



US006851890B2

(12) **United States Patent**  
**Kostelnik et al.**

(10) **Patent No.:** **US 6,851,890 B2**  
(45) **Date of Patent:** **\*Feb. 8, 2005**

(54) **ADVANCED CONTAINMENT SYSTEM**

(75) Inventors: **Kevin M. Kostelnik**, Idaho Falls, ID (US); **Hideki Kawamura**, Tokyo (JP); **John G. Richardson**, Idaho Falls, ID (US); **Masaru Noda**, Tokyo (JP)

(73) Assignee: **Bechtel BWXT Idaho, LLC**, Idaho Falls, ID (US)

(\*) Notice: Subject to any disclaimer, the term of this patent is extended or adjusted under 35 U.S.C. 154(b) by 21 days.

This patent is subject to a terminal disclaimer.

4,670,305 A	6/1987	Morgenthaler et al.
4,676,693 A	6/1987	Hiroshima et al.
4,741,644 A	5/1988	Cavalli et al.
4,947,470 A *	8/1990	Darilek ..... 405/129.5
4,949,076 A	8/1990	Wann
5,009,266 A	4/1991	Dieter
5,013,185 A	5/1991	Taki
5,018,576 A	5/1991	Udell et al.
5,030,034 A	7/1991	Bodine
5,037,240 A	8/1991	Sherman
5,054,961 A	10/1991	Sherman
5,076,727 A	12/1991	Johnson et al.
5,106,233 A	4/1992	Breaux
5,180,251 A	1/1993	Paurat et al.
5,199,816 A	4/1993	Paurat et al.
5,240,348 A	8/1993	Breaux
5,259,705 A	11/1993	Breaux et al.
5,280,243 A	1/1994	Miller

(21) Appl. No.: **10/412,491**

(22) Filed: **Apr. 3, 2003**

(65) **Prior Publication Data**

US 2003/0198517 A1 Oct. 23, 2003

**Related U.S. Application Data**

(62) Division of application No. 09/729,435, filed on Dec. 4, 2000, now Pat. No. 6,575,663.

(60) Provisional application No. 60/169,112, filed on Dec. 6, 1999.

(51) **Int. Cl.**<sup>7</sup> ..... **B09B 1/00**

(52) **U.S. Cl.** ..... **405/129.55**; 405/129.8

(58) **Field of Search** ..... 405/129.1, 129.45, 405/129.5, 129.55, 129.6, 129.8

(56) **References Cited**

**U.S. PATENT DOCUMENTS**

910,421 A	1/1909	Schlueter
2,101,285 A	12/1937	Stevens
3,411,305 A	11/1968	Cella
4,557,759 A	12/1985	McGrew et al.
4,601,615 A	7/1986	Cavalli
4,632,602 A *	12/1986	Hovnanian ..... 405/129.8
4,634,187 A	1/1987	Huff et al.

(List continued on next page.)

**OTHER PUBLICATIONS**

Pearlman, Leslie, "Subsurface containment and Monitoring Systems: Barriers and Beyond," National Network of Environmental Management Studies Fellow for U.S. Environmental Protection Agency, Mar. 1999.

*Primary Examiner*—John Kreck

(74) *Attorney, Agent, or Firm*—TraskBritt P.C.

(57) **ABSTRACT**

An advanced containment system for containing buried waste and associated leachate. The advanced containment system comprises a plurality of casing sections with each casing section interlocked to an adjacent casing section. Each casing section includes a complementary interlocking structure that interlocks with the complementary interlocking structure on an adjacent casing section. A barrier filler substantially fills the casing sections and may substantially fill the spaces of the complementary interlocking structure to form a substantially impermeable barrier. Some of the casing sections may include sensors so that the casing sections and the zone of interest may be remotely monitored after the casing sections are emplaced in the ground.

**43 Claims, 6 Drawing Sheets**

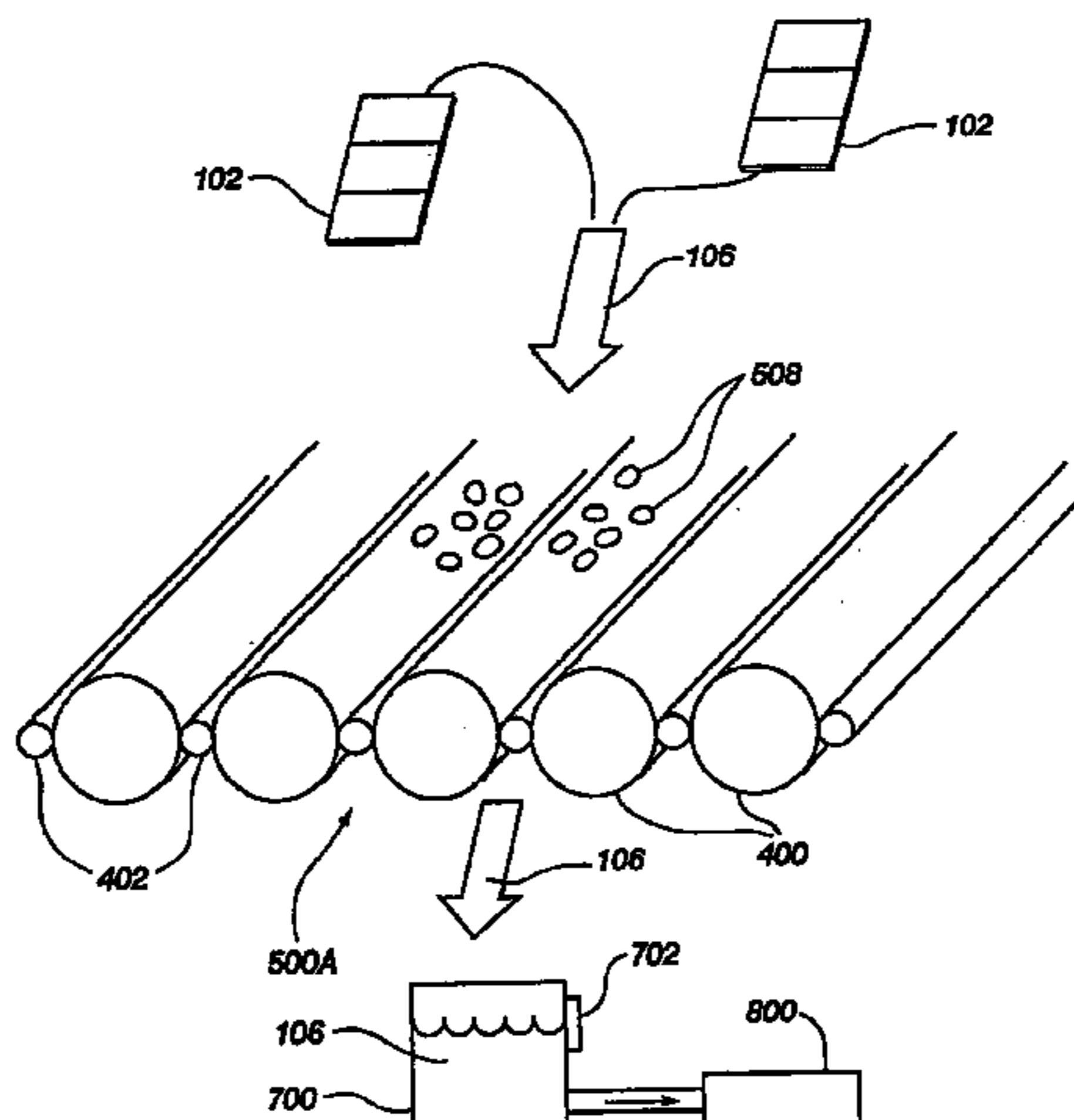

---

U.S. PATENT DOCUMENTS					
5,305,798 A	4/1994	Driver	5,818,241 A	10/1998	Kelly
5,324,433 A	6/1994	Grant et al.	5,861,090 A	1/1999	Clarke et al.
5,340,406 A	8/1994	Fearon	5,879,110 A	3/1999	Carter, Jr.
5,354,149 A	10/1994	Breaux	5,905,184 A	5/1999	Carter, Jr.
5,360,293 A	11/1994	Breaux et al.	5,961,437 A	10/1999	Smith et al.
5,388,931 A	2/1995	Carlson	5,971,440 A	10/1999	Boatman
5,460,032 A	10/1995	Hampton et al.	5,975,800 A	11/1999	Edwards et al.
5,476,992 A	12/1995	Ho et al.	6,016,714 A	1/2000	Smith et al.
5,531,895 A	7/1996	Alford et al.	6,099,206 A	8/2000	Pennell
5,551,807 A	9/1996	Breaux	6,102,617 A	8/2000	Hampton
5,584,610 A	12/1996	Simpson et al.	6,138,752 A	10/2000	Bass et al.
5,605,417 A	2/1997	Englert et al.	6,250,848 B1	6/2001	Moridis et al.
5,611,642 A	3/1997	Wilson	6,258,273 B1	7/2001	Gee
5,716,164 A	2/1998	Biro et al.	6,280,118 B1	8/2001	Suthersan et al.
5,758,993 A	6/1998	Schednecht et al.	6,281,801 B1	8/2001	Cherry et al.
5,765,965 A	6/1998	Carter, Jr. et al.	6,312,605 B1	11/2001	Kerfoot
5,800,096 A	9/1998	Barrow	6,648,552 B1 *	11/2003	Smith et al. .... 405/129.55
5,816,344 A	10/1998	Turner	2002/0107428 A1	8/2002	Nickelson et al.
5,816,748 A	10/1998	Kleiser et al.	2003/0152427 A1	8/2003	Nickelson et al.

\* cited by examiner

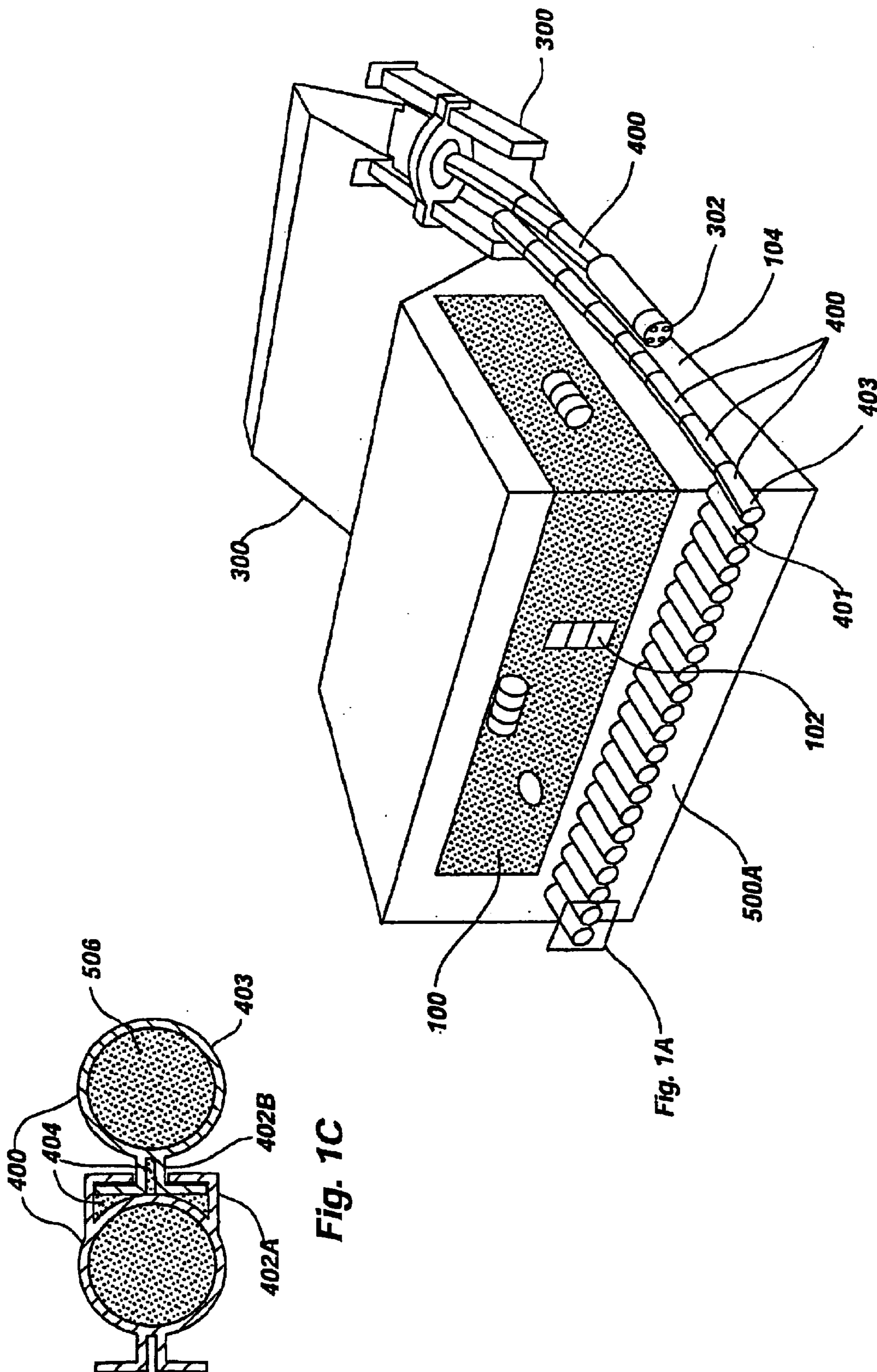

Fig. 1

Fig. 1C

Fig. 1A



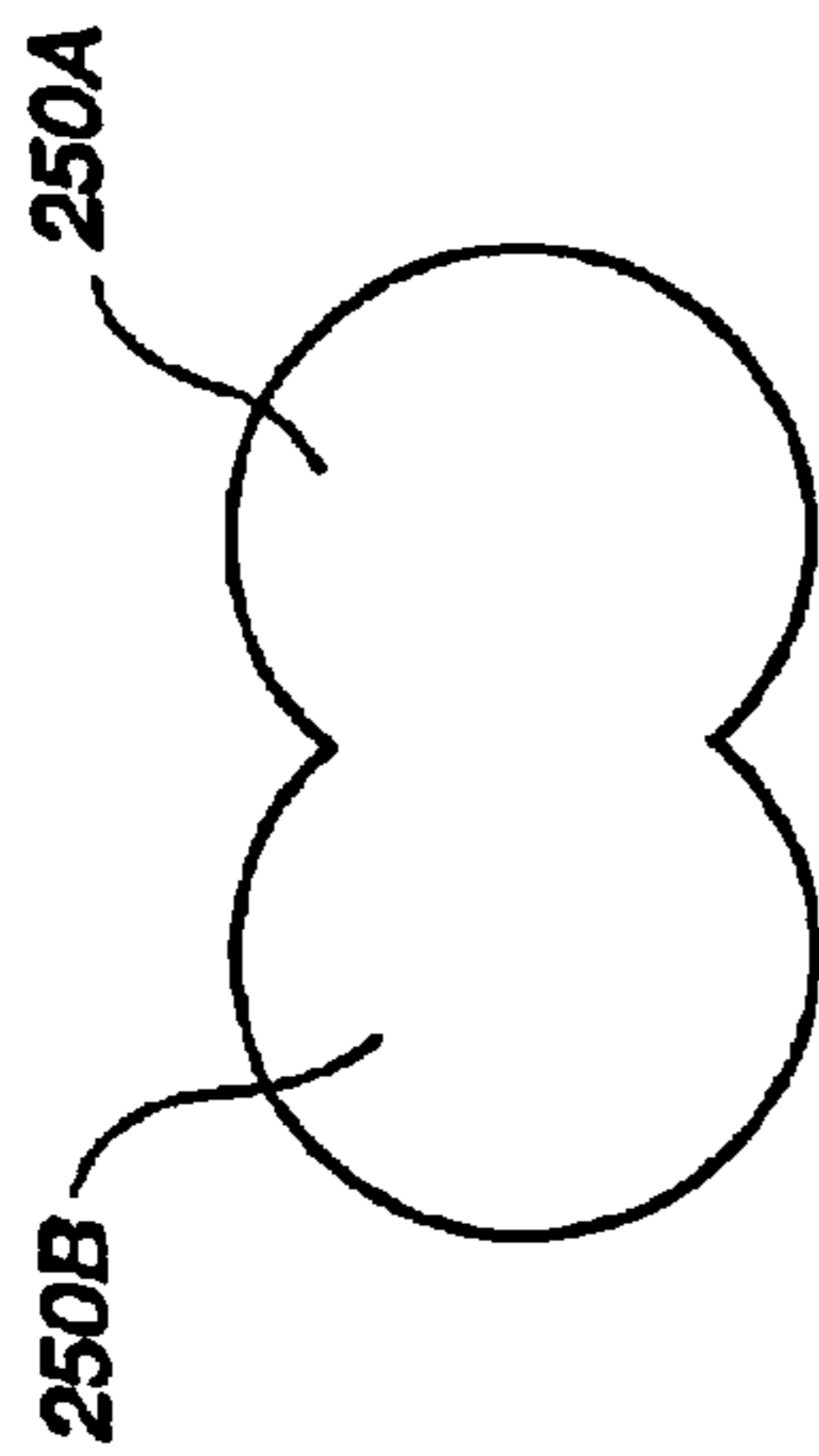

Fig. 1A-1

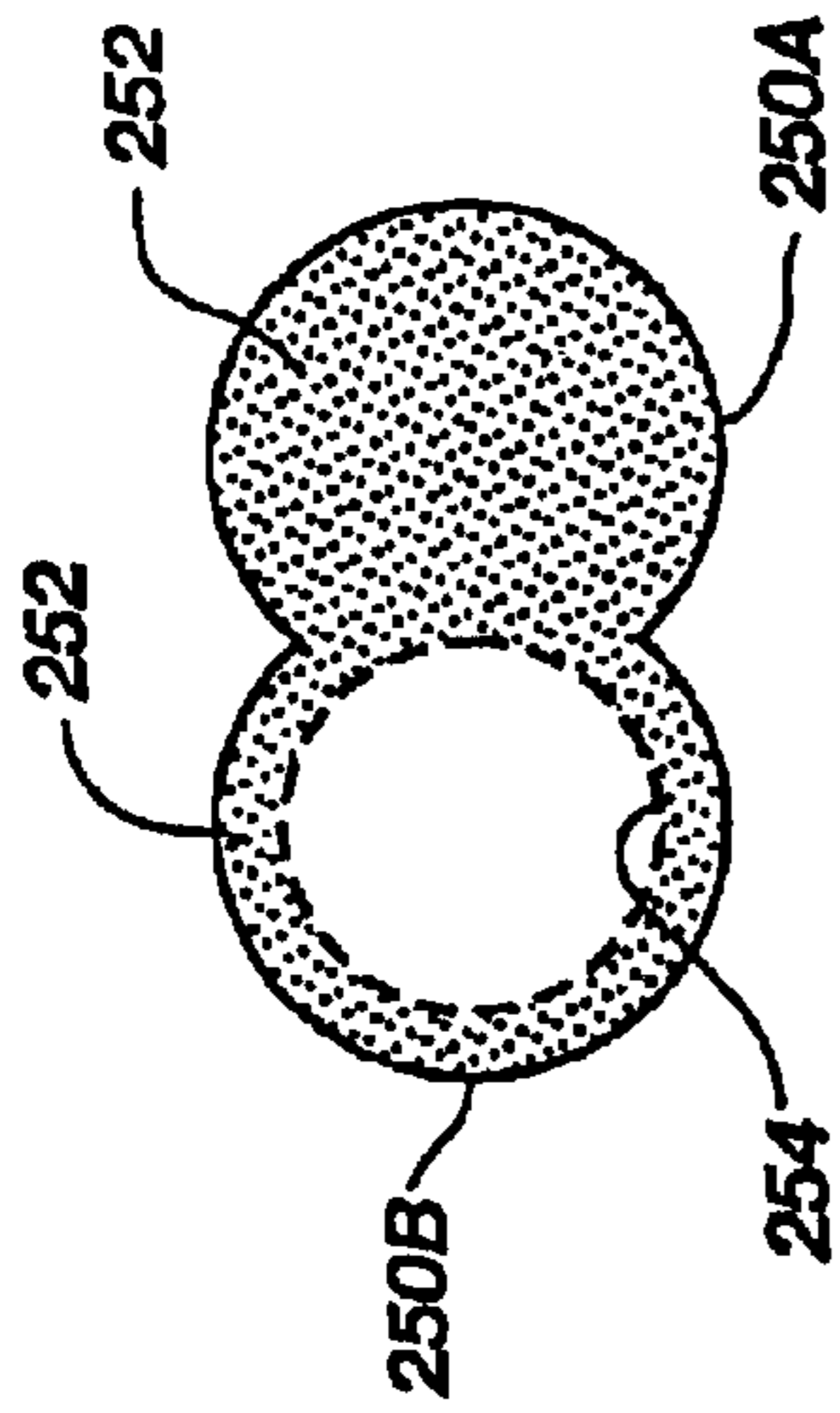

Fig. 1A-2

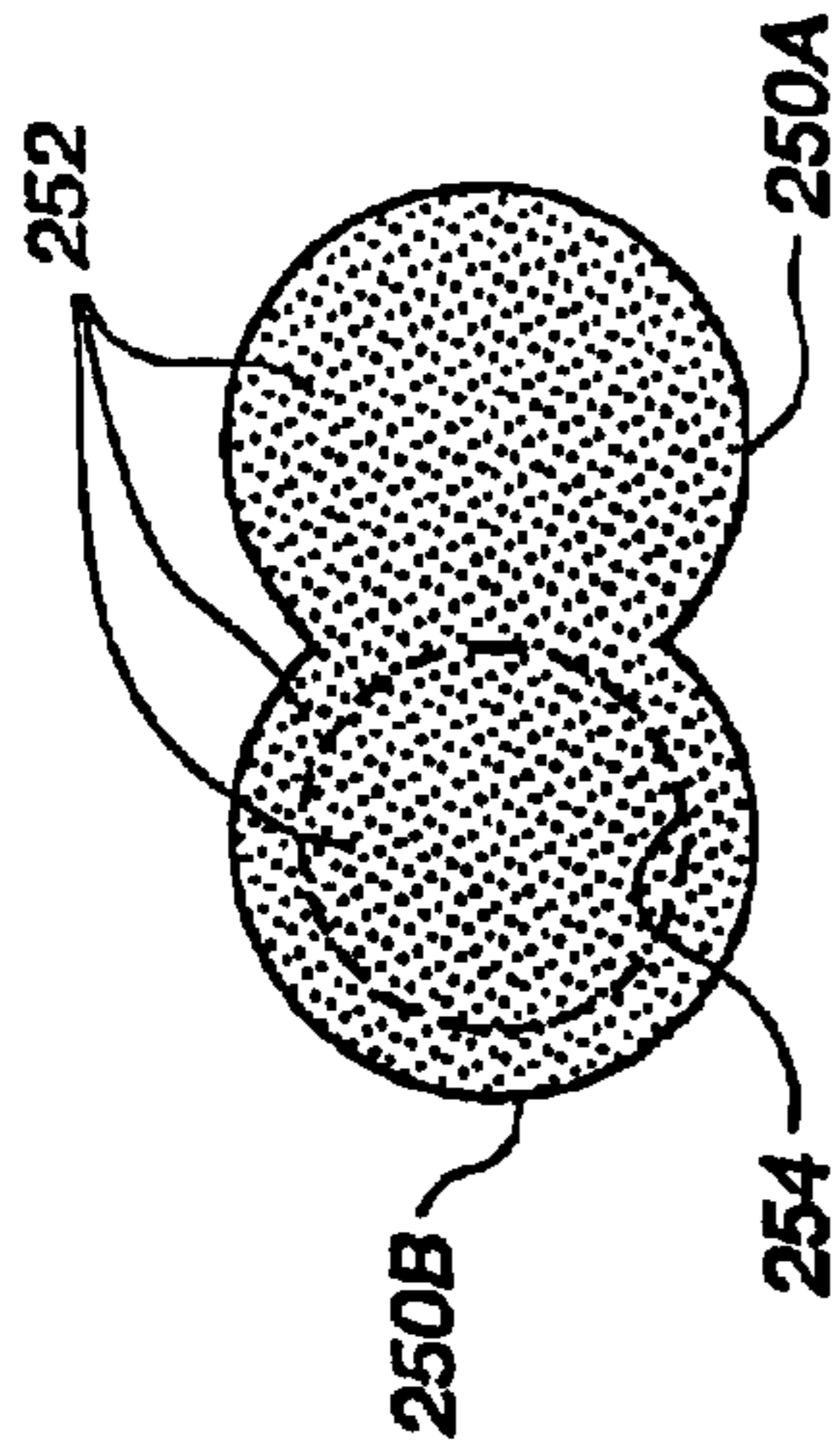

Fig. 1A-3

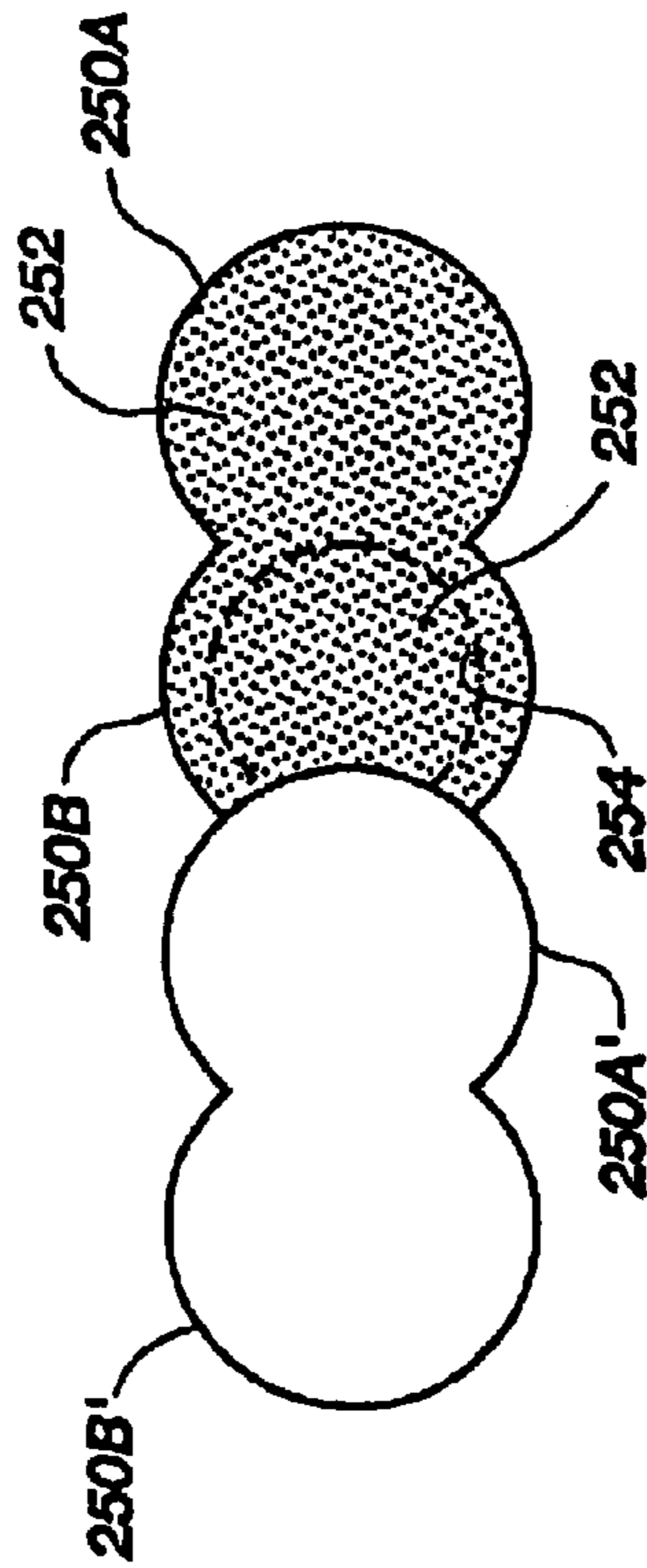

Fig. 1A-4

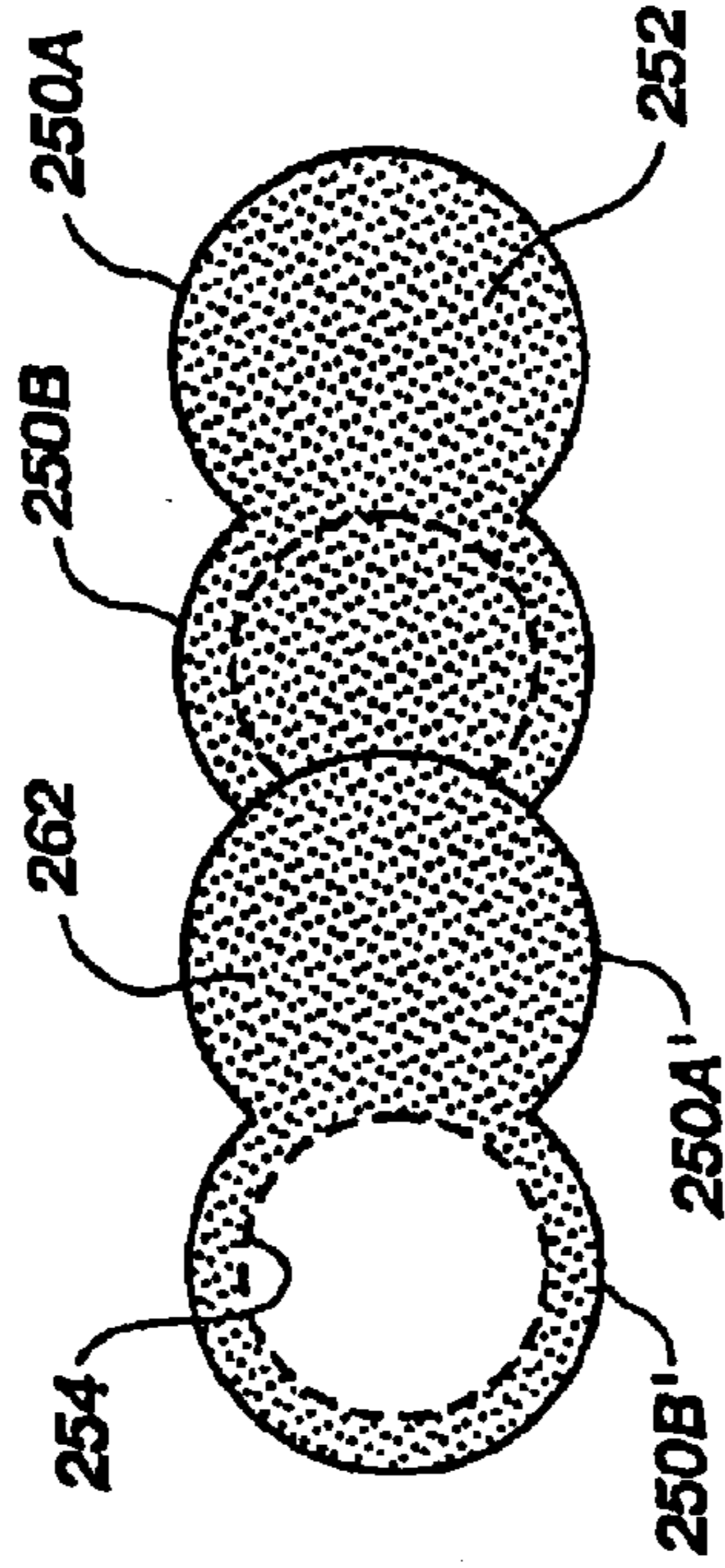

Fig. 1A-5

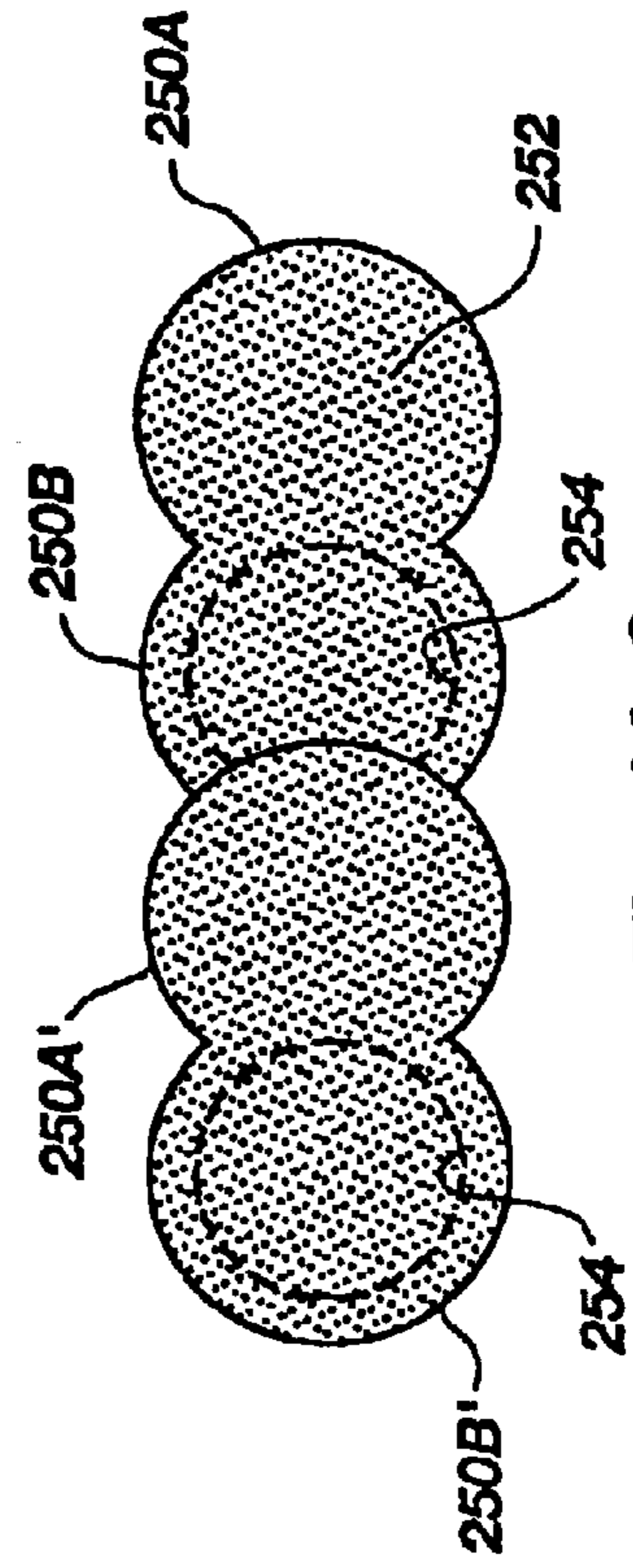

Fig. 1A-6

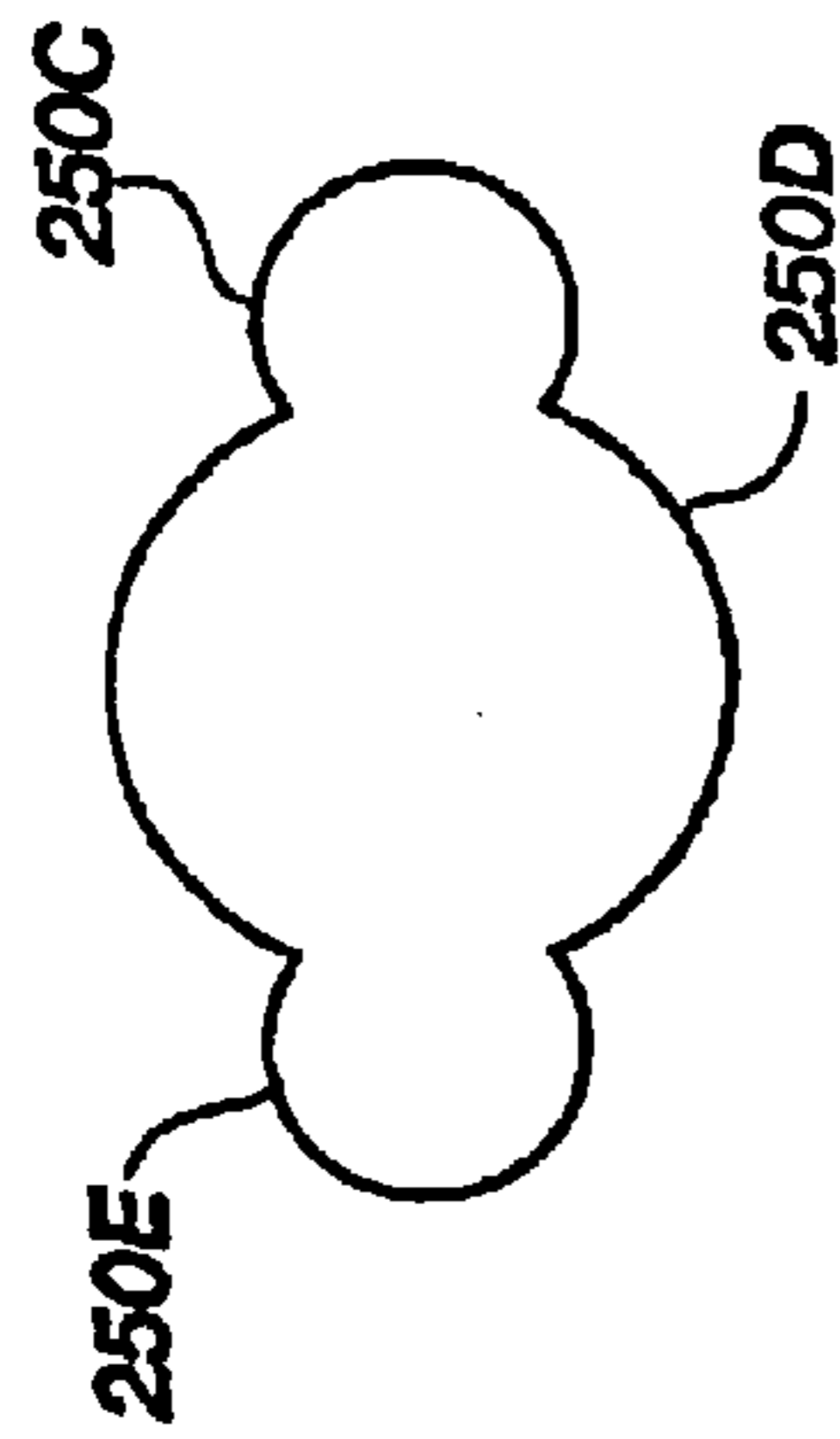

Fig. 1B-1

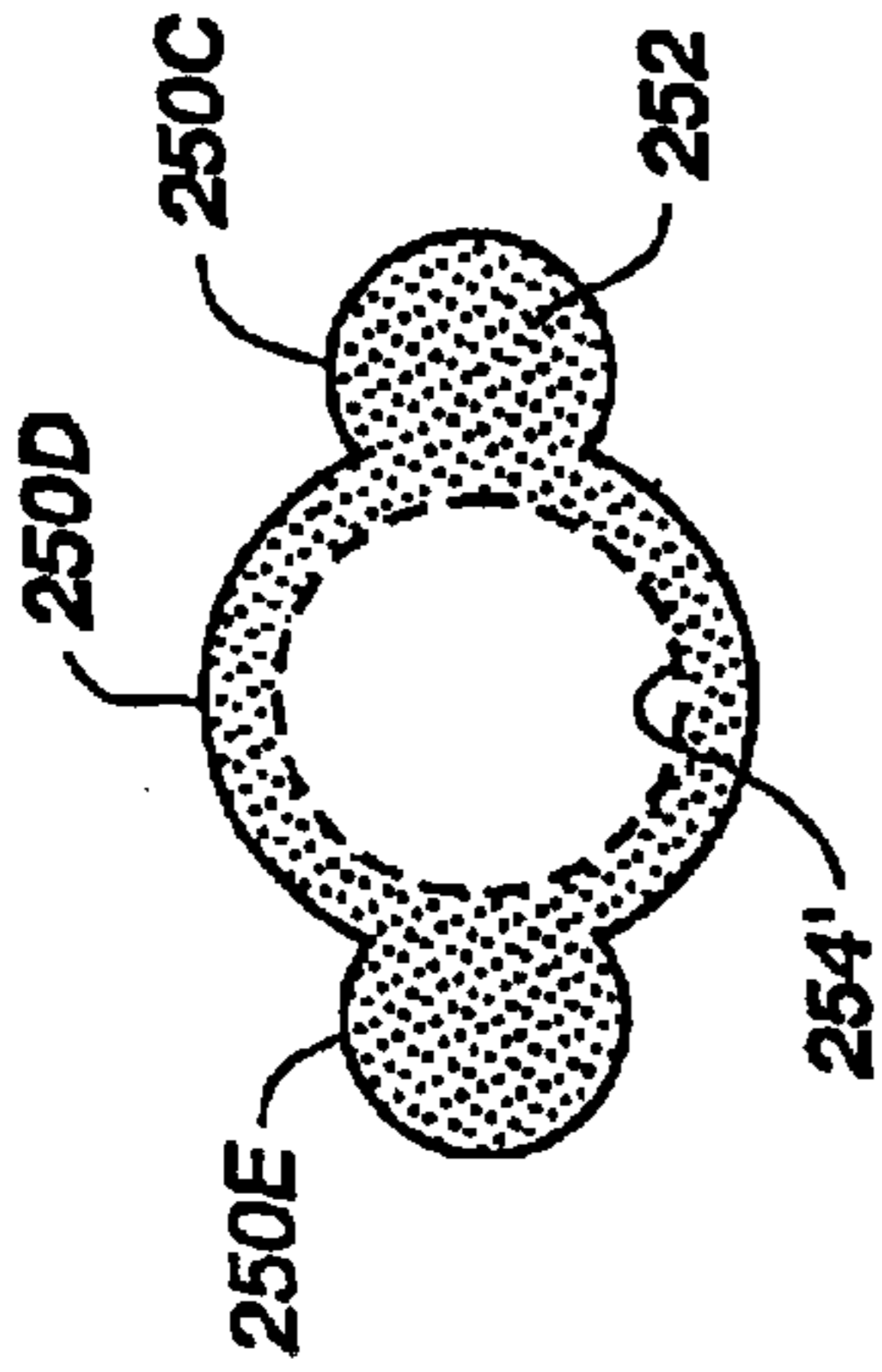

Fig. 1B-2

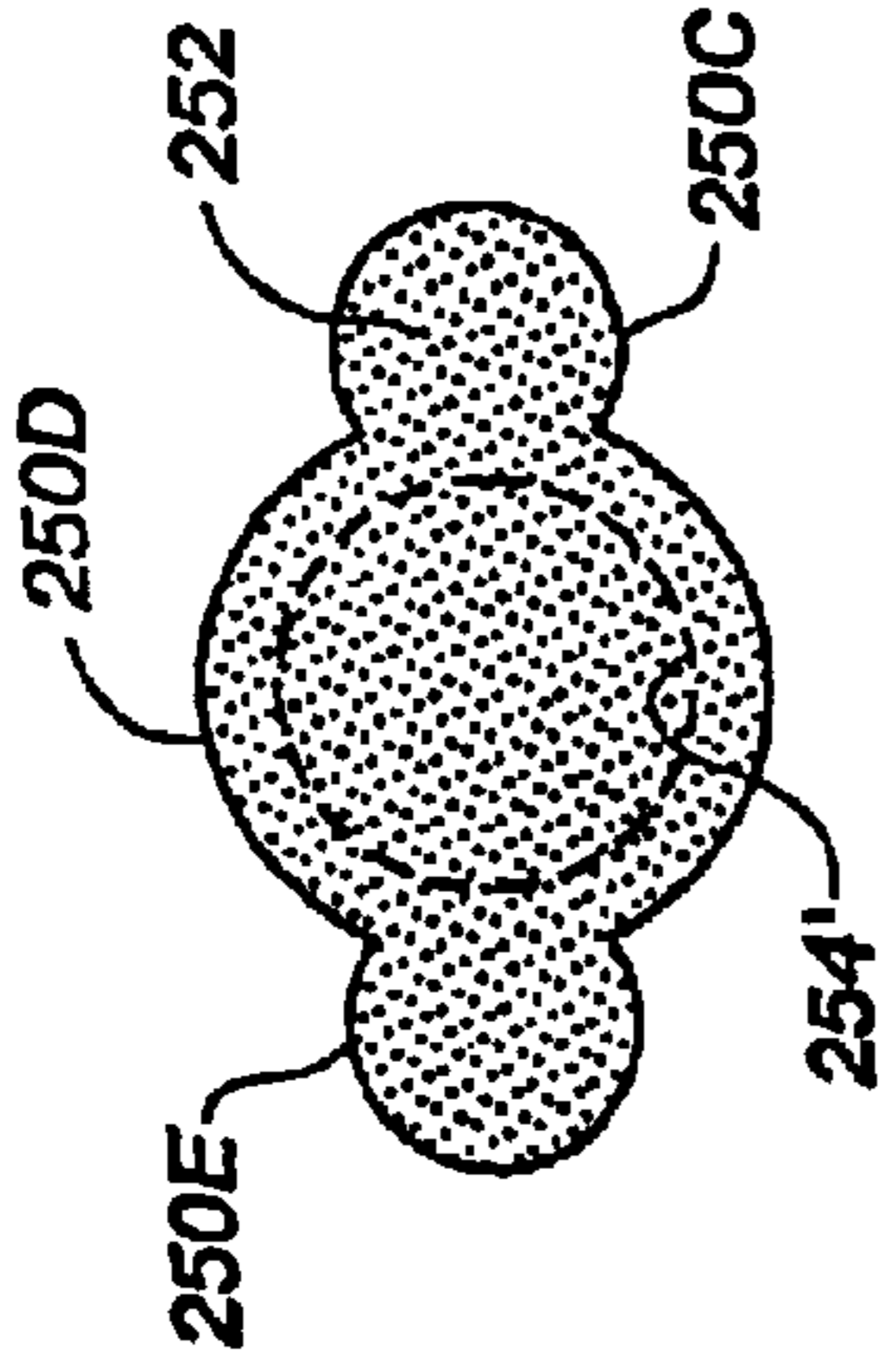

Fig. 1B-3

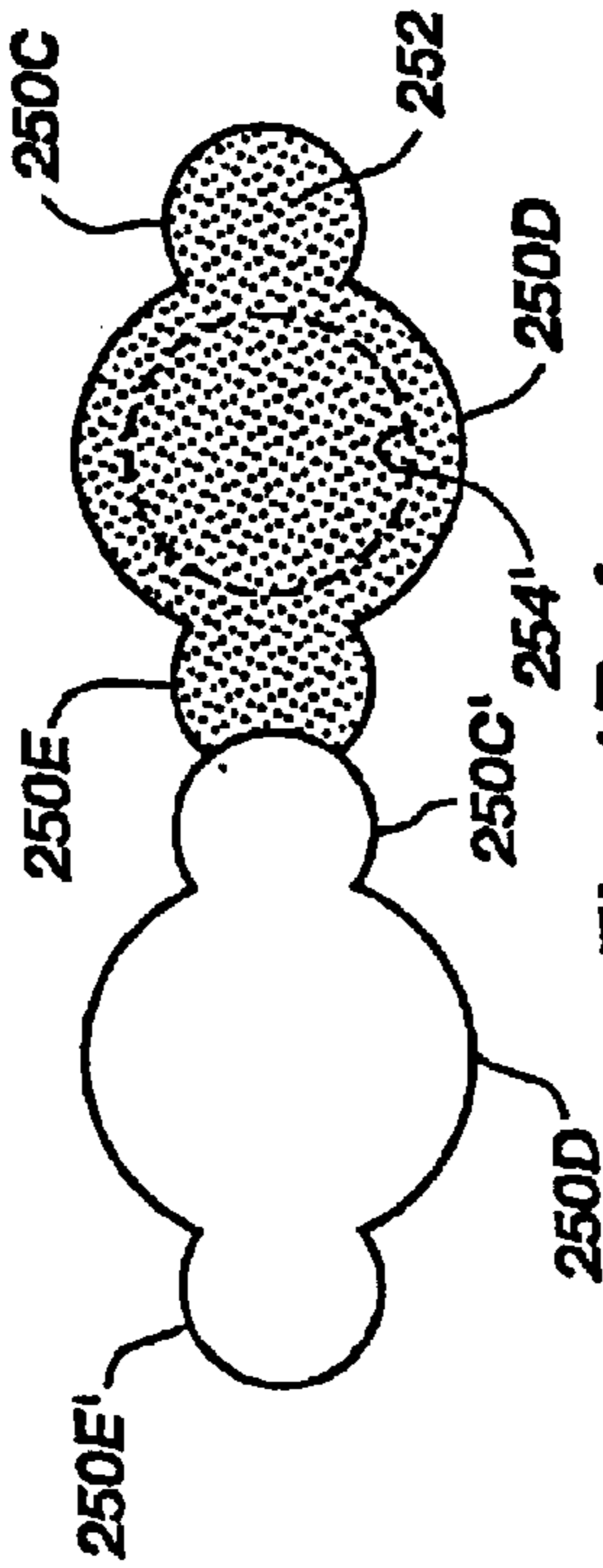

Fig. 1B-4

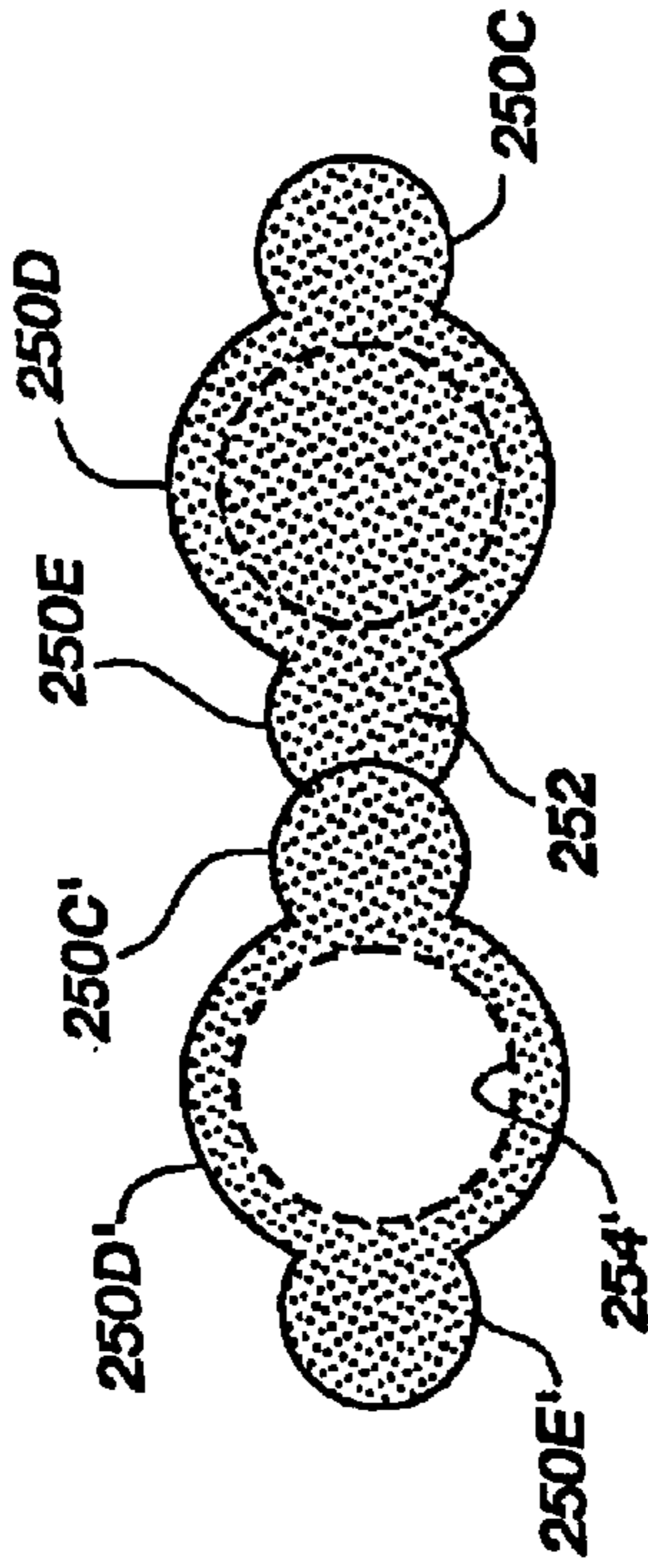

Fig. 1B-5

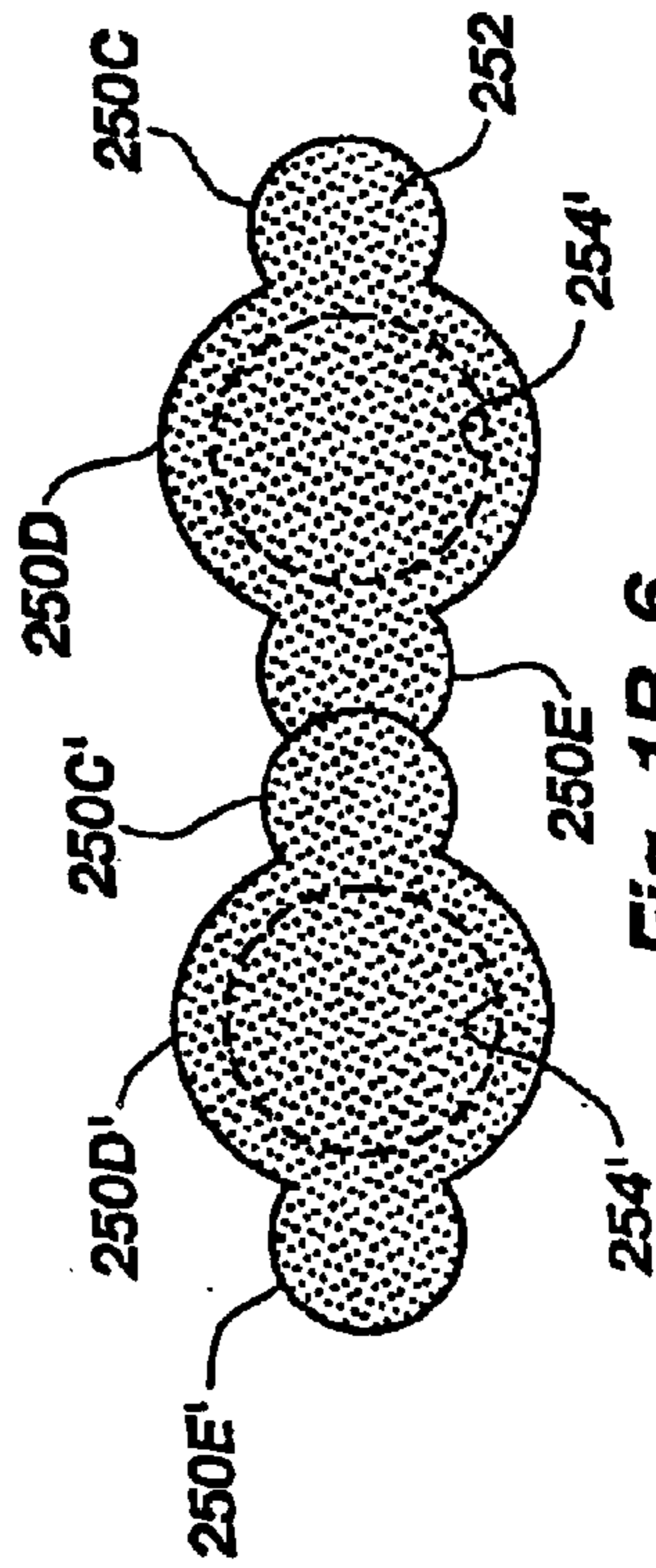

Fig. 1B-6

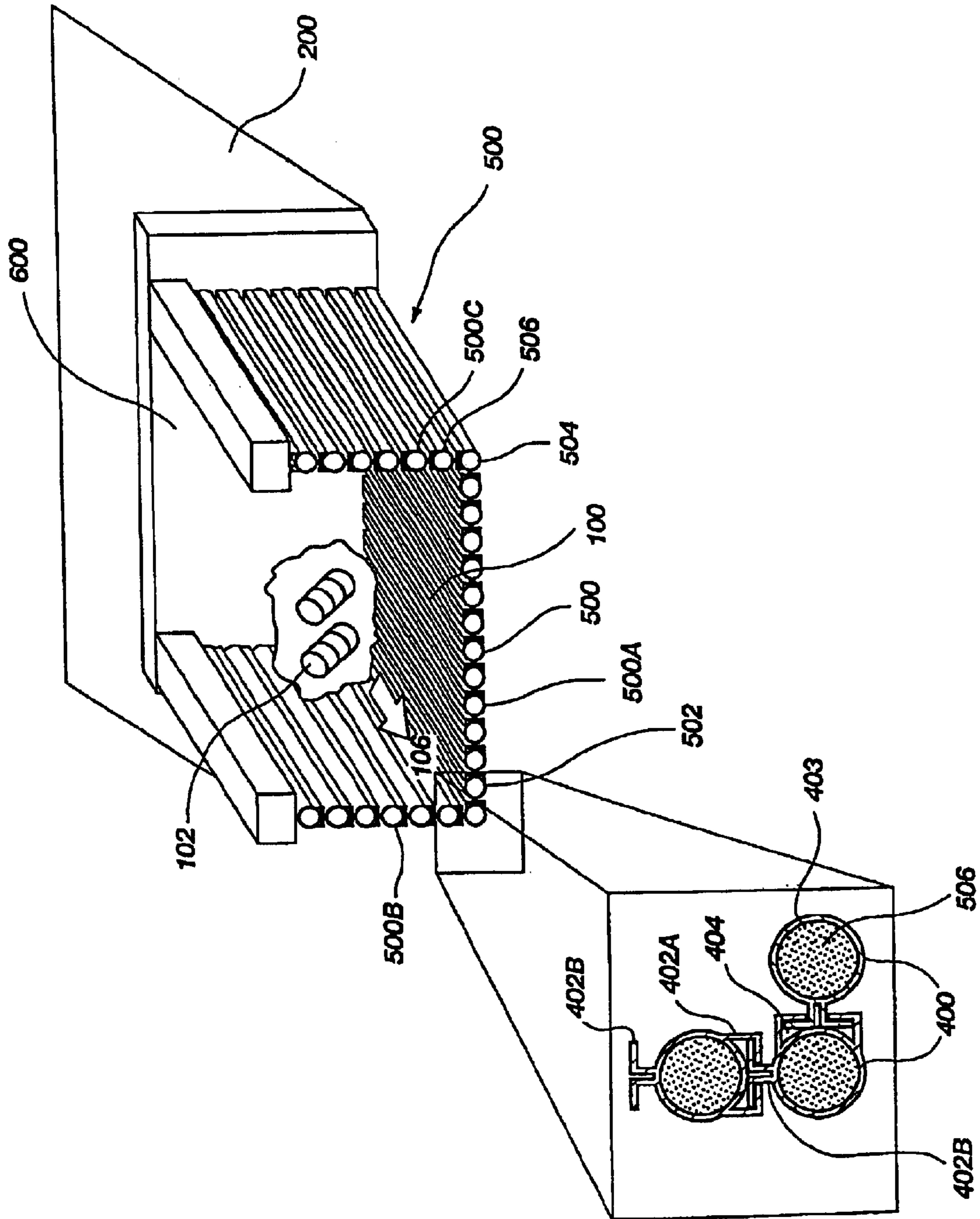

Fig. 2



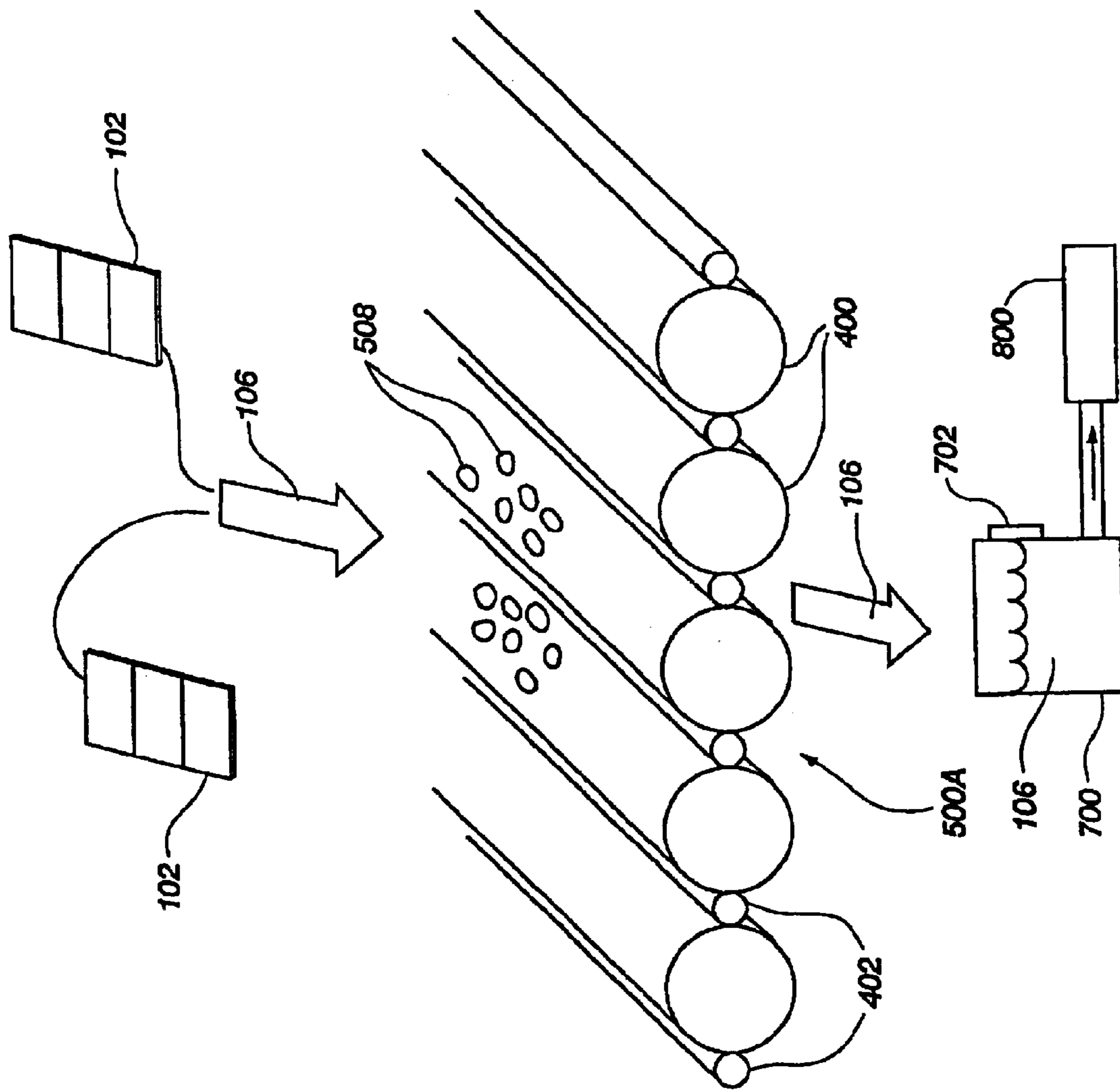

Fig. 3

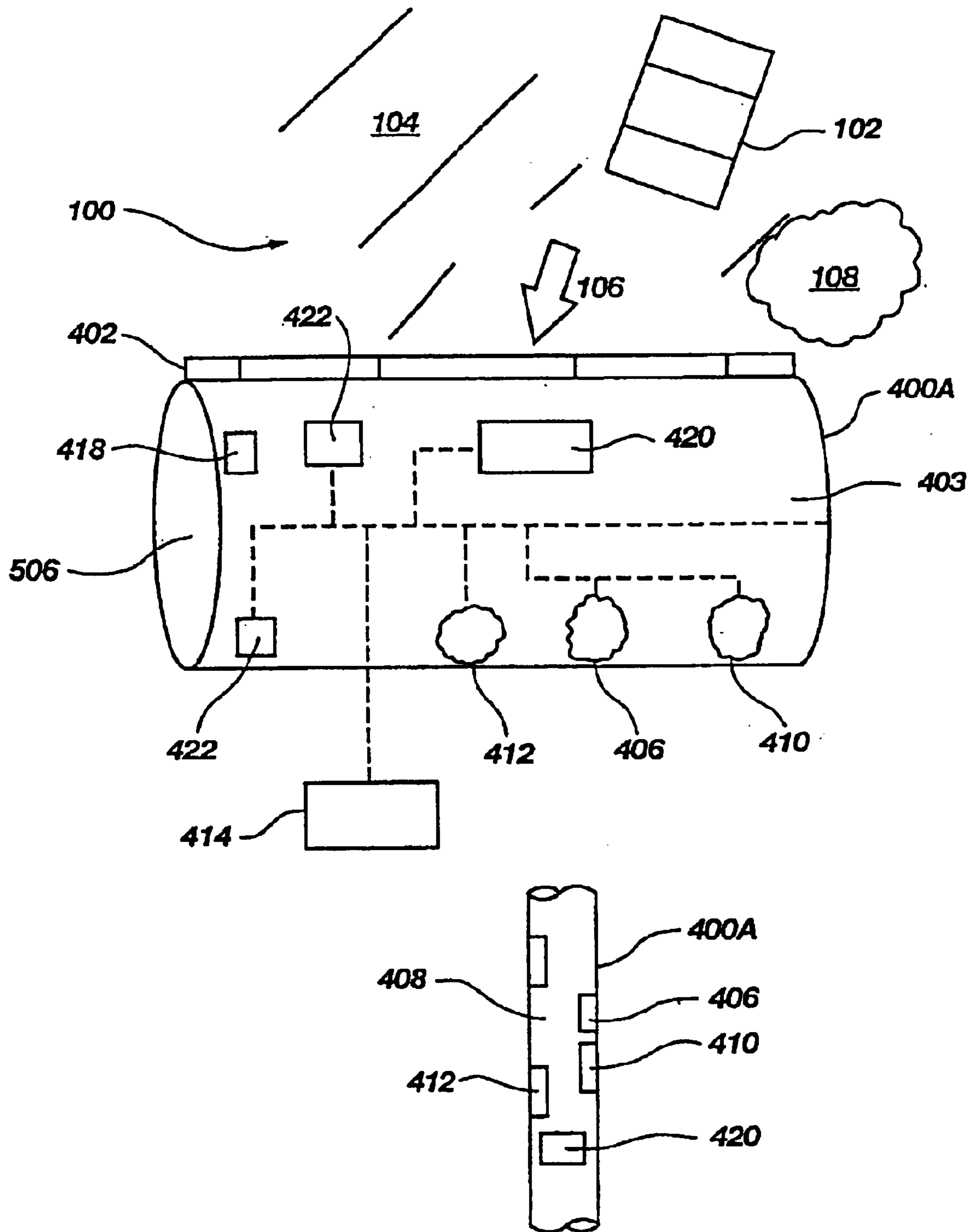

Fig. 4



**ADVANCED CONTAINMENT SYSTEM****RELATED APPLICATION**

This application is a divisional application of U.S. application Ser. No. 09/729,435, filed Dec. 4, 2000 now U.S. Pat. No. 6,575,663, issued Jun. 10, 2003, which claims priority from U.S. provisional application Ser. No. 60/169,112 filed Dec. 6, 1999 and is incorporated by reference.

**CONTRACTUAL ORIGIN OF THE INVENTION**

This invention was made with United States Government support under Contract No. DE-AC07-94ID13223, now Contract No. DE-AC07-99ID13727 awarded by the United States Department of Energy. The United States Government has certain rights in the invention.

**BACKGROUND OF THE INVENTION**

## 1. Field of the Invention

The present invention relates generally to methods and devices for in situ containment of buried waste. More particularly, embodiments of the present invention relate to an improved barrier, as well as to its installation and use, for reliably containing and managing leachate from buried waste.

## 2. Prior State of the Art

Management and disposal of various types of waste are long-standing problems. Early waste management and disposal systems were primitive, because there were no disposal or environmental regulations in place at the time. In countless instances, the waste was simply buried underground. The volume of waste that has been buried is tremendous. Some experts estimate that landfills in the United States alone hold more than 3 million cubic meters of buried waste. Further, much of the waste that was buried comprises heavy metals such as mercury and cadmium, carcinogenic materials such as trichloroethylene, radioactive materials, and other hazardous substances.

While burial and similar approaches produced an aesthetically pleasing result by removing the waste from sight, it was soon discovered that effluent from the buried waste was working its way through the soil and into the groundwater. This process is commonly known as leaching. Because groundwater is a major source of water for drinking and for agriculture, contamination of the groundwater by leaching is a major concern.

The contamination caused by buried waste is not limited solely to groundwater however. At least some of the groundwater finds its way into waterways such as streams, rivers, and lakes, thus polluting those waterways and poisoning the plant and animal life. Obviously, polluted waterways pose a threat to humans as well, particularly in the case of waterways and bodies of water used for recreational purposes and/or as a source of drinking water.

Not all of the cases of groundwater pollution arise from the leaching of chemicals from waste sources. In some cases, the waste is buried in the path of the groundwater and as groundwater flows through the waste, it collects various chemicals and toxins from the waste, and deposits those chemicals and toxins in other soils and waterways.

Clean soil and groundwater are important to human, plant, and animal life as well as to the environment in general. Accordingly, a variety of methods and devices have been devised to attempt to resolve the problems induced by buried waste. These remedies can be broadly grouped into the

categories of remediation and containment. Remediation remedies focus on processes designed to change the chemical composition of a contaminated material or contaminant, while containment remedies seek to eliminate the pollution problem by removing or isolating the contaminants and contaminated material from the surrounding area.

Remediation approaches such as biological treatments, thermal processes and chemical processes are problematic for a variety of reasons. In particular, many of these remediation techniques are expensive and potentially hazardous. Further, it is difficult to verify the effectiveness of many of the treatments and remediation-type approaches may not be appropriate for all types of contaminated material. Finally, determining the proper remediation technique is, in itself, a complex and time-consuming process, particularly in view of the web of regulations and procedures that govern such treatments.

Containment, barrier, or in situ, approaches are problematic as well. One known containment approach is simply to dig up and remove the contaminated soil for treatment and/or disposal. This approach is expensive and time-consuming and often accomplishes little more than moving the problem to another location. Other containment approaches involve installing vertical and/or horizontal barriers around the buried waste. In theory, this approach is attractive because it does not involve digging up or otherwise disturbing the buried waste.

However, these containment or barrier systems suffer from a variety of inadequacies including lack of durability, continuity and integrity. These inadequacies are a function of numerous factors including, but not limited to: exposure to harsh chemicals such as concentrated saline solutions, and saturated calcite and gypsum solutions; exposure to extreme thermal gradients such as are typically experienced in freeze/thaw zones; and exposure to stresses induced by shifting in the earth.

The hydraulic conductivity, which is the rate at which a fluid or hazardous substance flows through a barrier, is unacceptably high in some barrier systems and other typical barrier systems are not particularly well-suited to a variety of soil conditions such as hard rock and sand. A further flaw is that many barrier systems do not provide methods for evaluating the integrity of the barrier during and after installation, which is complicated by the fact that many barrier systems also lack provision for long term monitoring of the containment zone and the leachate therefrom. The inability to monitor a barrier system that is isolating hazardous waste is unacceptable because of the potential harm that can be caused to the environment. The lack of durability, continuity and integrity in known containment systems has a significant effect on the performance of those systems and the effectiveness of those containment and barrier systems cannot be readily determined or evaluated.

Accordingly, what is needed is an improved in situ containment system and a method for installing the system. Specifically, the containment system should be durable so as to maintain both integrity and effectiveness under a variety of physical and thermal conditions as well as adaptable to wide range of soil types and conditions. The containment system should be chemically stable and impervious to attack by the chemicals, compounds, and microbes typically encountered in buried waste. The containment system should also have a low hydraulic conductivity so as to minimize the passage of fluids and chemicals through the barrier and the containment system should monitor the integrity of the barrier both during and after installation.



Further, the containment system should be capable of long-term monitoring of the zone enclosed by the containment system and should also be capable of monitoring the leachate from the zone of interest. Also, both the system and the method for installing the containment system should be relatively simple and cost-effective. Finally, the installation method should ensure that the containment system is properly placed and oriented.

### OBJECTS AND SUMMARY OF THE INVENTION

The present invention has been developed in response to the current state of the art, and in particular, in response to these and other problems and needs that have not been fully or completely solved by currently available waste containment systems and methods.

Thus, it is an overall object of one embodiment of the present invention to provide a simple yet cost-effective waste containment system that is particularly useful for in situ monitoring, control, and management of buried waste and associated leachate.

It is another object of one embodiment of the invention to provide a containment system including one or more barriers comprised of interlocking steel casing sections so as to facilitate a durable, impervious and chemically stable containment system having a high degree of continuity and integrity.

A further object of one embodiment of the present invention is to impart added integrity and durability to the barrier by filling the metallic casing sections with an impervious material.

Another object of one embodiment of the present invention is to provide a containment system that employs embedded sensors for long-term monitoring of the integrity of the barriers and for monitoring the containment zone and leachate.

It is also an object of one embodiment of the present invention to provide a containment system installation method that is cost-effective.

Finally, it is an object of one embodiment of the present invention to provide a containment system installation method which will ensure accurate placement and orientation of the containment system.

The effects of buried waste on the environment can be quite profound and are not limited to the area in which the buried waste is located because chemicals, toxins and other hazardous substances associated or produced by the buried waste are frequently introduced into the groundwater and carried to other parts of the environment. These chemicals and other dangerous substances may ultimately be found in drinking water, irrigation water, rivers, lakes, and other sources of water. In this manner, buried waste has an adverse effect on the health of people, plants, and animals and also harms the environment.

In many instances, the buried waste is difficult to move and relocation of the buried waste may actually cause more harm. In these and other instances, it is desirable to contain the buried waste by surrounding the buried waste with a barrier that effectively isolates the buried waste. The containment systems and barriers of the present invention provide an advanced containment system that is continuous, durable, and capable of performing in a variety of geologic and environmental conditions. Additionally, the effectiveness of the advanced containment system is able to be verified over a sustained time period.

In a preferred embodiment, the containment system includes one or more barriers comprising a plurality of metal casing sections longitudinally connected by interlocking structure present on each casing. The barriers cooperate with one or more concrete walls to collectively enclose at least a portion of the buried waste.

Preferably, a barrier is first installed underneath the zone of interest. Specifically, a line of individual steel casing sections are placed by a micro-tunneling device or the like which simultaneously excavates a tunnel and installs connecting casing segments behind the micro-tunneling device as tunneling progresses. The length of the tunnels is determined by the size of the zone of interest to be contained. Preferably, the tunneling device includes a system for ensuring accurate placement and orientation of the tunnels and casing sections. As each tunnel is dug and lined with casing sections, a successive adjacent tunnel is dug and casing sections situated therein which longitudinally interlock with the casing sections placed in the previously excavated tunnel, so as to form a continuous barrier of predetermined width.

The casing sections and the joints whereby they interlock are preferably filled with grout or the like so as to provide an added measure of strength, durability, and imperviousness to the barrier. In a preferred embodiment, two vertical barriers are interlocked with the ends of the horizontal barrier so that the horizontal barrier and vertical barriers collectively form a continuous U or channel-shaped containment boundary around the zone of interest. Preferably, the horizontal and/or vertical barriers include sensors installed contemporaneously so as to permit monitoring of the integrity and performance of the barriers during and after installation. In a preferred embodiment, the barriers also include sensors for long-term monitoring of the zone of interest and associated leachate.

After the channel has been completed, a concrete wall is installed at either end of the containment area, thereby cooperating with the barriers to enclose the containment area on all sides except the top. Optionally, at least one of the barriers has one or more openings in fluid communication with a collection system or the like so that leachate flowing through the opening can be monitored, collected, and processed.

Additional objects and advantages of the present invention will be set forth in the description which follows, and in part will be obvious from the description, or may be learned by the practice of the invention. The objects and advantages of the invention may be realized and obtained by means of the instruments and combinations particularly pointed out in the appended claims. These and other objects and features of the present invention will become more fully apparent from the following description and appended claims, or may be learned by the practice of the invention as set forth hereinafter.

### BRIEF DESCRIPTION OF THE DRAWINGS

In order to more fully understand the manner in which the above-recited and other advantages and objects of the invention are obtained, a more particular description of the invention will be rendered by reference to specific embodiments thereof which are illustrated in the appended drawings. Understanding that these drawings depict only typical embodiments of the invention and are not therefore to be considered to be limiting of its scope, the invention and its presently understood best mode for making and using the same will be described and explained with additional speci-



5

ficity and detail through the use of the accompanying drawings in which:

FIG. 1 is a perspective view of a micro tunneling device installing casing sections underneath the zone of interest;

FIG. 1A illustrates a cross-section view of one embodiment of simultaneous double tunnel excavation, looking towards the front end of the tunnels, and indicates the interconnection between adjacent tunnels;

FIG. 1B illustrates a cross-section view of one embodiment of simultaneous triple tunnel excavation, looking toward the front end of the tunnels, and indicates the interconnection between adjacent tunnels;

FIG. 1C illustrates a cross-section view of one embodiment of the interlock structure between adjacent casing sections;

FIG. 2 is a perspective view of an embodiment of the installed containment system;

FIG. 3 is a depiction of an embodiment of a barrier adapted for leachate collection and processing; and

FIG. 4 is a schematic of a casing section having a plurality of sensors for monitoring the zone of interest and the barrier.

#### DETAILED DESCRIPTION OF THE PREFERRED EMBODIMENTS

The threat to the environment produced by buried waste begins when the contaminants produced by buried waste leach into the groundwater. Once groundwater has been contaminated, the potential harm is great, because groundwater typically makes its way to rivers and lakes, which are frequently sources of drinking water and irrigation water. In this manner, the contaminants originally produced by buried waste make their way to plants, animals and humans.

The advanced containment system (ACS) of the present invention addresses these and other concerns of buried waste by isolating a zone of interest, which provides several significant advantages. The ACS is capable of creating a continuous barrier of various sizes and configurations. The barriers can be installed in both saturated and unsaturated zones of interest and in a variety of geologies from soft soil to hard rock. ACS provides for the verification of the barrier installation as well as structural continuity of the barrier. ACS also significantly improves the hydraulic performance of the barrier, allows the performance of the barrier to be monitored for an extended period of time, and is cost effective.

As used herein, "buried waste" refers to: construction and demolition materials such as lumber and concrete blocks; laboratory equipment such as glassware and tubing; process equipment such as valves, ion exchange resins, and heat exchangers; maintenance equipment such as oils and greases; decontamination materials such as paper, rags and plastics; hazardous and radioactive materials; and any other type of waste or garbage which is buried in the ground. The chemicals and other substances produced by buried waste which leaches into the surrounding soil and groundwater are also encompassed by the term buried waste. "Zone of interest" refers to an area or volume of ground containing buried waste. A containment system is typically designed to isolate the zone of interest from the surrounding earth and water such that the buried waste and associated leachate is geographically confined to the zone of interest.

The present invention is described in terms of diagrams and figures. Using the diagrams and figures in this manner to present the invention should not be construed as limiting its scope. Rather, the diagrams and figures are intended to be

6

exemplary embodiments of the present invention. Additionally, the diagrams and figures are not necessarily drawn to scale.

In general, the present invention relates to advanced containment systems for use in in situ monitoring, controlling, and management of buried waste and associated leachate. FIGS. 1 through 4 indicate various presently preferred embodiments of an advanced containment system. Other embodiments of the present invention may also be available and such figures are not intended to be limiting.

FIG. 1 depicts a zone of interest **100** to be isolated by a containment system. In order to contain zone of interest **100**, a trench **200** is first dug on either side of zone of interest **100** (only one trench is shown) containing buried waste **102**. Micro tunneling device **300** is then placed in trench **200**. Trench **200** facilitates the introduction of micro tunneling device **300**, but the creation of trench **200** may be omitted in some embodiments. If trench **200** is dug, the soil, if contaminated, is disposed of by appropriate and approved methods. Additionally, any soil excavated by tunneling device **300** is also collected, scanned, and disposed of by similar methods.

One type of micro tunneling device **300** is known as a micro tunnel boring machine, or micro TBM. In a preferred embodiment, micro tunneling device **300** comprises an auger head **302** or the like for rotary excavation of soil **104**. However, it is contemplated that the inventive barrier system may be installed in any of a number of different types of soil and rock, or combinations thereof. Accordingly, installation of the containment or barrier system by other excavation devices including, but not limited to, 'double-tube down the hole' drills (preferred for hard soil and soft rock), rotary percussion drills (preferred for hard rock), Multi-face Tunnel Boring Machine, Multi-face Shielded Tunnel Boring Machine, Shielded Tunnel Boring Machine coupled with a Horizontal Cutting Screw Auger, Pipe Propulsion, Curved Pipe Propulsion, Trench Cutting, and the like is contemplated as being within the scope of this invention. Preferred construction speeds are about 50 meters/day of tunnel through soft soil, about 25 meters/day of tunnel through hard soil/soft rock, and about 8 meters/day of tunnel through hard rock.

In order to contain the buried waste in a zone of interest, micro tunneling device **300** serially drills a plurality of parallel tunnels underneath the zone of interest. Preferably, each tunnel is substantially circular in cross-section. However, this invention contemplates as within its scope tunnels of a wide variety of different cross sectional shapes. Each tunnel begins in trench **200** and ends in trench **200** (not shown) on the other side of zone of interest **100**. Micro tunneling device **300** lines each tunnel with casing sections **400** so as to form a tube **401** inside each tunnel as drilling progresses. One of the functions of casing sections **400** installed during tunneling is to support the portion of the tunnel already drilled. In a physically supportive matrix such as hard rock, casing sections **400** may not be required. In a preferred embodiment, casing sections **400** comprise a body **403** optimally constructed of steel or the like. However, alternative casing materials that would provide the functionality and durability of steel are contemplated as being within the scope of this invention. Alternative casing materials include, but are not limited to, concrete and the like.

In a preferred embodiment, each tunnel is about 0.5 meters in diameter. Further, it is preferred that the tunnels be in the range of about 50 meters to about 150 meters long.

An alternative embodiment is depicted in steps (i) through (vi) of FIG. 1A. In this embodiment, two parallel overlap-



ping tunnels **250A** and **250B**, respectively, are excavated substantially simultaneously (step (i)) by micro tunneling device **300** (not shown). Overlapping tunnels **250A** and **250B** are preferably substantially circular in cross-section. However, this invention contemplates as within its scope tunnels of a wide variety of different cross sectional shapes. Micro tunneling device **300** preferably comprises a double multiface TBM or the like. As excavation progresses, overlapping tunnel **250A** is substantially filled with barrier filler **252** (step (ii)). Barrier filler **252** preferably comprises grout, cement, concrete, bentonite-based materials, modified cement, polysiloxane, acrylic polymers, or the like. Substantially simultaneously with excavation of overlapping tunnels **250A** and **250B**, and backfilling of overlapping tunnel **250A**, barrier filler forms **254** are placed in overlapping tunnel **250B** and barrier filler **252** is poured or injected about barrier filler forms **254** as indicated in FIG. 1A (step (ii)) so as to form a hollow tube made of barrier filler **252**. After overlapping tunnel **250B** has been completely excavated, it is backfilled with barrier filler **252** (step (iii)). The process then is then repeated, a portion of overlapping tunnel **250B** being cut out (see FIG. 1A) as part of the excavation of overlapping tunnel **250A'** and the excavation sequence is repeated as required (steps (iv) through (vi)). In this alternative embodiment, no casing sections **400** are required.

Yet another alternative embodiment is depicted in steps (i) through (vi) of FIG. 1B. In this embodiment, three parallel overlapping tunnels **250C**, **250D**, and **250E**, respectively, are excavated substantially simultaneously by a tunneling device (not shown) such as a triple multiface shield machine or the like. Alternatively, the tunneling device (not shown) comprises two shielded TBMs having a horizontal slot/auger cutter positioned therebetween so as to reduce the volume of excavated soil and the amount of barrier filler **252** subsequently required for filling. Overlapping tunnels **250C**, **250D**, and **250E** are preferably substantially circular in cross-section. However, this invention contemplates as within its scope tunnels of a wide variety of different cross sectional shapes.

As excavation progresses, overlapping tunnels **250C** and **250E** are substantially filled with barrier filler **252**. Substantially simultaneously with excavation of overlapping tunnels **250C**, **250D** and **250E**, and backfilling of overlapping tunnels **250C** and **250E**, barrier filler forms **254'** are placed in overlapping tunnel **250D** and barrier filler **252** is poured or injected about barrier filler forms **254'** as indicated in step (ii) of FIG. 1B. After overlapping tunnel **250D** has been completely excavated, it is backfilled with barrier filler **252** as indicated in step (iii) of FIG. 1C. Alternatively, tunnel **250D** may be left open. As indicated in steps (iv) through (vi) of FIG. 1B, the process then is then repeated, a portion of overlapping tunnel **250E** being cut out as part of excavation of overlapping tunnel **250C'** and the excavation sequence repeated as required. In this alternative embodiment, no casing sections **400** are required.

With continuing reference now to FIG. 1, micro tunneling device **300** preferably includes a control system (not shown) for ensuring accurate drilling. Alignment and orientation of the first tunnel drilled is critical as all subsequent tunnels are drilled with reference to the first tunnel. In particular, as subsequent tunnels are drilled and lined with casing sections **400**, each casing section **400** installed in a subsequently drilled tunnel is longitudinally interlocked with an adjacent casing section **400** in the previously drilled and lined tunnel so that a continuous barrier segment **500A** is formed as indicated in FIG. 1. In a preferred embodiment, barrier segment **500A** is substantially horizontal.

One embodiment of complementary interlocking structure **402A** and **402B** adapted to interlock adjacent casing sections **400** is indicated in FIG. 1C. Complementary interlocking structure **402A** and **402B** provides the dual benefit of positively interlocking adjacent casing sections **400** and, once the first tunnel is drilled and lined with casing sections **400**, complementary interlocking structure **402B** serves to accurately and reliably guide complementary interlocking structure **402A** of adjacent casing sections **400** into place, thus ensuring accurate placement and orientation of those casing sections **400** and thus of barrier segment **500A** as a whole. Note that complementary interlocking structure **402A** and **402B** represents only one possible embodiment of structure in accordance with the teachings of this invention, and this invention is not considered to be limited thereto. It is contemplated that any of a wide variety of structural arrangements could profitably be employed to achieve the functionality of complementary interlocking structure **402A** and **402B** and, accordingly, those structural arrangements are contemplated as being within the scope of the present invention as well. Two possible alternative interlock arrangements, previously discussed, are indicated in FIGS. 1A and 1B, respectively.

Once barrier segment **500A** is installed, barrier segments **500C** and **500B** are installed in like manner by micro tunneling device **300** (not shown) to produce the U-shaped configuration indicated in FIG. 2. In particular, barrier segment **500B** interlocks with barrier segment **500A** at edge casing **502**, by way of complementary interlocking structure **402A** and **402B**, and excavation and lining of subsequent tunnels proceeds substantially vertically upward from edge casing **502** until barrier segment **500B** reaches a desired height. In similar fashion, barrier segment **500C** employs complementary interlocking structure **402A** or the like to interlock with complementary interlocking structure **402B** or the like on barrier segment **500A** at edge casing **504**, the excavation and lining of subsequent tunnels proceeding vertically upward from edge casing **504** until barrier segment **500C** reaches a desired height. Note that while a preferred embodiment indicates a substantially U-shaped barrier **500** formed by three barrier segments **500A**, **500B**, and **500C**, this invention contemplates as within its scope other barriers having the same functionality as the U-shape including, but not limited to, a V-shaped configuration.

Upon installation of barrier segments **500A**, **500B**, and **500C**, casing sections **400** and interlock spaces **404** are preferably filled with a barrier filler **252** such as grout, cement, concrete, bentonite-based materials, modified cement, polysiloxane, acrylic polymers, or the like, as indicated in FIG. 2. When filled, interlock spaces **404** provide a connection having the same integrity, performance and functionality as casing sections **400** when casing sections **400** are filled. Barrier filler **252** thus cooperates with steel casing sections **400** to produce a barrier **500** that is chemically stable, even when exposed to solutions saturated with calcite, gypsum, and the like. Further, barrier **500** has a high degree of continuity, and resists attack by chemicals, microbes, and the like. Additionally, resulting barrier **500** has a low hydraulic conductivity  $K$ , preferably,  $K \leq 10^{-7}$  cm/sec, so that barrier **500** is substantially impermeable by leachate **106** generated by buried waste **102**. Finally, resulting barrier **500** is thermally stable and retains its integrity and effectiveness under a wide variety of physical and thermal conditions including ground shifting, and large temperature gradients. Barrier **500** is particularly well-suited for use in freeze/thaw conditions and conditions where heavy precipitation causes high levels of groundwater flow.



Note that a variety of means may be profitably employed to perform the functions, enumerated herein, of barrier segments **500A**, **500B** and **500C**. Barrier segments **500A**, **500B**, and **500C** are examples of barrier means for limiting migration of leachate and for containing buried waste in a zone of interest. Accordingly, the structure disclosed herein simply represents one embodiment of structure capable of performing these functions. It should be understood that this structure is presented solely by way of example and should not be construed as limiting the scope of the present invention in any way.

Once barrier segments **500A**, **500B**, and **500C** have been installed and filled with barrier filler **252**, concrete walls **600** (one wall shown removed for clarity) are installed and positioned in trench **200** (one trench shown removed for clarity) so as to abut barrier segments **500A**, **500B**, and **500C**, as indicated in FIG. 2. Thus, walls **600** cooperate with barrier **500** to form a containment system that substantially contains zone of interest **100** and prevents buried waste **102** and associated leachate **106** from escaping from zone of interest **100**.

Walls **600** preferably comprise concrete, grout, bentonite-based materials, or the like. In an alternative embodiment, only barrier segment **500A** (FIGS. 1 and 2) is installed, and walls **600** (FIG. 2) are installed in place of barrier segments **500B** and **500C**. Alternatively, barrier segment **500A** is curved such that the ends extend above the zone of interest, in which case the need for walls **600** is obviated. This invention further contemplates as within its scope a variety of combinations and arrangements of barrier segments and walls including, but not limited to, those combinations and arrangements discussed herein.

In an alternative embodiment, illustrated in FIG. 3, barrier segment **500A** is configured to facilitate collection and processing of leachate **106** produced by buried waste **102**. In particular, at least some casing sections **400** are left unfilled, i.e., not filled with barrier filler **252**, and are perforated with holes **508** collectively forming an opening or 'window' so as to permit leachate **106** to flow down into casing sections **400** where it can be collected and routed to an accumulation tank **700** or the like for holding and subsequent processing by processing system **800**. In a preferred embodiment, accumulation tank **700** includes sensors **702** or the like for monitoring various parameters including, but not limited to, leachate accumulation levels. In a preferred embodiment, processing system **800** analyzes and/or processes, by any of a variety of well known methods, said leachate to extract chemicals, minerals, metals, and other desired material. Such known methods contemplated as being within the scope of the present invention include, but are not limited to, filtration and the like.

Finally, a critical feature of the inventive containment system is the ability to monitor the integrity and performance of the containment system. The monitoring system also has a predictive capacity which allows it to predict potential problem areas and failures in the containment system. Additionally, the monitoring system of the present invention detects emissions and flow of leachate **106** from zone of interest **100**. Monitoring of leachate **106** and other emissions is important because, among other things, it permits site operators to evaluate the condition and composition of zone of interest **100**.

As indicated in FIG. 4, a 'smart' casing section **400A** is contemplated that incorporates a variety of embedded sensors for performing the aforementioned functions. As used herein, 'embedded sensors' refer to those sensors located

either internal to casing sections **400A**, and/or located on the exterior surface **408** of casing sections **400A**. A preferred embodiment of smart casing section **400A** contemplates both internal and external sensors. With reference first to external sensors, presence/concentration sensor **406** is recessed in exterior surface **408** of smart casing section **400A** and measures both the types and concentration of contaminants **108**, whether present in leachate **106** or in soil **104**. In similar fashion, distribution sensor **410** is recessed in exterior surface **408** of smart casing section **400A** and measures the spatial distribution of contaminants **108** and/or leachate **106** in soil **104**. Likewise, radiation detection and measurement ('RDM') sensor **412** is recessed in exterior surface **408** of smart casing section **400A** and monitors and reports radiological activity in zone of interest **100**. In a preferred embodiment, presence/concentration sensor **406**, distribution sensor **410**, and RDM sensor **412** are installed on smart casing section **400A** in locations remote from complementary interlocking structure **402A** and **402B**.

In addition to their respective sensing functions, presence/concentration sensor **406**, distribution sensor **410**, and RDM sensor **412** are configured to feed data to real-time data management system **414** for processing and analysis. Preferably, real-time data management system **414** comprises a computer-based application that integrates hardware, software, sensor output, positioning information and data analysis functions.

A variety of different sensor types are contemplated as being suitable for performing the functions of presence/concentration sensor **406**, distribution sensor **410**, and RDM sensor **412**. In particular, the function of presence/concentration sensor **406** is preferably performed by a surface acoustic wave (SAW) sensor or solid state sensor such as a field effect transistor (FET), as well as by Fourier transform infrared spectrometry (FTIR), time domain electromagnetics, or the like. Time domain electromagnetics, which measure presence, location, and concentration of contaminants by measuring conductivity and dielectric contrasts of the medium in which they are located, are also suitable for performing the spatial distribution measurement function of distribution sensor **410**. The radiation detection and measurement functions of RDM sensor **412** is preferably performed by gamma-ray spectrometry, plastic scintillators, scintillating fibers, miniature chamber detectors, or the like. Note that this invention contemplates as within its scope various other types of sensors that will provide the functionality described herein.

As indicated in FIG. 4, smart casing section **400A** also includes a variety of internal sensors for performing a number of different functions relating to the integrity of smart casing section **400A**. Because these sensors are internal to smart casing section **400A**, they permit monitoring of various aspects of the installation while the installation is in progress.

In view of the fact that the joints between successive smart casing sections **400A** represent a potential leak-through path for leachate **106** and contaminants **108**, the integrity of those joints is of particular concern. Accordingly, joint integrity sensor **418** evaluates the integrity of the joint between successive smart casing sections **400A**. That is, joint integrity sensor **418** determines whether there are cracks, voids, or other defects in the joint that could permit leak through of leachate **106** and/or contaminants **108**, and joint integrity sensor **418** also detects the onset and growth of cracks and voids. As with presence/concentration sensor **406**, distribution sensor **410**, and RDM sensor **412**, joint integrity sensor **418** is configured to feed data to real-time data management system **414** for processing and analysis.



Joint integrity can be evaluated in several different ways. Preferred sensors for performing this function include acoustic/ultrasonic time domain reflectometry sensors that detect cracks and large voids in structures such as smart casing section **400A**. Also, known optical fiber sensors employ fiber optic principles to make strain measurements in smart casing section **400A** and thereby detect the onset and growth of voids and cracks in smart casing section **400A**. Because joint integrity can be meaningfully evaluated in a variety of different ways, this invention contemplates as within its scope any sensor type that would be suitable for directly or indirectly measuring and evaluating joint integrity. Note also that the aforementioned sensor types are equally suitable for evaluating the integrity of the structure of smart casing section **400A** itself, that is, they are not limited solely to joint integrity applications.

In addition to containing sensors for evaluating smart casing section **400A** structure and joint integrity, smart casing section **400A** of the inventive barrier also includes migration sensor **420** for detecting migration and leakage of leachate **106** and contaminants **108**. In a preferred embodiment, migration sensor **420** comprises a sensor incorporating fiber optic coupled optical spectroscopy functionality for measuring, for example, volatile organic compounds (VOCs) that may have leaked through smart casing section **400A** of the inventive barrier. However other migration sensors suitable for measuring chemical migration, and emission of VOCs and the like are contemplated as being within the scope of the present invention. As indicated in FIG. 4, migration sensor **420** is preferably configured to feed data to real-time data management system **414** for processing and analysis.

A preferred embodiment of smart casing section **400A** also includes one or more predictive sensors **422** for identifying failure precursors in barrier filler **252** and/or in smart casing section **400A**. One preferred predictive sensor **422** is one that measures changes in the dielectric permeability and/or permittivity of barrier filler **252**. Changes in dielectric permeability and/or permittivity are typically precursors to macroscopic changes in performance of barrier filler **252**, and thus of the containment system as a whole. In an alternative embodiment, predictive sensor **422** comprises electrical source and antenna arrays (not shown) used to measure changes in resistivity of barrier filler **252**. A change in resistivity from a baseline measurement taken at installation would indicate a break or pocket in barrier filler **252**.

Predictive sensors **422** preferably also comprise a sacrificial cathode or the like for detecting conduction paths through smart casing section **400A**. Existence of a conduction path through smart casing section **400A** indicates that a failure of smart casing section **400A** will ultimately occur. Because galvanic action only occurs when there is a conduction path, galvanic action at the sacrificial cathode serves to predict failure of smart casing section **400A**. As indicated in FIG. 4, predictive sensors **422** are preferably configured to feed data to real-time data management system **414** for processing and analysis. Note that this invention contemplates as within its scope any sensor having analogous predictive capabilities, and this invention should accordingly not be construed to be limited to those embodiments enumerated and discussed herein.

In the alternative embodiments of the present invention depicted in FIGS. 1A and 1B, some or all of the sensors herein described may be placed as excavation and/or back-filling occurs.

The containment system also provides the benefit of a barrier having multiple layers. In the instance of metal

casings filled with concrete or other suitable material, at least three layers of containment are provided. The first layer comprises the top portions of the casings. The second layer comprises the concrete or other suitable material which fills the casings as well as the interlock structures. In addition to providing a second layer of containment, the concrete further enhances the strength of the barrier. The third layer comprises the bottom portions of the casings. The sensors which are indicative of the integrity and continuity of the first layer can also be applied to the second and third layers. The resulting barrier is continuous, durable, verifiable and may be instrumented to effectively measure its long-term integrity and performance.

The present invention has been described in terms of buried waste, but the systems and methods of the present invention have other applications. For instance, a barrier having perforated casings may be using in mining operations to collect the material being mined. When the collection of the mined material reaches a predetermined level, it is easily extracted from collectors in the perforated casings. Other applications include perforated barriers used for agricultural purposes. For example, the water used to irrigate an agricultural area typically drains in a particular location. A containment barrier having perforated casings can be installed in the drainage area. The smart casings may be supplied with modules that function to remove contaminants such as fertilizer and pesticide from the irrigation water.

The present invention may be embodied in other specific forms without departing from its spirit or essential characteristics. The described embodiments are to be considered in all respects only as illustrative and not restrictive. The scope of the invention is, therefore, indicated by the appended claims rather than by the foregoing description. All changes that come within the meaning and range of equivalency of the claims are to be embraced within their scope.

We claim:

**1.** A containment barrier for monitoring and containing a zone of interest, comprising:

a plurality of casing sections arranged in a series of substantially parallel tubes, the plurality of substantially parallel tubes collectively forming a barrier segment;

a plurality of sensors comprising at least a first set of sensors located on exterior surface of the plurality of the casing sections and at least a second set of sensors located internal to the plurality of casing sections;

barrier filler substantially filling the plurality of casing sections; and

a real-time data management system in operative communication with the plurality of sensors.

**2.** A containment barrier according to claim **1**, wherein the first set of sensors is configured to monitor the zone of interest and comprises at least one of the following sensor types; a presence/concentration sensor, a radiation detection and measurement sensor, and a distribution sensor.

**3.** The containment barrier according to claim **1**, wherein the second set of sensors is configured to monitor said plurality of casing sections and said barrier filler, and comprises at least one of the following sensor types; joint integrity sensor, a migration sensor, and a predictive sensor.

**4.** The containment barrier according to claim **1**, wherein at least some of the plurality of substantially parallel tubes have complementary interlocking structures.

**5.** The containment barrier according to claim **4**, wherein at least one of the plurality of sensors is located remote from the complementary interlocking structures.



## 13

6. The containment barrier according to claim 4, wherein at least one of the complementary interlocking structures is interlocked with an adjacent complementary interlocking structure.

7. The containment barrier according to claim 6, wherein at least two interlocked complementary interlocking structures are substantially filled with a barrier filler.

8. The containment claim barrier according to claim 7, wherein the barrier filler comprises at least one of: grout; cement; concrete; bentonite-based material; modified cement; polysiloxane; and acrylic polymers.

9. The containment barrier according to claim 2, wherein at least one of the sensors of the first set of sensors is configured to feed data to a real-time data management system.

10. The containment barrier according to claim 9, further comprising a real-time data management system in communication with the at least one of the sensors of the first set of sensors configured to feed data to a real-time data management system.

11. The containment barrier according to claim 10, wherein the real-time data management system comprises an integration of hardware, software, sensor output, positioning information and data analysis functions.

12. The containment barrier according to claim 1, wherein at least one of the sensors is configured as a surface acoustic wave sensor.

13. The containment barrier according to claim 1, wherein at least one of the sensors is configured as a solid state sensor.

14. The containment barrier according to claim 1, wherein at least one of the sensors is configured to function as a time domain electromagnetic sensor.

15. The containment barrier according to claim 1, wherein at least one the sensors is configured to function as a Fourier transform infrared spectrometry sensor.

16. A containment barrier for monitoring and containing a zone of interest, comprising:

a plurality of casing sections arranged in a series of substantially parallel tubes, the plurality of substantially parallel tubes collectively forming a barrier segment;

a plurality of sensors comprising at least a first set of sensors located on exterior surfaces of the plurality of the casing sections;

barrier filler substantially filling the plurality of casing sections; and

a real-time data management system in operative communication with the plurality of sensors.

17. A containment barrier according to claim 16, wherein the first set of sensors is configured to monitor the zone of interest and comprises at least one of the following sensor types: a presence/concentration sensor, a radiation detection and measurement sensor, and a distribution sensor.

18. The containment barrier according to claim 16, wherein at least some of the plurality of substantially parallel tubes have complementary interlocking structures.

19. The containment barrier according to claim 18, wherein at least one of the plurality of sensors is located remote from the complementary interlocking structures.

20. The containment barrier according to claim 18, wherein at least one of the complementary interlocking structures is interlocked with an adjacent complementary interlocking structure.

21. The containment barrier according to claim 20, wherein at least two interlocked complementary interlocking structures are substantially filled with a barrier filler.

## 14

22. The containment barrier according to claim 21, wherein the barrier filler comprises at least one of: grout; cement; concrete; bentonite-based material; modified cement; polysiloxane; and acrylic polymers.

23. The containment barrier according to claim 16, wherein at least one of the sensors of the first set of sensors is configured to feed data to a real-time data management system.

24. The containment barrier according to claim 23, further comprising a real-time data management system in communication with the at least one of the sensors of the first set of sensors configured to feed data to a real-time data management system.

25. The containment barrier according to claim 24, wherein the real-time data management system comprises an integration of hardware, software, sensor output, positioning information and data analysis functions.

26. The containment barrier according to claim 16, wherein at least one of the sensors is configured as a surface acoustic wave sensor or a solid state sensor.

27. The containment barrier according to claim 16, wherein at least one of the sensors is configured to function as a time domain electromagnetic sensor or a Fourier transform infrared spectrometry sensor.

28. The containment barrier according to claim 16, further comprising at least a second set of sensors located internal to the plurality of casing sections.

29. The containment barrier according to claim 28, wherein the second set of sensors is configured to monitor said plurality of casing sections and said barrier filler, and comprises at least one of the following sensor types: a joint integrity sensor, a migration sensor, and a predictive sensor.

30. A containment barrier for monitoring and containing a zone of interest, comprising:

a plurality of casing sections arranged in a series of substantially parallel tubes, the plurality of substantially parallel tubes collectively forming a barrier segment;

barrier filler substantially filling the plurality of casing sections;

a plurality of sensors comprising at least a first set of sensors located internal to the plurality of casing sections; and

a real-time data management system in operative communication with the plurality of sensors.

31. A containment barrier according to claim 30, wherein the first set of sensors is configured to monitor said plurality of casing sections and said barrier filler, and comprises at least one of the following sensor types: a joint integrity sensor, a migration sensor, and a predictive sensor.

32. The containment barrier according to claim 30, wherein at least some of the plurality of substantially parallel tubes have complementary interlocking structures.

33. The containment barrier according to claim 32, wherein at least one of the plurality of sensors is located remote from the complementary interlocking structures.

34. The containment barrier according to claim 32, wherein at least one of the complementary interlocking structures is interlocked with an adjacent complementary interlocking structure.

35. The containment barrier according to claim 34, wherein at least two interlocked complementary interlocking structures are substantially filled with a barrier filler.

36. The containment barrier according to claim 35, wherein the barrier filler comprises at least one of: grout; cement; concrete; bentonite-based material; modified cement; polysiloxane; and acrylic polymers.

## 15

37. The containment barrier according to claim 30, wherein at least one of the sensors of the first set of sensors is configured to feed data to a real-time data management system.

38. The containment barrier according to claim 37, further comprising a real-time data management system in communication with the at least one of the sensors of the first set of sensors configured to feed data to a real-time data management system.

39. The containment barrier according to claim 38, wherein the real-time data management system comprises an integration of hardware, software, sensor output, positioning information and data analysis functions.

40. The containment barrier according to claim 30, wherein a least one of the sensors is configured as a surface acoustic wave sensor or a solid state sensor.

## 16

41. The containment barrier according to claim 30, wherein at least one of the sensors is configured to function as a time domain electromagnetic sensor or a Fourier transform infrared spectrometry sensor.

42. The containment barrier according to claim 30, further comprising at least a second set of sensors located on exterior surfaces of the plurality of casing sections.

43. The containment barrier according to claim 42, wherein the second set of sensors is configured to monitor the zone of interest and comprises at least one of the following sensor types: a presence/concentration sensor, a radiation detection and measurement sensor, and a distribution sensor.

\* \* \* \* \*