



US005840540A

United States Patent [19][11] **Patent Number:** **5,840,540****St. George-Hyslop et al.**[45] **Date of Patent:** **Nov. 24, 1998**[54] **NUCLEIC ACIDS ENCODING PRESENILIN II**[75] Inventors: **Peter H. St. George-Hyslop; Johanna M. Rommens; Paul E. Fraser**, all of Toronto, Canada[73] Assignees: **The Hospital for Sick Children; HSC Research and Development Limited Partnership**, both of Canada[21] Appl. No.: **967,101**[22] Filed: **Nov. 10, 1997****Related U.S. Application Data**

[60] Division of Ser. No. 592,541, Jan. 26, 1996, which is a continuation-in-part of Ser. No. 509,359, Jul. 31, 1995, which is a continuation-in-part of Ser. No. 496,841, Jun. 28, 1995, which is a continuation-in-part of Ser. No. 431,048, Apr. 28, 1995.

[51] **Int. Cl.**⁶ **C12P 21/06; C07H 17/00; C07K 14/00**[52] **U.S. Cl.** **435/69.1; 435/320.1; 435/252.3; 435/325; 536/23.1; 536/24.3; 530/350**[58] **Field of Search** **435/69.1, 320.1, 435/252.3, 325; 536/23.1, 24.3; 530/350**[56] **References Cited****U.S. PATENT DOCUMENTS**

5,262,332 11/1993 Selkoe .
 5,297,562 3/1994 Potter .
 5,449,604 9/1995 Schellenberg et al. .
 5,668,006 9/1997 Hadcock et al. .

FOREIGN PATENT DOCUMENTS

2054302 4/1992 Canada .
 2071105 12/1992 Canada .
 2096911 11/1993 Canada .
 WO 91/19810 12/1991 WIPO .
 WO 94/00569 1/1994 WIPO .
 94/10569 5/1994 WIPO .
 94/23049 10/1994 WIPO .
 WO 97/03086 1/1997 WIPO .
 WO 97/03192 1/1997 WIPO .
 WO 97/03999 2/1997 WIPO .

OTHER PUBLICATIONS

Johansson et al., *J. Biol. Chem.*, 270(35):20615–20620 (1995).
 Pawlak et al., EMBL Sequence Data Library, Dec. 20, 1994, Accession No. T18858.
 Auffray et al., EMBL Sequence Data Library, Feb. 17, 1995, Accession No. F08730.
 Zahraoui et al., EMBL Sequence Data Library, Jul. 22, 1994, Accession No. X56740.
 Drivas et al., EMBL Sequence Data Library, Feb. 19, 1991, Accession No. X53143.
 Chambon et al., EMBL Sequence Data Library, Feb. 7, 1992, Accession No. M84820.
 Fleischhauer et al., EMBL Sequence Data Library, Mar. 31, 1992, Accession No. X63522.
 Yu et al., EMBL Sequence Data Library, Dec. 10, 1991, Accession No. M81766.

Sevigny et al., EMBL Sequence Data Library, Jan. 7, 1995, Accession No. U17104.

Walkley et al., EMBL Sequence Data Library, Jan. 1, 1994, Accession No. X74801.

Hillier et al., EMBL Sequence Data Library, Apr., 22, 1995, Accession No. R12984.

Fujiwara et al., EMBL Sequence Data Library, Aug. 25, 1995, Accession No. D55326.

Hillier et al., EMBL Sequence Data Library, Mar. 6, 1995, Accession No. T64843.

Barinaga, "New Alzheimer's Gene Found," *Science*, 268:1845–1846 (1995).Barinaga, "Missing Alzheimer's Gene Found," *Science*, 269:81–92(1995).Campion et al., "Mutations of the presenilin I gene in families with early-onset Alzheimer's disease," *Human Molecular Genetics*, 4(12):2373–2377 (1995).Chartier-Harlin et al., "Early onset Alzheimer's disease caused by mutations at codon 717 of the β -amyloid precursor protein gene," *Nature*, 353:844–846 (1991).Cruts et al., "Molecular genetic analysis of familial early-onset Alzheimer's disease linked to chromosome 14q24.3," *Human Molecular Genetics*, 4(12):2363–2371 (1995).Foncin et al., "Alzheimer's Presenile dementia transmitted in an extended kindred," *Rev. Neurol. (Paris)*, 141:194–202 (1985).Goate et al., "Segregation of a missense mutation in the amyloid precursor protein gene with familial Alzheimer's disease," *Nature*, 349:704–706 (1991).Goudsmit et al., "Familial Alzheimer's Disease in two kindreds of the same geographic and ethnic origin: a clinical and genetic study," *J. Neurol. Sci.*, 49:79–89 (1981).Gyapay et al., "The 1993–94 Genethon human genetic linkage map," *Nature Genetics*, 7:246–311 (1994).Karlinsky et al., "Molecular and prospective phenotypic characterization of a pedigree with familial Alzheimer's disease and a missense mutation in codon 717 of the β -amyloid precursor protein (APP) gene," *Neurology*, 42:1445–1453 (1992).Katzman, "Alzheimer's Disease," *N. Eng.J.Med.*, 314:964–973 (1986).Levy-Lahad et al., "A Familial Alzheimer's Disease Locus on Chromosome 1," *Science*, 269:970–973 (1995).

(List continued on next page.)

Primary Examiner—Karen Cochrane Carlson
Attorney, Agent, or Firm—Lerner, David, Littenberg, Krumholz & Mentlik

[57] **ABSTRACT**

The present invention describes the identification, isolation and cloning of two human presenilin genes, PS-1 and PS-2, mutations in which lead to Familial Alzheimer's Disease. Also identified are presenilin homologue genes in mice, *C. elegans* and *D. melanogaster*. Transcripts and products of these genes are useful in detecting and diagnosing Alzheimer's disease, developing therapeutics for treatment of Alzheimer's disease, as well as the isolation and manufacture of the protein and the constructions of transgenic animals expressing the mutant genes.

31 Claims, 10 Drawing Sheets

OTHER PUBLICATIONS

- Levy-Lahad et al., "Candidate Gene for the Chromosome I Familial Alzheimer's Disease Locus," *Science*, 269:973-977 (1995).
- Mullan et al., "A pathogenic mutation for probable Alzheimer's disease in the APP gene at the N-terminus of β -amyloid," *Nature Genetics*, 1:345-347 (1992).
- Mullan et al., "A locus for familial early-onset Alzheimer's disease on the long arm of chromosome 14, proximal to the α 1-antichymotrypsin gene," *Nature Genetics*, 2:340-342 (1992).
- Murrell et al., "A mutation in the amyloid precursor protein associated with hereditary Alzheimer's Disease," *Science*, 254:97-99 (1991).
- Nee et al., "A family with histologically confirmed Alzheimer's Disease," *Arch. Neurol.*, 40:203-208 (1983).
- Pericak-Vance et al., "Genetic linkage studies in Alzheimer's Disease families," *Exp. Neurol*, 102:271-279 (1988).
- Rogaev et al., "Analysis of the c-FOS gene on chromosome 14 and the promoter of the amyloid precursor protein gene in familial Alzheimer's disease," *Neurology*, 43:2275-2279 (1993).
- Rogaev et al., "Familial Alzheimer's disease in kindreds with missense mutations in a gene on chromosome 1 related to the Alzheimer's disease type 3 gene," *Nature*, 376:775-778 (1995).
- Rommens et al., "A transcription map of the region containing the Huntington disease gene," *Hum. Molec. Genet.*, 2:901-907 (1993).
- Sherrington et al., "Cloning of a gene bearing missense mutations in early-onset familial Alzheimer's disease," *Nature*, 375:754-760 (1995).
- St. George-Hyslop et al., "Genetic linkage studies suggest that Alzheimer's disease is not a single homogeneous disorder," *Nature*, 347:194-197 (1990).
- St. George-Hyslop et al., "Genetic evidence for a novel familial Alzheimer's disease locus on chromosome 14," *Nature Genetics*, 2:330-334 (1992).
- St. George-Hyslop et al., "Alzheimer's Disease and Possible Gene Interaction," *Science*, 265:537 (1994).
- Saunders et al., "Association of apolipoprotein E allele e4 with the late-onset familial and sporadic Alzheimer's disease," *Neurology*, 43:1467-1472 (1993).
- Schellenberg et al., "Genetic Linkage Evidence for a Familial Alzheimer's Disease Locus on Chromosome 14," *Science*, 258:668-670 (1992).
- Schellenberg et al., "Chromosome 14 and Late-Onset Familial Alzheimer Disease (FAD)," *Am. J. Hum. Genet.*, 53:619-628 (1993).
- Strittmatter et al., "Apolipoprotein E: high avidity binding to β -amyloid and increased frequency of type 4 allele in late-onset familial Alzheimer's disease," *Proc. Nat'l. Acad. Sci. USA*, 90:1977-1981 (1993).
- Van Broeckhoven et al., "Mapping of a gene predisposing to early-onset Alzheimer's disease to chromosome 14q24.3," *Nature Genetics*, 2:335-339 (1992).
- Van Broeckhoven, "Presenilins and Alzheimer disease," *Nature Genetics*, 11:230-232 (1995).
- Wong et al., "Mutation of the gene for the human lysosomal serine protease Cathepsin G is not the cause of aberrant APP processing in familial Alzheimer disease," *Neurosci. Lett*, 152:96-98 (1993).
- L'Hernault et al., "Mutation of a Putative Sperm Membrane Protein in *Caenorhabditis elegans* Prevents Sperm Differentiation but Not Its Associated Meiotic Divisions," *J. Cell Biol.*, 119(1):55-68 (1992).
- Li et al., "Identification and expression analysis of a potential familial Alzheimer disease gene on chromosome 1 related to AD3," *Proc. Natl. Acad. Sci. USA*, 92:12180-4 (1995).
- Yamada et al., "Complementary DNA for the mouse homolog of the human amyloid beta protein precursor," *Biochem. Biophys. Res. Comm.* 149(2):665-71 (1987).

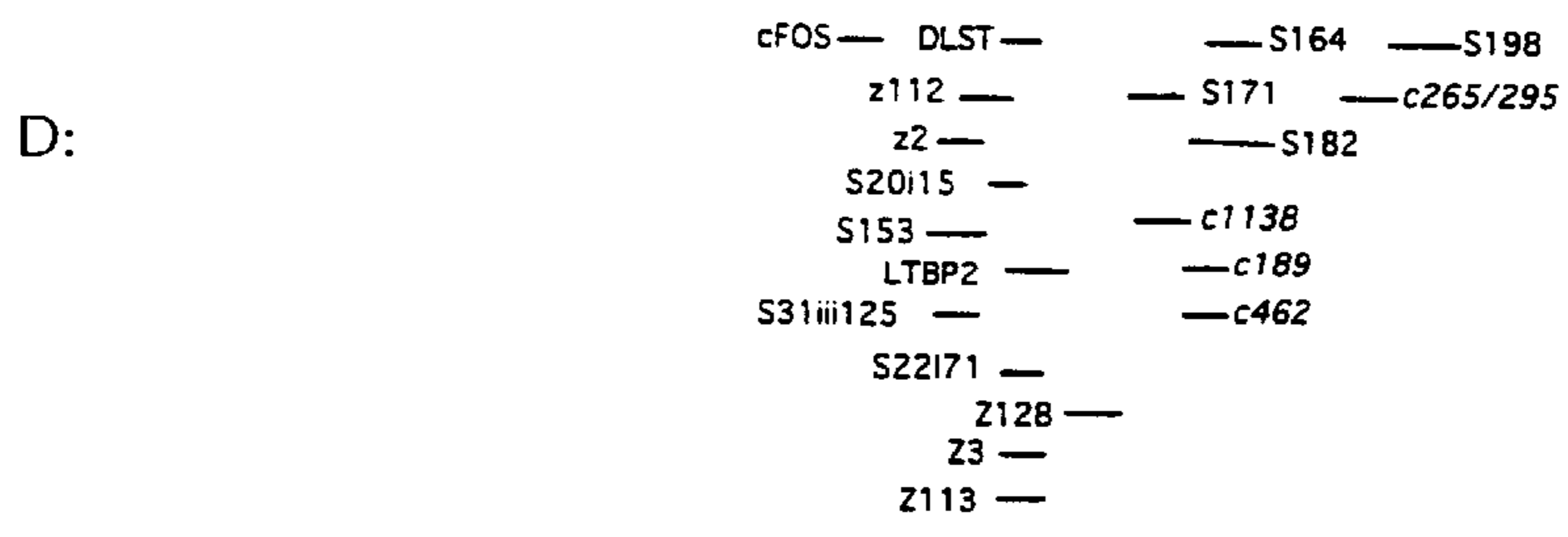
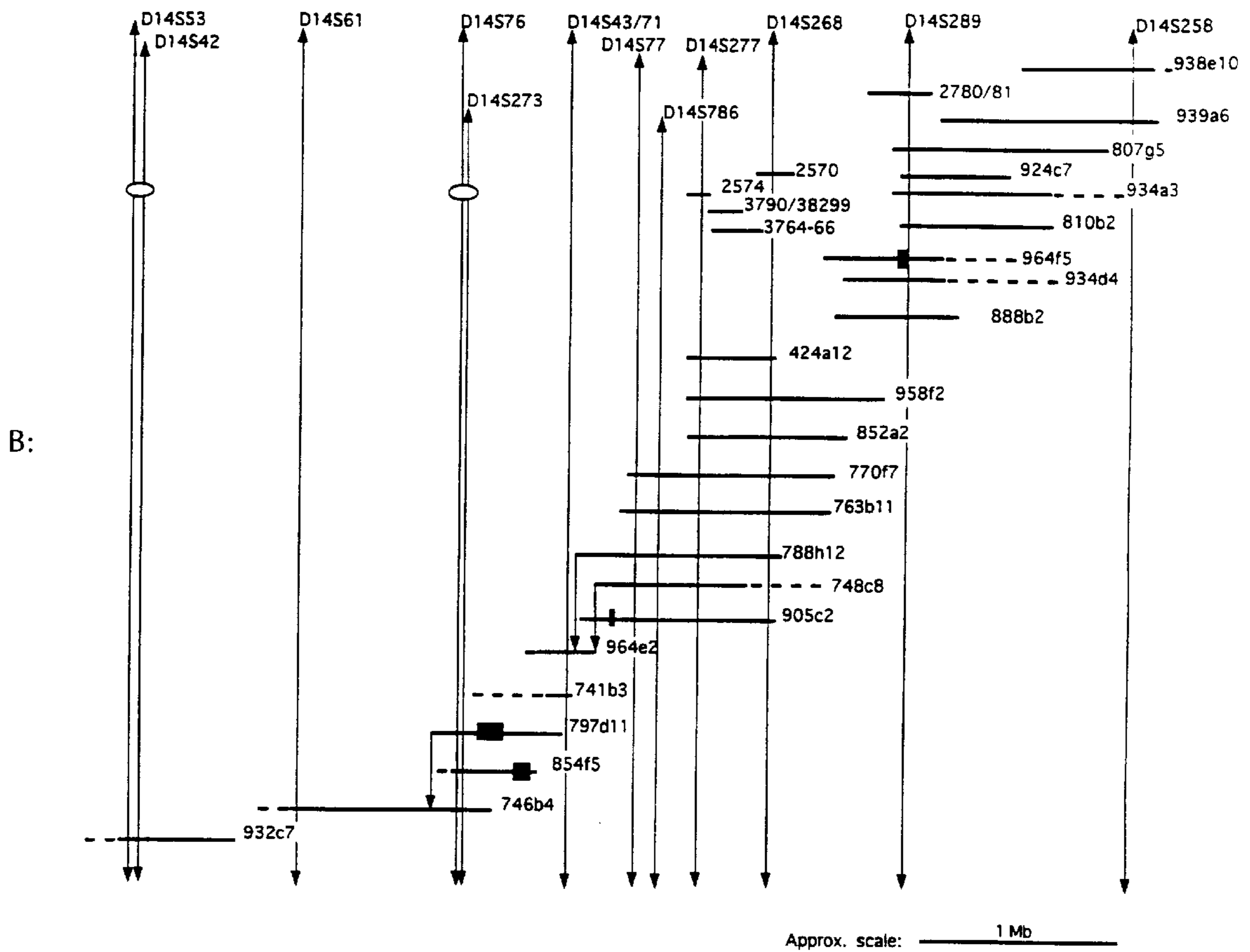
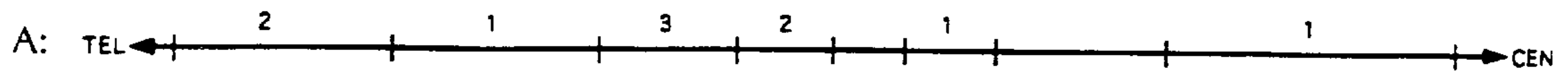
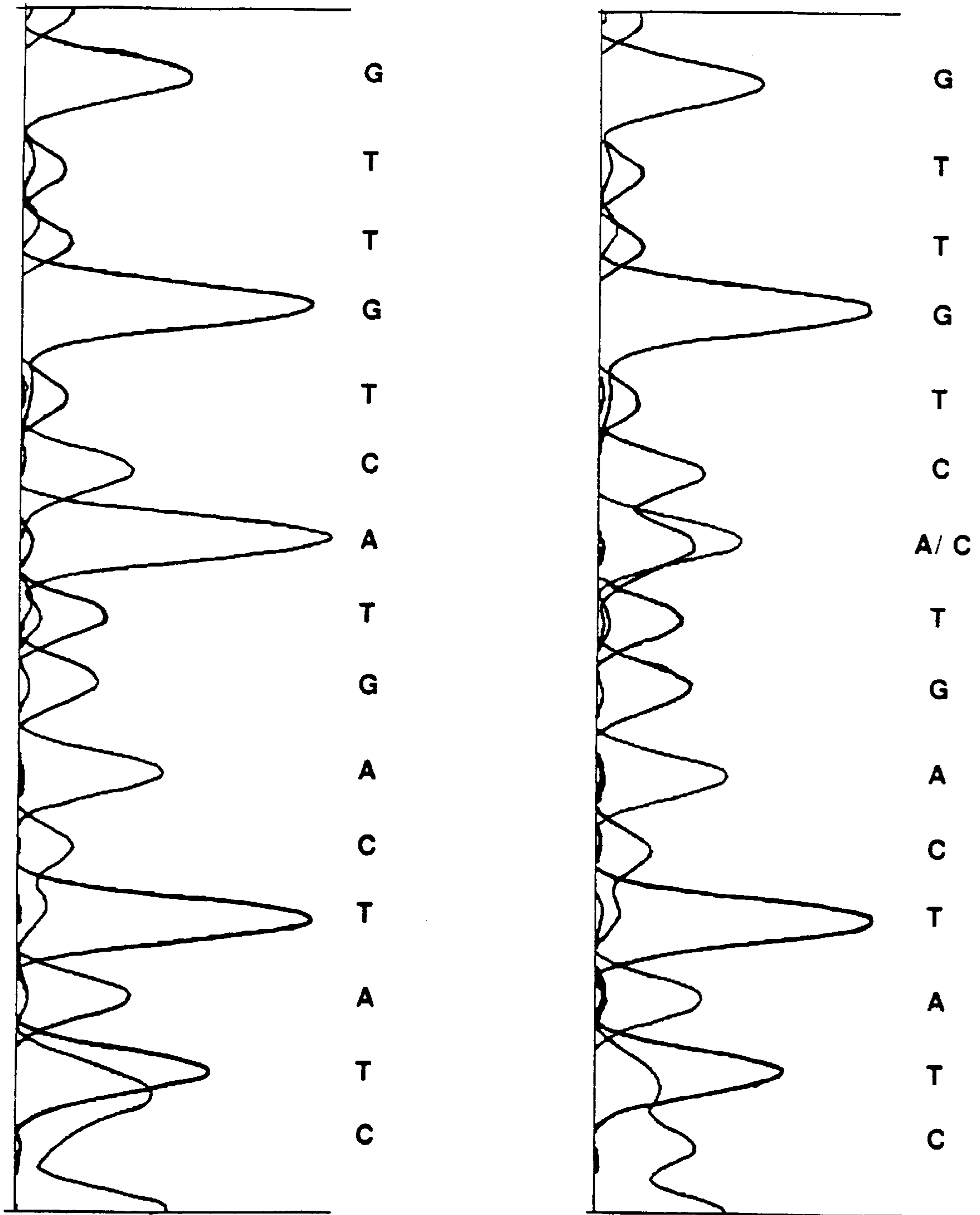

FIG. 1



Met

146

Leu

FIG. 2A

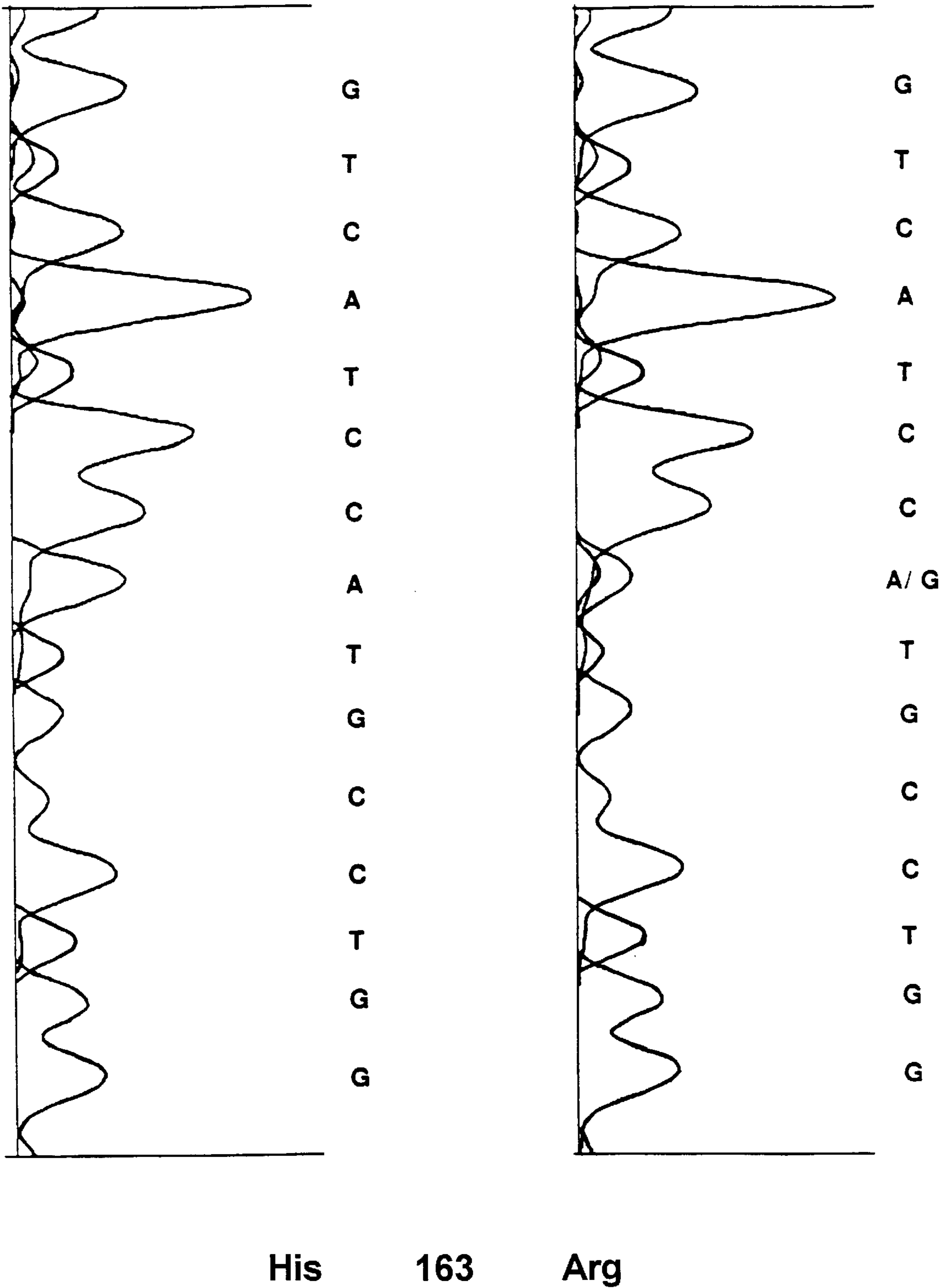
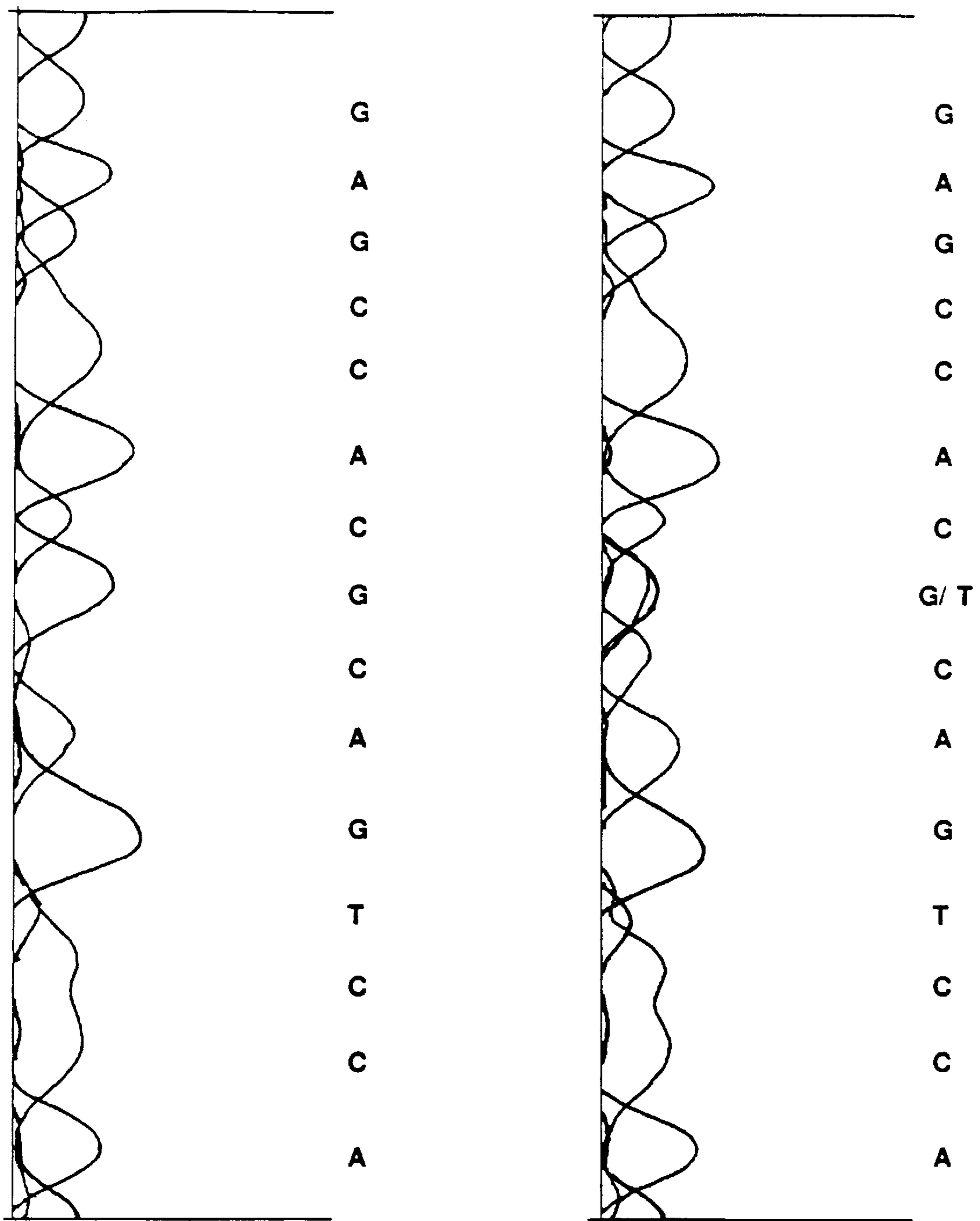

FIG. 2B



Ala

246

Glu

FIG. 2C

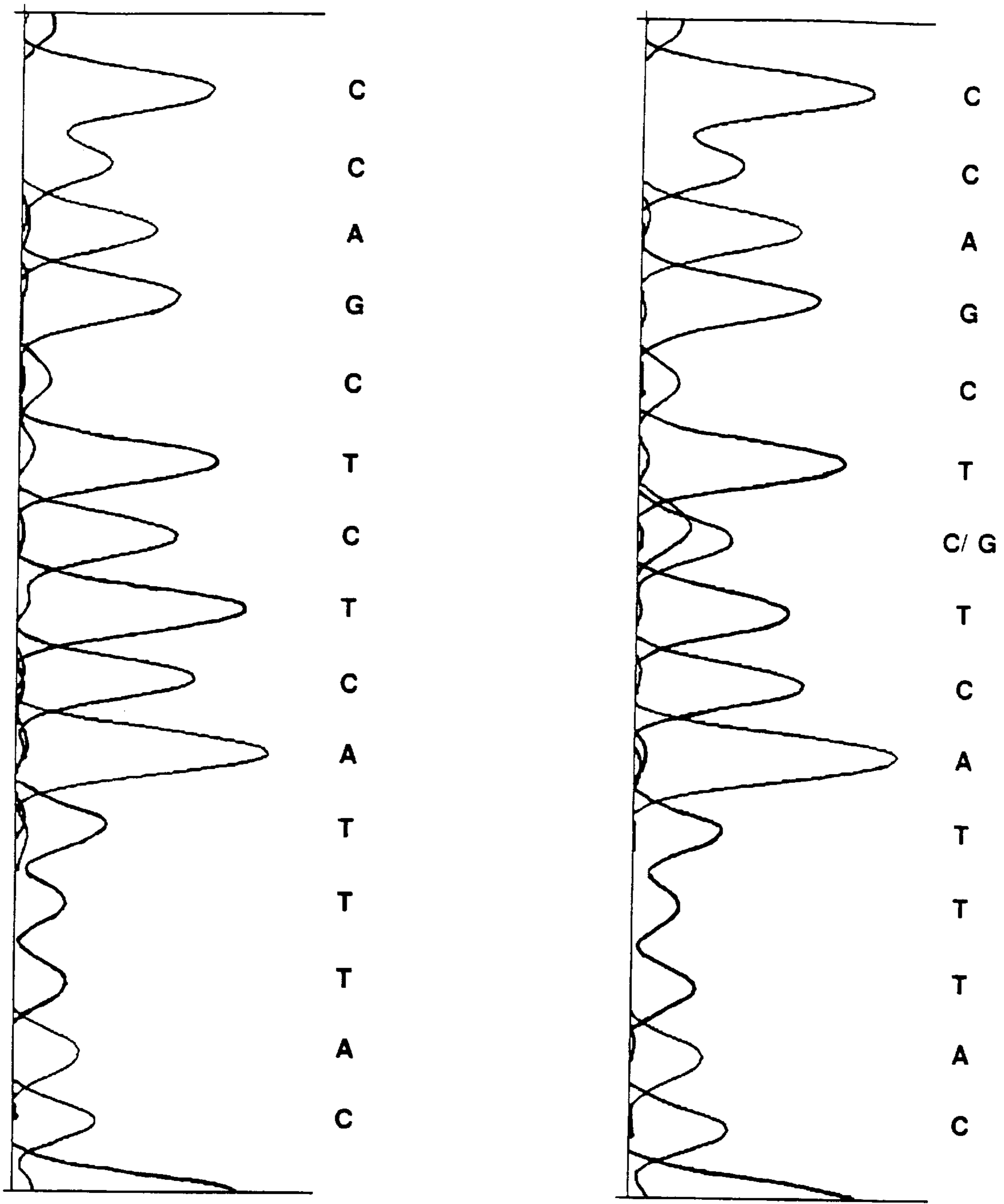

Leu

286

Val

FIG. 2D

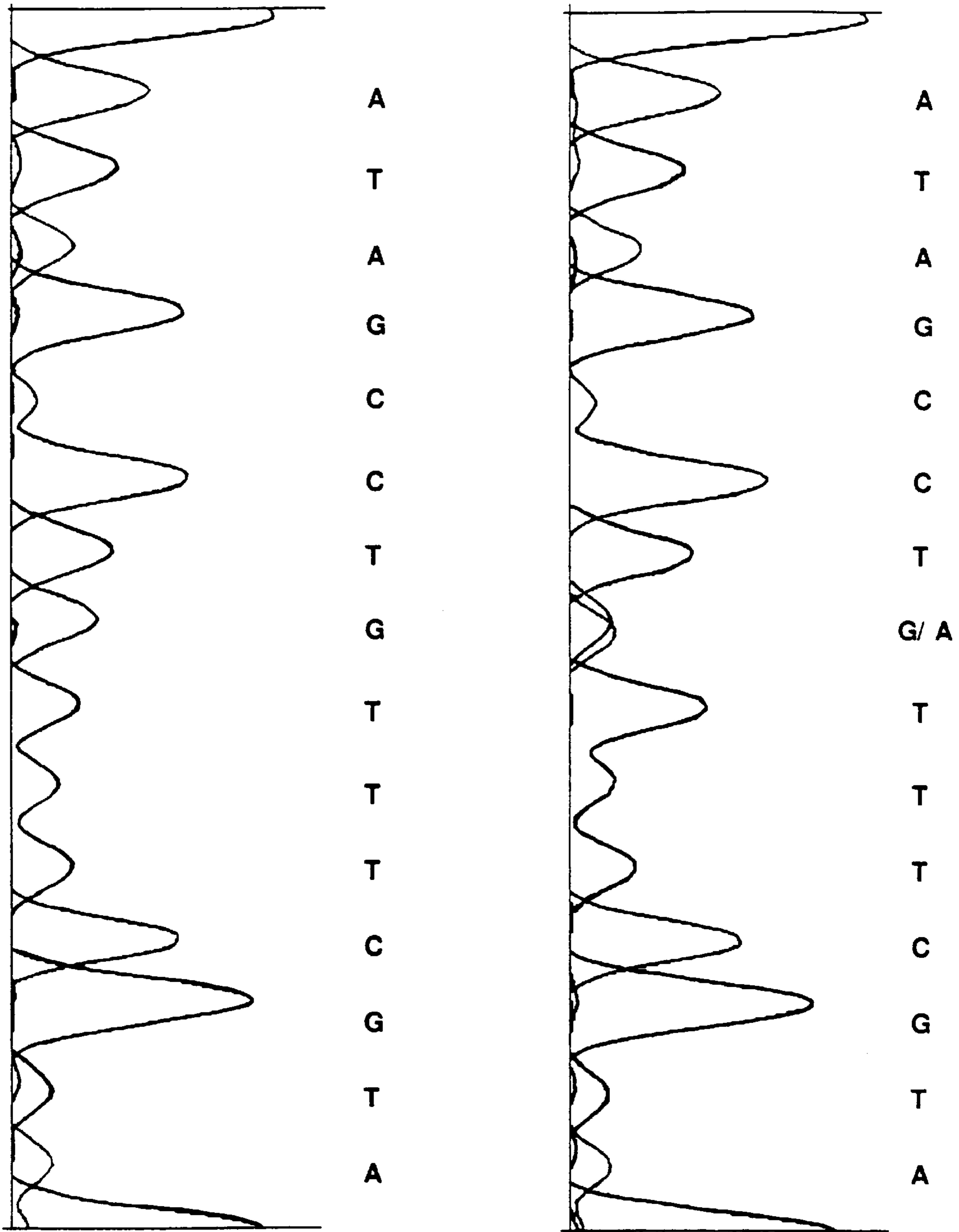

Cys 410

Tyr

FIG. 2E

FIG. 3A

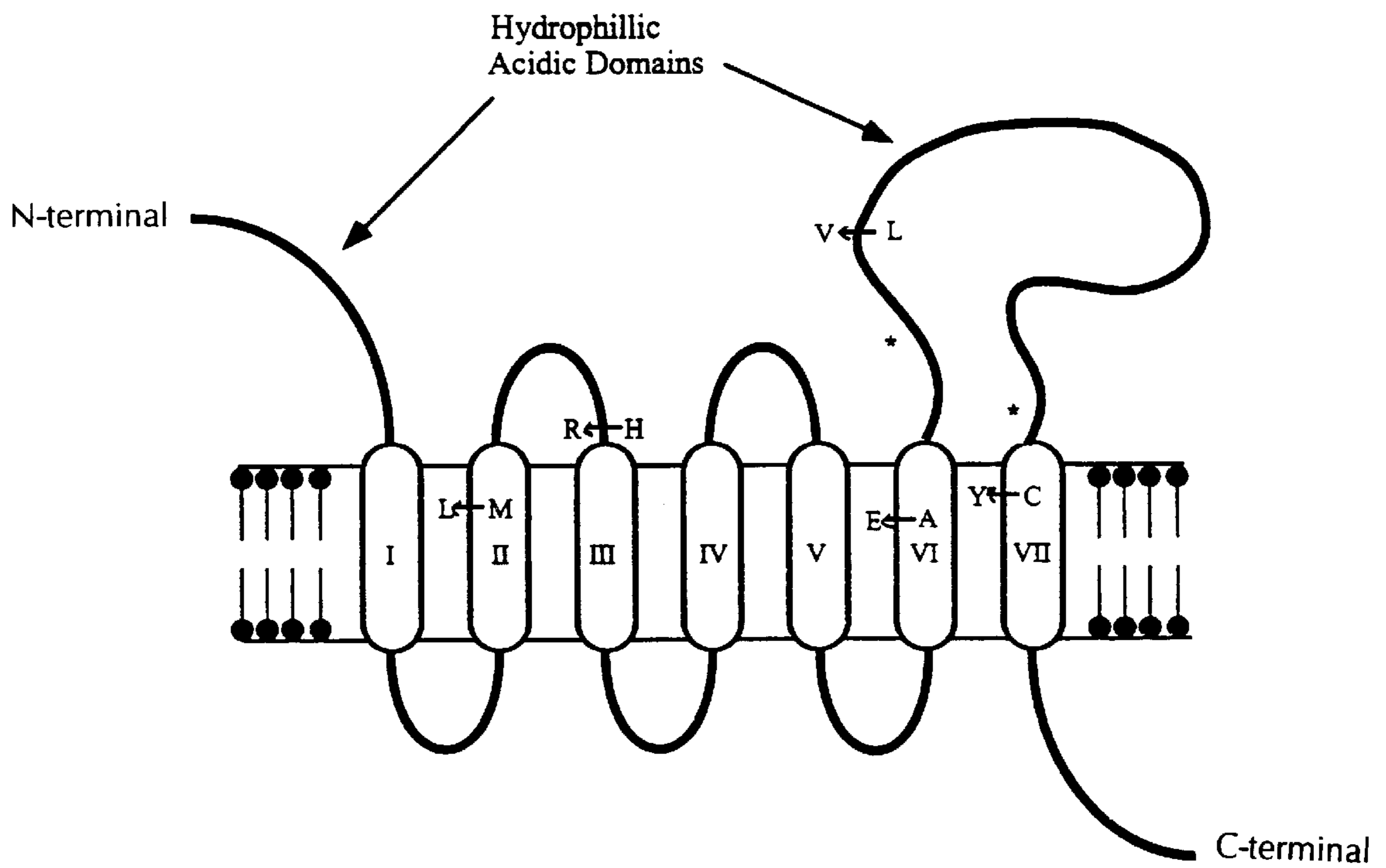
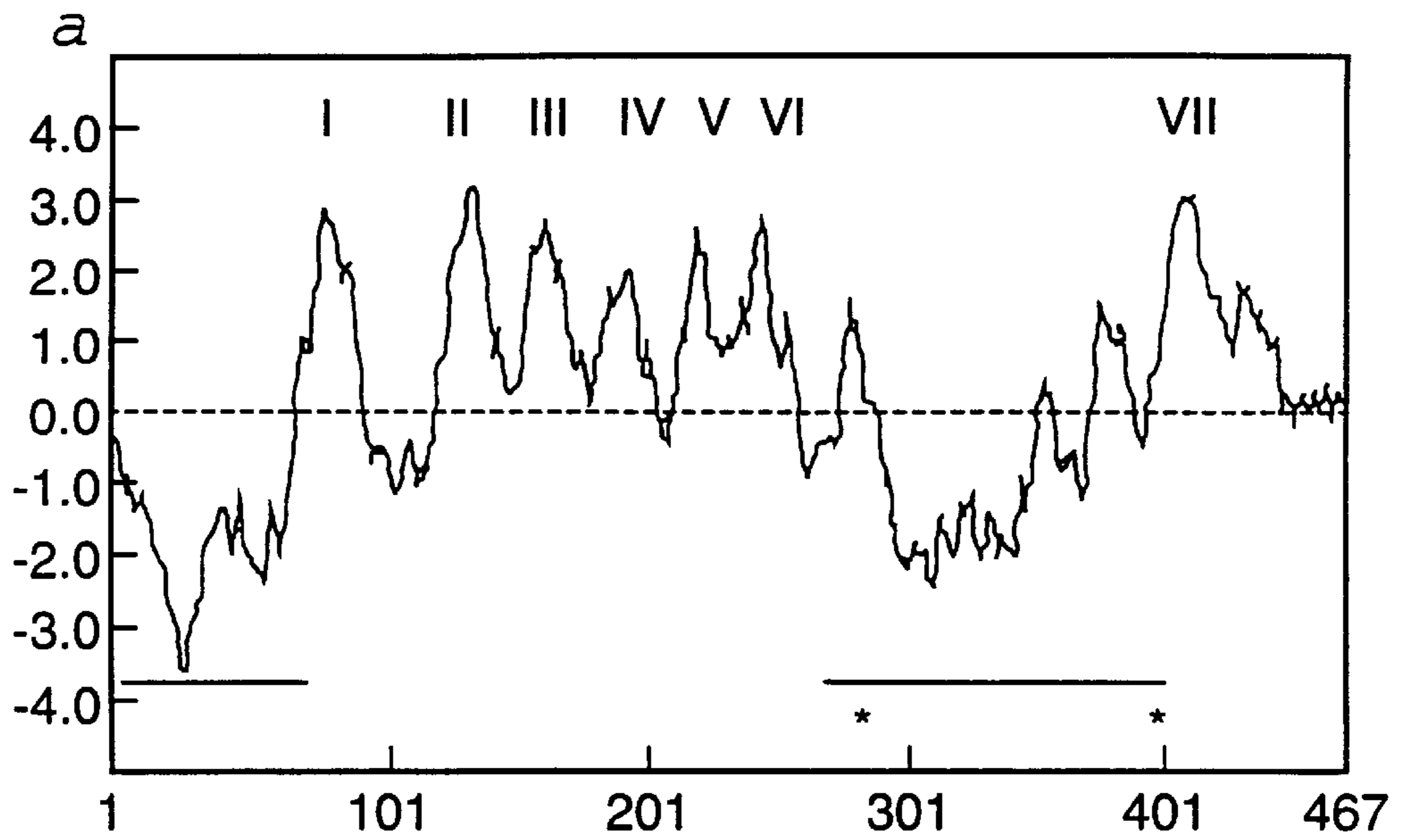

FIG. 3B

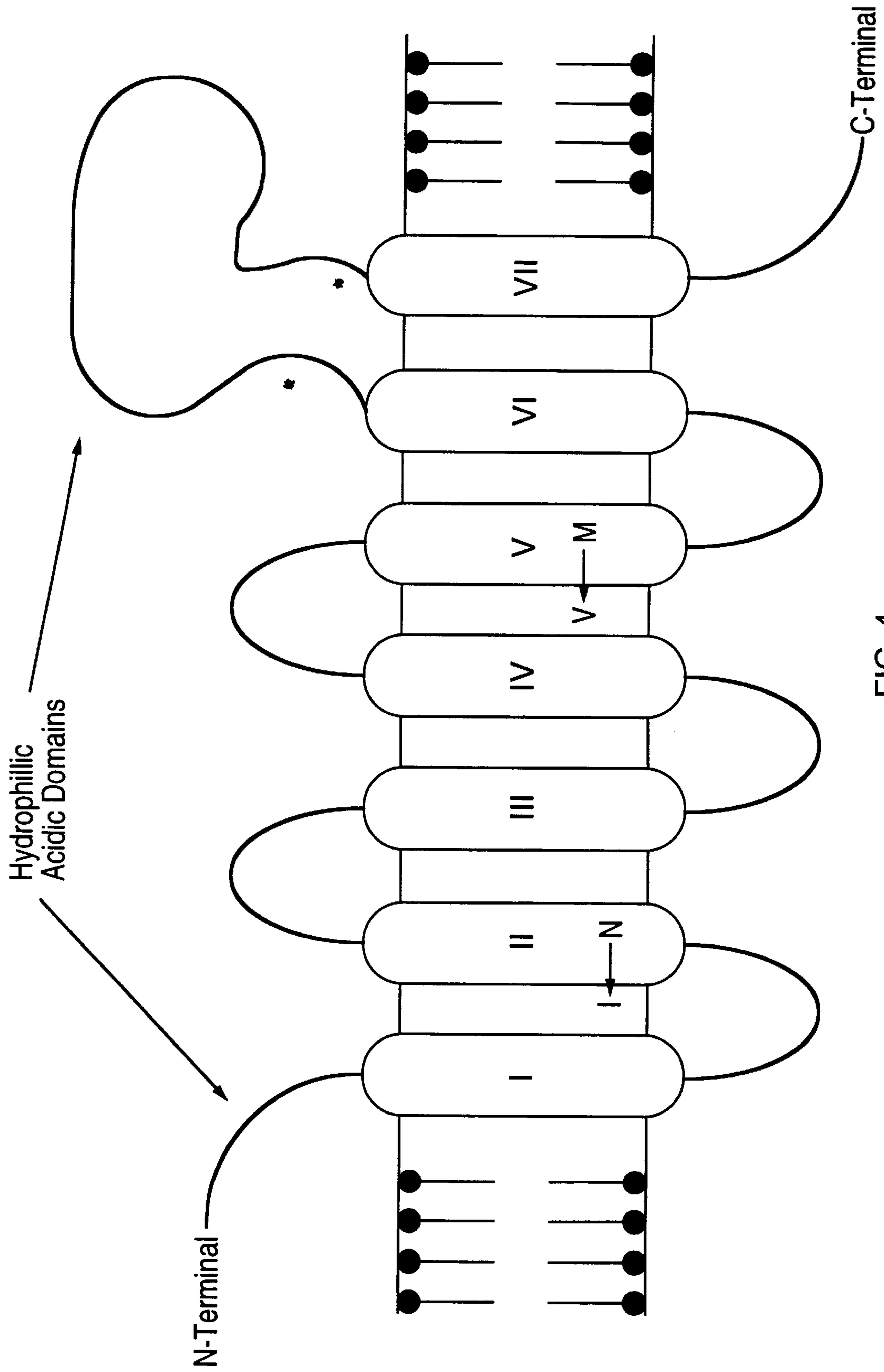

FIG. 4

FIG. 5A

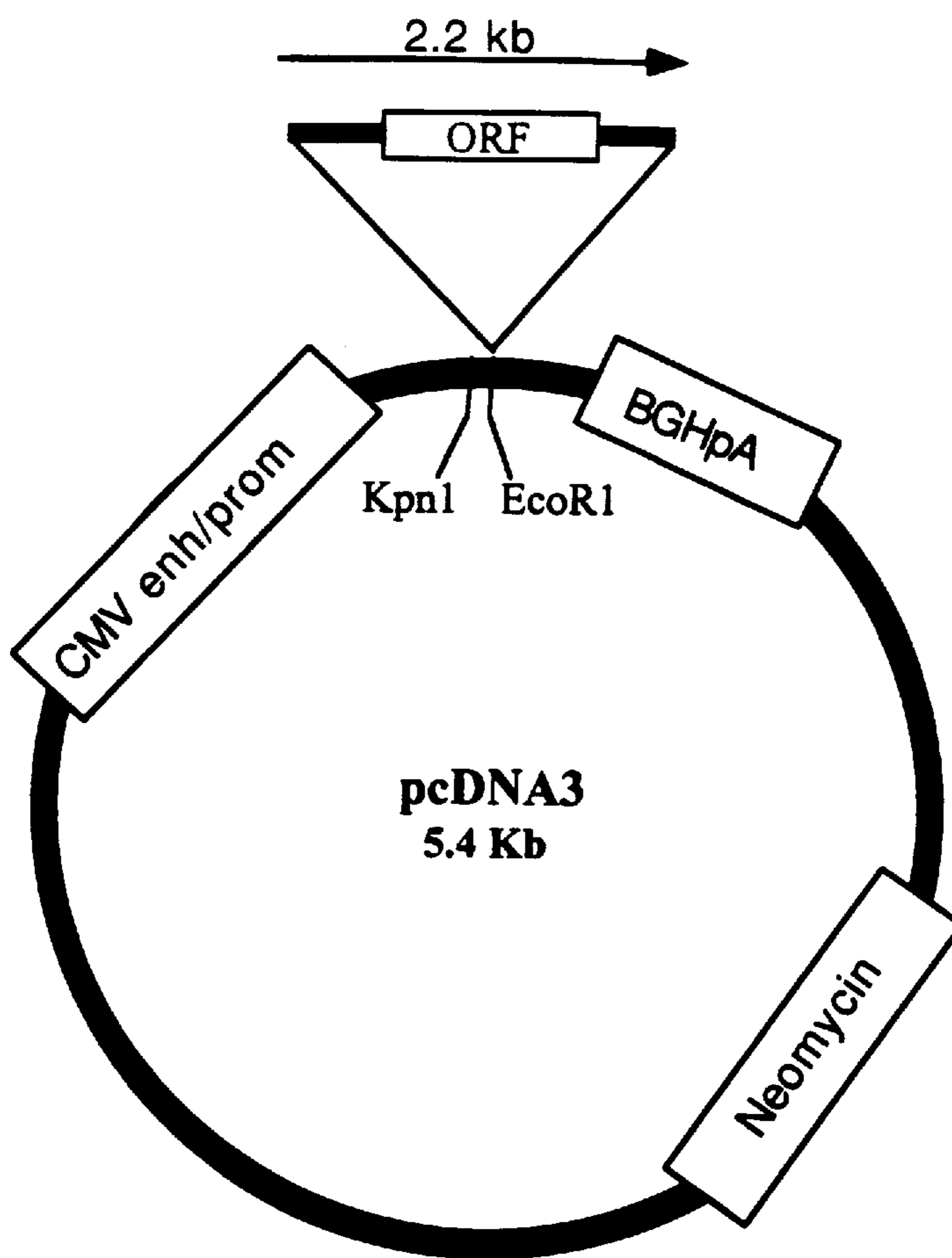
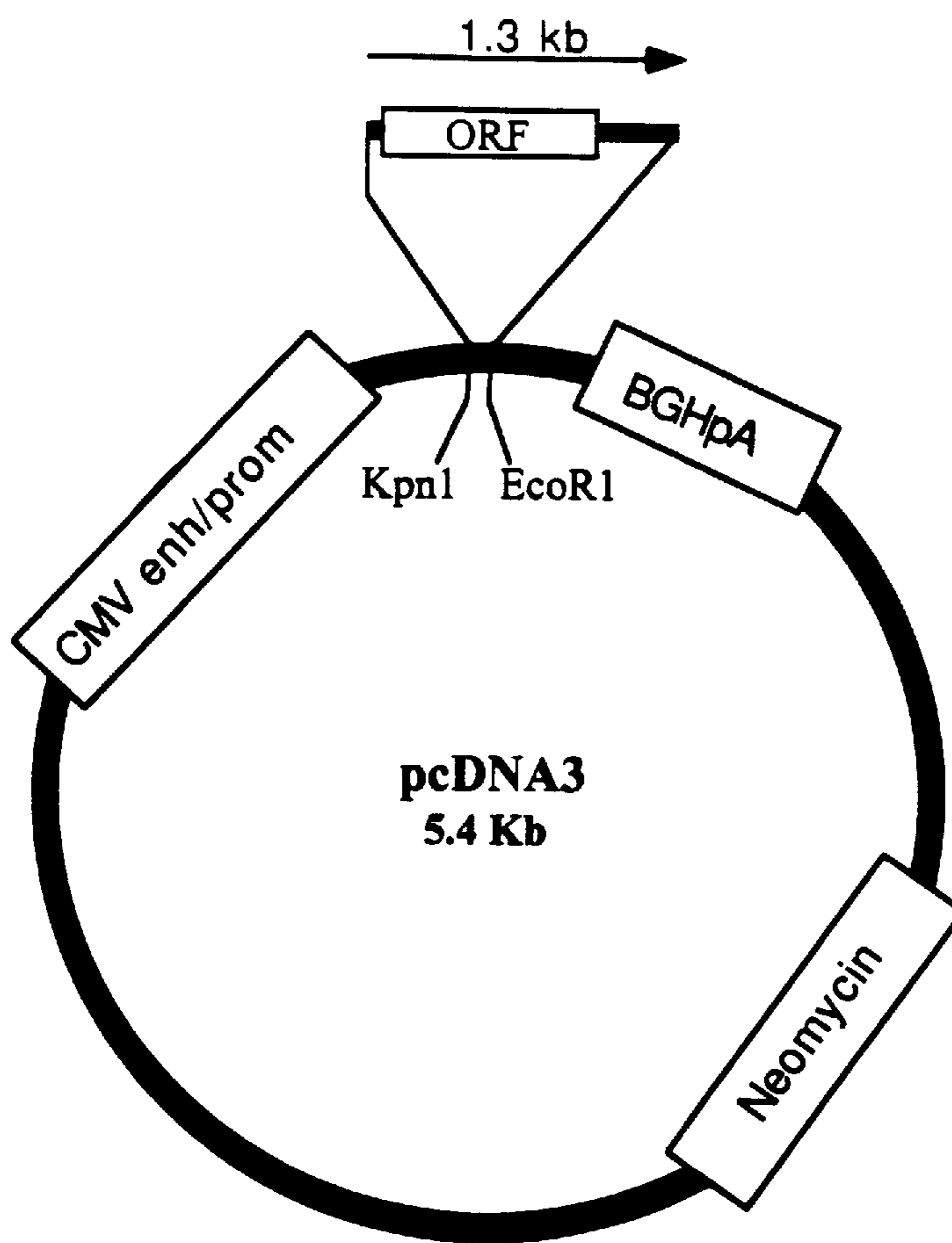

FIG. 5B



NUCLEIC ACIDS ENCODING PRESENILIN II

CROSS REFERENCE TO RELATED APPLICATIONS

This application is a Divisional of U.S. application Ser. No. 08/592,541, filed Jan. 26, 1996, which was a Continuation-In-Part of U.S. application Ser. No. 08/509,359, filed Jul. 31, 1995, which was a Continuation-In-Part of U.S. application Ser. No. 08/496,841, filed Jun. 28, 1995, which was a Continuation-In-Part of U.S. application Ser. No. 08/431,048 filed Apr. 28, 1995, all of which are incorporated herein by reference.

FIELD OF THE INVENTION

The present invention relates generally to the field of neurological and physiological dysfunctions associated with Alzheimer's Disease. More particularly, the invention is concerned with the identification, isolation and cloning of genes which when mutated are associated with Alzheimer's Disease as well as their transcripts, gene products and associated sequence information and neighbouring genes. The present invention also relates to methods for diagnosing and detecting carriers of the genes, and to Alzheimer's Disease diagnosis and gene therapy using recombinant technologies and therapy using the information derived from the DNA, protein, and the metabolic function of the protein.

BACKGROUND OF THE INVENTION

In order to facilitate reference to various journal articles, a listing of the articles is provided at the end of this specification.

Alzheimer's Disease (AD) is a degenerative disorder of the human central nervous system characterized by progressive memory impairment and cognitive and intellectual decline during mid to late adult life (Katzman, 1986). The disease is accompanied by a constellation of neuropathologic features principal amongst which are the presence of extracellular amyloid or senile plaques and the neurofibrillary degeneration of neurons. The etiology of this disease is complex, although in some families it appears to be inherited as an autosomal dominant trait. However, even amongst these inherited forms of AD, there are at least three different genes which confer inherited susceptibility to this disease (St. George-Hyslop et al., 1990). The $\epsilon 4$ (Cys112Arg) allelic polymorphism of the Apolipoprotein E (ApoE) gene has been associated with AD in a significant proportion of cases with onset late in life (Saunders et al., 1993; Strittmatter et al., 1993). Similarly, a very small proportion of familial cases with onset before age 65 years have been associated with mutations in the β -amyloid precursor protein (APP) gene (Chartier-Harlin et al., 1991; Goate et al., 1991; Murrell et al., 1991; Karlinsky et al., 1992; Mullan et al., 1992). A third locus (AD3) associated with a larger proportion of cases with early onset AD has recently been mapped to chromosome 14q24.3 (Schellenberg et al., 1992; St George-Hyslop et al., 1992; Van Broeckhoven et al., 1992).

Although chromosome 14q carries several genes which could be regarded as candidate genes for the site of mutations associated with AD3 (e.g. cFOS, alpha-1-antichymotrypsin, and cathepsin G), most of these candidate genes have been excluded on the basis of their physical location outside the AD3 region and/or the absence of mutations in their respective open reading frames (Schellenberg, GD et al., 1992; Van Broeckhoven, C et al., 1992; Rogaev et al., 1993; Wong et al., 1993).

There have been several developments and commercial directions in respect of treatment of Alzheimer's Disease and diagnosis thereof. Published PCT application WO 94 23049 describes transfection of high molecular weight YAC DNA into specific mouse cells. This method is used to analyze large gene complexes, for example the transgenic mice may have increased amyloid precursor protein gene dosage, which mimics the trisomic condition that prevails in Down's Syndrome, and allows the generation of animal models with β -amyloidosis similar to that prevalent in individuals with Alzheimer's Disease. Published international application WO 94 00569 describes transgenic non-human animals harbouring large transgenes such as the transgene comprising a human amyloid precursor protein gene. Such animal models can provide useful models of human genetic diseases such as Alzheimer's Disease.

Canadian Patent application No. 2096911 describes a nucleic acid coding for amyloid precursor protein-cleaving protease, which is associated with Alzheimer's Disease and Down's syndrome. The genetic information may be used to diagnose Alzheimer's Disease. The genetic information was isolated from chromosome 19. Canadian patent application 2071105, describes detection and treatment of inherited or acquired Alzheimer's Disease by the use of YAC nucleotide sequences. The YACs are identified by the numbers 23CB10, 28CA12 and 26FF3.

U.S. Pat. No. 5,297,562, describes detection of Alzheimer's Disease associated with trisomy of chromosome 21. Treatment involves methods for reducing the proliferation of chromosome 21 trisomy. Canadian Patent application No. 2054302 describes monoclonal antibodies which recognize a human brain cell nucleus protein encoded by chromosome 21 and are used to detect changes or expression due to Alzheimer's Disease or Down's Syndrome. The monoclonal antibody is specific to a protein encoded by human chromosome 21 and is found in large pyramidal cells of human brain tissue.

SUMMARY OF THE INVENTION

By extensive effort and a unique approach to investigating the AD3 region of chromosome 14q, the Alzheimer's related membrane protein (ARMP) gene (or presenilin I (PS 1) gene has been isolated, cloned and sequenced from within the AD3 region on chromosome 14q24.3. In addition, direct sequencing of RT-PCR products spanning this 3.0 kb cDNA transcript isolated from affected members of at least eight large pedigrees linked to chromosome 14, has led to the discovery of missense mutations in each of these different pedigrees. These mutations are absent in normal chromosomes. It has now been established that the PS1 (or ARMP) gene is causative of familial Alzheimer's Disease type AD3. In realizing this link, it is understood that mutations in this gene can be associated with other cognitive, intellectual, or psychological diseases such as cerebral hemorrhage, schizophrenia, depression, mental retardation and epilepsy. These clinical diagnoses and phenotypes are present in these AD families and these phenotypes have been seen in mutations of the APP protein gene. The Amyloid Precursor Protein (APP) gene is also associated with inherited Alzheimer's Disease. The identification of both normal and mutant forms of the PS1 gene and gene products has allowed for the development of screening and diagnostic tests for PS1 utilizing nucleic acid probes and antibodies to the gene product. Through interaction with the defective gene product and the pathway in which this gene product is involved, gene therapy, therapeutic intervention, manipulation and delivery are now made possible.

A second gene associated with AD has now been identified on human chromosome 1. This gene, the ES-1 or presenilin II (PS2) gene, also has been isolated and cloned. Mutations of this gene have been identified in patients with early onset familial AD. The PS2 (or ES-1) gene and protein have been shown to have high degrees of sequence homology at both the nucleic acid and amino acid sequence levels, and share major structural similarities, including conserved regions, tissue-specific alternative splicing patterns and predicted tertiary structure. Thus, they are believed to be representatives of a new gene family, the presenilins.

Non-human homologues of the PS1 and PS2 genes and proteins have now been identified, isolated and cloned. Amongst those disclosed herein are the murine homologue (PS1) of human PS1, a *C. elegans* member (SEL-12), and a *D. melanogaster* member (DmPS) of the presenilin gene family. Each of these genes and proteins have been identified on the basis of their high degrees of homology to the PS1/PS2 genes.

Various aspects of the invention are summarized as follows. In accordance with a first aspect of the invention, a purified mammalian polynucleotide is provided which codes for Alzheimer's related membrane protein (ARMP) or presenilin I (PS1). The polynucleotide has a sequence which is the functional equivalent of the DNA sequence of ATCC deposit 97124, deposited Apr. 28, 1995. The mammalian polynucleotide may be in the form of DNA, genomic DNA, cDNA, mRNA and various fragments and portions of the gene sequence encoding PS1. The mammalian DNA is conserved in many species, including humans and rodents, for example mice; the DNA is conserved also in all other non-mammalian vertebrates and most invertebrate organisms.

Purified human nucleotide sequences which encode mutant PS1 include those having mutations at nucleotide position (i) 685, A→C (A is replaced by C); (ii) 737, A→G; (iii) 986, C→A, iv) 1105, C→G; (v) 1478, G→A; (vi) 1027, C→T; (vii) 1102, C→T; and (viii) 1422, C→G of SEQ ID NO:1 as well as in the cDNA sequence of a further human clone of a sequence identified by SEQ ID NO:133.

The nucleotide sequences encoding both PS1 and PS2 have an alternative splice form in the gene's open reading frame. The human cDNA sequence which codes for PS1 has SEQ ID NO:1 as well as SEQ ID NO:133 as sequenced in another human clone. The mouse sequence which encodes mPS1 has SEQ ID NO:3, as well as SEQ ID NO:135 derived from a further clone containing the entire coding region. Various DNA and RNA probes and primers may be made from appropriate polynucleotide lengths selected from the sequences. Portions of the sequence also encode antigenic determinants of these presenilins.

Suitable expression vectors comprising the nucleotide sequences are provided along with suitable host cells transfected with such expression vectors.

In accordance with another aspect of the invention, purified mammalian Alzheimer's related membrane protein (ARMP) or presenilin I (PS1) is provided. The purified protein has an amino acid sequence encoded by polynucleotide sequence as identified above which for the human is SEQ ID NO:2 and SEQ ID NO:134 (derived from another clone). The mouse PS1 amino acid sequence is defined by SEQ ID NO:4 which is translated from another clone containing the entire coding region. The purified protein may have substitution mutations selected from the group consisting of the following positions identified in SEQ ID NO:2 and SEQ ID NO:134: (i) M146L; (ii) H163R; (iii)

A246E; (iv) L286V; (v) C410Y; (vi) A260V; (vii) A285V; and (viii) L392V.

In accordance with another aspect of the invention, polyclonal and monoclonal antibodies raised to specific predicted sequences of the presenilin proteins are provided. Polypeptides of at least six amino acid residues are provided. The polypeptides of six or greater amino acid residues may define antigenic epitopes of a presenilin. Monoclonal antibodies having suitably specific binding affinity for the antigenic regions of a presenilin are prepared by use of corresponding hybridoma cell lines. In addition, other polyclonal antibodies may be prepared by inoculation of animals with suitable peptides or holoprotein which add suitable specific binding affinities for antigenic regions of a presenilin.

In accordance with another aspect of the invention, an isolated DNA molecule is provided which codes for E5-1 protein.

In accordance with another aspect of the invention, purified PS2 protein is provided, having amino acid SEQ ID NO:137.

In accordance with another aspect of the invention a bioassay is provided for determining if a subject has a normal or mutant PS1 or PS2, where the bioassay comprises providing a biological sample from the subject, conducting a biological assay on the sample to detect a normal or mutant gene sequence coding for PS1 or PS2, a normal or mutant PS1 or PS2 amino acid sequence, or a normal or defective protein function.

In accordance with another aspect of the invention, a process is provided for producing PS1 or PS2 comprising culturing one of the above described transfected host cells under suitable conditions, to produce the presenilin by expressing the DNA sequence. Alternatively, a PS1 or PS2 protein may be isolated from mammalian cells in which the presenilin is normally expressed.

In accordance with another aspect of the invention, is a therapeutic composition comprising PS1 or PS2 and a pharmaceutically acceptable carrier.

In accordance with another aspect of the invention, a recombinant vector for transforming a mammalian tissue cell to express therapeutically effective amounts of PS1 or PS2 in the cells is provided. The vector is normally delivered to the cells by a suitable vehicle. Suitable vehicles include vaccinia virus, adenovirus, adeno associated virus, retrovirus, liposome transport, neurotropic viruses, Herpes simplex virus and other vector systems.

In accordance with another aspect of the invention, a method of treating a patient deficient in normal PS1 or PS2 comprising administering to the patient a therapeutically effective amount of the protein targeted at a variety of patient cells which normally express the presenilin. The extent of administration of normal PS1 or PS2 being sufficient to override any effect the presence of the mutant presenilin may have on the patient. As an alternative to protein, suitable ligands and therapeutic agents such as small molecules and other drug agents may be suitable for drug therapy designed to replace the protein and defective presenilin, displace mutant presenilin, or to suppress its formation.

In accordance with another aspect of the invention, an immunotherapy for treating a patient having Alzheimer's Disease comprises treating the patient with antibodies specific to the mutant presenilin to reduce biological levels or activity of the mutant protein in the patient. To facilitate such amino acid therapy, a vaccine composition may be provided

for evoking an immune response in a patient of Alzheimer's Disease where the composition comprises a mutant PS1 and a pharmaceutically acceptable carrier with or without a suitable excipient. The antibodies developed specific to the mutant PS1 could be used to target appropriately encapsulated drugs/molecules, specific cellular/tissue sites. Therapies utilizing specific ligands which bind to normal or wild type PS1 and which augment normal function of PS1 in membranes and/or cells or inhibits the deleterious effect of the mutant protein are also made possible.

In accordance with another aspect of the invention, a transgenic animal model for Alzheimer's Disease which has the mammalian polynucleotide sequence with at least one mutation which when expressed results in mutant PS1 or PS2 in the animal cells and thereby manifests a phenotype. For example, the human Prion gene when over-expressed in rodent peripheral nervous system and muscle cells causes a quite different response in the animal than the human. The animal may be a rodent and is preferably a mouse, but may also be other animals including rat, pig, *D. melanogaster*, *C. elegans* (nematode), all of which are used for transgenic models. Yeast cells can also be used in which a presenilin sequence is expressed from an artificial vector.

In accordance with another aspect of the invention a transgenic mouse model for Alzheimer's Disease has the mouse gene encoding a human or murine PS1 or PS2 homologue mutated to manifest the symptoms. The transgenic mouse may exhibit symptoms of cognitive memory loss or behavioural disturbances. In addition or alternatively, the symptoms may appear as another cellular tissue disorder such as in mouse liver, kidney, spleen, bone marrow or other organs in which the presenilin gene product is normally expressed.

In accordance with another aspect of the invention, the presenilin proteins and nucleic acids may be used in the screening of small molecules which will be candidates for drug therapy of Alzheimer's and related diseases. In one series of embodiments, small molecules may be screened for their ability to bind to a presenilin, especially human PS1 or PS2. In particular, assays are provided which may be used to identify small molecules which will bind selectively or preferentially to either the normal or mutant forms of PS1 or PS2. Such small molecules may be further tested using the animal models disclosed herein to further evaluate their therapeutic utility. In another series of embodiments, compounds may be tested for their ability to induce or repress expression of the presenilins, especially human PS1 or PS2. Thus, assays are provided in which the ability of a compound to alter the levels of presenilin mRNA transcripts or protein in a cell or cell culture is tested. In preferred embodiments, the 5' regulatory region of a presenilin gene, especially a human PS1 or PS2 gene, are operatively joined to a reporter gene and cells are transformed with this recombinant construct. Such recombinant cells may then be used in high through-put assays for compounds which affect the expression of the presenilins.

In accordance with another aspect of the invention, the proteins of the invention can be used as starting points for rational drug design to provide ligands, therapeutic drugs or other types of small chemical molecules. Alternatively, small molecules or other compounds identified by the above-described screening assays may serve as "lead compounds" in rational drug design.

DETAILED DESCRIPTION OF THE INVENTION

Various aspects of the invention are described hereinafter with respect to the drawings wherein:

FIG. 1, panel A is a schematic drawing of the genomic physical and transcriptional map of the AD3 region of chromosome 14. Genetic map inter-marker genetic distances averaged for male and female meiosis are indicated in centiMorgans.

FIG. 1, panel B is a schematic drawing of the constructed physical contig map of overlapping genomic DNA fragments cloned into YACs spanning a FAD locus on chromosome 14q.

FIG. 1, panel C is a schematic drawing of regions of interest within the constructed physical contig map.

FIG. 1, panel D is a schematic drawing of a transcriptional map illustrating physical locations of the 19 independent longer cDNA clones.

FIG. 2, panel A is a reproduction of the output of an automated fluorescent chromatogram representing the change in nucleic acids which direct the Met 146 Leu change in the amino acid sequence of the ARMP or PS1 gene.

FIG. 2, panel B is a reproduction of the output of an automated fluorescent chromatogram representing the change in nucleic acids which direct the His 163 Ala change in the amino acid sequence of the gene.

FIG. 2, panel C is a reproduction of the output of an automated fluorescent chromatogram representing the change in nucleic acids which direct the Ala 246 Glu change in the amino acid sequence of the gene.

FIG. 2, panel D is a reproduction of the output of an automated fluorescent chromatogram representing the change in nucleic acids which direct the Leu 286 Val change in the amino acid sequence of the gene.

FIG. 2, panel E is a reproduction of the output of an automated fluorescent chromatogram representing the change in nucleic acids which direct the Cys 410 Tyr change in the amino acid sequence of the gene.

FIG. 3, panel A is a representation of a hydropathy plot of the putative PS1 protein.

FIG. 3, panel B is a schematic drawing of a model for the structural organization of the putative PS1 protein. Roman numerals depict the transmembrane domains. Putative glycosylation sites are indicated as asterisks and most of the phosphorylation sites are located on the same membrane face as the two acidic hydrophilic loops. The MAP kinase site is present at residue 115 and the PKC site at residue 114. FAD mutation sites are indicated by horizontal arrows.

FIG. 4 is a schematic drawing of the predicted structure of the PS2 protein.

FIG. 5A depicts an expression vector containing the entire ARMP cDNA sequence and includes the 5' untranslated region.

FIG. 5B depicts an expression vector containing a truncated ARMP cDNA in which the 5' untranslated region is replaced with an artificial Kozak consensus sequence around the 5' cloning site.

DESCRIPTION OF THE PREFERRED EMBODIMENTS

In order to facilitate review of the various embodiments of the invention and an understanding of the various elements and constituents used in making and using the invention, the following terms used in the invention description have the following meanings:

Alzheimer Related Membrane Protein (ARMP) or Presenilin-I (PS1) Gene—the chromosome 14 gene which when mutated is associated with familial Alzheimer's Dis-

ease and/or other inheritable disease phenotypes (e.g. cerebral hemorrhage, mental retardation, schizophrenia, psychosis, and depression). This definition is understood to include sequence polymorphisms wherein nucleotide substitutions in the gene sequence do not affect the essential function of the gene product, as well as functional equivalents of the nucleotide sequences of SEQ ID NO:1, SEQ ID NO:133, and SEQ ID NO:5. This term primarily relates to an isolated coding sequence, but can also include some or all of the flanking regulatory elements and/or introns. The term PS1 gene includes genes in other species analogous to this human gene which when mutated is associated with Alzheimer's Disease. This gene is also referred to as the ARMP gene, and sometimes as the S182 gene.

Alzheimer Related Membrane Protein (ARMP) or Presenilin-I Protein—the protein encoded by the PS1 gene. This protein is also referred to as ARMP. The preferred source of protein is the mammalian protein as isolated from human or other animal cells. Alternatively, functionally equivalent proteins may exist in plants, insects and invertebrates (such as *C. elegans*). The protein may be produced by recombinant organisms, or chemically or enzymatically synthesized. This definition is understood to include the amino acid sequences of SEQ ID NO:2 and SEQ ID NO:134 and also the various polymorphic forms of the protein wherein amino acid substitutions or deletions within the amino acid sequence do not affect the essential functioning of the protein. The term also includes functional fragments of PS1 and functional equivalents of the PS1 amino acid sequence. Mutant PS1 Gene—The PS1 gene containing one or more mutations which typically lead to Alzheimer's Disease and/or other inheritable disease phenotypes (e.g. cerebral hemorrhage, mental retardation, schizophrenia, psychosis, and depression). This definition is understood to include the various mutations that exist, wherein nucleotide substitutions in the gene sequence affect the essential function of the gene product, as well as mutations of functional equivalents of the nucleotide sequences of SEQ ID NO:1, SEQ ID NO:133 and ID NO:5. This term primarily relates to an isolated coding sequence, but can also include some or all of the flanking regulatory elements and/or introns.

Mutant PS1—a mammalian protein that is highly analogous to PS1 in terms of primary structure, but wherein one or more amino acid insertions, deletions and/or substitutions result in impairment of its essential function, so that mammals, especially humans, whose PS1 producing cells express mutant PS1 rather than the normal PS1, are predisposed to demonstrate the symptoms of Alzheimer's Disease and/or other relevant inheritable phenotypes (e.g. cerebral hemorrhage, mental retardation, schizophrenia, psychosis, and depression).

mPS1 Gene—mouse gene analogous to the human PS1 gene. This definition is understood to include sequence polymorphisms wherein nucleotide substitutions in the gene sequence do not affect the essential function of the gene product, as well as functional equivalents of the nucleotide sequence of SEQ ID NO:135. This term primarily relates to an isolated coding sequence, but can also include some or all of the flanking regulatory elements and/or introns.

mPS1—mouse Alzheimer related membrane protein, encoded by the mPS1 gene and analogous to the human PS1. This definition is understood to include the amino acid sequence of SEQ ID NO:4 and also the various polymorphic forms of the protein wherein amino acid substitutions, insertions, or deletions within the amino acid sequence do not affect the essential functioning of the protein. The term also includes functional fragments of the protein and functional equivalents of its amino acid sequence.

Mutant mPS1 gene—the mPS1 gene containing one or more mutations which typically lead to one or more amino acid insertions, deletions and/or substitutions resulting in impairment of the function of the mPS1 protein. This definition is understood to include the amino acid sequence of SEQ ID NO:4 and also the various polymorphic forms of the protein wherein amino acid substitutions or deletions within the amino acid sequence do not affect the essential functioning of the protein. The term also includes functional fragments of the protein and functional equivalents of its amino acid sequence.

Mutant mPS1—a mouse protein which is highly analogous to mPS1 in terms of primary structure, but wherein one or more amino acid insertions, deletions and/or substitutions result in impairment of its essential function, so that mice, whose mPS1 producing cells express mutant mPS1 rather than the normal mPS1, are predisposed to demonstrate the symptoms of Alzheimer's Disease and/or other relevant inheritable phenotypes, or other phenotypes and behaviours as manifested in mice.

PS1 or PS2 carrier—a mammal in apparent good health whose chromosomes contain a mutant PS1 or PS2 gene that may be transmitted to offspring and which will, in most cases, develop Alzheimer's Disease in mid to late adult life.

Missense mutation—A mutation of nucleic acid sequence which alters a codon to that of another amino acid, causing an altered translation product to be made.

Pedigree—In human genetics, a diagram showing the ancestral relationships and transmission of genetic traits over several generations in a family.

PS2 gene—the chromosome 1 gene which shows homology to the PS1 gene and which when mutated is associated with familial Alzheimer's Disease and/or other inheritable disease phenotypes. This definition is understood to include sequence polymorphisms wherein nucleotide substitutions in the gene sequence do not affect the essential function of the gene product, as well as functional equivalents of the nucleotide SEQ ID NO:136. This term primarily relates to an isolated coding sequence, but can also include some or all of the flanking regulatory elements and/or introns. This term also includes the gene in other species analogous to the human gene described herein. This gene is also referred to as the E5-1 gene.

PS2 protein—the protein encoded by the PS2 gene. This protein is also referred to as E5-1. The term PS2 protein includes the protein of SEQ ID NO:137 and also the various polymorphic and splice variant forms of the protein wherein amino acid substitutions or deletions within the amino acid sequence do not affect the essential functioning of the protein. The term also includes functional fragments of the protein and functional equivalents of its amino acid sequence.

Mutant PS2 gene—the PS2 gene containing one or more mutations which typically lead to Alzheimer's Disease. This term is understood to include the various mutations that exist, wherein nucleotide substitutions, insertions, or deletions in the gene sequence affect the essential function of the gene product. This term primarily relates to an isolated coding sequence but can also include some or all of the flanking regulatory elements and/or introns.

Mutant PS2 protein—a protein analogous to PS2 protein but wherein one or more amino acid insertions, deletions and/or substitutions result in impairment of its essential function such that mammals, especially humans, whose PS2-producing cells express mutant PS2 protein, are predisposed to demonstrate the symptoms of Alzheimer's Disease.

DmPS gene—*Drosophila melanogaster* gene analogous to the human PS1 and PS2 genes. This definition is understood

to include the amino acid sequence polymorphisms wherein nucleotide substitutions, insertions or deletions in the gene sequence do not affect the essential function of the gene product, as well as functional equivalents of the nucleotide sequence, SEQ ID NO:165. This term primarily relates to an isolated coding sequence but can also include some or all of the flanking regulatory elements and/or introns.

DmPS protein—The protein encoded by the DmPS gene and analogous to the human presenilins. This definition is understood to include the amino acid sequence of SEQ ID NO:166 and also the various polymorphic forms of the protein wherein amino acid substitutions, insertions or deletions within the amino acid sequence do not affect the essential functioning of the protein. The term also includes functional fragments of the protein and functional equivalents of its amino acid sequence.

Mutant DmPS Gene—the DmPS gene containing one or more mutations which lead to one or more amino acid insertions, deletions and/or substitutions resulting in impairment of the function of the DmPS protein.

Mutant DmPS Protein—a *D. melanogaster* protein which is highly analogous to DmPS protein in terms of primary structure, wherein one or more amino acid insertions, deletions and/or substitutions result in impairment of its essential function.

Functional Equivalent—as used in describing gene sequences and amino acid sequences means that a recited sequence need not be identical to the definitive sequence of the SEQ ID NOs but need only provide a sequence which functions biologically and/or chemically as the equivalent of the definitive sequence. Hence sequences which correspond to a definitive sequence may also be considered as functionally equivalent sequence.

Linkage analysis—Analysis of co-segregation of a disease trait or disease gene with polymorphic genetic markers of defined chromosomal location.

hPS1 gene—human PS1 gene

ORF—open reading frame.

PCR—polymerase chain reaction.

contig—contiguous cloned regions

YAC—yeast artificial chromosome

RT-PCR—reverse transcription polymerase chain reaction.

SSR—Simple sequence repeat polymorphism.

Homology—typically measured using sequence analysis software (e.g., Sequence Analysis Software Package of the Genetics Computer Group, University of Wisconsin Biotechnology Center, 1710 University Avenue, Madison, Wis. 53705). Such software matches similar sequences by assigning degrees of homology to various insertions, deletions, substitutions, and other modifications. Conservative substitutions typically include substitutions within the following groups: glycine, alanine; valine, isoleucine, leucine; aspartic acid, glutamic acid, asparagine, glutamine; serine, threonine; lysine, arginine; and phenylalanine, tyrosine.

Percent Identity—is a measure of the identity of any two amino acid or nucleic acid sequences over a defined length.

Protein and polypeptide—any chain of amino acids, regardless of length or post-translational modification (e.g., glycosylation or phosphorylation).

Substantially pure preparation—is a preparation which is at least 60% by weight (dry weight) the compound of interest. Preferably the preparation is at least 75%, more preferably at least 90%, and most preferably at least 99%, by weight the compound of interest. Purity can be measured by any appropriate method, e.g., column chromatography, polyacrylamide gel electrophoresis, or HPLC analysis.

Isolated DNA—is DNA that is not immediately contiguous with both of the coding sequences with which it is imme-

diately contiguous (one on the 5' end and one on the 3' end) in the naturally occurring genome of the organism from which it is derived. The term therefore includes, for example, a recombinant DNA which is incorporated into a vector; into an autonomously replicating plasmid or virus; or into the genomic DNA of a prokaryote or eukaryote, or which exists as a separate molecule (e.g., a cDNA or a genomic DNA fragment produced by PCR or restriction endonuclease treatment) independent of other sequences. It also includes a recombinant DNA which is part of a hybrid gene encoding additional polypeptide sequence.

Substantially identical amino acid sequence—is an amino acid sequence which differs only by conservative amino acid substitutions, for example, substitution of one amino acid for another of the same class (e.g., valine for glycine, arginine for lysine, etc.) or by one or more non-conservative substitutions, deletions, or insertions located at positions of the amino acid sequence which do not destroy the function of the protein (assayed, e.g., as described herein). Preferably, such a sequence is at least 85%, more preferably 90%, and most preferably 95% identical at the amino acid level to the sequence of the protein or peptide to which it is being compared. For nucleic acids, the length of comparison sequences will generally be at least 50 nucleotides, preferably at least 60 nucleotides, more preferably at least 75 nucleotides, and most preferably 110 nucleotides. A “substantially identical” nucleic acid sequence codes for a substantially identical amino acid sequence as defined above.

Transformed cell—is a cell into which (or into an ancestor of which) has been introduced, by means of recombinant DNA techniques, a DNA molecule encoding a protein of interest.

Operably Joined. A coding sequence and a regulatory region are said to be operably joined when they are covalently linked in such a way as to place the expression or transcription of the coding sequence under the influence or control of the regulatory region. If it is desired that the coding sequences be translated into a functional protein, two DNA sequences are said to be operably joined if induction of promoter function results in the transcription of the coding sequence and if the nature of the linkage between the two DNA sequences does not (1) result in the introduction of a frame-shift mutation, (2) interfere with the ability of the regulatory region to direct the transcription of the coding sequences, or (3) interfere with the ability of the corresponding RNA transcript to be translated into a protein. Thus, a regulatory region would be operably joined to a coding sequence if the regulatory region were capable of effecting transcription of that DNA sequence such that the resulting transcript might be translated into the desired protein or polypeptide.

Stringent Hybridization Conditions. Stringent hybridization conditions is a term of art understood by those of ordinary skill in the art. For any given nucleic acid sequence, stringent hybridization conditions are those conditions of temperature and buffer solution which will permit hybridization of that nucleic acid sequence to its complementary sequence and not to substantially different sequences. The exact conditions which constitute “stringent” conditions, depend upon the length of the nucleic acid sequence and the frequency of occurrence of subsets of that sequence within other non-identical sequences. By varying hybridization conditions from a level of stringency at which no hybridization occurs to a level at which hybridization is first observed, one of ordinary skill in the art can, without undue experimentation, determine conditions which will allow a given sequence to hybridize only with identical sequences.

Suitable ranges of such stringency conditions are described in Krause, M. H. and S. A. Aaronson, *Methods in Enzymology*, 200:546–556 (1991). Stringent hybridization conditions, depending upon the length and commonality of a sequence, may include hybridization conditions of 30° C.–60° C. and from 5× to 0.1×SSC. Highly stringent hybridization conditions may include hybridization at 45° C. and 0.1×SSC. Less than stringent hybridization conditions are employed to isolate nucleic acid sequences which are substantially similar, allelic or homologous to any given sequence.

Purified antibody—is an antibody which is at least 60%, by weight, free from the proteins and naturally-occurring organic molecules with which it is naturally associated. Preferably, the preparation is at least 75%, more preferably at least 90%, and most preferably at least 99%, by weight, antibody.

Specifically binds—means an antibody which recognizes and binds the protein of interest but which does not substantially recognize and bind other molecules in a sample, e.g., a biological sample, which naturally includes the protein of interest.

The present invention is concerned with the identification and sequencing of the mammalian ARMP or presenilin I gene in order to gain insight into the cause and etiology of Alzheimer's Disease, and to provide screening methods and therapies for the diagnosis and treatment of the disease can be developed. The gene has been identified, cDNA isolated and cloned, and its transcripts and gene products identified and sequenced. During such identification of the gene, considerable sequence information has also been developed on intron information in the PS1 gene, flanking untranslated information and signal information and information involving neighbouring genes in the AD3 chromosome region. Direct sequencing of overlapping RT-PCR products spanning the human gene isolated from affected members of large pedigrees linked to chromosome 14 has led to the discovery of missense mutations which co-segregate with the disease.

Although it is generally understood that Alzheimer's Disease is a neurological disorder, most likely in the brain, expression of PS1 has been found in a variety of human tissues such as heart, brain, placenta, lung, liver, skeletal muscle, kidney and pancreas. Although this gene is expressed widely, the clinically apparent phenotype exists in brain although it is conceivable that biochemical phenotypes may exist in these other tissues. As with other genetic diseases such as Huntington's Disease and APP—Alzheimer's, the clinical disease manifestation may reflect the different biochemistries of different cell types and tissues (which stem from genetics and the protein). Such findings suggest that AD may not be solely a neurological disorder but may also be a systemic disorder, hence requiring alternative therapeutic strategies which may be targeted to other tissues or organs or generally in addition or separately from neuronal or brain tissues.

The PS1 mutations identified have been related to Alzheimer's Disease pathology. With the identification and sequencing of the gene and the gene product, probes and antibodies raised to the gene product can be used in a variety of hybridization and immunological assays to screen for and detect the presence of either a normal or mutated gene or gene product.

Patient therapy through removal or blocking of the mutant gene product, as well as supplementation with the normal gene product by amplification, by genetic and recombinant techniques or by immunotherapy can now be achieved.

Correction or modification of the defective gene product by protein treatment immunotherapy (using antibodies to the defective protein) or knock-out of the mutated gene is now also possible. Familial Alzheimer's Disease could also be controlled by gene therapy in which the gene defect is corrected in situ or by the use of recombinant or other vehicles to deliver a DNA sequence capable of expressing the normal gene product, or a deliberately mutated version of the gene product whose effect counterbalances the deleterious consequences of the disease mutation to the affected cells of the patient.

The present invention is also concerned with the identification and sequencing of a second human gene, the PS2 or presenilin II gene on chromosome 1, which is associated with Alzheimer's Disease.

Disease mechanism insights and therapies analogous to those described above in relation to the PS1 gene also are nonavailable as a result of the identification and isolation of the PS2 gene.

A homologue of the human presenilin I gene, mPS1, has been identified in mice and has been cloned and sequenced. Additionally, a homologue of the human presenilin genes, DmPS1, has been identified in *D. melanogaster* and its sequence determined.

The remainder of the "Description of the Preferred Embodiments" is organized as follows.

1. Isolation of the Human PS1 (ARMP) Gene
 - a. Genetic mapping of the AD3 locus
 - b. Construction of a physical contig spanning the AD3 Region
 - c. Transcription mapping and preliminary analysis of candidate genes
 - d. Recovery of potential candidate genes
2. Characterization of the Human PS1 (ARMP) Gene
3. Identification of an alternate splice form of the PS1 (ARMP) gene product
4. Functional Domains of PS1 Protein
5. PS1 (ARMP) Protein
6. Mutations in the S182 (PS1) transcript
7. Isolation and Purification of PS1 (ARMP) Protein
8. Expression of PS1 (ARMP)
9. Antibodies to PS1 (ARMP)
10. Isolation of the Murine PS1 Gene
11. Transgenic Mouse Model of Alzheimer's Disease
12. Isolation of the Human PS2 (E5-1) Gene—A Homologue of the PS1 Gene
13. Mutations of the PS2 (E5-1) Gene associated with Alzheimer's Disease
14. PS2 (E5-1) Protein
15. Isolation and Purification of PS2 (ARMP) Protein
16. Antibodies to PS2 (E5-1)
17. Transgenic Mouse Model of PS2 (E5-1)-related Alzheimer's Disease
18. Functional Domains of Presenilins
19. Isolation of Presenilin Binding Proteins
 - a. direct extraction by affinity chromatography using GST-fusion proteins and synthetic peptides
 - b. co-isolation of presenilins and bound proteins by immunoprecipitation
 - c. Biomolecular Interaction Assay (BIAcore) utilizing a GST-fusion capture system
 - d. Two-Hybrid yeast systems
20. Identification of Small Molecules with Presenilin Binding Capacity
21. Assays for Identifying Drugs Which Affect Presenilin Expression

22. Identification of a homologue of the ARMP (PS1) gene in *C. elegans*
 23. Identification of a homologue of the PS1 (ARMP) gene in *D. melanogaster*
 24. Screening for and Diagnosis of Alzheimer's Disease
 - a. General diagnostic Methods
 - b. Screening for Alzheimer's Disease Linked to Chromosome 14
 - c. Screening for Alzheimer's Disease Linked to Chromosome 1
 25. Therapies
 - a. Rationale for Therapeutic, Diagnostic, and Investigational Applications of the PS1 and PS2 Genes and Gene Products as they Relate to the Amyloid Precursor Protein
 - b. Rationale for Therapeutic, Diagnostic, and Investigational Applications of the PS1 and PS2 Genes and the Products Thereof
 - c. Protein Therapy
 - d. Gene Therapy
 26. Examples
 - a. Example 1: Development of the genetic, physical, "contig" and transcriptional map of the minimal co-segregating region
 - b. Example 2: Cumulative two point lod scores for chromosome 14q24.3 markers
 - c. Example 3: Haplotypes between flanking markers segregated with AD3 in FAD pedigrees
 - d. Example 4: Recovery of transcribed sequences from the AD3 interval
 - e. Example 5: Locating mutations in the ARMP (PS1) gene using restriction enzymes
 - f. Example 6: Locating mutations in the ARMP (PS1) gene using allele specific oligonucleotides
 - g. Example 7: Northern hybridization demonstrating the expression of ARMP (PS1) mRNA in a variety of tissues
 - h. Example 8: Eukaryotic and prokaryotic expression vector systems
 - i. Example 9: Locating additional mutations in the ARMP (PS1) gene
 - j. Example 10: Antibody production
 - k. Example 11: Identification of mutations in the (PS2) E5-1 gene
 - l. Example 12: Transgenic Mice
 - m. Example 13: Expression of Recombinant PS1 and PS2 in Eukaryotic Cells
 - n. Example 14: Isolation of Presenilin Binding Proteins by Affinity Chromatography
 - o. Example 15: Isolation of Presenilin Binding Proteins by Two-Hybrid Yeast System
 - p. Example 16: Transgenic *C. elegans*
 - q. Example 17: Cloning of a *Drosophila melanogaster* homologue, DmPS, for the Human Presenilin Genes
- Isolation of the Human PS1 (ARMP) Gene
Genetic Mapping of the AD3 Locus.

After the initial regional mapping of the AD3 gene locus to 14q24.3 near the anonymous microsatellite markers D14S43 and D14S53 (Schellenberg, GD et al., 1992; St George-Hyslop, P et al., 1992; Van Broeckhoven, C et al., 1992), twenty one pedigrees were used to segregate AD as a putative autosomal dominant trait (St George-Hyslop, P et al., 1992) and to investigate the segregation of 18 additional

genetic markers from the 14q24.3 region which had been organized into a high density genetic linkage map (FIG. 1B) (Weissenbach et al., 1992; Gyapay et al., 1994). Pairwise maximum likelihood analyses previously published confirmed substantial cumulative evidence for linkage between familial Alzheimer's Disease (FAD) and all of these markers (Table 1). However, much of the genetic data supporting linkage to these markers were derived from six large early onset pedigrees, FAD1 (Nee et al., 1983), FAD2 (Frommelt et al., 1991), FAD3 (Goudsmit et al., 1981; Pollen, 1993), FAD4 (Foncin et al., 1985), TOR1.1 (Bergamini, 1991) and 603 (Pericak-Vance et al., 1988) each of which provides at least one anonymous genetic marker from 14q24.3 (St. George-Hyslop, P. et al 1992).

In order to define more precisely the location of the AD3 gene relative to the known locations of the genetic markers from 14q24.3, recombinational landmarks were sought by direct inspection of the raw haplotype data from those genotyped affected members of the six pedigrees showing definitive linkage to chromosome 14. This selective strategy in this particular instance necessarily discards data from the reconstructed genotypes of deceased affected members as well as from elderly asymptomatic members of the large pedigrees, and takes no account of the smaller pedigrees of uncertain linkage status. However, this strategy is very sound because it also avoids the acquisition of potentially misleading genotype data acquired either through errors in the reconstructed genotypes of deceased affected members arising from non-paternity or sampling errors or from the inclusion of unlinked pedigrees.

Upon inspection of the haplotype data for affected subjects, members of the six large pedigrees whose genotypes were directly determined revealed obligate recombinants at D14S48 and D14S53, and at D14S258 and D14S63. The single recombinant at D14S53, which depicts a telomeric boundary for the FAD region, occurred in the same AD affected subject of the FAD1 pedigree who had previously been found to be recombinant at several other markers located telomeric to D14S53 including D14S48 (St George-Hyslop, P et al., 1992). Conversely, the single recombinant at D14S258, which marks a centromeric boundary of the FAD region, occurred in an affected member of the FAD3 pedigree who was also recombinant at several other markers centromeric to D14S258 including D14S63. Both recombinant subjects had unequivocal evidence of Alzheimer's Disease confirmed through standard clinical tests for the illness in other affected members of their families, and the genotype of both recombinant subjects was informative and co-segregating at multiple loci within the interval centromeric to D14S53 and telomeric to D14S258.

When the haplotype analyses were enlarged to include the reconstructed genotypes of deceased affected members of the six large pedigrees as well as data from the remaining fifteen pedigrees with probabilities for linkage of less than 0.95, several additional recombinants were detected at one or more marker loci within the interval between D14S53 and D14S258. Thus, one additional recombinant was detected in the reconstructed genotype of a deceased affected member of each of three of the larger FAD pedigrees (FAD 1, FAD2 and other related families), and eight additional recombinants were detected in affected members of five smaller FAD pedigrees. However, while some of these recombinants might have correctly placed the AD3 gene within a more defined target region, it was necessary to regard these potentially closer "internal recombinants" as unreliable not only for the reasons discussed earlier, but also because they provided mutually inconsistent locations for the AD3 gene within the D14S53-D14S258 interval.

Construction of a Physical Contig Spanning the AD3 Region.

As an initial step towards cloning the AD3 gene, a contig of overlapping genomic DNA fragments cloned into yeast artificial chromosome vectors, phage artificial chromosome vectors and cosmid vectors was constructed (FIG. 1B). FISH mapping studies using cosmids derived from the YAC clones 932c7 and 964f5 suggested that the interval most likely to carry the AD3 gene was at least five megabases in size. Because the large size of this minimal co-segregating region would make positional cloning strategies intractable, additional genetic pointers were sought which focused the search for the AD3 gene to one or more subregions within the interval flanked by D14S53 and D14S258. Haplotype analyses at the markers between D14S53 and D14S258 failed to detect statistically significant evidence for linkage disequilibrium and/or allelic association between the FAD trait and alleles at any of these markers, irrespective of whether the analyses were restricted to those pedigrees with early onset forms of FAD, or were generalized to include all pedigrees. This result was not unexpected given the diverse ethnic origins of our pedigrees. However, when pedigrees of similar ethnic descent were collated, direct inspection of the haplotypes observed on the disease-bearing chromosome segregating in different pedigrees of similar ethnic origin revealed two clusters of marker loci (Table 2). The first of these clusters located centromeric to D14S77 (D14S786, D14S277 and D14S268) and spanned the 0.95 Mb physical interval contained in YAC 78842 (depicted as region B in FIG. 1C). The second cluster was located telomeric to D14S77 (D14S43, D14S273, and D14S76) and spanned the ~1 Mb physical interval included within the overlapping YAC clones 964c2, 74163, 797d11 and part of 854f5 (depicted as region A in FIG. 1C). Identical alleles were observed in at least two pedigrees from the same ethnic origin (Table 2). As part the strategy, it was reasoned that the presence of shared alleles at one of these groups of physically clustered marker loci might reflect the co-inheritance of a small physical region surrounding the PS1 gene on the original founder chromosome in each ethnic population. Significantly, each of the shared extended haplotypes were rare in normal Caucasian populations and allele sharing was not observed at other groups of markers spanning similar genetic intervals elsewhere on chromosome 14q24.3.

Transcription Mapping and Preliminary Analysis of Candidate Genes

To isolate expressed sequences encoded within both critical intervals, a direct selection strategy was used involving immobilized, cloned, human genomic DNA as the hybridization target to recover transcribed sequences from primary complementary DNA pools derived from human brain mRNA (Rommens et al., 1993). Approximately 900 putative cDNA fragments of size 100 to 600 base pairs were recovered from regions A and B in FIG. 1C. These fragments were hybridized to Southern blots containing genomic DNAs from each of the overlapping YAC clones and genomic DNAs from humans and other mammals. This identified a subset of 151 clones which showed evidence for evolutionary conservation and/or for a complex structure which suggested that they were derived from spliced mRNA. The clones within this subset were collated on the basis of physical map location, cross-hybridization and nucleotide sequence, and were used to screen conventional human brain cDNA libraries for longer cDNAs. At least 19 independent cDNA clones over 1 kb in length were isolated and then aligned into a partial transcription map of the AD3 region (FIG. 1D). Only three of these transcripts corre-

sponded to known characterized genes (cFOS, dihydroli-poamide succinyl transferase and latent transforming growth factor binding protein 2).

Recovery of Potential Candidate Genes

Each of the open reading frame portions of the candidate genes were recovered by RT-PCR from mRNA isolated from post-mortem brain tissue of normal control subjects and from either post-mortem brain tissue or cultured fibroblast cell lines of affected members of six pedigrees definitively linked to chromosome 14. The RT-PCR products were then screened for mutations using chemical cleavage and restriction endonuclease fingerprinting single-strand sequence conformational polymorphism methods (Saleeba and Cotton, 1993; Liu and Sommer, 1995), and by direct nucleotide sequencing. With one exception, all of the genes examined, although of interest, were not unique to affected subjects, and did not co-segregate with the disease. The single exception was the candidate gene represented by clone S182 which contained a series of nucleotide changes not observed in normal subjects, but which altered the predicted amino acid sequence in affected subjects. Although nucleotide sequence differences were also observed in some of the other genes, most were in the 3' untranslated regions and none were unique to AD-affected subjects.

The remaining sequences, a subset of which are mapped in FIG. 1B, together with additional putative transcriptional sequences not identified in FIG. 1C, are identified in the sequence listings as Nos. 14 to 43. The sequences identified by SEQ ID NOs:14 to 43 represent neighbouring genes or fragments of neighbouring genes adjacent to the hPS1 gene or possibly additional coding fragments arising from alternative splicing of the hPS1. Sequences identified by SEQ ID NOs: 44–126 and 150–160 represent neighboring genomic fragments containing both exon and intron information. Such sequences are useful for creating primers, for creating diagnostic tests, creating altered regulatory sequences and use of adjacent genomic sequences to create better animal models.

Characterization of the Human PS1 (ARMP) Gene

Hybridization of the S 182 clone to northern blots identified a transcript expressed widely in many areas of brain and peripheral tissues as a major 3.0 kb transcript and a minor transcript of 7.0 kb. Although the identity of the ~7.0 kb transcript is unclear, two observations suggest that the ~3.0 kb transcript represents an active product of the gene. Hybridization of the S 182 clone to northern blots containing mRNA from a variety of murine tissues, including brain, identifies only a single transcript identical in size to the ~3.0 kb human transcript. All of the longer cDNA clones recovered to date (2.6–2.8 kb), which include both 5' and 3' UTRs and which account for the ~3.0 kb band on the northern blot, have mapped exclusively to the same physical region of chromosome 14. From these experiments the ~7.0 kb transcript could represent either a rare alternately spliced or polyadenylated isoform of the ~3.0 kb transcript or could represent another gene with homology to S 182.

The nucleotide sequence of the major transcript was determined from the consensus of eleven independent longer cDNA clones and from 3 independent clones recovered by standard 5' rapid amplification of cDNA ends and bears no significant homology to other human genes. The cDNA of the sequenced transcript is provided in SEQ ID NO:1 and the predicted amino acid sequence is provided in SEQ ID NO:2. The cDNA sequence of another sequenced human clone is also provided as SEQ ID NO:133 and its predicted amino acid sequence is provided in SEQ ID NO:134.

Analysis of the 5' end of multiple cDNA clones and RT-PCR products as well as corresponding genomic clones indicates that the 5' UTR is contained within at least two exons and that transcription either begins from two different start sites and/or that one of the early 5' untranslated exons is alternatively spliced (Table 6). The longest predicted open reading frame contains 467 amino acids with a small alternatively spliced exon of 4 amino acids at 25 codons from the putative start codon (Table 3). This putative start codon is the first in phase ATG located 63 bp downstream of a TGA stop codon and lacks a classical Kozak consensus sequences around the first two in-phase ATG sequences (Sherrington, 1995). Like other genes lacking classical 'strong' start codons, the putative 5' UTR of the human transcripts is rich in GC.

Further investigation of the PS1 gene has revealed a host of sequence fragments which form the PS1 gene and include intron sequence information, 5' end untranslated sequence information and 3' end untranslated sequence information (Table 6). Such sequence fragments are identified as SEQ ID NOs:6 to 13.

The DNA sequence of the PS1 gene as cloned has been incorporated into a plasmid Bluescript. This stable vector has been deposited at ATCC, Rockville, Md., under ATCC accession number 97124 on Apr. 28, 1995.

Identification of an Alternate Splice Form of the PS1 (ARMP) Gene Product

During sequencing studies of RT-PCR products for the PS1 gene recovered from a variety of tissues, it was discovered that some peripheral tissues (principally white blood cells) demonstrated two alternative splice forms of the PS1 gene. One form is identical to the (putatively 467 amino acid) isoform constitutively expressed in all brain regions. The alternative splice form results from the exclusion of the segment of the cDNA comprising base pairs 1018 to 1116, and results in a truncated isoform of the PS1 protein wherein the hydrophobic part of the hydrophilic acidically-charged loop immediately C-terminal to TM6 is removed. This alternatively spliced isoform therefore is characterized by preservation of the sequence N-terminal to and including the tyrosine at position 256, changing of the aspartate at 257 to alanine, and splicing on to the C-terminal part of the protein from and including tyrosine 291. Such splicing differences are often associated with important functional domains of the proteins. This argues that this hydrophilic loop (and consequently the N-terminal hydrophilic loop with similar amino acid charge) is/are active functional domains of the PS1 product and thus sites for therapeutic targeting.

Functional Domains of the PS1 (ARMP) Protein

With respect to DNA SEQ ID NO:1 and DNA SEQ ID NO:133, analysis of the sequence of overlapping cDNA clones predicted an ORF protein of 467 amino acids when read from the first in phase ATG start codon, and a molecular mass of approximately 52.6 kDa. The molecular weight of the protein can vary due to possible substitutions, insertions or deletions of amino acids or due either to polymorphisms in the protein or alternate splicing of the transcript.

Analysis of the predicted amino acid sequence using the Hopp and Woods algorithm suggested that the PS1 protein product is a multispinning integral membrane protein such as a receptor, a channel protein, or a structural membrane protein. The absence of recognizable signal peptide and the paucity of glycosylation sites are noteworthy, and the hydrophobicity profile suggests that the protein is less likely to be a soluble protein with a highly compact three-dimensional structure.

The protein may be a cellular protein with a highly compact three dimensional structure in which respect it may

be similar to APOE which is also related to Alzheimer's Disease. As mutations in this protein are associated with early onset (presenile) Alzheimer's Disease, the protein has been designated presenilin I (PS1).

The protein also contains a number of potential phosphorylation sites, one of which is the consensus site for MAP-kinase which is also involved in the hyperphosphorylation of tau during the conversion of normal tau to neurofibrillary tangles. This consensus sequence may provide a putative common pathway linking this protein and other known biochemical aspects of Alzheimer's Disease and would represent a likely therapeutic target. Review of the protein structure reveals two sequences YTPF (residues 115-119) and STPE (residues 353-356) which represent the 5/T-P motif which is the MAP kinase consensus sequence. Several other phosphorylation sites exist with consensus sequences for Protein Kinase C (PKC) activity. Because PKC activity is associated with differences in the metabolism of APP which are relevant to Alzheimer's Disease, these sites on the PS1 protein and homologues are sites for therapeutic targeting.

The N-terminal is characterized by a highly hydrophilic acidic charged domain with several potential phosphorylation domains, followed sequentially by a hydrophobic membrane spanning domain of 19 residues, a charged hydrophilic loop, five additional hydrophobic membrane spanning domains interspersed with short (5-20 residue) hydrophilic domains, an additional larger acidic hydrophilic charged loop and at least one, and possibly two, other hydrophobic potentially membrane-spanning domains, culminating in a polar domain at the C-terminus (Table 4 and FIG. 3B). The presence of seven membrane spanning domains is characteristic of several classes of G-coupled receptor proteins but is also observed with other proteins including channel proteins.

PS1 (ARMP) Protein

The PS1 (ARMP) protein is a member of a novel class of transmembrane proteins which share substantial amino acid homology. The homology is sufficient that certain nucleotide probes and antibodies raised against one can identify other members of this gene family. The major differences between members of this family reside in the amino acid and nucleotide sequence homologous to the hydrophilic acid loop domain between putative transmembrane 6 and transmembrane 7 domains of the PS1 gene and gene product. This region is alternatively spliced in some non-neural tissues, and is also the site of several pathogenic disease-causing mutations in the PS1 gene. The variable splicing of this hydrophilic loop, the presence of a high density of pathogenic mutations within this loop, and the fact that the amino acid sequences of the loop differs between members of the gene family suggest that this loop is an important functional domain of the protein and may confer some specificity to the physiologic and pathogenic interactions which the PS1 gene product undergoes. Because the N-terminal hydrophilic domain shares the same acidic charge as the hydrophilic acid loop domain between TM6 and TM7, and has the same orientation with respect to the membrane, it is very likely that these two domains share functionality either in a coordinated (together) or independent fashion (e.g. different ligands or functional properties). As a result everything said about the hydrophilic loop applies also to the N-terminal hydrophilic domain.

Knowledge of the specificity of the loop can be used to identify ligands and functional properties of the PS1 gene product (e.g. sites of interactions with APP, cytosolic proteins such as kinases, Tau, and MAP, etc.).

Comparison of the nucleic acid and predicted amino acid sequences of PS1 with available databases using the BLAST alignment paradigms revealed modest amino acid similarity with the *C. elegans* sperm integral membrane protein SPE-4 ($p=1.5 \times 10^{-25}$, 24–37% identity over three groups of at least fifty residues) and weaker similarity to portions of several other membrane spanning proteins including mammalian chromogranin A and the alpha subunit of mammalian voltage dependent calcium channels (Altschul et al., 1990). This clearly established that they are not the same gene. The amino-acid sequence similarities across putative transmembrane domains may occasionally yield alignment that simply arises from the limited number of hydrophobic amino acids, but there is also extended sequence alignment between S182 protein and SPE-4 at several hydrophilic domains. Both the putative PS1 protein and SPE-4 are predicted to be of comparable size (467 and 465 residues, respectively) and to contain at least seven transmembrane domains with a large acidic domain preceding the final predicted transmembrane domain. The PS1 protein does have a longer predicted hydrophilic region at the N terminus.

The similarity between the putative products of the SPE-4 and PS1 genes implies that they may have similar activities. The SPE-4 protein of *C. elegans* appears to be involved in the formation and stabilization of the fibrous body-membrane organelle (FBMO) complex during spermatogenesis. The FBMO is a specialized Golgi-derived organelle, consisting of a membrane bound vesicle attached to and partly surrounding a complex of parallel protein fibers and may be involved in the transport and storage of soluble and membrane-bound polypeptides. Mutations in SPE-4 disrupt the FBMO complexes and arrest spermatogenesis. Therefore the physiologic function of SPE-4 may be either to stabilize interactions between integral membrane budding and fusion events, or to stabilize interactions between the membrane and fibrillary proteins during the intracellular transport of the FBMO complex during spermatogenesis. Comparable functions could be envisaged for PS1. The PS1 could be involved either in the docking of other membrane-bound proteins such as β APP, or the axonal transport and fusion budding of membrane-bound vesicles during protein transport such as in the Golgi apparatus or endosome-lysosome system. If correct, then mutations might be expected to result in aberrant transport and processing of β APP and/or abnormal interactions with cytoskeletal proteins such as the microtubule-associated protein Tau. Abnormalities in the intracellular and in the extracellular disposition of both β APP and Tau are in fact an integral part of the neuropathologic features of Alzheimer's Disease. Although the location of the PS1 mutations in highly conserved residues within conserved domains of the putative proteins suggests that they are pathogenic, at least three of these mutations are conservative which is commensurate with the onset of disease in adult life. Because none of the mutations observed so far are deletions or nonsense mutations that would be expected to cause a loss of function, we cannot predict whether these mutations will have a dominant gain-of-function effect and promote aberrant processing of β APP or a dominant loss-of-function effect causing arrest of normal β APP processing.

An alternate possibility is that the ARMP gene product may represent a receptor or channel protein. Mutations of such proteins have been causally related to several other dominant neurological disorders in both vertebrate (e.g., malignant hyperthermia, hyperkalemic periodic paralysis in humans) and in invertebrate organisms (deg-1(d) mutants in *C. elegans*). Although the pathology of these other disorders

does not resemble that of Alzheimer's Disease there is evidence for functional abnormalities in ion channels in Alzheimer's Disease. For example, anomalies have been reported in the tetra-ethylammonium-sensitive 113pS potassium channel and in calcium homeostasis. Perturbations in transmembrane calcium fluxes might be especially relevant in view of the weak homology between PS1 and the α -ID subunit of voltage-dependent calcium channels and the observation that increases in intracellular calcium in cultured cells can replicate some of the biochemical features of Alzheimer's Disease such as alteration in the phosphorylation of Tau-microtubule-associated protein and increased production of A β peptides.

The normal PS1 protein, substantially free of other proteins, is encoded by the aforementioned SEQ. ID No:1 and SEQ ID NO:133. As will be later discussed, PS1 protein and fragments thereof may be made by a variety of methods. Purified mutant PS1 protein is characterized by FAD—associated phenotype (necrotic death, apoptotic death, granulovascular degeneration, neurofibrillary degeneration, abnormalities or changes in the metabolism of APP, Ca^{2+} , K^+ , and glucose, mitochondrial function and energy metabolism neurotransmitter metabolism, all of which have been found to be abnormal in human brain, and/or peripheral tissue cells in subjects with Alzheimer's Disease) in a variety of cells. The mutant PS1, free of other proteins, is encoded by the mutant DNA sequence.

Mutations in the S182 (PSI) transcript

Several mutations in the ARMP gene have been identified which cause a severe type of familial Alzheimer's Disease. One or a combination of these mutations may be responsible for this form of Alzheimer's Disease as well as several other neurological disorders. The mutations may be any form of nucleotide sequence alteration or substitution. Specific disease causing mutations in the form of nucleotide and/or amino acid substitutions have been located, although it is anticipated that additional mutations will be found in other families.

Direct sequencing of overlapping RT-PCR products spanning the 3.0 kb S182 transcript isolated from affected members of the six large pedigrees linked to chromosome 14 led to the discovery of eight missense mutations in each of the six pedigrees (Table 7, FIG. 2). Each of these mutations co-segregated with the disease in the respective pedigrees, and were absent from upwards of 142 unrelated neurologically normal subjects drawn from the same ethnic origins as the FAD pedigrees (284 unrelated chromosomes).

The location of the gene within the physical interval segregating with AD3 trait, the presence of eight different missense mutations which co-segregate with the disease trait in six pedigrees definitively linked to chromosome 14, and the absence of these mutations in 284 independent normal chromosomes cumulatively confirms that the PS1 gene is the AD3 locus. Further biologic support for this hypothesis arises both from the fact that the residues mutated in FAD kindreds are conserved in evolution (Table 3) and occur in domains of the protein which are also highly conserved, and from the fact that the PS1 gene product is expressed at high levels in most regions of the brain including those most severely affected by AD.

Each of the observed nucleotide substitutions occurred within the putative ORF of the PS1 transcript, and would be predicted to change the encoded amino acid at the following positions, numbering from the first putative initiation codon. The mutations are listed both with reference to their nucleotide locations in SEQ ID NO:1 and SEQ ID NO:133 (an additional human clone) and to their amino acid locations in

SEQ ID NO:2 and SEQ ID NO:134 (the additional human clone).

| | | |
|-------|-----------|-------------|
| i) | 685, A→C | Met 146 Leu |
| ii) | 737, A→G | His 163 Arg |
| iii) | 986, C→A | Ala 246 Glu |
| iv) | 1105, C→G | Leu 286 Val |
| v) | 1478, G→A | Cys 410 Tyr |
| vi) | 1027, C→T | Ala 260 Val |
| vii) | 1102, C→T | Ala 285 Val |
| viii) | 1422, C→G | Leu 392 Val |

A further missense mutation was found in presenilin I:
Leu 171 Pro

The Met146Leu, Ala246Glu and Cys410Tyr mutations have not been detected in the genomic DNA of affected members of the eight remaining small early onset autosomal dominant FAD pedigrees or six additional families in our collection which express late FAD onset. We predict that such mutations would not commonly occur in late onset FAD which has been excluded by genetic linkage studies from the more aggressive form of AD linked to chromosome 14q24.3 (St George-Hyslop, P et al., 1992; Schellenberg et al., 1993). The His163Arg mutation has been found in the genomic DNA of affected members of one additional FAD pedigree for which positive but significant statistical evidence for linkage to 14 becomes established. Age of onset of affected members was consistent with affected individuals from families linked to chromosome 14.

Mutations Ala260Val, Ala285Val, and Leu392Val all occur within the acidic hydrophilic loop between putative transmembrane domain 6 (TM6) and transmembrane domain 7 (TM7) (FIG. 3). Two of these mutations (A260V; A285V) and the L286V mutation are also located in the alternate splice domain.

All nine mutations can be assayed by a variety of strategies (direct nucleotide sequencing, allele specific oligos, ligation polymerase chain reaction, SSCP, RFLPs etc.) using RT-PCR products representing the mature mRNA/cDNA sequence or genomic DNA.

Of all the nucleotide substitutions co-segregating with the disease in their respective pedigrees, none were seen in asymptomatic family members aged more than two standard deviations beyond the mean age of onset, and none were present on 284 chromosomes from unrelated neurologically normal subjects drawn from comparable ethnic origins

Table 9 shows the above-noted PS1 mutations and other published mutations of this gene.

Isolation and Purification of PS1 (ARMP) Protein

The PS1 protein may be isolated and purified by methods selected on the basis of properties revealed by its sequence. Since the protein possesses properties of a membrane-spanning protein, a membrane fraction of cells in which the protein is highly expressed (e.g. central nervous system cells or cells from other tissues) is isolated and the proteins extracted by detergent solubilization.

Purification can be achieved using protein purification procedures such as chromatography methods (gel-filtration, ion-exchange and immunoaffinity), by high-performance liquid chromatography (RP-HPLC, ion-exchange HPLC, size-exclusion HPLC, high-performance chromatofocusing and hydrophobic interaction chromatography) or by precipitation (immunoprecipitation). Polyacrylamide gel electrophoresis can also be used to isolate the PS1 protein based on its molecular weight, charge properties and hydrophobicity.

Similar procedures to those just mentioned could be used to purify the protein from cells transfected with vectors containing the PS1 gene (e.g. baculovirus systems, yeast expression systems, eukaryotic expression systems).

Purified protein can be used in further biochemical analyses to establish secondary and tertiary structure which may aid in the design of pharmaceuticals to interact with the protein, alter protein charge configuration or charge interaction with other proteins, lipid or saccharide moieties, alter its function in membranes as a transporter channel or receptor and/or in cells as an enzyme or structural protein and treat the disease.

The protein can also be purified by creating a fusion protein by ligating the PS1 cDNA sequence to a vector which contains a sequence for another peptide (e.g. GST—glutathione succinyl transferase). The fusion protein is expressed and recovered from prokaryotic (e.g. bacterial or baculovirus) or eukaryotic cells. The fusion protein can then be purified by affinity chromatography based upon the fusion vector sequence. The PS1 protein can then be further purified from the fusion protein by enzymatic cleavage of the fusion protein.

Expression of PS1 (ARMP)

As an embodiment of the present invention, PS1 protein may be expressed using eukaryotic and prokaryotic expression systems. Eukaryotic expression systems can be used for many studies of the PS1 gene and gene product including determination of proper expression and post-translational modifications for full biological activity, identifying regulatory elements located in the 5' region of the PS1 gene and their role in tissue regulation of protein expression, and production of large amounts of the normal and mutant protein for isolation and purification. Cells expressing the PS1 protein may be used as a functional assay system for antibodies generated against the protein or to test effectiveness of pharmacological agents. Expressed and purified PS1 protein may be used to examine its role as a component of a signal transduction system and to study the function of the normal complete protein, specific portions of the protein, or of naturally occurring and artificially produced mutant proteins.

Prokaryotic expression systems allow the holo-protein, or various important functional domains of the protein, to be recovered as fusion proteins and used for binding studies, structural studies, functional studies, and for the generation of appropriate antibodies.

Expression of the PS1 gene in heterologous cell systems can be used to demonstrate structure-function relationships. Ligating the PS1 DNA sequence into a plasmid expression vector to transfect cells is a useful method to test the influence of PS1 on various cellular biochemical parameters. Plasmid expression vectors containing either the entire normal or mutant human or mouse PS1 sequence or portions thereof, can be used in in vitro mutagenesis experiments which will identify portions of the protein crucial for regulatory function.

The DNA sequence can be manipulated in studies to understand the expression of the gene and its product, to achieve production of large quantities of the protein for functional analysis, for antibody production, and for patient therapy. Changes in the sequence may or may not alter the expression pattern in terms of relative quantities, tissue-specificity and functional properties. Partial or full-length DNA sequences which encode for the PS1 protein, modified or unmodified, may be ligated to bacterial expression vectors. *E. coli* can be used with a variety of expression vector systems, e.g. the T7 RNA polymerase/promoter system using two plasmids or by labelling of plasmid-encoded proteins, or by expression by infection with M13 Phage mGPI-2. *E. coli* vectors can also be used with Phage lambda regulatory sequences, by fusion protein vectors (e.g. lacZ

and *trpE*), by maltose-binding protein fusions, and by glutathione-S-transferase fusion proteins, etc., all of which, together with many other prokaryotic expression systems, are widely available commercially.

Alternatively, the PS1 protein can be expressed in insect cells using baculoviral vectors, or in mammalian cells using vaccinia virus or specialised eukaryotic expression vectors. For expression in mammalian cells, the cDNA sequence may be ligated to heterologous promoters, such as the simian virus (SV40) promoter in the pSV2 vector or other similar vectors and introduced into cultured eukaryotic cells such as COS cells to achieve transient or long-term expression. The stable integration of the chimeric gene construct may be maintained in mammalian cells by biochemical selection, such as neomycin and mycophenolic acid.

The PS1 DNA sequence can be altered using procedures such as restriction enzyme digestion, fill-in with DNA polymerase, deletion by exonuclease, extension by terminal deoxynucleotide transferase, ligation of synthetic or cloned DNA sequences and site-directed sequence alteration with the use of specific oligonucleotides together with PCR.

The cDNA sequence or portions thereof, or a mini gene consisting of a cDNA with an intron and its own promoter, is introduced into eukaryotic expression vectors by conventional techniques. These vectors permit the transcription of the cDNA in eukaryotic cells by providing regulatory sequences that initiate and enhance the transcription of the cDNA and ensure its proper splicing and polyadenylation. The endogenous PS1 gene promoter can also be used. Different promoters within vectors have different activities which alters the level of expression of the cDNA. In addition, certain promoters can also modulate function such as the glucocorticoid-responsive promoter from the mouse mammary tumor virus.

Some of the vectors listed contain selectable markers or neo bacterial genes that permit isolation of cells by chemical selection. Stable long-term vectors can be maintained in cells as episomal, freely replicating entities by using regulatory elements of viruses. Cell lines can also be produced which have integrated the vector into the genomic DNA. In this manner, the gene product is produced on a continuous basis.

Vectors are introduced into recipient cells by various methods including calcium phosphate, strontium phosphate, electroporation, lipofection, DEAE dextran, microinjection, or by protoplast fusion. Alternatively, the cDNA can be introduced by infection using viral vectors.

Using the techniques mentioned, the expression vectors containing the PS1 gene or portions thereof can be introduced into a variety of mammalian cells from other species or into non-mammalian cells as described in Example 8.

The recombinant expression vector, according to this invention, comprises the selected DNA of the DNA sequences of this invention for expression in a suitable host. The DNA is operatively joined in the vector to an expression control sequence in the recombinant DNA molecule so that normal or mutant PS1 protein can be expressed. The expression control sequence may be selected from the group consisting of sequences that control the expression of genes of prokaryotic or eukaryotic cells and their viruses and combinations thereof. The expression control sequence may be selected from the group consisting of the lac system, the *trp* system, the *tac* system, the *trc* system, major operator and promoter regions of phage lambda, the control region of the fd coat protein, early and late promoters of SV40, promoters derived from polyoma, adenovirus, retrovirus, baculovirus, simian virus, 3-phosphoglycerate kinase promoter, yeast

acid phosphatase promoters, yeast alpha-mating factors and combinations thereof.

The host cells to be transfected with the vectors of this invention may be from a host selected from the group consisting of *E. coli*, *Pseudomonas*, *Bacillus subtilis*, *Bacillus stearothermophilus*, or other bacilli, other bacteria, yeasts, fungi, insects, mice or other animals or plant hosts or may be human tissue cells.

For the mutant PS1 DNA sequence, similar systems are employed to express and produce the mutant protein.

Antibodies to PS1 (ARMP)

Antibodies to epitopes within the PS1 protein can be raised to provide information on the characteristics of the proteins. Generation of antibodies enables the visualization of the protein in cells and tissues using Western blotting. In this technique, proteins are separated by polyacrylamide gel electrophoresis and transferred to nitrocellulose membranes. These membranes are then incubated in the presence of a primary antibody, washed and incubated with a secondary antibody to detect the protein-primary antibody complex. Following repeated washing, the entire complex is visualized using colourimetric or chemiluminescent methods.

Antibodies to the PS1 protein also allow for the use of immunocytochemistry and immunofluorescence techniques in which the proteins can be visualized directly in cells and tissues. This is most helpful in order to establish the sub-cellular location of the protein and the tissue specificity of the protein.

In order to prepare polyclonal antibodies, fusion proteins containing defined portions or all of the PS1 protein may be synthesized in bacteria by expression of corresponding DNA sequences in a suitable cloning vehicle, as described herein. The protein is then purified, coupled to a carrier protein, mixed with Freund's adjuvant (to help stimulate the antigenic response) and injected into rabbits or other suitable animals. Alternatively, protein can be isolated from cultured cells expressing the protein. Following booster injections at bi-weekly intervals, the rabbits or other suitable animals are bled and the sera isolated. Sera are used directly or purified prior to use, by various methods including affinity chromatography, Protein A-Sepharose, Antigen Sepharose, Anti-mouse-Ig-Sepharose. Sera or purified antibodies are used to probe protein extracts run on a polyacrylamide gel to identify the PS1 protein. Alternatively, antibodies may be obtained by making synthetic peptides corresponding to antigenic portions of the PS1 protein and injecting these into rabbits or other suitable animals.

To produce monoclonal PS1 antibodies, cells actively expressing the protein are cultured or isolated from tissues and the cell membranes isolated. The membranes, extracts, or recombinant protein extracts containing the PS1 protein are injected in Freund's adjuvant into mice. After receiving 9 injections over a three week period, the mice are sacrificed and their spleens are removed and resuspended in phosphate buffered saline (PBS). The spleen cells serve as a source of lymphocytes, some of which are producing antibody of the appropriate specificity. These cells are then fused with a permanently growing myeloma partner cell, and the products of the fusion are plated into a number of tissue culture wells in the presence of a selective agent such as HAT. The wells are screened by ELISA to identify those containing cells making useful antibody and these cells are freshly plated. After a period of growth, these cells are again screened to identify antibody-producing cells. Several cloning procedures are carried out until over 90% of the wells contain single clones which are positive for antibody production. By this procedure, a stable line of monoclonal

antibody-producing clones is established. Monoclonal antibody produced by such clones is purified by methods such as affinity chromatography using Protein A Sepharose or ion-exchange chromatography or by variations and combinations of these techniques.

Antibodies may also be used coupled to other compounds or materials for diagnostic and/or therapeutic uses. For example, they may be coupled to radionuclides for imaging and therapy, or to liposomes for the targeting of compounds contained in the liposomes to a specific tissue location.

Isolation of Murine PS1 gene

In order to characterize the physiological significance of the normal and mutant human PS1 gene and gene products in a transgenic mouse model, it was necessary to recover a mouse homologue of the human PS1 gene. A murine homologue of the human PS1 gene was recovered by screening a mouse cDNA library with a labelled human DNA probe. In this manner, a 2 kb partial transcript (representing the 3' end of the gene) and several RT-PCR products representing the 5' end were recovered. Sequencing of the consensus cDNA transcript of the murine homologue revealed substantial amino acid identity. The mouse cDNA sequence is identified as SEQ ID NO:3 and the predicted amino acid sequence is identified as SEQ ID NO:4. Further sequencing of the mouse cDNA transcript has provided the complete coding sequence, identified as SEQ ID NO: 135; the predicted amino acid sequence is identified as SEQ ID NO:4. More importantly, all of the amino acids that were mutated in the FAD pedigrees were conserved between the murine homologue and the normal human variant (Table 3). This conservation of the PS1 gene, as is shown in Table 3, indicates that an orthologous gene exists in the mouse (mPS1), and it is now possible to clone mouse genomic libraries using human PS1 probes. This will also make it possible to identify and characterize the PS1 gene in other species. This also provides evidence of animals with various disease states or disorders currently known or yet to be elucidated.

Transgenic Mouse Model

The creation of a mouse model for Alzheimer's Disease is important to the understanding of the disease and for the testing of possible therapies. Currently no unambiguous viable animal model for Alzheimer's Disease exists.

There are several ways in which to create an animal model for Alzheimer's Disease. One strategy is the generation, in the mouse gene, of a specific mutation such as one of the identified human PS1 gene mutations. Secondly, a wild type human gene could be inserted and/or the murine gene could be humanized by homologous recombination. Thirdly, it is possible to insert a mutant (single or multiple) human gene as a genomic or minigene cDNA construct using wild type, mutant or artificial promoter elements. Fourthly, knock-out of the endogenous murine genes may be accomplished by the insertion of artificially modified fragments of the endogenous gene by homologous recombination. The modifications include insertion of mutant stop codons, the deletion of DNA sequences, or the inclusion of recombination elements (lox p sites) recognized by enzymes such as Cre recombinase.

To inactivate the mPS1 gene, chemical or x-ray mutagenesis of mouse gametes, followed by fertilization, can be applied. Heterozygous offspring may be identified by Southern blotting to demonstrate loss of one allele by dosage, or failure to inherit one parental allele using RFLP markers.

To create a transgenic mouse, a mutant version of PS1 or mPS1 can be inserted into a mouse germ line using standard techniques of oocyte microinjection, or transfection or microinjection into stem cells. Alternatively, if it is desired

to inactivate or replace the endogenous mPS1 gene, homologous recombination using embryonic stem cells may be applied.

For oocyte injection, one or more copies of the mutant or wild type PS1 gene can be inserted into the pronucleus of a just-fertilized mouse oocyte. This oocyte is then reimplanted into a pseudo-pregnant foster mother. The liveborn mice are screened for integrants using analysis of tail DNA for the presence of human PS1 gene sequences. The transgene may be either a complete genomic sequence injected as a YAC, BAC, PAC or other chromosome DNA fragment, a cDNA with either the natural promoter or a heterologous promoter, or a minigene containing all of the coding region and other elements found to be necessary for optimum expression.

Retroviral infection of early embryos can also be done to insert the mutant or wild type human PS1. In this method, the mutant or wild type PS1 is inserted into a retroviral vector which is used to infect mouse embryos directly during the early stages of development to generate chimeras, some of which will lead to germline transmission. Similar experiments can be conducted in the case of mutant proteins, using mutant murine or other animal PS1 gene sequences.

Homologous recombination using stem cells allows for the screening of gene transfer cells to identify the rare homologous recombination events. Once identified, these can be used to generate chimeras by injection of mouse blastocysts, and a proportion of the resulting mice will show germline transmission from the recombinant line. This methodology is especially useful if inactivation of the mPS1 gene is desired. For example, inactivation of the mPS1 gene can be done by designing a DNA fragment which contains sequences from a mPS1 exon flanking a selectable marker. Homologous recombination leads to the insertion of the marker sequences in the middle of an exon, inactivating the mPS1 gene. DNA analysis of individual clones can then be used to recognize the homologous recombination events.

It is also possible to create mutations in the mouse germline by injecting oligonucleotides containing the mutation of interest and screening the resulting cells by PCR.

This embodiment of the invention has the most significant commercial value as a mouse model for Alzheimer's Disease. Because of the high percentage of sequence conservation between human and mouse it is contemplated that an orthologous gene will exist also in many other species. It is thus contemplated that it will be possible to generate other animal models using similar technology.

Isolation of the Human PS2 (E5-1) Gene, a Homologue of the PS1 (ARMP) Gene

A gene, presenilin II (PS2) or E5-1, with substantial nucleotide and amino acid homology to the PS1 gene was identified by using the nucleotide sequence of the cDNA for PS1 to search data bases using the BLASTN paradigm of Altschul et al. 1990. Three expressed sequence tagged sites (ESTs) identified by accession numbers T03796, R14600, and R05907 were located which had substantial homology ($p < 1.0 \times 10^{-100}$, greater than 97% identity over at least 100 contiguous base pairs).

Oligonucleotide primers were produced from these sequences and used to generate PCR products by reverse transcriptase PCR (RT-PCR). These short RT-PCR products were partially sequenced to confirm their identity with the sequences within the data base and were then used as hybridization probes to screen full-length cDNA libraries. Several different cDNA's ranging in size from 1 Kb to 2.3 Kb were recovered from a cancer cell cDNA library (CaCo-2) and from a human brain cDNA library (E5-1, G1-1, cc54, cc32).

The nucleotide sequence of these clones confirmed that all were derivatives of the same transcript.

The gene encoding the transcript, the PS2 gene, mapped to human chromosome 1 using hybrid mapping panels and to two clusters of CEPH Mega YAC clones which have been placed upon a physical contig map (YAC clones 750g7, 921d12 mapped by FISH to 1q41; and YAC clone 787g12 which also contains an EST for the leukemia associated phosphoprotein (LAP18) gene which has been mapped to 1p36. 1-p35) (data not shown).

Hybridization of the (E5-1) PS2 cDNA clones to northern blots detected an ~2.3 kilobase mRNA band in many tissues including regions of the brain, as well as a ~2.6 Kb mRNA band in muscle, cardiac muscle and pancreas.

In skeletal muscle, cardiac muscle and pancreas, the (E5-1) PS2 gene is expressed at relatively higher levels than in brain and as two different transcripts of ~2.3 Kb and ~2.6 Kb. Both of the transcripts have sizes clearly distinguishable from that of the 2.7 Kb PS1 transcript, and did not cross-hybridize with PS1 probes at high stringency. The cDNA sequence of the (E5-1) PS2 gene is identified as SEQ ID NO:136.

The longest ORF within the (E5-1) PS2 cDNA consensus nucleotide sequence predicts a polypeptide containing 448 amino acids (SEQ ID NO:137) numbering from the first in-phase ATG codon which was surrounded by a GCC-agg-GCt-ATG-c Kozak consensus sequence.

Analysis of RT-PCR products from brain and muscle RNA revealed that nucleotides 1153–1250 of the PS2 transcript are alternately spliced.

A splice variant of the (E5-1) PS2 cDNA sequence identified as SEQ ID NO:136 has also been found in all tissues examined. This splice variant lacks the triplet GAA at nucleotide positions 1338–1340.

A further variant has been found in one normal individual whose (E5-1) PS2 cDNA had C replacing T at nucleotide position 626, without any change in the amino acid sequence.

The DNA sequence of the PS2 gene as cloned has been incorporated into a vector and deposited at ATCC, Rockville, Md., under ATCC accession number 97214 on Jun. 28, 1995.

Mutations of the PS2 (E5-1) Gene Associated with Alzheimer's Disease

The strong similarity between PS1 and the (E5-1) PS2 gene product raised the possibility that the (E5-1) PS2 gene might be the site of disease-causing mutations in some of a small number of early onset AD pedigrees in which genetic linkage studies have excluded chromosomes 14, 19 and 21. RT-PCR was used to isolate cDNAs corresponding to the (E5-1) PS2 transcript from lymphoblasts, fibroblasts or post-mortem brain tissue of affected members of eight pedigrees with early onset FAD in which mutations in the β APP and PS1 gene had previously been excluded by direct sequencing studies.

Examination of these RT-PCR products detected a heterozygous A→G substitution at nucleotide 1080 in all four affected members of an extended pedigree of Italian origin (Flo10) with early onset, pathologically confirmed FAD (onset=50–70 yrs). This mutation would be predicted to cause a Met→Val missense mutation at codon 239 (Table 8).

A second mutation (A→T at nucleotide 787) causing a Asn→Ile substitution at codon 141 was found in affected members of a group of related pedigrees of Volga German ancestry (represented by cell lines AG09369, AG09907, AG09952, and AG09905, Coriell Institute, Camden N.J.). Significantly, one subject (AG09907) was homozygous for

this mutation, an observation compatible with the in-bred nature of these pedigrees. Significantly, this subject did not have a significantly different clinical picture from those subjects heterozygous for the Asn141Ile mutation. Neither of the (E5-1) PS2 gene mutations were found in 284 normal Caucasian controls nor were they present in affected members of pedigrees with the AD3 type of AD.

Both of these PS2 mutations would be predicted to cause substitution of residues which are highly conserved within the PS1/PS2 gene family.

An additional (E5-1) PS2 mutation is caused by a T to C substitution at base pair 1624 causing an Ile to Thr substitution at codon 420. This mutation was found in a further case of early onset (45 years of age) familial AD.

The finding of a gene whose product is predicted to share substantial amino acid and structural similarities with the PS1 gene product suggests that these proteins may be functionally related as independent proteins with overlapping functions but perhaps with slightly different specific activities, as physically associated subunits of a multimeric polypeptide or as independent proteins performing consecutive functions in the same pathway.

The observation of three different missense mutations in conserved domains of the (E5-1) PS2 protein in subjects with a familial form of AD argues that these mutations are, like those in the PS1 gene, causal to AD. This conclusion is significant because, while the disease phenotype associated with mutations in the PS1 gene (onset 30–50 yrs, duration 10 years) is subtly different from that associated with mutations in the (E5-1) PS2 gene (onset 40–70 years; duration up to 20 yrs), the general similarities clearly argue that the biochemical pathway subsumed by members of this gene family is central to the genesis of at least early onset AD. The subtle differences in disease phenotype may reflect a lower level of expression of the (E5-1) PS2 transcript in the CNS, or may reflect a different role for the (E5-1) PS2 gene product.

By analogy to the effects of PS1 mutations, (E5-1) PS2 when mutated may cause aberrant processing of APP (Amyloid Precursor Protein) into A β peptide, hyperphosphorylation of Tau microtubule associated protein and abnormalities of intracellular calcium homeostasis. Interference with these anomalous interactions provides a potential therapy for AD.

PS2 (E5-1) Protein

A comparison of the amino acid sequences of human PS1 and (E5-1) PS2 homologue protein is shown in Table 8. Identical residues are indicated by vertical lines. The locations of mutations in the (E5-1) PS2 gene are indicated by downward pointing arrows. The locations of the mutations in the human PS1 gene are indicated by upward pointing arrows. Putative TM domains are in open ended boxes. The alternatively spliced exons are denoted by superscripted (E5-1) PS2 or subscripted (PS1) “*”.

BLASTP alignment analyses also detected significant homology with SPE-4 of *C. elegans* (P=3.5 e-26; identity=20–63% over five domains of at least 22 residues), and weak homologies to brain sodium channels (alpha III subunit) and to the alpha subunit of voltage dependent calcium channels from a variety of species (P=0.02; identities 20–28% over two or more domains each of at least 35 residues) (Altschul, 1990). These alignments are similar to those described above for the PS1 gene. However, the most striking homology to the PS2 protein was found with the amino acid sequence predicted for PS1. PS1 and PS2 proteins share 63% overall amino acid sequence identity, and several domains display virtually complete identity (Table 8). Furthermore, all eight residues mutated in PS1 in subjects

with AD3 are conserved in the PS2 protein (Table 8). As would be expected, hydrophobicity analyses suggest that both proteins also share a similar structural organization.

The similarity was greatest in several domains of the protein corresponding to the intervals between transmembrane domain 1 (TM 1) and TM6, and from TM7 to the C-terminus of the PS1 gene. The main difference from PS1 is a difference in the size and amino acid sequence of the acidically-charged hydrophilic loop in the position equivalent to the hydrophilic loop between transmembrane domains TM6 and TM7 in the PS1 protein and in the sequence of the N-terminal hydrophilic domains.

Thus, both proteins are predicted to possess seven hydrophobic putative transmembrane domains, and both proteins bear large acidic hydrophilic domains at the N-terminus and between TM6 and TM7 (FIGS. 6 and 8). A further similarity arose from the above-described analysis of RT-PCR products from brain and muscle RNA, which revealed that nucleotides 1153–1250 of the (E5-1) PS2 transcript are alternatively spliced. These nucleotides encode amino acids 263–296, which are located within the TM6–TM7 loop domain of the putative PS2 protein and which share 94% sequence identity with the alternatively spliced amino acids 257–290 in PS1.

The most noticeable differences between the two predicted amino acid sequences occur in the amino acid sequence in the central portion of the TM6→TM7 hydrophilic loop (residues 304–374 of PS1; 310–355 of (PS2), and in the N-terminal hydrophilic domain (Table 8). By analogy, this domain is also less highly conserved between the murine and human PS1 genes (identity=47/60 residues), and shows no similarity to the equivalent region of SPE-4.

Isolation and Purification of PS2 (ARMP) Protein

The PS2 protein may be isolated and purified by the types of methods described above for the PS1 protein.

The protein may also be prepared by expression of the (E5-1) PS2 cDNA described herein in a suitable host. The protein is preferably expressed as a fusion protein by ligating its encoding cDNA sequence to a vector containing the coding sequence for another suitable peptide, e.g., GST. The fusion protein is expressed and recovered from prokaryotic cells such as bacterial or baculovirus cells or from eukaryotic cells. Antibodies to PS1, by virtue of portions of amino acid sequence identity with PS2, can be used to purify, attract and bind to PS2 protein and vice versa.

Antibodies to PS2 (E5-1)

Due to its structural similarity with the PS1, the PS2 protein may be used for the development of probes, peptides, or antibodies to various peptides within it which may recognize both the PS2 and the PS1 gene products. As a protein homologue for the PS1, the PS2 protein may be used as a replacement for a defective PS1 gene product. It may also be used to elucidate functions of the PS1 gene in tissue culture and vice versa.

Transgenic Mouse Model of PS2 (E5-1)-Related Alzheimer's Disease

An animal model of Alzheimer's Disease related to mutations of the PS2 gene may be created by methods analogous to those described above for the PS1 gene.

Functional Domains of Presenilins

The mutations in presenilin I (PS1) and presenilin II (PS2) cluster around two domains, suggesting that these domains are the functional domains of these proteins. Five PS1 mutations cluster in the region between codon 82 and codon 146 which comprises the putative first transmembrane domain (TM1), the TM1-TM2 loop, and the TM2 domain in presenilin I; the mutation at codon 141 of PS2 is located in

the TM2 domain of presenilin II. These mutations probably destabilize the TM1-TM2 loop domain and its anchor points in TM1 and TM2. Eight PS1 mutations result in the alteration of amino acids between codons 246 and 410, which are involved in TM6, the TM6-TM7 loop, and TM7. The TM6-TM7 loop is located on the opposite face of the membrane from the TM1-TM2 loop. These mutations may modify the structure or stability of the TM6-TM7 loop (either directly or by modifying the conformation of TM6 or TM7). Further evidence for a functional domain residing in the TM6-TM7 loop (amino acids 300 to 371) is the sequence divergence in the central part of the TM6-TM7 loop among different members of the presenilin protein family. Because the amino-terminus sequences of members of the presenilin protein family are divergent, it is likely that the amino-terminus, like the TM6-TM7 loop, plays a role in conferring specificity to the function of each of the different presenilin proteins. These regions may represent ligand binding sites. If this is so, mutations in the TM6-TM7 region are likely to modify ligand binding activity. The TM1-TM2 loop, which is conserved amongst different members of the presenilin protein family, probably represents an effector domain on the opposing membrane face. Both the TM6-TM7 loop and the TM1-TM2 loop can be used as sites to develop specific binding agents to inhibit the effects of the mutations and/or restore the normal function of the presenilin protein in subjects with Alzheimer's Disease.

Isolation of Presenilin Binding Proteins

Isolation of interacting partners of the presenilins allows identification of the biochemical partners for the presenilins and thus the identification of the biochemical pathway disturbed by mutations in PS1 and PS2. Such partners could be for example, enzymes, co-receptors, ligands or stabilizers. By analysing these interactions, it is possible to design compounds which counteract the effect of the mutation interaction, thus providing treatment for abnormal interactions. These treatments might alter the interaction of the presenilins with these partners, they may alter the function of the interacting protein, they may alter the amount or tissue distribution or expression of the interaction partners, or they may alter similar properties of the presenilins themselves.

Soluble recombinant fusion proteins can be made, or the nucleotide sequence coding for amino acids within the loop or parts of the loop can be expressed, in suitable vectors (yeast-2-hybrid, baculovirus, and phage—display systems for instance) and used to identify other proteins which interact with PS1 or PS2 in the pathogenesis of Alzheimer's Disease and other neurological and psychiatric diseases. Therapies can be designed to modulate these interactions and thus to modulate Alzheimer's Disease and the other conditions associated with acquired or inherited abnormalities of the PS1 or PS2 genes or their gene products. The potential efficacy of these therapies can be tested by analyzing the affinity and function of these interactions after exposure to the therapeutic agent by standard pharmacokinetic measurements of affinity (Kd and Vmax etc) using synthetic peptides or recombinant proteins corresponding to functional domains of the PS1 gene, the PS2 gene or other presenilin homologues. Another method for assaying the effect of any interactions involving functional domains such as the hydrophilic loop is to monitor changes in the intracellular trafficking and post-translational modification of the relevant genes by *in situ* hybridization, immunohistochemistry, Western blotting and metabolic pulse-chase labelling studies in the presence of, and in the absence of, the therapeutic agents. A further method is to monitor the effects of "downstream" events including (i)

changes in the intracellular metabolism, trafficking and targeting of APP and its products; (ii) changes in second messenger events, e.g., cAMP intracellular Ca^{++} , protein kinase activities, etc.

Based on the locations of the familial AD mutations, the position of divergent primary sequence and the general topology of the PS1 and PS2 proteins, it is proposed that at least three domains may provide functional specificity to the presenilins. These functional domains are (1) the N-terminus (unique sequence in PS1 and PS2); (2) the TM6→7 loop (clustered mutations in the flanking conserved hydrophobic sequences and unique internal sequence); (3) the TM1, TM2 domains and TM1→2 linking sequence (concentration of several familial AD mutations) and (4) the C-terminus. To isolate proteins that interact with these functional domains, screening for presenilin binding proteins is carried out using GST-fusion constructs and synthetic peptides corresponding to these regions. For example, for PS2, GST-fusion peptides are made including sequences corresponding to amino acids 1 to 87 (N-terminus) or 272–390 (TM6→7 loop) or a synthetic peptide is made corresponding to amino acids 107 to 134 (TM1→2 link);

for PS1, GST-fusion peptides are made including sequences corresponding to amino acids 1 to 81 (N-terminus) or 266 to 410 (TM6→7 loop) or a synthetic peptide is made corresponding to amino acids 101 to 131 (TM1→2 link). The following methods may be employed to isolate presenilin binding proteins:

- (1) direct extraction by affinity chromatography using GST-fusion proteins and synthetic peptides;
- (2) co-isolation of presenilins and bound proteins by immunoprecipitation;
- (3) Biomolecular Interaction Assay (BIAcore) utilizing a GST-fusion capture system; and
- (4) Two-Hybrid yeast systems.

1. GST-Presenilin Fusion Protein & Synthetic Peptide Affinity Chromatography

GST-fusion proteins containing the N-terminus and TM6→7 loop sequences for PS1 and PS2 are used to probe human brain homogenates and the isolated collection of proteins is separated by SDS-PAGE and microsequenced (Phizicky and Fields, 1995). To ensure that the band being sequenced contains only one protein species, the presenilin-fusion and binding proteins are separated by 2D gel electrophoresis prior to transfer and sequencing. For proteins with a blocked N-terminus, an additional HPLC purification and cleavage (CNBr and/or trypsin) of the particular binding protein is used to release peptide fragments. Further purification by HPLC and microsequencing by conventional methods provides internal sequence data on such blocked proteins.

The TM1→2 linking sequence is predicted to reside on the opposite side of the membrane to that of the N-terminal and TM6→7 loop and may be important in transmembrane communication. This is supported by the Tyr 115 His mutation which was observed in a pedigree with early onset familial AD (30–40 years) and by additional mutations in the TM ½ helices which might be expected to destabilise the loop. The TM1→2 loop is relatively short (PS1: residues 101–131; PS2: residues 107–134) making these sequence more amenable to convention peptide synthesis. The PS1 fragment (31-mer) has been synthesised containing an additional C-terminal cysteine residue. This peptide will be used to create an affinity substrate for affinity chromatography (Sulfo-link; Pierce) to isolate binding proteins for microsequencing. A peptide corresponding to the PS2 sequence is similarly synthesised and used to screen for distinct binding proteins.

2. Co-Immunoprecipitation of PS1/PS2 and Bound Proteins

An additional technique for the isolation of the presenilins and their associated proteins is direct immunoprecipitation with antibodies. This procedure has been successfully used, for example, to isolate many of the synaptic vesicle associated proteins (Phizicky & Fields, 1994).

3. Biomolecular Interaction Assay (BIAcore)

A useful method for the detection and isolation of binding proteins is the BIAcore system developed by Pharmacia Biosensor and described in the manufacturer's protocol (LKB Pharmacia, Sweden). This system uses an affinity purified anti-GST antibody to immobilize GST-fusion proteins onto a sensor chip. The sensor utilizes surface plasmon resonance which is an optical phenomenon that detects changes in refractive indices. A homogenate of a tissue of interest is passed over the immobilized fusion protein and protein-protein interactions are registered as changes in the refractive index. This system can be used to determine the kinetics of binding, to assess whether any observed binding is of physiological relevance.

4. Two-Hybrid Yeast System

The Two-Hybrid system takes advantage of transcriptional factors that are composed of two physically separable, functional domains (Phizicky and Fields, 1994, supra). The most commonly used is the yeast GAL4 transcriptional activator consisting of a DNA binding domain and a transcriptional activation domain. Two different cloning vectors are used to generate separate fusions of the GAL4 domains to genes encoding potential binding proteins. The fusion proteins are co-expressed, targeted to the nucleus and, if interactions occur, activation of a reporter gene (e.g. lacZ) produces a detectable phenotype. For example, the Clontech Matchmaker System-2 may be used to screen the Clontech brain cDNA GAL4 activation domain fusion library with presenilin GALA binding domain fusion clones (Clontech, Palo Alto, Calif.).

Identification of Small Molecules with Presenilin Binding Capacity

Small molecule-based therapies are particularly preferred because such molecules are more readily absorbed after oral administration, have fewer potential antigenic determinants, and/or are more likely to cross the blood brain barrier than larger, protein-based pharmaceuticals. In light of the present disclosure, one of ordinary skill in the art is enabled to develop drug screening methodologies which will be useful in the identification of candidate small molecule pharmaceuticals for the treatment of Alzheimer's Disease. In particular, one is enabled to screen large libraries of small molecules in order to identify those which bind to the normal and/or mutant PS1 or PS2 protein and which, therefore, are candidates for modifying the in vivo activity of the normal or mutant presenilin proteins. Furthermore, one is enabled to identify small molecules which selectively or preferentially bind to a mutant form of a presenilin protein and which, therefore, may have particular utility in treating heterozygous victims of this dominant autosomal disease.

Methods for screening small molecule libraries for candidate protein-binding molecules are well known in the art and, in light of the present disclosure, may now be employed to identify compounds which bind to the normal or mutant forms of a presenilin. Briefly, in one embodiment, either a normal or mutant PS1 or PS2 protein may be immobilized on a substrate such as a column or filter, and a solution including the test compound(s) is contacted with the presenilin protein under conditions which are permissive for binding. The substrate is then washed with a solution which substantially reflects physiological conditions to remove

unbound or weakly bound small molecules. A second wash may then elute those compounds which strongly bound to the immobilized normal or mutant presenilin. Alternatively, the small molecule test compounds may be immobilized and a solution of normal or mutant PS1 or PS2 may be contacted with the column, filter or other substrate. The ability of the presenilin to bind to the small molecules may be determined as above or a labelled form of presenilin (e.g., radio-labelled or chemiluminescent) may be used to more rapidly assess binding to the substrate-immobilized compound(s). In addition, as both PS1 and PS2 are believed to be membrane associated proteins, it may be preferred that the presenilin proteins be incorporated into lipid bilayers (e.g., liposomes) to promote their proper folding. Such presenilin-liposomes may be immobilized on substrates (either directly or by means of another element in the liposome membrane), passed over substrates with immobilized small molecules, or used in any of a variety of other well known binding assays for membrane proteins. In another series of embodiments, either normal or mutant, free or membrane-bound PS1 or PS2 may be mixed in a solution with the candidate compound(s) under conditions which are permissive for binding, and the presenilin may be immunoprecipitated. Small molecules which co-immunoprecipitate with a presenilin may then be identified. As will be obvious to one of ordinary skill in the art, there are numerous other methods of screening individual small molecules or large libraries of small molecules (e.g., phage display libraries) to identify compounds which bind to normal or mutant presenilins. All of these methods comprise the step of mixing normal or mutant presenilin with test compounds, allowing for binding (if any), and assaying for bound complexes. All such methods are now enabled by the present disclosure of purified the presenilin I and presenilin II proteins.

Because the normal physiological roles of PS1 and PS2 are still unknown, compounds which bind to normal or mutant or both forms of these presenilins may have utility in treatments. Compounds which bind only to a normal presenilin may, for example, act as enhancers of its normal activity and thereby at least partially compensate for the lost or abnormal activity of mutant forms of the presenilin in Alzheimer's Disease victims. Compounds which bind to both normal and mutant forms of a presenilin may have utility if they differentially affect the activities of the two forms so as to alleviate the overall departure from normal function. Alternatively, blocking the activity of both normal and mutant forms of either PS1 or PS2 in heterozygotes may have less severe physiological and clinical consequences than the normal progress of the disease and, therefore, compounds which bind to and inhibit the activity of both normal and mutant forms of a presenilin may have utility. Preferably, however, compounds are identified which have a higher affinity of binding to mutant presenilin than to normal presenilin (e.g., 5-10 fold higher K_a) and which selectively or preferentially inhibit the activity of the mutant form. Such compounds may be identified by using any of the techniques described above and by then comparing the binding affinities of the candidate compound(s) for the normal and mutant forms of PS1 or PS2.

Once identified by the methods described above, the candidate compounds may then be produced in quantities sufficient for pharmaceutical administration or testing (e.g., μg or mg or greater quantities), and formulated in a pharmaceutically acceptable carrier (see, e.g., *Remington's Pharmaceutical Sciences*, Gennaro, A., ed., Mack Pub., 1990, the disclosure of which is incorporated herein by reference). These candidate compounds may then be admin-

istered to Alzheimer's patients or animal models of Alzheimer's Disease. The animal models described and enabled herein are of particular utility in further testing candidate small molecules which bind to normal or mutant presenilin for their therapeutic efficacy.

Once identified by the methods described above, the candidate compounds may also serve as "lead compounds" in the design and development of new pharmaceuticals. For example, as is well known in the art, sequential modification of small molecules (e.g., amino acid residue replacement with peptides; functional group replacement with peptide or non-peptide compounds) is a standard approach in the pharmaceutical industry for the development of new pharmaceuticals. Such development generally proceeds from a "lead compound" which is shown to have at least some of the activity (e.g., PS1 binding ability) of the desired pharmaceutical. In particular, when one or more compounds having at least some activity of interest (e.g., PS1 binding) are identified, structural comparison of the molecules can greatly inform the skilled practitioner by suggesting portions of the lead compounds which should be conserved and portions which may be varied in the design of new candidate compounds. Thus, the present invention also provides a means of identifying lead compounds which may be sequentially modified to produce new candidate compounds for use in the treatment of Alzheimer's Disease. These new compounds then may be tested both for presenilin-binding (e.g., in the binding assays described above) and for therapeutic efficacy (e.g., in the animal models described herein). This procedure may be iterated until compounds having the desired therapeutic activity and/or efficacy are identified.

Assays for Identifying Drugs Which Affect Presenilin Expression

In another series of embodiments, the present invention provides assays for identifying small molecules or other compounds which are capable of inducing or inhibiting the expression of PS1, PS2 or other presenilin-related genes and proteins. The assays may be performed in vitro using non-transformed cells, immortalized cell lines, or recombinant cell lines. In addition, the assays may detect the presence of increased or decreased expression of PS1, PS2 or other presenilin-related genes or proteins on the basis of increased or decreased mRNA expression (using, e.g., the nucleic acid probes disclosed and enabled herein), increased or decreased levels of PS1, PS2 or other presenilin-related protein products (using, e.g., the anti-presenilin antibodies disclosed and enabled herein), or increased or decreased levels of expression of a reporter gene (e.g., β -galactosidase or luciferase) operatively joined to a presenilin 5' regulatory region in a recombinant construct.

Thus, for example, one may culture cells known to express a particular presenilin and add to the culture medium one or more test compounds. After allowing a sufficient period of time (e.g., 6-72 hours) for the compound to induce or inhibit the expression of the presenilin, any change in levels of expression from an established baseline may be detected using any of the techniques described above and well known in the art. In particularly preferred embodiments, the cells are from an immortalized cell line such as a human glioblastoma cell line or a hybridoma x glioma cell line. Using the nucleic acid probes and/or antibodies disclosed and enabled herein, detection of changes in the expression of a presenilin, and thus identification of the compound as an inducer or repressor of presenilin expression, requires only routine experimentation.

In particularly preferred embodiments, a recombinant assay is employed in which a reporter gene such a

β -galactosidase or luciferase is operably joined to the 5' regulatory regions of a presenilin gene. Such regulatory regions may be easily isolated and cloned by one of ordinary skill in the art in light of the present disclosure of the coding regions of these genes. The reporter gene and regulatory regions are joined in-frame (or in each of the three possible reading frames) so that transcription and translation of the reporter gene may proceed under the control of the presenilin regulatory elements. The recombinant construct may then be introduced into any appropriate cell type although mammalian cells are preferred, and human cells are most preferred. The transformed cells may be grown in culture and, after establishing the baseline level of expression of the reporter gene, test compounds may be added to the medium. The ease of detection of the expression of the reporter gene provides for a rapid, high through-put assay for the identification of inducers and repressors of the presenilin gene.

Compounds identified by this method will have potential utility in modifying the expression of the PS1, PS2 or other presenilin-related genes in vivo. These compounds may be further tested in the animal models disclosed and enabled herein to identify those compounds having the most potent in vivo effects. In addition, as described above with respect to small molecules having presenilin-binding activity, these molecules may serve as "lead compounds" for the further development of pharmaceuticals by, for example, subjecting the compounds to sequential modifications, molecular modeling, and other routine procedures employed in rational drug design.

Identification of a Homologue of the ARMP (PS1) Gene in *C. elegans*

A homologue of the presenilin genes has been found in *C. elegans*. This homologue is designated SEL-12.

Missense and nonsense mutations in this gene lead to an incompletely penetrant defect in intracellular signal transduction pathways mediated by the Notch/Lin-12 gene (Levitan, 1995). The Notch/Lin-12 gene mediates intercellular signalling and cell fate determination during embryo genesis.

By determining the biology of this *C. elegans* gene, one obtains a simpler model on which one can study potential therapeutics for manipulation of the system.

By examining the relationship between Notch/Lin-12 genes and the human presenilins, *Drosophila* DmPS and *C. elegans* SEL-12, one may elucidate the general biochemical functions of the presenilins and identify upstream and downstream genes in the pathway which can be modified therapeutically by drugs. Notch is involved in cell fate decisions in embryo genesis. These same cell fate decisions may be reactivated after injury due to genetic or environmental agents. If the presenilins, amyloid precursor protein (APP), or apolipoprotein E (ApoE) are involved in Notch mediated responses to injury, or responses mediated by other genes, which lead to regeneration or degeneration decisions similar to those occurring in embryo genesis (differentiation versus degeneration) then knowledge of this pathway can be exploited to develop drugs to suppress degenerative response and augment normal regenerative response. The *C. elegans* and *D. melanogaster* models provide convenient ways to (1) define the genes involved in Notch-presenilin interactions; (2) determine the structural nature of these interactions and effects of mutations on these interactions; and (3) develop and test compounds based on the data from (1) and (2) to modulate these interactions. There is good evidence APP and ApoE are involved in injury repair mechanisms.

This observation suggests that the presenilin genes may have similar functions and that mutations in the presenilin

genes may alter the effectiveness of intracellular signalling pathways. Modification of a signalling pathway in the presence of presenilin mutations could be used as a means to define treatments for Alzheimer's Disease (AD). The potential mechanisms by which mutations in the presenilin genes might alter intracellular signalling pathways include the following:

First, the presenilin gene could act as a co-receptor with other receptors such as Notch/Lin-12.

Second, the presenilins could be involved as downstream effectors in the signal pathway (for instance, perhaps acting as a second messenger or amplification system through modification of calcium metabolism, etc.). Alternatively, the presenilin proteins may be involved in the intracellular processing of membrane proteins such as Notch/Lin-12 or the β APP proteins. This role in protein processing would be in keeping with the intracellular localization of the presenilin proteins in the endoplasmic reticulum and Golgi apparatus. The alteration of protein processing could occur shortly after synthesis of the native membrane proteins (e.g. the presenilins may have a role in chaperone, protein folding, and membrane insertion events). Alternatively, the presenilins might have a function in the processing of other enzymes and intracellular proteins which are necessary for the modification of cell surface proteins such as Notch/Lin-12 and β APP (e.g. the presenilins may be involved in the processing of α , β and γ secretase which are involved in β APP metabolism). The presenilins could also be involved in the intracellular transport of fragments of cell membrane proteins (e.g. the C-terminal stump of Notch/Lin-12 or β APP), as for instance in the translocation of Notch/Lin-12 fragments into the nucleus where they affect transcription.

Disturbances of function caused by mutations in the presenilin genes could be modified or corrected by drug treatment. These drugs could be screened for by using one or more of the following assays:

PC12 cells (ATCC, Rockville, Md.) are stably transfected by standard lipofectamine or calcium phosphate methods with wild-type and mutant presenilin cDNA's cloned into the vector pcDNA3 (Invitrogen, San Diego, Calif.) and induced to differentiate into neuron-like cell types by the administration of nerve growth factor (Gibco/BRL, MD) (Obermeier et al., (1994), these cells return to the undifferentiated state after withdrawal of the nerve growth factor. Differences in the rates and degrees of differentiation between PC12 cells transfected with wild-type or mutant presenilin cDNA's can be quantitated and an assay is thereby obtained, in which reversion to the wild-type phenotype is scored after the administration of a variety of chemical compounds available from a pharmaceutical/chemical combinatorial library.

A similar assay can be derived based upon Notch signalling pathways in other cell types including *Drosophila melanogaster* cells (PC or S2 cells) transfected with activated (mutant) Notch cDNA clones, or mammalian P19 cells also transfected with activated Notch cDNA clones.

By double-transfecting the *Drosophila* or P19 cells with the activated Notch clone, and with either wild-type or mutant presenilin cDNA's, it is possible to discern a difference in the rate of differentiation in cell types transfected with wild-type presenilin compared to cell types co-transfected with the mutant presenilin cDNA. Again, by challenging these cell types and scoring the phenotype of suppression of differentiation into neuronal cells in the presence of chemicals drawn from a chemical combinatorial library, compounds may be identified which reverse the effect of mutant presenilin genes on this Notch-mediated phenotype.

A similar effect can also be achieved in *C. elegans* and *Drosophila melanogaster* whole animals. In this system, animals bearing either wild-type Notch/Lin-12 genes or activated mutations in the Notch/Lin-12 gene also carry either wild-type or mutant human presenilin transgenes.

C. elegans and *D. melanogaster* are transformed by microinjection oocytes.

The presenilin transgenes are cloned downstream of the *C. elegans* heat-shock promoter element in an expression vector such as pPD69.78 hsp 16.2 or pPD69.3 hsp 16-41, which are public domain vectors for creating *C. elegans* transgenic lines in which the gene of interest is under the control of an inducible heat shock promoter element.

Identification of a Homologue of the PS1 (ARMP) Gene in *D. melanogaster*

A homologue of the presenilin genes has been found in *D. melanogaster*. This homologue is designated the DmPS gene.

Redundant oligonucleotides coding for highly conserved regions of the presenilin/sel 12 portions were prepared and used to identify relevant mRNAs from adult and embryonic *D. melanogaster*. These mRNAs were sequenced and shown to contain an open reading frame with a putative amino acid sequence highly homologous to that of the human presenilins. The DmPS cDNA is identified as SEQ ID NO:165.

This Sequence encodes a polypeptide of 541 amino acids (SEQ ID NO:166) with about 52% identity to the human presenilins.

The DNA sequence of the DmPS gene as cloned has been incorporated into a plasmid Bluescript. This stable vector was been deposited at ATCC, Rockville, Md., under ATCC accession number 97428 on Jan. 26, 1996.

The structure of the *D. melanogaster* homologue is similar to that of the human presenilins with at least seven putative transmembrane domains (Kyte-Doolittle hydrophobicity analyses using window of 15 and cut-off of 1.5). Evidence of at least one alternative splice form was detected in that clone pds13 contained an ORF of 541 amino acids, while clones pds7, pds14 and pds1 lacked nucleotides 1300-1341 inclusive. This alternative splicing would result in the alteration of Gly to Ala at residue 384 in the putative TM6-TM7 loop, and in-frame fusion to the Glu residue at codon 399 of the longer ORF. The principal differences between the amino acid sequence of the *D. melanogaster* and human genes were in the N-terminal acid hydrophilic domain and in the acid hydrophilic portion of the TM6-TM7 loop. The residues surrounding the TM6→TM7 loop are especially conserved (residues 220-313 and 451-524) suggesting that these are functionally important domains. Sixteen out of twenty residues mutated in human PS1 or PS2 and giving rise to human FAD are conserved in the *D. melanogaster* homologue.

The *D. melanogaster* presenilin (DmPS) gene can be targeted for null mutations (either spontaneous deletions/rearrangements or mutations inserted by standard P-element mutagenesis techniques). Wild-type or mutant transgenes can be over-expressed using standard transgenic methods in which a cDNA minigene under the control of one or more promoter element such as the GAL4-UAS system is micro-injected into oocytes (Brand and Perrimon, 1993). The presence or absence of a phenotype can be scored by anatomic and pathologic inspection, for example for defects in Notch mediated developmental pathways (Campos-Ortega, 1991) similar to those seen in *C. elegans* with defects in the sel-12 gene, which is the *C. elegans* homologue of the human presenilin genes (Levitan & Greenwald, 1995), or for behavioural defects, for example defects in

memory and learning, using methods used to characterize this in *D. melanogaster* mutants such as “dunce” and “ruberbaker” (Davis, 1996), or by biochemical methods (e.g. detection of defects in the handling of APL-1 which is the *D. melanogaster* homologue of the human APP genes thought to be involved in AD). *Drosophila* models can be used to explore the general biochemical function of the DmPS gene by analyzing the effect of null (knockout) mutations, the effects, in the *D. melanogaster*, of missense mutations gene similar to those observed in the human presenilin genes in human early onset AD and the effects of over-expressing wild-type or mutant DmPS. Such models can also be used to determine whether the human presenilin genes can complement loss of function mutations in the *Drosophila* DmPS gene, providing guidance for gene replacement therapy in humans with mutant presenilin genes). These models can also be used to test the efficacy of drugs intended to affect the biochemical processes which cause AD. Such drug screening is carried out by observing which drugs correct or improve a phenotype associated with a DmPS gene mutation.

The DmPS gene can also be used to define other proteins which interact with the *Drosophila* DmPS homologue. The human equivalents of any interacting proteins identified in *D. melanogaster* can be isolated using a variety of methods including PCR with redundant oligonucleotides, and protein database searches. The function of the interacting protein can also be more conveniently examined in *D. melanogaster* by genetic and biochemical means. Methods for identifying and characterizing such interacting proteins include yeast-2-hybrid, affinity chromatography using the *D. melanogaster* protein as the affinity reagent), and immunoprecipitation (with or without cross-linking) methods (Phizicky & Fields, 1995). The kinetics, biochemistry, and structural basis of this interaction can be verified using BIAcore analysis or crystallography etc and would serve as a basis for the development of compounds to augment defective interactions or impede pathological interactions due to mutations in the *D. melanogaster* presenilin. The function of the interacting protein can also be more easily worked out by genetic and biochemical means in *D. melanogaster* than in a higher animal model.

Additionally, the DmPS gene can be used in genetic paradigms to identify other genes which interact with the presenilins and which can modulate the effect of the mutant isoforms of the presenilins. Cross breeding experiments with other mutant *D. melanogaster* lines provide a means of mapping and cloning other genes which suppress or enhance the phenotype associated with mutations in the *D. melanogaster* presenilin. Subsequent isolation of the human homologues of such modifier genes will identify gene products capable of modulating the effect of mutations in the human presenilin genes. The biochemical effect of these modulating gene products can be modelled and used to develop pharmaceuticals to treat AD. Part of or all of the modulating gene product itself can be administered as a treatment for AD by a variety of means including protein infusion and gene therapy.

Screening and Diagnosis for Alzheimer's Disease

General Diagnostic Methods

The presenilin and presenilin-related genes and gene products, as well as other products derived therefrom (e.g., probes, antibodies), will be useful in the diagnosis of Alzheimer's Disease, presenile and senile dementias, psychiatric diseases such as schizophrenia, depression, etc., and neurologic diseases such as stroke and cerebral hemorrhage—all of which are seen to a greater or lesser extent in symptomatic

subjects bearing mutations in the PS1 or PS2 genes or in the APP gene. Diagnosis of inherited cases of these diseases can be accomplished by methods based upon the nucleic acids (including genomic and mRNA/cDNA sequences), proteins, and/or antibodies disclosed and enabled herein. Preferably, the methods and products are based upon the human PS1 or PS2 nucleic acids, proteins or antibodies disclosed herein. As will be obvious to one of ordinary skill in the art, however, the significant evolutionary conservation of large portions of the PS1 and PS2 nucleotide and amino acid sequences, even in species as diverse as humans and *C. elegans* and *Drosophila*, allow the skilled artisan to make use of such non-human presenilin-homologue nucleic acids, proteins and antibodies even for applications directed toward human or other mammalian subjects. Thus, for brevity of exposition, but without limiting the scope of the invention, the following description will focus upon uses of the human homologues of PS1 and PS2. It will be understood, however, that homologous sequences from other species, including those disclosed herein, will be equivalent for many purposes.

As will be appreciated by one of ordinary skill in the art, the choice of diagnostic methods of the present invention will be influenced by the nature of the available biological samples to be tested and the nature of the information required. PS1, for example, is highly expressed in brain tissue but brain biopsies are invasive and expensive procedures, particularly for routine screening. Other tissues which express PS1 at significant levels, however, may demonstrate alternative splicing (e.g., white blood cells) and, therefore, PS1 mRNA or protein from such cells may be less informative. Thus, assays based upon a subject's genomic DNA may be the preferred methods for PS1 diagnostics as no information will be lost due to alternative splicing and because essentially any nucleate cells may provide a usable sample. Diagnostics based upon other presenilin-related proteins are subject to similar considerations: availability of tissues, levels of expression in various tissues, and alternative translation products resulting from alternative mRNA splicing.

When a diagnostic assay is to be based upon presenilin-related proteins, a variety of approaches are possible. For example, diagnosis can be achieved by monitoring differences in the electrophoretic mobility of normal and mutant proteins. Such an approach will be particularly useful in identifying mutants in which charge substitutions are present, or in which insertions, deletions or substitutions have resulted in a significant change in the molecular mass of the resultant protein. Alternatively, diagnosis may be based upon differences in the proteolytic cleavage patterns of normal and mutant proteins, differences in molar ratios of the various amino acid residues, or by functional assays demonstrating altered function of the gene products. In some preferred embodiments, protein-based diagnostics will employ differences in the ability of antibodies to bind to normal and mutant presenilin-related proteins (especially PS1 or PS2). Such diagnostic tests may employ antibodies which bind to the normal proteins but not to mutant proteins, or vice versa. Because a limited number of mutations have been identified in the PS1 and PS2 genes/proteins, and because these mutations appear to be themselves conserved, it is currently preferred that antibodies capable of selectively binding to mutant proteins be employed. In particular, an assay in which a plurality of monoclonal antibodies, each capable of binding to a mutant epitope, may be employed. The levels of anti-mutant antibody binding in a sample obtained from a test subject (visualized by, for example,

radiolabelling, ELISA or chemiluminescence) may be compared to the levels of binding to a control sample. Such antibody diagnostics may be used for in situ immunohistochemistry using biopsy samples of CNS tissues obtained antemortem or postmortem, including neuropathological structures associated with these diseases such as neurofibrillary tangles and amyloid plaques, or may be used with fluid samples such as cerebrospinal fluid or with peripheral tissues such as white blood cells.

When the diagnostic assay is to be based upon nucleic acids from a sample, either mRNA or genomic DNA may be used. When mRNA is used from a sample, many of the same considerations apply with respect to source tissues and the possibility of alternative splicing. That is, there may be little or no expression of transcripts unless appropriate tissue sources are chosen or available, and alternative splicing may result in the loss of some information. With either mRNA or DNA, standard methods well known in the art may be used to detect the presence of a particular sequence either in situ or in vitro (see, e.g. Sambrook et al., eds. (1989) *Molecular Cloning: A Laboratory Manual*, Cold Spring Harbor Press, Cold Spring Harbor, N.Y.).

For in situ detection of a mutant PS1, PS2 or other presenilin-related nucleic acid sequence, a sample of tissue may be prepared by standard techniques and then contacted with a probe, preferably one which is labelled to facilitate detection, and an assay for nucleic acid hybridization is conducted under stringent conditions which permit hybridization only between the probe and highly or perfectly complementary sequences. Because most of the PS1 and PS2 mutations detected to date consist of a single nucleotide substitution, high stringency hybridization conditions will be required to distinguish normal sequences from most mutant sequences. As an example only, the following procedure may be employed on a subject: A rat animal model is anesthetized and transcardially perfused with cold PBS, followed by perfusion with a formaldehyde solution. The brain or other tissue of interest is then removed, frozen in liquid nitrogen, and cut into thin micron sections. The sections are placed on slides and incubated in proteinase K. Following rinsing in DEP, water and ethanol, the slides are placed in prehybridization buffer. A radioactive probe corresponding to the selected oligonucleotide is incubated with the sectioned brain tissue. After incubation and air drying, the labeled areas are visualized by autoradiography. Dark spots on the tissue sample indicate hybridization of the probe with brain mRNA, demonstrating expression of the nucleic acid sequence.

A significant advantage of the use of either DNA or mRNA is the ability to amplify the amount of genetic material using the polymerase chain reaction (PCR), either alone (with genomic DNA) or in combination with reverse transcription (with mRNA to produce cDNA). Because it is contemplated that such PCR-based genetic methods may be preferred commercial embodiments for diagnostic screenings, a detailed description of several embodiments is presented below.

Screening for Alzheimer's Disease Linked to Chromosome 14

Screening for Alzheimer's Disease as linked to chromosome 14 may now be readily carried out because of the knowledge of the mutations in the gene.

Individuals with a high risk for Alzheimer's Disease (present in family pedigree) or, individuals not previously known to be at risk, or people in general may be screened routinely using probes to detect the presence of a mutant PS1 gene by a variety of techniques. Genomic DNA used for the

diagnosis may be obtained from body cells, such as those present in the blood, tissue biopsy, surgical specimen, or autopsy material. The DNA may be isolated and used directly for detection of a specific sequence or may be PCR amplified prior to analysis. RNA or cDNA may also be used. To detect a specific nucleic acid sequence, hybridization using specific oligonucleotides, direct nucleotide sequencing, restriction enzyme digest, RNase protection, chemical cleavage, or ligase-mediated detection may be used. Oligonucleotides specific to mutant sequences can be chemically synthesized and labelled radioactively with isotopes, or non-radioactively using biotin tags, and hybridized to individual samples immobilized on membranes or other solid-supports by dot-blot or transfer from gels after electrophoresis. The presence or absence of these mutant sequences is then visualized using methods such as autoradiography, fluorometry, or calorimetric reaction. Examples of suitable PCR primers which are useful for example in amplifying portions of the subject sequence containing the aforementioned mutations are set out in Table 5. This table also sets out changes in restriction enzyme sites to provide a useful diagnostic tool as defined herein. Direct DNA sequencing reveals sequence differences between normal and mutant PS1 DNA. Cloned genomic or cDNA segments may be used as probes to detect specific DNA segments. PCR can be used to enhance the sensitivity of this method. PCR is an enzymatic amplification directed by sequence-specific primers, and involves repeated cycles of heat denaturation of the DNA, annealing of the complementary primers and extension of the annealed primer with a DNA polymerase. This results in an exponential increase of the target DNA.

Other nucleotide sequence amplification techniques may be used, such as ligation-mediated PCR, anchored PCR and enzymatic amplification as will be understood by those skilled in the art.

Sequence alterations may also generate fortuitous restriction enzyme recognition sites which are revealed by the use of appropriate enzyme digestion followed by gel-blot hybridization. DNA fragments carrying the site (normal or mutant) are detected by their increase or reduction in size, or by the increase or decrease of corresponding restriction fragment numbers. Genomic DNA samples may also be amplified by PCR prior to treatment with the appropriate restriction enzyme and the fragments of different sizes are visualized, for example under UV light in the presence of ethidium bromide, after gel electrophoresis.

Genetic testing based on DNA sequence differences may be achieved by detection of alteration in electrophoretic mobility of DNA fragments in gels. Small sequence deletions and insertions can be visualized by high resolution gel electrophoresis of single stranded DNA, or as changes in the migration pattern of DNA heteroduplexes in non-denaturing gel electrophoresis. Alternatively, a single base substitution mutation may be detected based on differential PCR product length in PCR. The PCR products of the normal and mutant gene may be differentially detected in acrylamide gels.

Nuclease protection assays (S1 or ligase-mediated) also reveal sequence changes at specific locations.

Alternatively, to confirm or detect a polymorphism resulting in restriction mapping changes, ligated PCR, ASO, REF-SSCP chemical cleavage, endonuclease cleavage at mismatch sites or SSCP may be used. Both REF-SSCP and SSCP are mobility shift assays which are based upon the change in conformation due to mutations.

DNA fragments may also be visualized by methods in which the individual DNA samples are not immobilized on

membranes. The probe and target sequences may be in solution or the probe sequence may be immobilized. Autoradiography, radioactive decay, spectrophotometry and fluorometry may also be used to identify specific individual genotypes. Mutations can also be detected by direct nucleotide sequencing.

According to an embodiment of the invention, the portion of the cDNA or genomic DNA segment that is informative for a mutation can be amplified using PCR. For example, the DNA segment immediately surrounding the C410Y mutation acquired from peripheral blood samples from an individual can be screened using the oligonucleotide primers TGGAGACTGGAACACAAC (SEQ ID NO:127) and GTGTGGCCAGGGTAGAGAACT (SEQ ID NO:128). This region would then be amplified by PCR, the products separated by electrophoresis, and transferred to membrane. Normal and mutant PCR products may then be detected using, for example, hybridization of labeled oligonucleotide probes and autoradiography, RFLP analysis, or direct sequencing.

Screening for Alzheimer's Disease linked to Chromosome 1
Screening for Alzheimer's Disease linked to mutations of the PS2 gene may now be conveniently carried out.

General screening methods are described above in relation to the described mutations in the PS1 gene. These described methods can be readily applied and adapted to detection of the described chromosome 1 mutations, as will be readily understood by those skilled in the art.

In accordance with one embodiment of the invention, the Asn141Ile mutation is screened for by PCR amplification of the surrounding DNA fragment using the primers:

5'-CATTCCTGAGGACACACC (end-labelled) and (SEQ ID NO:175)

5'-TGTAGAGCACCACCAAGA (unlabelled) (SEQ ID NO:176)

Any tissue with nucleated cells may be examined. The amplified products may be separated by, for example, electrophoresis and an autoradiogram or other standard method may be employed to detect mutant sequences.

In accordance with a further embodiment, the Met239Val mutation is screened for by PCR amplification of its surrounding DNA fragment using the primers:

5'-GCATGGTGTGCATCCACT and (SEQ ID NO:177)

5'-GGACCACTCTGGGAGGTA (SEQ ID NO:178)

The amplified products are separated and an autoradiogram or other standard method may be employed to detect mutant sequences.

In accordance with a further embodiment, the Ile420Thr mutation is screened for by PCR amplification of genomic DNA using primers 5' TGC TGC TTG CTG TGT TCA 3' (SEQ ID NO:161) and 5' CCA TGT CCC TCA GAT GTA GA 3' (SEQ ID NO:162) to generate a 146 base pair product which can be probed with allele specific oligonucleotides for the wild-type (5' CAT CTC CAT CAC GTT CG 3'; SEQ ID NO:163) and mutant (5' CAT CTC CAC CAC GTT CG 3'; SEQ ID NO:164) sequences.

The same primer sets may be used to detect the mutations by means of other methods such as SSCP, chemical cleavage, DGGE, nucleotide sequencing, ligation chain reaction and allele specific oligonucleotides. As will be understood by those skilled in the art, other suitable primer pairs may be devised and used.

In inherited cases, as the primary event, and in non-inherited cases as a secondary event due to the disease state, abnormal processing of PS1, PS2, APP or proteins reacting with PS1, PS2, or APP may occur. This can be detected as abnormal phosphorylation, glycosylation, glycation amida-

tion or proteolytic cleavage products in body tissues or fluids, e.g., CSF or blood.

Diagnosis of non-inherited cases also can be made by observation of alterations in the presenilin transcription, translation, and post-translational modification and processing as well as alterations in the intracellular and extracellular trafficking of presenilin gene products in the brain and peripheral cells. Such changes will include alterations in the amount of presenilin messenger RNA and/or protein, alteration in phosphorylation state, abnormal intracellular location/distribution, abnormal extracellular distribution, etc. Such assays will include: Northern Blots (with presenilin-specific and non-specific nucleotide probes which also cross-react with other members of the gene family), and Western blots and enzyme-linked immunosorbent assays (ELISA) (with antibodies raised specifically to: a presenilin; to various functional domains of a presenilin; to other members of the homologous gene family; and to various post-translational modification states including glycosylated and phosphorylated isoforms). These assays can be performed on peripheral tissues (e.g. blood cells, plasma, cultured or other fibroblast tissues, etc.) as well as on biopsies of CNS tissues obtained antemortem or postmortem, and upon cerebrospinal fluid. Such assays might also include in-situ hybridization and immunohistochemistry (to localized messenger RNA and protein to specific subcellular compartments and/or within neuropathological structures associated with these diseases such as neurofibrillary tangles and amyloid plaques).

In accordance with the present invention, diagnostic kits are also provided which will include the reagents necessary for the above-described diagnostic screens. For example, kits may be provided which include antibodies or sets of antibodies which are specific to one or more mutant epitopes. These antibodies may, in particular, be labelled by any of the standard means which facilitate visualization of binding. Alternatively, kits may be provided in which oligonucleotide probes or PCR primers are present for the detection and/or amplification of mutant PS1, PS2 or other presenilin-related nucleotide sequences. Again, such probes may be labelled for easier detection of specific hybridization. As appropriate to the various diagnostic embodiments described above, the oligonucleotide probes or antibodies in such kits may be immobilized to substrates and appropriate controls may be provided.

Therapies

An important aspect of the biochemical studies using the genetic information of this invention is the development of therapies to circumvent or overcome the PS1 or PS2 gene defect, and thus prevent, treat, control serious symptoms or cure the disease. In view of expression of the PS1 gene in a variety of tissues, one has to recognize that Alzheimer's Disease may not be restricted to the brain, or alternatively that diseases manifest in other tissues may arise from mutations, mis-expression, mis-metabolism or other inherited or acquired alteration in these genes and gene products.

Alzheimer's Disease manifests itself as a neurological disorder which in one of its forms is caused by a mutation in the PS1 gene and in another of its forms by a mutation in the PS2 gene, but such manifestation may be caused by the mutations affecting other organ tissues, such as the liver, releasing factors which affect brain activity and ultimately cause Alzheimer's Disease. Hence, in considering various therapies, it is understood that such therapies may be targeted at tissue other than the brain, such as heart, placenta, lung, liver, skeletal muscle, kidney and pancreas, where PS1 or PS2 is also expressed.

The effect of these mutations in PS1 and PS2 apparently is a gain of a novel function or an acceleration of a normal function which causes aberrant processing of (APP) Amyloid Precursor Protein into A β peptide, abnormal phosphorylation homeostasis, and abnormal apoptosis in brain. These effects are direct or indirect and are consistent with dominant inheritance with adult onset of symptoms.

Therapy to reverse this will be by means of small molecules (drugs), recombinant proteins, antibodies or recombinant genes, to block the aberrant function by altering the structure of the mutant protein, by enhancing its metabolic clearance or inhibiting binding of ligands to the mutant protein, or by inhibiting the channel function of the mutant protein. The same effect might be gained by inserting a second mutant protein by gene therapy similar to the correction of the "Deg 1(d)" and "Mec 4(d)" mutations in *C. elegans* by insertion of mutant transgenes. Alternately, overexpression of wild type PS1 protein or wild type PS2 or both may correct the defect. This could be achieved by the administration of drugs or proteins to induce the transcription and translation or inhibit the catabolism of the native PS1 and PS2 proteins. It could also be accomplished by infusion of recombinant proteins or by gene therapy with vectors causing expression of the normal protein at a high level or by modification of interacting proteins by the procedures described elsewhere herein.

Rationale for Therapeutic, Diagnostic, and Investigational Applications of the PS1 Gene and Gene Products as They Relate to the Amyloid Precursor Protein

The A β peptide derivatives of APP are neurotoxic (Selkoe et al, 1994). APP is metabolized by passages through the Golgi network and then to secretory pathways via clathrin-coated vesicles with subsequent passage to the plasma membrane where the mature APP is cleaved by α -secretase to a soluble fraction (Protease Nexin II) plus a non-amyloidogenic C-terminal peptide (Selkoe et al. 1995, Gandy et al. 1993). Alternatively, mature APP can be directed to the endosome-lysosome pathway where it undergoes β and α secretase cleavage to produce the A β peptides. The phosphorylation state of the cell determines the relative balance of α -secretase (non-amyloidogenic) or A β pathways (amyloidogenic pathway) (Gandy et al. 1993). The phosphorylation state of the cell can be modified pharmacologically by phorbol esters, muscarinic agonists and other agents, and appears to be mediated by cytosolic factors (especially protein kinase C) acting upon an integral membrane protein in the Golgi network, which we propose to be the PS1, and members of the homologous family (all of which carry several phosphorylation consensus sequences for protein kinase C). Mutations in the PS1 gene will cause alterations in the structure and function of the PS1 gene product leading to defective interactions with regulatory elements (e.g., protein kinase C) or with APP, thereby promoting APP to be directed to the amyloidogenic endosome-lysosome pathway. Environmental factors (viruses, toxins, and aging etc) may also have similar effects on PS1. To treat Alzheimer's Disease, the phosphorylation state of PS1 can be altered by chemical and biochemical agents (e.g., drugs, peptides and other compounds) which alter the activity of protein kinase C and other protein kinases, or which alter the activity of protein phosphatases, or which modify the availability of PS1 to be post-translationally modified. The interactions between kinases and phosphatases with the PS1 gene products (and the products of its homologues), and the interactions of the PS1 gene products with other proteins involved in the trafficking of APP within the Golgi network can be modulated to

decrease trafficking of Golgi vesicles to the endosome-lysosome pathway thereby promoting A β peptide production. Such compounds will include: peptide analogues of APP, PS1, and homologues of PS1 as well as other interacting proteins, lipids, sugars, and agents which promote differential glycosylation of PS1 and its homologues; agents which alter the biologic half-life of messenger RNA or protein of PS1 and homologues including antibodies and antisense oligonucleotides; and agents which act upon PS1 transcription.

The effect of these agents in cell lines and whole animals can be monitored by monitoring: transcription; translation; post-translational modification of PS1 (eg phosphorylation or glycosylation); and intracellular trafficking of PS1 and its homologues through various intracellular and extracellular compartments. Methods for these studies include Western and Northern blots; immunoprecipitation after metabolic labelling (pulse-chase) with radio-labelled methionine and ATP, and immunohistochemistry. The effect of these agents can also be monitored using studies which examine the relative binding affinities and relative amounts of PS1 gene products involved in interactions with protein kinase C and/or APP using either standard binding affinity assays or co-precipitation and Western blots using antibodies to protein kinase C, APP or PS1 and its homologues. The effect of these agents can also be monitored by assessing the production of A β peptides by ELISA before and after exposure to the putative therapeutic agent (Huang et al. 1993). The effect can also be monitored by assessing the viability of cell lines after exposure to aluminum salts and to A β peptides which are thought to be neurotoxic in Alzheimer's Disease. Finally, the effect of these agents can be monitored by assessing the cognitive function of animals bearing: their normal genotype at APP or PS1 homologues; or bearing human APP transgenes (with or without mutations); or bearing human PS1 transgenes (with or without mutations); or a combination of all of these.

Rationale for Therapeutic, Diagnostic, and Investigational Applications of the PS1 and PS2 Genes and Products

The PS1 gene product and the PS2 gene product have amino acid sequence homology to human ion channel proteins and receptors. For instance, the PS2 protein shows substantial homology to the human sodium channel (α -subunit (E=0.18, P=0.16, identities=22–27% over two regions of at least 35 amino acid residues) using the BLASTP paradigm of Altschul et al. 1990. Other diseases (such as malignant hyperthermia and hyperkalemic periodic paralysis in humans and the neurodegenerative of mechanosensory neurons in *C. elegans*) arise through mutations in ion channels or receptor proteins. Mutation of the PS1 gene or the PS2 gene could affect similar functions and lead to Alzheimer's Disease and other psychiatric and neurological diseases. Based upon this, a test for Alzheimer's Disease can be produced to detect an abnormal receptor or an abnormal ion channel function related to abnormalities that are acquired or inherited in the PS1 gene and its product, or in one of the homologous genes such as PS2 and their products. This test can be accomplished either in vivo or in vitro by measurements of ion channel fluxes and/or transmembrane voltage or current fluxes using patch clamp, voltage clamp and fluorescent dyes sensitive to intracellular calcium or transmembrane voltage. Defective ion channel or receptor function can also be assayed by measurements of activation of second messengers such as cyclic AMP, cGMP tyrosine kinases, phosphates, increases in intracellular Ca²⁺ levels, etc. Recombinantly made proteins may also be reconstructed in artificial membrane systems to study ion channel conduc-

tance. Therapies which affect Alzheimer's Disease (due to acquired/inherited defects in the PS1 gene or PS2 gene; due to defects in other pathways leading to this disease such as mutations in APP; and due to environmental agents) can be tested by analysis of their ability to modify an abnormal ion channel or receptor function induced by mutation in the PS1 gene or in one of its homologues. Therapies could also be tested by their ability to modify the normal function of an ion channel or receptor capacity of the PS1 gene products and its homologues. Such assays can be performed on cultured cells expressing endogenous normal or mutant PS1 genes/gene products or PS2 genes/gene products. Such studies can be performed in addition on cells transfected with vectors capable of expressing PS1, parts of the PS1 gene and gene product, mutant PS1, PS2 gene, parts of the PS2 gene and gene product, mutant PS2 gene or another homologue in normal or mutant form. Therapies for Alzheimer's Disease can be devised to modify an abnormal ion channel or receptor function of the PS1 gene or PS2 gene. Such therapies can be conventional drugs, peptides, sugars, or lipids, as well as antibodies or other ligands which affect the properties of the PS1 or PS2 gene product. Such therapies can also be performed by direct replacement of the PS1 gene and/or PS2 gene by gene therapy. In the case of an ion channel, the gene therapy could be performed using either mini-genes (cDNA plus a promoter) or genomic constructs bearing genomic DNA sequences for parts or all of the PS1 gene. Mutant PS1 or homologous gene sequences might also be used to counter the effect of the inherited or acquired abnormalities of the PS1 gene as has recently been done for replacement of the *mec 4* and *deg 1* in *C. elegans* (Huang and Chalfie, 1994). The therapy might also be directed at augmenting the receptor or ion channel function of the homologous genes such as the PS2 gene, in order that it may potentially take over the functions of the PS1 gene rendered defective by acquired or inherited defects. Therapy using antisense oligonucleotides to block the expression of the mutant PS1 gene or the mutant PS2 gene, coordinated with gene replacement with normal PS1 or PS2 gene can also be applied using standard techniques of either gene therapy or protein replacement therapy.

Protein Therapy

Treatment of Alzheimer's Disease can be performed by replacing the mutant protein with normal protein, or by modulating the function of the mutant protein. Once the biological pathway of the PS1 protein and the PS2 protein has been completely understood, it may also be possible to modify the pathophysiologic pathway or pathways (eg. a signal transduction pathway) in which these proteins participate, in order to correct the physiological defect.

To replace the mutant protein with normal protein, or with a protein bearing a deliberate counterbalancing mutation it is necessary to obtain large amounts of pure PS1 protein or PS2 protein from cultured cell systems which can express the protein. Delivery of the protein to the affected brain areas or other tissues can then be accomplished using appropriate packaging or administrating systems.

Gene Therapy

Gene therapy is another potential therapeutic approach in which normal copies of the PS1 gene or the PS2 gene are introduced into patients to code successfully for normal protein in several different affected cell types. The gene must be delivered to those cells in a form in which it can be taken up and code for sufficient protein to provide effective function. Alternatively, in some neurologic mutants it has been possible to prevent disease by introducing another copy of the homologous gene bearing a second mutation in that gene or to alter the mutation, or use another gene to block its effect.

Retroviral vectors can be used for somatic cell gene therapy especially because of their high efficiency of infection and stable integration and expression. The targeted cells however must be able to divide and the expression of the levels of normal protein should be high because the disease is a dominant one. The full length PS1 gene can be cloned into a retroviral vector and driven from its endogenous promoter or from the retroviral long terminal repeat or from a promoter specific for the target cell type of interest (such as neurons).

Other viral vectors which can be used include adeno-associated virus, vaccinia virus, bovine papilloma virus, or a herpesvirus such as Epstein-Barr virus.

Gene transfer could also be achieved using non-viral means requiring infection in vitro. This would include calcium phosphate, DEAE dextran, electroporation, and protoplast fusion. Liposomes may also be potentially beneficial for delivery of DNA into a cell. Although these methods are available, many of these are lower efficiency.

Antisense based strategies can be employed to explore PS1 gene function and as a basis for therapeutic drug design. The principle is based on the hypothesis that sequence-specific suppression of gene expression can be achieved by intracellular hybridization between mRNA and a complementary antisense species. The formation of a hybrid RNA duplex may then interfere with the processing/transport/translation and/or stability of the target PS1 mRNA. Hybridization is required for the antisense effect to occur, however the efficiency of intracellular hybridization is low and therefore the consequences of such an event may not be very successful. Antisense strategies may use a variety of approaches including the use of antisense oligonucleotides, injection of antisense RNA and transfection of antisense RNA expression vectors. Antisense effects can be induced by control (sense) sequences, however, the extent of phenotypic changes are highly variable. Phenotypic effects induced by antisense effects are based on changes in criteria such as protein levels, protein activity measurement, and target mRNA levels. Multidrug resistance is a useful model to study molecular events associated with phenotypic changes due to antisense effects, since the multidrug resistance phenotype can be established by expression of a single gene *mdr1* (MDR gene) encoding for P-glycoprotein.

Transplantation of normal genes into the affected area of the patient can also be useful therapy for Alzheimer's Disease. In this procedure, a normal human PS1 gene is transferred into a cultivatable cell type such as glial cells, either exogenously or endogenously to the patient. These cells are then injected serologically into the disease-affected tissue or tissues. This is a known treatment for Parkinson's disease.

Similar gene therapy strategies may be employed with respect to the PS2 gene in patients suffering from abnormalities in this gene.

Immunotherapy is also possible for Alzheimer's Disease. Antibodies are raised to a mutant PS1 or PS2 protein (or a portion thereof) and are administered to the patient to bind or block the mutant protein and prevent its deleterious effects. Simultaneously, expression of the normal protein product could be encouraged. Alternatively, antibodies are raised to specific complexes between mutant or wild-type PS1 or PS2 and their interaction partners.

A further approach is to stimulate endogenous antibody production to the desired antigen. Administration could be in the form of a one time immunogenic preparation or vaccine immunization. An immunogenic composition may be prepared as injectables, as liquid solutions or emulsions. The

PS1 or PS2 protein or other antigen may be mixed with pharmaceutically acceptable excipients compatible with the protein. Such excipients may include water, saline, dextrose, glycerol, ethanol and combinations thereof. The immunogenic composition and vaccine may further contain auxiliary substances such as emulsifying agents or adjuvants to enhance effectiveness. Immunogenic compositions and vaccines may be administered parenterally by injection subcutaneously or intramuscularly.

The immunogenic preparations and vaccines are administered in such amount as will be therapeutically effective, protective and immunogenic. Dosage depends on the route of administration and will vary according to the size of the host.

The above disclosure generally describes the present invention. A more complete understanding can be obtained by reference to the following specific examples. These examples are described solely for purposes of illustration and are not intended to limit the scope of the invention. Changes in the form and substitution of equivalents are contemplated as circumstances may suggest or render expedient. Although specific terms have been employed herein, such terms are intended in a descriptive sense and not for purposes of limitation.

The examples are described for the purposes of illustration and are not intended to limit the scope of the invention.

EXAMPLES

Example 1

Development of the Genetic, Physical "contig" and Transcriptional Map of the Minimal Co-segregating Region

The CEPH Mega YAC and the RPCI PAC human total genomic DNA libraries were searched for clones containing genomic DNA fragments from the AD3 region of chromosome 14q24.3 using oligonucleotide probes for each of the 12 SSR marker loci used in the genetic linkage studies as well as the additional markers depicted in FIG. 1A (Albertsen et al., 1990; Chumakov et al., 1992; Ioannu et al., 1994). The genetic map distances between each marker are depicted above the contig, and are derived from published data (NIH/CEPH Collaborative Mapping Group, 1992; Wang, 1992; Weissenbach, J et al., 1992; Gyapay, G et al., 1994). Clones recovered for each of the initial marker loci were arranged into an ordered series of partially overlapping clones ("contig") using four independent methods. First, sequences representing the ends of the YAC insert were isolated by inverse PCR (Riley et al., 1990), and hybridized to Southern blot panels containing restriction digests of DNA from all of the YAC clones recovered for all of the initial loci in order to identify other YAC clones bearing overlapping sequences. Second, inter-Alu PCR was performed on each YAC, and the resultant band patterns were compared across the pool of recovered YAC clones in order to identify other clones bearing overlapping sequences (Bellamne-Chartelot et al., 1992; Chumakov et al., 1992). Third, to improve the specificity of the Alu-PCR fingerprinting, the YAC DNA was restricted with *Hae*III or *Rsa*I, the restriction products were amplified with both Alu and L1H consensus primers, and the products were resolved by polyacrylamide gel electrophoresis. Finally, as additional STSs were generated during the search for transcribed sequences, these STSs were also used to identify overlaps. The resultant contig was complete except for a single discontinuity between YAC932C7 bearing D14S53 and YAC746B4 containing D14S61. The physical map order of the STSs within the contig was largely in accordance with the genetic linkage map for this region (NIH/CEPH Col-

laborative Mapping Group, 1992; Wang, Z, Weber, J. L., 1992; Weissenbach, J et al., 1992; Gyapay, G et al., 1994). However, as with the genetic maps, it was not possible to resolve unambiguously the relative order of the loci within the D14S43/D14S71 cluster and the D14S76/D14S273 cluster. PAC1 clones suggested that D14S277 is telomeric to D14S268, whereas genetic maps have suggested the reverse order. Furthermore, a few STS probes failed to detect hybridization patterns in at least one YAC clone which, on the basis of the most parsimonious consensus physical map and from the genetic map, would have been predicted to contain that STS. For instance, the D14S268 (AFM265) and RSCAT7 STSs are absent from YAC788H12. Because these results were reproducible, and occurred with several different STS markers, these results most likely reflect the presence of small interstitial deletions within one of the YAC clones.

Example 2

Cumulative Two-point Lod Scores for Chromosome 14q24.3 Markers

Genotypes at each polymorphic microsatellite marker locus were determined by PCR from 100 ng of genomic DNA of all available affected and unaffected pedigree members as previously described (St George-Hyslop, P et al., 1992) using primer sequences specific for each microsatellite locus (Weissenbach, J et al., 1992; Gyapay, G et al., 1994). The normal population frequency of each allele was determined using spouses and other neurologically normal subjects from the same ethnic groups, but did not differ significantly from those established for mixed Caucasian populations (Weissenbach, J et al., 1992; Gyapay, G et al., 1994). The maximum likelihood calculations assumed an age of onset correction, marker allele frequencies derived from published series of mixed Caucasian subjects, and an estimated allele frequency for the AD3 mutation of 1:1000 as previously described (St George-Hyslop, P et al., 1992). The analyses were repeated using equal marker allele frequencies, and using phenotype information only from affected pedigree members as previously described to ensure that inaccuracies in the estimated parameters used in the maximum likelihood calculations did not misdirect the analyses (St George-Hyslop, P et al., 1992). These supplemental analyses did not significantly alter either the evidence supporting linkage, or the discovery of recombination events.

Example 3

Haplotypes Between Flanking Markers Segregated with AD3 in FAD Pedigrees

Extended haplotypes between the centromeric and telomeric flanking markers on the parental copy of chromosome 14 segregating with AD3 in fourteen early onset FAD pedigrees (pedigrees NIH2, MGH1, Tor1.1, FAD4, FAD1, MEX1, and FAD2 show pedigree specific lod scores $\geq +3.00$ with at least one marker between D14S258 and D14S53). Identical partial haplotypes (boxed) are observed in two regions of the disease bearing chromosome segregating in several pedigrees of similar ethnic origin. In region A, shared alleles are seen at D14S268 ("B": allele size=126 bp, allele frequency in normal Caucasians=0.04; "C": size=124 bp, frequency=0.38); D14S277 ("B": size=156 bp, frequency=0.19; "C": size=154 bp, frequency=0.33); and RSCAT6 ("D": size=111 bp, frequency 0.25; "E": size=109 bp, frequency=0.20; "F": size=107 bp, frequency=0.47). In region B, alleles of identical size are observed at D14S43 ("A": size=193bp, frequency=0.01; "D": size=187 bp, frequency=0.12; "E": size=185 bp, frequency=0.26; "I":

size=160 bp, frequency=0.38); D14S273 ("3": size=193 bp, frequency=0.38; "4" size=191 bp, frequency=0.16; "5": size=189 bp, frequency=0.34; "6": size=187 bp, frequency=0.02) and D14S76 ("1": size=bp, frequency=0.01; "5": size=bp, frequency=0.38; "6": size=bp, frequency=0.07; "9": size=bp, frequency=0.38). The ethnic origins of each pedigree are abbreviated as: Ashk=Ashkenazi Jewish; Ital=Southern Italian; Angl=Anglo-Saxon-Celt; FrCan=French Canadian; Jpn=Japanese; Mex=Mexican Caucasian; Ger=German; Am=American Caucasian. The type of mutation detected is depicted by the amino acid substitution and putative codon number or by ND where no mutation has been detected because a comprehensive survey has not been undertaken due to the absence of a source of mRNA for RT-PCR studies.

Example 4

Recovery of Transcribed Sequences from the AD3 Interval.

Putative transcribed sequences encoded in the AD3 interval were recovered using a direct hybridization method in which short cDNA fragments generated from human brain mRNA were hybridized to immobilized cloned genomic DNA fragments (Rommens, JM et al., 1993). The resultant short putatively transcribed sequences were used as probes to recover longer transcripts from human brain cDNA libraries (Stratagene, La Jolla). The physical locations of the original short clone and of the subsequently acquired longer cDNA clones were established by analysis of the hybridization pattern generated by hybridizing the probe to Southern blots containing a panel of EcoRI digested total DNA samples isolated from individual YAC clones within the contig. The nucleotide sequence of each of the longer cDNA clones was determined by automated cycle sequencing (Applied Biosystems Inc., Calif.), and compared to other sequences in nucleotide and protein databases using the blast algorithm (Altschul, SF et al., 1990). Accession numbers for the transcribed sequences in this report are: L40391, L40392, L40393, L40394, L40395, L40396, L40397, L40398, L40399, L40400, L40401, L40402, and L40403.

Example 5

Locating Mutations in the ARMP (PS1) Gene Using Restriction Enzymes

The presence of Ala 246 Glu mutation which creates a DdeI restriction site was assayed in genomic DNA by PCR using the end labelled primer (5'-ATCTCCGGCAGGCATATCT-3') SEQ ID NO:129 and the unlabelled primer (5'-TGAAATCACAGCCAAGATGAG-3') SEQ ID NO:130 to amplify an 84 bp genomic exon fragment using 100 ng of genomic DNA template, 2 mM MgCl₂, 10 pMoles of each primer, 0.5 U Taq polymerase, 250 uM dNTPs for 30 cycles of 95° C. x20 seconds, 60° C. x20 seconds, 72° C. x5 seconds. The products were incubated with an excess of DdeI for 2 hours according to the manufacturers protocol, and the resulting restriction fragments were resolved on a 6% nondenaturing polyacrylamide gel and visualized by autoradiography. The presence of the mutation was inferred from the cleavage of the 84 bp fragment to due to the presence of a DdeI restriction site. All affected members of the FAD1 pedigree (filled symbols) and several at-risk members ("R") carried the DdeI site. None of the obligate escapees (those individuals who do not get the disease, age >70 years), and none of the normal controls carried the DdeI mutation.

Example 6

Locating Mutations in the ARMP (PS1) Gene Using Allele Specific Oligonucleotides

The presence of the Cys 410 Tyr mutation was assayed using allele specific oligonucleotides. 100 ng of genomic

DNA was amplified with the exonic sequence primer (5'-TGGAGACTGGAACACAAC-3') SEQ ID NO:127 and the opposing intronic sequence primer (5'-GTGTGGCCAGGGTAGAGAACT-3') SEQ ID NO:128 using the above reaction conditions except 2.5 mM MgCl₂, and cycle conditions of 94° C. x20 seconds, 58° C. x20 seconds, and 72° C. for 10 seconds). The resultant 216 bp genomic fragment was denatured by 10-fold dilution in 0.4M NaOH, 25 mM EDTA, and was vacuum slot-blotted to duplicate nylon membranes. The end-labelled "wild type" primer (5'-CCATAGCCTGTTTCGTAGC-3') Seq ID NO:131 and the end-labelled "mutant" primer (5'-CCATAGCCTATTTCGTAGC-3') SEQ ID No: 132 were hybridized to separate copies of the slot-blot filters in 5xSSC, 5xDenhardt's, 0.5% SDS for 1 hour at 48° C., and then washed successively in 2xSSC at 23° C. and 2xSSC, 0.1% SDS at 50° C. and then exposed to X-ray film. All testable affected members as well as some at-risk members of the AD3 and NIH2 pedigrees possessed the Cys 410 Tyr mutation. Attempts to detect the Cys 410 Tyr mutation by SSCP revealed that a common intronic sequence polymorphism migrated with the same SSCP pattern.

Example 7

Northern Hybridization Demonstrating the Expression of ARMP (PS1) Protein mRNA in a Variety of Tissues

Total cytoplasmic RNA was isolated from various tissue samples (including heart, brain and different regions of, placenta, lung, liver, skeletal muscle, kidney and pancreas) obtained from surgical pathology using standard procedures such as CsCl purification. The RNA was then electrophoresed on a formaldehyde gel to permit size fractionation. The nitrocellulose membrane was prepared and the RNA was then transferred onto the membrane. ³²P-labelled cDNA probes were prepared and added to the membrane in order for hybridization between the probe the RNA to occur. After washing, the membrane was wrapped in plastic film and placed into imaging cassettes containing X-ray film. The autoradiographs were then allowed to develop for one to several days. Sizing was established by comparison to standard RNA markers. Analysis of the autoradiographs revealed a prominent band at 3.0 kb in size. These northern blots demonstrated that the ARMP gene is expressed in all of the tissues examined.

Example 8

Eukaryotic and Prokaryotic Expression Vector Systems

Constructs suitable for use in eukaryotic and prokaryotic expression systems have been generated using two different classes of ARMP nucleotide cDNA sequence inserts. In the first class, termed full-length constructs, the entire ARMP cDNA sequence is inserted into the expression plasmid in the correct orientation, and includes both the natural 5' UTR and 3' UTR sequences as well as the entire open reading frame. The open reading frames bear a nucleotide sequence cassette which allows either the wild type open reading frame to be included in the expression system or alternatively, single or a combination of double mutations can be inserted into the open reading frame. This was accomplished by removing a restriction fragment from the wild type open reading frame using the enzymes NarI and PflmI and replacing it with a similar fragment generated by reverse transcriptase PCR and bearing the nucleotide sequence encoding either the Met146Leu mutation or the Hys163Arg mutation. A second restriction fragment was removed from the wild type normal nucleotide sequence for the open reading frame by cleavage with the enzymes PflmI and NcoI and replaced with a restriction fragment bearing

the nucleotide sequence encoding the Ala246Glu mutation, the Ala260Val mutation, the Ala285Val mutation, the Leu286Val mutation, the Leu392Val mutation or the Cys410Tyr mutation. A third variant, bearing a combination of either the Met146Leu or His163Arg mutation in tandem with one of the remaining mutations, was made by linking a NarI-PflmI fragment bearing one of the former mutations and a PflmI-NcoI fragment bearing one of the latter mutations.

The second class of cDNA inserts, termed truncated constructs, was constructed by removing the 5' UTR and part of the 3' UTR sequences from full length wild type or mutant cDNA sequences. The 5' UTR sequence was replaced with a synthetic oligonucleotide containing a KpnI restriction site and a Kozak initiation site (oligonucleotide GGTACCGCCACCATGACAGAGGTACCTGCAC, SEQ ID NO:139). The 3' UTR was replaced with an oligonucleotide corresponding to position 2566 of the cDNA and bore an artificial EcoRI site (oligonucleotide GAATTCAGTGGCTGTAGAAAAAGAC, SEQ ID NO:140). Mutant variants of this construct were then made by inserting the mutant sequences described above at the NarI-PflmI and PflmI-NcoI sites as described above.

For eukaryotic expression, these various cDNA constructs bearing wild type and mutant sequences, as described above, were cloned into the expression vector pZeoSV in which the SV60 promoter cassette had been removed by restriction digestion and replaced with the CMV promoter element of pcDNA3 (Invitrogen). For prokaryotic expression, constructs have been made using the glutathione S-transferase (GST) fusion vector pGEX-kg. The inserts which have been attached to the GST fusion nucleotide sequence are the same nucleotide sequences described above (generated with the oligonucleotide primers, SEQ ID NO:139 and SEQ ID NO:140) bearing either the normal open reading frame nucleotide sequence, or bearing a combination of single and double mutations as described above. These GST fusion constructs allow expression of the partial or full-length protein in prokaryotic cell systems as mutant or wild type GST fusion proteins, thus allowing purification of the full-length protein followed by removal of the GST fusion product by thrombin digestion. A further cDNA construct was made with the GST fusion vector, to allow the production of the amino acid sequence corresponding to the hydrophilic acidic loop domain between TM6 and TM7 of the full-length protein, either as a wild type nucleotide sequence or as a mutant sequence bearing either the Ala285Val mutation, the Leu286Val mutation or the Leu392Val mutation. This was accomplished by recovering wild type or mutant sequence from appropriate sources of RNA using the oligonucleotide primers GGATCCGGTCCACTTCGTATGCTG, SEQ ID NO:141, and TTTTTTGAATTCCTTAGGCTATGGTTGTGTTCCA, SEQ ID NO:142 This allowed cloning of the appropriate mutant or wild type nucleotide sequence corresponding to the hydrophilic acidic loop domain at the BamHI and the EcoRI sites within the pGEX-KG vector.

Example 9

Locating Additional Mutations in the ARMP (PS1) Gene

Mutations in the ARMP (PS1) gene can be assayed by a variety of strategies (direct nucleotide sequencing, allele specific oligos, ligation polymerase chain reaction, SSCP, RFLPs) using RT-PCR products representing the mature mRNA/cDNA sequence or genomic DNA. For the A260V and the A285V mutations, genomic DNA carrying the exon can be amplified using the same PCR primers and methods as for the L286V mutation.

PCR products were then denatured and slot blotted to duplicate nylon membranes using the slot blot protocol described for the C410T mutation.

The Ala260Val mutation was scored on these blots by using hybridization with end-labelled allele-specific oligonucleotides corresponding to the wild type sequence (GATTAGTGGTTGTTTGTG) SEQ ID NO:143 or the mutant sequence (GATTAGTGGCTGTTTGTG) SEQ ID NO:144 by hybridization at 48° C. followed by a wash at 52° C. in 3×SSC buffer containing 0.1% SDS. The Ala285Val mutation was scored on these slot blots as described above but using instead the allele-specific oligonucleotides for the wild type sequence (TTTTCCAGCTCTCATTTA) SEQ ID NO:145 or the mutant primer (TTTTCCAGTTCTCATTTA) SEQ ID NO:146 at 48° C. followed by washing at 52° C. as above except that the wash solution was 2×SSC.

The Leu392Val mutation was scored by amplification of the exon from genomic DNA using primers (AAACTTGGATTGGGAGAT) SEQ ID NO:148 and (GTGTGGCCAGGGTAGAGAACT) SEQ ID NO:128 using standard PCR buffer conditions except that the magnesium concentration was 2 mM and cycle conditions were 94° C. time 10 seconds, 56° C. times 20 seconds, and 72° C. for 10 seconds. The resulting 200 base pair genomic fragment was denatured as described for the Cys410Tyr mutation and slot-blotted in duplicate to nylon membranes. The presence or absence of the mutation was then scored by differential hybridization to either a wild type end-labelled oligonucleotide (TACAGTGTTCTGGTTGGTA) SEQ ID NO:147 or with an end-labelled mutant primer (TACAGTGTTGTGGTTGGTA) SEQ ID NO:149 by hybridization at 45° C. and then successive washing in 2×SSC at 23° C. and then at 68° C.

Example 10

Antibody Production

Peptide antigens corresponding to portions of the PS1 protein were synthesized by solid-phase techniques and purified by reverse phase high pressure liquid chromatography. Peptides were covalently linked to keyhole limpet hemocyanin (KLH) via disulfide linkages that were made possible by the addition of a cysteine residue at the peptide C-terminus. This additional residue does not appear normally in the protein sequence and was included only to facilitate linkage to the KLH molecule.

The specific sequences to which antibodies were raised are as follows:

Polyclonal antibody 1142: NDNRRERQEHNDRRSL (C)-residues 30–45 (SEQ ID NO:167);

Polyclonal antibody 519: KDGQLIYTPFTEDTE (C)-residues 109–120 (SEQ ID NO:168);

Polyclonal antibody 520: EAQRRVSKNSKYNAE (C)-residues 304–319 (SEQ ID NO:169);

Polyclonal antibody 1143: SHLGPHRSTPESRAA (C)-residues 346–360 (SEQ ID NO:170).

The non-native cysteine residue is indicated at the C-terminal by (C). These sequences are contained within specific unique domains of the PS1 protein. For example, sequences 167, 169 and 170 are located in potentially functional domains that are exposed to the aqueous media and may be involved in binding to other proteins critical for the development of the disease phenotype. Sequence 168 corresponds to a short linking region situated between the predicted first and second transmembrane helices. The choice of peptides was based on analysis of the protein sequence using the IBI Pustell antigenicity prediction algorithm.

A total of three New Zealand white rabbits were immunized with peptide-KLH complexes for each peptide antigen in combination with Freund's adjuvant and were subsequently given booster injections at seven day intervals. Antisera were collected for each peptide and pooled and IgG precipitated with ammonium sulfate. Antibodies were then affinity purified with Sulfo-link agarose (Pierce) coupled with the appropriate peptide. This final purification is required to remove non-specific interactions of other antibodies present in either the pre- or post-immune serum.

The specificity of each antibody was confirmed by three tests. First, each detected single predominant bands of the approximate size predicted for presenilin I on Western blots of brain homogenate. Second, each cross-reacted with recombinant fusion proteins bearing the appropriate sequence. Third each could be specifically blocked by pre-absorption with recombinant PS1 or the immunizing peptide.

In addition, two different PS1 peptide glutathione S-transferase (GST) fusion proteins have been used to generate PS1 antibodies. The first fusion protein included amino acids 1–81 (N terminus) of PS1 fused to GST. The second fusion protein included amino acids 266–410 (the TM6-TM7 loop domain) of PS1 fused to GST. Constructs encoding these fusion proteins were generated by inserting the appropriate nucleotide sequences into pGEX-2T expression plasmid (Amrad). The resulting constructs included sequences encoding GST and a site for thrombin sensitive cleavage between GST and the PS1 peptide. The expression constructs were transfected into *DH5αE. coli* and expression of the fusion proteins was induced using IPTG. The bacterial pellets were lysed and the soluble GST-fusion proteins were purified by single step affinity chromatography on glutathione sepharose beads (Boehringer-Mannheim, Montreal). The GST-fusion proteins were used to immunize mice to generate monoclonal antibodies using standard procedures. Clones obtained from these mice were screened with purified presenilin fragments.

In addition, the GST-fusion proteins were cleaved with thrombin to release PS1 peptide. The released peptides were purified by size exclusion HPLC and used to immunize rabbits for the generation of polyclonal antisera.

By similar methods, GST fusion proteins were made using constructs including nucleotide sequences for amino acids 1 to 87 (N terminus) or 272 to 390 (TM6→TM7 loop) of presenilin II and employed to generate monoclonal antibodies to that protein. The PS2 GST fusion proteins were also cleaved with thrombin and the released, purified peptides used to immunize rabbits to prepare polyclonal antisera.

Example 11

Identification of Mutations in E5-1 (PS2) Gene

RT-PCR products corresponding to the E5-1 (PS2) ORF were generated from RNA of lymphoblasts or frozen post-mortem brain tissue using oligonucleotide primer pairs 5'-CAGAGGATGGAGAGAATAC (SEQ ID NO:171) and 5'-GGCTCCCCAAACTGTCAT (SEQ ID NO:172) (product=888 bp); and 5'-GCCCTAGTGTTTCATCAAGTA (SEQ ID NO:173) and 5'-AAAGCGGGAGCCAAAGTC (SEQ ID NO:174) (product=826 bp) by PCR using 250 μMol dNTPs, 2.5 mM MgCl₂, 10 pMol oligonucleotides in 10 μl cycled for 40 cycles of 94° C.×20 seconds, 58° C.×20 seconds, 72° C.×45 seconds. The PCR products were sequenced by automated cycle sequencing (ABI, Foster City, A) amid the fluorescent chromatograms were scanned for heterozygous nucleotide substitutions by direct inspection and by the Factura (ver 1.2.0) and Sequence Navigator (ver 1.0.1b 15) software packages (data not shown).

Asn141Ile: The A→T substitution at nucleotide 787 creates a BclI restriction site. The exon bearing this mutation was amplified from 100 ng of genomic DNA using 10 pMol of oligonucleotides 5'-CATTCACTGAGGACACACC (SEQ ID NO:175) (end-labelled) and 5'-TGTAGAGCACCACCAAGA (SEQ ID NO:176) (unlabelled), and PCR reaction conditions similar to those described below for the Met239Val. 2 μl of the PCR product was restricted with BclI (NEBL, Beverly, Mass.) in 10 μl reaction volume according to the manufacturers' protocol, and the products were resolved by non-denaturing polyacrylamide gel electrophoresis. In subjects with wild type sequences, the 114 bp PCR product is cleaved into 68 bp and 46 bp fragments. Mutant sequences cause the product to be cleaved into 53 bp, 46 bp and 15 bp.

Met239Val: The A→G substitution at nucleotide 1080 deletes a NlaIII restriction site, allowing the presence of the Met 239Val mutation to be detected by amplification from 100 ng of genomic DNA using PCR (10 pMol oligonucleotides 5'-GCATGGTGTGCATCCACT (SEQ ID NO:177), 5'-GGACCACTCTGGGAGGTA (SEQ ID NO:178); 0.5 U Taq polymerase, 250 μM dNTPS, 1 μCi alpha ³²P-dCTP, 1.5 mM MgCl₂, 10 μl volume; 30 cycles of 94° C.×30 seconds, 58° C.×20 seconds, 72° C.×20 seconds) to generate a 110 bp product. 2 μl of the PCR reaction were diluted to 10 μl and restricted with 3 U of NlaIII (NEBL, Beverly, Mass.) for 3 hours. The restriction products were resolved by non-denaturing polyacrylamide gel electrophoresis and visualized by autoradiography. Normal subjects show cleavage products of 55, 35, 15 and 6 bp, whereas the mutant sequence gives fragments of 55, 50 and 6 bp.

In accordance with a further embodiment, the Ile 420 Thr mutation is screened for by PCR amplification of genomic DNA using primers 5' TGC TGC TTG CTG TGT TCA 3' (SEQ ID NO:161) and 5' CCA TGT CCC TCA GAT GTA GA 3' (SEQ ID NO:162) to generate a 146 base pair product which can be probed with allele specific oligonucleotides for the wild-type (5' CAT CTC CAT CAC GTT CG 3'; SEQ ID NO:163) and mutant (5' CAT CTC CAC CAC GTT CG 3'; SEQ ID NO:164) sequences.

Example 12

Transgenic Mice

A series of wild type and mutant PS1 and PS2 genes were constructed for use in the preparation of transgenic mice. Mutant versions of PS1 and PS2 were generated by site-directed mutagenesis of the cloned cDNAs CC33 (PS1) and CC32 (PS2) using standard techniques.

cDNAs CC33 and CC32 and their mutant versions were used to prepare two classes of mutant and wild type PS1 and PS2 cDNAs, as described in Example 8. The first class, referred to as "full-length" cDNAs, were prepared by removing approximately 200 bp of the 3' untranslated region immediately before the poly A site by digestion with EcoRI (PS1) or PvuII (PS2). The second class, referred to as "truncated" cDNAs, were prepared by replacing the 5' untranslated region with a ribosome binding site (Kozak consensus sequence) placed immediately 5' of the ATG start codon.

Various full length and truncated wild type and mutant PS1 and PS2 cDNAs, prepared as described above, were introduced into one or more of the following vectors and the resulting constructs were used as a source of gene for the production of transgenic mice.

The cos.TET expression vector: This vector was derived from a cosmid clone containing the Syrian hamster PrP gene. It has been described in detail by Scott et al. (1992) and Hsiao et al. (1995). PS1 and PS2 cDNAs (full length or

truncated) were inserted into this vector at its SalI site. The final constructs contain 20 kB of 5' sequence flanking the inserted cDNA. This 5' flanking sequence includes the PrP gene promoter, 50 bp of a PrP gene 5' untranslated region exon, a splice donor site, a 1 kB intron, and a splice acceptor site located immediately adjacent to the SalI site into which the PS1 or PS2 cDNA was inserted. The 3' sequence flanking the inserted cDNA includes an approximately 8 kB segment of PrP 3' untranslated region including a polyadenylation signal. Digestion of this construct with NotI (PS1) or FseI (PS2) released a fragment containing a mutant or wild type PS gene under the control of the PrP promoter. The released fragment was gel purified and injected into the pronuclei of fertilized mouse eggs using the method of Hsiao et al., 1995 (Table 12).

Platelet-derived growth factor receptor β-subunit constructs: PS cDNAs were also introduced between the SalI (full length PS1 cDNAs) or HindIII (truncated PS1 cDNAs, full length PS2 cDNAs, and truncated PS2 cDNAs) at the 3' end of the human platelet derived growth factor receptor β-subunit promoter and the EcoRI site at the 5' end of the SV40 poly A sequence and the entire cassette was cloned into the pZeoSV vector (Invitrogen, San Diego, Calif.). Fragments released by ScaI/BamHI digestion were gel purified and injected into the pronuclei of fertilized mouse eggs using the method of Hsiao et al. (supra) (Table 12).

Human β-actin constructs: Certain PS1 and PS2 cDNAs were inserted into the SalI site of pBacGH. The construct produced by this insertion includes 3.4 kB of the human β actin 5' flanking sequence (the human β actin promoter, a spliced 78 bp human β actin 5' untranslated exon and intron) and the PS1 or PS2 insert followed by 2.2 kB of human growth hormone genomic sequence containing several introns and exons as well as a polyadenylation signal. SfiI was used to release a PS-containing fragment which was gel purified and injected into the pronuclei of fertilized mouse eggs using the method of Hsiao et al. (supra) (Table 12).

Phosphoglycerate kinase constructs: Certain PS1 and PS2 cDNAs were introduced into the pkJ90 vector. The cDNAs were inserted between the KpnI site downstream of the human phosphoglycerate kinase promoter and the XbaI site upstream of the 3' untranslated region of the human phosphoglycerate kinase gene. PvuII/HindIII (PS1 cDNAs) or PvuII (PS2 cDNAs) digestion was used to release a PS-containing fragment which was then gel purified and injected into the pronuclei of fertilized mouse eggs as described above.

Table 10 includes a summary of the preparation of transgenic mice.

Example 13

Expression of Recombinant PS1 and PS2 in Eukaryotic Cells

Recombinant PS1 and PS2 have been expressed in a variety of cell types (e.g. PC12, neuroblastoma, Chinese hamster ovary, and human embryonic kidney 293 cells) using the pcDNA3 vector (Invitrogen, San Diego, Calif.). The PS1 and PS2 cDNAs inserted into this vector were the same full length and truncated cDNAs described in Example 8.

These cDNAs were inserted between the CMV promoter and the bovine growth hormone polyadenylation site of pcDNA3. The transgenes were expressed at high levels.

In addition, PS1 and PS2 have been expressed in COS cells using the pCMX vector. To facilitate tagging and tracing of the intracellular localization of the presenilin proteins, oligonucleotides encoding an 11 amino acid sequence derived from c-myc (EQKLISEEDLN; SEQ ID

NO:183) and recognized by the monoclonal anti-MYC antibody 9E10.2 (ATCC, Rockville, Md.) were ligated in-frame either immediately in front or immediately behind the open reading frame of PS1 and PS2 cDNAs. Untagged pCMX constructs were also prepared. The c-myc-tagged constructs were also introduced into pcDNA3 for transfection into CHO cells.

Transient and stable transfection of these constructs has been achieved using Lipofectamine (Gibco/BRL) according to the manufacturer's protocols. Cultures were assayed for transient expression after 48 hours. Stably transfected lines were selected using 0.5 mg/ml Geneticin (Gibco/BRL).

Expression of transfected PS proteins was assayed by Western blot using the anti-presenilin antibodies 1142, 519 and 520 described above. Briefly, cultured transfected cells were solubilized (2% SDS, 5 mM EDTA, 1 mg/ml leupeptin and aprotinin), and the protein concentration was determined by Lowry. Proteins were separated on SDS-PAGE gradient gels (4–20% Novex) and transferred to PVDF (10 mM CAPS) for 2 hr at a constant voltage (50V). Non-specific binding was blocked with skim milk (5%) for 1 hr. The proteins were then probed with the two rabbit polyclonal antibodies (~1 mg/ml in TBS, pH 7.4) for 12 hrs. Presenilin cross-reactive species were identified using biotinylated goat-anti rabbit secondary antibody which was visualized using horseradish peroxidase-conjugated streptavidin tertiary, 4-chloro-naphthol, and hydrogen peroxide. The c-myc-tagged presenilin peptides were assayed by Western blotting using both the anti-presenilin antibodies described above (to detect the presenilin peptide antigen), and culture supernatant from the hybridoma MYC1-9E10.2 (ATCC) diluted 1:10 for western blots and 1:3 for immunocytochemistry (to detect the myc-epitope). A major band of immunoreactivity of 50–60 kDa was identified by each of the various presenilin antibodies, and by the myc-epitope antibodies (for cell lines transfected with myc-containing plasmids). Minor bands at ~10–19 kDa and at ~70 kDa were detected by some presenilin antibodies.

For immunocytochemistry, transfected cells were fixed with 4% formaldehyde in TRIS buffered saline (TBS), washed extensively with TBS plus 0.1% Triton and non-specific binding blocked with 3% BSA. Fixed cells were probed with the presenilin antibodies (e.g. LL520 and SNI1142; typically 5–10 mg/ml), washed and visualized with FITC- or rhodamine-conjugated goat-anti rabbit secondary antibody. For c-myc-tagged presenilin constructs, the hybridoma MYC1-9E10.2 (ATCC) supernatant diluted 1:3 was used with anti-mouse secondary antibody. Slides were mounted in 90% glycerol with 0.1% phenylenediamine (ICN) to preserve fluorescence. Anti-BIP (or anti-calnexin) (StressGen, Victoria, B.C.) and wheat germ agglutinin (EY Labs, San Mateo, Calif.) were used as markers of endoplasmic reticulum and Golgi respectively. Double-immunolabelling was also performed with anti-actin (Sigma, St. Louis, Mo.), anti-amyloid precursor protein (22C11, Boehringer Mannheim) and anti-neurofilament (NF-M specific, Sigma) in neuronal line NSC34. These immunofluorescence studies demonstrated that the transfection product is widely distributed within the cell, with a particularly intense perinuclear localization suggestive of endoplasmic reticulum and Golgi, which is similar to that observed in untransfected cells but is more intense, sometimes spilling over into the nuclear membrane. Co-immunolocalization of the c-myc and PS epitopes was observed in CHO and COS cells transiently transfected with the myc-tagged presenilin constructs.

Robust expression of the transfected presenilin gene in the transfected cells was thus proven by immunocytochemistry,

Northern blot, Western blots (using antibodies to presenilins as above, and using the monoclonal antibody MYC1-9E10.2 to the myc-tag in constructs with 3' or 5' c-myc tags).

Example 14

Isolation of Presenilin Binding Proteins by Affinity Chromatography

To identify the proteins which may be involved in the biochemical function of the presenilins, PS1—binding proteins were isolated using affinity chromatography. A GST-fusion protein containing the PS1 TM6-TM7 loop, prepared as described in Example 8, was used to probe human brain extracts, prepared by homogenising brain tissue by Polytron in physiological salt solution. Non-specific binding was eliminated by pre-clearing the brain homogenates of endogenous GST-binding components by incubation with glutathione-Sepharose beads. These GST-free homogenates were then incubated with the GST-PS fusion proteins to produce the desired complexes with functional binding proteins. These complexes were then recovered using the affinity glutathione-Sepharose beads. After extensive washing with phosphate buffered saline, the isolated collection of proteins was separated by SDS-polyacrylamide gel electrophoresis (SDS-PAGE; Tris-tricine gradient gel 4–20%). Two major bands were observed at ~14 and 20 kd in addition to several weaker bands ranging from 50 to 60 kd.

Pharmacologic modification of interaction between these proteins and the TM6-TM7 loop may be employed in the treatment of Alzheimer's Disease. In addition, these proteins which are likely to act within the presenilin biochemical pathway may be novel sites of mutations that cause Alzheimer's Disease.

Example 15

Isolation of Presenilin Binding Proteins by Two-Hybrid Yeast System

To identify proteins interacting with the presenilin proteins, a yeast expression plasmid vector (pAS2-1, Clontech) was generated by ligating an in-frame partial cDNA sequence encoding either residues 266–409 of the PS1 protein or residues 272–390 of the PS2 protein into the EcoR1 and BamHI sites of the vector. The resultant fusion protein contains the GAL4 DNA binding domain coupled in frame either to the TM6-TM7 loop of the PS1 protein or to the TM6-TM7 loop of the PS2 protein. These expression plasmids were co-transformed, along with purified plasmid DNA from the human brain cDNA:pACT library, into yeast using the protocols of the Clontech Matchmaker yeast-two-hybrid kit (Clontech). Yeast clones bearing human brain cDNAs which interact with the TM6-TM7 loop domain were selected by HIS resistance and β gal⁺ activation. The clones were further selected by cyclohexamide sensitivity and the inserts of the human brain cDNAs were isolated by PCR and sequenced. Of 6 million initial transformants, 200 positive clones were obtained after HIS selection, and 42 after β gal⁺ colour selection, carried out in accordance with the manufacturer's protocol for selection of positive colonies. Of these 42 clones there were several (5–8) independent clones representing the genes typified by our clones pslly2h-9, pslly2h-6, and pslly2h-29. This indicates that these interactions are biologically real and reproducible.

Analysis of the sequences of these clones identified the proteins listed in Table 13 as interacting with the TM6-TM7 loop of PS1. The biologic relevance of these interactions is described in the table. The effect of mutations in the PS1 or PS2 gene on these interactions can be studied and, by screening of chemical libraries, drugs which will modify these interactions positively or negatively can be identified.

These compounds are used to screen for effects in AD by analysis of changes in the frequency and/or rate of development of clinical/neuropathologic/biochemical changes of AD in transgenic/homologous recombination animal models or tissue culture models.

Example 16

Transgenic *C. elegans*

Transgenic *C. elegans* were obtained by microinjection of oocytes. The vectors used and the transgenes inserted are shown in Table 11. Transformed animals were detected by assaying expression of human cDNA on northern blots or western blots using human cDNA probe CC32 and antibodies 519, 520 and 1142.

Example 17

Cloning of a *Drosophila melanogaster* homologue, DmPS, for the human presenilin genes

Redundant oligonucleotides 5' ctncngartggacngyctgg (SEQ ID NO:179) and 5' rcangc(agt)atngtngtrttcca (SEQ ID NO:180) were designed from published nucleotide sequence data for highly conserved regions of the presenilin/sel-12 proteins ending/beginning with Trp (e.g. at residues Trp247 and Trp404 in PS1; Trp253 and Trp385 in PS2). These primers were used for RT-PCR (50 μ l volume, 2 mM MgCl₂, 30 cycles of 94° C. \times 30", 57° C. \times 20", 72° C. \times 20") from mRNA from adult and embryonic *D. melanogaster*. The products were then reamplified using cycle conditions of 94° C. \times 1', 59° C. \times 0.5' and 72° C. \times 1' and internal conserved redundant primer 5' tttttctcgagacngcncargaragaaayga (SEQ ID NO:181) and 5' tttttggatcctaraa(agt)atraartcnc (SEQ ID NO:182). The ~600 bp product was cloned into the BamHI and XhoI sites of pBS. These products were sequenced and shown to contain an open reading frame with a putative amino acid sequence highly homologous to that of the human presenilins. This fragment was then used to screen a conventional *D. melanogaster* cDNA library (Stratagene, Calif.) to recover six independent cDNA clones of size ~2–2.5 kb (clones pds8, pds13, pds1, pds3, pds7 and pds14) which were sequenced. The longest ORF encodes a polypeptide of 541 amino acids with 52% identity to the human presenilins.

Although preferred embodiments of the invention have been described herein in detail, it will be understood by those skilled in the art that variations may be made thereto without departing from the spirit of the invention or the scope of the appended claims.

REFERENCES

- Albertsen et al., 1990, *Proc. Natl. Acad. Sci. USA*, v. 87, pp. 4256–4260.
- Altschul et al., 1990, *J. Mol. Biol.*, v. 215, pp. 403–410.
- Bellamne-Chartelot et al., 1992, *Cell*, v. 70, pp. 1059–1068.
- Bergamini, 1991, *Acta Neurol.*, v. 13, pp. 534–538.
- Brand, A. H. & Perrimon, N. (1993), *Development*, v. 118, pp. 401–415.
- Campion et al., (1995), *Hum. Molec. Genet.* (in the press).
- Campos-Ortega, J. A. & Jan, Y. N. (1991), *Ann. Rev. Neurosci.*, v. 14, p. 399.
- Canadian Patent Application No. 2,096,911
- Canadian Patent Application No. 2,071,105
- Chartier-Harlin et al., 1991, *Nature*, v. 353, pp. 844–846.
- Chumakov et al., 1992, *Nature*, v. 359, pp. 380–387.
- Cruts et al., (1995), *Hum. Molec. Genet.*, (in the press).

- Davis, R. L., (1996), *Physiol. Reviews* (in press).
- Foncin et al., 1985, *Rev. Neurol. (Paris)*, v. 141, pp. 194–202.
- Frommelt et al., 1991, *Alzheimer Dis. Assoc. Disorders*, v. 5, pp. 36–43.
- Gandy et al. 1993
- Goate et al., 1991, *Nature*, v. 349, pp. 704–706.
- Goudsmit et al., 1981, *J. Neurol. Sci.*, v. 49, pp. 79–87.
- Gyapay et al., 1994, *Nature Genetics*, v. 7, pp. 246–339.
- Hsiao et al. (1995), *Neuron.*, in press.
- Huang and Chalfie, 1994
- Huang et al. 1993,
- International Patent Application No. WO 94/23049
- International Patent Application No. WO 94/00569
- Ioannu et al., 1994, *Nature Genetics*, v. 6, pp. 84–89.
- Karlinsky et al., 1992, *Neurology*, v. 42, pp. 1445–1453.
- Katzman, 1986, *N. Eng. J. Med.*, v. 314, pp. 964–973.
- Levitan, 1995,
- Levitan et al., (1995), *Nature*, v. 377, pp. 351–354.
- Liu and Sommer 1995, *Biotechniques* in the press.
- Martin et al., (1995), *NeuroReport*, v. 7, in press.
- Mullan et al., 1992, *Nature Genetics*, v. 1, pp. 345–347.
- Murrell et al., 1991, *Science*, v. 254, pp. 97–99.
- Nee et al., 1983, *Arc. Neurol.*, v. 40, pp. 203–208.
- NIH/CEPH Collaborative Mapping Group, 1992, *Science*, v. 258, pp. 67–86.
- Obermeir et al., (1994), *Embo J.*, v. 7, pp. 1585–1590.
- Pericak-Vance et al., 1988, *Exp. Neurol.*, v. 102, pp. 271–279.
- Phizicky et al., (1995), *Microbiol. Reviews*, v. 59, pp. 94–123.
- Phizicky and Fields, 1994,
- Pollen, 1993, Oxford, Oxford University Press.
- Querfurth et al., (1995), *Molec. Brain Res.*, in press.
- Riley et al., 1990, *Nucl. Acid Res.*, v. 18, pp. 2887–2890.
- Rogaev et al., 1993, *Neurology*, v. 43, pp. 2275–2279.
- Rogaev et al., (1995), *Nature*, v. 376, pp. 775–778.
- Rogaev et al., (1995), *Nature*, v. 376, pp. 775–778.
- Rommens et al., 1993, *Hum. Molec. Genet.*, v. 2, pp. 901–907.
- Saleeba and Cotton, 1993, *Methods in Enzymology*, v. 217, pp. 285–295.
- Saunders, A., et al., (1993), *Neurology*, v. 43, pp. 1467–1472/
- Schellenberg et al., 1993, *Am. J. Hum. Genet.*, v. 53, pp. 619–628.
- Schellenberg et al., 1992, *Science*, v. 258, pp. 668–670.
- Scheuner et al. (1995), *Soc. Neurosci. Abstr.*, v. 21, p. 1500.
- Scott et al. (1992),
- Selkoe et al. 1995,
- Selkoe et al, 1994,
- Sherrington et al., 1995, *Nature*, v. 375, pp. 754–760.
- St. George-Hyslop et al., (1990), *Nature*, v. 347, pp. 194–197.
- St. George-Hyslop et al., 1992, *Nature*, v. 347, pp. 194–197.
- St. George-Hyslop et al., (1994), *Science*, v. 263, p. 537.

Strittmatter et al., 1993, *Proc. Natl. Acad. Sci. USA*, v. 90, pp. 1977–1981.
 U.S. Pat. No. 5,297,562
 Van Broeckhoven et al., 1992, *Nature Genetics*, v. 2, pp. 335–339.

Wang, 1992, *Genomics*, v. 13, pp. 532–536.
 Weissenbach et al., 1992, *Nature*, v. 359, pp. 794–798.
 Wong et al., 1993, *Neurosci. Lett.*, v. 152, pp. 96–98.

SEQUENCE LISTING

(1) GENERAL INFORMATION:

(i i i) NUMBER OF SEQUENCES: 183

(2) INFORMATION FOR SEQ ID NO:1:

(i) SEQUENCE CHARACTERISTICS:

- (A) LENGTH: 2791 base pairs
- (B) TYPE: nucleic acid
- (C) STRANDEDNESS: single
- (D) TOPOLOGY: linear

(i i) MOLECULE TYPE: cDNA

(x i) SEQUENCE DESCRIPTION: SEQ ID NO:1:

```

TGGGACAGGC AGCTCCGGGG TCCGCGGTTT CACATCGGAA AAAAAACAGC GGCTGGTCTG      60
GAAGGAACCT GAGCTACGAG CCGCGGCGGC AGCGGGGCGG CGGGGNAAGC GTATACCTAA     120
TCTGGGAGCC TGCAAGTGAC AACAGCCTTT GCGGTCCTTA GACAGCTTGG CCTGGAGGAG     180
AACACATGAA AGAAAGAACC TCAAGAGGCT TTGTTTTCTG TGAAACAGTA TTTCTATACA     240
GTTGCTCCAA TGACAGAGTT ACCTGCACCG TTGTCTACT TCCAGAATGC ACAGATGTCT     300
GAGGACAACC ACCTGAGCAA TACTGTACGT AGCCAGAATG ACAATAGAGA ACGGCAGGAG     360
CACAACGACA GACGGAGCCT TGGCCACCCT GAGCCATTAT CTAATGGACG ACCCCAGGGT     420
AACTCCCGGC AGGTGGTGGA GCAAGATGAG GAAGAAGATG AGGAGCTGAC ATTGAAATAT     480
GGCGCCAAGC ATGTGATCAT GCTCTTTGTC CCTGTGACTC TCTGCATGGT GGTGGTCGTG     540
GCTACCATTA AGTCAGTCAG CTTTTATACC CGGAAGGATG GGCAGCTAAT CTATACCCCA     600
TTCACAGAAG ATACCGAGAC TGTGGGCCAG AGAGCCCTGC ACTCAATTCT GAATGCTGCC     660
ATCATGATCA GTGTCATTGT TGTCATGACT ATCCTCCTGG TGGTTCTGTA TAAATACAGG     720
TGCTATAAGG TCATCCATGC CTGGCTTATT ATATCATCTC TATTGTTGCT GTTCTTTTTT     780
TCATTCATTT ACTTGGGGGA AGTGTTTAAA ACCTATAACG TTGCTGTGGA CTACATTACT     840
GTTGCACTCC TGATCTGGAA TTTGGGTGTG GTGGGAATGA TTTCCATTCA CTGGAAAGGT     900
CCACTTCGAC TCCAGCAGGC ATATCTCATT ATGATTAGTG CCCTCATGGC CCTGGTGTTT     960
ATCAAGTACC TCCCTGAATG GACTGCGTGG CTCATCTTGG CTGTGATTTT AGTATATGAT    1020
TTAGTGGCTG TTTTGTGTCC GAAAGGTCCA CTTCGTATGC TGGTTGAAAC AGCTCAGGAG    1080
AGAAATGAAA CGCTTTTTTC AGCTCTCATT TACTCCTCAA CAATGGTGTG GTTGGTGAAT    1140
ATGGCAGAAG GAGACCCGGA AGCTCAAAGG AGAGTATCCA AAAATTCCAA GTATAATGCA    1200
GAAAGCACAG AAAGGGAGTC ACAAGACACT GTTGCAGAGA ATGATGATGG CGGGTTTCAGT    1260
GAGGAATGGG AAGCCCAGAG GGACAGTCAT CTAGGGCCTC ATCGCTCTAC ACCTGAGTCA    1320
CGAGCTGCTG TCCAGGAACT TTCCAGCAGT ATCCTCGCTG GTGAAGACCC AGAGGAAAGG    1380
GGAGTAAAAC TTGGATTGGG AGATTTTATT TTCTACAGTG TTCTGGTTGG TAAAGCCTCA    1440
GCAACAGCCA GTGGAGACTG GAACACAACC ATAGCCTGTT TCGTAGCCAT ATTAATTGGT    1500
TTGTGCCTTA CATTATTACT CCTTGCCATT TTCAAGAAAG CATTGCCAGC TCTTCCAATC    1560

```

-continued

| | | | | | | |
|------------|-------------|------------|-------------|------------|------------|------|
| TCCATCACCT | TTGGGCTTGT | TTTCTACTTT | GCCACAGATT | ATCTTGTACA | GCCTTTTATG | 1620 |
| GACCAATTAG | CATTCCATCA | ATTTTATATC | TAGCATATTT | GCGGTTAGAA | TCCCATGGAT | 1680 |
| GTTTCTTCTT | TGACTATAAC | CAAATCTGGG | GAGGACAAAG | GTGATTTTCC | TGTGTCCACA | 1740 |
| TCTAACAAAG | TCAAGATTCC | CGGCTGGACT | TTTGCAGCTT | CCTTCCAAGT | CTTCCTGACC | 1800 |
| ACCTTGCACT | ATTGGACTTT | GGAAGGAGGT | GCCTATAGAA | AACGATTTTG | AACATACTTC | 1860 |
| ATCGCAGTGG | ACTGTGTCCT | CGGTGCAGAA | ACTACCAGAT | TTGAGGGACG | AGGTCAAGGA | 1920 |
| GATATGATAG | GCCCCGGAAGT | TGCTGTGCCC | CATCAGCAGC | TTGACGCGTG | GTCACAGGAC | 1980 |
| GATTTCACTG | ACACTGCGAA | CTCTCAGGAC | TACCGGTTAC | CAAGAGGTTA | GGTGAAGTGG | 2040 |
| TTTAAACCAA | ACGGAACTCT | TCATCTTAAA | CTACACGTTG | AAAATCAACC | CAATAATTCT | 2100 |
| GTATTAAGT | AATTCTGAAC | TTTTCAGGAG | GTAAGTGTGAG | GAAGAGCAGG | CACCAGCAGC | 2160 |
| AGAATGGGGA | ATGGAGAGGT | GGGCAGGGGT | TCCAGCTTCC | CTTTGATTTT | TTGCTGCAGA | 2220 |
| CTCATCCTTT | TTAAATGAGA | CTTGTTTTCC | CCTCTCTTTG | AGTCAAGTCA | AATATGTAGA | 2280 |
| TGCCTTTGGC | AATTCTTCTT | CTCAAGCACT | GACACTCATT | ACCGTCTGTG | ATTGCCATTT | 2340 |
| CTTCCCAAGG | CCAGTCTGAA | CCTGAGGTTG | CTTTATCCTA | AAAGTTTTAA | CCTCAGGTTC | 2400 |
| CAAATTCAGT | AAATTTTGGG | AACAGTACAG | CTATTTCTCA | TCAATTCTCT | ATCATGTTGA | 2460 |
| AGTCAAATTT | GGATTTTCCA | CCAAATTCTG | AATTTGTAGA | CATACTTGTA | CGCTCACTTG | 2520 |
| CCCCAGATGC | CTCCTCTGTC | CTCATTCTTC | TCTCCCACAC | AAGCAGTCTT | TTTCTACAGC | 2580 |
| CAGTAAGGCA | GCTCTGTCGT | GGTAGCAGAT | GGTCCCCTT | ATTCTAGGGT | CTTACTCTTT | 2640 |
| GTATGATGAA | AAGAATGTGT | TATGAATCGG | TGCTGTCAGC | CCTGCTGTCA | GACCTTCTTC | 2700 |
| CACAGCAAAT | GAGATGTATG | CCCAAAGCGG | TAGAATTAAA | GAAGAGTAAA | ATGGCTGTTG | 2760 |
| AAGCAAAAAA | AAAAAAAAAA | AAAAAAAAAA | A | | | 2791 |

(2) INFORMATION FOR SEQ ID NO:2:

(i) SEQUENCE CHARACTERISTICS:

- (A) LENGTH: 467 amino acids
- (B) TYPE: amino acid
- (C) STRANDEDNESS: single
- (D) TOPOLOGY: linear

(i i) MOLECULE TYPE: protein

(x i) SEQUENCE DESCRIPTION: SEQ ID NO:2:

| | | | | | | | | | | | | | | | |
|-----|-----|-----|-----|-----|-----|-----|-----|-----|-----|-----|-----|-----|-----|-----|-----|
| Met | Thr | Glu | Leu | Pro | Ala | Pro | Leu | Ser | Tyr | Phe | Gln | Asn | Ala | Gln | Met |
| 1 | | | | 5 | | | | | 10 | | | | | 15 | |
| Ser | Glu | Asp | Asn | His | Leu | Ser | Asn | Thr | Val | Arg | Ser | Gln | Asn | Asp | Asn |
| | | | 20 | | | | | 25 | | | | | 30 | | |
| Arg | Glu | Arg | Gln | Glu | His | Asn | Asp | Arg | Arg | Ser | Leu | Gly | His | Pro | Glu |
| | | 35 | | | | | 40 | | | | | 45 | | | |
| Pro | Leu | Ser | Asn | Gly | Arg | Pro | Gln | Gly | Asn | Ser | Arg | Gln | Val | Val | Glu |
| | 50 | | | | | 55 | | | | | 60 | | | | |
| Gln | Asp | Glu | Glu | Glu | Asp | Glu | Glu | Leu | Thr | Leu | Lys | Tyr | Gly | Ala | Lys |
| 65 | | | | | 70 | | | | | 75 | | | | | 80 |
| His | Val | Ile | Met | Leu | Phe | Val | Pro | Val | Thr | Leu | Cys | Met | Val | Val | Val |
| | | | | 85 | | | | | 90 | | | | | 95 | |
| Val | Ala | Thr | Ile | Lys | Ser | Val | Ser | Phe | Tyr | Thr | Arg | Lys | Asp | Gly | Gln |
| | | | 100 | | | | | 105 | | | | | 110 | | |
| Leu | Ile | Tyr | Thr | Pro | Phe | Thr | Glu | Asp | Thr | Glu | Thr | Val | Gly | Gln | Arg |
| | | 115 | | | | | 120 | | | | | 125 | | | |
| Ala | Leu | His | Ser | Ile | Leu | Asn | Ala | Ala | Ile | Met | Ile | Ser | Val | Ile | Val |

-continued

| 130 | | | | | 135 | | | | | 140 | | | | | |
|------------|------------|------------|------------|------------|------------|------------|------------|------------|------------|------------|------------|------------|------------|-----|------------|
| Val 145 | Met | Thr | Ile | Leu | Leu 150 | Val | Val | Leu | Tyr | Lys 155 | Tyr | Arg | Cys | Tyr | Lys 160 |
| Val | Ile | His | Ala | Trp 165 | Leu | Ile | Ile | Ser | Ser 170 | Leu | Leu | Leu | Leu | Phe | Phe 175 |
| Phe | Ser | Phe | Ile 180 | Tyr | Leu | Gly | Glu | Val 185 | Phe | Lys | Thr | Tyr | Asn 190 | Val | Ala |
| Val | Asp | Tyr 195 | Ile | Thr | Val | Ala | Leu | Leu 200 | Ile | Trp | Asn 205 | Leu | Gly | Val | Val |
| Gly | Met 210 | Ile | Ser | Ile | His | Trp 215 | Lys | Gly | Pro | Leu | Arg 220 | Leu | Gln | Gln | Ala |
| Tyr 225 | Leu | Ile | Met | Ile | Ser 230 | Ala | Leu | Met | Ala | Leu 235 | Val | Phe | Ile | Lys | Tyr 240 |
| Leu | Pro | Glu | Trp | Thr 245 | Ala | Trp | Leu | Ile | Leu | Ala 250 | Val | Ile | Ser | Val | Tyr 255 |
| Asp | Leu | Val | Ala 260 | Val | Leu | Cys | Pro | Lys 265 | Gly | Pro | Leu | Arg | Met 270 | Leu | Val |
| Glu | Thr | Ala 275 | Gln | Glu | Arg | Asn | Glu 280 | Thr | Leu | Phe | Pro | Ala 285 | Leu | Ile | Tyr |
| Ser | Ser 290 | Thr | Met | Val | Trp 295 | Leu | Val | Asn | Met | Ala | Glu 300 | Gly | Asp | Pro | Glu |
| Ala 305 | Gln | Arg | Arg | Val | Ser 310 | Lys | Asn | Ser | Lys | Tyr 315 | Asn | Ala | Glu | Ser | Thr 320 |
| Glu | Arg | Glu | Ser | Gln 325 | Asp | Thr | Val | Ala | Glu 330 | Asn | Asp | Asp | Gly | Gly | Phe 335 |
| Ser | Glu | Glu | Trp 340 | Glu | Ala | Gln | Arg | Asp 345 | Ser | His | Leu | Gly | Pro 350 | His | Arg |
| Ser | Thr | Pro 355 | Glu | Ser | Arg | Ala | Ala 360 | Val | Gln | Glu | Leu | Ser 365 | Ser | Ser | Ile |
| Leu | Ala 370 | Gly | Glu | Asp | Pro | Glu | Glu 375 | Arg | Gly | Val | Lys 380 | Leu | Gly | Leu | Gly |
| Asp 385 | Phe | Ile | Phe | Tyr | Ser 390 | Val | Leu | Val | Gly | Lys 395 | Ala | Ser | Ala | Thr | Ala 400 |
| Ser | Gly | Asp | Trp | Asn 405 | Thr | Thr | Ile | Ala | Cys 410 | Phe | Val | Ala | Ile | Leu | Ile 415 |
| Gly | Leu | Cys | Leu 420 | Thr | Leu | Leu | Leu 425 | Leu | Ala | Ile | Phe | Lys | Lys 430 | Ala | Leu |
| Pro | Ala | Leu 435 | Pro | Ile | Ser | Ile | Thr 440 | Phe | Gly | Leu | Val | Phe 445 | Tyr | Phe | Ala |
| Thr | Asp 450 | Tyr | Leu | Val | Gln | Pro 455 | Phe | Met | Asp | Gln | Leu 460 | Ala | Phe | His | Gln |
| Phe 465 | Tyr | Ile | | | | | | | | | | | | | |

(2) INFORMATION FOR SEQ ID NO:3:

- (i) SEQUENCE CHARACTERISTICS:
 (A) LENGTH: 1929 base pairs
 (B) TYPE: nucleic acid
 (C) STRANDEDNESS: single
 (D) TOPOLOGY: linear

(i i) MOLECULE TYPE: cDNA

(x i) SEQUENCE DESCRIPTION: SEQ ID NO:3:

ACCANACANC GGCAGCTGAG GCGGAAACCT AGGCTGCGAG CCGGCCGCC GGGCGCGGAG

60

-continued

| | | | | | | |
|-------------|-------------|------------|------------|------------|-------------|---------|
| AGAGAAGGAA | CCAACACAAG | ACAGCAGCCC | TTCGAGGTCT | TTAGGCAGCT | TGGAGGAGAA | 1 2 0 |
| CACATGAGAG | AAAGAATCCC | AAGAGGTTTT | GTTTTCTTTG | AGAAGGTATT | TCTGTCCAGC | 1 8 0 |
| TGCTCCAATG | ACAGAGATAC | CTGCACCTTT | GTCCTACTTC | CAGAATGCCC | AGATGTCTGA | 2 4 0 |
| GGACAGCCAC | TCCAGCAGCG | CCATCCGGAG | CCAGAATGAC | AGCCAAGAAC | GGCAGCAGCA | 3 0 0 |
| GCATGACAGG | CAGAGACTTG | ACAACCCTGA | GCCAATATCT | AATGGGCGGC | CCCAGAGTAA | 3 6 0 |
| CTCAAGACAG | GTGGTGGAAAC | AAGATGAGGA | GGAAGACGAA | GAGCTGACAT | TGAAATATGG | 4 2 0 |
| AGCCAAGCAT | GTCATCATGC | TCTTTGTCCC | CGTGACCCTC | TGCATGGTCG | TCGTCTGTGGC | 4 8 0 |
| CACCATCAAA | TCAGTCAGCT | TCTATACCCG | GAAGGACGGT | CAGCTAATCT | ACACCCCAT | 5 4 0 |
| CACAGAAGAC | ACTGAGACTG | TAGGCCAAAG | AGCCCTGCAC | TCGATCCTGA | ATGCGGCCAT | 6 0 0 |
| CATGATCAGT | GTCATTGTCA | TTATGACCAT | CCTCCTGGTG | GTCCTGTATA | AATACAGGTG | 6 6 0 |
| CTACAAGGTC | ATCCACGCCT | GGCTTATTAT | TTCATCTCTG | TTGTTGCTGT | TCTTTTTTTC | 7 2 0 |
| GTTCAATTTAC | TTAGGGGAAG | TATTTAAGAC | CTACAATGTC | KCCGTGGACT | ACGTTACAGT | 7 8 0 |
| AGCACTCCTA | ATCTGGAATT | GGGGTGTGGT | CGGGATGATT | GCCATCCACT | GGAAAGGCC | 8 4 0 |
| CCTTCGACTG | CAGCAGGCGT | ATCTCATTAT | GATCAGTGCC | CTCATGGCCC | TGGTATTTAT | 9 0 0 |
| CAAGTACCTC | CCCGAATGGA | CCGCATGGCT | CATCTTGGCT | GTGATTTTCA | TATATGATTT | 9 6 0 |
| GGTGGCTGTT | TTATGTCCCA | AAGGCCCACT | TCGTATGCTG | GTTGAAACAG | CTCAGGAAAG | 1 0 2 0 |
| AAATGAGACT | CTCTTTCCAG | CTCTTATCTA | TTCCTCAACA | ATGGTGTGGT | TGGTGAATAT | 1 0 8 0 |
| GGCTGAAGGA | GACCCAGAAG | CCCAAAGGAG | GGTACCCAAG | AACCCCAAGT | ATAACACACA | 1 1 4 0 |
| AAGAGCGGAG | AGAGAGACAC | AGGACAGTGG | TTCTGGGAAC | GATGATGGTG | GCTTCAGTGA | 1 2 0 0 |
| GGAGTGGGAG | GCCCAAAGAG | ACAGTCACCT | GGGGCCTCAT | CGCTCCACTC | CCGAGTCAAG | 1 2 6 0 |
| AGCTGCTGTC | CAGGAACTTT | CTGGGAGCAT | TCTAACGAGT | GAAGACCCGG | AGGAAAGAGG | 1 3 2 0 |
| AGTAAAACCT | GGACTGGGAG | ATTTTATTTT | CTACAGTGTT | CTGGTTGGTA | AGGCCTCAGC | 1 3 8 0 |
| AACCGCCAGT | GGAGACTGGA | ACACAACCAT | AGCCTGCTTK | GTAGCCATAC | TGATCGGCCT | 1 4 4 0 |
| GTGCCTTANA | TTACTCCTGC | TCGCCATTTA | CAAGAAAGGG | TNGCCAGCCC | NCCCCATCTC | 1 5 0 0 |
| CATCACCTTC | GGGTTCGTGT | TCTNCTTCGC | CACGGATTAC | CTTGTGCAGC | CCTTCATGGA | 1 5 6 0 |
| CCAACTTGCA | TTCCATCAGT | TTTATATCTA | GCCTTTCTGC | AGTTAGAACA | TGGATGTTTC | 1 6 2 0 |
| TTCTTTGATT | ATCAAAAACA | CAAAAACAGA | GAGCAAGCCC | GAGGAGGAGA | CTGGTGACTT | 1 6 8 0 |
| TCCTGTGTCC | TCAGCTAACA | AAGGCAGGAC | TCCAGCTGGA | CTTCTGCAGC | TTCCTTCCGA | 1 7 4 0 |
| GTCTCCCTAG | CCACCCGCAC | TACTGGACTG | TGGAAGGAAG | CGTCTACAGA | GGAACGGTTT | 1 8 0 0 |
| CCAACATCCA | TCGCTGCAGC | AGACGGTGTC | CCTCAGTGAC | TTGAGAGACA | AGGACAAGGA | 1 8 6 0 |
| AATGTGCTGG | GCCAAGGAGC | TGCCGTGCTC | TGCTAGCTTT | GGMCCGTGGG | CATGGAGATT | 1 9 2 0 |
| TACCCGCAC | | | | | | 1 9 2 9 |

(2) INFORMATION FOR SEQ ID NO:4:

- (i) SEQUENCE CHARACTERISTICS:
 (A) LENGTH: 467 amino acids
 (B) TYPE: amino acid
 (C) STRANDEDNESS: single
 (D) TOPOLOGY: linear

(i i) MOLECULE TYPE: protein

(x i) SEQUENCE DESCRIPTION: SEQ ID NO:4:

Met Thr Glu Ile Pro Ala Pro Leu Ser Tyr Phe Gln Asn Ala Gln Met
 1 5 10 15

-continued

| | | | | | | | | | | | | | | | |
|------------|------------|------------|------------|------------|------------|------------|------------|------------|------------|------------|------------|------------|------------|------------|------------|
| Ser | Glu | Asp | Ser 20 | His | Ser | Ser | Ser | Ala 25 | Ile | Arg | Ser | Gln | Asn 30 | Asp | Ser |
| Gln | Glu | Arg 35 | Gln | Gln | Gln | His | Asp 40 | Arg | Gln | Arg | Leu | Asp 45 | Asn | Pro | Glu |
| Pro | Ile 50 | Ser | Asn | Gly | Arg | Pro 55 | Gln | Ser | Asn | Ser | Arg 60 | Gln | Val | Val | Glu |
| Gln | Asp | Glu | Glu | Glu | Asp 70 | Glu | Glu | Leu | Thr | Leu 75 | Lys | Tyr | Gly | Ala | Lys 80 |
| His | Val | Ile | Met | Leu 85 | Phe | Val | Pro | Val | Thr 90 | Leu | Cys | Met | Val | Val 95 | Val |
| Val | Ala | Thr | Ile 100 | Lys | Ser | Val | Ser | Phe 105 | Tyr | Thr | Arg | Lys | Asp 110 | Gly | Gln |
| Leu | Ile | Tyr 115 | Thr | Pro | Phe | Thr | Glu 120 | Asp | Thr | Glu | Thr | Val 125 | Gly | Gln | Arg |
| Ala | Leu 130 | His | Ser | Ile | Leu | Asn 135 | Ala | Ala | Ile | Met | Ile 140 | Ser | Val | Ile | Val |
| Ile 145 | Met | Thr | Ile | Leu | Leu 150 | Val | Val | Leu | Tyr | Lys 155 | Tyr | Arg | Cys | Tyr | Lys 160 |
| Val | Ile | His | Ala | Trp 165 | Leu | Ile | Ile | Ser | Ser 170 | Leu | Leu | Leu | Leu | Phe 175 | Phe |
| Phe | Ser | Phe | Ile 180 | Tyr | Leu | Gly | Glu | Val 185 | Phe | Lys | Thr | Tyr | Asn 190 | Val | Xaa |
| Val | Asp | Tyr 195 | Val | Thr | Val | Ala | Leu 200 | Leu | Ile | Trp | Asn | Trp 205 | Gly | Val | Val |
| Gly | Met 210 | Ile | Ala | Ile | His | Trp 215 | Lys | Gly | Pro | Leu | Arg 220 | Leu | Gln | Gln | Ala |
| Tyr 225 | Leu | Ile | Met | Ile | Ser 230 | Ala | Leu | Met | Ala | Leu 235 | Val | Phe | Ile | Lys | Tyr 240 |
| Leu | Pro | Glu | Trp | Thr 245 | Ala | Trp | Leu | Ile | Leu 250 | Ala | Val | Ile | Ser | Val 255 | Tyr |
| Asp | Leu | Val | Ala 260 | Val | Leu | Cys | Pro | Lys 265 | Gly | Pro | Leu | Arg | Met 270 | Leu | Val |
| Glu | Thr | Ala 275 | Gln | Glu | Arg | Asn | Glu 280 | Thr | Leu | Phe | Pro | Ala 285 | Leu | Ile | Tyr |
| Ser | Ser 290 | Thr | Met | Val | Trp | Leu 295 | Val | Asn | Met | Ala | Glu 300 | Gly | Asp | Pro | Glu |
| Ala 305 | Gln | Arg | Arg | Val | Pro 310 | Lys | Asn | Pro | Lys | Tyr 315 | Asn | Thr | Gln | Arg | Ala 320 |
| Glu | Arg | Glu | Thr | Gln 325 | Asp | Ser | Gly | Ser | Gly 330 | Asn | Asp | Asp | Gly | Gly 335 | Phe |
| Ser | Glu | Glu | Trp 340 | Glu | Ala | Gln | Arg | Asp 345 | Ser | His | Leu | Gly | Pro 350 | His | Arg |
| Ser | Thr 355 | Pro | Glu | Ser | Arg | Ala | Ala 360 | Val | Gln | Glu | Leu | Ser 365 | Gly | Ser | Ile |
| Leu | Thr 370 | Ser | Glu | Asp | Pro | Glu 375 | Glu | Arg | Gly | Val | Lys 380 | Leu | Gly | Leu | Gly |
| Asp 385 | Phe | Ile | Phe | Tyr | Ser 390 | Val | Leu | Val | Gly | Lys 395 | Ala | Ser | Ala | Thr | Ala 400 |
| Ser | Gly | Asp | Trp | Asn 405 | Thr | Thr | Ile | Ala | Cys 410 | Xaa | Val | Ala | Ile | Leu 415 | Ile |
| Gly | Leu | Cys | Leu 420 | Xaa | Leu | Leu | Leu | Leu 425 | Ala | Ile | Tyr | Lys | Lys 430 | Gly | Xaa |
| Pro | Ala | Xaa 435 | Pro | Ile | Ser | Ile | Thr 440 | Phe | Gly | Phe | Val | Phe 445 | Xaa | Phe | Ala |

-continued

| | | | | | | | | | | | | | | | |
|-----|-----|-----|-----|-----|-----|-----|-----|-----|-----|-----|-----|-----|-----|-----|-----|
| Thr | Asp | Tyr | Leu | Val | Gln | Pro | Phe | Met | Asp | Gln | Leu | Ala | Phe | His | Gln |
| | 450 | | | | | 455 | | | | | 460 | | | | |
| Phe | Tyr | Ile | | | | | | | | | | | | | |
| 465 | | | | | | | | | | | | | | | |

(2) INFORMATION FOR SEQ ID NO:5:

- (i) SEQUENCE CHARACTERISTICS:
 (A) LENGTH: 3087 base pairs
 (B) TYPE: nucleic acid
 (C) STRANDEDNESS: single
 (D) TOPOLOGY: linear

(i i) MOLECULE TYPE: cDNA

(x i) SEQUENCE DESCRIPTION: SEQ ID NO:5:

```

GAATTCGGCA CGAGGGAAAT GCTGTTTGCT CGAAGACGTC TCAGGGCGCA GGTGCCTTGG      60
GCCGGGATTA GTAGCCGTCT GAACTGGAGT GGAGTAGGAG AAAGAGGAAG CGTCTTGGGC      120
TGGGTCTGCT TGAGCAACTG GTGAAACTCC GCGCCTCACG CCCCGGGTGT GTCCTTGTCC      180
AGGGGCGACG AGCATTCTGG GCGAAGTCCG CACSCCTCTT GTTCGAGGCG GAAGACGGGG      240
TCTGATSCTT TCTCCTTGGT CGGGMCTGTC TCGAGGCATG CATGTCCAGT GACTCTTGTG      300
TTTGCTGCTG CTTCCCTCTC AGATTCTTCT CACCGTTGTG GTCAGCTCTG CTTTAGGCAN      360
TATTAATCCA TAGTGGAGGC TGGGATGGGT GAGAGAATTG AGGTGACTTT TCCATAATTC      420
AGACCTAATC TGGGAGCCTG CAAGTGACAA CAGCCTTTGC GGTCCTTAGA CAGCTTGGCC      480
TGGAGGAGAA CACATGAAAG AAAGAACCTC AAGAGGCTTT GTTTTCTGTG AAACAGTATT      540
TCTATACAGT TGCTCCAATG ACAGAGTTAC CTGCACCGTT GTCCTACTTC CAGAATGCAC      600
AGATGTCTGA GGACAACCAC CTGAGCAATA CTAATGACAA TAGAGAACGG CAGGAGCACA      660
ACGACAGACG GAGCCTTGGC CACCCTGAGC CATTATCTAA TGGACGACCC CAGGGTAACT      720
CCCGGCAGGT GGTGGAGCAA GATGAGGAAG AAGATGAGGA GCTGACATTG AAATATGGCG      780
CCAAGCATGT GATCATGCTC TTTGTCCCTG TGA CTCTCTG CATGGTGGTG GTCGTGGCTA      840
CCATTAAGTC AGTCAGCTTT TATACCCGGA AGGATGGGCA GCTAATCTAT ACCCCATTCA      900
CAGAAGATAC CGAGACTGTG GGCCAGAGAG CCCTGCACTC AATTCTGAAT GCTGCCATCA      960
TGATCAGTGT CATTGTTGTC ATGACTATCC TCCTGGTGGT TCTGTATAAA TACAGGTGCT     1020
ATAAGGTCAT CCATGCCTGG CTTATTATAT CATCTCTATT GTTGCTGTTC TTTTTTTCAT     1080
TCATTTACTT GGGGGAAGTG TTTAAAACCT ATAACGTTGC TGTGGACTAC ATTACTGTTG     1140
CACTCCTGAT CTGGAATTTG GGTGTGGTGG GAATGATTTT CATTCACTGG AAAGGTCCAC     1200
TTCGACTCCA GCAGGCATAT CTCATTATGA TTAGTGCCCT CATGGCCCTG GTGTTTATCA     1260
AGTACCTCCC TGAATGGACT GCGTGGCTCA TCTTGGCTGT GATTTTCAGTA TATGATTTAG     1320
TGGCTGTTTT GTGTCCGAAA GGTCCACTTC GTATGCTGGT TGAAACAGCT CAGGAGAGAA     1380
ATGAAACGCT TTTTCCAGCT CTCATTTACT CCTCAACAAT GGTGTGGTTG GTGAATATGG     1440
CAGAAGGAGA CCCGGAAGCT CAAAGGAGAG TATCCAAAAA TTCCAAGTAT AATGCAGAAA     1500
GCACAGAAAG GGAGTCACAA GACACTGTTG CAGAGAATGA TGATGGCGGG TTCAGTGAGG     1560
AATGGGAAGC CCAGAGGGAC AGTCATCTAG GGCCTCATCG CTCTACACCT GAGTCACGAG     1620
CTGCTGTCCA GGAAC TTTCC AGCAGTATCC TCGCTGGTGA AGACCCAGAG GAAAGGGGAG     1680
TAAAAC TTGG ATTGGGAGAT TTCATTTTCT ACAGTGTTCT GGTTGGTAAA GCCTCAGCAA     1740
CAGCCAGTGG AGACTGGAAC ACAACCATAG CCTGTTTCGT AGCCATATTA ATTGGTTTGT     1800

```

-continued

| | | | | | | |
|------------|------------|-------------|------------|------------|------------|------|
| GCCTTACATT | ATTACTCCTT | GCCATTTTCA | AGAAAGCATT | GCCAGCTCTT | CCAATCTCCA | 1860 |
| TCACCTTTGG | GCTTGTTTTT | TACTTTGCCA | CAGATTATCT | TGTACAGCCT | TTTATGGACC | 1920 |
| AATTAGCATT | CCATCAATTT | TATATCTAGC | ATATTTGCGG | TTAGAATCCC | ATGGATGTTT | 1980 |
| CTTCTTTGAC | TATAACCAAA | TCTGGGGGAGG | ACAAAGGTGA | TTTTCTGTG | TCCACATCTA | 2040 |
| ACAAAGTCAA | GATTCCCAGG | TGGACTTTTG | CAGCTTCCTT | CCAAGTCTTC | CTGACCACCT | 2100 |
| TGCACTATTG | GACTTTGGAA | GGAGGTGCCT | ATAGAAAACG | ATTTTGAACA | TACTTCATCG | 2160 |
| CAGTGGACTG | TGTCCTCGGT | GCAGAAACTA | CCAGATTTGA | GGGACGAGGT | CAAGGAGATA | 2220 |
| TGATAGGCC | GGAAGTTGCT | GTGCCCCATC | AGCAGCTTGA | CGCGTGGTCA | CAGGACGATT | 2280 |
| TCACTGACAC | TGCGAACTCT | CAGGACTACC | GGTTACCAAG | AGGTTAGGTG | AAGTGGTTTA | 2340 |
| AACCAAACGG | AACTCTTCAT | CTTAAACTAC | ACGTTGAAAA | TCAACCCAAT | AATTCTGTAT | 2400 |
| TAACTGAATT | CTGAACTTTT | CAGGAGGTAC | TGTGAGGAAG | AGCAGGCACC | AGCAGCAGAA | 2460 |
| TGGGGAATGG | AGAGGTGGGC | AGGGGTTC | GCTTCCCTTT | GATTTTTTGC | TGCAGACTCA | 2520 |
| TCCTTTTTAA | ATGAGACTTG | TTTTCCCCTC | TCTTTGAGTC | AAGTCAAATA | TGTAGATGCC | 2580 |
| TTTGGCAATT | CTTCTTCTCA | AGCACTGACA | CTCATTACCG | TCTGTGATTG | CCATTTCTTC | 2640 |
| CCAAGGCCAG | TCTGAACCTG | AGGTTGCTTT | ATCCTAAAAG | TTTTAACCTC | AGGTTCCAAA | 2700 |
| TTCAGTAAAT | TTTGGAAACA | GTACAGCTAT | TTCTCATCAA | TTCTCTATCA | TGTTGAAGTC | 2760 |
| AAATTTGGAT | TTTCCACCAA | ATTCTGAATT | TGTAGACATA | CTTGTACGCT | CACTTGCCCC | 2820 |
| AGATGCCTCC | TCTGTCCTCA | TTCTTCTCTC | CCACACAAGC | AGTCTTTTTT | TACAGCCAGT | 2880 |
| AAGGCAGCTC | TGTCGTGGTA | GCAGATGGTC | CCACTTATTC | TAGGGTCTTA | CTCTTTGTAT | 2940 |
| GATGAAAAGA | ATGTGTTATG | AATCGGTGCT | GTCAGCCCTG | CTGTCAGACC | TTCTTCCACA | 3000 |
| GCAAATGAGA | TGTATGCCCA | AAGCGGTAGA | ATTAAAGAAG | AGTAAAATGG | CTGTTGAAGC | 3060 |
| AAAAAAAAAA | AAAAAAAAAA | AAAAAAA | | | | 3087 |

(2) INFORMATION FOR SEQ ID NO:6:

- (i) SEQUENCE CHARACTERISTICS:
 - (A) LENGTH: 945 base pairs
 - (B) TYPE: nucleic acid
 - (C) STRANDEDNESS: single
 - (D) TOPOLOGY: linear

(i i) MOLECULE TYPE: cDNA

(x i) SEQUENCE DESCRIPTION: SEQ ID NO:6:

| | | | | | | |
|------------|-------------|------------|------------|-------------|------------|-----|
| GTTNTCCNAA | CCAACCTTAGG | AGNTTGGACC | TGGGRAAGAC | CNACNTGATC | TCCGGGAGGN | 60 |
| AAAGACTNCA | GTTGAGCCGT | GATTGCACCC | ACTTTACTCC | AAGCCTGGGC | AACCAAAATG | 120 |
| AGACACTGGC | TCCAAACACA | AAAACAAAAA | CAAAAAAAGA | GTAAATTAAT | TTANAGGGAA | 180 |
| GNATTAAATA | AATAATAGCA | CAGTTGATAT | AGGTTATGGT | AAAATTATAA | AGGTGGGANA | 240 |
| TTAATATCTA | ATGTTTGGGA | GCCATCACAT | TATTCTAAAT | AATGTTTTGG | TGGAAATTAT | 300 |
| TGTACATCTT | TTAAAATCTG | TGTAATTTTT | TTTCAGGGAA | GTGTTTAAAA | CCTATAACGT | 360 |
| TGCTGTGGAC | TACATTACTG | TTNCACTCCT | GATCTGGAAT | TTTGGTGTGG | TGGGAATGAT | 420 |
| TTCCATTAC | TGGAAAGGTC | CACTTCGACT | CCAGCAGGCA | TATCTCATT | TGATTAGTGC | 480 |
| CCTCATGNCC | CTGKTGTTTA | TCAAGTACCT | CCCTGAATGG | ACTGNGTGGC | TCATCTTGGC | 540 |
| TGTGATTTCA | GTATATGGTA | AAACCCAAGA | CTGATAATTT | GTTTGTCA | GGAATGCCCC | 600 |
| ACTGGAGTGT | TTTCTTTCCT | CATCTCTTTA | TCTTGATTTA | GAGAAAATGG | TAACGTGTAC | 660 |
| ATCCCATAAC | TCTTCAGTAA | ATCATTAAAT | AGCTATAGTA | ACTTTTTTCAT | TTGAAGATTT | 720 |

-continued

| | | | | | | |
|------------|------------|------------|------------|------------|------------|-----|
| CGGCTGGGCA | TGGTAGCTCA | TGCCTGTAAT | CTTAGCACTT | TGGGAGGCTG | AGGCGGGCAG | 780 |
| ATCACCTAAG | CCCAGAGTTC | AAGACCAGCC | TGGGCAACAT | GGCAAAACCT | CGTATCTACA | 840 |
| GAAAATACAA | AAATTAGCCG | GGCATGGTGG | TGCACACCTG | TAGTTCCAGC | TACTTAGGAG | 900 |
| GCTGAGGTGG | GAGGATCGAT | TGATCCCAGG | AGGTCAAGNC | TGCAG | | 945 |

(2) INFORMATION FOR SEQ ID NO:7:

- (i) SEQUENCE CHARACTERISTICS:
 - (A) LENGTH: 450 base pairs
 - (B) TYPE: nucleic acid
 - (C) STRANDEDNESS: single
 - (D) TOPOLOGY: linear

(i i) MOLECULE TYPE: cDNA

(x i) SEQUENCE DESCRIPTION: SEQ ID NO:7:

| | | | | | | |
|------------|------------|------------|------------|------------|------------|-----|
| GTTGCAAAGT | CATGGATTCC | TTTAGGTAGC | TACATTATCA | ACCTTTTTGA | GAATAAAATG | 60 |
| AATTGAGAGT | GTTACAGTCT | AATTCTATAT | CACATGTAAC | TTTTATTTGG | ATATATCAGT | 120 |
| AATAGTGCTT | TTTTTTTTTT | TTTTTTTTTT | TTTTTTTTTT | TTTGGGGANA | GAGTCTCGCT | 180 |
| CTGTCGCCAG | GTTGGAGTGC | AATGGTGCGA | TCTTGGCTCA | CTGAAAGCTC | CACCNCCCGG | 240 |
| GTTCAAGTGA | TTCTCCTGCC | TCAGCCNCCC | AAGTAGNTGG | GACTACAGGG | GTGCGCCACC | 300 |
| ACGCCTGGGA | TAATTTTGGG | NTTTTLAGTA | GAGATGGCGT | TTCACCANCT | TGGNGCAGGC | 360 |
| TGGTCTTGGA | ACTCCTGANA | TCATGATCTG | CCTGCCTTAG | CCTCCCCAAA | GTGCTGGGAT | 420 |
| TNCAGGGGTG | AGCCTGTT | CCTGGGCCTC | | | | 450 |

(2) INFORMATION FOR SEQ ID NO:8:

- (i) SEQUENCE CHARACTERISTICS:
 - (A) LENGTH: 516 base pairs
 - (B) TYPE: nucleic acid
 - (C) STRANDEDNESS: single
 - (D) TOPOLOGY: linear

(i i) MOLECULE TYPE: cDNA

(x i) SEQUENCE DESCRIPTION: SEQ ID NO:8:

| | | | | | | |
|------------|------------|------------|------------|------------|------------|-----|
| GCTCATCATG | CTTCACGGGG | GAGGCTGTGC | GGGAAGAATG | CTCCCACACA | GNATAAAGAA | 60 |
| TGCTCCCGCA | CAGGATAGAG | AATGCCCCCG | CACAGCATAG | AGAAGCCCCC | GCACAGCATA | 120 |
| GAGAAATGCC | CCNCACAGCA | TAGAGAAGCC | CCCGCACAGC | ATAGAGAATG | CTCTTCACCT | 180 |
| CTGGGTTTTT | AACCAGCCAA | ACTAAAATCA | CAGAGGSCMA | CACATCATTT | AAGATAGAAA | 240 |
| TTTCTGTATC | TTTTAATTTY | TTTCMAAGTA | GTTTTACTTA | TTTTCAGATT | CTATTTCTTT | 300 |
| ACTAGAATTA | AGGGATAAAA | TAACAATGTG | TGCATAATGA | ACCCTATGAA | ACMAACMMAA | 360 |
| GCTAGGTTTT | TTTCATAGST | CTTCTTCCAG | ATTGAATGAA | CGTCTGTTCT | AAAATTTAAC | 420 |
| CCCCCAGGGA | AATATTCAGT | TAACTATGTT | AAAAACCCAG | ACTTGTGATT | GAGTTTTGCC | 480 |
| TGAAAATGCT | TTCATAATTA | TGTGTGAATG | TGTGTC | | | 516 |

(2) INFORMATION FOR SEQ ID NO:9:

- (i) SEQUENCE CHARACTERISTICS:
 - (A) LENGTH: 1726 base pairs
 - (B) TYPE: nucleic acid
 - (C) STRANDEDNESS: single
 - (D) TOPOLOGY: linear

(i i) MOLECULE TYPE: cDNA

-continued

(x i) SEQUENCE DESCRIPTION: SEQ ID NO:9:

| | | | | | | |
|-------------|------------|------------|-------------|------------|-------------|------|
| GGATCCCTCC | CCTTTTTAGA | CCATACAAGG | TAACTTCCGG | ACGTTGCCAT | GGCATCTGTA | 60 |
| AACTGTCATG | GTGTTGGCGG | GGAGTGTCTT | TTAGCATGCT | AATGTATTAT | AATTAGCGTA | 120 |
| TAGTGAGCAG | TGAGGATAAC | CAGAGGTCAC | TCTCCTCACC | ATCTTGGTTT | TGGTGGGTTT | 180 |
| TGGCCAGCTT | CTTTATTGCA | ACCAGTTTTA | TCAGCAAGAT | CTTTATGAGC | TGTATCTTGT | 240 |
| GCTGACTTCC | TATCTCATCC | CGNAACTAAG | AGTACCTAAC | CTCCTGCAAA | TTGMAGNCCA | 300 |
| GNAGGTCTTG | GNCTTATTTN | ACCCAGCCCC | TATTCAARAT | AGAGTNGYTC | TTGGNCCAAA | 360 |
| CGCCYCTGAC | ACAAGGATTT | TAAAGTCTTA | TTAATTAAGG | TAAGATAGKT | CCTTGSATAT | 420 |
| GTGGTCTGAA | ATCACAGAAA | GCTGAATTTG | GAAAAAGGTG | CTTGGASCTG | CAGCCAGTAA | 480 |
| ACAAGTTTTTC | ATGCAGGTGT | CAGTATTTAA | GGTACATCTC | AAAGGATAAG | TACAATTGTG | 540 |
| TATGTTGGGA | TGAACAGAGA | GAATGGAGCA | ANCCAAGACC | CAGGTAAAAG | AGAGGACCTG | 600 |
| AATGCCTTCA | GTGAACAATG | ATAGATAATC | TAGACTTTTTA | AACTGCATAC | TTCCTGTACA | 660 |
| TTGTTTTTTTC | TTGCTTCAGG | TTTTTAGAAC | TCATAGTGAC | GGGTCTGTTG | TTAATCCCAG | 720 |
| GTCTAACCGT | TACCTTGATT | CTGCTGAGAA | TCTGATTTAC | TGAAAATGTT | TTTCTTGTGC | 780 |
| TTATAGAATG | ACAATAGAGA | ACGGCAGGAG | CACAACGACA | GACGGAGCCT | TGGCCACCCT | 840 |
| GANCCATTAT | CTAATGGACG | ACCCAGGGTA | ACTCCCGGCA | GGTGGTGGAN | CAAGATGAGG | 900 |
| AAGAAGATGA | GGANCTGACA | TTGAAATATG | NCGSCAAGCA | TGTGATCATG | CTCTTTGKCC | 960 |
| CTGTGACTCT | CTGCATGGTG | GTGGTCGTGG | NTACCATTAA | GTCAGTCAGC | TTTTATACCC | 1020 |
| GGAAGGATGG | GCAGCTGTAC | GTATGAGTTT | KGTTTTATTA | TTCTCAAASC | CAGTGTGGCT | 1080 |
| TTTCTTTACA | GCATGTCATC | ATCACCTTGA | AGGCCTCTNC | ATTGAAGGGG | CATGACTTAG | 1140 |
| CTGGAGAGCC | CATCCTCTGT | GATGGTCAGG | AGCAGTTGAG | AGANCGAGGG | GTTATTA CTT | 1200 |
| CATGTTTTAA | GTGGAGAAAA | GGAACACTGC | AGAAGTATGT | TTCCTGTATG | GTATTA CTGG | 1260 |
| ATAGGGCTGA | AGTTATGCTG | AATTGAACAC | ATAAATTCTT | TCCACCTCA | GGNCATTGG | 1320 |
| GCGCCATTG | NTCTTCTGCC | TAGAATATTC | TTTCCTTTNC | TNACTTKGGN | GGATTAAATT | 1380 |
| CCTGTCATCC | CCCTCCTCTT | GGTGTTATAT | ATAAAGTNTT | GGTGCCGCAA | AAGAAGTAGC | 1440 |
| ACTCGAATAT | AAAATTTTCC | TTTTAATTCT | CAGCAAGGNA | AGTTACTTCT | ATATAGAAGG | 1500 |
| GTGCACCCNT | ACAGATGGAA | CAATGGCAAG | CGCACATTTG | GGACAAGGGA | GGGGAAAGGG | 1560 |
| TTCTTATCCC | TGACACACGT | GGTCCCNGCT | GNTGTGTNCT | NCCCCACTG | ANTAGGGTTA | 1620 |
| GACTGGACAG | GCTTAAACTA | ATTCCAATTG | GNTAATTTAA | AGAGAATNAT | GGGGTGAATG | 1680 |
| CTTTGGGAGG | AGTCAAGGAA | GAGNAGGTAG | NAGGTA ACTT | GAATGA | | 1726 |

(2) INFORMATION FOR SEQ ID NO:10:

(i) SEQUENCE CHARACTERISTICS:

- (A) LENGTH: 1883 base pairs
- (B) TYPE: nucleic acid
- (C) STRANDEDNESS: single
- (D) TOPOLOGY: linear

(i i) MOLECULE TYPE: cDNA

(x i) SEQUENCE DESCRIPTION: SEQ ID NO:10:

| | | | | | | |
|------------|------------|------------|------------|------------|------------|-----|
| CNCGTATAAA | AGACCAACAT | TGCCANCNAC | AACCACAGGC | AAGATCTTCT | CCTACCTTCC | 60 |
| CCCNNGGTGT | AATACCAAGT | ATTCNCCAAT | TTGTGATAAA | CTTTCATTGG | AAAGTGACCA | 120 |
| CCCTCCTTGG | TTAATACATT | GTCTGTGCCT | GCTTTCACAC | TACAGTAGCA | CAGTTGAGTG | 180 |
| TTTGCCCTGG | AGACCATATG | ACCCATAGAG | CTTAAAATAT | TCAGTCTGGC | TTTTTACAGA | 240 |

-continued

| | | | | | | |
|------------|-------------|------------|-------------|------------|------------|---------|
| GATGTTTCTG | ACTTTGTTAA | TAGAAAATCA | ACCCAACCTGG | TTTAAATAAT | GCACATACTT | 3 0 0 |
| TCTCTCTCAT | AGAGTAGTGC | AGAGGTAGNC | AGTCCAGATT | AGTASGGTGG | CTTCACGTTC | 3 6 0 |
| ATCCAAGGAC | TCAATCTCCT | TCTTTCTTCT | TTAGCTTCTA | ACCTCTAGCT | TACTTCAGGG | 4 2 0 |
| TCCAGGCTGG | AGCCCTASCC | TTCATTTCTG | ACAGTAGGAA | GGAGTAGGGG | AGAAAAGAAC | 4 8 0 |
| ATAGGACATG | TCAGCAGAAT | TCTCTCCTTA | GAAGTTCCAT | ACACAACACA | TCTCCCTAGA | 5 4 0 |
| AGTCATTGCC | CTTACTTGTT | CTCATAGCCA | TCCTAAATAT | AAGGGAGTCA | GAAGTAAAGT | 6 0 0 |
| CTKKNTGGCT | GGGAATATTG | GCACCTGGAA | TAAAAATGTT | TTTCTGTGAA | TGAGAAACAA | 6 6 0 |
| GGGGAAGATG | GATATGTGAC | ATTATCTTAA | GACAACTCCA | GTTGCAATTA | CTCTGCAGAT | 7 2 0 |
| GAGAGGCACT | AATTATAAGC | CATATTACCT | TTCTTCTGAC | AACCACTTGT | CAGCCNCNGT | 7 8 0 |
| GGTTTCTGTG | GCAGAATCTG | GTTCYATAMC | AAGTTCCTAA | TAANCTGTAS | CCNAAAAAAT | 8 4 0 |
| TTGATGAGGT | ATTATAATTA | TTTCAATATA | AAGCACCCAC | TAGATGGAGC | CAGTGTCTGC | 9 0 0 |
| TTCACATGTT | AAGTCCTTCT | TTCCATATGT | TAGACATTTT | CTTTGAAGCA | ATTTTAGAGT | 9 6 0 |
| GTAGCTGTTT | TTCTCAGGTT | AAAAATTCTT | AGCTAGGATT | GGTGAGTTGG | GGAAAAGTGA | 1 0 2 0 |
| CTTATAAGAT | NCGAATTGAA | TTAAGAAAAA | GAAAATTCTG | TGTTGGAGGT | GGTAATGTGG | 1 0 8 0 |
| KTGGTGATCT | YCATTAAACAC | TGANCTAGGG | CTTTKGKGT | TGKTTTATTG | TAGAATCTAT | 1 1 4 0 |
| ACCCCATTC | NAGAAGATAC | CGAGACTGTG | GGCCAGAGAG | CCCTGCACTC | AATTCTGAAT | 1 2 0 0 |
| GCTGCCATCA | TGATCAGNGT | CATTGTWGTC | ATGACTANNC | TCCTGGTGGT | TCWGTATAAA | 1 2 6 0 |
| TACAGGTGCT | ATAAGGTGAG | CATGAGACAC | AGATCTTTGN | TTTCCACCCT | GTTCTTCTTA | 1 3 2 0 |
| TGGTTGGGTA | TTCTTGTCAC | AGTAACTTAA | CTGATCTAGG | AAAGAAAAAA | TGTTTTGTCT | 1 3 8 0 |
| TCTAGAGATA | AGTTAATTTT | TAGTTTTCTT | CCTCCTCACT | GTGGAACATT | CAAAAAATAC | 1 4 4 0 |
| AAAAAGGAAG | CCAGGTGCAT | GTGTAATGCC | AGGCTCAGAG | GCTGAGGCAG | GAGGATCGCT | 1 5 0 0 |
| TGGGCCCAGG | AGTTCACAAG | CAGCTTGGGC | AACGTAGCAA | GACCCTGCCT | CTATTAAAGA | 1 5 6 0 |
| AAACAAAAAA | CAAATATTGG | AAGTATTTTA | TATGCATGGA | ATCTATATGT | CATGAAAAAA | 1 6 2 0 |
| TTAGTGTA | ATATATATAT | TATGATTAGN | TATCAAGATT | TAGTGATAAT | TTATGTTATT | 1 6 8 0 |
| TTGGGATTT | AATGCCTTTT | TAGGCCATTG | TCTCAAMAAA | TAAAAGCAGA | AAACAAAAAA | 1 7 4 0 |
| AGTTGTA | GAAAAATAAA | CATTTCCATA | TAATAGCACA | ATCTAAGTGG | GTTTTTGNTT | 1 8 0 0 |
| GTTTGT | TTGTTGAAGC | AGGGCCTTGC | CCTNYCACCC | AGGNTGGAGT | GAAGTGCAGT | 1 8 6 0 |
| GGCACGATTT | TGGCTCACTG | CAG | | | | 1 8 8 3 |

(2) INFORMATION FOR SEQ ID NO:11:

- (i) SEQUENCE CHARACTERISTICS:
 - (A) LENGTH: 823 base pairs
 - (B) TYPE: nucleic acid
 - (C) STRANDEDNESS: single
 - (D) TOPOLOGY: linear

(i i) MOLECULE TYPE: cDNA

(x i) SEQUENCE DESCRIPTION: SEQ ID NO:11:

| | | | | | | |
|------------|------------|------------|------------|------------|------------|-------|
| CAGGAGTGGA | CTAGGTAAAT | GNAAGNTGTT | TTAAAGAGAG | ATGNNGNCNG | GGACATAGTG | 6 0 |
| GTACACANCT | GTAATGCTCA | NCACTKATGG | GGAGTACTGA | AGGNGGNSGG | ATCACTTGNG | 1 2 0 |
| GGTCNGGAAT | NTGAGANCAG | CCTGGGCAAN | ATGGCGAAAC | CCTGTCTCTA | CTAAAAATAG | 1 8 0 |
| CCANAAWNWA | GCCTAGCGTG | GTGGCGCRCA | CGCGTGGTTC | CACCTACTCA | GGAGGCNTAA | 2 4 0 |
| GCACGAGNAN | TNCTTGAACC | CAGGAGGCAG | AGGNTGTGGT | GARCTGAGAT | CGTGCCACTG | 3 0 0 |

-continued

| | | | | | | |
|------------|------------|------------|------------|-------------|-------------|-------|
| CACTCCAGTC | TGGGCGACMA | AGTGAGACCC | TGTCTCCNNN | AAGAAAAAAAA | AAATCTGTAC | 3 6 0 |
| TTTTTAAGGG | TTGTGGGACC | TGTTAATTAT | ATTGAAATGC | TTCTYTTCTA | GGTCATCCAT | 4 2 0 |
| GCCTGGCTTA | TTATATCATC | TCTATTGTTG | CTGCTCTTTT | TTACATTCAT | T TACTTGGGG | 4 8 0 |
| TAAGTTGTGA | AATTTGGGGT | CTGTCTTTCA | GAATTAACTA | CCTNNGTGCT | GTGTAGCTAT | 5 4 0 |
| CATTTAAAGC | CATGTACTTT | GNTGATGAAT | TACTCTGAAG | TTTTAATTGT | NTCCACATAT | 6 0 0 |
| AGGTCATACT | TGGTATATAA | AAGACTAGNC | AGTATTACTA | ATTGAGACAT | TCTTCTGTNG | 6 6 0 |
| CTCCTNGCTT | ATAATAAGTA | GAAGTAAAAG | NAACTTAAGA | CTACAGTTAA | TTCTAAGCCT | 7 2 0 |
| TTGGGGAAGG | ATTATATAGC | CTTCTAGTAG | GAAGTCTTGT | GCNATCAGAA | TGTTTNTAAA | 7 8 0 |
| GAAAGGGTNT | CAAGGAATNG | TATAAANACC | AAAAATAATT | GAT | | 8 2 3 |

(2) INFORMATION FOR SEQ ID NO:12:

- (i) SEQUENCE CHARACTERISTICS:
 (A) LENGTH: 736 base pairs
 (B) TYPE: nucleic acid
 (C) STRANDEDNESS: single
 (D) TOPOLOGY: linear

(i i) MOLECULE TYPE: cDNA

(x i) SEQUENCE DESCRIPTION: SEQ ID NO:12:

| | | | | | | |
|------------|------------|------------|------------|-------------|------------|-------|
| GTCTTTCCCA | TCTTCTCCAC | AGAGTTTGTG | CCTTACATTA | T TACTCCTTG | CCATTTTCAA | 6 0 |
| GAAAGCATTG | TCAGCTCTTC | CAATCTCCAT | CACCTTTGGG | CTTGTTTTCT | ACTTTGCCAC | 1 2 0 |
| AGATTATCTT | GTACAGCCTT | TTATGGACCA | ATTAGCATTC | CATCAATTTT | ATATCTAGCA | 1 8 0 |
| TATTTGCGGT | TAGAATCCCA | TGGATGTTTC | TTCTTTGACT | ATAACAAAAT | CTGGGGAGGA | 2 4 0 |
| CAAAGGTGAT | TTCCTGTGTC | CACATCTAAC | AAATCAAGAT | CCCCGGCTGG | ACTTTTGGAG | 3 0 0 |
| GTTCCTTCCA | AGTCTTCCTG | ACCACCTTGC | ACTATTGGAC | TTTGGAAGGA | GGTGCCTATA | 3 6 0 |
| GAAAACGATT | TTGAACATAC | TTCATCGCAG | TGGACTGTGT | CCTCGGTGCA | GAAACTACCA | 4 2 0 |
| GATTTGAGGG | ACGAGGTCAA | GGAGATATGA | TAGGCCCGGA | AGTTGCTGTG | CCCCATCAGC | 4 8 0 |
| AGCTTGACGC | GTGGTCACAG | GACGATTTTC | ACTGACACTG | CGAACTCTCA | GGACTACCGT | 5 4 0 |
| TACCAAGAGG | TTAGGTGAAG | TGGTTTAAAC | CAAACGGAAC | TCTTCATCTT | AAACTACACG | 6 0 0 |
| TTGAAAATCA | ACCCAATAAT | TCTGTATTAA | CTGAATTCTG | AACTTTTCAG | GAGGTACTGT | 6 6 0 |
| GAGGAAGAGC | AGGCACCACC | AGCAGAATGG | GGAATGGAGA | GGTGGGCAGG | GGTTCCAGCT | 7 2 0 |
| TCCCTTTGAT | TTTTTG | | | | | 7 3 6 |

(2) INFORMATION FOR SEQ ID NO:13:

- (i) SEQUENCE CHARACTERISTICS:
 (A) LENGTH: 893 base pairs
 (B) TYPE: nucleic acid
 (C) STRANDEDNESS: single
 (D) TOPOLOGY: linear

(i i) MOLECULE TYPE: DNA (genomic)

(x i) SEQUENCE DESCRIPTION: SEQ ID NO:13:

| | | | | | | |
|------------|------------|------------|------------|------------|------------|-------|
| GGATCCGCC | GCCTTGGCCT | CCCAAAGTGC | TGGGATTACA | GGCATGAGCC | ACCGCTCCTG | 6 0 |
| GCTGAGTCTG | CGATTTCTTG | CCAGCTCTAC | CCAGTTGTGT | CATCTTAAGC | AAGTCACTGA | 1 2 0 |
| ACTTCTCTGG | ATTCCCTTCT | CCTNNWGTA | AATAAGNATG | TTATCTGNCC | NNCCTGCCTT | 1 8 0 |
| GGGCATTGTG | ATAAGGATAA | GATGACATTA | TAGAATNTNG | CAAATTTAAA | AGCGCTAGAC | 2 4 0 |
| AAATGATTTT | ATGAAAATAT | AAAGATTAGN | TTGAGTTTGG | GCCAGCATAG | AAAAAGGAAT | 3 0 0 |

-continued

| | | | | | | |
|------------|------------|------------|------------|-------------|------------|-----|
| GTTGAGAACA | TTCNNTAAG | GATTACTCAA | GCYCCCCTTT | TGSTGKNWAA | TCAGANNGTC | 360 |
| ATNNAMNTAT | CNTNTGTGGG | YTGAAAATGT | TTGGTTGTCT | CAGGCGGTTC | CTACTTATTG | 420 |
| CTAAAGAGTC | CTACCTTGAG | CTTATAGTAA | ATTTGTCAGT | TAGTTGAAAG | TCGTGACAAA | 480 |
| TAAATACATT | CCTGGTTTAC | AAATTGGTCT | TATAAGTATT | TGATTGGTNT | AAATGNATTT | 540 |
| ACTAGGATTT | AACTAACAAT | GGATGACCTG | GTGAAATCCT | ATTTTCAGACC | TAATCTGGGA | 600 |
| GCCTGCAAGT | GACAACAGCC | TTTGCGGTCC | TTAGACAGCT | TGGCCTGGAG | GAGAACACAT | 660 |
| GAAAGAAAGG | TTTGTCTCTG | CTTAATGTAA | TCTATGGAAG | TGTTTTTTTAT | AACAGTATAA | 720 |
| TTGTAGTGCA | CAAAGTTCTG | TTTTTCTTTC | CCTTTTCAGA | ACCTCAAGAG | GCTTTGTTTT | 780 |
| CTGTGAAACA | GTATTTCTAT | ACAGTNTGCT | CCAANTGNAC | AGAGTTACCT | GCACNNCGTT | 840 |
| GTCCNTACTT | CCAGAATGCA | CAGATGTCTG | AGGACAACCA | CCTGAGCAAT | ACT | 893 |

(2) INFORMATION FOR SEQ ID NO:14:

- (i) SEQUENCE CHARACTERISTICS:
 - (A) LENGTH: 475 base pairs
 - (B) TYPE: nucleic acid
 - (C) STRANDEDNESS: single
 - (D) TOPOLOGY: linear

(i i) MOLECULE TYPE: DNA (genomic)

(x i) SEQUENCE DESCRIPTION: SEQ ID NO:14:

| | | | | | | |
|------------|-------------|------------|------------|------------|------------|-----|
| TCAGAAAATA | CTTTNGGGCA | CATGAGAATC | ACATGAGAAC | AAGCTGATGC | ATAATTCCTC | 60 |
| CTGTGATGGA | ATGTAATAGT | AATTTAACAG | TGTCCTTTCT | TTTTAACTGC | CTCAAGGATA | 120 |
| CAGCAAAATA | AAACAAAAGC | AATATGAAGG | CTGAGAATAG | GTATCAGATT | ATCATAAAAA | 180 |
| GTATAGATCA | AAAGGAATCT | GGTKCTNAGG | TTGGCGCAGC | AGCCTCTAGA | AGCGACNAGG | 240 |
| GAGACTTTTA | GAAC TACCAT | TCTCCTCTAT | AAGTGGATCC | NANGCCAGG | RAAACTTGAT | 300 |
| ATTGAGNACA | ATGGCCTTAC | TGAAATAACC | TGTGATCCAC | TCGGNCTCAT | CATCTCCACC | 360 |
| ACCACCATAA | ATTTGATGAG | TNCCTATAAT | ATTCCANCCA | GNGGAAATAC | CTGGRAGGTT | 420 |
| ACTGAAAGGC | NACNATCAGA | CNAAAATAAA | GNATACCGTA | GGTAAATTCT | ACAGT | 475 |

(2) INFORMATION FOR SEQ ID NO:15:

- (i) SEQUENCE CHARACTERISTICS:
 - (A) LENGTH: 180 base pairs
 - (B) TYPE: nucleic acid
 - (C) STRANDEDNESS: single
 - (D) TOPOLOGY: linear

(i i) MOLECULE TYPE: DNA (genomic)

(x i) SEQUENCE DESCRIPTION: SEQ ID NO:15:

| | | | | | | |
|------------|------------|------------|------------|------------|------------|-----|
| GTTCTCNAGA | TCTCTTCAA | ATTCATTNTG | CGCTATAGGA | GCTGGGATTA | CCGCGGGTGC | 60 |
| TGGAACCAGA | CTTGCNCTCC | AATGGATCCT | CCANACNGGA | NGGGGGGTGG | ACTCACACCA | 120 |
| TTTACAGGGG | GCTCGTAAAG | AATCCTGTTT | TGANTATTNT | NCCGTCAATT | ACCNCCCCAA | 180 |

(2) INFORMATION FOR SEQ ID NO:16:

- (i) SEQUENCE CHARACTERISTICS:
 - (A) LENGTH: 457 base pairs
 - (B) TYPE: nucleic acid
 - (C) STRANDEDNESS: single
 - (D) TOPOLOGY: linear

(i i) MOLECULE TYPE: DNA (genomic)

(x i) SEQUENCE DESCRIPTION: SEQ ID NO:16:

-continued

| | | | | | | |
|------------|------------|------------|------------|------------|------------|-------|
| AATGTAACMA | CMAAACCYCA | AACTCCTGNA | AGAANATGGT | TACTTATNGA | TNCCATTTNC | 6 0 |
| TTTTTNCAC | CTCAGACATA | AATATAAACM | MANTTTCTAC | TGTGGRAAAA | CATCTNCAGG | 1 2 0 |
| GGNCNTTTAN | CCATGATCTC | TAGNACNANG | GGCTNGTGGN | TNGTTTTAAT | GTCTCTAAGC | 1 8 0 |
| NACTNGACTA | GTTTCTCTTN | CACTGAGNAA | ACTGCNACAA | GTNNTTNCTN | CTGNATCTGN | 2 4 0 |
| ACTGNAATGC | TAAGTTNCAA | GTNCCAATGA | GCTNGTGANT | TANYCTTTAT | TTNAMCNAAA | 3 0 0 |
| GTNNTTAATC | ANCCNCAGTG | TTACTTTGNA | AAGCTNCTCC | CTGGACAGGC | GGCCCNACTT | 3 6 0 |
| CTAATGTTAT | GAATGGGCTG | GAGNANCCTC | NACNTGAGTT | TNNWAAGGNT | CAACANCCAA | 4 2 0 |
| TRGNAANTGT | AMCCGACTCT | AAATTCCAAC | CNATAAT | | | 4 5 7 |

(2) INFORMATION FOR SEQ ID NO:17:

- (i) SEQUENCE CHARACTERISTICS:
 - (A) LENGTH: 373 base pairs
 - (B) TYPE: nucleic acid
 - (C) STRANDEDNESS: single
 - (D) TOPOLOGY: linear

(i i) MOLECULE TYPE: DNA (genomic)

(x i) SEQUENCE DESCRIPTION: SEQ ID NO:17:

| | | | | | | |
|-------------|------------|------------|-------------|------------|------------|-------|
| ATCTGTGCTA | GGTAGTGTAC | TAATCATTCA | GTTTATCTCA | TTTAATCTNN | ATGNAACTCT | 6 0 |
| AAGTCATTTCG | CTNTGANCNA | CACATAACAG | ATCTCGCAAC | TGNAGTTTAG | CGAGGCCAGT | 1 2 0 |
| TAATTTKCCA | AAGNTCATAA | TNCTAAGNAG | TTCTAGNATG | GAGATTCMAA | GTCCNACTGT | 1 8 0 |
| TTAGTCAAGA | GACCCTACTG | TTAACTAGTA | CCTTTACACT | ACTAACTGGG | TAANCCATAA | 2 4 0 |
| NCAATTAATG | ATAAAGATTG | AGATTACTKC | CACATTCTCA | CTGGTTATAA | ATTAAAACNT | 3 0 0 |
| CAAATAAAAA | NTCTTGGCAC | TTCTATGGTA | ATATTTTTTAT | TAGGATAAAC | TTTCAAGNAG | 3 6 0 |
| TGGATNCTAG | GTG | | | | | 3 7 3 |

(2) INFORMATION FOR SEQ ID NO:18:

- (i) SEQUENCE CHARACTERISTICS:
 - (A) LENGTH: 422 base pairs
 - (B) TYPE: nucleic acid
 - (C) STRANDEDNESS: single
 - (D) TOPOLOGY: linear

(i i) MOLECULE TYPE: DNA (genomic)

(x i) SEQUENCE DESCRIPTION: SEQ ID NO:18:

| | | | | | | |
|------------|------------|------------|------------|------------|------------|-------|
| CCCACACTGN | TGGGCCATGG | AAGCCATGAG | TGTACCACAT | GGCCCTGTCC | CACTGGCCAC | 6 0 |
| AGTNGATTGG | TTGGNTCGGG | AGTAGTCACC | TGATTCAAGN | TGGGCCAATC | AGATCCTACC | 1 2 0 |
| TCCANGGGGT | TNGGAATTAG | AAAACAGTGA | CCCTAGYTAG | TNTAGGCNAC | TTGAACTGGA | 1 8 0 |
| GGGCCCATAC | ATTCAGGAGC | CTTATGGGGC | CATGTACACA | TGGAAGCAGG | AAGANTGAAG | 2 4 0 |
| GAGGGAGAAG | TAGAGGCCAG | AAACCCACCT | GGGTTCTGT | TTCCCAATGN | TAAGTCCCTG | 3 0 0 |
| CCATGTYCCT | GCTCTTCCTG | TGGTTNGGAT | CTTCAAAGGT | TGCTCAAATT | NGGGGCAGTG | 3 6 0 |
| GCCCTGGCAG | CTTTTCAAAT | CCTYCCCAT | TTTATTGAAG | CTGAAAGACC | CTTGACTAGA | 4 2 0 |
| AC | | | | | | 4 2 2 |

(2) INFORMATION FOR SEQ ID NO:19:

- (i) SEQUENCE CHARACTERISTICS:
 - (A) LENGTH: 395 base pairs
 - (B) TYPE: nucleic acid
 - (C) STRANDEDNESS: single

-continued

(D) TOPOLOGY: linear

(i i) MOLECULE TYPE: DNA (genomic)

(x i) SEQUENCE DESCRIPTION: SEQ ID NO:19:

| | | | | | | |
|------------|------------|------------|------------|------------|------------|-------|
| ATTGTTATTT | TTCGTCACTA | CCTCCCCGGG | TCGGGAGTGG | GTAATTTGCG | CGCCTGCTGC | 6 0 |
| CTTCCTTGGA | TGTGGTAGCC | GTTTCTCAGG | CTCCCTCTCC | GGAATCGAAC | CCTGATTCCC | 1 2 0 |
| CGTCACCCGT | GGTCACCATG | GTTAGGCACG | GCGACTACCA | TCGAAAGTTA | ATAGGGCAGA | 1 8 0 |
| TCTCGAGAAT | TCTCGAGATC | TCCNTCMAAT | TATTACTTCA | NTTKCGGTAG | TGATCAGNAC | 2 4 0 |
| NAGGCAGTTC | TATTGATTTT | TCTCCTTTCA | TTCTGAGTTT | CTCCATAAAT | TAATTGGACC | 3 0 0 |
| TAATCATGTT | TKNAATCCTG | TCTTTTAGGG | GGNANTTGNA | CTNTCAAGTG | TTTAAAGGGA | 3 6 0 |
| GGGNCGGAGN | ATGATTNTGG | ATTGGAGTGA | GAGCA | | | 3 9 5 |

(2) INFORMATION FOR SEQ ID NO:20:

(i) SEQUENCE CHARACTERISTICS:

- (A) LENGTH: 487 base pairs
- (B) TYPE: nucleic acid
- (C) STRANDEDNESS: single
- (D) TOPOLOGY: linear

(i i) MOLECULE TYPE: DNA (genomic)

(x i) SEQUENCE DESCRIPTION: SEQ ID NO:20:

| | | | | | | |
|------------|------------|------------|------------|------------|------------|-------|
| CAGANTTTCT | GGGTNAAAAG | GACCTNANAC | ATAATATAGT | GGACTTNCAA | TAAACACTTA | 6 0 |
| CCAAATGGAN | AAATGAACCC | CTGGTCACCC | CGATCTCACT | AGTNCCTNCC | CTGAAACCCG | 1 2 0 |
| ANANATCTGA | GTCCTTTTCT | CCTTTACTAA | CCCTTNCTCC | AATCCTGCTC | ATGGGAATTA | 1 8 0 |
| ANGNTGTAAA | ATANGCCTGG | GGNACCTCGG | RCCTCTNCCC | TGGGNTCTGT | GGGTGGGAGN | 2 4 0 |
| ACTGTGGAAG | CCGTWTCAAT | CGCCCCCACC | TATGAGAGCC | TTTCTNCAGG | GCCAGCCATG | 3 0 0 |
| AACGTCCCCC | ATGTNATCAG | NATCTNCAGG | CTACTGCTGT | CCTTCYTGGA | TWTTTAACTT | 3 6 0 |
| GGRGGCGGGC | CAGGGACAGA | AAARGGAGGT | GGCAAGATCC | TTGAACAAAA | GGAGCTATAA | 4 2 0 |
| AAGGGCGTTG | GGGGAAGCAA | GGCAAACGGC | AGATTAAACA | AGCAGGCACC | TCAAGGAAAC | 4 8 0 |
| GTGACGC | | | | | | 4 8 7 |

(2) INFORMATION FOR SEQ ID NO:21:

(i) SEQUENCE CHARACTERISTICS:

- (A) LENGTH: 500 base pairs
- (B) TYPE: nucleic acid
- (C) STRANDEDNESS: single
- (D) TOPOLOGY: linear

(i i) MOLECULE TYPE: DNA (genomic)

(x i) SEQUENCE DESCRIPTION: SEQ ID NO:21:

| | | | | | | |
|------------|------------|------------|------------|------------|------------|-------|
| CTCGAGATCT | GGCCCATCAT | TTAGTTTTAT | NGCTTGNAGT | NTNTAGNAGA | TAAAACATCC | 6 0 |
| ACGTGGATCT | NCTCTTAGAG | AAATCAANTA | CTTTAGGNAT | NTGATAGTCA | GAGANTGGNT | 1 2 0 |
| ATCAAATNGA | AAGGNATNTN | GGTNGANCAG | TTAGTTNGYN | CCNTTNGNNG | AGACCACTGG | 1 8 0 |
| GNTGTNGASA | CCAGATTCMK | GGGTNCNAAT | CTTANGGTAA | TCTNAGAGCC | AACACATGGG | 2 4 0 |
| TCATNTTATS | CCCCAAACTT | AGCCACATCT | BGTGGGGYTA | TGGNGTCACC | CCAAGAGCAG | 3 0 0 |
| GAGGAGCATG | GNTGGATGGA | AATCCATCTC | CACCACTGGA | ACCCCAAWTT | CTGAATGNAT | 3 6 0 |
| CACCTGTTAG | AGTTTCTTGT | YCATAAAATA | GCAGGGAATT | TAGGAATTTA | GTTTTTTTTT | 4 2 0 |
| AATAGTTTGG | GCCTTTTATC | CACACTCTCA | GGAGCTTAGG | ATACTTTTCT | CCTTCAGCTC | 4 8 0 |

-continued

ACTCTGAAAC TCCCTCTGGA

5 0 0

(2) INFORMATION FOR SEQ ID NO:22:

- (i) SEQUENCE CHARACTERISTICS:
 (A) LENGTH: 406 base pairs
 (B) TYPE: nucleic acid
 (C) STRANDEDNESS: single
 (D) TOPOLOGY: linear

(i i) MOLECULE TYPE: DNA (genomic)

(x i) SEQUENCE DESCRIPTION: SEQ ID NO:22:

| | | | | | | |
|------------|------------|------------|------------|------------|------------|-------|
| TCGAGATCTG | TGGTAGTNAC | ATGATATTCT | GGCAMPACT | TTCATTATCA | CCTTTATTAA | 6 0 |
| AATAAATTTA | AAGAAAAATG | GCAGTATGTT | TCTGTGRAGN | CCACGAGTAC | TCATTTTAAA | 1 2 0 |
| GGACTCMAGA | GTTNCAGRNA | AGTAAAAAGR | AAAGAGTAAA | ATCATTTTCT | AANTYTYWYY | 1 8 0 |
| TTCCAGAAAT | AACGATGTTG | AGCATTAAGT | GGACTTCATT | TCATACTCTT | TCMMAGNTTA | 2 4 0 |
| TGTAGGCATA | WAWATGTGTG | TGTATATACA | TATATATGGG | TACATCCTTA | GAGAAGTTGG | 3 0 0 |
| CTGGCTAGAT | AGACACACNT | NAAAAATGGR | ATCATACTCT | AATKCCATTT | NNANTTTANA | 3 6 0 |
| AAATACATAT | TCAGANCCNC | TGTNCTTATA | NACAGAGTAA | NTGAAA | | 4 0 6 |

(2) INFORMATION FOR SEQ ID NO:23:

- (i) SEQUENCE CHARACTERISTICS:
 (A) LENGTH: 289 base pairs
 (B) TYPE: nucleic acid
 (C) STRANDEDNESS: single
 (D) TOPOLOGY: linear

(i i) MOLECULE TYPE: DNA (genomic)

(x i) SEQUENCE DESCRIPTION: SEQ ID NO:23:

| | | | | | | |
|------------|------------|------------|------------|------------|------------|-------|
| GACCCAGTAA | AACTTATCTC | ATGAGCATAA | GGCTGAATGG | GATTGACAGC | CTACAGAACC | 6 0 |
| CGGATTTTAT | CATGAGGGCA | TTAGTGGGGG | TTGGGGGTTA | GGTACTGAAA | GTTTAAGGAG | 1 2 0 |
| GTGAAAGGAA | AGCAACTTGT | GCCTTACAGG | GTCAAGCTAG | GTCAAGGAAA | TTCCCAGGAG | 1 8 0 |
| CGTGTGGAAG | CTCTCTACCT | GATAGGTGAG | CTCAAGCTTA | TGACCGCCCA | AGCTTCTCCC | 2 4 0 |
| CAAGCTTCCC | TTCCACTGCT | TCCTCTTGAT | TGACTTCCAC | AGCAAGGTC | | 2 8 9 |

(2) INFORMATION FOR SEQ ID NO:24:

- (i) SEQUENCE CHARACTERISTICS:
 (A) LENGTH: 367 base pairs
 (B) TYPE: nucleic acid
 (C) STRANDEDNESS: single
 (D) TOPOLOGY: linear

(i i) MOLECULE TYPE: DNA (genomic)

(x i) SEQUENCE DESCRIPTION: SEQ ID NO:24:

| | | | | | | |
|------------|------------|------------|------------|------------|------------|-------|
| CCATCAGGAT | TACTGAGTA | AAAATCTCAG | GTNTTAACCA | TGCCCTAAA | ATGTGCTATN | 6 0 |
| CCAAAGAGGA | ACAGGTTACT | TGGGAGGAAA | AAAGCTGCCT | GGGNAACTCC | CCNCAAATGT | 1 2 0 |
| TTATTTTAAA | TAAAAATGGT | NGATGGAAAT | ATTTTNTAAA | AGAACTTGGG | GTNTAATATG | 1 8 0 |
| GNATACTGCC | CATCAAACAA | AAAAGGAAAT | AAAACCTCNT | TCCCATTTAT | AATAAGTTNC | 2 4 0 |
| CCACCCTTTA | CTATCAAGAT | TACAACTTAT | TGACCTTTTA | TGCTNGCTNG | GTTTTTTTGG | 3 0 0 |
| GACTGCCTAA | TCCAATGTTT | AAATTTTCTA | NGTCTGNATT | TCAATGTGGG | TAGGAGTNAT | 3 6 0 |
| TTTTCAA | | | | | | 3 6 7 |

-continued

(2) INFORMATION FOR SEQ ID NO:25:

- (i) SEQUENCE CHARACTERISTICS:
 (A) LENGTH: 425 base pairs
 (B) TYPE: nucleic acid
 (C) STRANDEDNESS: single
 (D) TOPOLOGY: linear

(i i) MOLECULE TYPE: DNA (genomic)

(x i) SEQUENCE DESCRIPTION: SEQ ID NO:25:

```

GAGTATCTGA CAGGTAAGAT TGCTTTTTTAA AGTTGTTTTA AATGCATTAC ATGACTGAGA      6 0
AAAGAAAAAT GCACATTTTA TTGTTGCAGT TTA AAAATTTT C ATTTNGNGTG AA ACTAAACG      1 2 0
TGAAACAAAA GGGATAAATG TGTTTTGNTT TTGTTTTGGT TTTACCTGTT TGGGGTATTT      1 8 0
TTTTCTGAGT TTGTGTAGAA ACCCGTGTGG NTACACTGGG TAATCCTGTC AGGGNTACMA      2 4 0
AMCTTGGGTC TTGANTTTGG TTANTTTGGNT TTANTTTGGT NACCCATGTA CTTGCTCTTC      3 0 0
CNTCCAGAA ACATAGCTTG GTAGGCNAGG GTTAANCCAG TGTCGGCGAN CCCATGTCCC      3 6 0
TANCACAGCA TCTTGTAAGT TTAATGCACA ATCGTTCCNT CCCAGGATGG ANTTATCATT      4 2 0
ATAAA                                             4 2 5

```

(2) INFORMATION FOR SEQ ID NO:26:

- (i) SEQUENCE CHARACTERISTICS:
 (A) LENGTH: 2377 base pairs
 (B) TYPE: nucleic acid
 (C) STRANDEDNESS: single
 (D) TOPOLOGY: linear

(i i) MOLECULE TYPE: DNA (genomic)

(x i) SEQUENCE DESCRIPTION: SEQ ID NO:26:

```

GAGAGGCGCA GGAGCCACAA ATAAAGCAAG AGCCAGAATC AGAAGNGGAG GAAGAAGAAA      6 0
AGCAAGAAAA AGRAGRAANA CGAGAAGAAC CCATGGRAGA GGAAGAGGAN CCAGANCMMA      1 2 0
AGCCTTGTCT GAAACCTACT CTGAGGCCCA TCAGCTCTGC TCCATCTGTT TCCTCTGCCA      1 8 0
GTGGNAATGC NACACCTAAC ACTCCTGGGG ATGAGTCTCC CTGTGGTATT ATTATTCCTC      2 4 0
ATGRAAACTC ACCAGATCAA CAGCAACCTG AGGAGCATAG GCCMAAAATA GGACTAAGTC      3 0 0
TTAAACTGGG TGCTTCCAAT AGTCCTGGTC AGCCTAATTC TGTGAAGAGA AAGAACTAC      3 6 0
CTGTAGATAG TGTCTTTAAC AAATTTGAGG ATGAAGACAG TGATGACGTA CCCC GAAAAA      4 2 0
GGAAACTGGT TCCCTTGGAT TATGGTGAAG ATGATAAAAA TNCAACCAA GGC ACTGTAA      4 8 0
ACACTGAAGA AAAGCGTAAA CACATTAAGA GTCTCATTGA GAAAATCCCT ACAGCCAAAC      5 4 0
CTGAGCTCTT CGCTTATCCC CTGGATTGGT CTATTGTGGA TTCTATACTG ATGGAACGTC      6 0 0
GAATTAGACC ATGGATTAAT AAGAAAATCA TAGAATATAT AGGTGAAGAA GAAGCTACAT      6 6 0
TAGTTGATTT NGTTTGTCT AAGGTTATGG CTCATAGTNC ACCCCAGAGC ATTTTAGATG      7 2 0
ATGTTGCCAT GGTACTTGAT GAAGAAGCAG AAGTTTTTAT AGTCAAAATG TGGAGATTAT      7 8 0
TGATATATGA AACAGAAGCC AAGAAAATTG GTCTTGTGAA GTAAA ACTTT TTATATTTAG      8 4 0
AGTTCCATTT CAGATTTCTT CTTTGCCACC CTTTTAAGGA CTTKGAATTT TTCTTTGTCT      9 0 0
TKGAAGACAT TGTGAGATCT GTAATTTTTT TTTTTTGTAG AAAATGTGAA TTTTTTGGTC      9 6 0
CTCTAATTTG TTGTTGCCCT GTGTA CTCCC TTGGTTGTAA AGTCATCTGA ATCCTTGGTT      1 0 2 0
CTCTTTATAC TCACCAGGTA CAAAT TACTG GTATGTTTTA TAAGCCGCAG C TACTGTACA      1 0 8 0
CAGCCTATCT GATATAATCT TGTTCTGCTG ATTTGTTTCT TG TAAATATT AAAACGACTC      1 1 4 0
CCCAATTATT TTGCAGAATT GCACTTAATA TTGAAATGTA CTGTATAGGA ACCAACATGA      1 2 0 0

```

-continued

| | | | | | | |
|------------|------------|------------|------------|------------|-------------|------|
| ACAATTTTAA | TTGAAAACAC | CAGTCATCAA | CTATTACCAC | CCCCACTCTC | TTTTTCATCAG | 1260 |
| AAATGGCAAG | CCCTTGTGAA | GGCATGGAGT | TTAAAATTGG | AATGCAAAAA | TTAGCAGACA | 1320 |
| ATCCATTCTT | ACTGTATTTT | TGTATGAATG | TGTTTGTGAA | TGTATGTGTA | AAAGTCTTTC | 1380 |
| TTTTCCCTAA | TTTGCTTTGG | TGGGGTCCTT | AAAACATTTT | CCAACATAAG | AATAGAATTG | 1440 |
| TAAAGGAAAA | GTGGTACTGT | TCCAACCTGA | AATGTCTGTT | ATAATTAGGT | TATTAGTTTC | 1500 |
| CCAGAGCATG | GTGTTCTCGT | GTCGTGAGCA | ATGTGGGTTG | CTAACTGTAT | GGGGTTTTCT | 1560 |
| TATTAATAAG | ATGGCTGCTT | CAGCTTCTCT | TTTAAAGGAA | TGTGGATCAT | AGTGATTTTT | 1620 |
| CCTTTTAATT | TTATTGCTCA | GAAATGAGGC | ATATCCCTAA | AAATCTCGGA | GAGCTGTATT | 1680 |
| TAATGCATTT | TTGCACTAAT | TGGTCCTTAG | TTAATTCTA | TTGTATCTGT | TTATTTAACA | 1740 |
| AAAAATTCAT | CATATCAAAA | AGTGTAAGTG | AAAACCCCTT | TTAAAACAAA | ACAAAAAAAT | 1800 |
| GAAATAAAAT | TAGGCAAATT | GACAGACAGT | GAGAGTTTTA | CAAACATGAT | AGGTATTCTG | 1860 |
| CTCGGCAATT | TGTAAGTTTA | CATGTTATTT | AAGGATAAAG | GTAAATCATT | CAAGGCAGTT | 1920 |
| ACCAACCACT | AACTATTTGT | TTTCATTTTT | GTCTTGTAGA | AGGTTTATAT | CTTGTTTTAC | 1980 |
| CTTGGCTCAT | TAGTGTTTAA | AAATGTACTG | ATGATGTGCT | TAGAGAAATT | CCTGGGGCTT | 2040 |
| TCTTCGTTGT | AGATCAGAAT | TTCACCAGGG | AGTAAAATTA | CCTGAAAACG | TAAGAAGTTT | 2100 |
| TAAACAGCTT | TCCACACAAA | TTAGATGCAA | CTGTTCCCAT | GTCTGAGGTA | CTTATTTAAA | 2160 |
| AGAAAGGTAA | AGATTGGCCT | GTTAGAAAAA | GCATAATGTG | AGCTTTGGAT | TACTGGATTT | 2220 |
| TTTTTTTTTT | TAAACACACC | TGGAGAGGAC | ATTTGAAAAC | ACTGTTCTTA | CCCTCGAACC | 2280 |
| CTGATGTGGT | TCCATTATGT | AAATATTTCA | AATATTAATA | ATGTATATAT | TTGAAAAAAA | 2340 |
| AAAAAAAAAA | AAAATTCCTG | CGGCCGCAAG | GGAATTC | | | 2377 |

(2) INFORMATION FOR SEQ ID NO:27:

- (i) SEQUENCE CHARACTERISTICS:
 - (A) LENGTH: 489 base pairs
 - (B) TYPE: nucleic acid
 - (C) STRANDEDNESS: single
 - (D) TOPOLOGY: linear

(i i) MOLECULE TYPE: DNA (genomic)

(x i) SEQUENCE DESCRIPTION: SEQ ID NO:27:

| | | | | | | |
|------------|------------|------------|------------|------------|------------|-----|
| ATTGGAGCTC | CACCGCGGTG | GCGGCCGCTC | TAGNAACTAG | TGGATCCCCC | GGGCTGCAGG | 60 |
| AATTCTCGAG | ATCTCCCCCA | AGTAAATGAA | TGAAAAAAAG | AACAGCAACA | ATAGAGATGA | 120 |
| TATAATAAGC | CAGGCATGGA | TGACCTTATA | GCACCCTGTA | TTTATACAGA | ACCACCAGGA | 180 |
| GGATAGTCAT | GACAACNATG | ACACTGATCA | TGATNCCAGC | ATTCAGAATT | GAGTNCAGGG | 240 |
| CTCTCTGGCC | CACAGTCTCG | GTATCTTCTG | TGNATGGGGT | ATAGATTARC | TGTCCATCCT | 300 |
| TCCGGGNATA | AAANCTGACT | GACTTAATGG | TANCCACGAC | CACCACCCAT | KCAGAGAGTC | 360 |
| ACAGGGACMA | AAGAGCATGA | TCAACATGCT | TGGCNCATA | TTTCAATNTC | ANCTCCTCAT | 420 |
| CTTCTTCCTC | ATCTTNCTCC | ACCACCTNCC | GGGAGTTAAC | CCTGGGGTGC | TCCATTAGAT | 480 |
| AATGGCTCA | | | | | | 489 |

(2) INFORMATION FOR SEQ ID NO:28:

- (i) SEQUENCE CHARACTERISTICS:
 - (A) LENGTH: 2307 base pairs
 - (B) TYPE: nucleic acid
 - (C) STRANDEDNESS: single
 - (D) TOPOLOGY: linear

-continued

(i i) MOLECULE TYPE: DNA (genomic)

(x i) SEQUENCE DESCRIPTION: SEQ ID NO:28:

| | | | | | | |
|------------|------------|------------|------------|------------|------------|---------|
| AGGGTGCTTC | AGTGTGGCTG | ACACAGCAGC | ATGGTCTTGA | CAAGTTTTCT | TCATCCTACC | 6 0 |
| ACAAAATCCC | AGTTGGTAAT | AGAGACTTTA | CTCCTACCTA | TCAAAACCAC | AAAATGTCCC | 1 2 0 |
| ATTAGGGGGG | GACATGTTGT | ACATGTTAGG | ATCATTCAAA | TAACCAAGAT | TATAAGGTGA | 1 8 0 |
| GGAAAGATGC | CCCTAACTGA | TTCTTTTGTC | TCTCATCTTG | TTGGTTCCAG | GGACCGAGTG | 2 4 0 |
| GGGTCAATCT | TCTGGTSSTG | CCTCTCCAGG | TCTCTTCCAG | GCCGGTCATA | GACGTACTCC | 3 0 0 |
| CTCTGAGGCC | GACCGATGGT | TAGAAGAGGT | GTCTAAGAGC | GTCCGGGCTC | AGCAGCCCCA | 3 6 0 |
| GGCCTCAGCT | GCTCCTCTGC | AGCCAGTTCT | CCAGCCTCCT | CCACCCACTG | CCATCTCCCA | 4 2 0 |
| GCCAGCATCA | CCTTTCCAAG | GGAATGCATT | CCTCACCTCT | CAGCCTGTGC | CAGTGGGTGT | 4 8 0 |
| GGTCCCAGCC | CTGCAACCAG | CCTTTGTCCC | TGCCCAGTCC | TATCCTGTGG | CCAATGGAAT | 5 4 0 |
| GCCCTATCCA | GCCCCTAATG | TGCCTGTGGT | GGGCATCACT | CCCTCCCAGA | TGGTGGCCAA | 6 0 0 |
| CGTWTTTGGC | ACTGCAGGCC | ACCCTCAGGC | TGCCCATCCC | CATCAGTCAC | CCAGCCTGGT | 6 6 0 |
| CAGGCAGCAG | ACATTCCCTC | ACTACGAGGC | AAGCAGTGCT | ACCACCAGTC | CCTTCTTTAA | 7 2 0 |
| GCCTCCTGCT | CAGCACCTCA | ACGGTTCTGC | AGCTTTCAAT | GGTGTAGATG | ATGGCAGGTT | 7 8 0 |
| GGCCTCAGCA | GACAGGCATA | CAGAGGTTCC | TACAGGCACC | TGCCCAGTGG | ATCCTTTTGA | 8 4 0 |
| AGCCCAGTGG | GCTGCATTAG | AAAATAAGTC | CAAGCAGCGT | ACTAATCCCT | CCCCTACCAA | 9 0 0 |
| CCCTTTCTCC | AGTGACTION | AGAAGACGTT | TGAAATTGAA | CTTTAAGCAA | TCATTATGGC | 9 6 0 |
| TATGTATCTT | GTCCATACCA | GACAGGGAGC | AGGGGGTAGC | GGTCAAAGGA | GCMAAACAGA | 1 0 2 0 |
| YTTTGTCTCC | TGATTAGTAC | TCTTTTCACT | AATCCCAAAG | GTCCCAAGGA | ACAAGTCCAG | 1 0 8 0 |
| GCCCAGAGTA | CTGTGAGGGG | TGATTTTGAA | AGACATGGGA | AAAAGCATT | CTAGAGAAAA | 1 1 4 0 |
| GCTGCCTTGC | AATTAGGCTA | AAGAAGTCAA | GGAAATGTTG | CTTTCTGTAC | TCCCTCTTCC | 1 2 0 0 |
| CTTACCCCCT | TACAAATCTC | TGGCAACAGA | GAGGCAAAGT | ATCTGAACAA | GAATCTATAT | 1 2 6 0 |
| TCCAAGCACA | TTTACTGAAA | TGTAAAACAC | AACAGGAAGC | AAAGCAATGT | CCCTTTGTTT | 1 3 2 0 |
| TTCAGGCCAT | TCACCTGCCT | CCTGTCAGTA | GTGGCCTGTA | TTAGAGATCA | AGAAGAGTGG | 1 3 8 0 |
| TTTGTGCTCA | GGCTGGGAAC | AGAGAGGCAC | GCTATGCTGC | CAGAATTCCC | AGGAGGGCAT | 1 4 4 0 |
| ATCAGCAACT | GCCCAGCAGA | GCTATATTTT | GGGGGAGAAG | TTGAGCTTCC | ATTTTGAGTA | 1 5 0 0 |
| ACAGAATAAA | TATTATATAT | ATCAAAAGCC | AAAATCTTTA | TTTTTATGCA | TTTAGAATAT | 1 5 6 0 |
| TTTAAATAGT | TCTCAGATAT | TAAGAAGTTG | TATGAGTTGT | AAGTAATCTT | GCCAAAGGTA | 1 6 2 0 |
| AAGGGGCTAG | TTGTAAGAAA | TTGTACATRA | GATTGATTTA | TCATTGATGC | CTACTGAAAT | 1 6 8 0 |
| AAAAAGAGGA | AAGGCTGGAA | GCATGCAGAC | AGGATCCCTA | GCTTGTTTTT | TGTCAGTCAT | 1 7 4 0 |
| TCATTGTAAG | TAGCACATTG | CAACAACAAT | CATGCTTATG | ACCAATACAG | TCACTAGGTT | 1 8 0 0 |
| GTAGTTTTTT | TTAAATAAAG | GAAAAGCAGT | ATTGTCCTGG | TTTTAAACCT | ATGATGGAAT | 1 8 6 0 |
| TCTAATGTCA | TTATTTTAAT | GGAATCAATC | GAAATATGCT | CTATAGAGAA | TATATCTTTT | 1 9 2 0 |
| ATATATTGCT | GCAGTTTCCT | TATGTTAATC | CTTTAACACT | AAGGTAACAT | GACATAATCA | 1 9 8 0 |
| TACCATAGAA | GGGAACACAG | GTTACCATAT | TGGTTTGTAA | TATGGGTCTT | GGTGGGTTTT | 2 0 4 0 |
| GTTTTATCCT | TTAAATTTTG | TTCCCATGAG | TTTTGTGGGG | ATGGGGATTC | TGGTTTTATT | 2 1 0 0 |
| AGCTTTGTGT | GTGTCCTCTT | CCCCCAAACC | CCCTTTTGGT | GAGAACATCC | CCTTGACAGT | 2 1 6 0 |
| TGCAGCCTCT | TGACCTCGGA | TAACAATAAG | AGAGCTCATC | TCATTTTTAC | TTTTGAACGT | 2 2 2 0 |
| TGGCGCTTAC | AATCAAATGT | AAGTTATATA | TATTTGTACT | GATGAAAATT | TATAATCTGC | 2 2 8 0 |

-continued

TTTAACAAAA ATAAATGTTC ATGGTAG

2307

(2) INFORMATION FOR SEQ ID NO:29:

- (i) SEQUENCE CHARACTERISTICS:
 - (A) LENGTH: 343 base pairs
 - (B) TYPE: nucleic acid
 - (C) STRANDEDNESS: single
 - (D) TOPOLOGY: linear

(i i) MOLECULE TYPE: DNA (genomic)

(x i) SEQUENCE DESCRIPTION: SEQ ID NO:29:

```

GGCAGCTATT TACATGGCCT CACAGGCATC AGCTGAAAAG AGGACCCMAA AAGAAATTGG      60
AGATATTGCT GGTGTTGCTG ATGTTACAAT CAGRCAGTTC TATAGACTGA TCTATCCTCG      120
AGCCCCAGAT CTGTTCTTA CAGACTTCMA ATTKGACACC CCAGTGGACA AACTACCACA      180
GCTATAAATT GAGGCAGYTA ACGTCMAATT CTTGANNACM AAACCTKNCC TGTGTACAT      240
AGCCTATACM AAATGCTGGG TTGAGCCTTT CATAAGGNAA AACMNAAGAC ATGGNTACGC      300
ATTCCAGGGC TKGANTACTT ATTGCTTGGC ATTCTTGTAT GTA                          343

```

(2) INFORMATION FOR SEQ ID NO:30:

- (i) SEQUENCE CHARACTERISTICS:
 - (A) LENGTH: 363 base pairs
 - (B) TYPE: nucleic acid
 - (C) STRANDEDNESS: single
 - (D) TOPOLOGY: linear

(i i) MOLECULE TYPE: DNA (genomic)

(x i) SEQUENCE DESCRIPTION: SEQ ID NO:30:

```

AAAGGGCTAA CCAGCCACTG CACCAAAATT AGTCCTTACA TTATAATACT CTGGCCATTG      60
GAAGAGAAAA ATGGGAAAAT TCAACAATTT GAAAGACTAT GATCCCTCTG GTCATGATC      120
TACTGACCAG AATGAAGTCC TGAAGGATTT CCTTCTGTTA TGTTATCTAC CCAGCTAATC      180
TCAAACAAGA GGAGCTGGAA AGAACAAAGC CCCATGAAGC TACCCCTAGA CCCAGAAAGC      240
CAAGAACAGG GCCAAGAAAA TGAACAGCAG ACAAGCCTGA AATAGAAGTG GNACAGACAT      300
GTGGNAAGAC CAAGTACACC CAGTTNGGTG GTAAAGATTC CGATATCAAG CTTATCGATA      360
CCG                                          363

```

(2) INFORMATION FOR SEQ ID NO:31:

- (i) SEQUENCE CHARACTERISTICS:
 - (A) LENGTH: 362 base pairs
 - (B) TYPE: nucleic acid
 - (C) STRANDEDNESS: single
 - (D) TOPOLOGY: linear

(i i) MOLECULE TYPE: DNA (genomic)

(x i) SEQUENCE DESCRIPTION: SEQ ID NO:31:

```

AGTACATGGT TTCTTGNCCA CCCASCAC CTTTCCCAT CTCTACGGY TGATAGTCTC      60
TCAGNTAGTA GACCTTTTCT NGTTTAGRCA GGGCCACNTT TTTAAAACT CCAGACGGGT      120
ACCCTCCATG TKGMAGGCGA CGTGGCCCTG GATCACTCAA CTGANTGTCA TNKGANTGGT      180
GCCCCAGAG TGAGGACAAT GGTGNAGCCC TCCTAAGGCC CTNCCTGAGT GTCCCTCCTT      240
CATGAAGATG ATTCTGAGGN TTCCAGGCC TNCACCCTTC TTKGAAARCC CATAGNAGTT      300
CATATGNACT NCTCTNCTAT GCTCACCAA CTCTNCCTTC ATCATACTTG GGGGATGTGT      360

```

-continued

G T

3 6 2

(2) INFORMATION FOR SEQ ID NO:32:

- (i) SEQUENCE CHARACTERISTICS:
 (A) LENGTH: 475 base pairs
 (B) TYPE: nucleic acid
 (C) STRANDEDNESS: single
 (D) TOPOLOGY: linear

(i i) MOLECULE TYPE: DNA (genomic)

(x i) SEQUENCE DESCRIPTION: SEQ ID NO:32:

```

GTGCATGTAA TTACAGTTAC GATATATGAA ACGTACAAAA TATTATGAGT ATATAATATG      6 0
GGGAGACTTA ATCTAGTTTG GGGGATCAGG GCACATTTCT CTAAGAAAGT GACATTTGAA      1 2 0
TTGAGCTCTG AAGGATAAAT AGACATTACC CAGAAGAATA AAATGATGGG GAAGAAGGAG      1 8 0
GACATTTTCC GTAGATTTCC AGTGGCCCN CTTGATCCCT TATCCACTCA TCACTNAGGA      2 4 0
GGATATTTAA TKCTATAGAA ATGGRAGRAA GACMMAAAGA GACCCTNATA TCTCGAGAGG      3 0 0
ATCCAGCMAA ATTCCAAGAG ACACAACAWT AAGAAACTNG GAAGGAAGAG AAAAGGCMMN      3 6 0
NNAGGNAAAA GAAAGACAAG GAAATTNWN NAGNACGGAG AGAAAGAGAG AGGGAGCGTN      4 2 0
NAAGGNACG AGAAAGGCGA GNACGGGGAC GAGAAAGGN AAGAGNACGT AAACG      4 7 5

```

(2) INFORMATION FOR SEQ ID NO:33:

- (i) SEQUENCE CHARACTERISTICS:
 (A) LENGTH: 346 base pairs
 (B) TYPE: nucleic acid
 (C) STRANDEDNESS: single
 (D) TOPOLOGY: linear

(i i) MOLECULE TYPE: DNA (genomic)

(x i) SEQUENCE DESCRIPTION: SEQ ID NO:33:

```

GGAAATAAAT GAGATCTCAG TGGTGGTATG GATTGGACTG ATCTCTGTAA CTGTGTNTGG      6 0
AAAAAGGACC GGAAAATGAA AGCCAGATCC CAGTAAGGGG TAGAGAGGGG CCAAGAGAAC      1 2 0
TGAACATCTG GGCTGCCGGA GAAATCAAAG TCTAGGAAGT AAGAGGTAAG AGTGTACTION      1 8 0
AGGGGACATA CCCCAATCTC TTGGTTCCCT CCCTCTNCCT TCCTCTCCCA GAGACCCAGG      2 4 0
TCCCTGGGAC TATNTTGGAT CTGTCTCTGA AGCTGAAAAA CAAAAGGCAG AGGAGACAGT      3 0 0
CGGNTCTAAG TGACCAATCT CAAGCCAGCT TGGTCAGAAN TCCTAA      3 4 6

```

(2) INFORMATION FOR SEQ ID NO:34:

- (i) SEQUENCE CHARACTERISTICS:
 (A) LENGTH: 433 base pairs
 (B) TYPE: nucleic acid
 (C) STRANDEDNESS: single
 (D) TOPOLOGY: linear

(i i) MOLECULE TYPE: DNA (genomic)

(x i) SEQUENCE DESCRIPTION: SEQ ID NO:34:

```

AAATCCAGTG CAGGCAACAT TATGTGGAAA TAGAAACAGG GCTCCTGCTA GGAGATTGAN      6 0
ATTCTGGCTT TCCTTTGGAA CCCCTCACTG ACTCATCGCC CCTGAANCAG GANCCANCAG      1 2 0
GTNCCAAGGC TCCCCTGCTC CTNTCCCTNC CCCAGGGCGA GATAGGAARC CGGAARCCTG      1 8 0
GGCAGGCTGA RCCCANCCGA CTGGAACCAG GGNAGANCCT GTGGGTGGGT GGNAGGGAGG      2 4 0
GAAGGAGGCC AGATTCCTCC AGAACTGGGG RAGAGAACAG GTTTTGGAAAG TTGGGGGAGG      3 0 0
GTTTGGGTTT CACAGTGATG GTTTCATGAN ACCCTGGAGG GTTNCACACT CCTGGTKCAN      3 6 0

```

-continued

TTTTGNTANT CGTNCTTTGA ANACARNCCG CTTCTTTTCA ACCCTCCNCN TAAAAAGTTT 4 2 0
TGATNTTTTA AGG 4 3 3

(2) INFORMATION FOR SEQ ID NO:35:

- (i) SEQUENCE CHARACTERISTICS:
 (A) LENGTH: 350 base pairs
 (B) TYPE: nucleic acid
 (C) STRANDEDNESS: single
 (D) TOPOLOGY: linear

(i i) MOLECULE TYPE: DNA (genomic)

(x i) SEQUENCE DESCRIPTION: SEQ ID NO:35:

ACCAAGAGCC CCCAGTTTAT GNTAACTCTC ATGACAAACA CAATTTTAGT ACCTCTCACT 6 0
 ACCAACTATC CAGGAACCAG GANTCACCTA TTA CTACGGT TCCAGCAGAA TGGGAATCCC 1 2 0
 ATTCTCGGAT ATCCAGGGTA AATCCCTGAC CATGTGAGAG GAATCCTAGT GCCCCAACAA 1 8 0
 CCTCACCCCC TGACTCCTCC TCAANGGCTC TGCCAAGTCA ACAAAAAAAT CCTCTACATT 2 4 0
 TACACTATCT GTAAAGCCAA AGACCAGCGT CAACCTAAAT GTCCATCAAT AAGGGAATGG 3 0 0
 TTGGATAAGT AAAAATTATG CAGCTGTAGG AAGGAATGAA GAATGTCTAT 3 5 0

(2) INFORMATION FOR SEQ ID NO:36:

- (i) SEQUENCE CHARACTERISTICS:
 (A) LENGTH: 512 base pairs
 (B) TYPE: nucleic acid
 (C) STRANDEDNESS: single
 (D) TOPOLOGY: linear

(i i) MOLECULE TYPE: DNA (genomic)

(x i) SEQUENCE DESCRIPTION: SEQ ID NO:36:

AAAGGGAACA AAAGCTGGTA CCGGGCCCCC CCTCGAGGTC GACGGTATCG ATAAGCTGGA 6 0
 TATCGAATCC TCGAGATCTA CCTAAAAAAA AAAAATTAAC TTCCCAAATG TGGGAGTCTA 1 2 0
 CTCTGTTCCC TCCTNGTNTT TATTNCTGTN TACTTTYCTA ANATGGTTAA AATGTGTAAN 1 8 0
 CAATATGTGT CCTTTNACTN KGGKGTGAAC ATTTTTYCTA TTATAAATYC TWAGAAAATA 2 4 0
 TTNCTATGGN TATGAGATAT TKGATTCCAA GTGCCTKGTA ATTTACTYCT CAAATGTCCC 3 0 0
 TGATGTKGGA NATTKGTTNC TAGTGTTYCA CTATTTAAAA AAACAGNAAT ATCTGTCTNT 3 6 0
 ATGCTNAGAG CTTNTYCAGT TTYCAAATTA TTNCCTTAGG GTAAAATCCT AGAAGTAGAA 4 2 0
 TTTTTGGGGC AAATTATCTA CATATTTATA ATTGTCTTGG TATTCCAAAT CTCGTTTTCC 4 8 0
 AAAAGCTTAT ATCAATTTGT ACTTAACACC AG 5 1 2

(2) INFORMATION FOR SEQ ID NO:37:

- (i) SEQUENCE CHARACTERISTICS:
 (A) LENGTH: 450 base pairs
 (B) TYPE: nucleic acid
 (C) STRANDEDNESS: single
 (D) TOPOLOGY: linear

(i i) MOLECULE TYPE: DNA (genomic)

(x i) SEQUENCE DESCRIPTION: SEQ ID NO:37:

ATTTAAGATG ACTGGGGGTC TCTNCCTAAT CCCATACTCC ACTGGAGAGG ANAAGTGGGA 6 0
 AAGGTTGGTC TAGTTARGGT NGNTGGGGAC CCTCCCAAGA GCTGNAGAAG CAGAGATAAG 1 2 0
 NAGAGCCTNC TNCTAAATCC ACATGGNCCT YCCAAGGNTC TCATCCTCTA GGACCTACCA 1 8 0

-continued

| | | | | | | |
|------------|------------|------------|------------|------------|------------|-------|
| CTNCTCAGTC | TACTTACTTG | TCTYCTGANA | TGCTTTCTNG | AGGGGNAGAA | AACAAAGGAA | 2 4 0 |
| GAGTAATAAC | AAGCAGNAGA | AACTGCAGAG | AATGNAAAAT | AAGTCCATAG | GAGAATGTTG | 3 0 0 |
| NAAATAGAAT | CATCCNCCTT | TACATATTGT | CACTCCAGGA | AAACTGCCAA | GAACCACTCA | 3 6 0 |
| TTCTCTAGA | TACAMTTTCT | GTAGGATCCY | CCCAGACTTC | CTCCCTTAAG | CACGTCAGTA | 4 2 0 |
| TTCTCCTTAT | TCTCCCTTCA | TTTCAACCCT | | | | 4 5 0 |

(2) INFORMATION FOR SEQ ID NO:38:

- (i) SEQUENCE CHARACTERISTICS:
 (A) LENGTH: 766 base pairs
 (B) TYPE: nucleic acid
 (C) STRANDEDNESS: single
 (D) TOPOLOGY: linear

(i i) MOLECULE TYPE: DNA (genomic)

(x i) SEQUENCE DESCRIPTION: SEQ ID NO:38:

| | | | | | | |
|-------------|------------|------------|------------|------------|------------|-------|
| CGAGATCTGC | CCCAGCCCAC | ATTTCTTTG | TTGAATGAGT | AGAGAAGACT | GAGAAGTATC | 6 0 |
| ACTCACCCGT | GATGTGGTTT | GTCCCTTTTC | CAGCCAGTGT | GTTGGTAATA | AAAGTCACCT | 1 2 0 |
| TTCAGAGCTT | TGGTCCCCGT | AATGCCCGTC | TTTCTGTGT | CCAGGAATAA | CCTTTGNTAC | 1 8 0 |
| TAGGCAGTCC | TCTGAAAGAT | TTGTAGAAGG | TAAAGTGGA | AAGGGACTTG | GAAGCTCATA | 2 4 0 |
| GAATCCATGC | CTCTTCTTTT | AGCATCAAGG | AATTAGAAGT | CCTGAGAGAT | GAAGAATGTT | 3 0 0 |
| GTCTTCCCAA | CTCAAACCCA | TTTCTTGAAG | CCATTTCCCT | GGTTACTGNA | TTGGCCACAA | 3 6 0 |
| CCCTTCCCCC | TTGNTATCCT | CATCCTGCTA | ATGCTGTTTT | TAATGGCCTG | CCAGTCTGGA | 4 2 0 |
| TTTGTCTTTG | GCAACCAAAC | AATTTTGCTT | CACAAGATTC | CTACTTAAGG | GAAGAGAGGG | 4 8 0 |
| GCTCCTCATT | TNTCACTTGT | ACAAGAGCAG | GGCTGGTCAG | CTTTACACAG | GTGTCAGATG | 5 4 0 |
| AACCGTCACA | ANCCAGANTT | NCATGTTGGC | CTCAGGAGGG | CTTCNAGGTC | CAACATCTCG | 6 0 0 |
| ACGTAAGGAG | CGTTCCCAGT | TCTTTCATGC | TCAGATAACA | GTNCTAACTN | CAGCTGTTTC | 6 6 0 |
| ATCCCNAAATC | CCTANTTGAG | GTCTTAACAT | CTATTCCATT | TTKCCNACMA | GGTTATNCT | 7 2 0 |
| GTTAACCCCTC | TNCACCAGAN | TTAGANCTGA | CTGATNCACT | TCCTAG | | 7 6 6 |

(2) INFORMATION FOR SEQ ID NO:39:

- (i) SEQUENCE CHARACTERISTICS:
 (A) LENGTH: 327 base pairs
 (B) TYPE: nucleic acid
 (C) STRANDEDNESS: single
 (D) TOPOLOGY: linear

(i i) MOLECULE TYPE: DNA (genomic)

(x i) SEQUENCE DESCRIPTION: SEQ ID NO:39:

| | | | | | | |
|------------|------------|------------|------------|------------|------------|-------|
| TCATACTTGT | ATAGTTCKNT | AAGATAATCA | CTCTCTCACT | CAGACATNNG | GNGRARNGCC | 6 0 |
| CNTCGATCAC | TTGGGANAGG | NGACTTGCMA | TGTTTAATGA | TTGTCANCCM | NANAANTAAG | 1 2 0 |
| CTNACAGGGC | AAAAACAGCC | TYANGTCAGT | TCTNTCTCCC | TAATCCTCTA | GRAKNAAATC | 1 8 0 |
| NNAWRNTRNN | ACTCTGNNTC | TGTGCCATNA | NANATNTTNC | ANTTGTATTT | ATGNACTCCA | 2 4 0 |
| CATNGAGTAC | ACCTCACTAA | WTNTNCTNCT | GGGNAACNCC | CSCMCCANTT | TTNNTTGNT | 3 0 0 |
| GANANACARC | AATGCTGGCA | TACNGTG | | | | 3 2 7 |

(2) INFORMATION FOR SEQ ID NO:40:

- (i) SEQUENCE CHARACTERISTICS:
 (A) LENGTH: 431 base pairs
 (B) TYPE: nucleic acid

-continued

(C) STRANDEDNESS: single
(D) TOPOLOGY: linear

(i i) MOLECULE TYPE: DNA (genomic)

(x i) SEQUENCE DESCRIPTION: SEQ ID NO:40:

```

CCAGACTTTC  ATAAGTNGTG  TTATTATGAA  GATTAGAGTN  CTGAAGCTTA  CTGGATTAGA      6 0
AGAGNACGAG  GGGGTAGCTG  CCCCAATATA  TTCTAATTTT  TCTKGAGGAC  CACCAAATNG     1 2 0
GMAGAGTGTC  TCTGATAGGG  AAAAGGAAGA  GTTGGAAAGN  ATCTTAGCCT  CTAGGANAAA     1 8 0
AGAACCATTT  TTATTGGCCA  CCAAAGTTAC  ATCTAGTKGC  CTACAAATTT  ATNTCCAAAC     2 4 0
TCCTTATCCT  GCCAATTCAG  GGTCCGNA  ACTGATGCCA  AACTATAGTT  TAGTCTNCTA     3 0 0
TCACATGACT  GCATTATACA  TACCCAATTA  TCTGGGMAAA  CAGACCTGAT  CCAAACACAG     3 6 0
TTKGGTNCTT  TCCTTNCCTT  NCCTTKGTTT  AGCCTGTYCC  GTCTACTNGG  GGTGTCTTKG     4 2 0
ATTTGCTCCA  G

```

(2) INFORMATION FOR SEQ ID NO:41:

(i) SEQUENCE CHARACTERISTICS:
(A) LENGTH: 276 base pairs
(B) TYPE: nucleic acid
(C) STRANDEDNESS: single
(D) TOPOLOGY: linear

(i i) MOLECULE TYPE: DNA (genomic)

(x i) SEQUENCE DESCRIPTION: SEQ ID NO:41:

```

TTTTTTTCCA  CCAGACTTAC  CAAATTTTAG  ATGNATGGAA  GAACTGTAAA  TNCCATAAAA      6 0
GNTAATCTAT  NCATNGACCC  CCACCATTAT  GATAGAGATC  ATNTGGTGAN  TAATGAAAGA     1 2 0
TGAAACTCTC  AGCTGGGAAA  GTAANAAGGA  ATAGGATGTA  AGTATGAGCT  CCTGTTTTTT     1 8 0
ATTATNTTTA  TGGATGCCCC  CTCAGAAAAA  TATGNAANGG  GGTAAGTAC  TNGGAAATGG     2 4 0
GTNTTTTATG  NATAGTAAGT  CCCACTCACG  AGGTTT

```

(2) INFORMATION FOR SEQ ID NO:42:

(i) SEQUENCE CHARACTERISTICS:
(A) LENGTH: 270 base pairs
(B) TYPE: nucleic acid
(C) STRANDEDNESS: single
(D) TOPOLOGY: linear

(i i) MOLECULE TYPE: DNA (genomic)

(x i) SEQUENCE DESCRIPTION: SEQ ID NO:42:

```

TCGAGATCTA  AAGCAGATGN  AGACTTTNCA  CNAATAAAT  TACTGCTTT  TTYCTGTGA      6 0
NATAAGTTNC  GAGAAGGAAA  GCTTTKGATT  NCTRATGAG  TYCAGTGGAT  TATYCTNAGN     1 2 0
ACTAGAGTKG  NKGTKGAAGN  CATGGNACAT  TTATATAGWT  YWTTCAAGTTC  TACTACTAAAT     1 8 0
GATGGAAGAA  TGAGAAATCC  TATATGACAA  ATAGAAAAGT  YCATYCTYCA  TAATTGAGAA     2 4 0
CATTGAGCAG  TTGGATTACC  AAGATCTCGA

```

(2) INFORMATION FOR SEQ ID NO:43:

(i) SEQUENCE CHARACTERISTICS:
(A) LENGTH: 580 base pairs
(B) TYPE: nucleic acid
(C) STRANDEDNESS: single
(D) TOPOLOGY: linear

(i i) MOLECULE TYPE: DNA (genomic)

-continued

(x i) SEQUENCE DESCRIPTION: SEQ ID NO:43:

```

CTTAGTTTTA GACTAGTTTC ATTATACTAC CAGTTTCTAA TATGTTGGTT TTTTATTCAC      6 0
TATTTGATAT ATTTGTTTTA ATATATGTTC TTGTTTTAGC AGGTAAAAGA ATCATAACAA      1 2 0
ATGTTTTTAA AAGAACATTA TTATTCCTTA ATAACGTCT TTTTATGCAT TTGGCATGCC      1 8 0
AACTTTTTTC ATTAACATCT TGGGTATTTT ATAAAAAGAG GGAAAGCTCA ATGTTTAAACA      2 4 0
GGTAGCTTTT CTTAGGAGCT AAATTAATA TTTAACAAAT CTCCTTCCCT TCNCCCTTCC      3 0 0
CCATCCCTCA AAGNATGGGT GNANTTATCT TTAACCTTTG GGCTNGCATC CNTGNAAGCT      3 6 0
TATGGNTANT CATAGTCTNA CMAAACTAGG GTCACCNAAC TTGGCAGCAG AAATAATCTA      4 2 0
GTCTTACTGT GATAACTACC CAATTACTTT ATTATTTTTT CAGTTNCAGT TCCAAATGTT      4 8 0
TTGTGGNAAN AATTTTTNCT GTTTGTGATT TTCCAAGCTT AGAGGGGGAA ACCAACTTTC      5 4 0
CAGTGTGGA GAGCACTGNA TAGTTTATGN ATTGTGTAAA      5 8 0

```

(2) INFORMATION FOR SEQ ID NO:44:

```

( i ) SEQUENCE CHARACTERISTICS:
  ( A ) LENGTH: 347 base pairs
  ( B ) TYPE: nucleic acid
  ( C ) STRANDEDNESS: single
  ( D ) TOPOLOGY: linear

```

(i i) MOLECULE TYPE: DNA (genomic)

(x i) SEQUENCE DESCRIPTION: SEQ ID NO:44:

```

TGTTTCTTAA NACAGAAAAA AATTTACTGA TNGGACATTG TTCTAAGTGT ATTATTGTAT      6 0
TAAATGGATC ATTTAATTTA ATCTTCATAA CTGACATAGG AGTTGAGTAA CTTGTGTGGT      1 2 0
CAAATAGCTA GTAAGTGATG AGTAGGCTGG GCGCAGTGGC TCAAGCCTGT AATCCCAGCA      1 8 0
CTCTGGGAGG CTGAGGCAGG CAGATCACTT GAGGTCAGGA GTTTGAGACC AGCCTGGNCA      2 4 0
ACATGGNAAA ACCTCGTCTC TACTAAAAAT AAAAAAATTA GCTGGGCGTG GTGGGNGCGC      3 0 0
ACTTGTAGNC CCAGNTACTC GGAAGGCTGA GGCAGGAGGA ATCGCTT      3 4 7

```

(2) INFORMATION FOR SEQ ID NO:45:

```

( i ) SEQUENCE CHARACTERISTICS:
  ( A ) LENGTH: 430 base pairs
  ( B ) TYPE: nucleic acid
  ( C ) STRANDEDNESS: single
  ( D ) TOPOLOGY: linear

```

(i i) MOLECULE TYPE: DNA (genomic)

(x i) SEQUENCE DESCRIPTION: SEQ ID NO:45:

```

GCTCATCATG CTTACAGGGG GAGGCTGTGC GGAAGAATG CTCCCACACA GNATAAAGAA      6 0
TGCTCCCGCA CAGGATAGAG AATGCCCCCG CACAGCATAG AGAAGCCCCC GCACAGCATA      1 2 0
GAGAATGCCC CCNCACAGCA TAGAGAAGCC CCCGCACAGN ATAGAGAATG CTCTTCACCT      1 8 0
CTGGGTTTTT AACCAGCCAA ACTAAAATCA CAGAGGGCAA CACATCATT AAGATAGAAA      2 4 0
TTTCTGTATC TTTAATTTT TTTCAAAGTA GTTTTACTTA TTTNCAGATT CTATTTCTTT      3 0 0
ACTAGAATTA AGGATAAAA TAACAATGTG TGCATAATGA ACCCTATGAA ACAAACAAAA      3 6 0
GCTAGGTTTT NTNCATAGGT CTNCTTCCNN ATTGAATGAA CGTCTNTCCT CAAATTTANC      4 2 0
CCCCCAGGGA      4 3 0

```

(2) INFORMATION FOR SEQ ID NO:46:

(i) SEQUENCE CHARACTERISTICS:

-continued

(A) LENGTH: 400 base pairs
 (B) TYPE: nucleic acid
 (C) STRANDEDNESS: single
 (D) TOPOLOGY: linear

(i i) MOLECULE TYPE: DNA (genomic)

(x i) SEQUENCE DESCRIPTION: SEQ ID NO:46:

```
CAAACCCCTAT GNGAAATGGA AAGGAAACTA TTCTAAAGCA TAAAAGGTAG AAATATATAT      6 0
ACCACCCATC  AAGAAAGATT ATTTTGTNTG AACTCAAGTC ACCAGAGTGG CTAAAGCCCA      1 2 0
GTAGAATGGA  AATGATTATA TGGAAAGGTGA GGCCAACGGG ACCAGAACAT ACTGTGATAG      1 8 0
ACAGNAAGGA  GCTGTCTATC TTCTATTCTC CCACAGAAGG AGGTGACTAA GTCANCTGCC      2 4 0
CAAGCAATGT  TATATCTGCA ATTGATGTNC AGCAGTACAA GTCTGAACAA CTTGGATTGG      3 0 0
NTGATTAATG  TCCACANTAA ACATACAAGT CNTAATAGCT ATCTCTATAT AGTCTTTGGG      3 6 0
TNTTTACAAG  GCACTGNCAC ATNATCTCAC CTATTCCTCC      4 0 0
```

(2) INFORMATION FOR SEQ ID NO:47:

(i) SEQUENCE CHARACTERISTICS:
 (A) LENGTH: 500 base pairs
 (B) TYPE: nucleic acid
 (C) STRANDEDNESS: single
 (D) TOPOLOGY: linear

(i i) MOLECULE TYPE: DNA (genomic)

(x i) SEQUENCE DESCRIPTION: SEQ ID NO:47:

```
AGNATCCAGA ATTGAGTGNA GNGTTCTCTG GNCCACAGTC TCGGTATCTN CTGTGAAATG      6 0
GGGTATAGAT TCTACAATAA AACAAACACA NNGGCCCTAG GTCAGTGTTA ATGGAGATCA      1 2 0
CCANCCACAT TACCACCTCC AACACAGAAT TTTCTTTTTT TTAATNCAAT NCGTNTCTTA      1 8 0
TAAGTCACTT TNCCCCAACT CACCAATCTA GNTAAGAATT TTTACCCTGA GAAAAACAGC      2 4 0
TACACTCTAA AATTGCTNCA AAGAAAATGT CTAACATNTG GAAAGAAGGA CTTAACATGT      3 0 0
GANGNAGACA CTGGCTCCAT CTAGNGGGTG CTTTNTTTTG AAATAATTAT AATNCCNCAT      3 6 0
CAAATTTTNG GGGGNTACAG CTTATTAGGA ACTTGTTATA GAACCAGATT CTGCCACAGA      4 2 0
ANCCACGTGG GTTGACAAGT GGTGNCAGA AGAAAGGTAA TATGGCTTAT NATTAGGGNC      4 8 0
TCNCATCTGC AGAGTAATTG      5 0 0
```

(2) INFORMATION FOR SEQ ID NO:48:

(i) SEQUENCE CHARACTERISTICS:
 (A) LENGTH: 460 base pairs
 (B) TYPE: nucleic acid
 (C) STRANDEDNESS: single
 (D) TOPOLOGY: linear

(i i) MOLECULE TYPE: DNA (genomic)

(x i) SEQUENCE DESCRIPTION: SEQ ID NO:48:

```
AAAATGCTTG ANNCAAATGT CATCTAGTTC CATCTCTACG ACTCTCATGG GGTCCAAAGA      6 0
AGAGTTTTAN TTGAGTTTTA GAATGTGAAG TTGTGAAGTG TCTGAAAAAC TACATGGTGN      1 2 0
TCTGAAAGNC AAAC TTTTAG CCTTGGGGGA GAGCATCTAA GACAGNAGGT GAAGGGNAGG      1 8 0
GGTTAGAACT AGAGGGATTG AAGAATATTA TCCATATAGG TTAGGGTTAG GTNNGGCAAC      2 4 0
GTTTTATAGA ACAAACATTG GCAAGCTACA GCCACAGGCC AGATCTGTCT NCTACCTTCC      3 0 0
CACAAAGGTG TAATAACAAA GTTATTCACA AATGTGTGAA TAAACTNNCA TTGGAAAGTG      3 6 0
CCCACGCTCC TNGGTTTATA CATTGTCTGT GGCTGCTTTC ACACTACAGT AGCACAGGTG      4 2 0
```

-continued

AGTGTNTGCA CTGGAGACCA TATGCCCCAT AGAGCTTTAA

4 6 0

(2) INFORMATION FOR SEQ ID NO:49:

- (i) SEQUENCE CHARACTERISTICS:
 - (A) LENGTH: 370 base pairs
 - (B) TYPE: nucleic acid
 - (C) STRANDEDNESS: single
 - (D) TOPOLOGY: linear

(i i) MOLECULE TYPE: DNA (genomic)

(x i) SEQUENCE DESCRIPTION: SEQ ID NO:49:

```

ATCAAGCAAC AGTGTGTTAT GCCTATACTC CATGTTTATA TGTGTGTATT AAAAAATGTA      6 0
TTTGTATATA TGTGTATGTA TAAGTGTGTG TGTGTGTATG ATGATTCTNC TCCCGNTTTG      1 2 0
AAGGTGAAAG AAAGCACACC TTTATTTAAG CATAAACTTT GGGTTTCAGA TACTGTCTGG      1 8 0
AAAAATGATT TATCTCCCAC TTTGAAATTC CAAAATACGT ACATATATTT TTTTTTTCTT      2 4 0
TTCTTTTTTA GTTTNAGGGT CTTGCTGTGT TGCCCAGGCT GGAGTGCAGT AGTGTGATCA      3 0 0
TAGNTCACAC AGNCTCTAAC TCCCAGGNTC AAGNTATCTT CCTGCCCCAG NCTCCTGAGT      3 6 0
AGNTGGGACT                                     3 7 0

```

(2) INFORMATION FOR SEQ ID NO:50:

- (i) SEQUENCE CHARACTERISTICS:
 - (A) LENGTH: 500 base pairs
 - (B) TYPE: nucleic acid
 - (C) STRANDEDNESS: single
 - (D) TOPOLOGY: linear

(i i) MOLECULE TYPE: DNA (genomic)

(x i) SEQUENCE DESCRIPTION: SEQ ID NO:50:

```

CAAAAAATCA AAGGGAAGNT GGAACCCCTG CCCACCTCTC CATTCCCAT TCTGCTGGTG      6 0
GTGNCTGCTC TTCCTCACAG TACCTCCTGA AAAGTTCAGA ATTCAGTTAA TACAGAATTA      1 2 0
TTGGGTTGAT TTTCAACGTG TAGTTTAAGA TGAAGAGTTC CGNTTGGTTT AAACCACTTC      1 8 0
ACCTAACCTC TTGGTAACGG TAGTCCTGAG AGTTCGCAGT GTCANTGAAA ATCGTCCTGT      2 4 0
GACCACGCGT CAAGCTGCTG ATGGGGGACA GAAACTTCCG GGNCTATCAT ATCTCCTTGA      3 0 0
NCTCGGCCCT CAAATCTGGT AGTTTCTGCA CCGAGGGACA CAGTCCACTG CGATGAAGTA      3 6 0
TGTTCAAAAT CGNTTCTTT AGGGAACTCC TTCCAAAGTC CAATAGTGNA AGGTGGTCAA      4 2 0
GGAAGGATTT GGAAGGAAGN TGNAAAAGTC AGNCGGGAAT CTTGATTTGG NTAGNTGTGG      4 8 0
ANANAGGAAA TCACTTGGCC                                     5 0 0

```

(2) INFORMATION FOR SEQ ID NO:51:

- (i) SEQUENCE CHARACTERISTICS:
 - (A) LENGTH: 105 base pairs
 - (B) TYPE: nucleic acid
 - (C) STRANDEDNESS: single
 - (D) TOPOLOGY: linear

(i i) MOLECULE TYPE: DNA (genomic)

(x i) SEQUENCE DESCRIPTION: SEQ ID NO:51:

```

GGAAAGAGGT CTCCTAACAC CCAGACAGTG TAAAAATCCA GTTTTTCTTC CTTTTGGNNG      6 0
GAGACAGAGT CTCGCACTGT AGCTCAGGCT GGAGTGCAGT GGCAC                                     1 0 5

```

(2) INFORMATION FOR SEQ ID NO:52:

-continued

(i) SEQUENCE CHARACTERISTICS:
 (A) LENGTH: 386 base pairs
 (B) TYPE: nucleic acid
 (C) STRANDEDNESS: single
 (D) TOPOLOGY: linear

(i i) MOLECULE TYPE: DNA (genomic)

(x i) SEQUENCE DESCRIPTION: SEQ ID NO:52:

```

AGTCCCAGCT  ACTCAGGAGG  CTGGGGCAGG  AAGATAGCTT  GAGCCTGGGA  GTTAGAGGCT      6 0
GTGTGAGCTA  TGATCACACT  ACTGCACTCC  AGCCTGGGCA  ACACAGCAAG  ACCCTAAAAC     1 2 0
TAAAAAAGAA  AAGAAAAAAA  AAATATATGT  ACGTATTTTG  GAATTTCAA  GTGGGAGATA     1 8 0
AATCATTTTT  CCAGACAGTA  TCTGAAACCC  AAAGTTTATG  CTTAAATAAA  GGTGTGCTTT     2 4 0
CTTTCACCTT  CAAAGCGGGA  GAAGAATCAT  CATACACACA  CACACACTTA  TACATACACA     3 0 0
TATATACAAA  ATACATTTTT  TAATACACAC  ATATAAACAT  GGAGTATAGG  CATAACACAC     3 6 0
TGTTGCTTGA  TAAAATATAG  GGATCC                               3 8 6

```

(2) INFORMATION FOR SEQ ID NO:53:

(i) SEQUENCE CHARACTERISTICS:
 (A) LENGTH: 377 base pairs
 (B) TYPE: nucleic acid
 (C) STRANDEDNESS: single
 (D) TOPOLOGY: linear

(i i) MOLECULE TYPE: DNA (genomic)

(x i) SEQUENCE DESCRIPTION: SEQ ID NO:53:

```

TATATTTNAT  CAAGCAACAG  TGTGTTATGC  CTATACTCCA  TGTTTATATG  TGTGTATTAA      6 0
AAAATGTATT  TGTATATATG  TGTATGTATA  AGTGTGTGTG  TGTGTATGAT  GATTCTCCTC     1 2 0
CCGNTTGAAG  GTGAAAGAAA  GCACACCTTT  ATTTAAGCAT  AAACCTTTGGG  TTTCAGATAC     1 8 0
TGTCTGGAAA  AATGATTTAT  CTCCCCTTT  GAAATTCCAA  AATACGTACA  TATATTTTTT     2 4 0
TTTTCTTTTC  TTTTTTAGTT  TNAGGGTCTT  GCTGTGTTGC  CCAGGCTGGA  GTGCAGTAGT     3 0 0
GTGATCATAG  NTCACACAGG  CTCTAACTCC  CAGGNTCAAG  CTATCTTCCT  GCCCCAGNCT     3 6 0
CCTGAGTAGG  TGGGACT                               3 7 7

```

(2) INFORMATION FOR SEQ ID NO:54:

(i) SEQUENCE CHARACTERISTICS:
 (A) LENGTH: 521 base pairs
 (B) TYPE: nucleic acid
 (C) STRANDEDNESS: single
 (D) TOPOLOGY: linear

(i i) MOLECULE TYPE: DNA (genomic)

(x i) SEQUENCE DESCRIPTION: SEQ ID NO:54:

```

CTGCAGTAAG  CCACGTTTCA  GCCACTGTAC  TCTAGCGTGG  ATGACAGAGA  GAGATCCTGT      6 0
CTTTGGAAGA  AAAAAACAAA  AAGAAAAAAA  AAAGAGTATG  GCCATGGCCT  TATAATATAG     1 2 0
AAGGGGTCAC  ATATTAATCT  CTGAAAATGG  ATCTCTTGTG  GGCTTTCATA  CAAGGCAACA     1 8 0
GCCACAGAGT  ACGTACCTGA  AAGCTGCCTG  GGNTTAATGG  CTGGNAGTAT  GTTCTAACTN     2 4 0
GTTTCAGGNAC  CCATGTCACN  ACTGGTGGTT  ACAGAATGTG  AATCTCACAC  TGTCCNAAAT     3 0 0
CGGTTTTATT  TTTAAAANGA  ATAATTCTAN  TACATTACCT  TATAAAAAGT  AGGTAACCTA     3 6 0
ATTTTGGNTT  TTAAAAGTGA  ATTGAGGGCA  GATGCAAGTG  GNTCACACCT  ATTAATCCCA     4 2 0
AATACCTTGG  AGAGGGCAAG  GTAGGAGGAT  TGGTTGGAGC  CCAGGAGTCC  AAAGACCAGG     4 8 0

```

-continued

CTAGGGAATA TTGNAAGAAN GTCCTCTCTA CAANAAANAA T

5 2 1

(2) INFORMATION FOR SEQ ID NO:55:

- (i) SEQUENCE CHARACTERISTICS:
 (A) LENGTH: 516 base pairs
 (B) TYPE: nucleic acid
 (C) STRANDEDNESS: single
 (D) TOPOLOGY: linear

(i i) MOLECULE TYPE: DNA (genomic)

(x i) SEQUENCE DESCRIPTION: SEQ ID NO:55:

CTGCANGAAG CTTTTNTTNC TTTTNGGNGG AGACAGAGTC TTGCTGTGTC ANCCCAGGCT 6 0
 GGGGTGCAGT GGNACAGTCA TAGCTCACTG CAACCTTGAA CTCCCTGGNT CATGCGATCC 1 2 0
 TCCCACTTCA GCCTCTCAAG TAGCTAGAAC TACAGGTGTG CACCACCATG CCTGACTAAC 1 8 0
 TTGTTTATTN GNGGGAGAGA GAACGNTCTT GCTATATTGC CTAGGCTGGT CNTTGAAGTCT 2 4 0
 TTGGGNTNCA AGCAATCCTC CTACCTTGGC CTCTNCAAGG TANTTGGGAT TNATAGGTGT 3 0 0
 GAGCCACNTG CATCTGGCCT CAATTCACCT TAAAAATNCA AAATTAGGTT ACCTACTTTT 3 6 0
 TATAAGGTAA TGTATTAGAA TTATTCTTNN NAAAAATAAA ACCGATTTGG GAAAGNGTGA 4 2 0
 GANTCACATT CTGTAACCAC CAGTGGTGAA ATGGGTCCCC GAACAAGGTA GAACATACTC 4 8 0
 CCAGCCATTA ACCCCAGGGA GNGTTCAAGT CCGTNC 5 1 6

(2) INFORMATION FOR SEQ ID NO:56:

- (i) SEQUENCE CHARACTERISTICS:
 (A) LENGTH: 505 base pairs
 (B) TYPE: nucleic acid
 (C) STRANDEDNESS: single
 (D) TOPOLOGY: linear

(i i) MOLECULE TYPE: DNA (genomic)

(x i) SEQUENCE DESCRIPTION: SEQ ID NO:56:

GGATCCTGTT TCTTAAAACA GAAAAAATT TACTGATAGN ACATTGTTCT AAGTGTATTA 6 0
 TTGTATTTAA TGGATCATTT AATTTAATCT TCATAACTGA CATAGGAGTT GAGTAACTTG 1 2 0
 TGTGGTCAAA TAGCTAGTAA GTGATGAGTA GGCTGGGCGC AGTGGNTCAA GCCTGTAATC 1 8 0
 CCAGCACTCT GGGAGGCTGA GGCAGGCAGA TCACTTGAGG TCAGGAGTTT GAGACCAGCC 2 4 0
 TGGCCAACAT GGNAAAACCT CGTCTCTACT AAAAATACAA AAATTAGCTG GGCGTGGTGG 3 0 0
 GTGCGCACTT GTAGTCCCAG CTA CT CGGAA GGGTTGAGGC AGGAGGAATC GCTTGGTCCC 3 6 0
 CGGGAGGGAG AGGTTGNTNG TGNAGCTGAG ATCACGCCAC TNGCACTCCA GGCTGGGNAA 4 2 0
 CAAAAGGGAG ACCTTTNCTC AAAAAAAT NAAAAATAAA AGTGATGAGT AGGATTGGGA 4 8 0
 CCCNAGACAT CTTTTCTCCA AGACC 5 0 5

(2) INFORMATION FOR SEQ ID NO:57:

- (i) SEQUENCE CHARACTERISTICS:
 (A) LENGTH: 500 base pairs
 (B) TYPE: nucleic acid
 (C) STRANDEDNESS: single
 (D) TOPOLOGY: linear

(i i) MOLECULE TYPE: DNA (genomic)

(x i) SEQUENCE DESCRIPTION: SEQ ID NO:57:

CTGCAGNCTC AAACCCTTGT CCTGGGATCA AACAATCCTC CCACCTCAGC CTTCAAAGTA 6 0

-continued

| | | | | | | |
|------------|------------|------------|------------|-------------|------------|-------|
| GATAGAACTA | CAGGCATGCA | CTACCATGCC | TAATTTTTTA | AAAAAAAAATT | TTTTTTCAGA | 1 2 0 |
| GATGAGATCT | CACTGTGTTT | CCCAGGNTTG | TCCGGAACTC | CTGGACTCAA | GCGATCCTCC | 1 8 0 |
| CACCTTGGGC | TGCCAAAGTG | TTGGGATTAC | AGGCATGAGC | CACCATGCCT | GGCCATACAC | 2 4 0 |
| TTTTTTTTTT | TTTTTAANCA | AGACGGAGTC | TNGTTCTGTC | GCCCAGACTG | GAGTGCAGGG | 3 0 0 |
| GCGTNNATCT | TGGCTCACTT | GAAAGCTTCG | CCTCCCAGGG | TTCATGCCGT | TCTCCTGNCT | 3 6 0 |
| CAGCCTCCCA | AGTNGGTGGG | ACTACAGGNA | TCTGCACCAC | GNCCGGTTAT | TTNTTGGGTT | 4 2 0 |
| TGNNGNAGGG | ACGGGGTTTC | ACCATGTTAG | GCAGGATGAC | TTCGGACTTC | CNGACCCAAG | 4 8 0 |
| ATCACCTGCT | TCGGCTCCCA | | | | | 5 0 0 |

(2) INFORMATION FOR SEQ ID NO:58:

- (i) SEQUENCE CHARACTERISTICS:
 - (A) LENGTH: 440 base pairs
 - (B) TYPE: nucleic acid
 - (C) STRANDEDNESS: single
 - (D) TOPOLOGY: linear

(i i) MOLECULE TYPE: DNA (genomic)

(x i) SEQUENCE DESCRIPTION: SEQ ID NO:58:

| | | | | | | |
|------------|------------|------------|------------|------------|------------|-------|
| GAATTCCAGA | CGAGCCTGGG | CAACACAGTG | AGACTCTATC | ACTACAAAAA | AATTTTAAAA | 6 0 |
| TTAGCTAAAG | TTGATGGNAC | ATGCCTGCAG | TCCAGCTAC | TCAGGAGGCT | GGGGCAGGAA | 1 2 0 |
| GATAGCTTGA | GCCTGGGAGT | TAGAGGCTGT | GTGAGCTATG | ATCACACTAC | TGCACTCCAG | 1 8 0 |
| CCTGGGCAAC | ACAGCAAGAC | CCTAAAATA | AAAAAGAAAA | GAAAAAAAAA | ATATATGTAC | 2 4 0 |
| GTNTTTGGGG | AATTTCAAAG | TGGGAGATAA | ATCATTTTTT | CAGACAGTNT | CTTGAAACCC | 3 0 0 |
| AAAGTTTATG | CTTAAATAAA | GGTGTGCTTT | CTTTCACCTT | CAAANGCGGG | AGAAGGATCA | 3 6 0 |
| TCATNCACAC | ACACACACTN | ATCATNCACA | TTTTTACAAA | TNCAATTNNN | NAATACAACA | 4 2 0 |
| CATTTTAACA | TGGGGTTTTG | | | | | 4 4 0 |

(2) INFORMATION FOR SEQ ID NO:59:

- (i) SEQUENCE CHARACTERISTICS:
 - (A) LENGTH: 513 base pairs
 - (B) TYPE: nucleic acid
 - (C) STRANDEDNESS: single
 - (D) TOPOLOGY: linear

(i i) MOLECULE TYPE: DNA (genomic)

(x i) SEQUENCE DESCRIPTION: SEQ ID NO:59:

| | | | | | | |
|------------|------------|--------------|------------|------------|------------|-------|
| GGATCCTGTT | TCTTAAAACA | GAAAAAAAAATT | TACTGATAGN | ACATTGTTCT | AAGTGTATTA | 6 0 |
| TTGTATTAAA | TGGATCATTT | AATTTAATCT | TCATAACTGA | CATAGGAGTT | GAGTAACTTG | 1 2 0 |
| TGTGGTCAAA | TAGCTAGTAA | GTGATGAGTA | GGCTGGGCGC | AGTGGCTCAA | GCCTGTAATC | 1 8 0 |
| CCAGCACTCT | GGGAGGCTGA | GGCAGGCAGA | TCACTTGAGG | TCAGGAGTTT | GAGACCAGCC | 2 4 0 |
| TGGCCAACAT | GGNAAAACCT | CGTCTCTACT | AAAAATACAA | AAATTAGCTG | GGCGTGGTGG | 3 0 0 |
| NTGCGCACTT | GTAGTCCCAG | CTACTCGGAA | GGCTNGAGGC | AGGAGGAATC | GCTTGATCCC | 3 6 0 |
| NGGGAGGGAG | AGGTTGGTNG | TGANGCTGAG | ATCACGNCAC | TTGNACTCCA | GNCTGGGNAA | 4 2 0 |
| CAAANGNGAG | ATCTTNTCTC | AAAAAAAAAAT | AAAANTAAAA | NGTGATGAGT | AGGATTTGGA | 4 8 0 |
| CCCCAGACAT | CCTNTCTCCA | GGACCTGGNA | TTC | | | 5 1 3 |

(2) INFORMATION FOR SEQ ID NO:60:

- (i) SEQUENCE CHARACTERISTICS:

-continued

(A) LENGTH: 390 base pairs
 (B) TYPE: nucleic acid
 (C) STRANDEDNESS: single
 (D) TOPOLOGY: linear

(i i) MOLECULE TYPE: DNA (genomic)

(x i) SEQUENCE DESCRIPTION: SEQ ID NO:60:

```
GAATTTCCTGG NCTCAAGTGA TCCTCTCACC TCAGCCTCCC AAATTGCTGG GATTAGAGTG      6 0
TGAGCCACTG TGCCTAGCCT GCATATATCT ATTTTAAATG ACTGCTAAAT CTCATTGTAT      1 2 0
GAAAATTTAT GTCCTAGCTA TAAAATTTGN TAGCACATGT TTAATTTTTT CTAATTTTCAG      1 8 0
ATGTTTTAAA CTAATATTTT CCAAAGTATA GTATGGCATT TTAGGTATGA TATGATCTTT      2 4 0
NNTCCTCTTC G TACTCATTT TTATAGTTAT GGCCTGTGCA ACTGGTTTCC CATTATATG      3 0 0
AATGATACAG AGCTTCCTAT TAAGAAAAAG TTCAGCTTGG GGAAAAAAA AGTGAATTGT      3 6 0
CAACTTNGAG GGAAAAAAGT GAATTATTGG      3 9 0
```

(2) INFORMATION FOR SEQ ID NO:61:

(i) SEQUENCE CHARACTERISTICS:
 (A) LENGTH: 366 base pairs
 (B) TYPE: nucleic acid
 (C) STRANDEDNESS: single
 (D) TOPOLOGY: linear

(i i) MOLECULE TYPE: DNA (genomic)

(x i) SEQUENCE DESCRIPTION: SEQ ID NO:61:

```
TCAAGTACCT CCCTGAATGG ACTGCGTGGC TCATCTTGGC TGTGATTTCA GTATATGGTA      6 0
AAACCCAAGA CTGATAATTT GTTTGT CACA GGAATGCCCC ACTGGAGTGT TTTCTTTCCT      1 2 0
CATCTCTTTA TCTTGATTTA GAGAAAATGG TAACGTGTAC ATCCCATAAC TCTTCAGTAA      1 8 0
ATCATTAAAT AGCTATAGTA ACTTTTTTCAT TTGAAGATTT CGGCTGGGCA TGGTAGCTCA      2 4 0
TGCCTGTAAT CTTAGCACTT TGGGAGGCTG AGGCGGGCAG ATCACCTAAG CCCAGAGTTC      3 0 0
AAGACCAGCC TGGGCAACAT GGCAAAACCT CGTATCTACA GAAAATACAA AAATTNGNCG      3 6 0
GGNATG      3 6 6
```

(2) INFORMATION FOR SEQ ID NO:62:

(i) SEQUENCE CHARACTERISTICS:
 (A) LENGTH: 498 base pairs
 (B) TYPE: nucleic acid
 (C) STRANDEDNESS: single
 (D) TOPOLOGY: linear

(i i) MOLECULE TYPE: DNA (genomic)

(x i) SEQUENCE DESCRIPTION: SEQ ID NO:62:

```
AACACCAGGG NCATGAGGGC ACTAATCATA ATGAGATATG CCTGCTGGAG TCGAAGTGGA      6 0
CCTTTCAGT GAATGGAAAT CATTCCCACC ACACCAAAAT TCCAGATCAG GAGTGNAACA      1 2 0
GTAATGTAGT CCACAGCAAC GTTATAGGTT TTAAACACTT CCCTGAAAAA AAATTACACA      1 8 0
GATTTTAAAA GATGTACAAT AATTTCCACC AAAACATTAT TTAGAATAAT GTGATGGCTC      2 4 0
CCAAACATTA GATATTAATN TCCCACCTTT ATAATTTTAC CATAACCTAT ATCAACTGTG      3 0 0
CTATTATTTA TTTAATNCTT CCCTNTAAAT TAATTTACTC TTTTTTTGTT TTTGTTTTTG      3 6 0
NGTTTGGAGC CAGTGTCTCA TTTTGGTTGC CCAGGCTTGG AGTAAAGTGG GTGCAATCAC      4 2 0
GGCTCAACTG NAGTCTTNC CTCCNGGAGA TCAGGTNGGT CTCCCCAGG TCCAANCTCC      4 8 0
TAAGTTGGTT NGGANAAC      4 9 8
```

-continued

(2) INFORMATION FOR SEQ ID NO:63:

- (i) SEQUENCE CHARACTERISTICS:
 (A) LENGTH: 469 base pairs
 (B) TYPE: nucleic acid
 (C) STRANDEDNESS: single
 (D) TOPOLOGY: linear

(i i) MOLECULE TYPE: DNA (genomic)

(x i) SEQUENCE DESCRIPTION: SEQ ID NO:63:

```

TAAACAACAG  GGNCATGAGG  GCACTAATCA  TAATGAGATA  TGCCTGCTGG  AGTCGAAGTG      6 0
GACCTTTCCA  GTGAATGGAA  ATCATTCCCA  CCACACCAAA  ATTCCAGATC  AGGAGTGAAA     1 2 0
CAGTAATGTA  GTCCACAGCA  ACGTTATAGG  TTTTAAACAC  TTCCCTGAAA  AAAAATTACA     1 8 0
CAGATTTTAA  AAGATGTACA  ATAATTTCCA  CAAAACATT  ATTTAGAATA  ATGTGATGGC     2 4 0
TCCCAAACAT  TAGATATTAA  TNTCCACCT  TTATAATTTT  ACCATAACCT  ATATCAACTG     3 0 0
TGCTATTATT  TATTTAATNC  TTCCCTCTAA  ATTAATTTAC  TCTTTTTTTG  TTTTTGTTTT     3 6 0
TGTGTTTGGA  GCCAGTGTCT  CATTTTGGTT  GCCCAGGCTT  GGAGTAAAGT  GGGTGCAATC     4 2 0
ACGGCTCAAC  TGNAGTCTTT  ACCTCCCGGA  GATCANGTTG  GTCTTTCCC      4 6 9

```

(2) INFORMATION FOR SEQ ID NO:64:

- (i) SEQUENCE CHARACTERISTICS:
 (A) LENGTH: 370 base pairs
 (B) TYPE: nucleic acid
 (C) STRANDEDNESS: single
 (D) TOPOLOGY: linear

(i i) MOLECULE TYPE: DNA (genomic)

(x i) SEQUENCE DESCRIPTION: SEQ ID NO:64:

```

GTTTATCAAG  TACCTCCCTG  AATGGACTGN  GTGGCTCATC  TTGGCTGTGA  TTTCAGTATA      6 0
TGGTAAAACC  CAAGACTGAT  AATTTGTTTG  TCACAGGAAT  GCCCCACTGG  AGTGTTTTTCT    1 2 0
TTCCTCATCT  CTTTATCTTG  ATTTAGAGAA  AATGGTAACG  TGTACATCCC  ATAACTCTTC     1 8 0
AGTAAATCAT  TAATTAGCTA  TAGTAACTTT  TTCATTTGAA  GATTTCCGGCT  GGGCATGGTA     2 4 0
GCTCATGCCT  GTAATCTTAG  CACTTTGGGA  GGCTGAGGCG  GGCAGATCAC  CTAAGCCCAG     3 0 0
AGTTCAAGAC  CAGCCTGGGC  AACATGGCAA  AACCTCGTAT  CTACAGAAAA  TACAAAAATT     3 6 0
AGCCNGGNAT                                     3 7 0

```

(2) INFORMATION FOR SEQ ID NO:65:

- (i) SEQUENCE CHARACTERISTICS:
 (A) LENGTH: 316 base pairs
 (B) TYPE: nucleic acid
 (C) STRANDEDNESS: single
 (D) TOPOLOGY: linear

(i i) MOLECULE TYPE: DNA (genomic)

(x i) SEQUENCE DESCRIPTION: SEQ ID NO:65:

```

GTCATGGTGT  TGGCGGGGAG  TGTCTTTTAG  CATGCTAATG  TATTATAATT  AGCGTATAGT      6 0
GAGCAGTGAG  GATAACCAGA  GGTCACCTCT  CTCACCATCT  TGGTTTTGGT  GGGTTTTGGC     1 2 0
CAGCTTCTTT  ATTGCAACCA  GTTTTATCAG  CAAGATCTTT  ATGAGCTGTA  TCTTGTGCTG     1 8 0
ACTTCCTATC  TCATCCCGNA  ACTAAGAGTA  CCTAACCTCC  TGNAAATTGA  AGNCCAGNAG     2 4 0
GTCTTGGCCT  TATTTNACCC  AGCCCCTATT  CAAAATAGAG  TNGTTCTTGG  NCCAAACGCC     3 0 0

```

-continued

CCTGACACAA GGATTT

3 1 6

(2) INFORMATION FOR SEQ ID NO:66:

- (i) SEQUENCE CHARACTERISTICS:
 (A) LENGTH: 448 base pairs
 (B) TYPE: nucleic acid
 (C) STRANDEDNESS: single
 (D) TOPOLOGY: linear

(i i) MOLECULE TYPE: DNA (genomic)

(x i) SEQUENCE DESCRIPTION: SEQ ID NO:66:

```

CTGCAGNCCG GGGGATCCTG GTAAAAGTCA CAAGGTCAGC CTAATAAAGC AGGGAAAAC 6 0
AAAGGCAAGT AAACACGTGC AGACAAAAAA AGGGATAAAG AAAAGGAATT AAGAAACTAG 1 2 0
CATTTTTAAN GTGGGGGAGG TGAATGCTTC CCAGAATGGG TTTATATCAC TTGCTTGNGG 1 8 0
GCCTTCTGAG TGTGNAAC AACCTGTCAT CATCACACAT ACCTGTCATC TTTAATGGTC 2 4 0
TCCATACATT ACTAATAGAT TATACAGATG GCCATCACTT AACACTTCCA CTCACTCAAT 3 0 0
TTGTNCAACA TGCAAGGTTA CCCTCTTTTT TNGCTTACNG CCACAAAGCA TTGGANAAGG 3 6 0
TTTGTGATTT TTAGCCN CCACTTCATC AAATTTAAGC ATTTTCTTTT TCCTNTTAAC 4 2 0
ANCCAGGACA GGNTTNAACN AAGGAAAT 4 4 8

```

(2) INFORMATION FOR SEQ ID NO:67:

- (i) SEQUENCE CHARACTERISTICS:
 (A) LENGTH: 450 base pairs
 (B) TYPE: nucleic acid
 (C) STRANDEDNESS: single
 (D) TOPOLOGY: linear

(i i) MOLECULE TYPE: DNA (genomic)

(x i) SEQUENCE DESCRIPTION: SEQ ID NO:67:

```

CTGCAGCTCC AAGCACCTTT TTCAAATTCA GCTTTCTGTG ATTTTCAGACC ACATATGCAA 6 0
GGAAGTATCT TACCTTAATT AATAAGACTT TAAAATCCTT GTGTCAGAGG CGTTTGGACC 1 2 0
AGAGCAACTC TATCTTGAAT AGGGGCTGGG TAAAATAAGG CCAAGACCTA CTGGGCTGCA 1 8 0
TTTGCAGGAG GTTAGGTACT CTTAGTTACG GGATGAGATA GGAAGTCAGC ACAAGATACA 2 4 0
GCTCATAAAG GATCTTGCTG ATAAAAGTGG TTGCAATAAA GAAGCTGGNC AAAACCCACC 3 0 0
AAAACCAAGA TGGTGAGGAG AGTGACCTCT GGTTATCCTC ACTGNTCACT ATACGNTAAT 3 6 0
TATTATACAT TAGCATGCTA AAAGACACTC CCCGCAACAA CCATGANAGG TTTACAAGTT 4 2 0
NCCATGGNAA CGNNCCCGGA NGNTANCTTG 4 5 0

```

(2) INFORMATION FOR SEQ ID NO:68:

- (i) SEQUENCE CHARACTERISTICS:
 (A) LENGTH: 388 base pairs
 (B) TYPE: nucleic acid
 (C) STRANDEDNESS: single
 (D) TOPOLOGY: linear

(i i) MOLECULE TYPE: DNA (genomic)

(x i) SEQUENCE DESCRIPTION: SEQ ID NO:68:

```

CTGNAGCCTC CACCACCCAG GTTCAGGTGA TTCTCCTGCC GTAGNCTCAT GAGTAGNTGG 6 0
GATTACAGGC ATGTGCCACC ATGCCCGACT AATTTTTATA TTTTATAGTAG AGACGGGGTT 1 2 0
TCACCATGTT GGGCAGGCTG GTCTCAAACCT CCTGACCTCA AGTGATCTGC CCACCTTGGC 1 8 0
CTCCCAAAGT GCTGGGATTT CAGGCGCCTG GCCTGTTACT TGATTATATG CTAACAAGG 2 4 0

```

-continued

| | | | | | | |
|------------|------------|------------|------------|------------|------------|-------|
| GGTGGATTAT | TCATGAGTTT | TCTGGGAAAG | AGGTGGGCAA | TTCCCGGAAC | TGAGGGATCC | 3 0 0 |
| CTCCCCTTNN | NAGACCATAC | AAGGTAACCT | CCGGACGTTG | GCATGGNATC | TTGTTAAACT | 3 6 0 |
| TGTCATGGNG | TTGGGGGGGA | GTGTCTTT | | | | 3 8 8 |

(2) INFORMATION FOR SEQ ID NO:69:

- (i) SEQUENCE CHARACTERISTICS:
 - (A) LENGTH: 500 base pairs
 - (B) TYPE: nucleic acid
 - (C) STRANDEDNESS: single
 - (D) TOPOLOGY: linear

(i i) MOLECULE TYPE: DNA (genomic)

(x i) SEQUENCE DESCRIPTION: SEQ ID NO:69:

| | | | | | | |
|------------|------------|------------|------------|------------|------------|-------|
| CTGCAGAAGT | ATGTTTCCTG | TATGGTATTA | CTGGATAGGG | CTGAAGTTAT | GCTGAATTGA | 6 0 |
| ACACATAAAT | TCTTTTCCAC | CTCAGGGNCA | TTGGGCGCCC | ATTGCTCTTC | TGCCTAGAAT | 1 2 0 |
| ATTCTTTCCT | TTTCTAACTT | TGGTGGATTA | AATTCCTGTC | ATCCCCCTCC | TCTTGGTGTT | 1 8 0 |
| ATATATAAAG | TNTTGGTGCC | GCAAAAGAAG | TAGCACTCGA | ATATAAAATT | TTCCTTTTAA | 2 4 0 |
| TTCTCAGCAA | GGNAAGTTAC | TTCTATATAG | AAGGGTGCAC | CCNTACAGAT | GGAACAATGG | 3 0 0 |
| CAAGCGCACA | TTTGGGACAA | GGGAGGGGAA | AGGGTTCTTA | TCCCTGACAC | ACGTGGTCCC | 3 6 0 |
| NGCTGNTGTG | TNCTNCCCCC | ACTGANTAGG | GTTAGACTGG | ACAGGCTTAA | ACTAATTCCA | 4 2 0 |
| ATTGGNTAAT | TTAAAGAGAA | TNATGGGGTG | AATGCTTTGG | GAGGAGTCAA | GGAAGAGNAG | 4 8 0 |
| GTAGNAGGTA | ACTTGAATGA | | | | | 5 0 0 |

(2) INFORMATION FOR SEQ ID NO:70:

- (i) SEQUENCE CHARACTERISTICS:
 - (A) LENGTH: 435 base pairs
 - (B) TYPE: nucleic acid
 - (C) STRANDEDNESS: single
 - (D) TOPOLOGY: linear

(i i) MOLECULE TYPE: DNA (genomic)

(x i) SEQUENCE DESCRIPTION: SEQ ID NO:70:

| | | | | | | |
|------------|------------|------------|------------|------------|------------|-------|
| CTGCAGAGTA | ATTGCAACTG | GAGTTGTCTT | AAGATAATGT | CACATATCCA | TCTTCCCCTT | 6 0 |
| GTTTCTCATT | CACAGAAAAA | CATTTTTATT | CCAGGTGCCA | ATATTCCCAG | CCAAAAAGAC | 1 2 0 |
| TTTACTTCTG | ACTCCCTTAT | ATTTAGGATG | GCTATGAGAA | CAAGTAAGGG | CAATGACTTC | 1 8 0 |
| TAGGGAGATG | TGTTGTGTAT | GGAAGTTCTA | AGGAGAGAAT | TCTGCTGACA | TGTCCTATGT | 2 4 0 |
| TCTTTTCTCC | CCTACTCCTT | CCTACTGTCA | GAAATGAAGG | CTAGGGCTCC | AGCCTGGACC | 3 0 0 |
| CTGAAGTAAG | CTAGAGGTTA | GAAGCTAAAG | AAGAAAGAAG | GAGATTGAGT | CCTTGGATGA | 3 6 0 |
| ACGTGAAGCC | ACCCTACTAA | TCTGGACTGN | CTACCTCTGN | ACTACTCTAT | GAGAGAGAAA | 4 2 0 |
| GTATGTGCAT | TATTT | | | | | 4 3 5 |

(2) INFORMATION FOR SEQ ID NO:71:

- (i) SEQUENCE CHARACTERISTICS:
 - (A) LENGTH: 439 base pairs
 - (B) TYPE: nucleic acid
 - (C) STRANDEDNESS: single
 - (D) TOPOLOGY: linear

(i i) MOLECULE TYPE: DNA (genomic)

(x i) SEQUENCE DESCRIPTION: SEQ ID NO:71:

-continued

| | | | | | | |
|------------|------------|------------|------------|------------|------------|-------|
| CATGCTCTTT | GTCCCTGTGA | CTCTCTGCAT | GGTGGTGGTC | GTGGNTACCA | TTAAGTCAGT | 6 0 |
| CAGCTTTTAT | ACCCGGAAGG | ATGGGCAGCT | GTACGTATGA | GTTTGGTTTT | ATTATTCTCA | 1 2 0 |
| AAGCCAGTGT | GGCTTTTCTT | TACAGCATGT | CATCATCACC | TTGAAGGCCT | CTGCATTGAA | 1 8 0 |
| GGGGCATGAC | TTAGCTGGAG | AGCCCATCCT | CTGTGATGGT | CAGGAGCAGT | TGAGAGAGCG | 2 4 0 |
| AGGGGTTATT | ACTTCATGTT | TTAAGTGGAG | AAAAGGAACA | CTGCAGAAGT | ATGTTTCCTG | 3 0 0 |
| TATGGTATTA | CTGGATAGGG | CTGAAGTTAT | GCTGAATTGA | ACACATAAAT | TCTTTTCCAC | 3 6 0 |
| CTCAGGGGCA | TTGGGCGCCC | ATTGNTCTTC | TGCCTAGAAT | ATTCTTTCCT | TTNCTNACTT | 4 2 0 |
| GGGNGGATTA | AATTCCTGT | | | | | 4 3 9 |

(2) INFORMATION FOR SEQ ID NO:72:

- (i) SEQUENCE CHARACTERISTICS:
 - (A) LENGTH: 318 base pairs
 - (B) TYPE: nucleic acid
 - (C) STRANDEDNESS: single
 - (D) TOPOLOGY: linear

(i i) MOLECULE TYPE: DNA (genomic)

(x i) SEQUENCE DESCRIPTION: SEQ ID NO:72:

| | | | | | | |
|------------|------------|------------|------------|------------|------------|-------|
| TCCATCTCTA | CGACTCTCAT | GGGGTCCAAA | GAAGAGTTTT | AATTGAGTTT | TAGAATGTGN | 6 0 |
| AGTTGTGAAG | TGTCTGAAAA | ACTACATGGT | GNTCTGAAAG | NCAAACTTTT | AGCCTTGGGG | 1 2 0 |
| GAGAGCATCT | AAGACAGNAG | GTGAAGGGGA | GGGGTTAGAN | CTAGAGGGAT | TGAAGAATAT | 1 8 0 |
| TATCCATATA | GGTTAGGGTT | AGGTGTGGCA | ACGTTTTATA | GAACAAACAT | TGGNAAGCTA | 2 4 0 |
| CAGACACAGG | CCAGNTCTGT | CTNCTACCTN | TCCACAAAGG | TGTNATAACA | AAGTTANNCA | 3 0 0 |
| CAAATGTGTG | AATAAACT | | | | | 3 1 8 |

(2) INFORMATION FOR SEQ ID NO:73:

- (i) SEQUENCE CHARACTERISTICS:
 - (A) LENGTH: 450 base pairs
 - (B) TYPE: nucleic acid
 - (C) STRANDEDNESS: single
 - (D) TOPOLOGY: linear

(i i) MOLECULE TYPE: DNA (genomic)

(x i) SEQUENCE DESCRIPTION: SEQ ID NO:73:

| | | | | | | |
|------------|------------|------------|------------|------------|------------|-------|
| GTTGCAAAGT | CATGGATTCC | TTTAGGTAGC | TACATTATCA | ACCTTTTTGA | GAATAAAATG | 6 0 |
| AATTGAGAGT | GTTACAGTCT | AATTCTATAT | CACATGTAAC | TTTTATTTGG | ATATATCAGT | 1 2 0 |
| AATAGTGCTT | TTTCNTTTTT | TTTTTTTNTT | TTTTTTNNTT | TTNGGGGANA | GAGTCTCGCT | 1 8 0 |
| CTGTCGCCAG | GTTGGAGTGC | AATGGTGCGA | TCTTGGCTCA | CTGAAAGCTC | CACCNCCCGG | 2 4 0 |
| GTTCAAGTGA | TTCTCCTGCC | TCAGCCNCCC | AAGTAGNTGG | GACTACAGGG | GTGCGCCACC | 3 0 0 |
| ACGCCTGGGA | TAATTTTGGG | NTTTTTAGTA | GAGATGGCGT | TTCACCANCT | TGGNGCAGGC | 3 6 0 |
| TGGTCTTGGA | ACTCCTGANA | TCATGATCTG | CCTGCCTTAG | CCTCCCCAAA | GTGCTGGGAT | 4 2 0 |
| TNCAGGGGTG | AGCCACTGTT | CCTGGGCCTC | | | | 4 5 0 |

(2) INFORMATION FOR SEQ ID NO:74:

- (i) SEQUENCE CHARACTERISTICS:
 - (A) LENGTH: 489 base pairs
 - (B) TYPE: nucleic acid
 - (C) STRANDEDNESS: single
 - (D) TOPOLOGY: linear

(i i) MOLECULE TYPE: DNA (genomic)

-continued

(x i) SEQUENCE DESCRIPTION: SEQ ID NO:74:

| | | | | | | |
|-------------|------------|-------------|-------------|------------|------------|-----|
| CTGCAGNTGA | GCCGTGATTG | CANCCACTTT | ACTCCNAGCC | TGGGCAANCA | AAATGAGACA | 60 |
| CTGGCTNCAA | ACACAAAAAC | AAAAACA AAA | AAAGAGTAAA | TTAATTTAAA | GGGAAGTATT | 120 |
| AAATAAATAA | TAGCACAGTT | GATATAGGTT | ATGGTAAAAAT | TATAAAGGTG | GGATATTAAT | 180 |
| ATCTAATGTT | TGGGAGCCAT | CACATTATTC | TAAATAATGT | TTTGGTGGAA | ATTATTGTAC | 240 |
| ATCTTTTAAA | ATCTGTGTAA | TTTTTTTTCA | GGGAAGTGTT | TAAAACCTAT | AACGTTGCTG | 300 |
| TGGACTACAT | TACTGTTGCA | CTCCTGATCT | GGAATTTTGG | TGTGGTGGGA | ATGATTTCCA | 360 |
| TTC ACTGGAA | AGGTCCACTT | CGACTCCAGC | AGGCATATCT | CATTATGATT | AGTGCCCTCA | 420 |
| TGGCCCTGGT | GTTTATCAAG | TACCNCCCTG | AATGGACTGG | GTGGCTCATC | TTGGCTGTGA | 480 |
| TTTCAGTAT | | | | | | 489 |

(2) INFORMATION FOR SEQ ID NO:75:

- (i) SEQUENCE CHARACTERISTICS:
 (A) LENGTH: 449 base pairs
 (B) TYPE: nucleic acid
 (C) STRANDEDNESS: single
 (D) TOPOLOGY: linear

(i i) MOLECULE TYPE: DNA (genomic)

(x i) SEQUENCE DESCRIPTION: SEQ ID NO:75:

| | | | | | | |
|------------|------------|-------------|------------|------------|------------|-----|
| CTGCAGNCTT | GACCTCCTGG | GATCAATCGA | TCCTCCCACC | TCAGCCTCCT | AAGTAGCTGG | 60 |
| AACTACAGGT | GTGCACCACC | ATGCCCGGCT | AATTTTTGTA | TTTTCTGTAG | ATACGAGGTT | 120 |
| TTGCCATGTT | GCCCAGGCTG | GTCTTGA ACT | CTGGGCTTAG | GTGATCTGCC | CGCCTCAGCC | 180 |
| TCCCAAAGTG | CTAAGATTAC | AGGCATGAGC | TACCATGCCC | AGCCGAAATC | TTCAAATGAA | 240 |
| AAAGTTACTA | TAGCTAATTA | ATGATTTACT | GAAGAGTTAT | GGGATGTACA | CGTTACCATT | 300 |
| TTCTCTAAAT | CAAGATAAAG | AGATGAGGAA | AGAAAACACT | CCAGTGGGGC | ATTCCTGTGA | 360 |
| CAAACAAATT | ATCAGTCTTG | GGTTTTACNA | TATACTGAAA | TCACAGCCAA | GATGAGCCAC | 420 |
| GCAGTCCATT | CAGGGAGGTA | CTTGATAAAA | | | | 449 |

(2) INFORMATION FOR SEQ ID NO:76:

- (i) SEQUENCE CHARACTERISTICS:
 (A) LENGTH: 490 base pairs
 (B) TYPE: nucleic acid
 (C) STRANDEDNESS: single
 (D) TOPOLOGY: linear

(i i) MOLECULE TYPE: DNA (genomic)

(x i) SEQUENCE DESCRIPTION: SEQ ID NO:76:

| | | | | | | |
|------------|------------|------------|------------|------------|------------|-----|
| TTCTTGCCGT | TCCCGACCCG | AGCCTGGTGC | CCCTTCCCCA | TTATGATCCT | TNTCGCTTCC | 60 |
| GGCGGCATCG | GGATGCCCCG | CGTTGCAGGC | CATNCTGTCC | CAGNCAGGTA | GATGACGACC | 120 |
| ATCAGGGACA | GCTTCAAGGA | TCGCTCGCGG | CTCTTACCAG | CCTAACTTCG | ATCATTGGAC | 180 |
| CGCTGATCGT | CACGGCGATT | TATCCCGCCT | CGGCGAGCAC | ATGGAACGGG | TTGGCATGGA | 240 |
| TTGTAGGCGC | CGCCCTATAC | CTTGTCTGCC | TCCCCGCGT | TGCGTCGCGG | TGCATGGAGC | 300 |
| CGGNCCACCT | CGACCTGAAT | GGAANCCGGC | GGCACCTCGC | TAACGGATTC | ACCACTCCAA | 360 |
| GAATTGGAGC | CAATCAATTC | TTGCGGAGAA | CTGTGAATGC | NCAAACCAAC | CCTTGGCAGA | 420 |
| ACATATCCAT | CGCGTCCGCC | ATCTCCANCA | GCCGCACGCG | GCGCATCTCG | GGCAGCGTTG | 480 |
| GGTCCTGCAG | | | | | | 490 |

-continued

(2) INFORMATION FOR SEQ ID NO:77:

- (i) SEQUENCE CHARACTERISTICS:
 (A) LENGTH: 470 base pairs
 (B) TYPE: nucleic acid
 (C) STRANDEDNESS: single
 (D) TOPOLOGY: linear

(i i) MOLECULE TYPE: DNA (genomic)

(x i) SEQUENCE DESCRIPTION: SEQ ID NO:77:

```

CTGCAGTGTT TAAAAAATAA AATAAACTAA AAGTTTATTT ATGAGGAGTA CACTGCTTTC      6 0
TTGTAAACAC ATGTACAAGC CATATAATAG AGTTCATTTT NNACCCTAGT TACGGAAACA      1 2 0
CTAGAAAGTC TNCACCCGGC CAAGATAACA CATCTTTAGG TAAAAATAGC AAGAAATATT      1 8 0
TTATGGGTTG TTTACTTAAA TCATAGTTTT CAGGTTGGGC ACAGTGGNTC ATGCCTGTAA      2 4 0
TCCCAGCACT TTATGCGGCT GAGGCAGGCA GATCAGTTGA GGTCAGAAGT TTGAGACCAG      3 0 0
CCTGGGCAAT GTGGCAAAAC CTCATCTCCA CTA AAAAATAC AAAAATTAGC CAGGCATGGT      3 6 0
GGTGCACACA TGTTAATTCC CAGCTACTTG GGAGGNTTGA GACAGGAGGG TCGCTTGGNC      4 2 0
CTAGGAGGGA AGAAGTTGNA GGGANCTTAA TGTCACTGCA CTCTAGNTTG      4 7 0

```

(2) INFORMATION FOR SEQ ID NO:78:

- (i) SEQUENCE CHARACTERISTICS:
 (A) LENGTH: 445 base pairs
 (B) TYPE: nucleic acid
 (C) STRANDEDNESS: single
 (D) TOPOLOGY: linear

(i i) MOLECULE TYPE: DNA (genomic)

(x i) SEQUENCE DESCRIPTION: SEQ ID NO:78:

```

CACTCAATTC TGAATGCTGC CATCATGATC AGTGTCATTG TTGTCATGAC TANNCTCCTG      6 0
GTGGTTCTGT ATAAATACAG GTGCTATAAG GTGAGCATGA GACACAGATC TTTGNTTTC      1 2 0
ACCCTGTTCT TCTTATGGTT GGGTATTCTT GTCACAGTAA CTTAACTGAT CTAGGAAAGA      1 8 0
AAAAATGTTT TGTCTTCTAG AGATAAGTTA ATTTTTAGTT TTCTTCCTCC TCACTGTGGA      2 4 0
ACATTCAAAA AATACAAAAA GGAAGCCAGG TGCATGTGTA ATGCCAGGCT CAGAGGCTGA      3 0 0
GGCAGGAGGA TCGCTTGGGC CCAGGAGTTC ACAAGCAGCT TGGGCAACGT AGCAAGACCC      3 6 0
TGCCTCTATT AAAGAAAACA AAAAACAAAT ATTGGAAGTA TTTTATATGC ATGGAATCTA      4 2 0
TATGTCATGA AAAAATTAGT GTAAA                                4 4 5

```

(2) INFORMATION FOR SEQ ID NO:79:

- (i) SEQUENCE CHARACTERISTICS:
 (A) LENGTH: 496 base pairs
 (B) TYPE: nucleic acid
 (C) STRANDEDNESS: single
 (D) TOPOLOGY: linear

(i i) MOLECULE TYPE: DNA (genomic)

(x i) SEQUENCE DESCRIPTION: SEQ ID NO:79:

```

CCTGTATTTA TACTGAACCA CCAGGAGGAT AGTCATGACT ACAATGACNC TGATCATGAT      6 0
GGCAGCATT C AGAATTGAGT GCAGGGCTCT CTGGCCACAC GTCTCGGTAT CTTCTGTGAA      1 2 0
TGGGGTATAG ATTCTACAAT AAAACAAACA CAAAAGCCCT AGGTCAGTGT TAATGGAGAT      1 8 0
CACCAACCAC ATTACCACCT CCAACACAGA ATTTTCTTTT TCTTAATTCA ATTCGNATCT      2 4 0

```

-continued

| | | | | | | |
|------------|------------|------------|------------|------------|------------|-------|
| TATAAGTCAC | TTTTCCCCAA | CTCACCAATN | CTAGCTAAGA | ATTTTAAACC | TGAGAAAAAC | 3 0 0 |
| AGCTACACTC | TAAAATTGCT | TCAAAGAAAA | TGTCTAACAT | ATGGAAAGAA | GGACTTAACA | 3 6 0 |
| TGTGAAGCAG | ACACTGGCTC | CATCTAGTGG | GTGCTTTATA | TTGAAATAAT | TATAATACCT | 4 2 0 |
| CATCAAATTT | TTTNGGGTAC | AGNTTATTAG | GAACTTGGTA | TGGAACCAGA | TTCTGCCACA | 4 8 0 |
| GAAACCACGN | GGGCTG | | | | | 4 9 6 |

(2) INFORMATION FOR SEQ ID NO:80:

- (i) SEQUENCE CHARACTERISTICS:
 - (A) LENGTH: 496 base pairs
 - (B) TYPE: nucleic acid
 - (C) STRANDEDNESS: single
 - (D) TOPOLOGY: linear

(i i) MOLECULE TYPE: DNA (genomic)

(x i) SEQUENCE DESCRIPTION: SEQ ID NO:80:

| | | | | | | |
|------------|-------------|------------|------------|------------|------------|-------|
| CATTAGATAA | TGGNTCAGGG | TGGCCAAGGC | TCCGTCTGTC | GTTGTGCTCC | TGCCGTTCTC | 6 0 |
| TATTGTCATT | CTATAAGCAC | AAGAAAAACA | TTTTCAGTAA | ATCAGATTCT | CAGCAGAATC | 1 2 0 |
| AAGGTAACGG | TTAGACCTGG | GATTAACAAC | AGACCCGTCA | CTATGAGTTC | TAAAAACCTG | 1 8 0 |
| AAGCAAGAAA | AAACAATGTA | CAGGAAGTAT | GCAGTTTAAA | AGTCTAGATT | ATCTATCATT | 2 4 0 |
| GTTCACTGAA | GGCATTTCAGG | TCCTCTCTTT | TACCTGGGTC | TTGGNTTGCT | CCATTCTCTC | 3 0 0 |
| TGTTCATCCC | AACATACACA | ATTGTACTTA | TCCTTTGAGA | TGTACCTTAA | ATACTGACAC | 3 6 0 |
| CTGCATGAAA | ACTTGTTTAC | TGGCTGCAGG | TCCAAGCACC | TTTTTCNAAA | TTCAGCTTTC | 4 2 0 |
| TGTGATTTCA | GACCACATAT | GCAAGGAACT | ATCTTACCTT | AATTAATAAG | ANTTTAAAAT | 4 8 0 |
| CCTTGTGTCA | GAGGCG | | | | | 4 9 6 |

(2) INFORMATION FOR SEQ ID NO:81:

- (i) SEQUENCE CHARACTERISTICS:
 - (A) LENGTH: 368 base pairs
 - (B) TYPE: nucleic acid
 - (C) STRANDEDNESS: single
 - (D) TOPOLOGY: linear

(i i) MOLECULE TYPE: DNA (genomic)

(x i) SEQUENCE DESCRIPTION: SEQ ID NO:81:

| | | | | | | |
|------------|------------|-------------|------------|------------|------------|-------|
| AGGANCGCTT | GGGCCAGGA | GTTCAACAAGC | AGCTTGGGCA | ACGTAGCAAG | ACCCTGCCTC | 6 0 |
| TATTAAGAA | AACAAAAAAC | AAATATTGGA | AGTATTTTAT | ATGCATGGAA | TCTATATGTC | 1 2 0 |
| ATGAAAAAAT | TAGTGTAATA | TATATATATT | ATGATTAGNT | ATCAAGATTT | AGTGATAATT | 1 8 0 |
| TATGTTATNN | NGGGATTTCA | ATGCCTTTTT | AGGCCATTGT | CTCAAAAAAT | AAAAGCAGAA | 2 4 0 |
| AACAAAAAAA | GTTGTAAGTG | AAAAATAAAC | ATTTCCATAT | AATAGCACAA | TCTAAGTGGG | 3 0 0 |
| TTTTTGNTTG | TTTGTTTGNT | TGTTGAAGCA | GGGCCTTGCC | CTNCCACCCA | GGNTGGAGTG | 3 6 0 |
| AAGTGCAG | | | | | | 3 6 8 |

(2) INFORMATION FOR SEQ ID NO:82:

- (i) SEQUENCE CHARACTERISTICS:
 - (A) LENGTH: 500 base pairs
 - (B) TYPE: nucleic acid
 - (C) STRANDEDNESS: single
 - (D) TOPOLOGY: linear

(i i) MOLECULE TYPE: DNA (genomic)

(x i) SEQUENCE DESCRIPTION: SEQ ID NO:82:

-continued

| | | | | | | |
|------------|-------------|-------------|-------------|-------------|------------|-------|
| GAATTCCTTT | TTTTTTTTTTT | TTTTTTTTTTT | TTNCTCCTAA | TGTTTTTTATT | GTNCCTTAGA | 6 0 |
| TAACTGGATA | GNACAAAGTT | NGNCTTNGTT | TTTTACTTAA | AAAACGTACT | TTCCGCATAC | 1 2 0 |
| TGTNGCCCGT | ATGACTTTTCC | TGTCCCATCG | GAAACCAGAG | TTTCCCCAGG | TGAGCCCTTC | 1 8 0 |
| CTATCTGNNG | NTACATGATT | TAGCTAATTT | AACAAGAAGA | GAGTAATTCC | TTNGGATTAT | 2 4 0 |
| TATCAACATG | AAACTTGGAC | TATGTCTCTA | TAAGGGTGAA | CACTGATTTT | TTTTTTCTTT | 3 0 0 |
| TTAGAAACAA | AAACCATCCA | CTTATTAATC | CAAACCTACGG | GATTGGATTT | ACAACAATCA | 3 6 0 |
| TCGCATNAAC | TGAACATACG | AAGTTACCAC | TCAAGGGAAT | NACAGAAGAA | CGTTGNACAA | 4 2 0 |
| TNTNTCTTAC | GGGGTACGNG | AATTCAAACA | ATGTGGGGAN | AGGAACTTCA | NTCTACAAAN | 4 8 0 |
| TCTGACCATC | GNTTCAGTAT | | | | | 5 0 0 |

(2) INFORMATION FOR SEQ ID NO:83:

- (i) SEQUENCE CHARACTERISTICS:
 - (A) LENGTH: 450 base pairs
 - (B) TYPE: nucleic acid
 - (C) STRANDEDNESS: single
 - (D) TOPOLOGY: linear

(i i) MOLECULE TYPE: DNA (genomic)

(x i) SEQUENCE DESCRIPTION: SEQ ID NO:83:

| | | | | | | |
|------------|-------------|------------|------------|------------|------------|-------|
| GAATTCCTTT | ACTCTTCTTT | AATTCTACCG | TCTTTGGGCA | TACATCTCAT | TTGNTGTGGA | 6 0 |
| AGAAGGTCTG | ACAGNAGGGC | TGACAGCACC | GATTCATAAC | ACATTCTTTT | CATCATACAA | 1 2 0 |
| AGAGTAAGAC | CCTAGAATAA | TGGGACCATC | TGCTACCACG | ACAGAGCTGC | CTTACTGGCT | 1 8 0 |
| GTAGAAAAAG | ACTGCTTG TG | TGGGAGAGAA | GAATGAGGAC | AGAGGAGGCA | TCTGGGGCAA | 2 4 0 |
| GTGAGCGTAC | AAGTATNTCT | ACAAATTCAG | AATTTGGTGG | AAAATCCAAA | TTTGNCTTCA | 3 0 0 |
| ACATGATAGA | GAATTGATGA | GAAAATAGCT | GTNCTGTTTC | CAAATTTTAC | TGAATTTGGG | 3 6 0 |
| AACCTGAGGT | TAAAAC TTTT | AGGATNAAGC | AACTCAGGTT | CAAGACTTNG | NCTNGGGAAG | 4 2 0 |
| GAATGGAAAC | ACAGACGGGA | ATGAGTNTCA | | | | 4 5 0 |

(2) INFORMATION FOR SEQ ID NO:84:

- (i) SEQUENCE CHARACTERISTICS:
 - (A) LENGTH: 450 base pairs
 - (B) TYPE: nucleic acid
 - (C) STRANDEDNESS: single
 - (D) TOPOLOGY: linear

(i i) MOLECULE TYPE: DNA (genomic)

(x i) SEQUENCE DESCRIPTION: SEQ ID NO:84:

| | | | | | | |
|------------|-------------|-------------|------------|------------|-------------|-------|
| CAACTGTATT | TATACAGNAA | CCACCAGGAG | GATAGTCATG | ACAACAATGA | CAAACCTAGGA | 6 0 |
| ATAGCCCCCT | TTCACTTCTG | AGTCCCAGAG | GTTACCCAAG | GCACCCCTCT | GACATCCGGC | 1 2 0 |
| CTGCTTCTTC | TCACATGANA | AAAACCTAGCC | CCCAGTNTGA | TCCGCAGGTN | GAGGAATNCC | 1 8 0 |
| CCGGGTCGAG | GTTTCGGATCC | TGGATGACAG | ACCCTCTCGC | CCCTGAAGGN | GATAACCGGG | 2 4 0 |
| TGTGGTACAT | GGACGGNTAT | CACAACAACC | GCTTCGNACG | TGAGTACAAG | TCCATGGTTG | 3 0 0 |
| ACTTCATGAA | CACGGACAAT | TTCACCTCCC | ACCGTCTCCC | CCACCCCTGG | TCGGGCACGG | 3 6 0 |
| GGNAGGTGGT | CTNCAACGGT | TCTTTCTNCT | TCAACAAGTT | CCAGAGCCAC | ATCATCATCA | 4 2 0 |
| GTTTTGGACC | TGAAGANAGA | GAACATCCTC | | | | 4 5 0 |

(2) INFORMATION FOR SEQ ID NO:85:

-continued

(i) SEQUENCE CHARACTERISTICS:
 (A) LENGTH: 500 base pairs
 (B) TYPE: nucleic acid
 (C) STRANDEDNESS: single
 (D) TOPOLOGY: linear

(i i) MOLECULE TYPE: DNA (genomic)

(x i) SEQUENCE DESCRIPTION: SEQ ID NO:85:

```

GGATCCCTCC CCTTTTTAGA CCATACAAGG TAACTTCCGG ACGTTGCCAT GGCATCTGTA      6 0
AACTGTCATG GTGTTGGCGG GGAGTGTCTT TTAGCATGCT AATGTATTAT AATTAGCGTA      1 2 0
TAGTGAGCAG TGAGGATAAC CAGAGGTCAC TCTCCTCACC ATCTTGGTTT TGGTGGGTTT      1 8 0
TGGCCAGCTT CTTTATTGCA ACCAGTTTTA TCAGCAAGAT CTTTATGAGC TGTATCTTGT      2 4 0
GCTGACTTCC TATCTCATCC CGTAACTAAG AGTACCTAAC CTCCTGCAAA TNGCAGCCCA      3 0 0
GTAGGTCTTG GNCTTATTTT ACCCAGCCCC TATTCAAGAT AGAGTTGCTC NTGGTCCAAA      3 6 0
CGCCTCTGAC ACAAGGATTT TAAAGTCTTA TTAATTAAGG TAAGATAGGT CCTTGGATAT      4 2 0
GTGGTCTGAA ATCACAGAAA GCTGAATTTG GAAAAAGGTG CTTGGAGCTG CAGCCAGTAA      4 8 0
ACAAGTTTTC ATGCAGGTGT                                     5 0 0

```

(2) INFORMATION FOR SEQ ID NO:86:

(i) SEQUENCE CHARACTERISTICS:
 (A) LENGTH: 500 base pairs
 (B) TYPE: nucleic acid
 (C) STRANDEDNESS: single
 (D) TOPOLOGY: linear

(i i) MOLECULE TYPE: DNA (genomic)

(x i) SEQUENCE DESCRIPTION: SEQ ID NO:86:

```

CTGCAGTGAG CCAAATCGT GCCACTGCAC TTCACTCCAG CCTGGGTGAC AGGGCAAGGC      6 0
CCTGCTTCAA CAAACAAACA AACAAACAAA AACCCACTTA GATTGTGCTA TTATATGGAA      1 2 0
ATGTTTATTT TTCAGTTACA ACTTTTTTTG TTTTCTGCTT TTATTTGTTG AGACAATGGC      1 8 0
CTAAAAGGC ATTGAAATNC CAAAATAACA TAAATTATCA CTAAATCTTG ATAACTAATC      2 4 0
ATAATATATA TATTTTACAC TAATTTTTTC ATGACATATA GATTCCATGC ATATAAAATA      3 0 0
CTTCCAATAT TTGTTTTTTG TTTTCTTTAA TAGAGGCAGG GTCTTGCTAC GTTGCCCAAG      3 6 0
CTGCTTGTGA ACTCCTGGGC CCAAGCGATC CTCCTGCCTC AGCCTCTGAG CCTGGCATT A      4 2 0
CACATGCACC TGGCTTCCTT TTTGTNTTTT TTGAATGTTC CACAGTGAGG AGGAAGAAAA      4 8 0
CTNAAAATTA ACTTATCTCT                                     5 0 0

```

(2) INFORMATION FOR SEQ ID NO:87:

(i) SEQUENCE CHARACTERISTICS:
 (A) LENGTH: 450 base pairs
 (B) TYPE: nucleic acid
 (C) STRANDEDNESS: single
 (D) TOPOLOGY: linear

(i i) MOLECULE TYPE: DNA (genomic)

(x i) SEQUENCE DESCRIPTION: SEQ ID NO:87:

```

CTGCAGATGA GAGGCACTAA TTATAAGCCA TATTACCTTT CTTCTGACAA CCACTTGTC A      6 0
GCCACGTTGG TTTCTGTGGC AGAATCTGGT TCTATAACAA GTTCCTAATA AGCTGTAGCC      1 2 0
AAAAAATTT GATGAGGTAT TATAATTATT TCAATATAAA GCACCCACTA GATGGAGCCA      1 8 0
GTGTCTGCTT CACATGTTAA GTCCTTCTTT CCATATGTTA GACATTTTCT TTGAAGCAAT      2 4 0

```

-continued

| | | | | | | |
|------------|------------|------------|------------|------------|------------|-------|
| TTTAGAGTGT | AGCTGTTTTT | CTCAGGTAA | AAATTCTTAG | CTAGGATTGG | TGAGTTGGGG | 3 0 0 |
| AAAAGTGACT | TATAAGATAC | GAATTGAATT | AAGAAAAAGA | AAATTCTGTG | TTGGAGGTGG | 3 6 0 |
| TAATGTGGGT | GGTGATCTTC | ATTAACACTG | ANCTAGGGNT | TTGGGGTTTG | GTTTATTGTA | 4 2 0 |
| GAATCTATAC | CCCATTCANA | GAAGATACCG | | | | 4 5 0 |

(2) INFORMATION FOR SEQ ID NO:88:

- (i) SEQUENCE CHARACTERISTICS:
 - (A) LENGTH: 502 base pairs
 - (B) TYPE: nucleic acid
 - (C) STRANDEDNESS: single
 - (D) TOPOLOGY: linear

(i i) MOLECULE TYPE: DNA (genomic)

(x i) SEQUENCE DESCRIPTION: SEQ ID NO:88:

| | | | | | | |
|------------|------------|------------|------------|-------------|------------|-------|
| CTGCAGCCAG | TAAACAAGTT | TTCATGCAGG | TGTCAGTATT | TAAGGTACAT | CTCAAAGGAT | 6 0 |
| AAGTACAATT | GTGTATGTTG | GGATGAACAG | AGAGAATGGA | GCAAGCCAAG | ACCCAGGTAA | 1 2 0 |
| AAGAGAGGAC | CTGAATGCCT | TCAGTGAACA | ATGATAGATA | ATCTAGACTT | TTAAACTGCA | 1 8 0 |
| TACTTCCTGT | ACATTGTTTT | TTCTTGCTTC | AGGTTTTTAG | AACTCATAGT | GACGGGTCTG | 2 4 0 |
| TTGTTAATCC | CAGGTCTAAC | CGTTACCTTG | ATTCTGCTGA | GAATCTGATT | TACTGAAAAT | 3 0 0 |
| GTTTTTCTTG | TGCTTATAGA | ATGACAATAG | AGAACGGCAG | GAGCACAAACG | ACAGACGGAG | 3 6 0 |
| CCTTGGCCAC | CCTGAGCCAT | TATCTAATGG | ACGACCCAGG | GTA ACTCCCG | GCAGGTGGTG | 4 2 0 |
| GAGCAAGATG | AGGAAGAAGA | TGAGGAGCTG | ACATTGAAAT | ATGGCGGCNA | GCATGTGATC | 4 8 0 |
| ATGCTCNTTG | GCCCTGTGAN | TC | | | | 5 0 2 |

(2) INFORMATION FOR SEQ ID NO:89:

- (i) SEQUENCE CHARACTERISTICS:
 - (A) LENGTH: 499 base pairs
 - (B) TYPE: nucleic acid
 - (C) STRANDEDNESS: single
 - (D) TOPOLOGY: linear

(i i) MOLECULE TYPE: DNA (genomic)

(x i) SEQUENCE DESCRIPTION: SEQ ID NO:89:

| | | | | | | |
|------------|------------|------------|------------|------------|------------|-------|
| CTGCAGTGTT | CCTTTTCTCC | ACTTAAAACA | TGAAGTAATA | ACCCCTCGNT | CTCTCAACTG | 6 0 |
| CTCCTGACCA | TCACAGAGGA | TGGGCTCTCC | AGCTAAGTCA | TGCCCTTCA | ATGNAGAGGC | 1 2 0 |
| CTTCAAGGTG | ATGATGACAT | GCTGTAAAGA | AAAGCCACAC | TGGGTTTGAG | AATAATAAAA | 1 8 0 |
| CAAACTCAT | ACGTACAGCT | GCCCATCCTT | CCGGGTATAA | AAGCTGACTG | ACTTAATGGT | 2 4 0 |
| AGCCACGACC | ACCACCATGC | AGAGAGTCAC | AGGGACAAAG | AGCATGATCA | CATGCTTGGC | 3 0 0 |
| GNCATATTTT | AATGTCAGNT | CCTCATCTTC | TTCCTCATCT | TGNTCCACCA | CCTGCCGGGA | 3 6 0 |
| GTTACCNTGG | GTCGTCCATT | AGATAATGGG | TCAGGGTGGC | CAAGGCTCCG | TCTGTCGTTG | 4 2 0 |
| TGCTCCTGCC | GTTCTCTATT | GTCATTCTAT | AAGCACAAGA | AAAACATTTN | CAGTAAATCA | 4 8 0 |
| GATNCTCAGC | AGAATCAAG | | | | | 4 9 9 |

(2) INFORMATION FOR SEQ ID NO:90:

- (i) SEQUENCE CHARACTERISTICS:
 - (A) LENGTH: 500 base pairs
 - (B) TYPE: nucleic acid
 - (C) STRANDEDNESS: single
 - (D) TOPOLOGY: linear

(i i) MOLECULE TYPE: DNA (genomic)

-continued

(x i) SEQUENCE DESCRIPTION: SEQ ID NO:90:

| | | | | | | |
|------------|------------|------------|------------|------------|-------------|-------|
| TAACTCCCAG | GNTCAAGATN | TCTNCCTGCG | TTAGCCTCCT | GAGTAGCTGG | GACTATAGGT | 6 0 |
| ATGTGCCACT | ATTCTGAAA | ACATAATCAG | TTTTGAAGGT | AGTGTCTGGG | CTGGGCGCAG | 1 2 0 |
| TGGNTCACGC | CTTCAATCCC | AGCACTTTGG | GAGGNCGAGG | TGGGCGGATC | ACCTGAGGTC | 1 8 0 |
| AGGAGTTCGA | GACCAGCCTG | ACCAACATGG | GATAAGACTC | CATCTCTACT | AAAAATACAA | 2 4 0 |
| AAAATTAGCC | AGGCATGGTG | GNGCATGCCT | GTAATCCCAG | CTACTCAGGA | GGNTGAGGNA | 3 0 0 |
| GGAGAATTGG | TTGGAACCTA | GGAAGCAGAG | GCTGTGGTGG | AGCCGAGATC | GCACCATTTGG | 3 6 0 |
| ACTCCAGGCT | GGGNAACAAG | AGTGAAAATC | CNTCTTAAAA | AAAAAAAAAA | AAAGGTAGNG | 4 2 0 |
| TTTTGNCCGG | NGCGGGGGGT | CACGCCTGTA | ATCCCAGNAT | TGGGGANGGC | AAGGNGGGGG | 4 8 0 |
| GTCANNANGN | NAGNAGTCCG | | | | | 5 0 0 |

(2) INFORMATION FOR SEQ ID NO:91:

(i) SEQUENCE CHARACTERISTICS:

- (A) LENGTH: 502 base pairs
- (B) TYPE: nucleic acid
- (C) STRANDEDNESS: single
- (D) TOPOLOGY: linear

(i i) MOLECULE TYPE: DNA (genomic)

(x i) SEQUENCE DESCRIPTION: SEQ ID NO:91:

| | | | | | | |
|------------|------------|------------|------------|------------|------------|-------|
| GAATTCTGCT | GACATGTCCT | ATGTTCTTTT | CTCCCCTACT | CCTTCCTACT | GTCAGNAATG | 6 0 |
| AAGGGTAGGG | CTCCAGCCTG | GACCCTGAAG | TAAGCTAGAG | GTTAGAAGCT | AAAGAAGAAA | 1 2 0 |
| GAAGGAGATT | GAGTCCTTNG | ATGAACGTGA | AGCCACCGTA | CTAATCTGGA | CTGCCTACCT | 1 8 0 |
| CTGCACTACT | CTATGAGAGA | GAAAGTATGT | GCATTATTTA | AACCAGTTGG | GTTGATTTTC | 2 4 0 |
| TATTAACAAA | GTCAGAAACA | TCTCTGTAAA | AAGCCAGACT | GAATATTTTA | AGCTCTATGG | 3 0 0 |
| GTCATATGGT | CTCCAGGGCA | AACACTCAAC | TGTGCTACTG | TAGTGTGAAA | GCAGGCACAG | 3 6 0 |
| ACAATGTATT | AACCAAGGAG | GGTGGTCACT | TTCCAATGAA | AGTTTATCAC | AAATTGGNGA | 4 2 0 |
| ATACTTGGTA | TTACACCNNG | GGGGAAGGTA | GGAGAAGATC | TTGCCTGTGG | TTGTNGNTGG | 4 8 0 |
| CAATGTTGGT | CTTTTATACG | NG | | | | 5 0 2 |

(2) INFORMATION FOR SEQ ID NO:92:

(i) SEQUENCE CHARACTERISTICS:

- (A) LENGTH: 495 base pairs
- (B) TYPE: nucleic acid
- (C) STRANDEDNESS: single
- (D) TOPOLOGY: linear

(i i) MOLECULE TYPE: DNA (genomic)

(x i) SEQUENCE DESCRIPTION: SEQ ID NO:92:

| | | | | | | |
|------------|------------|------------|------------|------------|------------|-------|
| GAATTCTCTC | CTTAGAAGTT | CCATACACAA | CACATCTCCC | TAGAAGTCAT | TGCCCTTACT | 6 0 |
| TGTTCTCATA | GCCATCCTAA | ATATAAGGGA | GTCAGAAGTA | AAGTCTGGNT | GGCTGGGAAT | 1 2 0 |
| ATTGGCACCT | GGAATAAAAA | TGTTTTTCTG | TGAATGAGAA | ACAAGGGGAA | GATGGATATG | 1 8 0 |
| TGACATTATC | TTAAGACAAC | TCCAGTTGCA | ATTACTCTGC | AGATGAGAGG | CACTAATTAT | 2 4 0 |
| AAGCCATATT | ACCTTTCTTC | TGACAACCAC | TTGTCAGCCC | ACGTGGTTTC | TGTGGCAGAA | 3 0 0 |
| TCTGGTTCTA | TAACAAGTTC | CTAATAAGCT | GTAGCCAAAA | AAATTTGATG | AGGTATTATA | 3 6 0 |
| ATTATTTCAA | TATAAAGCAC | CCACTAGATG | GAGCCAGTGT | CTGCTTCACA | TGTTAAGTCC | 4 2 0 |
| TTCTTTCCAT | ATGTTAGACA | TTTCTTTGAA | GCAATTTTAG | AGTGTAGCTG | TTTCTCAGGT | 4 8 0 |

-continued

TAAAATTCTT AGTAG

495

(2) INFORMATION FOR SEQ ID NO:93:

- (i) SEQUENCE CHARACTERISTICS:
 (A) LENGTH: 500 base pairs
 (B) TYPE: nucleic acid
 (C) STRANDEDNESS: single
 (D) TOPOLOGY: linear

(i i) MOLECULE TYPE: DNA (genomic)

(x i) SEQUENCE DESCRIPTION: SEQ ID NO:93:

```

TATGGTTGCC TATTCTTGTC ACAGTAACTN AACTGATCTA GGAAAGAAAA AATGTTTTGT      60
CTTCTAGAGA TAAGTTAATT TTTAGTTTTTCTTCTCCTCA CTGTGGAACA TTCAAAAAAT      120
ACAAAAGGA AGCCAGGTGC ATGTGTAATG CCAGGCTCAG AGGCTGAGGC AGGAGGATCG      180
CTTGGGCCCA GGAGTTCACA AGCAGCTTGG GCAACGTAGC AAGACCCTGC CTCTATTAAA      240
GAAAACAAAA AACAAATATT GGAAGTATTT TATATGCATG GAATCTATAT GTCATGAAAA      300
AATTAGTGTA AAATATATAT ATTATGATTA GTTATCAAGA TTTAGTGATA ATTTATGTTA      360
TTTTGGGATT TCAATGCCTT TTTAGGCCAT TGTCTCAAAA AAATAAAAGC AGGAAAACAA      420
AAAAAGTTGT AACTTGAAAA ATAAACATTT CCATATTTAT AGCCAACATA GTGGGTTTNG      480
GGTNGGTTGG GTTGGTTGGT                                     500

```

(2) INFORMATION FOR SEQ ID NO:94:

- (i) SEQUENCE CHARACTERISTICS:
 (A) LENGTH: 385 base pairs
 (B) TYPE: nucleic acid
 (C) STRANDEDNESS: single
 (D) TOPOLOGY: linear

(i i) MOLECULE TYPE: DNA (genomic)

(x i) SEQUENCE DESCRIPTION: SEQ ID NO:94:

```

TTATCATTAA CAGGTCCCAC AACCCCTAAA AAGTACAGAT TTTTTTTTTTCTTNGTGGAGA      60
CAGGGTCTCA CTTGGTCGCC CAGACTGGAG TGCAGTGGCA CGATCTCAGT TCACCACAAC      120
CTCTGCCTCC TGGGTTCAAG CAATNCTCGT GCTTAAGCCT CCTGAGTAGG TGGAAACCACG      180
CGTGCGCGCC ACCACGCTAG GTTNATTGTG GCTTTTTTTAG TAGAGACAGG GTTTCGCCAT      240
GTTGCCCAGG CTGGTCTCAN ATTCCNGACC TCAAGTGATC CGNCCGCCTC AGACTCCCAA      300
AGTGNTGAGC ATTACAGNTG TGTACCACTA TGTCCCNGNC CNCATCTCTC TTTAAAACAN      360
CTTNCATTTA CCTAGTCCAC TCCTG                                     385

```

(2) INFORMATION FOR SEQ ID NO:95:

- (i) SEQUENCE CHARACTERISTICS:
 (A) LENGTH: 330 base pairs
 (B) TYPE: nucleic acid
 (C) STRANDEDNESS: single
 (D) TOPOLOGY: linear

(i i) MOLECULE TYPE: DNA (genomic)

(x i) SEQUENCE DESCRIPTION: SEQ ID NO:95:

```

GACCTAGAAA AGAAAGCATT TCAANNTAAT TAACAGGTCC CACAACCCTT AAAAAGTACA      60
GATTTTTTTT TTCTTTNNGG AGACAGGGTC TCACTTTGTC GCCCAGACTG GAGTGCAGTG      120
GCACGATCTC AGCTCACCAC ANCCTCTGCC TCCTGGGTTT AAGNANTTCT CGTGCTTANG      180

```

-continued

| | | | | | | |
|------------|------------|------------|------------|------------|------------|-------|
| CCTCCTGAGT | AGGTGGAACC | ACGCGTGTGC | GCCACCACGC | TAGGCTACTT | TNTGTATTTT | 2 4 0 |
| TAGTAGAGAC | AGGGTTTCGC | CATNTTGCCC | AGGCTGNTCT | CAAATTCCTG | ACCCNCAAGT | 3 0 0 |
| GATCCCCCN | CCTTCAGTAC | TCCCCATCAG | | | | 3 3 0 |

(2) INFORMATION FOR SEQ ID NO:96:

- (i) SEQUENCE CHARACTERISTICS:
 - (A) LENGTH: 382 base pairs
 - (B) TYPE: nucleic acid
 - (C) STRANDEDNESS: single
 - (D) TOPOLOGY: linear

(i i) MOLECULE TYPE: DNA (genomic)

(x i) SEQUENCE DESCRIPTION: SEQ ID NO:96:

| | | | | | | |
|------------|------------|------------|------------|------------|-------------|-------|
| GGTGGNCGTT | CTAGAACTAG | TGGCNCCCAA | GGNAGAAGAA | GTTTTCTTAG | TACAGAACAA | 6 0 |
| AATGAAANGT | CTCCCATGTC | TACTTCTTTC | TACACAGACA | CGGCATCCAT | CCGTTTTTCT | 1 2 0 |
| CANTCTTTCC | NCCACCTTTC | CCGTCTTTCT | ATTCCACAAA | GCCGNCATTG | TCATCCTGGC | 1 8 0 |
| CCNTTCTCAA | TGAGCTGTTG | NNTACACCTC | CCAGACGGCG | TGGTGGNCGG | TCAGAGGGGC | 2 4 0 |
| TCCTCACTTC | CCAGTAGGGG | TGGCCGNGCA | GGNGGTGCCC | CNCACCCCCC | GGGCGGGGTG | 3 0 0 |
| GTTNGTCCNN | CCGGNGGGNT | GCACCNCCCC | CACCCCTCCC | CNCTCTNCTA | CTGGCGGTCTG | 3 6 0 |
| TNTATTNCAN | NATCTTTAAG | CA | | | | 3 8 2 |

(2) INFORMATION FOR SEQ ID NO:97:

- (i) SEQUENCE CHARACTERISTICS:
 - (A) LENGTH: 360 base pairs
 - (B) TYPE: nucleic acid
 - (C) STRANDEDNESS: single
 - (D) TOPOLOGY: linear

(i i) MOLECULE TYPE: DNA (genomic)

(x i) SEQUENCE DESCRIPTION: SEQ ID NO:97:

| | | | | | | |
|------------|------------|------------|------------|------------|------------|-------|
| GGATCCAAAG | GAAGTTAGAG | GCCAGCTCAG | TCTACACCTG | CTACTGNTCA | GTGCCACCCC | 6 0 |
| GGTCAAGGGA | GACCAACACA | TGGTAAAGGT | CAAGGGCTTC | TTGGAAGGCA | GTCAGCAGCC | 1 2 0 |
| TGTGCAAGAT | GTTCTCCACA | CTGCTCAGNT | TAAGGGGAGC | TGGGGGCAGG | ACCTCAGCTG | 1 8 0 |
| GNATCTCTGC | TTCACCAGTG | TCCAGGGGTT | GCACAATTCT | TGTTTACTCG | TAGGATATTT | 2 4 0 |
| AATCTTGNN | GGTGCTATCA | TAAATGGGAC | TTATCCNCTN | ATTATGTTTT | CTTACTAGTT | 3 0 0 |
| GTTTATGTGA | AGGTTATTGA | TTTGGGTTTC | ACTTTATTTN | GTGGNAATGG | AGTTTCACTC | 3 6 0 |

(2) INFORMATION FOR SEQ ID NO:98:

- (i) SEQUENCE CHARACTERISTICS:
 - (A) LENGTH: 208 base pairs
 - (B) TYPE: nucleic acid
 - (C) STRANDEDNESS: single
 - (D) TOPOLOGY: linear

(i i) MOLECULE TYPE: DNA (genomic)

(x i) SEQUENCE DESCRIPTION: SEQ ID NO:98:

| | | | | | | |
|------------|------------|------------|------------|-------------|------------|-------|
| AATGTCACGG | ATTCCTTTAG | GTAGNTACAC | CCATCAACCT | TTTTGAGAAT | AAAATGAATT | 6 0 |
| GAGAGTGTTA | CAGTCTAATT | CTATATCACA | TGTAACTTTT | ATTTGGATAT | ATCAGTAATA | 1 2 0 |
| GTGCTTTTTT | TTTTTTTTTT | TTTTTTTTTT | TTTTTTTTTT | TGNGANAGAGT | CTCGCTCTGT | 1 8 0 |
| CGCCAGGTTG | GAGTGNAATG | GTGCGATC | | | | 2 0 8 |

-continued

(2) INFORMATION FOR SEQ ID NO:99:

- (i) SEQUENCE CHARACTERISTICS:
 (A) LENGTH: 470 base pairs
 (B) TYPE: nucleic acid
 (C) STRANDEDNESS: single
 (D) TOPOLOGY: linear

(i i) MOLECULE TYPE: DNA (genomic)

(x i) SEQUENCE DESCRIPTION: SEQ ID NO:99:

```

AACAAAGGTTT CTCGGTCGGC GGTGAATATA CCGGGGCGTC GATATTTGTT GCGGAATACT      6 0
CCCCTGACCG TAAACGTGGC TTTATGGGCA GCTGGCTGGA CTTCGGTTCT ATTGCCGGGT      1 2 0
TTGTGCTGGG TGCGGGCGTG GTGGTGTTAA TTTCGACCAT TGTCGGCGAA GCGAACTTCC      1 8 0
TCGATTGGGG CTGGCGTATT CCGTTCCTTA TCGCTCTGCC GTTAGGGATT ATCGGGCTTT      2 4 0
ACCTGCGCCA TGCCTGGAA GAGACTCCGG CGTTCAGCA GNATGTCGAT AAACCTGGAAC      3 0 0
AGGGCGACCG TGAAGGTTTG GAGGATGGCC CGAAAGTCTC GTTTAAAGAG ATTGGCACTA      3 6 0
AATACTGGNG CAGNCTGTTG AATGTTTGGG CTTGGTAATT GGCAACCAAC GTGATTACTA      4 2 0
NATGTTGGTG ACCTATATTG CCGAGTTATT GCGGATAAC CTGAATTATC      4 7 0

```

(2) INFORMATION FOR SEQ ID NO:100:

- (i) SEQUENCE CHARACTERISTICS:
 (A) LENGTH: 440 base pairs
 (B) TYPE: nucleic acid
 (C) STRANDEDNESS: single
 (D) TOPOLOGY: linear

(i i) MOLECULE TYPE: DNA (genomic)

(x i) SEQUENCE DESCRIPTION: SEQ ID NO:100:

```

TAATTATATT GAAATGCTTC TCNTCTAGGT CATCCATGNC TGGNTTATTA TATCATCTCT      6 0
ATTGNTGNTG CTCTTTTTTA CATNCATTTA CTTGGGGTAA GTTGTGAAAT TTGGGGTCTG      1 2 0
TCTTTCAGAA TTAACCTACCT NNGTGCTGTG TAGCTATCAT TTAAAGCCAT GTACTTTGNT      1 8 0
GATGAATTAC TCTGAAGTTT TAATTGTNTC CACATATAGG TCATACTTGG TATATAAAAG      2 4 0
ACTAGNCAGT ATTACTAATT GAGACATTCT TCTGTNGCTC CTNGCTTATA ATAAGTAGAA      3 0 0
CTGAAAGNAA CTTAAGACTA CAGTTAATTC TAAGCCTTTG GGAAGGATT ATATAGCCTT      3 6 0
CTAGTAGGAA GTCTTGTGCN ATCAGAATGT TTNTAAAGAA AGGGTNTCAA GGAATNGTAT      4 2 0
AAANACCAA AATAATTGAT      4 4 0

```

(2) INFORMATION FOR SEQ ID NO:101:

- (i) SEQUENCE CHARACTERISTICS:
 (A) LENGTH: 449 base pairs
 (B) TYPE: nucleic acid
 (C) STRANDEDNESS: single
 (D) TOPOLOGY: linear

(i i) MOLECULE TYPE: DNA (genomic)

(x i) SEQUENCE DESCRIPTION: SEQ ID NO:101:

```

AAAACAAAGC CTCTTGAGGT TCTGAAAAGG GAAAGAAAAA CAGAAGTTTG TGCACTACAA      6 0
TTATACTGTT ATAAAAACA CTTCCATAGA TTACATTAAG CAGAAACAAA CCTTCTTTTC      1 2 0
ATGTGTTCTC CTCCAGGCCA AGCTGTCTAA GGACCGCAAA GGCTGTTGTC ACTTGCAGGC      1 8 0
TCCCAGATTA GGTCTGAAAT AGGATTTAC CAGGTCATCC ATTGTTAGTT AAATCCTAGT      2 4 0
AAATTCATTT ANACCAATCA AATACTTATA AGACCAATTT GTAAACCAGG AATGTATTAA      3 0 0

```

-continued

| | | | | | | |
|------------|------------|------------|------------|------------|------------|-------|
| TTTGTCACGA | CTTTCAACTA | ACTGACAAAT | TTACTATAAG | CTCAAGGTAG | GACTCTTTAG | 3 6 0 |
| CAATAAGTAG | GAACCGCCTG | AGACAACCAA | ACATTTTCAA | CCCACAAANG | ATACTTTAAT | 4 2 0 |
| GACTTTCTGA | TTTNCCAGCA | AAAGGGGGG | | | | 4 4 9 |

(2) INFORMATION FOR SEQ ID NO:102:

- (i) SEQUENCE CHARACTERISTICS:
 - (A) LENGTH: 425 base pairs
 - (B) TYPE: nucleic acid
 - (C) STRANDEDNESS: single
 - (D) TOPOLOGY: linear

(i i) MOLECULE TYPE: DNA (genomic)

(x i) SEQUENCE DESCRIPTION: SEQ ID NO:102:

| | | | | | | |
|------------|------------|------------|------------|------------|------------|-------|
| GGATCCGCC | TCCTCGGCCT | CCCAAAGTGT | TGGGATTACA | GGCGTGAGCC | ACCGCACCTG | 6 0 |
| GCTTTTTTTT | TTTTTTTTTT | TGGNGGAGAC | AGAGTCTTAC | TCTGTTGCC | AAGCTGGAGT | 1 2 0 |
| GCAGTGGTGC | AATCTTGGTT | CACTGNAACC | TCCACCTCCA | GAGTTCAAGC | AATTCTCTGC | 1 8 0 |
| CTCAGTTTCT | GGAGTAGCTG | GGATTACAGG | TGCCTGCCAT | CACGCCTGGC | TAAATTTGGN | 2 4 0 |
| ATTTTTTTTT | AGTAGAGACA | GGTTTTCAAC | ATGTTGGCCA | GGCTGGTCTT | GAACTCCTGA | 3 0 0 |
| CCTTGTGATC | CACCAGCCTC | GGCCTCCCAA | ATTGNTGGGA | TTACAGGCGT | GAGCCACCAC | 3 6 0 |
| AACCAGGCTA | AAGTTTTAAA | ACATGCCAAG | TGTATTTACA | TAATGCGATA | CGANTTATGT | 4 2 0 |
| ACATA | | | | | | 4 2 5 |

(2) INFORMATION FOR SEQ ID NO:103:

- (i) SEQUENCE CHARACTERISTICS:
 - (A) LENGTH: 386 base pairs
 - (B) TYPE: nucleic acid
 - (C) STRANDEDNESS: single
 - (D) TOPOLOGY: linear

(i i) MOLECULE TYPE: DNA (genomic)

(x i) SEQUENCE DESCRIPTION: SEQ ID NO:103:

| | | | | | | |
|------------|------------|------------|------------|------------|------------|-------|
| GGATCCGCC | GCCTTGGCCT | CCCAAAGTGC | TGGGATTACA | GGCATGAGCC | ACCGCTCCTG | 6 0 |
| GCTGAGTCTG | CGATTTCTTG | CCAGCTCTAC | CCAGTTGTGT | CATCTTAAGC | AAGTCACTGA | 1 2 0 |
| ACTTCTCTGG | ATTCCCTTCT | CCTNTTGTA | AATAAGCATG | TTATCTGTCC | NNCCTGCCTT | 1 8 0 |
| GGGCATTGTG | ATAAGGATAA | GATGACATTA | TAGAATNTNG | CAAAATTA | AGCGCTAGAC | 2 4 0 |
| AAATGATTTT | ATGAAAATAT | AAAGATTAGN | TTGAGTTTGG | GCCAGCATAG | AAAAAGGAAT | 3 0 0 |
| GTTGAGAACA | TTCCNTTAAG | GATTACTCAA | GCTCCCTTTG | GTGTATATCA | GNGTCA | 3 6 0 |
| CNTATCTTNG | GGGCTGAAAA | ATGTTT | | | | 3 8 6 |

(2) INFORMATION FOR SEQ ID NO:104:

- (i) SEQUENCE CHARACTERISTICS:
 - (A) LENGTH: 224 base pairs
 - (B) TYPE: nucleic acid
 - (C) STRANDEDNESS: single
 - (D) TOPOLOGY: linear

(i i) MOLECULE TYPE: DNA (genomic)

(x i) SEQUENCE DESCRIPTION: SEQ ID NO:104:

| | | | | | | |
|------------|------------|------------|------------|------------|------------|-------|
| GAAAAGGGAA | AGAAAAACAG | AACTTTGTGC | ACTACAATTA | TACTGTTATA | AAAAACACTT | 6 0 |
| CCATAGATTA | CATTAAGCAG | AAACAAACCT | TTCTTTCATG | TGTTCTCCTC | CAGGCCAAGC | 1 2 0 |
| TGTCTAAGGA | CCGCAAAGGC | TGTTGTCACT | TGCAGGCTCC | CAGATTAGGT | CTGAAATAGG | 1 8 0 |

-continued

ATTTCAACCAG GTCATCCATT GTTAGTTAAA TCCTAGTAAA TNCA

2 2 4

(2) INFORMATION FOR SEQ ID NO:105:

- (i) SEQUENCE CHARACTERISTICS:
 (A) LENGTH: 440 base pairs
 (B) TYPE: nucleic acid
 (C) STRANDEDNESS: single
 (D) TOPOLOGY: linear

(i i) MOLECULE TYPE: DNA (genomic)

(x i) SEQUENCE DESCRIPTION: SEQ ID NO:105:

GGATCCGCCC TCCTCGGCCT CCCAAAGTGT TGGGATTACA GGCGTGAGCC ACCGCACCTG 6 0
 GCTTTTTTTT TTTTTTTTTT TGGNGGAGAC AGAGTCTTAC TCTGTTGCC C AAGCTGGAGT 1 2 0
 GCAGTGGTGC AATCTTGGTT CACTGCAACC TCCACCTCCA GAGTTCAAGC AATTCTCTGC 1 8 0
 CTCAGTTTCT GGAGTAGCTG GGATTACAGG TGCCTGCCAT CACGCCTGGN TAAATTTGGG 2 4 0
 ATTTTTTTTT AGTAGAGACA GGGTTTCANC ATGTTGGCCA GGNTGGTCTT GGACTCCTGA 3 0 0
 CCTGGTGAAC CACCAGGCTC GGGCTCCAAA TTTGGTTGGG ATTACAGGGG GTNAANCAAC 3 6 0
 CACAACCCAG NCTAAAGTTT TNAAAACATN CAAAGTGTTT TAAAATNATG NGATACGATT 4 2 0
 TATTGTACAA TTAATTTTAT 4 4 0

(2) INFORMATION FOR SEQ ID NO:106:

- (i) SEQUENCE CHARACTERISTICS:
 (A) LENGTH: 448 base pairs
 (B) TYPE: nucleic acid
 (C) STRANDEDNESS: single
 (D) TOPOLOGY: linear

(i i) MOLECULE TYPE: DNA (genomic)

(x i) SEQUENCE DESCRIPTION: SEQ ID NO:106:

GTCTTTCCCA TCTTCTCCAC AGAGTTTGTG CTTTACATTA TTA CTCTTG CCATTTTCAA 6 0
 GAAAGCATTG TCAGCTCTTC CAATCTCCAT CACCTTTGGG CTTGTTTTCT ACTTTGCCAC 1 2 0
 AGATTATCTT GTACAGCCTT TTATGGACCA ATTAGCATTC CATCAATTTT ATATCTAGCA 1 8 0
 TATTTGCGGN TAGAATCCCA TGGATGTTTC TTCTTTGACT ATAACAAAAT CTGGGGAGGA 2 4 0
 CAAAGGTGAT TTTCTGTGT CCACATCTAA CAAAGTCAAG ATCCCCGGCT GGACTTTTGG 3 0 0
 AGGTTCCCTC CAAGTCTTCC TGACCACCTT GCACTATTGG ACTTTGGNAA GGAGGTGCCT 3 6 0
 ATAGAAAACG ATTTTGGAAC ATACTTCATC GCAGGGGGAC TGTGTCCCCC GGTGGCAGAA 4 2 0
 NCTACCAAGA TTTGCGGGNC GAGGTCAA 4 4 8

(2) INFORMATION FOR SEQ ID NO:107:

- (i) SEQUENCE CHARACTERISTICS:
 (A) LENGTH: 198 base pairs
 (B) TYPE: nucleic acid
 (C) STRANDEDNESS: single
 (D) TOPOLOGY: linear

(i i) MOLECULE TYPE: DNA (genomic)

(x i) SEQUENCE DESCRIPTION: SEQ ID NO:107:

GGATCCGCCC GCCTTGGCCT CCCAAAGTGC TGGGATTACA GGCATGAGCC ACCGCTCCTG 6 0
 GCTGAGTCTG CGATTTCTTG CCAGCTCTAC CCAGTTGTGT CATCTTAAGC AAGTCACTGA 1 2 0
 ACTTCTCTGG ATTCCCTTCT CCTTNAGTAA AATAAGNATG TTATCTGNCC GCCCTGCCTN 1 8 0

-continued

GGNNATTGNG ATAAGGAT

198

(2) INFORMATION FOR SEQ ID NO:108:

- (i) SEQUENCE CHARACTERISTICS:
 (A) LENGTH: 500 base pairs
 (B) TYPE: nucleic acid
 (C) STRANDEDNESS: single
 (D) TOPOLOGY: linear

(i i) MOLECULE TYPE: DNA (genomic)

(x i) SEQUENCE DESCRIPTION: SEQ ID NO:108:

```

CTGCAGTGAG CCGTGATTGC ACCACTTTAC TCCAGCCTGG GCAACAAAAT GAGACCCTGG      60
CTCAAAAACA AAAACAAAAA CAAAAAAGA GTAAATTAAT TTAAAGGGAA GTATTAAATA      120
AATAATAGCA CAGTTGATAT AGGTTATGGT AAAATTATAA AGGTGGGATA TTAATATCTA      180
ATGTTTGGGA GCCATCACAT TATTCTAAAT AATGTNTTGG TGAAAATTAT TGTACATCTT      240
TTAAAATCTG TGTAATTTTT TTTCAGGGAA GTGTTTAAAA CCTATAACGT TGCTGTGGAC      300
TACATTACTG TTGCACTCCT GATCTGGAAT TTTGGGTGTG GTGGGAATGA TTTCCATTCA      360
CTGGAAAGGT CCACTTCGAC TCCAGCAGGC ATATCTCATT ATGATTAGTG CCTCATGGNC      420
CTGGTGTTTA TCAAAGTACC TCCCTGAATG GACTGCGTGG GTCATCTTGG NTGTGATTCA      480
GTATATGGTA AAACCCAAGA                                     500

```

(2) INFORMATION FOR SEQ ID NO:109:

- (i) SEQUENCE CHARACTERISTICS:
 (A) LENGTH: 500 base pairs
 (B) TYPE: nucleic acid
 (C) STRANDEDNESS: single
 (D) TOPOLOGY: linear

(i i) MOLECULE TYPE: DNA (genomic)

(x i) SEQUENCE DESCRIPTION: SEQ ID NO:109:

```

CTGCAGCCTT GACCTCCTGG GATCAATCGA TCCTCCCACC TCAGCCTCCT AAGTAGCTGG      60
AACTACAGGT GTGCACCACC ATGCCCGGCT AATNGNTGTA TTTTCTGTAG ATACGAGGTN      120
TNGCCATGTT GCCCAGGCTG GTCTTGAACT CTGGGCTTAG GTGATCTGCC CGCCTCAGCC      180
TCCCAAAGTG CTAAGATTAC AGGCATGAGC TACCATGCCC AGCCGAAATC TTCAAATGAA      240
AAAGTTACTA TAGCTAATTA ATGATTTACT GAAGAGTTAT GGGATGTACA CGTTACCATT      300
TTCTCTAAAT CAAGATAAAG AGATGAGGAA AGAAAACACT CCAGTGGGGC ATTCCTGTNA      360
CAAAACAAAT TATCAGTCTT GGGGTTTNAC CATATACTGA AATCACAGGC AAGATGAGCC      420
ACGCAGTCCA TNCAGGGAGG TACTGGATAA CACCAGGGNC ATGAGGGACT AATCATAATG      480
AGATATGCTG CTGGAGTCGA                                     500

```

(2) INFORMATION FOR SEQ ID NO:110:

- (i) SEQUENCE CHARACTERISTICS:
 (A) LENGTH: 550 base pairs
 (B) TYPE: nucleic acid
 (C) STRANDEDNESS: single
 (D) TOPOLOGY: linear

(i i) MOLECULE TYPE: DNA (genomic)

(x i) SEQUENCE DESCRIPTION: SEQ ID NO:110:

```

CTGCAGGATG AGAGCGATCT CTTNTTNCAT TTCCTGCGCT ACGCGCTGCG GCGGACCAA      60
TTCTTTCGCC ATAATAAATT CTCCTGACNA AAAAGGGGCT GTTAGCCCCT TTTTAAAATT      120

```

-continued

| | | | | | | |
|-------------|------------|-------------|-------------|------------|------------|-------|
| AATTTTCAGGT | GGAAGGGCTG | TTCACGTTGA | CCTGATAAGA | CGCGCCAGCG | TCACATCAGG | 1 8 0 |
| CAATCCATGC | CGGATGCAGC | GTAAACGCCT | TATCCC GCAT | GGAACCCTAA | AAACCTTAAG | 2 4 0 |
| CAATGGTACG | TTGGATCTCG | ATGATTTTCGA | ATACTTCGAT | CACATCGNCA | GTGCGGACGT | 3 0 0 |
| CGTTGTAGTT | CTTAACGCCG | ATACCACATT | CCATACCGTT | ACGGGACTTC | GTTAACGTCA | 3 6 0 |
| TCTTTGGAAG | CGGGGCAGGG | ACTCCAGCTC | GNCTTCGTAG | ATAACCACGT | TGGCACGCAG | 4 2 0 |
| GAACGCGGGT | CGGGTTGTGA | CGTTTAAACAC | AACTTCCGGG | TAACCATACA | GGCTGNGATG | 4 8 0 |
| GNACCAAATT | TCGGGGGATT | TGGACAAGTC | AAGAACTTCC | CGCCAGACCG | ATAATCTTGT | 5 4 0 |
| TGTTTCAGTTC | | | | | | 5 5 0 |

(2) INFORMATION FOR SEQ ID NO:111:

- (i) SEQUENCE CHARACTERISTICS:
 - (A) LENGTH: 541 base pairs
 - (B) TYPE: nucleic acid
 - (C) STRANDEDNESS: single
 - (D) TOPOLOGY: linear

- (i i) MOLECULE TYPE: DNA (genomic)

- (x i) SEQUENCE DESCRIPTION: SEQ ID NO:111:

| | | | | | | |
|------------|------------|------------|--------------|------------|------------|-------|
| CTGCAGCTTT | CCTTTAAACT | AGGAAGACTT | G TTCCTATAC | CCCAGTAACG | ATACACTGTA | 6 0 |
| CACTAAGCAA | ATAGCAGTCA | AACCCAAATG | AAATTTNTAC | AGATGTTCTG | TGTCATTTTA | 1 2 0 |
| TNTTGTTTAT | GTTGTCTCCC | CCACCCCCAC | CAGTTCACCT | GCCATTTATT | TCATATTCAT | 1 8 0 |
| TCAACGTCTN | NNTGTGTAAA | AAGAGACAAA | AAACATTA AAA | CTTTTTTCCT | TCGTTAATTC | 2 4 0 |
| CTCCCTACCA | CCCATTTACA | AGTTTAGCCC | ATACATTTTA | TTAGATGTCT | TTTATGTTTT | 3 0 0 |
| TCTTTTNCTA | GATTTAGTGG | CTGNGTTGTG | TCCGAAAGGT | CCACTTCGTA | TTGCTGGTTG | 3 6 0 |
| AAACAGCTCA | GGAGAGAAAT | GAAACGCTTT | TTCCAGCTCT | CATTTACTCC | TGTAAGTATT | 4 2 0 |
| TGGAGAATGA | TATTGAATTA | GTAATCAGNG | TAGAATTTAT | CGGGAACTTG | AAGANATGTN | 4 8 0 |
| ACTATGGCAA | TTTCANGGNA | CTTGTCTCAT | CTTAAATGAN | AGNATCCCTG | GACTCCTGNA | 5 4 0 |
| G | | | | | | 5 4 1 |

(2) INFORMATION FOR SEQ ID NO:112:

- (i) SEQUENCE CHARACTERISTICS:
 - (A) LENGTH: 241 base pairs
 - (B) TYPE: nucleic acid
 - (C) STRANDEDNESS: single
 - (D) TOPOLOGY: linear

- (i i) MOLECULE TYPE: DNA (genomic)

- (x i) SEQUENCE DESCRIPTION: SEQ ID NO:112:

| | | | | | | |
|------------|------------|------------|------------|------------|------------|-------|
| NNCCNCNCN | NNNNNNNTTN | NTNTTGCCCG | ATAACTATAG | GGNGACTTGG | AGATCCACCG | 6 0 |
| CGGTGGCGGN | CGNTCTAGAA | CTAGTGGATC | CCCCGGGNTG | CAGGACCCAA | CGCTGCCCGA | 1 2 0 |
| GATGCGCCGC | GTGCGGTTGC | TGGAGATGGC | GGACGCGATG | GATATGTTCT | GCCAAGGGTT | 1 8 0 |
| GGTTTGCGCA | TTCACAGTTC | TCCGCAAGAA | TTGATTGGCT | CCAATTCTTG | GAGTGGTGAA | 2 4 0 |
| T | | | | | | 2 4 1 |

(2) INFORMATION FOR SEQ ID NO:113:

- (i) SEQUENCE CHARACTERISTICS:
 - (A) LENGTH: 834 base pairs
 - (B) TYPE: nucleic acid
 - (C) STRANDEDNESS: single

-continued

(D) TOPOLOGY: linear

(i i) MOLECULE TYPE: DNA (genomic)

(x i) SEQUENCE DESCRIPTION: SEQ ID NO:113:

```

CCCCCCNCC  NNNNNTTTTN  NGCAGCCCGT  AATTACCCTC  ACTNCCGGGA  ACAAAGCTG      6 0
GGTACCGGGC  CCCCCTCGA  GGTGACGGT  ATCGATAAGC  TTGATATCGA  ATTCCTGCAG    1 2 0
TGTTTAAAAA  ATAAAATAAA  CTAAGTTTT  ATTTATGAGG  AGTACACTGC  TTTCTTGTA    1 8 0
ACACATGTAC  AAGCCATATA  ATAGAGTTCA  TTTTTTACCC  TAGTTACGGA  AACACTAGAA    2 4 0
AGTCTTCACC  CGGCCAAGAT  AACACATCTT  TAGTAAAAAT  AGCAAGAAAT  ATTTTATGGG    3 0 0
TTGTTTACTT  AAATCATAGT  TTTCAGGTTG  GGCACAGTGG  NTCATGCCTG  TAATCCCAGC    3 6 0
ACTTTATGCG  GNTGAGGCAG  GCAGATCAGT  TGAGGTCAGA  AGTTTGGAGA  CCAGNCTGGG    4 2 0
CAATGTGGNA  AAACCTCATC  TCCACTAAAA  ATACAAAAAT  TAGNCAGGCA  TGGTGGTGCA    4 8 0
CACATGTAAT  TCCAGNTACT  TGGGGAGGCT  GAGACAGGAG  GATCGNTTGA  ACCTAGGGAG    5 4 0
GGAGGAGTTG  GAGTGAGCTA  ATGTCAATGC  ACTCTTGGTT  GGGGCGANAG  AGCAAGATCT    6 0 0
TTCTTCCAAA  AAAAAAAAAA  AAAAAAAGC  CAGGTGNGGN  GGTCAAGGCT  GTAATCCAGA    6 6 0
ATTNGGGAGG  CCGNGGAGGN  NATCANTGNG  GNAGNGTCA  AGNGGGGCNG  GCCACATGGG    7 2 0
GAACCCGTTN  TTNTTAAATN  AAAATTAGCC  GGGGNGGGGG  AGGACTNTAT  CCNGTTCCGG    7 8 0
NGGTGNGGAG  GATCNTTATT  NTGGNGGAGG  GTGGATGNNC  CAGTTGACNC  CCCC          8 3 4

```

(2) INFORMATION FOR SEQ ID NO:114:

(i) SEQUENCE CHARACTERISTICS:

- (A) LENGTH: 838 base pairs
- (B) TYPE: nucleic acid
- (C) STRANDEDNESS: single
- (D) TOPOLOGY: linear

(i i) MOLECULE TYPE: DNA (genomic)

(x i) SEQUENCE DESCRIPTION: SEQ ID NO:114:

```

TTGGGCNCNC  GCCCCTTAAN  TTTTATNGN  TTNCTANAAA  AANANNNGGC  NCNNTAAAAAT    6 0
ATATTTTTTN  TTGTGACCCC  TTTTAAAAGG  GACCCNCTAA  AAAATTTTNT  GGTTNNTTTN    1 2 0
GATTTANGTG  GGTGNTTTTN  TTATATTTTT  GGNGAGNNTC  TGTAGTCNTC  NCCCTCAAAC    1 8 0
ANNTCNTACN  ATNGGNANCG  TGA CTCTGTC  NTTNGTNANN  NTCGNTNTCN  NGTNATTCNA    2 4 0
GGNNCCTCGC  GCNNCNCGGG  CNNNGTTTTT  TTTNNCNNTT  TTTAAGCCNA  ANNCTCAGTA    3 0 0
NCNTCCAACG  GNGCTNNGAC  ANNGNNNCT  NTCGNGGGTN  CCCTCTNTNT  NGNNCNGGCG    3 6 0
TNNNGNNNC  NGNCNGCNGN  GCCNTGCGNN  NNGNNNGNGG  NNGNTNNCA  TANGGATNGN    4 2 0
GNTGCTCNNC  NCNNGNGTNN  TNAGTAGGNA  NTTTTNTNNT  ACTTGCCNNC  NNNTNGCTGC    4 8 0
GAGNANAGCN  ANNTNGNNGN  AGNGNNGNTG  CGCGGANNTT  CCCCTGATNA  NCTCGAGCNG    5 4 0
NTTACNGGNG  CNNCCTNGAA  NAAGNGNNGT  ANNGTGCCGA  GNCGCTANNC  TGAGCCTGAG    6 0 0
TNTCGACNGG  NATNGTGNTT  CNTACNGTTA  NGGGNNGCNC  GANCGGGNTG  ANTCNCCGGN    6 6 0
NGANCNAGCG  ACTGCCTNTC  ANGCGAANCG  TNTCANGNNN  GTAGAGCANA  GGGTNANNNG    7 2 0
TCNNNNAAGC  NTNAGTGAN  TGTCNTNACN  NGTGANTTAC  GGCNTAGNCT  TGATNTNNAN    7 8 0
NCGAGGNNNN  ATNNANNNTT  GGANANTTNN  TNNNTCNCN  TCGCGGNGNG  NCNNGCCG      8 3 8

```

(2) INFORMATION FOR SEQ ID NO:115:

(i) SEQUENCE CHARACTERISTICS:

- (A) LENGTH: 803 base pairs

-continued

(B) TYPE: nucleic acid
 (C) STRANDEDNESS: single
 (D) TOPOLOGY: linear

(i i) MOLECULE TYPE: DNA (genomic)

(x i) SEQUENCE DESCRIPTION: SEQ ID NO:115:

```

ATTCGCGCGT AGCCCGATAA CTATAGGGCG ACNTGGAGNT CCACCGCGGT GCGGGCCGCT      6 0
CTAGNAACTA GTGGATCCCC CGGGCTGCAG GAATTCACGG ACTAATCCTC TACAGATCTT      1 2 0
GCTGGAGTGG CCTTTCAGCC TTTTGTGACT GTTTGTAGTG AAATGTACAC ACAAGCCTAC      1 8 0
AAGGCAGCCC AGATGTACCA TAACTGTGGG AAAATTAAAA AAAAAAAAAAC ACAGAACCTC      2 4 0
TCTATGTTGC CCATGCTGGA CTCAAACCTCT TAGACAAGCA ATCCTCGTAC CTCAGCCTCC      3 0 0
TGAGTTCCTG AGTAGCTGGG ACTACAAGCA TGCACCACCA TGCCAGGCTA TGAGAAAGTT      3 6 0
CTTTTTATTG ATCCAGACCT TATTGCCTGG TAACTTCCAC CACTGTTCTT AGCTCTGNTC      4 2 0
TCTGGTCCTA ACAGAGGAAA ATCTTGACCC CACACCTAGT GCAACTGGAT AGCTTATNGT      4 8 0
TGGGCTNGTG TTTCTCTAT TCTGGGTCCA CCCTAAAATC CNATAGATAC TCCAACCTGCT      5 4 0
CANAGNAAAC CAAGCTCTCT CTCTNNCTTN CTTTCTTNNN CTCTATTNAT TNATGGGNNA      6 0 0
TNATTNATTN NGGGGATGGN GTTCGGTCGC CGCCCGGCTG GNGTGAAATG GGGGAGGCAA      6 6 0
TCAATTTAAC CCCACCCNGG GTCCAGGGAT CTCGTTNAAA CCGNNNNNNN NNNNNNNNNA      7 2 0
NGNNCNNCNC NNNCCNNTNN NNGGTTTNN NNGNNNNGGG NNNCCNNNNN NANNNNNNTN      7 8 0
NNNCCNCNA NNNTNCNNNN CCC                                          8 0 3

```

(2) INFORMATION FOR SEQ ID NO:116:

(i) SEQUENCE CHARACTERISTICS:
 (A) LENGTH: 780 base pairs
 (B) TYPE: nucleic acid
 (C) STRANDEDNESS: single
 (D) TOPOLOGY: linear

(i i) MOLECULE TYPE: DNA (genomic)

(x i) SEQUENCE DESCRIPTION: SEQ ID NO:116:

```

CNNNNNNNCC CNNTNATTNT ACGCCAGCCG CGTAATTAAC CCTCACTAAA GGAACAACAAA      6 0
GCTGGGTACC GGGCCCCCCC TCGAGGTCGA CGGTATCGAT AAGCTTGATA TCGAATTCCA      1 2 0
ACTCCTCACT TGCCAGATGT GACCTTAAGC AAGTGAAGTT CTGTGTGCCA CACTGTTTTTTC      1 8 0
ATCTGTAAAA GGATAAAGGG AATATCATAA ATTAGNTTGT TAAGCCTTAG TTTAATAATG      2 4 0
TCTCTAAGTT TTACATATAA GTAGACAGTG TCTTTCTTGT TTAGTGAATA ATCATTCTTA      3 0 0
TTATTTAATA GTATCTCTAC TAAATTTATT GTGTAAGATT ATACTAATCT TGTTTAGTGC      3 6 0
GTGGTAATCA CTTCTGCTCA TATTTAACCT ATAAGCATAA TATAGTTTAT TTATATACCA      4 2 0
NTTATTTATT TTATTTTATT TGNNGAGATG CAGCTTGTCT TTTNCAACCC AGGGNTGNGG      4 8 0
NGNAGNNGNG NAANCTTGNT TCACTGNAAC CNCCACCNC CAGGTNCAAG NGATTCTCCT      5 4 0
GNTCAAGCCN CCTNAGNAGN TGGNATTACA GNACGANTAC ANNCCAGNTA NNNNGGNTNT      6 0 0
NNGNTNGNNA GGNNNCACAN NNGNCAGGTN NNTCGNCTCC NNGCCANTNA CTNNNNCCAN      6 6 0
CCCCNNGGNN NNNNATANAG NATNANCANN NNCCNCNNNN NCNNNNNNNG GNGGANNCCN      7 2 0
NNTNGCNGNN ANNGNNANN NNTNNNNNNN NNGGNCNNNG NNNNNNNNCC NNNNNNCCCC      7 8 0

```

(2) INFORMATION FOR SEQ ID NO:117:

(i) SEQUENCE CHARACTERISTICS:
 (A) LENGTH: 803 base pairs

-continued

(B) TYPE: nucleic acid
 (C) STRANDEDNESS: single
 (D) TOPOLOGY: linear

(i i) MOLECULE TYPE: DNA (genomic)

(x i) SEQUENCE DESCRIPTION: SEQ ID NO:117:

```

NNNNNNNNNC  CNNNNNTTC  GNNCGTAACN  CGANTCACTA  TAGGGCGACT  TGGAGCTCCA      6 0
CCGCGGTGGC  GGCCGCTCTA  GAACTAGTGG  ATCCCCCGGG  CTGCAGGAAT  TCGATATCAA     1 2 0
GCTTTNGTGT  GTAAAAAGTA  TTAGAATCTC  ATGTTTTTGA  ACAAGGTTGG  CAGTGGGTTG     1 8 0
GGAGGAGGGA  TTGGAGATTG  ATGCGATAGG  AATGTGAAGG  GATAGCTTGG  GGTGGATTTT     2 4 0
ATTTTTTAAT  TTTAATTTTT  ATTTNTTGAG  ATGGAGTCTT  GCTCTGTCTC  CCAGGCTGGA     3 0 0
GTGCAGTGGT  GTGATCTCAG  CTCACGGGTT  CAAGCGATTC  TCCTGCTGCA  GCCTCCCGAG     3 6 0
TAGCTGGGAT  TACAGGAGCG  CGCCACCACA  CCCGGNTAAT  TTNNTTGTAT  TTTTAGTAGA     4 2 0
GACGGGGTTT  CACCATGTTG  GTTAGGCTGG  TCTAGAACTC  CCAACCTCAT  GATCCGCCTG     4 8 0
CTTCGGCCTC  CCAAAGTGCC  GGAATTACAG  GCGTGAGCGA  CTGCACCCGG  CCGCTTGGGG     5 4 0
GTGGATTTTT  AAAGAAATTT  AGAAGAATGT  AACTTGGCCA  GATACCATGT  ACCCGTTAAT     6 0 0
TCATTTNCGG  TTTTTTGGAT  ACCCATTTTG  NNATTCTCCC  NCCACTGGAT  AAATAAGGGN     6 6 0
GGTTCATTNT  NGNTTAGTTT  GGGTNTTTTT  NAGTGTGGNT  TCTGCTTATN  ATTAGAATGG     7 2 0
NCTNCTTTNC  CAANCTGGAA  AGGGAGGAGT  TAAAATCANT  ACCAGAANCA  GAAATTCTTT     7 8 0
TCANTTGTTG  CNCNAGAAAT  GCC                                     8 0 3

```

(2) INFORMATION FOR SEQ ID NO:118:

(i) SEQUENCE CHARACTERISTICS:
 (A) LENGTH: 819 base pairs
 (B) TYPE: nucleic acid
 (C) STRANDEDNESS: single
 (D) TOPOLOGY: linear

(i i) MOLECULE TYPE: DNA (genomic)

(x i) SEQUENCE DESCRIPTION: SEQ ID NO:118:

```

TNCNNNNCN  NNNNNAATTT  TNGCAGNCGC  GTAATTAACC  TCACTAAAGG  GAACAAAAGC      6 0
TGGGTACCGG  GCCCCCCTC  GAGGTCGACG  GTATCGATAA  GCTTCCCTCC  CCTTCCTCAG     1 2 0
CTCTGGCGAC  CCTGCGCTGT  GGTGGTTCTC  CAACCACACT  CATTCTCCTC  AGCTGGCTCC     1 8 0
TTGCTCTTCT  TCCACCCCT  CGTTGGAAGT  GTTCCTAAGT  GTTTGGCTTG  GCCTCCTCTT     2 4 0
CCCCTTCCTT  AGNTTAGACT  TCTCCACTGC  TCCAACATCA  ACTGGAAATC  TATGGAATTG     3 0 0
ATTCCTGTTT  TCAGCTCCAG  TCCTGTTTAC  AGGGCATTTT  CACCTGCTGG  CACTTCCAAA     3 6 0
GTGACACTTC  CAAACCACTT  CCTCGCCCTC  CTCTCTAAAC  CAGGTCTTTC  TTCCTAACTT     4 2 0
CCTTATTTCT  GAGAATGTCT  CTGNCATGTT  CTAAACTGAA  AACTCCTAGT  CAACTNCACA     4 8 0
CTTTATTCCC  TGGATCCTCA  ATTGGGTTCC  CATGTNCCGT  TAGTGTTTCT  TGGTAAGNCT     5 4 0
CTGCCANCAC  CGNAGGATCG  ACTCTAATCA  CATCTCAACT  GAATTATGGN  AAAGTCAACT     6 0 0
CAATTCTCTC  AACCATCCCA  GGCTCCACTA  TGGNTAATAT  GCTAAGGAGA  GCTGACCCAA     6 6 0
CGGGGAGAAG  ATCTGNNGGG  GAGGAGAGAA  ACAAAGNTAA  TGGAATNATT  CTCGAAAAGC     7 2 0
CCACAAGGNG  AAGGATAACC  CNCTTCCNCT  CGAAAGAGGG  GGGATCGCCA  GATNTCGCGC     7 8 0
CCGGAAAGAA  ACCGGGGNGA  GGGGGTTACA  NTGTAAGNC                                     8 1 9

```

(2) INFORMATION FOR SEQ ID NO:119:

-continued

(i) SEQUENCE CHARACTERISTICS:
 (A) LENGTH: 796 base pairs
 (B) TYPE: nucleic acid
 (C) STRANDEDNESS: single
 (D) TOPOLOGY: linear

(i i) MOLECULE TYPE: DNA (genomic)

(x i) SEQUENCE DESCRIPTION: SEQ ID NO:119:

```
TNTTGGCTGG TACTGCTTGA GCAACTGGTG AAACTCCGCG CCTCACGCC CCGGTGTGTC      6 0
CTTGTCCAGG GCGGACGAGC ATTCTGGGCG AAGTCCGCAC GCCTCTTGTT CGAGGCGGAA      1 2 0
GACGGGGTCT GATGCTTTCT CCTTGGTCGG GACTGTCTCG AGGCATGCAT GTCCAGTGAC      1 8 0
TCTTGTGTTT GCTGCTGCTT CCCTCTCAGA TTCTTCTCAC CGTTGTGGTC AGCTCTGCTT      2 4 0
TAGGCATATT AATCCATAGT GGAGGCTGGG ATGGGTGAGA GAATTGAGGT GACTTTTCCA      3 0 0
TAATTCAGGT GAGATGTGAT TAGAGTTCGA TCTGCGGTGG TGGCAGAGGC TTACAAGAAA      3 6 0
CACTAACGGG ACATGGGAAC CAATTGAGGA TCAGGGAATA AAGTGTGAAG TTGACTAGGA      4 2 0
GGTTTTTCAGT TTAGAACATG GCAGAGACAT TCTCAGAAAT AAGGAAGTTA GGAAGAAAGA      4 8 0
CTGGTTTAGA GAGGAGGGCG ANGAAGTGGT TTGGGAAGTG TCACTTTGGG AAGTGCCAGC      5 4 0
AGGTGAAAAT GCCTGTGACA GGATGGAGCT GAAAACAGGA TCAATTCCAT AGATTCCAGT      6 0 0
TGATGTNGGA GCAGGGGAGA AGTCTTAGCT AAGGAAGGGG AAGAGGAGGC CAAGGNAACA      6 6 0
CTTAGGACAA TTGNAACGAN GGGGGGGGAG AAGAGNAAGG GCCACTTAGG GGAATAATNT      7 2 0
GGTGGGGGAC CCCCAAGNNA GGGCGCANNN TTAGGAGGGG GGGANNTCAN AGGAAAGTGG      7 8 0
AAGNTTGGGT TTANCT                                     7 9 6
```

(2) INFORMATION FOR SEQ ID NO:120:

(i) SEQUENCE CHARACTERISTICS:
 (A) LENGTH: 802 base pairs
 (B) TYPE: nucleic acid
 (C) STRANDEDNESS: single
 (D) TOPOLOGY: linear

(i i) MOLECULE TYPE: DNA (genomic)

(x i) SEQUENCE DESCRIPTION: SEQ ID NO:120:

```
ATTCGTCGTA NCCCGATNAC TATAGGGCGA CTTGGAGCTC CACCGCGGTG GCGGNCGCGG      6 0
GCAGGGNCCG GNCCTTTGTG GCCGCCCGGG CCGCGAAGCC GGTGTCCTAA AAGATGAGGG      1 2 0
GCGGGGCGCG GNCGGTTGGG GCTGGGGAAC CCCGTGTGGG AAACCAGGAG GGGCGGCCCG      1 8 0
TTTCTCGGGC TTCGGGCGCG GCCGGGTGGA GAGAGATTCC GGGGAGCCTT GGTCCGAAA      2 4 0
TGCTGTTTGC TCGAAGACGT CTCAGGGCGC AGGTGCCTTG GGCCGGGATT AGTAGCCGTC      3 0 0
TGAACTGGAG TGGAGTAGGA GAAAGAGGAA GCGTCTTGGG CTGGGTCTGC TTGAGCAACT      3 6 0
GGTGAAACTC CGCGCCTCAC GCCCCGGGTG TGTCTTGTG CAGGGGCGAC GAGCATTCTG      4 2 0
GGCGAAGTCC GCACGCCTCT TGTTGAGGCG GGAAGACGGG GTCTTGATGC TTTCTCCTTG      4 8 0
GGTCGGGGAC TGTCTCGAGG CATGCATGTC CAGTGACTCT TGTGTTTGGT GNTGCTTCCC      5 4 0
TCTCAGATCT TCTCACCGNG GTGGGCAACT CTGTTTAGGC ATATTATCCA TAGNGGAGGC      6 0 0
TGGATGGTTG AAANAATTGA GGTNATTTTC CATAATCAAG TGAAATTTGA TAGAGTCCGN      6 6 0
CTTTNNGGGT GNAAGGGTTA AAAAAAATA ACGGAAATGG AACAATGAGG TCAAGGATTA      7 2 0
GTTGAGTTGN TAGNGGTTCA ATTAGANATG AAGGNATCTA AAATAGGAGT AGAGAANNNG      7 8 0
TTNAAAGAGG GAAAATTTTG CC                                     8 0 2
```

-continued

(2) INFORMATION FOR SEQ ID NO:121:

- (i) SEQUENCE CHARACTERISTICS:
 (A) LENGTH: 793 base pairs
 (B) TYPE: nucleic acid
 (C) STRANDEDNESS: single
 (D) TOPOLOGY: linear

(i i) MOLECULE TYPE: DNA (genomic)

(x i) SEQUENCE DESCRIPTION: SEQ ID NO:121:

```

ATATGCAGCC GCGTAATTAA CCTCACTAAA GGGAACAAAA GCTGGGTACC GGGCCCCCCC      6 0
TCGAGGTCGA CGGTATCGAT AAGCTTGATA TCGAATTCCT GCAGCCCGGG GGATCCGCCC      1 2 0
CGCGGCCTCC CAAAGTGCTG GGATTACAGG CGTGAGCCAC CGCCCCGGGN CTCACATTTT      1 8 0
ATTTCTATTG GCTAGCGCTG CTCTAAATCT TCTGTTTCCT CTGCTACACC AGGCCTAACA      2 4 0
CTCAAATCC CTGCCAACCT TTTCTTCCT GAAGCTTCCC TCCCCTTCCT CAGCTCTGGC      3 0 0
GACCCTGCGC TGTGGTGGTT CTCCAACCAC ACTCATTCTC CTCAGCTGGC TCCTTGCTCT      3 6 0
TCTTCCACCC CCTCGNTGGA AGTGTTCTTA AGTGTTTGGC TTGGCCTCCT CTTCCCCTTC      4 2 0
CTTAGCTTAG ACTTCTCCAC TGCTCCAACA TCAACTGGAA ATCTATGGAA TTGATTCCTG      4 8 0
TTTCAGCTCC AGTCCTGTTC ACAGGGGATT TTCANCTGGT GGCATTTCCA AAGTGAAATT      5 4 0
CCAAACCACT TCCTCGGCCT CCTCTTCTAA ANCAGGTCTT TCTTCCTAAC TTCCTTATTC      6 0 0
TTGAGAATGT CTCTGCATGT TCTTAAANTG AAAACTCCTA GTCAAATTCA AATTTATCCC      6 6 0
TGATCCCAA TGGTCCCATT CCCGTAGGGT TTNTGTAGCC TGCACACCGA GGTCGGANTT      7 2 0
TATNNATTCA CCGATTATGG AAAGTAACCA ATCTTNACCA NCCAGCTCAT TTGTTNTNTG      7 8 0
CTAAGAGGGT NCC                                                                7 9 3

```

(2) INFORMATION FOR SEQ ID NO:122:

- (i) SEQUENCE CHARACTERISTICS:
 (A) LENGTH: 440 base pairs
 (B) TYPE: nucleic acid
 (C) STRANDEDNESS: single
 (D) TOPOLOGY: linear

(i i) MOLECULE TYPE: DNA (genomic)

(x i) SEQUENCE DESCRIPTION: SEQ ID NO:122:

```

AAAGTCATGG ATTCCTTTAG GTAGCTACAT TATCAACCTT TTTGAGAATA AAATGAATTG      6 0
AGAGTGTTAC AGTCTAATTC TATATCACAT GTAACCTTTTA TTTGGATATA TCAGTAATAG      1 2 0
TGCTTTTTTCN TTTTTTTTTT TTNTTTTTTT TNNTTTTNGG GGANAGAGTC TCGCTCTGTC      1 8 0
GCCAGGTTGG AGTGCAATGG TGCGATCTTG GCTCACTGAA AGCTCCACCN CCCGGGTTC A      2 4 0
AGTGATTCTC CTGCCTCAGC CNCCCAAGTA GNTGGGACTA CAGGGGTGCG CCACCACGCC      3 0 0
TGGGATAATT TTGGGNTTTT TAGTAGAGAT GGC GTTTT CAC CANCTTGGNG CAGGCTGGTC      3 6 0
TTGGAACTCC TGANATCATG ATCTGCCTGC CTTAGCCTCC CCAAAGTGCT GGGATTNCAG      4 2 0
GGGTGAGCCA CTGTTCTCTGG                                                         4 4 0

```

(2) INFORMATION FOR SEQ ID NO:123:

- (i) SEQUENCE CHARACTERISTICS:
 (A) LENGTH: 453 base pairs
 (B) TYPE: nucleic acid
 (C) STRANDEDNESS: single
 (D) TOPOLOGY: linear

(i i) MOLECULE TYPE: DNA (genomic)

-continued

(x i) SEQUENCE DESCRIPTION: SEQ ID NO:123:

| | | | | | | |
|-------------|-------------|------------|------------|--------------|------------|-----|
| CTTAGTCTGT | NTCGTAGTCA | TATTAATTGT | AAGTNTACAC | TAATAAGAAT | GTGTCAGAGC | 60 |
| TCTTAATGTC | AAAAC TTTGA | TTACACAGTC | CCTTTAAGGC | AGTTCTGTTT | TAACCCCAGG | 120 |
| TGGGT TAAAT | ATTCCAGCTA | TCTGAGGAGC | TTTTNGATAA | TTGGACCTCA | CCTTAGTAGT | 180 |
| TCTCTACCCT | GGCCACACAT | TAGAATCACT | TGGGAGCTTT | TAAAAC TGT A | AGCTCTGCCC | 240 |
| TGAGATATTC | TTACTCAATT | TAATTGTGTA | GTTTTTAAAA | TTCCCCAGGA | AATTCTGGTA | 300 |
| TTTCTGTTTA | GGAACCGCTG | CCTCAAGCCT | AGCAGNACAG | ATATGTAGGA | AATTAGCTCT | 360 |
| GTAAGGTTGG | TCTTACAGGG | GATAAACAGA | TCCTTCCTTA | GNCCCTGGGA | CTTAATCACT | 420 |
| GAGAGTTTGG | GTGGNGGTTT | NGNATTTAAT | GAC | | | 453 |

(2) INFORMATION FOR SEQ ID NO:124:

(i) SEQUENCE CHARACTERISTICS:

- (A) LENGTH: 369 base pairs
- (B) TYPE: nucleic acid
- (C) STRANDEDNESS: single
- (D) TOPOLOGY: linear

(i i) MOLECULE TYPE: DNA (genomic)

(x i) SEQUENCE DESCRIPTION: SEQ ID NO:124:

| | | | | | | |
|-------------|------------|------------|-------------|------------|------------|-----|
| GACACACATT | CACACATAAT | TATGAAAGCA | TTTTTCAGGCA | AAACTCAATC | ACAAGTCTGG | 60 |
| GTTTTTAACA | TAGTTAACTG | AATATTTCCC | TTGGGGGGTT | AAATTTTAGA | ACAGACGTNC | 120 |
| ATNCAATCTG | GAAGAAGAGC | TATGAAAAAA | ACCTAGCTTG | GGTNGGTTTC | ATAGGGTNCA | 180 |
| TTATGNACAC | ATTGTTATTT | TATCCCTTAA | TNCTAGTAAA | GAAATAGAAT | CTGAAAATAA | 240 |
| GTA AAACTAC | TTGGAAAAAA | NTTAAAAGAT | ACAGAAATTT | CTATCTTAAA | TGATGTGTGG | 300 |
| GCCNCTGTGA | TTTTAGTNGG | GNTGGTTAAA | ANCC CAGAGG | TGAAGAGNAT | NCTCTATGCT | 360 |
| GTGNGGGGG | | | | | | 369 |

(2) INFORMATION FOR SEQ ID NO:125:

(i) SEQUENCE CHARACTERISTICS:

- (A) LENGTH: 516 base pairs
- (B) TYPE: nucleic acid
- (C) STRANDEDNESS: single
- (D) TOPOLOGY: linear

(i i) MOLECULE TYPE: DNA (genomic)

(x i) SEQUENCE DESCRIPTION: SEQ ID NO:125:

| | | | | | | |
|------------|------------|-------------|------------|------------|------------|-----|
| GCTCATCATG | CTTCACGGGG | GAGGCTGTGC | GGGAAGAATG | CTCCCACACA | GNATAAAGAA | 60 |
| TGCTCCCGCA | CAGGATAGAG | AATGCCCCCG | CACAGCATAG | AGAAGCCCCC | GCACAGCATA | 120 |
| GAGAATGCCC | CCNCACAGCA | TAGAGAAGCC | CCCGCACAGC | ATAGAGAATG | CTCTTCACCT | 180 |
| CTGGGTTTTT | AACCAGCCAA | ACTAAAATCA | CAGAGGSCMA | CACATCATT | AAGATAGAAA | 240 |
| TTTCTGTATC | TTTTAATTTY | TTTCMAAGTA | GTTTTACTTA | TTTTCAGATT | CTATTTCTTT | 300 |
| ACTAGAATTA | AGGGATAAAA | TAACAATGTG | TGCATAATGA | ACCCTATGAA | ACMAACMMAA | 360 |
| GCTAGGTTTT | TTTCATAGST | CTTCTTCCAG | ATTGAATGAA | CGTCTGTTCT | AAAATTTAAC | 420 |
| CCCCCAGGGA | AATATTCAGT | TA ACTATGTT | AAAAACCCAG | ACTTGTGATT | GAGTTTTGCC | 480 |
| TGAAAATGCT | TTCATAATTA | TGTGTGAATG | TGTGTC | | | 516 |

(2) INFORMATION FOR SEQ ID NO:126:

(i) SEQUENCE CHARACTERISTICS:

-continued

- (A) LENGTH: 121 base pairs
- (B) TYPE: nucleic acid
- (C) STRANDEDNESS: single
- (D) TOPOLOGY: linear

(i i) MOLECULE TYPE: DNA (genomic)

(x i) SEQUENCE DESCRIPTION: SEQ ID NO:126:

GTATAATGCA GGTGCTATAA GGTGAGCATG AGACACAGAT CTTTGCTTTC CACCCTGTTC 6 0
 TTCTTATGGT TGGGTATTCT TGTCACAGTA ACTTAACTGA TCTAGGAAAG AAAAAATGTT 1 2 0
 T 1 2 1

(2) INFORMATION FOR SEQ ID NO:127:

- (i) SEQUENCE CHARACTERISTICS:
 - (A) LENGTH: 18 base pairs
 - (B) TYPE: nucleic acid
 - (C) STRANDEDNESS: single
 - (D) TOPOLOGY: linear

(i i) MOLECULE TYPE: DNA (genomic)

(x i) SEQUENCE DESCRIPTION: SEQ ID NO:127:

TGGAGACTGG AACACAAC 1 8

(2) INFORMATION FOR SEQ ID NO:128:

- (i) SEQUENCE CHARACTERISTICS:
 - (A) LENGTH: 21 base pairs
 - (B) TYPE: nucleic acid
 - (C) STRANDEDNESS: single
 - (D) TOPOLOGY: linear

(i i) MOLECULE TYPE: DNA (genomic)

(x i) SEQUENCE DESCRIPTION: SEQ ID NO:128:

GTGTGGCCAG GGTAGAGAAC T 2 1

(2) INFORMATION FOR SEQ ID NO:129:

- (i) SEQUENCE CHARACTERISTICS:
 - (A) LENGTH: 19 base pairs
 - (B) TYPE: nucleic acid
 - (C) STRANDEDNESS: single
 - (D) TOPOLOGY: linear

(i i) MOLECULE TYPE: DNA (genomic)

(x i) SEQUENCE DESCRIPTION: SEQ ID NO:129:

ATCTCCGGCA GGCA TATCT 1 9

(2) INFORMATION FOR SEQ ID NO:130:

- (i) SEQUENCE CHARACTERISTICS:
 - (A) LENGTH: 21 base pairs
 - (B) TYPE: nucleic acid
 - (C) STRANDEDNESS: single
 - (D) TOPOLOGY: linear

(i i) MOLECULE TYPE: DNA (genomic)

(x i) SEQUENCE DESCRIPTION: SEQ ID NO:130:

TGAAATCACA GCCAAGATGA G 2 1

(2) INFORMATION FOR SEQ ID NO:131:

- (i) SEQUENCE CHARACTERISTICS:
 - (A) LENGTH: 19 base pairs

-continued

(B) TYPE: nucleic acid
 (C) STRANDEDNESS: single
 (D) TOPOLOGY: linear

(i i) MOLECULE TYPE: DNA (genomic)

(x i) SEQUENCE DESCRIPTION: SEQ ID NO:131:

CCATAGCCTG TTTCTAGC

19

(2) INFORMATION FOR SEQ ID NO:132:

(i) SEQUENCE CHARACTERISTICS:
 (A) LENGTH: 19 base pairs
 (B) TYPE: nucleic acid
 (C) STRANDEDNESS: single
 (D) TOPOLOGY: linear

(i i) MOLECULE TYPE: DNA (genomic)

(x i) SEQUENCE DESCRIPTION: SEQ ID NO:132:

CCATAGCCTA TTTCTAGC

19

(2) INFORMATION FOR SEQ ID NO:133:

(i) SEQUENCE CHARACTERISTICS:
 (A) LENGTH: 2791 base pairs
 (B) TYPE: nucleic acid
 (C) STRANDEDNESS: single
 (D) TOPOLOGY: linear

(i i) MOLECULE TYPE: cDNA

(x i) SEQUENCE DESCRIPTION: SEQ ID NO:133:

TGGGACAGGC AGCTCCGGGG TCCGCGGTTT CACATCGGAA ACAAACAGC GGCTGGTCTG 60
 GAAGGAACCT GAGCTACGAG CCGCGGCGGC AGCGGGGCGG CGGGGAAGCG TATACCTAAT 120
 CTGGGAGCCT GCAAGTGACA ACAGCCTTTG CGGTCCTTAG ACAGCTTGGC CTGGAGGAGA 180
 ACACATGAAA GAAAGAACCT CAAGAGGCTT TGTTTTCTGT GAAACAGTAT TTCTATACAG 240
 TTGCTCCAAT GACAGAGTTA CCTGCACCGT TGTCCTACTT CCAGAATGCA CAGATGTCTG 300
 AGGACAACCA CCTGAGCAAT ACTGTACGTA GCCAGAATGA CAATAGAGAA CGGCAGGAGC 360
 ACAACGACAG ACGGAGCCTT GGCCACCCTG AGCCATTATC TAATGGACGA CCCAGGGTA 420
 ACTCCCGGCA GGTGGTGGAG CAAGATGAGG AAGAAGATGA GGAGCTGACA TTGAAATATG 480
 GCGCCAAGCA TGTGATCATG CTCTTTGTCC CTGTGACTCT CTGCATGGTG GTGGTCGTGG 540
 CTACCATTA GTCAGTCAGC TTTTATACCC GGAAGGATGG GCAGCTAATC TATACCCCAT 600
 TCACAGAAGA TACCGAGACT GTGGGCCAGA GAGCCCTGCA CTCAATTCTG AATGCTGCCA 660
 TCATGATCAG TGTCATTGTT GTCATGACTA TCCTCCTGGT GGTTCTGTAT AAATACAGGT 720
 GCTATAAGGT CATCCATGCC TGGCTTATTA TATCATCTCT ATTGTTGCTG TTCTTTTTTT 780
 CATTCAATTA CTTGGGGGAA GTGTTTAAA CCTATAACGT TGCTGTGGAC TACATTAATG 840
 TTGCACTCCT GATCTGGAAT TTTGGTGTGG TGGGAATGAT TTCCATTAC TGGAAAGGTC 900
 CACTTCGACT CCAGCAGGCA TATCTCATTG TGATTAGTGC CCTCATGGCC CTGGTGTTTA 960
 TCAAGTACCT CCCTGAATGG ACTGCGTGGC TCATCTTGGC TGTGATTTCA GTATATGATT 1020
 TAGTGGCTGT TTTGTGTCCG AAAGGTCCAC TTCGTATGCT GGTTGAAACA GCTCAGGAGA 1080
 GAAATGAAAC GCTTTTTCCA GCTCTCATTT ACTCCTCAAC AATGGTGTGG TTGGTGAATA 1140
 TGGCAGAAGG AGACCCGGAA GCTCAAAGGA GAGTATCCAA AAATTCCAAG TATAATGCAG 1200
 AAAGCACAGA AAGGGAGTCA CAAGACACTG TTGCAGAGAA TGATGATGGC GGGTTCAGTG 1260

-continued

| | | | | | | |
|------------|-------------|-------------|-------------|------------|------------|------|
| AGGAATGGGA | AGCCCAGAGG | GACAGTCATC | TAGGGCCTCA | TCGCTCTACA | CCTGAGTCAC | 1320 |
| GAGCTGCTGT | CCAGGAACTT | TCCAGCAGTA | TCCTCGCTGG | TGAAGACCCA | GAGGAAAGGG | 1380 |
| GAGTAAAAC | TGGATTGGGA | GATTTCAATTT | TCTACAGTGT | TCTGGTTGGT | AAAGCCTCAG | 1440 |
| CAACAGCCAG | TGGAGACTGG | AACACAACCA | TAGCCTGTTT | CGTAGCCATA | TTAATTGGTT | 1500 |
| TGTGCCTTAC | ATTATTACTC | CTTGCCATTT | TCAAGAAAGC | ATTGCCAGCT | CTTCCAATCT | 1560 |
| CCATCACCTT | TGGGCTTGTT | TTCTACTTTG | CCACAGATTA | TCTTGACAG | CCTTTTATGG | 1620 |
| ACCAATTAGC | ATTCCATCAA | TTTTATATCT | AGCATATTTG | CGGTTAGAAT | CCCATGGATG | 1680 |
| TTTCTTCTTT | GACTATAACC | AAATCTGGGG | AGGACAAAGG | TGATTTTCCT | GTGTCCACAT | 1740 |
| CTAACAAAGT | CAAGATTCCC | GGCTGGACTT | TTGCAGCTTC | CTTCCAAGTC | TTCCTGACCA | 1800 |
| CCTTGCCTTA | TTGGACTTTG | GAAGGAGGTG | CCTATAGAAA | ACGATTTTGA | ACATACTTCA | 1860 |
| TCGCAGTGGA | CTGTGTCCCT | CGGTGCAGAA | ACTACCAGAT | TTGAGGGACG | AGGTCAAGGA | 1920 |
| GATATGATAG | GCCCCGGAAGT | TGCTGTGCCC | CATCAGCAGC | TTGACGCGTG | GTCACAGGAC | 1980 |
| GATTTCACTG | ACACTGCGAA | CTCTCAGGAC | TACCGGTTAC | CAAGAGGTTA | GGTGAAGTGG | 2040 |
| TTTAAACCAA | ACGGAACTCT | TCATCTTAAA | CTACACGTTG | AAAATCAACC | CAATAATTCT | 2100 |
| GTATTAAGT | AATTCTGAAC | TTTTCAGGAG | GTAAGTGTGAG | GAAGAGCAGG | CACCAGCAGC | 2160 |
| AGAATGGGGA | ATGGAGAGGT | GGGCAGGGGT | TCCAGCTTCC | CTTTGATTTT | TTGCTGCAGA | 2220 |
| CTCATCCTTT | TTAAATGAGA | CTTGTTTTCC | CCTCTCTTTG | AGTCAAGTCA | AATATGTAGA | 2280 |
| TTGCCTTTGG | CAATTCTTCT | TCTCAAGCAC | TGACACTCAT | TACCGTCTGT | GATTGCCATT | 2340 |
| TCTTCCCAAG | GCCAGTCTGA | ACCTGAGGTT | GCTTTATCCT | AAAAGTTTTA | ACCTCAGGTT | 2400 |
| CCAAATTCAG | TAAATTTTGG | AAACAGTACA | GCTATTTCTC | ATCAATTCTC | TATCATGTTG | 2460 |
| AAGTCAAATT | TGGATTTTCC | ACCAAATTCT | GAATTTGTAG | ACATACTTGT | ACGCTCACTT | 2520 |
| GCCCCCAGAT | GCCTCCTCTG | TCCTCATTCT | TCTCTCCCAC | ACAAGCAGTC | TTTTTCTACA | 2580 |
| GCCAGTAAGG | CAGCTCTGTC | TGGTAGCAGA | TGGTCCCAT | ATTCTAGGGT | CTTACTCTTT | 2640 |
| GTATGATGAA | AAGAATGTGT | TATGAATCGG | TGCTGTCAGC | CCTGCTGTCA | GACCTTCTTC | 2700 |
| CACAGCAAAT | GAGATGTATG | CCCAAAGCGG | TAGAATTAAA | GAAGAGTAAA | ATGGCTGTTG | 2760 |
| AAGCAAAAAA | AAAAAAAAAA | AAAAAAAAAA | A | | | 2791 |

(2) INFORMATION FOR SEQ ID NO:134:

- (i) SEQUENCE CHARACTERISTICS:
 (A) LENGTH: 467 amino acids
 (B) TYPE: amino acid
 (C) STRANDEDNESS: single
 (D) TOPOLOGY: linear

(i i) MOLECULE TYPE: protein

(x i) SEQUENCE DESCRIPTION: SEQ ID NO:134:

| | | | | | | | | | | | | | | | |
|-----|-----|-----|-----|-----|-----|-----|-----|-----|-----|-----|-----|-----|-----|-----|-----|
| Met | Thr | Glu | Leu | Pro | Ala | Pro | Leu | Ser | Tyr | Phe | Gln | Asn | Ala | Gln | Met |
| 1 | | | | 5 | | | | | 10 | | | | | 15 | |
| Ser | Glu | Asp | Asn | His | Leu | Ser | Asn | Thr | Val | Arg | Ser | Gln | Asn | Asp | Asn |
| | | | 20 | | | | | 25 | | | | | 30 | | |
| Arg | Glu | Arg | Gln | Glu | His | Asn | Asp | Arg | Arg | Ser | Leu | Gly | His | Pro | Glu |
| | | 35 | | | | | 40 | | | | | 45 | | | |
| Pro | Leu | Ser | Asn | Gly | Arg | Pro | Gln | Gly | Asn | Ser | Arg | Gln | Val | Val | Glu |
| | 50 | | | | | 55 | | | | 60 | | | | | |
| Gln | Asp | Glu | Glu | Glu | Asp | Glu | Glu | Leu | Thr | Leu | Lys | Tyr | Gly | Ala | Lys |
| 65 | | | | | 70 | | | | | 75 | | | | | 80 |

-continued

| | | | | | | | | | | | | | | | |
|-----|-----|-----|-----|-----|-----|-----|-----|-----|-----|-----|-----|-----|-----|-----|-----|
| His | Val | Ile | Met | Leu | Phe | Val | Pro | Val | Thr | Leu | Cys | Met | Val | Val | Val |
| | | | | 85 | | | | | 90 | | | | | 95 | |
| Val | Ala | Thr | Ile | Lys | Ser | Val | Ser | Phe | Tyr | Thr | Arg | Lys | Asp | Gly | Gln |
| | | | 100 | | | | | 105 | | | | | 110 | | |
| Leu | Ile | Tyr | Thr | Pro | Phe | Thr | Glu | Asp | Thr | Glu | Thr | Val | Gly | Gln | Arg |
| | | 115 | | | | | 120 | | | | | 125 | | | |
| Ala | Leu | His | Ser | Ile | Leu | Asn | Ala | Ala | Ile | Met | Ile | Ser | Val | Ile | Val |
| | 130 | | | | | 135 | | | | | 140 | | | | |
| Val | Met | Thr | Ile | Leu | Leu | Val | Val | Leu | Tyr | Lys | Tyr | Arg | Cys | Tyr | Lys |
| 145 | | | | 150 | | | | | | 155 | | | | | 160 |
| Val | Ile | His | Ala | Trp | Leu | Ile | Ile | Ser | Ser | Leu | Leu | Leu | Leu | Phe | Phe |
| | | | | 165 | | | | | 170 | | | | | 175 | |
| Phe | Ser | Phe | Ile | Tyr | Leu | Gly | Glu | Val | Phe | Lys | Thr | Tyr | Asn | Val | Ala |
| | | | 180 | | | | | 185 | | | | | 190 | | |
| Val | Asp | Tyr | Ile | Thr | Val | Ala | Leu | Leu | Ile | Trp | Asn | Phe | Gly | Val | Val |
| | | 195 | | | | | 200 | | | | | 205 | | | |
| Gly | Met | Ile | Ser | Ile | His | Trp | Lys | Gly | Pro | Leu | Arg | Leu | Gln | Gln | Ala |
| | 210 | | | | | 215 | | | | | 220 | | | | |
| Tyr | Leu | Ile | Met | Ile | Ser | Ala | Leu | Met | Ala | Leu | Val | Phe | Ile | Lys | Tyr |
| 225 | | | | 230 | | | | | | 235 | | | | | 240 |
| Leu | Pro | Glu | Trp | Thr | Ala | Trp | Leu | Ile | Leu | Ala | Val | Ile | Ser | Val | Tyr |
| | | | | 245 | | | | | 250 | | | | | 255 | |
| Asp | Leu | Val | Ala | Val | Leu | Cys | Pro | Lys | Gly | Pro | Leu | Arg | Met | Leu | Val |
| | | | 260 | | | | | 265 | | | | | 270 | | |
| Glu | Thr | Ala | Gln | Glu | Arg | Asn | Glu | Thr | Leu | Phe | Pro | Ala | Leu | Ile | Tyr |
| | | 275 | | | | | 280 | | | | | 285 | | | |
| Ser | Ser | Thr | Met | Val | Trp | Leu | Val | Asn | Met | Ala | Glu | Gly | Asp | Pro | Glu |
| | 290 | | | | | 295 | | | | | 300 | | | | |
| Ala | Gln | Arg | Arg | Val | Ser | Lys | Asn | Ser | Lys | Tyr | Asn | Ala | Glu | Ser | Thr |
| 305 | | | | | 310 | | | | | 315 | | | | | 320 |
| Glu | Arg | Glu | Ser | Gln | Asp | Thr | Val | Ala | Glu | Asn | Asp | Asp | Gly | Gly | Phe |
| | | | | 325 | | | | | 330 | | | | | 335 | |
| Ser | Glu | Glu | Trp | Glu | Ala | Gln | Arg | Asp | Ser | His | Leu | Gly | Pro | His | Arg |
| | | | 340 | | | | | 345 | | | | | 350 | | |
| Ser | Thr | Pro | Glu | Ser | Arg | Ala | Ala | Val | Gln | Glu | Leu | Ser | Ser | Ser | Ile |
| | | 355 | | | | | 360 | | | | | 365 | | | |
| Leu | Ala | Gly | Glu | Asp | Pro | Glu | Glu | Arg | Gly | Val | Lys | Leu | Gly | Leu | Gly |
| | 370 | | | | | 375 | | | | | 380 | | | | |
| Asp | Phe | Ile | Phe | Tyr | Ser | Val | Leu | Val | Gly | Lys | Ala | Ser | Ala | Thr | Ala |
| 385 | | | | | 390 | | | | | 395 | | | | | 400 |
| Ser | Gly | Asp | Trp | Asn | Thr | Thr | Ile | Ala | Cys | Phe | Val | Ala | Ile | Leu | Ile |
| | | | | 405 | | | | | 410 | | | | | 415 | |
| Gly | Leu | Cys | Leu | Thr | Leu | Leu | Leu | Leu | Ala | Ile | Phe | Lys | Lys | Ala | Leu |
| | | | 420 | | | | | 425 | | | | | 430 | | |
| Pro | Ala | Leu | Pro | Ile | Ser | Ile | Thr | Phe | Gly | Leu | Val | Phe | Tyr | Phe | Ala |
| | | 435 | | | | | 440 | | | | | 445 | | | |
| Thr | Asp | Tyr | Leu | Val | Gln | Pro | Phe | Met | Asp | Gln | Leu | Ala | Phe | His | Gln |
| | 450 | | | | | 455 | | | | | 460 | | | | |
| Phe | Tyr | Ile | | | | | | | | | | | | | |
| 465 | | | | | | | | | | | | | | | |

(2) INFORMATION FOR SEQ ID NO:135:

(i) SEQUENCE CHARACTERISTICS:

(A) LENGTH: 1962 base pairs

-continued

(B) TYPE: nucleic acid
 (C) STRANDEDNESS: single
 (D) TOPOLOGY: linear

(i i) MOLECULE TYPE: cDNA

(x i) SEQUENCE DESCRIPTION: SEQ ID NO:135:

```

ACCAACACGG CAGCTGAGGC GGAAACCTAG GCTGCGAGCC GGCCGCCCGG GCGCGGAGAG      60
AGAAGGAACC AACACAAGAC AGCAGCCCTT CGAGGTCTTT AGGCAGCTTG GAGGAGAACA      120
CATGAGAGAA AGAATCCCAA GAGGTTTTGT TTTCTTTGAG AAGGTATTTT TGTCCAGCTG      180
CTCCAATGAC AGAGATACCT GCACCTTTGT CCTACTTCCA GAATGCCAG ATGTCTGAGG      240
ACAGCCACTC CAGCAGCGCC ATCCGGAGCC AGAATGACAG CCAAGAACGG CAGCAGCAGC      300
ATGACAGGCA GAGACTTGAC AACCCCTGAGC CAATATCTAA TGGGCGGCC CAGAGTAACT      360
CAAGACAGGT GGTGGAACAA GATGAGGAGG AAGACGAAGA GCTGACATTG AAATATGGAG      420
CCAAGCATGT CATCATGCTC TTTGTCCCG TGACCCTCTG CATGGTCGTC GTCGTGGCCA      480
CCATCAAATC AGTCAGCTTC TATACCCGGA AGGACGGTCA GCTAATCTAC ACCCCATTCA      540
CAGAAGACAC TGAGACTGTA GGCCAAAGAG CCCTGCACTC GATCCTGAAT GCGGCCATCA      600
TGATCAGTGT CATTGTCATT ATGACCATCC TCCTGGTGGT CCTGTATAAA TACAGGTGCT      660
ACAAGGTCAT CCACGCCTGG CTTATTATTT CATCTCTGTT GTTGCTGTTC TTTTTTTCGT      720
TCATTTACTT AGGGGAAGTA TTTAAGACCT ACAATGTCGC CGTGGACTAC GTTACAGTAG      780
CACTCCTAAT CTGGAATTTT GGTGTGGTCG GGATGATTGC CATCCACTGG AAAGGCCCCC      840
TTCGACTGCA GCAGGCGTAT CTCATTATGA TCAGTGCCCT CATGGCCCTG GTATTTATCA      900
AGTACCTCCC CGAATGGACC GCATGGCTCA TCTTGGCTGT GATTTAGTA TATGATTTGG      960
TGGCTGTTTT ATGTCCCAA GGCCCACTTC GTATGCTGGT TGAAACAGCT CAGGAAAGAA     1020
ATGAGACTCT CTTTCCAGCT CTTATCTATT CCTCAACAAT GGTGTGGTTG GTGAATATGG     1080
CTGAAGGAGA CCCAGAAGCC CAAAGGAGGG TACCCAAGAA CCCCAAGTAT AACACACAAA     1140
GAGCGGAGAG AGAGACACAG GACAGTGGTT CTGGGAACGA TGATGGTGGC TTCAGTGAGG     1200
AGTGGGAGGC CCAAAGAGAC AGTCACCTGG GGCCTCATCG CTCCACTCCC GAGTCAAGAG     1260
CTGCTGTCCA GGAAC TTTCT GGGAGCATT TAACGAGTGA AGACCCGGAG GAAAGAGGAG     1320
TAAACTTTGG ACTGGGAGAT TTCATTTTCT ACAGTGTTCT GGTTGGTAAG GCCTCAGCAA     1380
CCGCCAGTGG AGACTGGAAC ACAACCATAG CCTGCTTTGT AGCCATACTG ATCGGCCTGT     1440
GCCTTACATT ACTCCTGCTC GCCATTTTCA AGAAAGCGTT GCCAGCCCTC CCCATCTCCA     1500
TCACCTTCGG GCTCGTGTT TACTTCGCCA CGGATTACCT TGTGCAGCCC TTCATGGACC     1560
AACTTGCATT CCATCAGTTT TATATCTAGC CTTTCTGCAG TTAGAACATG GATGTTTCTT     1620
CTTTGATTAT CAAAAACACA AAAACAGAGA GCAAGCCCGA GGAGGAGACT GGTGACTTTC     1680
CTGTGTCCTC AGCTAACAAA GGCAGGACTC CAGCTGGACT TCTGCAGCTT CCTTCCGAGT     1740
CTCCCTAGCC ACCCGCACTA CTGGACTGTG GAAGGAAGCG TCTACAGAGG AACGGTTTCC     1800
AACATCCATC GCTGCAGCAG ACGGTGTCCC TCAGTGACTT GAGAGACAAG GACAAGGAAA     1860
TGTGCTGGGC CAAGGAGCTG CCGTGCTCTG CTAGCTTTGA CCGTGGGCAT GGAGATTTAC     1920
CCGCACTGTG AACTCTCTAA GGTAAACAAA GTGAGGTGAA CC                               1962

```

(2) INFORMATION FOR SEQ ID NO:136:

(i) SEQUENCE CHARACTERISTICS:
 (A) LENGTH: 2285 base pairs
 (B) TYPE: nucleic acid

-continued

(C) STRANDEDNESS: single
 (D) TOPOLOGY: linear

(i i) MOLECULE TYPE: cDNA

(x i) SEQUENCE DESCRIPTION: SEQ ID NO:136:

| | | | | | | |
|------------|-------------|------------|------------|-------------|-------------|------|
| GAATTCGGCA | CGAGGGCATT | TCCAGCAGTG | AGGAGACAGC | CAGAAGCAAG | CTTTTGGAGC | 60 |
| TGAAGGAACC | TGAGACAGAA | GCTAGTCCCC | CCTCTGAATT | TACTGATGA | AGAAACTGAG | 120 |
| GCCACAGAGC | TAAAGTGACT | TTTCCCAAGG | TCGCCCAGCG | AGGACGTGGG | ACTTCTCAGA | 180 |
| CGTCAGGAGA | GTGATGTGAG | GGAGCTGTGT | GACCATAGAA | AGTGACGTGT | TAAAAACCAG | 240 |
| CGCTGCCCTC | TTTGAAAGCC | AGGGAGCATC | ATTCATTTAG | CCTGCTGAGA | AGAAGAAACC | 300 |
| AAGTGTCCGG | GATTCAAGAC | CTCTCTGCGG | CCCCAAGTGT | TCGTGGTGCT | TCCAGAGGCA | 360 |
| GGGCTATGCT | CACATTCATG | GCCTCTGACA | GCGAGGAAGA | AGTGTGTGAT | GAGCGGACGT | 420 |
| CCCTAATGTC | GGCCGAGAGC | CCCACGCCGC | GCTCCTGCCA | GGAGGGCAGG | CAGGGCCCAG | 480 |
| AGGATGGAGA | GAATACTGCC | CAGTGGAGAA | GCCAGGAGAA | CGAGGAGGAC | GGTGAGGAGG | 540 |
| ACCCTGACCG | CTATGTCTGT | AGTGGGGTTC | CCGGGCGGCC | GCCAGGCCTG | GAGGAAGAGC | 600 |
| TGACCCTCAA | ATACGGAGCG | AAGCATGTGA | TCATGCTGTT | TGTGCCTGTC | ACTCTGTGCA | 660 |
| TGATCGTGGT | GGTAGCCACC | ATCAAGTCTG | TGCGCTTCTA | CACAGAGAAG | AATGGACAGC | 720 |
| TCATCTACAC | GCCATTCACT | GAGGACACAC | CCTCGGTGGG | CCAGCGCCTC | CTCAACTCCG | 780 |
| TGCTGAACAC | CCTCATCATG | ATCAGCGTCA | TCGTGGTTAT | GACCATCTTC | TTGGTGGTGC | 840 |
| TCTACAAGTA | CCGCTGCTAC | AAGTTCATCC | ATGGCTGGTT | GATCATGTCT | TCACTGATGC | 900 |
| TGCTGTTCTT | CTTCACCTAT | ATCTACCTTG | GGGAAGTGCT | CAAGACCTAC | AATGTGGCCA | 960 |
| TGGACTACCC | CACCCTCTTG | CTGACTGTCT | GGAACTTCGG | GGCAGTGGGC | ATGGTGTGCA | 1020 |
| TCCACTGGAA | GGGCCCTCTG | GTGCTGCAGC | AGGCCTACCT | CATCATGATC | AGTGCGCTCA | 1080 |
| TGGCCCTAGT | GTTTCATCAAG | TACCTCCCAG | AGTGGTCCGC | GTGGGTTCATC | CTGGGCGCCA | 1140 |
| TCTCTGTGTA | TGATCTCGTG | GCTGTGCTGT | GTCCCAAAGG | GCCTCTGAGA | ATGCTGGTAG | 1200 |
| AAACTGCCCA | GGAGAGAAAT | GAGCCCATAT | TCCCTGCCCT | GATATACTCA | TCTGCCATGG | 1260 |
| TGTGGACGGT | TGGCATGGCG | AAGCTGGACC | CCTCCTCTCA | GGGTGCCCTC | CAGCTCCCCT | 1320 |
| ACGACCCGGA | GATGGAAGAA | GACTCCTATG | ACAGTTTTGG | GGAGCCTTCA | TACCCCGAAG | 1380 |
| TCTTTGAGCC | TCCCTTGACT | GGCTACCCAG | GGGAGGAGCT | GGAGGAAGAG | GAGGAAAGGG | 1440 |
| GCGTGAAGCT | TGGCCTCGGG | GACTTCATCT | TCTACAGTGT | GCTGGTGGGC | AAGGCGGCTG | 1500 |
| CCACGGGCAG | CGGGGACTGG | AATACCACGC | TGGCCTGCTT | CGTGGCCATC | CTCATTGGCT | 1560 |
| TGTGTCTGAC | CCTCCTGCTG | CTTGCTGTGT | TCAAGAAGGC | GCTGCCCGCC | CTCCCCATCT | 1620 |
| CCATCACGTT | CGGGCTCATC | TTTTACTTCT | CCACGGACAA | CCTGGTGC GG | CCGTTTCATGG | 1680 |
| ACACCCTGGC | CTCCCATCAG | CTCTACATCT | GAGGGACATG | GTGTGCCACA | GGCTGCAAGC | 1740 |
| TGCAGGGAAT | TTTCATTGGA | TGCAGTTGTA | TAGTTTTACA | CTCTAGTGCC | ATATATTTTT | 1800 |
| AAGACTTTTT | TTTCCTTAAA | AAATAAAGTA | CGTGTTTACT | TGGTGAGGAG | GAGGCAGAAC | 1860 |
| CAGCTCTTTG | GTGCCAGCTG | TTTCATCACC | AGACTTTGGC | TCCCGCTTTG | GGGAGCGCCT | 1920 |
| CGCTTCACGG | ACAGGAAGCA | CAGCAGGTTT | ATCCAGATGA | ACTGAGAAGG | TCAGATTAGG | 1980 |
| GTGGGGAGAA | GAGCATCCGG | CATGAGGGCT | GAGATGCCCA | AAGAGTGTGC | TCGGGAGTGG | 2040 |
| CCCCTGGCAC | CTGGGTGCTC | TGGCTGGAGA | GGAAAAGCCA | GTTCCCTACG | AGGAGTGTTT | 2100 |
| CCAATGCTTT | GTCCATGATG | TCCTTGTTAT | TTTATTNCCY | TTANAACTG | ANTCCTNTTN | 2160 |
| TTNTTDCGGC | AGTCACMCTN | CTGGGRAGTG | GCTTAATAGT | AANATCAATA | AANAGNTGAG | 2220 |

-continued

TCCTNTTAGA AAAAAAAAAA AAAAAAAAAA AAAAAAAAAA AAAAAAAAAA AAAAAAAAAA 2280
 AAAAA 2285

(2) INFORMATION FOR SEQ ID NO:137:

- (i) SEQUENCE CHARACTERISTICS:
 (A) LENGTH: 448 amino acids
 (B) TYPE: amino acid
 (C) STRANDEDNESS: single
 (D) TOPOLOGY: linear

(i i) MOLECULE TYPE: protein

(x i) SEQUENCE DESCRIPTION: SEQ ID NO:137:

| | | | | | | | | | | | | | | | |
|-----|-----|-----|-----|-----|-----|-----|-----|-----|-----|-----|-----|-----|-----|-----|-----|
| Met | Leu | Thr | Phe | Met | Ala | Ser | Asp | Ser | Glu | Glu | Glu | Val | Cys | Asp | Glu |
| 1 | | | | 5 | | | | | 10 | | | | | 15 | |
| Arg | Thr | Ser | Leu | Met | Ser | Ala | Glu | Ser | Pro | Thr | Pro | Arg | Ser | Cys | Gln |
| | | | 20 | | | | | 25 | | | | | 30 | | |
| Glu | Gly | Arg | Gln | Gly | Pro | Glu | Asp | Gly | Glu | Asn | Thr | Ala | Gln | Trp | Arg |
| | | 35 | | | | | 40 | | | | | 45 | | | |
| Ser | Gln | Glu | Asn | Glu | Glu | Asp | Gly | Glu | Glu | Asp | Pro | Asp | Arg | Tyr | Val |
| | 50 | | | | | 55 | | | | | 60 | | | | |
| Cys | Ser | Gly | Val | Pro | Gly | Arg | Pro | Pro | Gly | Leu | Glu | Glu | Glu | Leu | Thr |
| 65 | | | | | 70 | | | | | 75 | | | | | 80 |
| Leu | Lys | Tyr | Gly | Ala | Lys | His | Val | Ile | Met | Leu | Phe | Val | Pro | Val | Thr |
| | | | | 85 | | | | | 90 | | | | | 95 | |
| Leu | Cys | Met | Ile | Val | Val | Val | Ala | Thr | Ile | Lys | Ser | Val | Arg | Phe | Tyr |
| | | | 100 | | | | | 105 | | | | | 110 | | |
| Thr | Glu | Lys | Asn | Gly | Gln | Leu | Ile | Tyr | Thr | Pro | Phe | Thr | Glu | Asp | Thr |
| | | 115 | | | | | 120 | | | | | 125 | | | |
| Pro | Ser | Val | Gly | Gln | Arg | Leu | Leu | Asn | Ser | Val | Leu | Asn | Thr | Leu | Ile |
| | 130 | | | | | 135 | | | | | 140 | | | | |
| Met | Ile | Ser | Val | Ile | Val | Val | Met | Thr | Ile | Phe | Leu | Val | Val | Leu | Tyr |
| 145 | | | | | 150 | | | | | 155 | | | | | 160 |
| Lys | Tyr | Arg | Cys | Tyr | Lys | Phe | Ile | His | Gly | Trp | Leu | Ile | Met | Ser | Ser |
| | | | | 165 | | | | | 170 | | | | | 175 | |
| Leu | Met | Leu | Leu | Phe | Leu | Phe | Thr | Tyr | Ile | Tyr | Leu | Gly | Glu | Val | Leu |
| | | | 180 | | | | | 185 | | | | | 190 | | |
| Lys | Thr | Tyr | Asn | Val | Ala | Met | Asp | Tyr | Pro | Thr | Leu | Leu | Leu | Thr | Val |
| | | 195 | | | | | 200 | | | | | 205 | | | |
| Trp | Asn | Phe | Gly | Ala | Val | Gly | Met | Val | Cys | Ile | His | Trp | Lys | Gly | Pro |
| | 210 | | | | | 215 | | | | | 220 | | | | |
| Leu | Val | Leu | Gln | Gln | Ala | Tyr | Leu | Ile | Met | Ile | Ser | Ala | Leu | Met | Ala |
| 225 | | | | | 230 | | | | | 235 | | | | | 240 |
| Leu | Val | Phe | Ile | Lys | Tyr | Leu | Pro | Glu | Trp | Ser | Ala | Trp | Val | Ile | Leu |
| | | | | 245 | | | | | 250 | | | | | 255 | |
| Gly | Ala | Ile | Ser | Val | Tyr | Asp | Leu | Val | Ala | Val | Leu | Cys | Pro | Lys | Gly |
| | | | 260 | | | | | 265 | | | | | 270 | | |
| Pro | Leu | Arg | Met | Leu | Val | Glu | Thr | Ala | Gln | Glu | Arg | Asn | Glu | Pro | Ile |
| | | 275 | | | | | 280 | | | | | 285 | | | |
| Phe | Pro | Ala | Leu | Ile | Tyr | Ser | Ser | Ala | Met | Val | Trp | Thr | Val | Gly | Met |
| | 290 | | | | | 295 | | | | | 300 | | | | |
| Ala | Lys | Leu | Asp | Pro | Ser | Ser | Gln | Gly | Ala | Leu | Gln | Leu | Pro | Tyr | Asp |
| 305 | | | | | 310 | | | | | 315 | | | | | 320 |
| Pro | Glu | Met | Glu | Glu | Asp | Ser | Tyr | Asp | Ser | Phe | Gly | Glu | Pro | Ser | Tyr |
| | | | | 325 | | | | | 330 | | | | | 335 | |

-continued

| | | | | | | | | | | | | | | | |
|-----|-----|-----|-----|-----|-----|-----|-----|-----|-----|-----|-----|-----|-----|-----|-----|
| Pro | Glu | Val | Phe | Glu | Pro | Pro | Leu | Thr | Gly | Tyr | Pro | Gly | Glu | Glu | Leu |
| | | | 340 | | | | | 345 | | | | | 350 | | |
| Glu | Glu | Glu | Glu | Glu | Arg | Gly | Val | Lys | Leu | Gly | Leu | Gly | Asp | Phe | Ile |
| | | 355 | | | | | 360 | | | | | 365 | | | |
| Phe | Tyr | Ser | Val | Leu | Val | Gly | Lys | Ala | Ala | Ala | Thr | Gly | Ser | Gly | Asp |
| | 370 | | | | | 375 | | | | | 380 | | | | |
| Trp | Asn | Thr | Thr | Leu | Ala | Cys | Phe | Val | Ala | Ile | Leu | Ile | Gly | Leu | Cys |
| 385 | | | | | 390 | | | | | 395 | | | | | 400 |
| Leu | Thr | Leu | Leu | Leu | Leu | Ala | Val | Phe | Lys | Lys | Ala | Leu | Pro | Ala | Leu |
| | | | | 405 | | | | | 410 | | | | | 415 | |
| Pro | Ile | Ser | Ile | Thr | Phe | Gly | Leu | Ile | Phe | Tyr | Phe | Ser | Thr | Asp | Asn |
| | | | 420 | | | | | 425 | | | | | 430 | | |
| Leu | Val | Arg | Pro | Phe | Met | Asp | Thr | Leu | Ala | Ser | His | Gln | Leu | Tyr | Ile |
| | | 435 | | | | | 440 | | | | | 445 | | | |

(2) INFORMATION FOR SEQ ID NO:138:

- (i) SEQUENCE CHARACTERISTICS:
 (A) LENGTH: 372 amino acids
 (B) TYPE: amino acid
 (C) STRANDEDNESS: single
 (D) TOPOLOGY: linear

(i i) MOLECULE TYPE: protein

(x i) SEQUENCE DESCRIPTION: SEQ ID NO:138:

| | | | | | | | | | | | | | | | |
|-----|-----|-----|-----|-----|-----|-----|-----|-----|-----|-----|-----|-----|-----|-----|-----|
| Glu | Glu | Leu | Thr | Leu | Lys | Tyr | Gly | Ala | Lys | His | Val | Ile | Met | Leu | Phe |
| 1 | | | | 5 | | | | | 10 | | | | | 15 | |
| Val | Pro | Val | Thr | Leu | Cys | Met | Ile | Val | Val | Val | Ala | Thr | Ile | Lys | Ser |
| | | | 20 | | | | | 25 | | | | | 30 | | |
| Val | Arg | Phe | Tyr | Thr | Glu | Lys | Asn | Gly | Gln | Leu | Ile | Tyr | Thr | Pro | Phe |
| | | 35 | | | | | 40 | | | | | 45 | | | |
| Thr | Glu | Asp | Thr | Pro | Ser | Val | Gly | Gln | Arg | Leu | Leu | Asn | Ser | Val | Leu |
| | 50 | | | | | 55 | | | | | 60 | | | | |
| Asn | Thr | Leu | Ile | Met | Ile | Ser | Val | Ile | Val | Val | Met | Thr | Ile | Phe | Leu |
| 65 | | | | | 70 | | | | | 75 | | | | | 80 |
| Val | Val | Leu | Tyr | Lys | Tyr | Arg | Cys | Tyr | Lys | Phe | Ile | His | Gly | Trp | Leu |
| | | | | 85 | | | | | 90 | | | | | 95 | |
| Ile | Met | Ser | Ser | Leu | Met | Leu | Leu | Phe | Leu | Phe | Thr | Tyr | Ile | Tyr | Leu |
| | | | 100 | | | | | 105 | | | | | 110 | | |
| Gly | Glu | Val | Leu | Lys | Thr | Tyr | Asn | Val | Ala | Met | Asp | Tyr | Pro | Thr | Leu |
| | | 115 | | | | | 120 | | | | | 125 | | | |
| Leu | Leu | Thr | Val | Trp | Asn | Phe | Gly | Ala | Val | Gly | Met | Val | Cys | Ile | His |
| | 130 | | | | | 135 | | | | | 140 | | | | |
| Trp | Lys | Gly | Pro | Leu | Val | Leu | Gln | Gln | Ala | Tyr | Leu | Ile | Met | Ile | Ser |
| 145 | | | | | 150 | | | | | 155 | | | | | 160 |
| Ala | Leu | Met | Ala | Leu | Val | Phe | Ile | Lys | Tyr | Leu | Pro | Glu | Trp | Ser | Ala |
| | | | | 165 | | | | | 170 | | | | | 175 | |
| Trp | Val | Ile | Leu | Gly | Ala | Ile | Ser | Val | Tyr | Asp | Leu | Val | Ala | Val | Leu |
| | | | 180 | | | | | 185 | | | | | 190 | | |
| Cys | Pro | Lys | Gly | Pro | Leu | Arg | Met | Leu | Val | Glu | Thr | Ala | Gln | Glu | Arg |
| | | 195 | | | | | 200 | | | | | 205 | | | |
| Asn | Glu | Pro | Ile | Phe | Pro | Ala | Leu | Ile | Tyr | Ser | Ser | Ala | Met | Val | Trp |
| | 210 | | | | | 215 | | | | | 220 | | | | |
| Thr | Val | Gly | Met | Ala | Lys | Leu | Asp | Pro | Ser | Ser | Gln | Gly | Ala | Leu | Gln |
| 225 | | | | | 230 | | | | | | 235 | | | | 240 |

-continued

| | | | | | | | | | | | | | | | |
|-----|-----|-----|-----|-----|-----|-----|-----|-----|-----|-----|-----|-----|-----|-----|-----|
| Leu | Pro | Tyr | Asp | Pro | Glu | Met | Glu | Glu | Asp | Ser | Tyr | Asp | Ser | Phe | Gly |
| | | | | 245 | | | | | 250 | | | | | 255 | |
| Glu | Pro | Ser | Tyr | Pro | Glu | Val | Phe | Glu | Pro | Pro | Leu | Thr | Gly | Tyr | Pro |
| | | | 260 | | | | | 265 | | | | | 270 | | |
| Gly | Glu | Glu | Leu | Glu | Glu | Glu | Glu | Glu | Arg | Gly | Val | Lys | Leu | Gly | Leu |
| | | 275 | | | | | 280 | | | | | 285 | | | |
| Gly | Asp | Phe | Ile | Phe | Tyr | Ser | Val | Leu | Val | Gly | Lys | Ala | Ala | Ala | Thr |
| | 290 | | | | | 295 | | | | | 300 | | | | |
| Gly | Ser | Gly | Asp | Trp | Asn | Thr | Thr | Leu | Ala | Cys | Phe | Val | Ala | Ile | Leu |
| 305 | | | | | 310 | | | | | 315 | | | | | 320 |
| Ile | Gly | Leu | Cys | Leu | Thr | Leu | Leu | Leu | Leu | Ala | Val | Phe | Lys | Lys | Ala |
| | | | | 325 | | | | | 330 | | | | | 335 | |
| Leu | Pro | Ala | Leu | Pro | Ile | Ser | Ile | Thr | Phe | Gly | Leu | Ile | Phe | Tyr | Phe |
| | | | 340 | | | | | 345 | | | | | 350 | | |
| Ser | Thr | Asp | Asn | Leu | Val | Arg | Pro | Phe | Met | Asp | Thr | Leu | Ala | Ser | His |
| | | 355 | | | | | 360 | | | | | 365 | | | |
| Gln | Leu | Tyr | Ile | | | | | | | | | | | | |
| | 370 | | | | | | | | | | | | | | |

(2) INFORMATION FOR SEQ ID NO:139:

(i) SEQUENCE CHARACTERISTICS:

- (A) LENGTH: 31 base pairs
- (B) TYPE: nucleic acid
- (C) STRANDEDNESS: single
- (D) TOPOLOGY: linear

(i i) MOLECULE TYPE: other nucleic acid

- (A) DESCRIPTION: /desc = "primer"

(x i) SEQUENCE DESCRIPTION: SEQ ID NO:139:

GGTACCGCCA CCATGACAGA GGTACCTGCA C

31

(2) INFORMATION FOR SEQ ID NO:140:

(i) SEQUENCE CHARACTERISTICS:

- (A) LENGTH: 25 base pairs
- (B) TYPE: nucleic acid
- (C) STRANDEDNESS: single
- (D) TOPOLOGY: linear

(i i) MOLECULE TYPE: other nucleic acid

- (A) DESCRIPTION: /desc = "primer"

(x i) SEQUENCE DESCRIPTION: SEQ ID NO:140:

GAATTC ACTG GCTGTAGAAA AAGAC

25

(2) INFORMATION FOR SEQ ID NO:141:

(i) SEQUENCE CHARACTERISTICS:

- (A) LENGTH: 24 base pairs
- (B) TYPE: nucleic acid
- (C) STRANDEDNESS: single
- (D) TOPOLOGY: linear

(i i) MOLECULE TYPE: other nucleic acid

- (A) DESCRIPTION: /desc = "primer"

(x i) SEQUENCE DESCRIPTION: SEQ ID NO:141:

GGATCCGGTC CACTTCGTAT GCTG

24

(2) INFORMATION FOR SEQ ID NO:142:

(i) SEQUENCE CHARACTERISTICS:

- (A) LENGTH: 33 base pairs

-continued

(B) TYPE: nucleic acid
(C) STRANDEDNESS: single
(D) TOPOLOGY: linear

(i i) MOLECULE TYPE: other nucleic acid
(A) DESCRIPTION: /desc = "primer"

(x i) SEQUENCE DESCRIPTION: SEQ ID NO:142:

TTTTTTGAAT TCTTAGGCTA TGGTTGTGTT CCA 3 3

(2) INFORMATION FOR SEQ ID NO:143:

(i) SEQUENCE CHARACTERISTICS:
(A) LENGTH: 19 base pairs
(B) TYPE: nucleic acid
(C) STRANDEDNESS: single
(D) TOPOLOGY: linear

(i i) MOLECULE TYPE: other nucleic acid
(A) DESCRIPTION: /desc = "primer"

(x i) SEQUENCE DESCRIPTION: SEQ ID NO:143:

GATTAGTGGT TGT TTTGTG 1 9

(2) INFORMATION FOR SEQ ID NO:144:

(i) SEQUENCE CHARACTERISTICS:
(A) LENGTH: 19 base pairs
(B) TYPE: nucleic acid
(C) STRANDEDNESS: single
(D) TOPOLOGY: linear

(i i) MOLECULE TYPE: other nucleic acid
(A) DESCRIPTION: /desc = "primer"

(x i) SEQUENCE DESCRIPTION: SEQ ID NO:144:

GATTAGTGGC TGT TTTGTG 1 9

(2) INFORMATION FOR SEQ ID NO:145:

(i) SEQUENCE CHARACTERISTICS:
(A) LENGTH: 19 base pairs
(B) TYPE: nucleic acid
(C) STRANDEDNESS: single
(D) TOPOLOGY: linear

(i i) MOLECULE TYPE: other nucleic acid
(A) DESCRIPTION: /desc = "primer"

(x i) SEQUENCE DESCRIPTION: SEQ ID NO:145:

TTTTTCCAGC TCTCATTTA 1 9

(2) INFORMATION FOR SEQ ID NO:146:

(i) SEQUENCE CHARACTERISTICS:
(A) LENGTH: 19 base pairs
(B) TYPE: nucleic acid
(C) STRANDEDNESS: single
(D) TOPOLOGY: linear

(i i) MOLECULE TYPE: other nucleic acid
(A) DESCRIPTION: /desc = "primer"

(x i) SEQUENCE DESCRIPTION: SEQ ID NO:146:

TTTTTCCAGT TCTCATTTA 1 9

(2) INFORMATION FOR SEQ ID NO:147:

(i) SEQUENCE CHARACTERISTICS:
(A) LENGTH: 19 base pairs

-continued

(B) TYPE: nucleic acid
 (C) STRANDEDNESS: single
 (D) TOPOLOGY: linear

(i i) MOLECULE TYPE: other nucleic acid
 (A) DESCRIPTION: /desc = "primer"

(x i) SEQUENCE DESCRIPTION: SEQ ID NO:147:

T A C A G T G T T C T G G T T G G T A

1 9

(2) INFORMATION FOR SEQ ID NO:148:

(i) SEQUENCE CHARACTERISTICS:
 (A) LENGTH: 19 base pairs
 (B) TYPE: nucleic acid
 (C) STRANDEDNESS: single
 (D) TOPOLOGY: linear

(i i) MOLECULE TYPE: other nucleic acid
 (A) DESCRIPTION: /desc = "primer"

(x i) SEQUENCE DESCRIPTION: SEQ ID NO:148:

T A C A G T G T T C T G G T T G G T A

1 9

(2) INFORMATION FOR SEQ ID NO:149:

(i) SEQUENCE CHARACTERISTICS:
 (A) LENGTH: 19 base pairs
 (B) TYPE: nucleic acid
 (C) STRANDEDNESS: single
 (D) TOPOLOGY: linear

(i i) MOLECULE TYPE: other nucleic acid
 (A) DESCRIPTION: /desc = "primer"

(x i) SEQUENCE DESCRIPTION: SEQ ID NO:149:

T A C A G T G T T G T G G T T G G T A

1 9

(2) INFORMATION FOR SEQ ID NO:150:

(i) SEQUENCE CHARACTERISTICS:
 (A) LENGTH: 1092 base pairs
 (B) TYPE: nucleic acid
 (C) STRANDEDNESS: single
 (D) TOPOLOGY: linear

(i i) MOLECULE TYPE: cDNA

(x i) SEQUENCE DESCRIPTION: SEQ ID NO:150:

| | | | | | | |
|---------------------|---------------------|---------------------|---------------------|-----------------------|---------------------|-------|
| G T C T A G A T A A | G N C A A C A T T C | A G G G G T A G A A | G G G G A C T G T T | T A T T T T T T T C C | T T T A G T C T C T | 6 0 |
| C T T A A G A G T | G A G A A A A A T T | T T C C C A G G A A | T C C C G G T G G A | C T T T G C T T C A | C C A C T C A T A G | 1 2 0 |
| G T T C A T A C C A | A G T T A C A A C C | C C A C A A C C T T | A G A G C T T T T G | T T A G G A A G A G | G C T T G G T G G G | 1 8 0 |
| A T T A C C G T G C | T T G G C T T G G C | T T G G T C A G G A | T T C A C C A C C A | G A G T C A T G T G | G G A G G G G G T G | 2 4 0 |
| G G A A C C C A A A | C A A T T C A G G A | T T C T G C C C T C | A G G A A A T A A A | G G A G A A A A T A | G C T G T T G G A T | 3 0 0 |
| A A A C T A C C A G | C A G G C A C T G C | T A C A G C C C A T | G C T T T G T G G T | T T A A G G G C C A | G C T A G T T A C A | 3 6 0 |
| A T G A C A G C T A | G T T A C T G T T T | C C A T G T A A T T | T T C T T A A A G G | T A T T A A A T T T | T T C T A A A T A T | 4 2 0 |
| T A G A G C T G T A | A C T T C C A C T T | T C T C T T G A A G | G C A C A G W A A G | G G A G T C A C A A | G A C A C T G T T G | 4 8 0 |
| C A G A G A A T G A | T G A T G G C G G G | T T C A G T G A G G | A A T G G G A A S C | C C A G R G G G A C | A N T C A T C T A G | 5 4 0 |
| G G C C T C A T C G | C T C T A C A C C T | G A G T C A C G A G | C T K C T N T C C A | G G R A C T T T C C | A N C A G T A T C C | 6 0 0 |
| T C G C T G G T G A | A G A C C C A G A G | G A A A G N A T G T | T C A N T T C T C C | A T N T T T C A A A | G T C A T G G A T T | 6 6 0 |
| C C T T T A G G T A | G C T A C A T T A T | C A A C C T T T T T | G A G A A T A A A A | T G A A T T G A G A | G T G T T A C A G T | 7 2 0 |

-continued

| | | | | | | |
|------------|------------|------------|------------|------------|------------|------|
| CTAATTCTAT | ATCACATGTA | ACTTTTATTT | GGATATATCA | GTAATAGTGC | TTTTTYNTTT | 780 |
| TTTTTTTTTT | TTTTTTTTTT | TTTTNGGNGA | NAGAGTCTCG | CTCTGTCGCC | AGGTTGGAGT | 840 |
| GCAATGGTGC | GATCTTGGCT | CACTGAAAGC | TCCACCNCCC | GGGTTCAAGT | GATTCTCCTG | 900 |
| CCTCAGCCNC | CCAAGTAGNT | GGGACTACAG | GGGTGCGCCA | CCACGCCTGG | GATAATTTTG | 960 |
| GGNTTTTTAG | TAGAGATGGC | GTTTCACCAN | CTTGGNGCAG | GCTGGTCTTG | GAACTCCTGA | 1020 |
| NATCATGATC | TGCCTGCCTT | AGCCTCCCCA | AAGTGCTGGG | ATTNCAGGGG | TGAGCCACTG | 1080 |
| TTCTGGGCC | TC | | | | | 1092 |

(2) INFORMATION FOR SEQ ID NO:151:

- (i) SEQUENCE CHARACTERISTICS:
 (A) LENGTH: 1003 base pairs
 (B) TYPE: nucleic acid
 (C) STRANDEDNESS: single
 (D) TOPOLOGY: linear

(i i) MOLECULE TYPE: cDNA

(x i) SEQUENCE DESCRIPTION: SEQ ID NO:151:

| | | | | | | |
|------------|------------|-------------|------------|------------|-------------|------|
| CTGCAGTGAG | CCGAGATCAT | GCTGCTGTAC | TCCAGCCTGG | GCCACAGAGC | CAAACCTCCAT | 60 |
| CTCCCAAAAA | AAAAAAATAT | TAATTAATAT | GATNAAATGA | TGCCTATCTC | AGAATTCTTG | 120 |
| TAAGGATTTT | TTAGKACAAG | TGCTGGGTAT | AAACTATANA | TTCRATAGAT | GNCGATTATT | 180 |
| ACTTAYTATT | GTTATTGATA | AATAACAGCA | GCATCTACAG | TTAAGACTCC | AGAGTCAGTC | 240 |
| ACATAGAATC | TGGNACTCCT | ATTGTAGNAA | ACCCCNMMAG | AAAGAAAACA | CAGCTGAAGC | 300 |
| CTAATTTTGT | ATATCATTTA | CTGACTTCTC | TCATTCATTG | TGGGGTTGAG | TAGGGCAGTG | 360 |
| ATATTTTTGA | ATTGTGAAAT | CATANCAAAG | AGTGACCAAC | TTTTTAATAT | TTGTAACCTT | 420 |
| TCCTTTTTAG | GGGGAGTAAA | ACTTGGATTG | GGAGATTTCA | TTTTCTACAG | TGTTCTGGTT | 480 |
| GGTAAAGCCT | CAGCAACAGC | CAGTGGAGAC | TGGAACACAA | CCATAGCCTG | TTTCGTAGCC | 540 |
| ATATTAATTG | TMMSTATACA | CTAATAAGAA | TGTGTCAGAG | CTCTTAATGT | CMAAACTTTG | 600 |
| ATTACACAGT | CCCTTTAAGG | CAGTTCTGTT | TTAACCCAG | GTGGGTAAA | TATTCCAGCT | 660 |
| ATCTGAGGAG | CTTTTNGATA | ATTGGACCTC | ACCTTAGTAG | TTCTCTACCC | TGGCCACACA | 720 |
| TTAGAATCAC | TTGGGAGCTT | TTAAAACCTGT | AAGCTCTGCC | CTGAGATATT | CTTACTCAAT | 780 |
| TTAATTGTGT | AGTTTTTAAA | ATTCCCCAGG | AAATTCTGGT | ATTTCTGTTT | AGGAACCGCT | 840 |
| GCCTCAAGCC | TAGCAGCACA | GATATGTAGG | AAATTAGCTC | TGTAAGGTTG | GTCTTACAGG | 900 |
| GATAAACAGA | TCCTTCCTTA | GTCCCTGGAC | TTAATCACTG | AGAGTTTGGG | TGGTGGTTTT | 960 |
| GGATTTAATG | ACACAACCTG | TAGCATGCAG | TGTTACTTAA | GAC | | 1003 |

(2) INFORMATION FOR SEQ ID NO:152:

- (i) SEQUENCE CHARACTERISTICS:
 (A) LENGTH: 1726 base pairs
 (B) TYPE: nucleic acid
 (C) STRANDEDNESS: single
 (D) TOPOLOGY: linear

(i i) MOLECULE TYPE: cDNA

(x i) SEQUENCE DESCRIPTION: SEQ ID NO:152:

| | | | | | | |
|------------|------------|------------|------------|------------|------------|-----|
| GGATCCCTCC | CCTTTTTAGA | CCATACAAGG | TAACCTCCGG | ACGTTGCCAT | GGCATCTGTA | 60 |
| AACTGTCATG | GTGTTGGCGG | GGAGTGTCTT | TTAGCATGCT | AATGTATTAT | AATTAGCGTA | 120 |
| TAGTGAGCAG | TGAGGATAAC | CAGAGGTCAC | TCTCCTCACC | ATCTTGGTTT | TGGTGGGTTT | 180 |

-continued

| | | | | | | |
|------------|------------|------------|-------------|------------|------------|------|
| TGGCCAGCTT | CTTTATTGCA | ACCAGTTTTA | TCAGCAAGAT | CTTTATGAGC | TGTATCTTGT | 240 |
| GCTGACTTCC | TATCTCATCC | CGNAACTAAG | AGTACCTAAC | CTCCTGCAAA | TTGMAGNCCA | 300 |
| GNAGGTCTTG | GNCTTATTTN | ACCCAGCCCC | TATTCAARAT | AGAGTNGYTC | TTGGNCCAAA | 360 |
| CGCCYCTGAC | ACAAGGATTT | TAAAGTCTTA | TTAATTAAGG | TAAGATAGKT | CCTTGSATAT | 420 |
| GTGGTCTGAA | ATCACAGAAA | GCTGAATTTG | GAAAAAGGTG | CTTGGASCTG | CAGCCAGTAA | 480 |
| ACAAGTTTTC | ATGCAGGTGT | CAGTATTTAA | GGTACATCTC | AAAGGATAAG | TACAATTGTG | 540 |
| TATGTTGGGA | TGAACAGAGA | GAATGGAGCA | ANCCAAGACC | CAGGTAAAAG | AGAGGACCTG | 600 |
| AATGCCTTCA | GTGAACAATG | ATAGATAATC | TAGACTTTTTA | AACTGCATAC | TTCCTGTACA | 660 |
| TTGTTTTTTC | TTGCTTCAGG | TTTTTAGAAC | TCATAGTGAC | GGGTCTGTTG | TTAATCCCAG | 720 |
| GTCTAACCGT | TACCTTGATT | CTGCTGAGAA | TCTGATTTAC | TGAAAATGTT | TTTCTTGTGC | 780 |
| TTATAGAATG | ACAATAGAGA | ACGGCAGGAG | CACAACGACA | GACGGAGCCT | TGGCCACCCT | 840 |
| GANCCATTAT | CTAATGGACG | ACCCAGGGTA | ACTCCCGGCA | GGTGGTGGAN | CAAGATGAGG | 900 |
| AAGAAGATGA | GGANCTGACA | TTGAAATATG | NCGSCAAGCA | TGTGATCATG | CTCTTTGKCC | 960 |
| CTGTGACTCT | CTGCATGGTG | GTGGTCGTGG | NTACCATTAA | GTCAGTCAGC | TTTTATACCC | 1020 |
| GGAAGGATGG | GCAGCTGTAC | GTATGAGTTT | KGTTTTATTA | TTCTCAAASC | CAGTGTGGCT | 1080 |
| TTTCTTTACA | GCATGTCATC | ATCACCTTGA | AGGCCTCTNC | ATTGAAGGGG | CATGACTTAG | 1140 |
| CTGGAGAGCC | CATCCTCTGT | GATGGTCAGG | AGCAGTTGAG | AGANCGAGGG | GTTATTACTT | 1200 |
| CATGTTTTAA | GTGGAGAAAA | GGAACACTGC | AGAAGTATGT | TTCCTGTATG | GTATTACTGG | 1260 |
| ATAGGGCTGA | AGTTATGCTG | AATTGAACAC | ATAAATTCTT | TTCCACCTCA | GGGNCATTGG | 1320 |
| GCGCCCATTG | NTCTTCTGCC | TAGAATATTC | TTTCCTTTNC | TNACTTKGGN | GGATTAAATT | 1380 |
| CCTGTCATCC | CCCTCCTCTT | GGTGTTATAT | ATAAAGTNTT | GGTGCCGCAA | AAGAAGTAGC | 1440 |
| ACTCGAATAT | AAAATTTTCC | TTTTAATTCT | CAGCAAGGNA | AGTTACTTCT | ATATAGAAGG | 1500 |
| GTGCACCCNT | ACAGATGGAA | CAATGGCAAG | CGCACATTTG | GGACAAGGGA | GGGGAAAGGG | 1560 |
| TTCTTATCCC | TGACACACGT | GGTCCCNGCT | GNTGTGTNCT | NCCCCCACTG | ANTAGGGTTA | 1620 |
| GACTGGACAG | GCTTAAACTA | ATTCCAATTG | GNTAATTTAA | AGAGAATNAT | GGGGTGAATG | 1680 |
| CTTTGGGAGG | AGTCAAGGAA | GAGNAGGTAG | NAGGTAACCT | GAATGA | | 1726 |

(2) INFORMATION FOR SEQ ID NO:153:

- (i) SEQUENCE CHARACTERISTICS:
 (A) LENGTH: 1883 base pairs
 (B) TYPE: nucleic acid
 (C) STRANDEDNESS: single
 (D) TOPOLOGY: linear

(i i) MOLECULE TYPE: cDNA

(x i) SEQUENCE DESCRIPTION: SEQ ID NO:153:

| | | | | | | |
|------------|------------|------------|------------|------------|------------|-----|
| CNCGTATAAA | AGACCAACAT | TGCCANCNAC | AACCACAGGC | AAGATCTTCT | CCTACCTTCC | 60 |
| CCCNNGGTGT | AATACCAAGT | ATTCNCCAAT | TTGTGATAAA | CTTTCATTGG | AAAGTGACCA | 120 |
| CCCTCCTTGG | TTAATACATT | GTCTGTGCCT | GCTTTCACAC | TACAGTAGCA | CAGTTGAGTG | 180 |
| TTTGCCCTGG | AGACCATATG | ACCCATAGAG | CTTAAAATAT | TCAGTCTGGC | TTTTTACAGA | 240 |
| GATGTTTCTG | ACTTTGTAA | TAGAAAATCA | ACCCAACTGG | TTTAAATAAT | GCACATACTT | 300 |
| TCTCTCTCAT | AGAGTAGTGC | AGAGGTAGNC | AGTCCAGATT | AGTASGGTGG | CTTCACGTTC | 360 |
| ATCCAAGGAC | TCAATCTCCT | TCTTTCTTCT | TTAGCTTCTA | ACCTCTAGCT | TACTTCAGGG | 420 |
| TCCAGGCTGG | AGCCCTASCC | TTCATTTCTG | ACAGTAGGAA | GGAGTAGGGG | AGAAAAGAAC | 480 |

-continued

| | | | | | | |
|-------------|-------------|------------|------------|------------|------------|------|
| ATAGGACATG | TCAGCAGAAT | TCTCTCCTTA | GAAGTTCCAT | ACACAACACA | TCTCCCTAGA | 540 |
| AGTCATTGCC | CTTACTTGTT | CTCATAGCCA | TCCTAAATAT | AAGGGAGTCA | GAAGTAAAGT | 600 |
| CTKKNTGGCT | GGGAATATTG | GCACCTGGAA | TAAAAATGTT | TTTCTGTGAA | TGAGAAACAA | 660 |
| GGGGAAGATG | GATATGTGAC | ATTATCTTAA | GACAACTCCA | GTTGCAATTA | CTCTGCAGAT | 720 |
| GAGAGGCACT | AATTATAAGC | CATATTACCT | TTCTTCTGAC | AACCACTTGT | CAGCCCNCGT | 780 |
| GGTTTCTGTG | GCAGAATCTG | GTTCYATAMC | AAGTTCCTAA | TAANCTGTAS | CCNAAAAAAT | 840 |
| TTGATGAGGT | ATTATAATTA | TTTCAATATA | AAGCACCCAC | TAGATGGAGC | CAGTGTCTGC | 900 |
| TTCACATGTT | AAGTCCTTCT | TTCCATATGT | TAGACATTTT | CTTTGAAGCA | ATTTTAGAGT | 960 |
| GTAGCTGTTT | TTCTCAGGTT | AAAAATTCTT | AGCTAGGATT | GGTGAGTTGG | GGAAAAGTGA | 1020 |
| CTTATAAGAT | NCGAATTGAA | TTAAGAAAAA | GAAAATTCTG | TGTTGGAGGT | GGTAATGTGG | 1080 |
| KTGGTGATCT | YCATTAAACAC | TGANCTAGGG | CTTTKGKGT | TGKTTTATTG | TAGAATCTAT | 1140 |
| ACCCCATTC | NAGAAGATAC | CGAGACTGTG | GGCCAGAGAG | CCCTGCACTC | AATTCTGAAT | 1200 |
| GCTGCCATCA | TGATCAGNGT | CATTGTWGTC | ATGACTANNC | TCCTGGTGGT | TCWGTATAAA | 1260 |
| TACAGGTGCT | ATAAGGTGAG | CATGAGACAC | AGATCTTTGN | TTTCCACCCT | GTTCTTCTTA | 1320 |
| TGGTTGGGTA | TTCTTGTCAC | AGTAACTTAA | CTGATCTAGG | AAAGAAAAAA | TGTTTTGTCT | 1380 |
| TCTAGAGATA | AGTTAATTTT | TAGTTTTCTT | CCTCCTCACT | GTGGAACATT | CAAAAAATAC | 1440 |
| AAAAAGGAAG | CCAGGTGCAT | GTGTAATGCC | AGGCTCAGAG | GCTGAGGCAG | GAGGATCGCT | 1500 |
| TGGGCCCAGG | AGTTCACAAG | CAGCTTGGGC | AACGTAGCAA | GACCCTGCCT | CTATTAAGA | 1560 |
| AAACAAAAAA | CAAATATTGG | AAGTATTTTA | TATGCATGGA | ATCTATATGT | CATGAAAAAA | 1620 |
| TTAGTGTA | ATATATATAT | TATGATTAGN | TATCAAGATT | TAGTGATAAT | TTATGTTATT | 1680 |
| TTGGGATTTT | AATGCCTTTT | TAGGCCATTG | TCTCAAMAAA | TAAAAGCAGA | AAACAAAAAA | 1740 |
| AGTTGTA | GAAAAATAAA | CATTTCCATA | TAATAGCACA | ATCTAAGTGG | GTTTTTGNTT | 1800 |
| GTTTGTTTTGN | TTGTTGAAGC | AGGGCCTTGC | CCTNYCACCC | AGGNTGGAGT | GAAGTGCAGT | 1860 |
| GGCACGATTT | TGGCTCACTG | CAG | | | | 1883 |

(2) INFORMATION FOR SEQ ID NO:154:

- (i) SEQUENCE CHARACTERISTICS:
 (A) LENGTH: 1990 base pairs
 (B) TYPE: nucleic acid
 (C) STRANDEDNESS: single
 (D) TOPOLOGY: linear

(i i) MOLECULE TYPE: cDNA

(x i) SEQUENCE DESCRIPTION: SEQ ID NO:154:

| | | | | | | |
|------------|------------|------------|------------|------------|------------|-----|
| ATGTTTGACA | ATTTCTCCGT | TCCACCCTTG | ATTAAATAAG | GTAGTATTCA | TTTTTTAAGT | 60 |
| TTTAGCTTTT | GGATATATGT | GTAAGTGTGG | TATGCTGTCT | AATGAATTAA | GACAATTGGT | 120 |
| NCTKTCTTTA | CCCMACANCT | GGACMAAGAG | CAGGCAAGAT | NCAANAATCA | AGTGACCCAG | 180 |
| NCAAACCAGA | CACATTTTCT | GCTCTCAGCT | AGCTTGCCAC | CTAGAAAGAC | TGGTTGTCNA | 240 |
| AGTTGGAGTC | CAAGAATCGC | GGAGGATGTT | TAAAATGCAG | TTTCTCAGGT | TCTCNCCACC | 300 |
| CACCAGAAGT | TTTGATTCAT | TGAGTGGTGG | GAGAGGGCAG | AGATATTTGC | GATTTTAACA | 360 |
| GCATTCTCTT | GATTGTGATG | CAGCTGGTTC | SCAAATAGGT | ACCCTAAAGA | AATGACAGGT | 420 |
| GTTAAATTTA | GGATGGCCAT | CGCTTGTATG | CCGGGAGAAG | CACACGCTGG | GCCCAATTTA | 480 |
| TATAGGGGCT | TCGTCCTCA | GCTCGAGCAR | CCTCAGAACC | CCGACAACCY | ACGCCAGCKC | 540 |

-continued

| | | | | | | |
|------------|------------|------------|------------|------------|------------|---------|
| TCTGGGCGGA | TTCRTCAGK | TGGGGAAGSC | CAGGTGGAGC | TCTGGKTTCT | CCCCGCAATC | 6 0 0 |
| GTTTCTCCAG | GCCGGAGGCC | CCGCCCCCTT | CCTCCTGGCT | CCTCCCCTCC | TCCGTGGGCC | 6 6 0 |
| GNCCGCCAAC | GACGCCAGAG | CCGGAAATGA | CGACAACGGT | GAGGGTTCTC | GGGCGGGGCC | 7 2 0 |
| TGGGACAGGC | AGCTCCGGGG | TCCNCGNWT | NACATCGGAA | ACAAAACAGC | GGCTGGTCTG | 7 8 0 |
| GAAGGAACCT | GAKCTACGAC | CCGCGGCGGC | AGCGGGGCGG | CGGGGAAGCG | TATGTGCGTG | 8 4 0 |
| ATGGGGAGTC | CGGGCAAGCC | AGGAAGGCAC | CGCGGACATG | GGCGGCCGCG | GGCAGGGNCC | 9 0 0 |
| GGNCCTTTGT | GGCCGCCCGG | GCCGCGAAGC | CGGTGTCCTA | AAAGATGAGG | GGCGGGGCGC | 9 6 0 |
| GGCCGGTTGG | GGCTGGGGAA | CCCCGTGTGG | GAAACCAGGA | GGGGCGGCC | GTTTCTCGGG | 1 0 2 0 |
| CTTCGGGCGC | GGCCGGGTGG | AGAGAGATT | CGGGGAGCCT | TGGTCCGGAA | ATGCTGTTTG | 1 0 8 0 |
| CTCGAAGACG | TCTCAGGGCG | CAGGTGCCTT | GGGCCGGGAT | TAGTAGCCGT | CTGAACTGGA | 1 1 4 0 |
| GTGGAGTAGG | AGAAAGAGGA | AGCGTCTTGG | GCTGGGTCTG | CTTGAGCAAC | TGGTGAAACT | 1 2 0 0 |
| CCGCGCCTCA | CGCCCCGGGT | GTGTCCTTGT | CCAGGGGCGA | CGAGCATTCT | GGCGAAAGTC | 1 2 6 0 |
| CGCACGCCTC | TTGTTGAGG | CGGAAGACGG | GGTCTTGATG | CTTTCTCCTT | GGTCGGGACT | 1 3 2 0 |
| GTCTCGAGGC | ATGCATGTCC | AGTGACTCTT | GTGTTTGCTG | CTGCTTCCCT | CTCAGATTCT | 1 3 8 0 |
| TCTCACCGTT | GTGGTCAGCT | CTGCTTTAGG | CATATTAATC | CATAGTGGAG | GCTGGGATGG | 1 4 4 0 |
| GTGAGAGAAT | TGAGGTGACT | TTTCCATAAT | TCAGGTGAGA | TGTGATTAGA | GTTCGGATCC | 1 5 0 0 |
| TNCGGTGGTG | GCAGAGGCTT | ACCAAGAAAC | ACTAACGGGA | CATGGGAACC | AATTGAGGAT | 1 5 6 0 |
| CCAGGGAATA | AAGTGTGAAG | TTGACTAGGA | GGTTTTCAGT | TTAAGAACAT | GGCAGAGACA | 1 6 2 0 |
| TTCTCAGAAA | TAAGGAAGTT | AGGAAGAAAG | ACCTGGTTTA | GAGAGGAGGG | CGAGGAAGTG | 1 6 8 0 |
| GTTTGGAAGT | GTCACTTTGG | AAGTGCCAGC | AGGTGAAAAT | GCCCTGTGAA | CAGGACTGGA | 1 7 4 0 |
| GCTGAAAACA | GGAATCAATT | CCATAGATTT | CCAGTTGATG | TTGGAGCAGT | GGAGAAGTCT | 1 8 0 0 |
| AANCTAAGGA | AGGGGAAGAG | GAGGCCAAGC | CAAACACTTA | GGAACACTTN | CNACGAGGGG | 1 8 6 0 |
| GTGGAAGAAG | AGCAAGGAGC | CAGCTGAGGA | GAATGAGTGT | GGTTGGAGAA | CCACCACAGC | 1 9 2 0 |
| NCAGGGTCGC | CAGANCTGAG | GAAGGGGAGG | GAAGCTTATC | GAGKAMSGWC | RACMKCGAGT | 1 9 8 0 |
| TGGCAGGGAT | | | | | | 1 9 9 0 |

(2) INFORMATION FOR SEQ ID NO:155:

- (i) SEQUENCE CHARACTERISTICS:
 (A) LENGTH: 736 base pairs
 (B) TYPE: nucleic acid
 (C) STRANDEDNESS: single
 (D) TOPOLOGY: linear

(i i) MOLECULE TYPE: cDNA

(x i) SEQUENCE DESCRIPTION: SEQ ID NO:155:

| | | | | | | |
|------------|------------|------------|------------|-------------|------------|-------|
| GTCTTTCCCA | TCTTCTCCAC | AGAGTTTGTG | CCTTACATTA | TTACTCCTTG | CCATTTTCAA | 6 0 |
| GAAAGCATTG | TCAGCTCTTC | CAATCTCCAT | CACCTTTGGG | CTTGTTTTCT | ACTTTGCCAC | 1 2 0 |
| AGATTATCTT | GTACAGCCTT | TTATGGACCA | ATTAGCATTC | CATCAATTTT | ATATCTAGCA | 1 8 0 |
| TATTTGCGGT | TAGAATCCCA | TGGATGTTTC | TTCTTTGACT | ATAACAAAAT | CTGGGGAGGA | 2 4 0 |
| CAAAGGTGAT | TTCCTGTGTC | CACATCTAAC | AAATCAAGAT | CCCCGGCTGG | ACTTTTGGAG | 3 0 0 |
| GTTCCTTCCA | AGTCTTCCTG | ACCACCTTGC | ACTATTGGAC | TTTGGAAAGGA | GGTGCCTATA | 3 6 0 |
| GAAAACGATT | TTGAACATAC | TTCATCGCAG | TGGACTGTGT | CCTCGGTGCA | GAAACTACCA | 4 2 0 |
| GATTTGAGGG | ACGAGGTCAA | GGAGATATGA | TAGGCCCGGA | AGTTGCTGTG | CCCCATCAGC | 4 8 0 |
| AGCTTGACGC | GTGGTCACAG | GACGATTTTC | ACTGACACTG | CGAACTCTCA | GGACTACCGT | 5 4 0 |

-continued

| | | | | | | |
|------------|------------|------------|------------|------------|------------|-------|
| TACCAAGAGG | TTAGGTGAAG | TGGTTTAAAC | CAAACGGAAC | TCTTCATCTT | AAACTACACG | 6 0 0 |
| TTGAAAATCA | ACCCAATAAT | TCTGTATTAA | CTGAATTCTG | AACTTTTCAG | GAGGTACTGT | 6 6 0 |
| GAGGAAGAGC | AGGCACCACC | AGCAGAATGG | GGAATGGAGA | GGTGGGCAGG | GGTTCCAGCT | 7 2 0 |
| TCCCTTTGAT | TTTTTG | | | | | 7 3 6 |

(2) INFORMATION FOR SEQ ID NO:156:

- (i) SEQUENCE CHARACTERISTICS:
 (A) LENGTH: 1117 base pairs
 (B) TYPE: nucleic acid
 (C) STRANDEDNESS: single
 (D) TOPOLOGY: linear

(i i) MOLECULE TYPE: cDNA

(x i) SEQUENCE DESCRIPTION: SEQ ID NO:156:

| | | | | | | |
|------------|------------|------------|------------|-------------|------------|---------|
| GGATCCGCC | GCCTTGGCCT | CCCAAAGTGC | TGGGATTACA | GGCATGAGCC | ACCGCTCCTG | 6 0 |
| GCTGAGTCTG | CGATTTCTTG | CCAGCTCTAC | CCAGTTGTGT | CATCTTAAGC | AAGTCACTGA | 1 2 0 |
| ACTTCTCTGG | ATTCCCTTCT | CCTNNWGTA | AATAAGNATG | TTATCTGNCC | NNCCTGCCTT | 1 8 0 |
| GGGCATTGTG | ATAAGGATAA | GATGACATTA | TAGAATNTNG | CAAAATTAAA | AGCGCTAGAC | 2 4 0 |
| AAATGATTTT | ATGAAAATAT | AAAGATTAGN | TTGAGTTTGG | GCCAGCATAG | AAAAAGGAAT | 3 0 0 |
| GTTGAGAACA | TTCNTTAAG | GATTACTCAA | GCYCCCCTTT | TGSTGKNWAA | TCAGANNGTC | 3 6 0 |
| ATNNAMNTAT | CNTNTGTGGG | YTGAAAATGT | TTGGTTGTCT | CAGGCGGTTC | CTACTTATTG | 4 2 0 |
| CTAAAGAGTC | CTACCTTGAG | CTTATAGTAA | ATTTGTCAGT | TAGTTGAAAG | TCGTGACAAA | 4 8 0 |
| TTAATACATT | CCTGGTTTAC | AAATTGGTCT | TATAAGTATT | TGATTGGTNT | AAATGNATTT | 5 4 0 |
| ACTAGGATTT | AACTAACAAT | GGATGACCTG | GTGAAATCCT | ATTTTCAGACC | TAATCTGGGA | 6 0 0 |
| GCCTGCAAGT | GACAACAGCC | TTTGCGGTCC | TTAGACAGCT | TGGCCTGGAG | GAGAACACAT | 6 6 0 |
| GAAAGAMMGG | TTTGWNTCTG | NTTAWTGTA | TCTATGRAAG | TGTTTTTWAT | MACAGTATAA | 7 2 0 |
| TTGTMTGMAC | AAAGTTCTGT | TTTTCTTTCC | CTTNCAGAA | CCTCAAGAGG | CTTTGTTTTC | 7 8 0 |
| TGTGAAACAG | TATTTCTATA | CAGNTGCTCC | AATGACAGAG | TNACCTGCAC | CGTTGTCCTA | 8 4 0 |
| CTTCCAGAAT | GCACAGATGT | CTGAGGACAA | CCACCTGAGC | AATACTGTAC | GTAGCCAGGT | 9 0 0 |
| ACAGCGTCAG | TYTCTNAAAC | TGCCTYYGNC | AGACTGGATT | CACTTATCAT | CTCCCCTCAC | 9 6 0 |
| CTCTGAGAAA | TGCTGAGGGG | GSTAGGNAGG | GCTTTCTCTA | CTTNACCACA | TTTNATAATT | 1 0 2 0 |
| ATTTTTGGGT | GACCTTCAGC | TGATCGCTGG | GAGGGACACA | GGGCTTNTTT | AACACATAGG | 1 0 8 0 |
| GTGTTGGATA | CAGNCCCTCC | CTAATTCACA | TTTCANC | | | 1 1 1 7 |

(2) INFORMATION FOR SEQ ID NO:157:

- (i) SEQUENCE CHARACTERISTICS:
 (A) LENGTH: 540 base pairs
 (B) TYPE: nucleic acid
 (C) STRANDEDNESS: single
 (D) TOPOLOGY: linear

(i i) MOLECULE TYPE: cDNA

(x i) SEQUENCE DESCRIPTION: SEQ ID NO:157:

| | | | | | | |
|------------|------------|------------|-------------|------------|------------|-------|
| CTGCAGCTTT | CCTTTAAACT | AGGAAGACTT | GTTCCCTATAC | CCCAGTAACG | ATACACTGTA | 6 0 |
| CACTAAGCAA | ATAGCAGTCA | AACCCAAATG | AAATTTNTAC | AGATGTTCTG | TGTCATTTTA | 1 2 0 |
| TNTTGTTTAT | GTTGTCTCCC | CCACCCCCAC | CAGTTCACCT | GCCATTTATT | TCATATTCAT | 1 8 0 |
| TCAACGTCTN | NNTGTGTAAA | AAGAGACAAA | AAACATTAAA | CTTTTTTCCT | TCGTTAATTC | 2 4 0 |

-continued

| | | | | | | |
|------------|------------|------------|------------|------------|------------|-------|
| CTCCCTACCA | CCCATTTACA | AGTTTAGCCC | ATACATTTTA | TTAGATGTCT | TTTATGTTTT | 3 0 0 |
| TCTTTTNCTA | GATTTAGTGG | CTGTTTNGTG | TCCGAAAGGT | CCACTTCGTA | TGCTGGTTGA | 3 6 0 |
| AACAGCTCAG | GAGAGAAATG | AAACGCTTTT | TCCAGCTCTC | ATTTACTCCT | GTAAGTATTT | 4 2 0 |
| GGAGAATGAT | ATTGAATTAG | TAATCAGNGT | AGAATTTATC | GGGAACTTGA | AGANATGTNA | 4 8 0 |
| CTATGGCAAT | TTCANGGNAC | TTGTCTCATC | TTAAATGANA | GNATCCCTGG | ACTCCTGNAG | 5 4 0 |

(2) INFORMATION FOR SEQ ID NO:158:

- (i) SEQUENCE CHARACTERISTICS:
 (A) LENGTH: 509 base pairs
 (B) TYPE: nucleic acid
 (C) STRANDEDNESS: single
 (D) TOPOLOGY: linear

(i i) MOLECULE TYPE: cDNA

(x i) SEQUENCE DESCRIPTION: SEQ ID NO:158:

| | | | | | | |
|------------|------------|------------|------------|------------|------------|-------|
| CCCCGTCNAT | GCATACTTTG | TGTGTCCAGT | GCTTACCTGG | AATCCNGTCT | TTCCCAACAG | 6 0 |
| CAACAATGGT | GTGGTTGGTG | AATATGGCAG | AAGGAGACCC | GGAAGCTCAA | AGGAGAGTAT | 1 2 0 |
| CCAAAAATTC | CAAGTATAAT | GCAGAAAGTA | GGTAACTYYY | NTTAGATAMN | ATCTTGATTT | 1 8 0 |
| TNCAGGGTCA | CTGTTATAAG | CTAACAGTAT | AGNAATGTTT | TTATCGTCTT | TCTNKGGNCA | 2 4 0 |
| TAGACTCCTN | KGAGAATCTC | TTGAGAACTA | TGATAATGCC | CAGTAAATAC | NCAGATAAGT | 3 0 0 |
| ATTTAAGGAG | TNCAGATACT | CAAANCCCAA | CAATACNGTC | AAAGCATCCT | AGGTTAAGAC | 3 6 0 |
| AMCNCCCAT | AAATACAGAA | TACCAGCATG | GAAAGGTTCA | GGCTGAGGTT | ATGATTGGGT | 4 2 0 |
| TTGGGTTTTG | GGNNNGTTTT | TTATAAGTCA | TGATTTTAAA | AAGAAAAAAT | AAACTCTCTC | 4 8 0 |
| CAAACATGTA | AAAGTAAGAA | TCTCCTAAA | | | | 5 0 9 |

(2) INFORMATION FOR SEQ ID NO:159:

- (i) SEQUENCE CHARACTERISTICS:
 (A) LENGTH: 823 base pairs
 (B) TYPE: nucleic acid
 (C) STRANDEDNESS: single
 (D) TOPOLOGY: linear

(i i) MOLECULE TYPE: cDNA

(x i) SEQUENCE DESCRIPTION: SEQ ID NO:159:

| | | | | | | |
|------------|------------|------------|------------|------------|------------|-------|
| CAGGAGTGGA | CTAGGTAAAT | GNAAGNTGTT | TTAAAGAGAG | ATGNNGNCNG | GGACATAGTG | 6 0 |
| GTACACANCT | GTAATGCTCA | NCACTKATGG | GGAGTACTGA | AGGNGGNSGG | ATCACTTGNG | 1 2 0 |
| GGTCNGGAAT | NTGAGANCAG | CCTGGGCAAN | ATGGCGAAAC | CCTGTCTCTA | CTAAAAATAG | 1 8 0 |
| CCANAAWNWA | GCCTAGCGTG | GTGGCGCRCA | CGCGTGGTTC | CACCTACTCA | GGAGGCNTAA | 2 4 0 |
| GCACGAGNAN | TNCTTGAACC | CAGGAGGCAG | AGGNTGTGGT | GARCTGAGAT | CGTGCCACTG | 3 0 0 |
| CACTCCAGTC | TGGGCGACMA | AGTGAGACCC | TGTCTCCNNN | AAGAAAAAAA | AAATCTGTAC | 3 6 0 |
| TTTTTAAGGG | TTGTGGGACC | TGTTAATTAT | ATTGAAATGC | TTCTYTTCTA | GGTCATCCAT | 4 2 0 |
| GCCTGGCTTA | TTATATCATC | TCTATTGTTG | CTGCTCTTTT | TTACATTCAT | TTACTTGGGG | 4 8 0 |
| TAAGTTGTGA | AATTTGGGGT | CTGTCTTTCA | GAATTAACTA | CCTNNGTGCT | GTGTAGCTAT | 5 4 0 |
| CATTTAAAGC | CATGTACTTT | GNTGATGAAT | TACTCTGAAG | TTTTAATTGT | NTCCACATAT | 6 0 0 |
| AGGTCATACT | TGGTATATAA | AAGACTAGNC | AGTATTAATA | ATTGAGACAT | TCTTCTGTNG | 6 6 0 |
| CTCCTNGCTT | ATAATAAGTA | GAACTGAAAG | NAACTTAAGA | CTACAGTTAA | TTCTAAGCCT | 7 2 0 |
| TTGGGGAAGG | ATTATATAGC | CTTCTAGTAG | GAAGTCTTGT | GCNATCAGAA | TGTTTNTAAA | 7 8 0 |

-continued

GAAAGGGTNT CAAGGAATNG TATAAANACC AAAAATAATT GAT

8 2 3

(2) INFORMATION FOR SEQ ID NO:160:

- (i) SEQUENCE CHARACTERISTICS:
 - (A) LENGTH: 945 base pairs
 - (B) TYPE: nucleic acid
 - (C) STRANDEDNESS: single
 - (D) TOPOLOGY: linear

(i i) MOLECULE TYPE: cDNA

(x i) SEQUENCE DESCRIPTION: SEQ ID NO:160:

```

GTTNTCCNAA CCAACTTAGG AGNTTGGACC TGGGRAAGAC CNACNTGATC TCCGGGAGGN      6 0
AAAGACTNCA GTTGAGCCGT GATTGCACCC ACTTTACTCC AAGCCTGGGC AACCAAAATG      1 2 0
AGACACTGGC TCCAAACACA AAAACAAAAA CAAAAAAGA GTAAATTAAT TTANAGGGAA      1 8 0
GNATTAAATA AATAATAGCA CAGTTGATAT AGGTTATGGT AAAATTATAA AGGTGGGANA      2 4 0
TTAATATCTA ATGTTTGGGA GCCATCACAT TATTCTAAAT AATGTTTTGG TGGAAATTAT      3 0 0
TGTACATCTT TAAAATCTG TGTAATTTTT TTTCAGGGAA GTGTTTAAAA CCTATAACGT      3 6 0
TGCTGTGGAC TACATTA CTG TTNCACTCCT GATCTGGAAT TTTGGTGTGG TGGGAATGAT      4 2 0
TTCCATTCAC TGGAAAGGTC CACTTCGACT CCAGCAGGCA TATCTCATTG TGATTAGTGC      4 8 0
CCTCATGNCC CTGKTGTTTA TCAAGTACCT CCCTGAATGG ACTGNGTGGC TCATCTTGGC      5 4 0
TGTGATTTCA GTATATGGTA AAACCCAAGA CTGATAATTT GTTTGT CACA GGAATGCCCC      6 0 0
ACTGGAGTGT TTTCTTTCCT CATCTCTTTA TCTTGATTTA GAGAAAATGG TAACGTGTAC      6 6 0
ATCCATAAC TCTTCAGTAA ATCATTAAAT AGCTATAGTA ACTTTTTTCAT TTGAAGATTT      7 2 0
CGGCTGGGCA TGGTAGCTCA TGCCTGTAAT CTTAGCACTT TGGGAGGCTG AGGCGGGCAG      7 8 0
ATCACCTAAG CCCAGAGTTC AAGACCAGCC TGGGCAACAT GGCAAAACCT CGTATCTACA      8 4 0
GAAAATACAA AAATTAGCCG GGCATGGTGG TGCACACCTG TAGTTCAGC TACTTAGGAG      9 0 0
GCTGAGGTGG GAGGATCGAT TGATCCCAGG AGGTCAAGNC TGCAG                      9 4 5

```

(2) INFORMATION FOR SEQ ID NO:161:

- (i) SEQUENCE CHARACTERISTICS:
 - (A) LENGTH: 18 base pairs
 - (B) TYPE: nucleic acid
 - (C) STRANDEDNESS: single
 - (D) TOPOLOGY: linear

(i i) MOLECULE TYPE: other nucleic acid
 (A) DESCRIPTION: /desc = "primer"

(x i) SEQUENCE DESCRIPTION: SEQ ID NO:161:

TGCTGCTTGC TGTGTTCA

1 8

(2) INFORMATION FOR SEQ ID NO:162:

- (i) SEQUENCE CHARACTERISTICS:
 - (A) LENGTH: 20 base pairs
 - (B) TYPE: nucleic acid
 - (C) STRANDEDNESS: single
 - (D) TOPOLOGY: linear

(i i) MOLECULE TYPE: other nucleic acid
 (A) DESCRIPTION: /desc = "primer"

(x i) SEQUENCE DESCRIPTION: SEQ ID NO:162:

CCATGTCCCT CAGATGTAGA

2 0

-continued

(2) INFORMATION FOR SEQ ID NO:163:

(i) SEQUENCE CHARACTERISTICS:

- (A) LENGTH: 17 base pairs
- (B) TYPE: nucleic acid
- (C) STRANDEDNESS: single
- (D) TOPOLOGY: linear

(i i) MOLECULE TYPE: other nucleic acid

- (A) DESCRIPTION: /desc = "primer"

(x i) SEQUENCE DESCRIPTION: SEQ ID NO:163:

CATCTCCATC ACGTTTCG

1 7

(2) INFORMATION FOR SEQ ID NO:164:

(i) SEQUENCE CHARACTERISTICS:

- (A) LENGTH: 17 base pairs
- (B) TYPE: nucleic acid
- (C) STRANDEDNESS: single
- (D) TOPOLOGY: linear

(i i) MOLECULE TYPE: other nucleic acid

- (A) DESCRIPTION: /desc = "primer"

(x i) SEQUENCE DESCRIPTION: SEQ ID NO:164:

CATCTCCACC ACGTTTCG

1 7

(2) INFORMATION FOR SEQ ID NO:165:

(i) SEQUENCE CHARACTERISTICS:

- (A) LENGTH: 1895 base pairs
- (B) TYPE: nucleic acid
- (C) STRANDEDNESS: single
- (D) TOPOLOGY: linear

(i i) MOLECULE TYPE: cDNA

(x i) SEQUENCE DESCRIPTION: SEQ ID NO:165:

| | | | | | | |
|------------|------------|------------|------------|------------|------------|---------|
| TATATGAGTC | GCTTTAAAAC | AAAAGAAAGT | TTTTACCAGC | TACATTCCTT | TGGTTTCCTT | 6 0 |
| AACTAAATCC | CATCACACAA | CTACGGCTTC | GCAGGGGGAG | GCGTCCAGCG | CTACGGAGGC | 1 2 0 |
| GAACGAACGC | ACACCACTGA | TGGCTGCTGT | CAATCTCCAG | GCTTCGTGCT | CCTCCGGGCT | 1 8 0 |
| CGCCTCTGAG | GATGACGCCA | ATGTGGGCAG | CCAGATAGGC | GCGGCGGAGC | GTTTGGAACG | 2 4 0 |
| ACCTCCAAGG | CGGCAACAGC | AGCGGAACAA | CTACGGCTCC | AGCAATCAGG | ATCAACCGGA | 3 0 0 |
| TGCTGCCATA | CTTGCTGTGC | CCAATGTGGT | GATGCGTGAA | CCTTGTGGCT | CGCGCCCTTC | 3 6 0 |
| AAGACTGACC | GGTGGAGGAG | GCGGCAGTGG | TGGTCCGCCC | ACAAATGAAA | TGGAGGAAGA | 4 2 0 |
| GCAGGGCCTG | AAATACGGGG | CCCAGCATGT | GATCAAGTTA | TTCGTCCCCG | TCTCCCTTTG | 4 8 0 |
| CATGCTGGTA | GTGGTGGCTA | CCATCAACTC | CATCAGCTTC | TACAACAGCA | CGGATGTCTA | 5 4 0 |
| TCTCCTCTAC | ACACCTTTCC | ATGAACAATC | GCCCGAGCCT | AGTGTTAAGT | TCTGGAGTGC | 6 0 0 |
| CTTGCGAAC | TCCCTGATCC | TGATGAGCGT | GGTGGTGGTG | ATGACCTTTT | TGCTGATTGT | 6 6 0 |
| TTTGTACAAG | AAGCGTTGCT | ATCGCATCAT | TCACGGCTGG | CTGATTCTCT | CCTCCTTCAT | 7 2 0 |
| GTTGTTGTTT | ATTTTTACGT | ACTTATATTT | GGAAGAGCTT | CTTCGCGCCT | ATAACATACC | 7 8 0 |
| GATGGACTAC | CCTACTGCAC | TACTGATTAT | GTGGAACTTT | GGAGTGGTCG | GAATGATGTC | 8 4 0 |
| CATCCATTGG | CAGGGACCTC | TGCGGTTGCA | GCAAGGATAT | CTCATTTTCG | TGGCAGCCTT | 9 0 0 |
| GATGGCCTTG | GTGTTCATTA | AATACCTGCC | TGAATGGACT | GCCTGGGCTG | TATTGGCTGC | 9 6 0 |
| CATTTCTATT | TGGGATCTTA | TTGCTGTCCT | TTCGCCAAGA | GGACCCCTCC | GCATTCTGGT | 1 0 2 0 |
| GGAAACGGCT | CAGGAGCGAA | ATGAGCAAAT | CTTCCCCGCT | CTGATTTATT | CATCCACTGT | 1 0 8 0 |

-continued

```

CGTTTACGCA CTTGTAAACA CTGTTACGCC GCAGCAATCG CAGGCCACAG CTCCTCCTC 1140
GCCGTTCGTCC AGCAACTCCA CCACAACCAC GAGGGCCACG CAGAACTCGC TGGCTTCGCC 1200
AGAGGCAGCA GCGGCTAGTG GCCAACGCAC AGGTAACTCC CATCCTCGAC AGAATCAGCG 1260
GGATGACGGC AGTGTACTGG CAACTGAAGG TATGCCACTT GTGACTTTTA AAAGCAATTT 1320
GCGCGGAAAC GCTGAGGCTG CGGGTTTCAC GCAAGAGTGG TCAGCTAACT TGAGCGAACG 1380
TGTGGCTCGT CGCCAGATTG AAGTTCAAAG TACTCAGAGT GGAAACGCTC AGCGCTCCAA 1440
CGAGTATAGG ACAGTAACAG CTCCGGATCA GAATCATCCG GATGGGCAAG AAGAACGTGG 1500
CATAAAGCTT GGCCTCGGCG ACTTCATCTT CTA CTCTCGGTA TTAGTGGGCA AGGCCTCCAG 1560
CTACGGCGAC TGGACGACCA CAATCGCTTG CTTTGTGGCC ATCCTCATTG GACTCTGCCT 1620
CACTCTTCTG CTTCTGGCCA TTTGGCGCAA GGCGCTACCC GCCCTGCCCA TCTCAATAAC 1680
GTTTCGGATTG ATATTTTGCT TCGCCACTAG TCGGGTGGTC AAGCCGTTCA TGGAGGATCT 1740
ATCGGCCAAG CAGGTGTTTA TATAAACTTG AAAAGACAAG GACACATCAA GTGTCTTACA 1800
GTATCATAGT CTAACAAAGC TTTTTGTAAT CCAATTCTTT ATTTAACCAA ATGCATAGTA 1860
ACAACCTCGA CTA AAAAAAAAA AAAAAAAAA AAAAA 1895

```

(2) INFORMATION FOR SEQ ID NO:166:

- (i) SEQUENCE CHARACTERISTICS:
 (A) LENGTH: 541 amino acids
 (B) TYPE: amino acid
 (C) STRANDEDNESS: single
 (D) TOPOLOGY: linear

(i i) MOLECULE TYPE: protein

(x i) SEQUENCE DESCRIPTION: SEQ ID NO:166:

```

Met Ala Ala Val Asn Leu Gln Ala Ser Cys Ser Ser Gly Leu Ala Ser
1                    5                    10                    15
Glu Asp Asp Ala Asn Val Gly Ser Gln Ile Gly Ala Ala Glu Arg Leu
20
Glu Arg Pro Pro Arg Arg Gln Gln Gln Arg Asn Asn Tyr Gly Ser Ser
35                    40                    45
Asn Gln Asp Gln Pro Asp Ala Ala Ile Leu Ala Val Pro Asn Val Val
50                    55                    60
Met Arg Glu Pro Cys Gly Ser Arg Pro Ser Arg Leu Thr Gly Gly Gly
65                    70                    75                    80
Gly Gly Ser Gly Gly Pro Pro Thr Asn Glu Met Glu Glu Glu Gln Gly
85                    90                    95
Leu Lys Tyr Gly Ala Gln His Val Ile Lys Leu Phe Val Pro Val Ser
100                    105                    110
Leu Cys Met Leu Val Val Val Ala Thr Ile Asn Ser Ile Ser Phe Tyr
115                    120                    125
Asn Ser Thr Asp Val Tyr Leu Leu Tyr Thr Pro Phe His Glu Gln Ser
130                    135                    140
Pro Glu Pro Ser Val Lys Phe Trp Ser Ala Leu Ala Asn Ser Leu Ile
145                    150                    155                    160
Leu Met Ser Val Val Val Val Met Thr Phe Leu Leu Ile Val Leu Tyr
165                    170                    175
Lys Lys Arg Cys Tyr Arg Ile Ile His Gly Trp Leu Ile Leu Ser Ser
180                    185                    190
Phe Met Leu Leu Phe Ile Phe Thr Tyr Leu Tyr Leu Glu Glu Leu Leu
195                    200                    205

```

-continued

| | | | | | | | | | | | | | | | |
|-----|-----|-----|-----|-----|-----|-----|-----|-----|-----|-----|-----|-----|-----|-----|-----|
| Arg | Ala | Tyr | Asn | Ile | Pro | Met | Asp | Tyr | Pro | Thr | Ala | Leu | Leu | Ile | Met |
| | 210 | | | | | 215 | | | | | 220 | | | | |
| Trp | Asn | Phe | Gly | Val | Val | Gly | Met | Met | Ser | Ile | His | Trp | Gln | Gly | Pro |
| 225 | | | | | 230 | | | | | 235 | | | | | 240 |
| Leu | Arg | Leu | Gln | Gln | Gly | Tyr | Leu | Ile | Phe | Val | Ala | Ala | Leu | Met | Ala |
| | | | | 245 | | | | | 250 | | | | | 255 | |
| Leu | Val | Phe | Ile | Lys | Tyr | Leu | Pro | Glu | Trp | Thr | Ala | Trp | Ala | Val | Leu |
| | | | 260 | | | | | 265 | | | | | 270 | | |
| Ala | Ala | Ile | Ser | Ile | Trp | Asp | Leu | Ile | Ala | Val | Leu | Ser | Pro | Arg | Gly |
| | | 275 | | | | | 280 | | | | | 285 | | | |
| Pro | Leu | Arg | Ile | Leu | Val | Glu | Thr | Ala | Gln | Glu | Arg | Asn | Glu | Gln | Ile |
| | 290 | | | | | 295 | | | | | 300 | | | | |
| Phe | Pro | Ala | Leu | Ile | Tyr | Ser | Ser | Thr | Val | Val | Tyr | Ala | Leu | Val | Asn |
| 305 | | | | | 310 | | | | | 315 | | | | | 320 |
| Thr | Val | Thr | Pro | Gln | Gln | Ser | Gln | Ala | Thr | Ala | Ser | Ser | Ser | Pro | Ser |
| | | | | 325 | | | | | 330 | | | | | 335 | |
| Ser | Ser | Asn | Ser | Thr | Thr | Thr | Thr | Arg | Ala | Thr | Gln | Asn | Ser | Leu | Ala |
| | | | 340 | | | | | 345 | | | | | 350 | | |
| Ser | Pro | Glu | Ala | Ala | Ala | Ala | Ser | Gly | Gln | Arg | Thr | Gly | Asn | Ser | His |
| | | 355 | | | | | 360 | | | | | 365 | | | |
| Pro | Arg | Gln | Asn | Gln | Arg | Asp | Asp | Gly | Ser | Val | Leu | Ala | Thr | Glu | Gly |
| | 370 | | | | | 375 | | | | | 380 | | | | |
| Met | Pro | Leu | Val | Thr | Phe | Lys | Ser | Asn | Leu | Arg | Gly | Asn | Ala | Glu | Ala |
| 385 | | | | | 390 | | | | | 395 | | | | | 400 |
| Ala | Gly | Phe | Thr | Gln | Glu | Trp | Ser | Ala | Asn | Leu | Ser | Glu | Arg | Val | Ala |
| | | | | 405 | | | | | 410 | | | | | 415 | |
| Arg | Arg | Gln | Ile | Glu | Val | Gln | Ser | Thr | Gln | Ser | Gly | Asn | Ala | Gln | Arg |
| | | | 420 | | | | | 425 | | | | | 430 | | |
| Ser | Asn | Glu | Tyr | Arg | Thr | Val | Thr | Ala | Pro | Asp | Gln | Asn | His | Pro | Asp |
| | | 435 | | | | | 440 | | | | | 445 | | | |
| Gly | Gln | Glu | Glu | Arg | Gly | Ile | Lys | Leu | Gly | Leu | Gly | Asp | Phe | Ile | Phe |
| | 450 | | | | | 455 | | | | | 460 | | | | |
| Tyr | Ser | Val | Leu | Val | Gly | Lys | Ala | Ser | Ser | Tyr | Gly | Asp | Trp | Thr | Thr |
| 465 | | | | | 470 | | | | | 475 | | | | | 480 |
| Thr | Ile | Ala | Cys | Phe | Val | Ala | Ile | Leu | Ile | Gly | Leu | Cys | Leu | Thr | Leu |
| | | | | 485 | | | | | 490 | | | | | 495 | |
| Leu | Leu | Leu | Ala | Ile | Trp | Arg | Lys | Ala | Leu | Pro | Ala | Leu | Pro | Ile | Ser |
| | | | 500 | | | | | 505 | | | | | 510 | | |
| Ile | Thr | Phe | Gly | Leu | Ile | Phe | Cys | Phe | Ala | Thr | Ser | Ala | Val | Val | Lys |
| | | 515 | | | | | 520 | | | | | 525 | | | |
| Pro | Phe | Met | Glu | Asp | Leu | Ser | Ala | Lys | Gln | Val | Phe | Ile | | | |
| | 530 | | | | | 535 | | | | | 540 | | | | |

(2) INFORMATION FOR SEQ ID NO:167:

- (i) SEQUENCE CHARACTERISTICS:
 (A) LENGTH: 15 amino acids
 (B) TYPE: amino acid
 (C) STRANDEDNESS: single
 (D) TOPOLOGY: linear

(i i) MOLECULE TYPE: peptide

(x i) SEQUENCE DESCRIPTION: SEQ ID NO:167:

| | | | | | | | | | | | | | | |
|-----|-----|-----|-----|-----|-----|-----|-----|-----|-----|-----|-----|-----|-----|-----|
| Asn | Asp | Asn | Arg | Glu | Arg | Gln | Glu | His | Asn | Asp | Arg | Arg | Ser | Leu |
| 1 | | | | 5 | | | | | 10 | | | | | 15 |

-continued

(2) INFORMATION FOR SEQ ID NO:168:

- (i) SEQUENCE CHARACTERISTICS:
 (A) LENGTH: 15 amino acids
 (B) TYPE: amino acid
 (C) STRANDEDNESS: single
 (D) TOPOLOGY: linear

(i i) MOLECULE TYPE: peptide

(x i) SEQUENCE DESCRIPTION: SEQ ID NO:168:

L y s A s p G l y G l n L e u I l e T y r T h r P r o P h e T h r G l u A s p T h r G l u
 1 5 1 0 1 5

(2) INFORMATION FOR SEQ ID NO:169:

- (i) SEQUENCE CHARACTERISTICS:
 (A) LENGTH: 15 amino acids
 (B) TYPE: amino acid
 (C) STRANDEDNESS: single
 (D) TOPOLOGY: linear

(i i) MOLECULE TYPE: peptide

(x i) SEQUENCE DESCRIPTION: SEQ ID NO:169:

G l u A l a G l n A r g A r g V a l S e r L y s A s n S e r L y s T y r A s n A l a G l u
 1 5 1 0 1 5

(2) INFORMATION FOR SEQ ID NO:170:

- (i) SEQUENCE CHARACTERISTICS:
 (A) LENGTH: 15 amino acids
 (B) TYPE: amino acid
 (C) STRANDEDNESS: single
 (D) TOPOLOGY: linear

(i i) MOLECULE TYPE: peptide

(x i) SEQUENCE DESCRIPTION: SEQ ID NO:170:

S e r H i s L e u G l y P r o H i s A r g S e r T h r P r o G l u S e r A r g A l a A l a
 1 5 1 0 1 5

(2) INFORMATION FOR SEQ ID NO:171:

- (i) SEQUENCE CHARACTERISTICS:
 (A) LENGTH: 19 base pairs
 (B) TYPE: nucleic acid
 (C) STRANDEDNESS: single
 (D) TOPOLOGY: linear

(i i) MOLECULE TYPE: other nucleic acid
 (A) DESCRIPTION: /desc = "primer"

(x i) SEQUENCE DESCRIPTION: SEQ ID NO:171:

C A G A G G A T G G A G A G A A T A C

1 9

(2) INFORMATION FOR SEQ ID NO:172:

- (i) SEQUENCE CHARACTERISTICS:
 (A) LENGTH: 19 base pairs
 (B) TYPE: nucleic acid
 (C) STRANDEDNESS: single
 (D) TOPOLOGY: linear

(i i) MOLECULE TYPE: other nucleic acid
 (A) DESCRIPTION: /desc = "primer"

(x i) SEQUENCE DESCRIPTION: SEQ ID NO:172:

G G C T C C C C A A A A C T G T C A T

1 9

-continued

(2) INFORMATION FOR SEQ ID NO:173:

- (i) SEQUENCE CHARACTERISTICS:
 - (A) LENGTH: 20 base pairs
 - (B) TYPE: nucleic acid
 - (C) STRANDEDNESS: single
 - (D) TOPOLOGY: linear

- (i i) MOLECULE TYPE: other nucleic acid
 - (A) DESCRIPTION: /desc = "primer"

- (x i) SEQUENCE DESCRIPTION: SEQ ID NO:173:

GCCCTAGTGT TCATCAAGTA

2 0

(2) INFORMATION FOR SEQ ID NO:174:

- (i) SEQUENCE CHARACTERISTICS:
 - (A) LENGTH: 18 base pairs
 - (B) TYPE: nucleic acid
 - (C) STRANDEDNESS: single
 - (D) TOPOLOGY: linear

- (i i) MOLECULE TYPE: other nucleic acid
 - (A) DESCRIPTION: /desc = "primer"

- (x i) SEQUENCE DESCRIPTION: SEQ ID NO:174:

AAAGCGGGAG CCAAAGTC

1 8

(2) INFORMATION FOR SEQ ID NO:175:

- (i) SEQUENCE CHARACTERISTICS:
 - (A) LENGTH: 19 base pairs
 - (B) TYPE: nucleic acid
 - (C) STRANDEDNESS: single
 - (D) TOPOLOGY: linear

- (i i) MOLECULE TYPE: other nucleic acid
 - (A) DESCRIPTION: /desc = "primer"

- (x i) SEQUENCE DESCRIPTION: SEQ ID NO:175:

CATTCACTGA GGACACACC

1 9

(2) INFORMATION FOR SEQ ID NO:176:

- (i) SEQUENCE CHARACTERISTICS:
 - (A) LENGTH: 18 base pairs
 - (B) TYPE: nucleic acid
 - (C) STRANDEDNESS: single
 - (D) TOPOLOGY: linear

- (i i) MOLECULE TYPE: other nucleic acid
 - (A) DESCRIPTION: /desc = "primer"

- (x i) SEQUENCE DESCRIPTION: SEQ ID NO:176:

TG TAGAGCAC CACCAAGA

1 8

(2) INFORMATION FOR SEQ ID NO:177:

- (i) SEQUENCE CHARACTERISTICS:
 - (A) LENGTH: 18 base pairs
 - (B) TYPE: nucleic acid
 - (C) STRANDEDNESS: single
 - (D) TOPOLOGY: linear

- (i i) MOLECULE TYPE: other nucleic acid
 - (A) DESCRIPTION: /desc = "primer"

- (x i) SEQUENCE DESCRIPTION: SEQ ID NO:177:

GCATGGTGTG CATCCACT

1 8

-continued

(2) INFORMATION FOR SEQ ID NO:178:

(i) SEQUENCE CHARACTERISTICS:

- (A) LENGTH: 18 base pairs
- (B) TYPE: nucleic acid
- (C) STRANDEDNESS: single
- (D) TOPOLOGY: linear

(i i) MOLECULE TYPE: other nucleic acid

- (A) DESCRIPTION: /desc = "primer"

(x i) SEQUENCE DESCRIPTION: SEQ ID NO:178:

GGACCACTCT GGGAGGTA

1 8

(2) INFORMATION FOR SEQ ID NO:179:

(i) SEQUENCE CHARACTERISTICS:

- (A) LENGTH: 16 base pairs
- (B) TYPE: nucleic acid
- (C) STRANDEDNESS: single
- (D) TOPOLOGY: linear

(i i) MOLECULE TYPE: other nucleic acid

- (A) DESCRIPTION: /desc = "primer"

(x i) SEQUENCE DESCRIPTION: SEQ ID NO:179:

CTCCGATGGA CGCTGG

1 6

(2) INFORMATION FOR SEQ ID NO:180:

(i) SEQUENCE CHARACTERISTICS:

- (A) LENGTH: 18 base pairs
- (B) TYPE: nucleic acid
- (C) STRANDEDNESS: single
- (D) TOPOLOGY: linear

(i i) MOLECULE TYPE: other nucleic acid

- (A) DESCRIPTION: /desc = "primer"

(x i) SEQUENCE DESCRIPTION: SEQ ID NO:180:

CAGCAGTATG TGTTTCCA

1 8

(2) INFORMATION FOR SEQ ID NO:181:

(i) SEQUENCE CHARACTERISTICS:

- (A) LENGTH: 27 base pairs
- (B) TYPE: nucleic acid
- (C) STRANDEDNESS: single
- (D) TOPOLOGY: linear

(i i) MOLECULE TYPE: other nucleic acid

- (A) DESCRIPTION: /desc = "primer"

(x i) SEQUENCE DESCRIPTION: SEQ ID NO:181:

TTTTTTGGAT CCTAAAAGTA TAATCCC

2 7

(2) INFORMATION FOR SEQ ID NO:182:

(i) SEQUENCE CHARACTERISTICS:

- (A) LENGTH: 27 base pairs
- (B) TYPE: nucleic acid
- (C) STRANDEDNESS: single
- (D) TOPOLOGY: linear

(i i) MOLECULE TYPE: other nucleic acid

- (A) DESCRIPTION: /desc = "primer"

(x i) SEQUENCE DESCRIPTION: SEQ ID NO:182:

TTTTTTGGAT CCTAAAAGTA TAATCCC

2 7

-continued

(2) INFORMATION FOR SEQ ID NO:183:

- (i) SEQUENCE CHARACTERISTICS:
 - (A) LENGTH: 11 amino acids
 - (B) TYPE: amino acid
 - (C) STRANDEDNESS: single
 - (D) TOPOLOGY: linear

(i i) MOLECULE TYPE: peptide

(x i) SEQUENCE DESCRIPTION: SEQ ID NO:183:

G l u G l n L y s L e u I l e S e r G l u G l u A s p L e u A s n
 1 5 10

TABLE 1

| LOCUS | RECOMBINATION FRACTION (⊖) | | | | | | | 20 |
|---------|----------------------------|-------|-------|-------|-------|-------|------|----|
| | 0.00 | 0.05 | 0.10 | 0.15 | 0.20 | 0.30 | 0.40 | |
| D14S63 | -∞ | 1.54 | 3.90 | 4.38 | 4.13 | 2.71 | 1.08 | 25 |
| D14S258 | -∞ | 21.60 | 19.64 | 17.19 | 14.50 | 8.97 | 3.81 | |
| D14S77 | -∞ | 15.18 | 15.53 | 14.35 | 12.50 | 7.82 | 2.92 | |
| D14S71 | -∞ | 15.63 | 14.14 | 12.19 | 10.10 | 5.98 | 2.39 | |
| D14S43 | -∞ | 19.36 | 17.51 | 15.27 | 12.84 | 7.80 | 3.11 | |
| D14S273 | -∞ | 12.30 | 11.52 | 10.12 | 8.48 | 5.04 | 1.91 | |
| D14S61 | -∞ | 26.90 | 24.92 | 22.14 | 18.98 | 12.05 | 5.07 | |
| D14S53 | -∞ | 11.52 | 11.41 | 10.39 | 8.99 | 5.73 | 2.51 | |
| D14S48 | -∞ | 0.50 | 1.05 | 1.14 | 1.04 | 0.60 | 0.18 | |

TABLE 2

| LOCUS | PEDIGREE ID | | | | | | | | | | | | | |
|---------------|-------------|-------|--------|-------|------|-------|-----------------|------|------|-------|-------|-------|------|-------|
| | NLB2 | FAD3 | TUR1.1 | FAD4 | RB | FAD1 | D1G12 | BOW | COOK | 683 | Tor42 | QUE | MEX1 | FAD2 |
| D14S63 | 1 | 4 | 7 | 4 | | 5 | | | | | | | 9 | 2 |
| D14S258 | 6 | 6 | 8 | 7 | 4 | 5 | 5 | 6 | 6 | | 7 | 6 | 7 | 6 |
| D14S263 | C | C | B | B | C | C | C | C | C | C | C | B | C | C |
| D14S277 | C | C | C | C | C | C | C | C | C | A | A | C | B | B |
| D14S786 | D | D | H | E | F | E | E | D/F | E | E | E | E | F | D |
| D14S77 | Y | Y | R | S | | P | P | K | H | | C | U | F | A |
| D14S71 | 7 | 7 | 1 | 5 | 7 | 7 | | 6 | 7 | | 3 | 7 | 2 | 6 |
| D14S43 | A | A | I | I | I | E | D | I | I | | C | 1 | D | C |
| D348273 | 6 | 6 | 5 | 5 | 5 | 4 | 4 ₄₅ | 4 | 6 | | 6 | 6 | 5 | 3 |
| D14S76 | 5 | 5 | 5 | 5 | 5 | 6 | 9 | 9 | | | 9 | 1 | 5 | 5 |
| D14S41 | E | E | G | F | | I | | | | | D | | L | F |
| D14853 | F | F | C | F | F | J | C | F | E | | J | D | F | F |
| ETHNIC ORIGIN | Ashk | Ashk | Ital | Ital | Ital | Angi | Angi | Angi | Angi | Amer | FrCan | FrCan | Mex | Ger |
| MUTATION | C410Y | C410Y | M146L | M146L | ND | A246E | ND | ND | ND | H163R | H163R | ND | ND | L286V |

55

60

65

TABLE 3

DNASIS
Simple Homology Region rmp. con [Frame 1]

| No. | Target File | Key | Target | Overlap | Match | Similarities Percentage | | |
|-----|--------------------------------|-----|--------|---------|-------|-------------------------|-----|-----|
| 1 | mamp.con/long [Frame 1] | 1 | 1 | 467 | 465 | 99.57% | | |
| 1 | HUMAN N - MTELPAPLSYFQNAQMS | 10 | 20 | 30 | 50 | 60 | 70 | |
| | EDNHLSTVRSQNDNRERQEHNDRRSLGHP | | | | | | | |
| | EPLELNSGRPQGNSRQVVEQDEED | | | | | | | |
| 1 | MOUSE N - MTEIPAPLSYFQNAQMS | 10 | 20 | 30 | 50 | 60 | 70 | |
| | EDSHSSAIRSQNDSQERQQHQRRLDNPEPI | | | | | | | |
| | SNRQVVEQDEED | | | | | | | |
| 71 | EELTKYGAKHVI | 80 | 90 | 100 | 120 | 130 | 140 | |
| | MLFVPVTL | | | | | | | |
| | CMVVVATI | | | | | | | |
| | KSVSFYTRKDGQLI | | | | | | | |
| | YTPFTEDTETV | | | | | | | |
| | QRALHSILNAAIMI | | | | | | | |
| 71 | EELTKYGAKHVI | 80 | 90 | 100 | 120 | 130 | 140 | |
| | MLFVPVTL | | | | | | | |
| | CMVVVATI | | | | | | | |
| | KSVSFYTRKDGQLI | | | | | | | |
| | YTPFTEDTETV | | | | | | | |
| | QRALHSILNAAIMI | | | | | | | |
| 141 | SVI | 150 | 160 | 170 | 180 | 190 | 200 | 210 |
| | VVMTILLV | | | | | | | |
| | VLYKYRCYKVI | | | | | | | |
| | HAWLI | | | | | | | |
| | ISSLLFFSFI | | | | | | | |
| | YLG | | | | | | | |
| | EVFKTYNVA | | | | | | | |
| | VDYITV | | | | | | | |
| | ALLIWN | | | | | | | |
| | LWLVVGM | | | | | | | |
| 211 | SI | 220 | 230 | 240 | 250 | 260 | 270 | 280 |
| | HWKGPLRL | | | | | | | |
| | QQAYLIMI | | | | | | | |
| | SALMALVFI | | | | | | | |
| | KYLPEW | | | | | | | |
| | AWLILAVI | | | | | | | |
| | S | | | | | | | |
| | VYDLVAVL | | | | | | | |
| | CPKGPLRML | | | | | | | |
| | VE | | | | | | | |
| | TAQERNE | | | | | | | |
| 281 | AI | 290 | 300 | 310 | 320 | 330 | 340 | 350 |
| | HWKGPLRL | | | | | | | |
| | QQAYLIMI | | | | | | | |
| | SALMALVFI | | | | | | | |
| | KYLPEW | | | | | | | |
| | AWLILAVI | | | | | | | |
| | S | | | | | | | |
| | VYDLVAVL | | | | | | | |
| | CPKGPLRML | | | | | | | |
| | VE | | | | | | | |
| | TAQERNE | | | | | | | |
| 351 | HR | 360 | 370 | 380 | 390 | 400 | 410 | 420 |
| | STPESRAAV | | | | | | | |
| | QELSSSIL | | | | | | | |
| | LAGEDPE | | | | | | | |
| | ERGVKLG | | | | | | | |
| | LGLDFIFYS | | | | | | | |
| | VLVGKAS | | | | | | | |
| | ATASGD | | | | | | | |
| | WNTTI | | | | | | | |
| | ACFVAI | | | | | | | |
| | LIGLCL | | | | | | | |
| 421 | TL | 430 | 440 | 450 | 460 | 470 | 480 | 490 |
| | LLLAI | | | | | | | |
| | FKKALP | | | | | | | |
| | ALPISIT | | | | | | | |
| | TFGLV | | | | | | | |
| | FFYFAT | | | | | | | |
| | DYLVQ | | | | | | | |
| | PFMDQL | | | | | | | |
| | A | | | | | | | |
| | FHFQFYI | | | | | | | |
| | -C | | | | | | | |
| 421 | XL | 430 | 440 | 450 | 460 | 470 | 480 | 490 |
| | LLLAI | | | | | | | |
| | YKKGXP | | | | | | | |
| | AXPI | | | | | | | |
| | SIT | | | | | | | |
| | TFGFV | | | | | | | |
| | FXFAT | | | | | | | |
| | DYLVQ | | | | | | | |
| | PFMDQL | | | | | | | |
| | A | | | | | | | |
| | FHFQFYI | | | | | | | |
| | -C | | | | | | | |

TABLE 4

| HUMAN ARMP FUNCTIONAL DOMAINS | | |
|---|--|----|
| Domains (Amino Acid Residue) | Functional Characteristic | 5 |
| 82-100 AA | Hydrophobic | |
| 132-154 AA | Hydrophobic | |
| 164-183 AA | Hydrophobic | |
| 195-213 AA | Hydrophobic | |
| 221-238 AA | Hydrophobic | 10 |
| 244-256 AA | Hydrophobic | |
| 281-299 AA | Hydrophobic | |
| 404-428 AA | Hydrophobic | |
| 431-449 AA | Hydrophobic | |
| 115-119 AA (YTPF) | Phosphorylation Site | |
| 353-356 AA (STPC) | Phosphorylation Site | 15 |
| 300-385 AA | Acid Rich Domain Possible Metal Binding Domain | |
| ANTIGENIC SITES INCLUDING AMINO ACID RESIDUES | | |
| 27-44 | | 20 |
| 46-48 | | |
| 50-60 | | |
| 66-67 | | |
| 107-111 | | |
| 120-121 | | |
| 125-126 | | |
| 155-160 | | 25 |
| 185-189 | | |
| 214-223 | | |
| 220-230 | | |
| 240-245 | | |
| 267-269 | | |
| 273-282 | | 30 |
| 300-370 | | |
| 400-420 | | |

TABLE 5

| MUTATION | ENZYME (effect of mutation) | AMPLIFICATION 0440 #1 | AMPLIFICATION 0440 #2 | ALLELE SPECIFIC 0440 |
|--------------|-----------------------------------|---|--|--|
| M146LEU | BspI (destroy) | 910 (170-S182 F) TCACAGAAGATA CCGAGACT | 911 (170-S182) R CCCAACCATAAGA AGAACAG | |
| MIS 163 Ary | Nla III (destroy) | 927 (intronic) TCTGTACTTTT AAGGGTTGTG | 928 ACTTTCAGAGTAATT CATCANCA | |
| Ala 246 | Dlc I (create) | 849 * GACTCCAGCAGG CATATCT | 892 TGAAATCACAGCC AAGATGAG | |
| Leu 286 Val. | Pvu II (create) | 952 GATGAGACAAGT NCCNTGAA TTAGTGGCTGTT TNGTGTCC | 951 CACCCATTTACAAG TTTAGC | |
| Cys 410 Tys | Allele specific iligo | 893 GTGTGGCCAGGG TAGAGAACT | 885 TGGAGACTGGAAC ACAAC | CCATAGCCTGTTTCGTAGC 890 = WT CCATAGCCTATTTTCGTAGC 891 = MUT |

TABLE 6

| POSITION OF EXONS AND INTRON-EXON BOUNDARIES OF THE ARMP GENE | | | |
|---|--------------------------|--|------------------------------|
| cDNA/mRNA SEQUENCE | | CORRESPONDING GENOMIC SEQUENCE | |
| ARMP (917ver) | Transcript ID CC44ver | Genomic Sequence file ID & position of exon | Comments |
| 1-113bp | N/A | 917-936.gen @ 731-834bp | Alternate 5'UTR |
| N/A | 1-422bp | 917-936.gen @ 1067-1475bp | Alternate 5'UTR |
| 114-195bp | 423-500bp | 932-943.gen @ 589-671bp | |
| 196-335bp | 501-632bp | 932-943.gen @ 759-899bp | 12bp Variably spliced |
| 337-586bp | 633-883bp | 901-912.gen @ 787-1037bp | |
| 587-730bp | 884-1026bp | 910-915.gen @ 1134-1278bp | M146L mutation |
| 731-795bp | 1027-1092bp | 925-913.gen @ 413-478bp | H163R mutation |
| 796-1017bp | 1093-1314bp | 849-892.gen @ 336-558bp | A246E mutation |
| 1018-1116bp | 1315-1413bp | 951-952.gen @ 312-412bp | L286V mutation, variable spl |
| 1117-1204bp | 1414-1501bp | 983-1011.gen @ 61-149bp | |
| 1205-1377bp | 1502-1674bp | 874-984.gen @ 452-625bp | |
| 1378-1497bp | 1674-1794bp | 885-1012.gen @ 431-550bp | C410Y mutation |
| 1498-2760bp | 1795-3060bp | 930-919.gen @ ~10bp-end | last AA, STOP, 3'UTR |

TABLE 7

| MUTATIONS AND POLYMORPHISMS IN THE ARMP GENE | | |
|--|-----------------------------|------------------------------------|
| Nucleotide # in ARMP.UPD | Amino acid # in ARMP.PRO | Comments |
| A→C ₆₈₄ | Met146Leu | Pathogenic, Unique to AD affected. |
| A→G ₇₃₈ | His163Arg | " |
| C→A ₉₈₅ | Ala246Glu | " |
| C→T ₁₀₂₇ | Ala260Val | " |
| C→T ₁₁₀₂ | Ala285Val | " |
| C→G ₁₁₀₄ | Leu286Val | " |

TABLE 7-continued

| MUTATIONS AND POLYMORPHISMS IN THE ARMP GENE | | |
|--|-----------------------------|-------------------------|
| Nucleotide # in ARMP.UPD | Amino acid # in ARMP.PRO | Comments |
| C→G ₁₄₂₂ | Leu392Val | " |
| G→A ₁₄₇₇ | Cys410Tyr | " |
| G→T ₁₆₃ | Phe205Leu | Polymorphism in normals |
| C→A ₁₇₀₀ | non-coding | 3'UTR polymorphism |
| G→A ₂₆₀₁ | non-coding | " |
| delC ₂₆₂₀ | non-coding | " |

TABLE 8

| | | | |
|------|-----|---|-----|
| E5-1 | 1 | MLTFMASDSEEEVCDERTSLMSAESPTPRSC-QEGRQGPEDGE--NTAQWRSQENEED | 55 |
| S182 | 1 | -----MT-ELPAPLSYFQNA-QNSEDNHLSNTV--RSQ-N--D | 31 |
| E5-1 | 56 | G-E--EDFDRYVCS-GVP-----GRPPGL-----E-----XKLTCLKYGAKHVI MLF | 92 |
| S182 | 51 | NRE RQE HND RR--SLGHPEPLSNGRPQGNSRQVVEQDEHXDXKLTCLKYGAKHVI MLF | 86 |
| E5-1 | 93 | VPVTLCMI VVVATI XSVRFYTRKNGQLI YTPFTEDTTPSVGQRLLNS VLNTLI MIVSVI | 149 |
| S182 | 87 | VPVTLCMVVVVATI XSVSFYTRKDGQLI YTPFTEDTSTVGQRALHSI LNAAI MIVSVI | 143 |
| E5-1 | 150 | VVMTIFLVVLYKYRCYKFI HGWLI MS S L M L L F L F T Y I Y L G X V L X T Y N V A M D Y P T L - L | 205 |
| S182 | 144 | VVMTI L L V V L Y K Y R C Y K V I H A W L I I S S L L L L F F F S F I Y L G X V F X T Y N V A V D Y I T V A L | 200 |
| | | ↑ L | |
| | | ↑ R | |
| | | ↓ V | |
| E5-1 | 206 | LT V W N F G A V G M V C I H W K G P L V L Q Q A Y L I M I S A L M A L V F I K Y L F E W S A W V I L G A - I S V | 261 |
| S182 | 201 | L I - W N F G V V G M I S I H W K G P L R L Q Q A Y L I M I S A L M A L V F I K Y L F E W T A W L I L - A V I S V | 255 |
| | | ↑ E | |

TABLE 8-continued

| | | |
|----------|--|-----|
| E5-1 262 | YDLVAVLCPKGPLRKL VETAQERNEPIFPALIYSSAMVWTVGMAKLDP-----S-- | 310 |
| S182 256 | YDLVAVLCPKGPLRMLVETAQERNETLFPALIYSS TMVWLVNMAI GDPEAQR RVSKN | 312 |
| | | |
| E5-1 311 | SQGAL-----QLPY---DP----EME-EDSYDSF-GEP--SYPE----VF EFPLT | 345 |
| S182 301 | SKYNAESTERESQDTVAENDDDGGFSE-EWEAQRD SHLG-PHRSTPESRAAVQE--LS | 365 |
| E5-1 346 | GYP--GEELEEEKRGVKLGLGDFIFYSVLVGKAAATGSGDWNTTLACFVAI LI GLC | 400 |
| S182 366 | SSILAGEDP---EERGVKLGDFIFYSVLVGKAS ATASGDWNTTIACFVAI LI GLC | 420 |
| | | |
| E5-1 401 | LTLLLLAVFKKALPALPISITFGLIFYFSTDNLV RPFMDTLASHQLYI* | 448 |
| S182 421 | LTLLLLAIFKKALPALPISITFGLV FYFATDYL VQPFMDQLAFHQFYI* | 467 |

TABLE 9

| MISSENSE MUTATIONS IN THE PRESENILIN GENES | | | |
|--|---------------|----------|---------------------------------------|
| PRESENILIN I (S182) | | | |
| Codon | location | mutation | phenotype |
| 82 | TM1 | Val→Leu | FAD, onset 55 years * |
| 115 | TM1→TM2 loop | Tyr→His | FAD, onset 37 years * |
| 139 | TM2 | Met→Thr | FAD, onset 49 years * |
| 143 | TM2 | Ile→Thr | FAD, onset 35 years t |
| 146 | TM2 | Met→Leu | FAD, onset 45 years |
| 163 | TM3 interface | His→Arg | FAD, onset 50 years |
| 171 | TM3 | Leu→Pro | FAD, onset 35 years |
| 231 | TM5 | Ala→Thr | FAD, onset 52 years * |
| 246 | TM6 | Ala→Glu | FAD, onset 55 years |
| 260 | TM6 | Ala→Val | FAD, onset 40 years |
| 264 | TM6 | Pro→Leu | FAD, onset 45 years * |
| 285 | TM6→TM7 loop | Ala→Val | FAD, onset 50 years |
| 286 | TM6→TM7 loop | Leu→Val | FAD, onset 50 years |
| 384 | TM6→TM7 loop | Gly→Ala | FAD, onset 35 years t |
| 392 | TM6→TM7 loop | Leu→Val | FAD, onset 25-40 years |
| 410 | TM7 | Cys→Tyr | FAD, onset 48 years |
| PRESENILIN II (E5-1) | | | |
| Codon | location | Mutation | phenotype |
| 141 | TM2 | Asn→Ile | FAD (Volga German), onset 50-65 years |
| 239 | TM5 | Met→Val | FAD (Florence), onset variable |
| 420 | C-terminus | Ile→Thr | FAD (Selkoe) |

*Campion et al., (1995).
t Crutsetal., (1995).

TABLE 10

| MURINE LINES CONTAINING MUTANT OR WILD TYPE HUMAN PRESENILIN TRANSGENES | | | | |
|---|--------------|------------------|------------------|-------------|
| VECTOR TYPE (promoter:polyA) | | | | |
| GENOTYPE (Nickname) | haPrP: haPrP | hPDGF-β: SV40 pA | hβ-Actin: hGH pA | hpGK: PGKpA |
| PSNL1: wild type | transgenic | transgenic | transgenic | newborn |
| PSNL1: Tyr115His** (French mutation) | mice | mice | transgenic | mice |

TABLE 10-continued

| MURINE LINES CONTAINING MUTANT OR WILD TYPE HUMAN PRESENILIN TRANSGENES | | | | |
|---|-----------------|------------------|------------------|-----------------|
| VECTOR TYPE (promoter:polyA) | | | | |
| GENOTYPE (Nickname) | haPrP: haPrP | hPDGF-β: SV40 pA | hβ-Actin: hGH pA | hpGK: PGKpA |
| PSNL1: Met146Leu** (FAD4 mutation) | transgenic mice | transgenic mice | | |
| PSNL1: Met146Leu(tr) | | transgenic mice | | injected |
| PSNL1: His163Arg (603 mutation) | | | | transgenic mice |
| PSNL1: Ala246Glu (FAD1 mutation) | | | | |
| PSNL1: Ala260Val (JPN1 mutation) | | | | |
| PSNL1: Ala285Val (JPN2 mutation) | | | | |
| PSNL1: Leu286Val (Ger/FAD2 mutation) | transgenic mice | | | |
| PSNL1: Leu392Val** (Borras mutation) | | | transgenic mice | |
| PSNL1: Cys410Tyr (MHG1/NIH2 mutation) | | | transgenic mice | |
| PSNL2: wild type | prepared | | transgenic | |
| PSNL2: Asn141Ile (Volga mutation) | injected | | transgenic | |
| PSNL2: Met239Val (FLO10 mutation) | prepared | | transgenic | |

**Mutations associated with onset ≤ 45 years of age.

TABLE 11

| C. elegans transgenes | | |
|-----------------------|-------------------|-------------------|
| Vector | | |
| GENOTYPE | pPD49.3 hsp 16-41 | pPD49.78 hsp 16-2 |
| PSNL1: wild type | transgenic | injected |
| PSNL1: Leu392Val | transgenic | injected |

TABLE 11-continued

| GENOTYPE | C. elegans transgenes | | 5 |
|----------------------------------|-----------------------|-------------------|----|
| | Vector | | |
| | pPD49.3 hsp 16-41 | pPD49.78 hsp 16-2 | |
| PSNL1: Met146Leu | | | 10 |
| + Leu392Val; cis double mutation | prepared | prepared | |
| PSNL2: wild type | prepared | prepared | |
| PSNL2: Asn141Ile | prepared | prepared | |

TABLE 12

Platelet derived growth factor promotor (PDGF) (vector pZEOsV)

a) S182

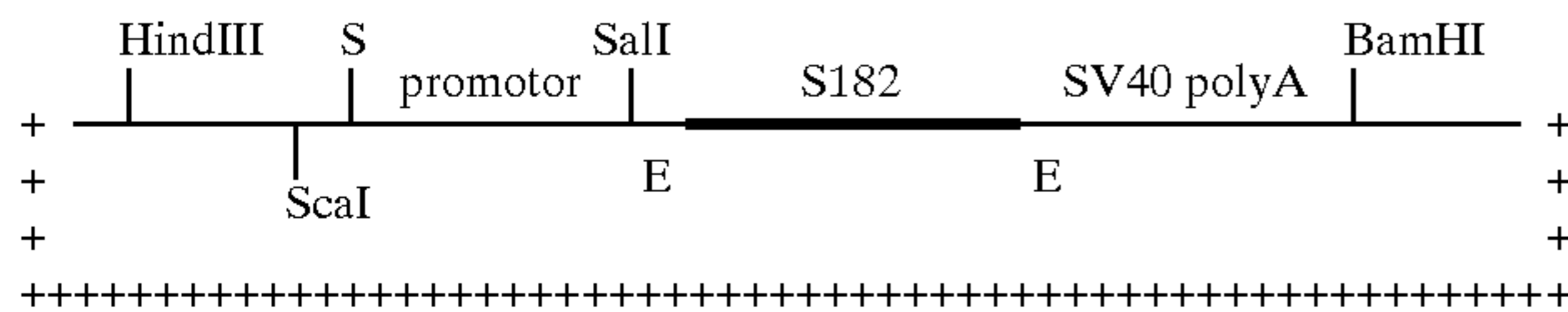

Construct released by HindIII/BamHI digestion

b) S182 Truncated (S182t)

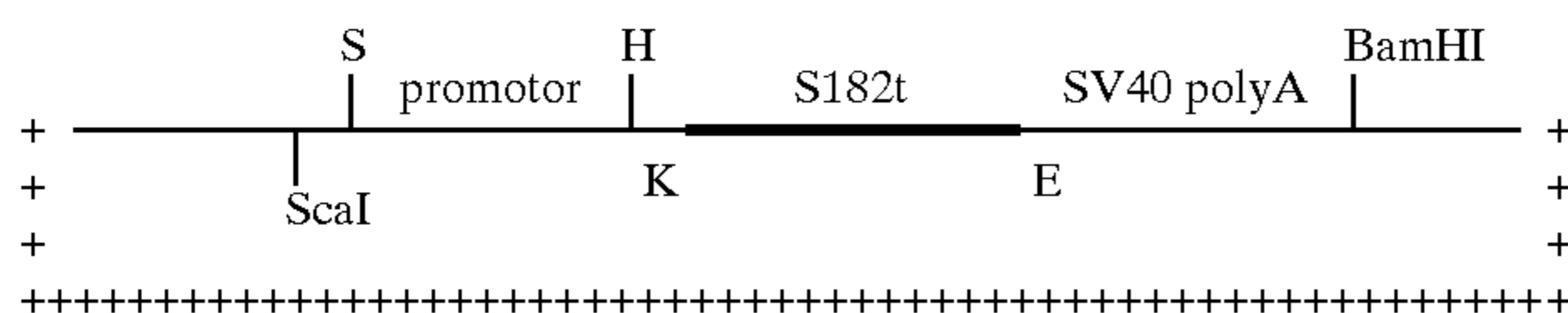

Construct released by ScaI/BamHI digestion

c) E5-1

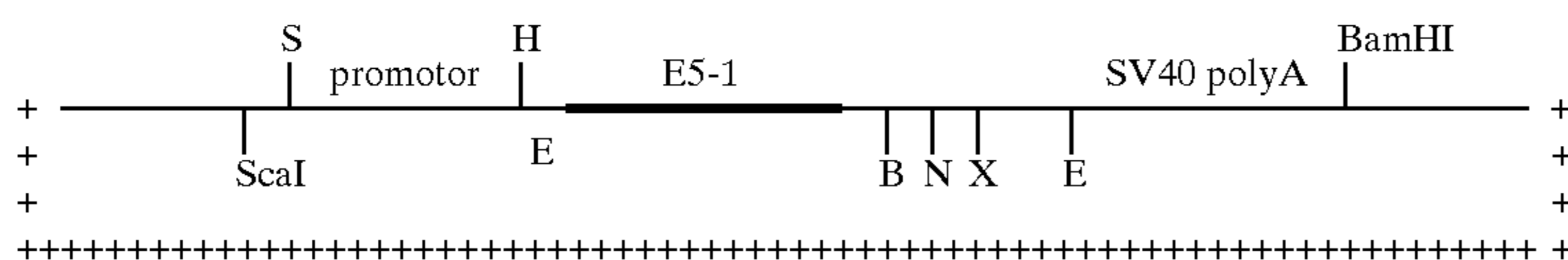

Construct released by ScaI/BamHI digestion

Legend: S = SpeI; H = HindIII; K = KpnI; E = EcoRI; B = BstXI; N = NotI; X = XhoI

β actin promotor (vector pGem11 Zf*)

a) S182

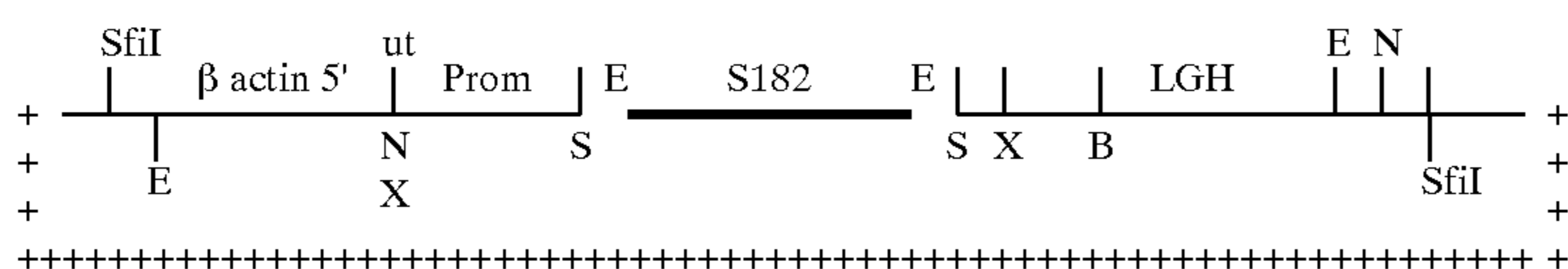

b) S182 Truncated (S182t)

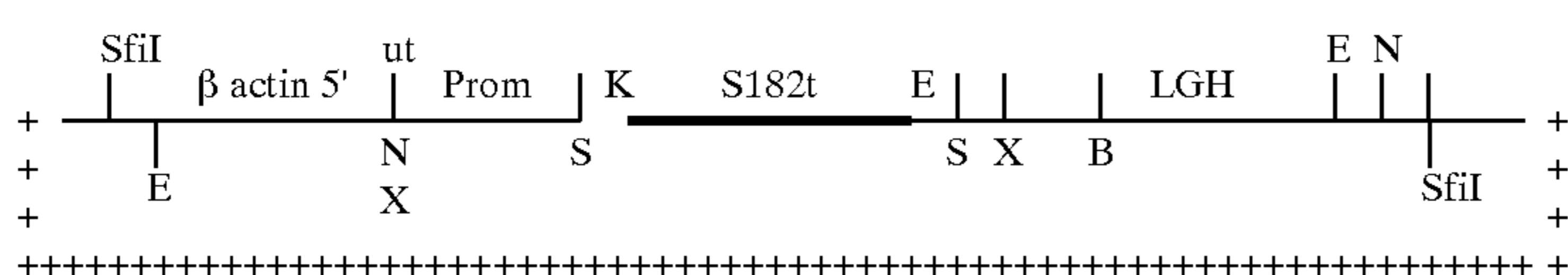
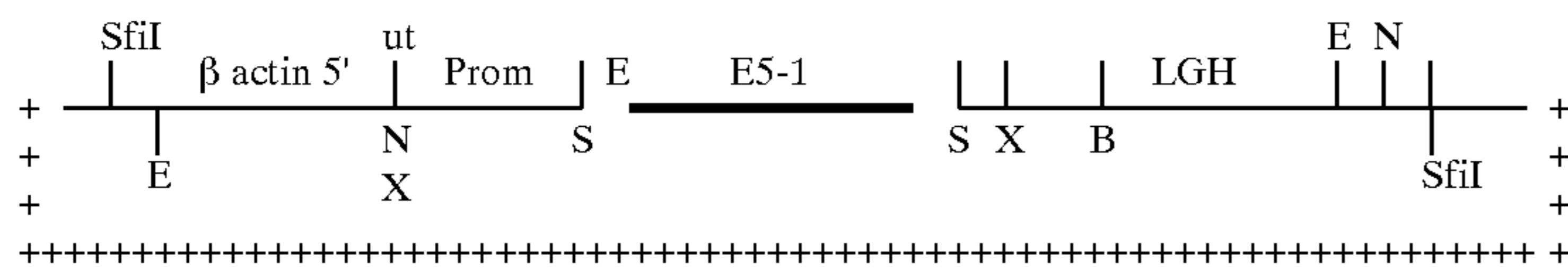

TABLE 12-continued

c) E5-1



Legend: ut = untranslate; Prom = promotor; E = EcoRI; N = NotI; S = Sall; X = XhoI B = BamHI; K = KpnI

Constructs released by SfiI digestion

Phosphoglycerate kinase promotor construct (PGK) (vector pPOP)

a) S182

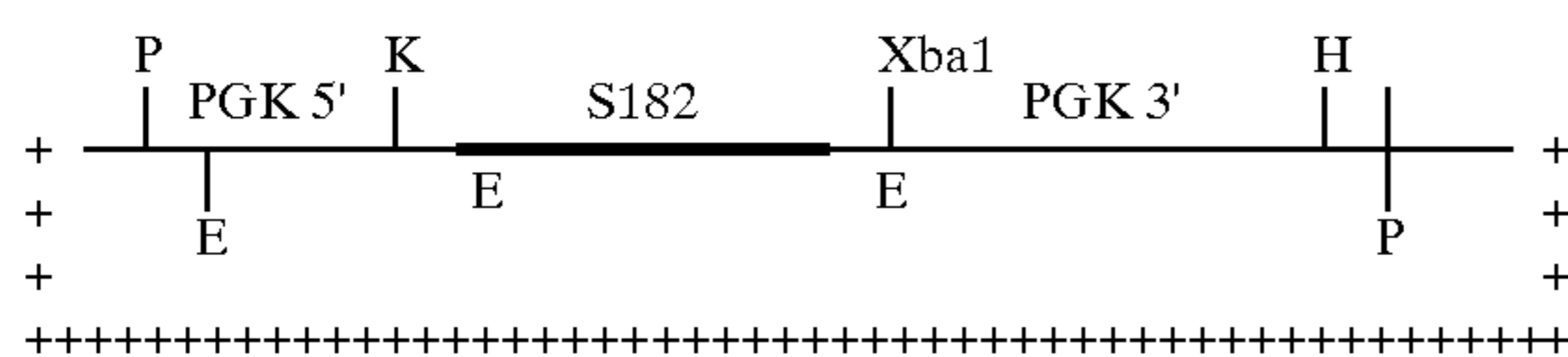

Construct released by PvuII/HindIII digestion

b) S182 Truncated (S182t)

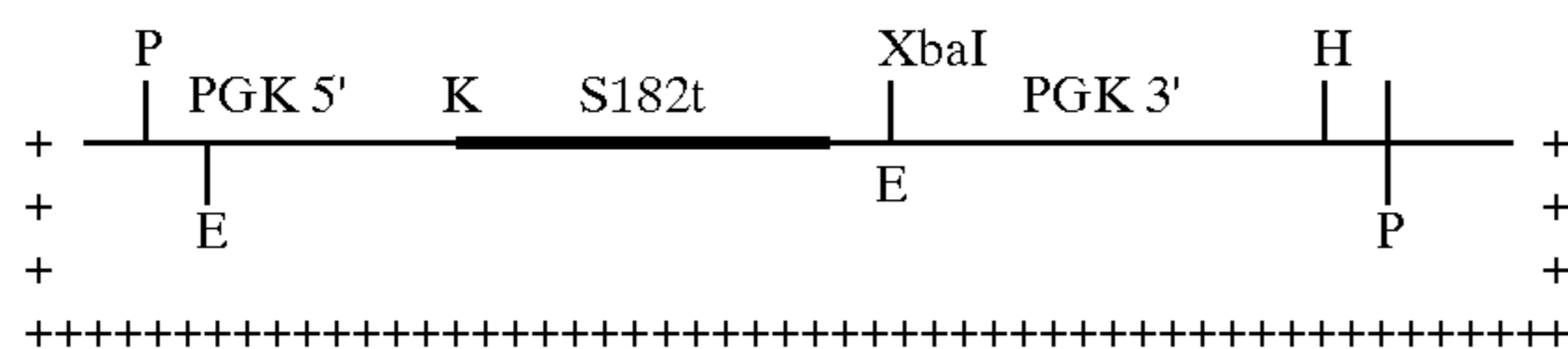

Construct released by PvuII/HindIII digestion

c) E5-1

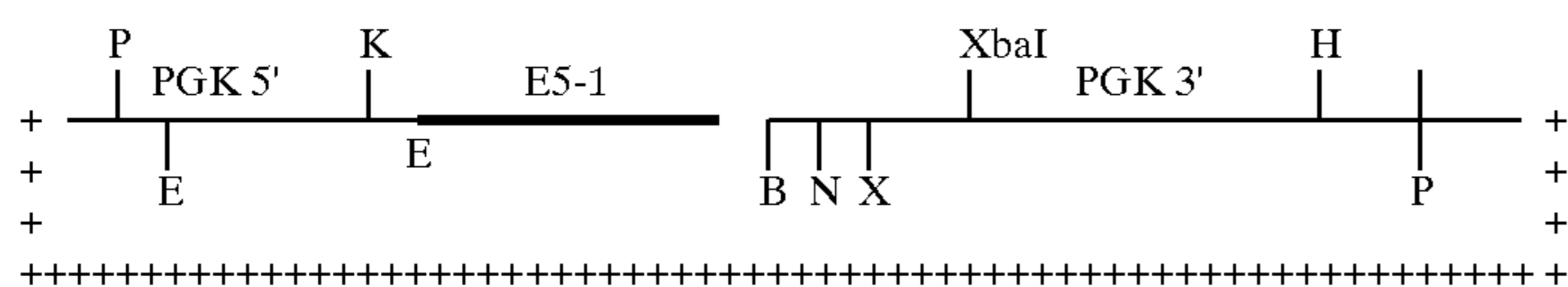

Construct released by PvuII digestion

Legend: P = PvuII; E = EcoRI; K = KpnI; B = BstXI; N = NotI; X = XhoI; H = HindIII

TABLE 13

| Gene name (official) | UofI clone ID | EST in database | Putative gene function |
|---|--|--|---|
| RabII | ps11y2h-9 | X56740 X53143 | Protein/vesicle traffic in ER/Golgi. NB possible relationship to processing of membrane proteins such as β APP and Notch with resultant overproduction of toxic A β peptides (esp. neurotoxic A $\beta_{1-42(43)}$ isoforms) (Scheuner, et al, 1995). |
| retinoid X receptor-B; nuclear receptor co- regulator; MHCclass I regulatory element | ps11y2h23b | m84820 x63522 m81766 | Gene involved in inter-cellular signalling - NB possible relationship to intercellular signalling function mediated by <i>C. elegans</i> sel12 (homologue of mammalian presenilins) and <i>C. elegans</i> Notch/lin-12 (transcription activator). |
| unknown gene | ps11y2h-6 ps11y2y10b ps11y2h17h2 ps11y2h24 ps11y2h25 | F08730 T18858 H17245 T06654 T77214 h24294 M62015 | Weak homology to Cyclic AMP response element binding protien (CREB) involved in transcriptional responses to extracellular signals as a second messenger pathway. Strong homology to p120 (NOL) protein also involved in transcription and cell cycle |

TABLE 13-continued

| Gene name (official) | UofT clone ID | EST in database | Putative gene function |
|--------------------------|--|---|---|
| | | T87427 G04019 | events. Note that these transcriptional event regulatory effects are similar to those postulated for Notch/lin-12 mediated effects on intercellular signalling. Activation of genes (eg β APP) causing over-expression of β APP mRNA has been shown in subjects with mutations in the presenilins (Querforth et al, 1995). Modulation of this aberrant transcriptional activation could be used as a therapeutic target to correct abnormalities in the expression of genes (including β APP and other genes) and thereby prevent/improve the symptoms of AD. |
| unknown gene (cont'd) | ps11y2h-6 ps11y2y10b ps11y2h17h2 PS1LY2H24 ps11y2h24 (cont'd) | F08736 T18858 H17245 ETC (cont'd) | Weak homology to plakophilin a protien involved in stabilization of the cytoskeletal fibrillar proteins Note that more than one member of the is gene family was isolated, suggesting a family of genes interacting differentially with different presenilins. Note that defects in the cytoskeleton (ie paired helical filaments and neurofibrillary tangles) are a major neuropathologic hallmark of AD. |
| antisecretory factor | ps11y2h-29 ps11y2h-31 | U24707 | Secretion of fluid in gut, unknown in brain. |
| unknown gene | ps11y2h-35 | R12984 | homology down to yeast, function = unknown. |
| cytoplasmic chaperonin | ps11y2h-27 | U17104 X74801 | Chaperonin containing TCP-1 |
| unknown gene | ps11y2h-41 | T64843 F12194 | unknown ESTs. Note: this gene product reacts strongly with both PS-1 and PS-2 which argues for a real effect related to the shared biochemical effects of PS-1 and PS-2 causing AD. |
| unknown gene | ps1y12h-17l | D55326 | expressed repeat sequence |

TABLE 14

File1: dros.concensus (1-541) vs File2: PS · 1 (s182) (1-468) Matching Percentage: 53%
 ^ = S182/E5 · 1 mutations * = alternate splice: G384->A384 and in frame fusion to E399

| | | |
|-----|--|-----|
| 1 | MAAVNLQASCSSGL—A—SEDDA—N—VGSQIGAAERLERPPRRQQQRNN | 50 |
| 1 | MTE—LPAPLSYFQNAQMS EDNHL SNTVRS QNDNRERQEHNDRR | 50 |
| 51 | YGSSNQDQPDAAILAVPNVVMREPCGS—RPSRLTGGGGSGGPPPTN—EM | 100 |
| 51 | —S—LGHPEPL—SNGRQP—GN—SRQVVEQDEE | 100 |
| 101 | E—EEQGLKYGAQHVIKLFVPSL CMLVVVATINSISFYNST—DVYLLYT | 150 |
| 101 | EDEELTLKYGAKHVI MLFVPVTL CMVVVATI KSVS FY—TRKDGQLIYT | 150 |
| 151 | PFHEQSPEPSVKFW—SALANSLILMSVVVMTFLLI VLYKKRCYRI | 200 |
| 151 | PFTEDTETVGQRALHSI L—NAAIMI SVI VVMTILLVLYKYRCYKV | 200 |
| 201 | I HGWLI LSSFMLLFI FTLYLEELL RAYNI PMDYPT—ALLIMWNFGVVGM | 250 |
| 201 | I HAWLI ISSLLLLFFSFI YLGEVFKTYNVAVDYI TVALLI—WNFGVVGM | 250 |

TABLE 14-continued

File1: dros.concensus (1-541) vs File2: PS · 1 (s182) (1-468) Matching Percentage: 53%
 ^ = S182/E5 · 1 mutations * = alternate splice: G384->A384 and in frame fusion to E399

| | | |
|-----|--|-----|
| 251 | MSIHWQGPLRLQGGYLI FVAALMALVFI KYLP EWTAWAVLAAI SIWDLIA | 300 |
| 251 | ISIH WKGPLRL LOOAYLI MISALMALVFI KYLP EWTAWLI LAVIS VYDLVA | 300 |
| 301 | VLS PRGPLXILVETAQERNEQIFPALI YSSTVVYALVNTVT —PQQSQAT | 350 |
| 301 | VLC PKGPLRMLVETAQERNETLFPALI YSSTMVW—LVNMAEGDPEA—QRR | 350 |
| 351 | ASSSPSSSN—STTTTRATQNSLASPEAAAASGQRTGNSHPRQNQRDDGS | 400 |
| 351 | VSKN—SKYNAESTE—RESQDTVA—ENDD—G—GFSEEWEAQRD—S | 400 |
| 401 | VLATEGMPLV—TFKSNLRGNAE AAGFTQEWSANLSERVARRQIEVQSTQS | 450 |
| 401 | HL—G—PHRSTPES—R—A—AV—QE—LS—S—S | 450 |
| 451 | GNAQRSNEYRTVTAPDQNHPDGQEERGI KLG LGDFI FYSVLVGKAS—S | 500 |
| 451 | ILAG—E—D—P—EERGVKLG LGDFI FYSVLVGKAS ATAS | 500 |
| 501 | YGDWTT T I ACFVAI LI GLCLTLLLLAI WRKALPALPISITFGLIFCFATS | 550 |
| 501 | —GDWNT T I ACFVAI LI GLCLTLLLLAI FKKALPALPISITFGLVIFYFATD | 550 |
| 551 | AVVKPFMED—LSAK—QVF—I * | 600 |
| 551 | YL VQPFM—DQL—AFHQ—FYI * | 600 |

What is claimed is:

1. An isolated polynucleotide which encodes a human presenilin II (PS2) protein comprising the amino acid sequence shown in SEQ ID NO:137, or a splice variant thereof.
2. The polynucleotide of claim 1, said polynucleotide having the sequence depicted in SEQ ID NO:136.
3. The polynucleotide of claim 1, comprising the nucleic acid sequence shown in SEQ ID NO:136.
4. The polynucleotide of claim 1, which is a polydeoxyribonucleotide.
5. The polynucleotide of claim 1, which is a polyribonucleotide.
6. An isolated polynucleotide contained in ATCC Deposit No. 97214, said polynucleotide encoding human presenilin II (SEQ ID NO:137).
7. An isolated polynucleotide comprising at least 12 to 2285 nucleotides of human presenilin II (PS2) gene (SEQ ID NO:136) or a complement thereof.
8. The polynucleotide of claim 7, which is selected from the group consisting of SEQ ID NO:161, SEQ ID NO:162, SEQ ID NO:163, SEQ ID NO:164, SEQ ID NO:171, SEQ ID NO:172, SEQ ID NO:173, SEQ ID NO:174, SEQ ID NO:175; SEQ ID NO:176, SEQ ID NO:177 and SEQ ID NO:178.
9. An isolated polynucleotide which encodes a mutant of human presenilin II (PS2) protein (SEQ ID NO:137), or a splice variant thereof, said mutant comprising amino acid substitutions at positions 141, 239, and/or 420 of SEQ ID NO:137.
10. The polynucleotide of claim 9, which is a polydeoxyribonucleotide.
11. The polynucleotide of claim 9, which is a polyribonucleotide.

12. The polynucleotide of claim 9, wherein said amino acid substitution is selected from the group consisting of N141I, M239V and I420T.
13. The polynucleotide of claim 9, wherein the amino acid substitution is at position 141.
14. The polynucleotide of claim 13, wherein the Asn at position 141 is substituted by Ile.
15. The polynucleotide of claim 9, wherein the amino acid substitution is at position 239.
16. The polynucleotide of claim 15, wherein the Met at position 239 is substituted by Val.
17. The polynucleotide of claim 9, wherein the amino acid substitution is at position 420.
18. The polynucleotide of claim 17, wherein the Ile at position 420 is substituted by Thr.
19. The mutant polynucleotide of claim 9, wherein the human PS2 protein is encoded by SEQ ID NO:136 and wherein said mutant polynucleotide further lacks the triplet GAA codon at nucleotide positions 1338–1340.
20. The mutant polynucleotide of claim 9, which further lacks amino acid residues 263–296.
21. An isolated polynucleotide defined by SEQ ID NO:136, said polynucleotide lacking the triplet GAA codon at nucleotide positions 1338–1340.
22. An isolated polynucleotide which encodes a human presenilin II (PS2) protein (SEQ ID NO:137), or a splice variant thereof which lacks amino acids 263–296.
23. A recombinant vector comprising a polynucleotide encoding human presenilin II (PS2) protein (SEQ ID NO:137).
24. A host cell comprising the recombinant vector of claim 23.
25. A process for recombinantly producing human presenilin II (PS2) protein, comprising culturing the host cell of

235

claim **24** under conditions whereby the PS2 protein is expressed and isolating the PS2 therefrom.

26. A recombinant vector comprising an isolated polynucleotide which encodes a mutant of human presenilin II (PS2) protein (SEQ ID NO:137), or a splice variant thereof, 5 said mutant comprising amino acid substitutions at positions 141, 239, and/or 420 of SEQ ID NO:137.

27. The recombinant vector of claim **26**, wherein the amino acid substitution is selected from the group consisting of N141I, M239V, and I420T. 10

28. A host cell comprising the recombinant vector of claim **27**.

236

29. A process for recombinantly producing mutant human presenilin II (PS2) protein, comprising culturing the host cell of claim **28** under conditions whereby the PS2 protein is expressed and isolating the PS2 therefrom.

30. A host cell comprising the recombinant vector of claim **26**.

31. A process for recombinantly producing human presenilin II (PS2) protein, comprising culturing the host cell of claim **30** under conditions whereby the PS2 protein is expressed and isolating the PS2 therefrom. 10

* * * * *