



US 20230345299A1

(19) **United States**

(12) **Patent Application Publication**
Haider et al.

(10) **Pub. No.: US 2023/0345299 A1**

(43) **Pub. Date: Oct. 26, 2023**

(54) **SYSTEMS AND METHODS OF REQUESTING BUFFER STATUS FOR WIRELESS P2P TRAFFIC**

Publication Classification

(51) **Int. Cl.**
H04W 28/02 (2006.01)
(52) **U.S. Cl.**
CPC *H04W 28/0278* (2013.01)

(71) Applicant: **Meta Platforms Technologies, LLC**,
Menlo Park, CA (US)

(72) Inventors: **Muhammad Kumail Haider**,
Sunnyvale, CA (US); **Chunyu Hu**,
Saratoga, CA (US)

(57) **ABSTRACT**

An access point may include one or more processors. The one or more processors may be configured to generate a first frame to trigger a receiver device to send a response frame that includes buffer status data corresponding to wireless traffic between the receiver device and another device. The one or more processors may be configured to wirelessly transmit, via a transmitter, the generated first frame to one or more devices.

(21) Appl. No.: **18/124,776**

(22) Filed: **Mar. 22, 2023**

Related U.S. Application Data

(60) Provisional application No. 63/333,822, filed on Apr. 22, 2022, provisional application No. 63/333,872, filed on Apr. 22, 2022.

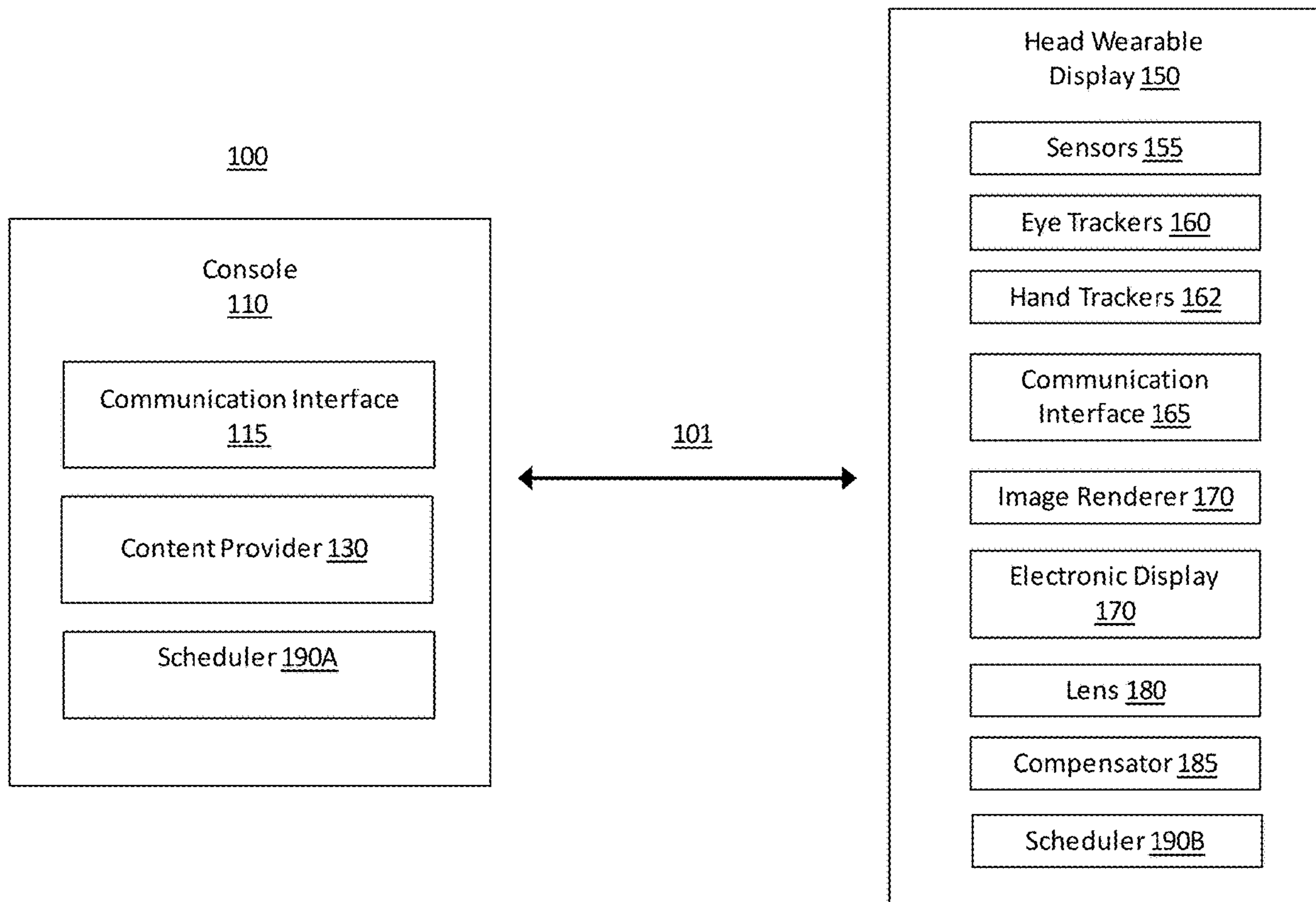

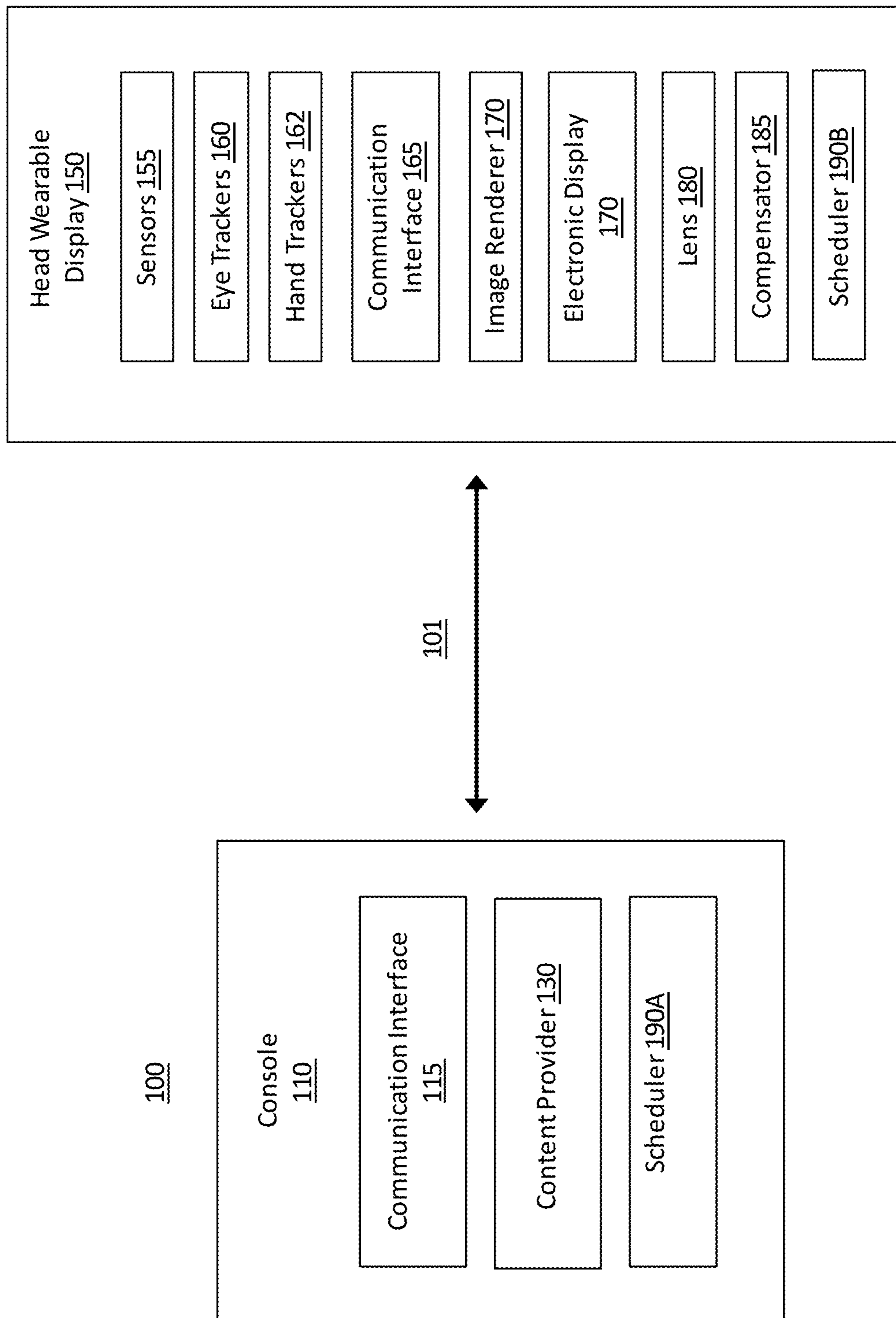

FIG. 1

150

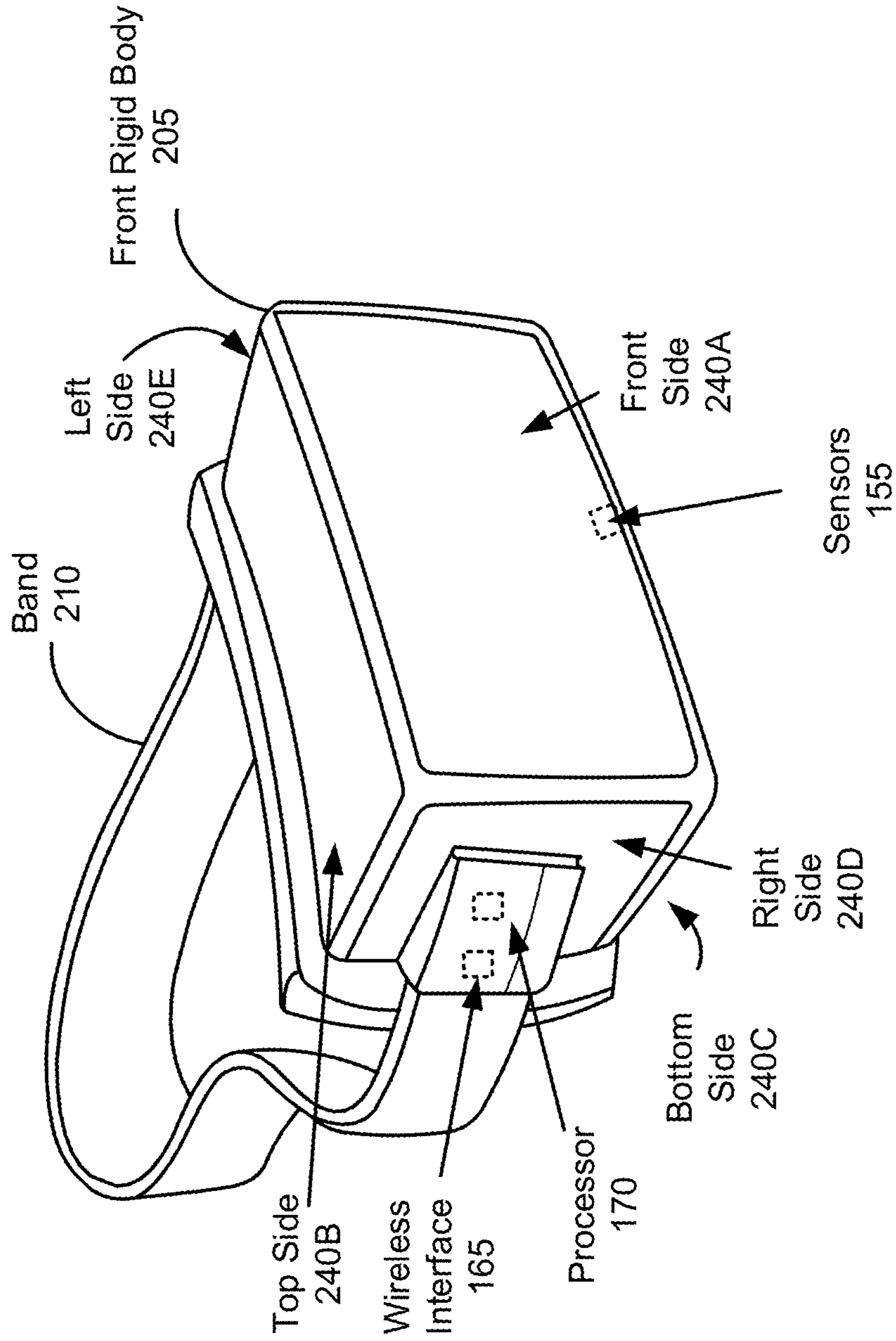

FIG. 2

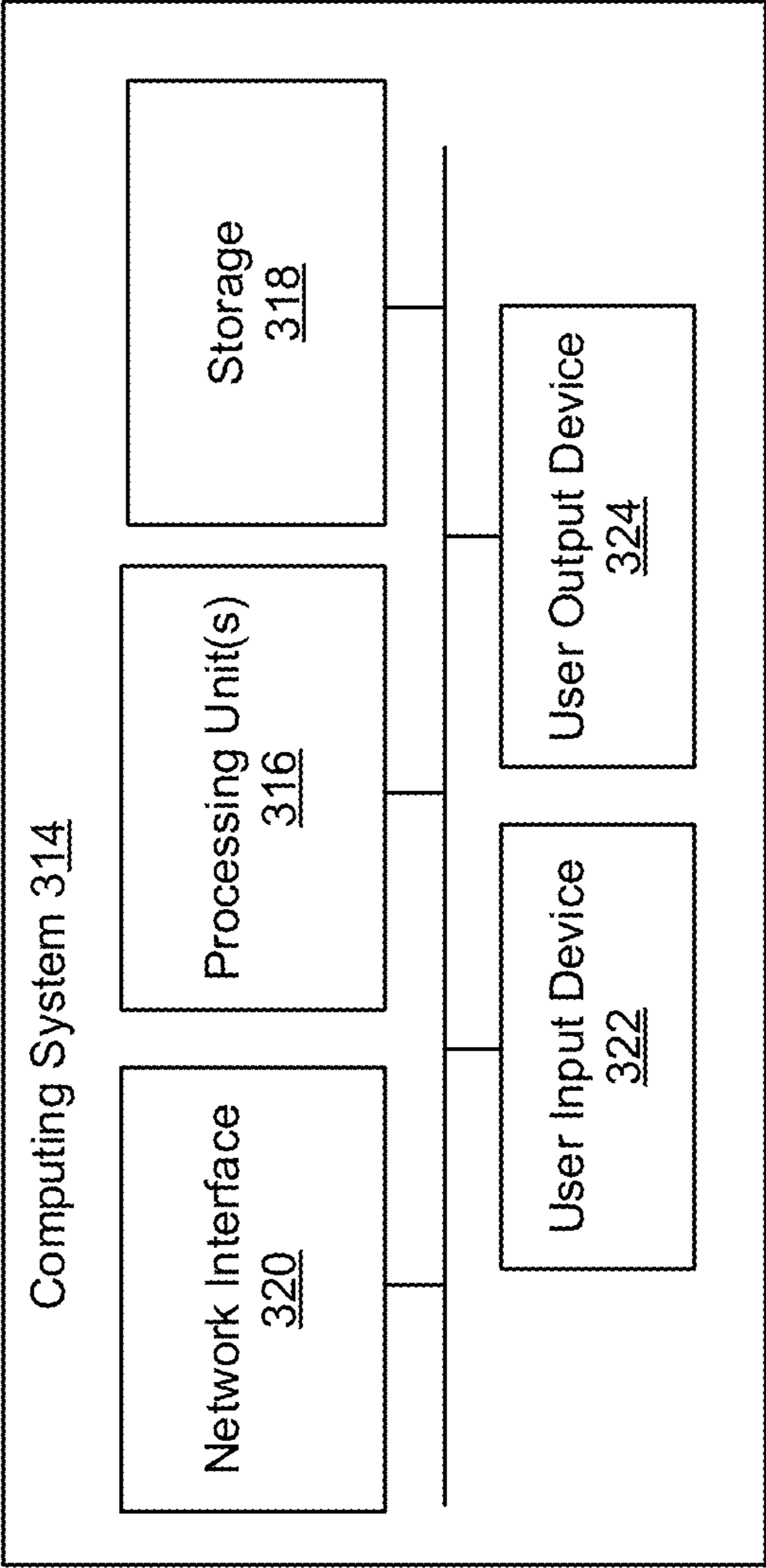

FIG. 3

400

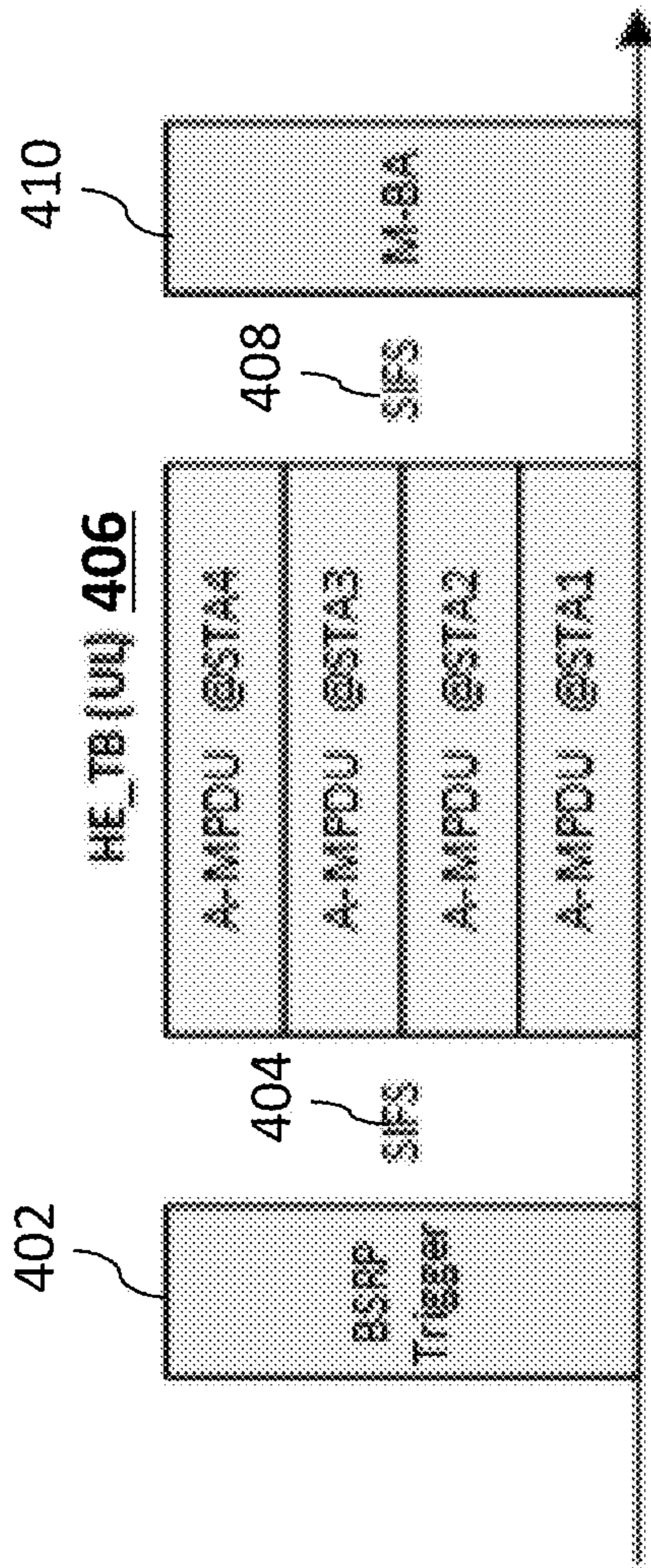

FIG. 4A

450

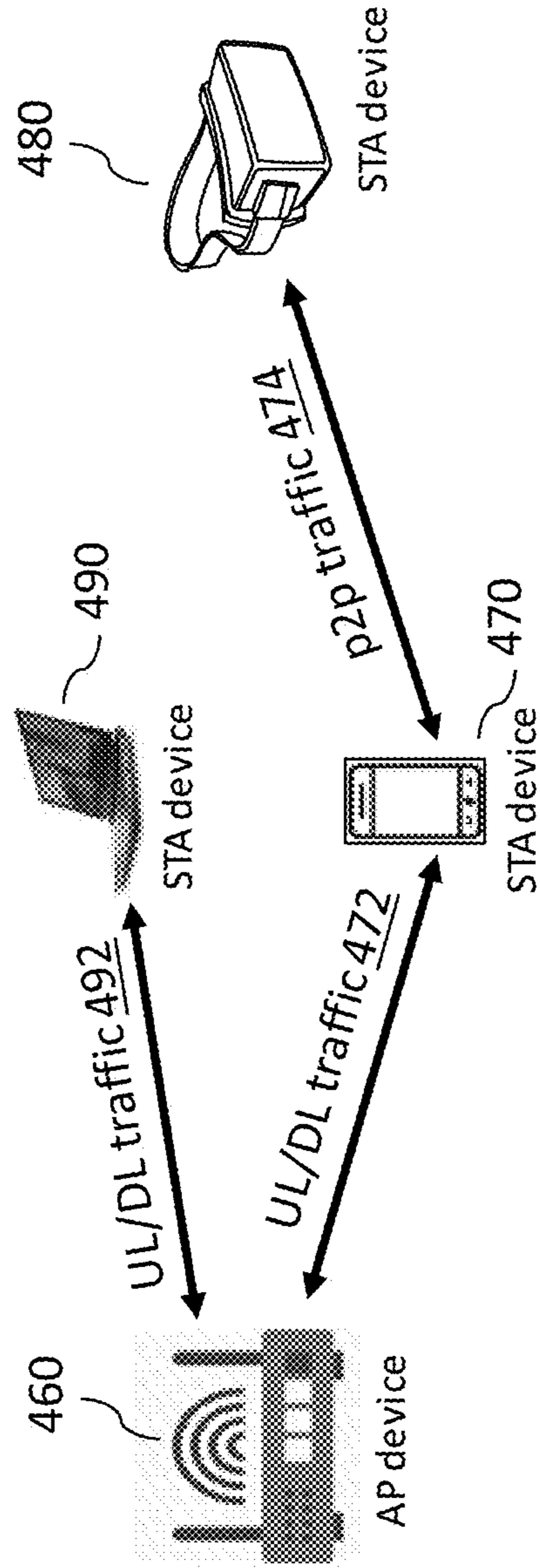

FIG. 4B

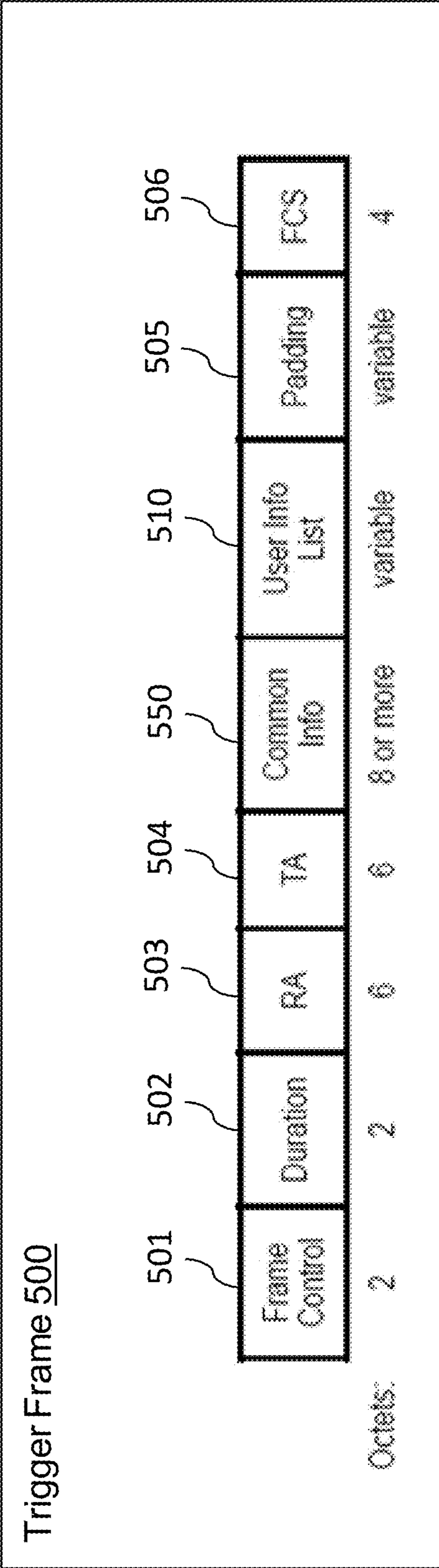

FIG. 5A

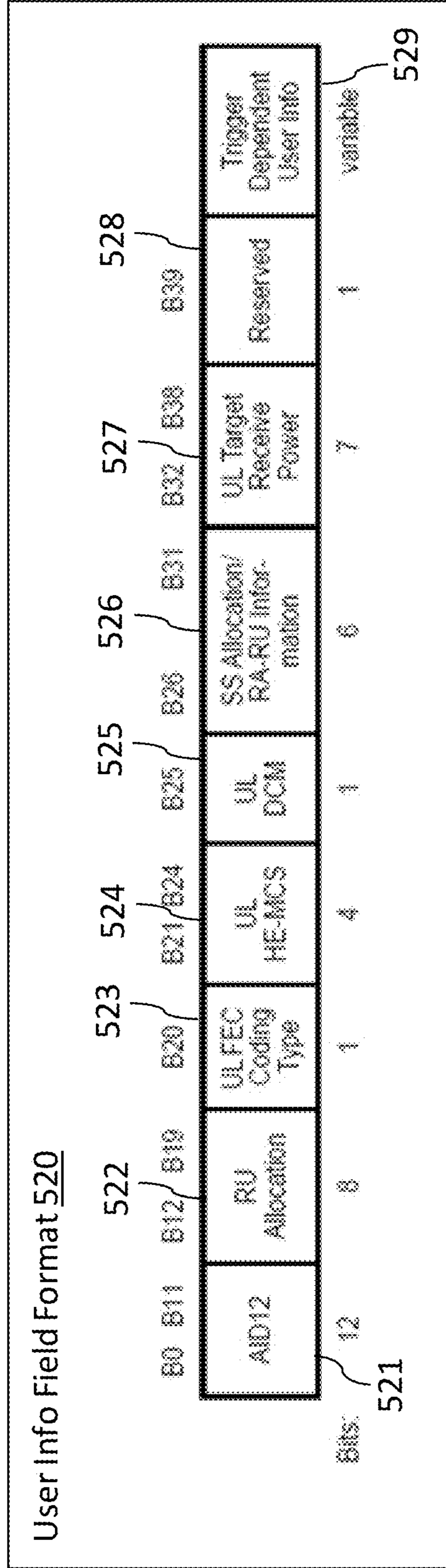

FIG. 5B

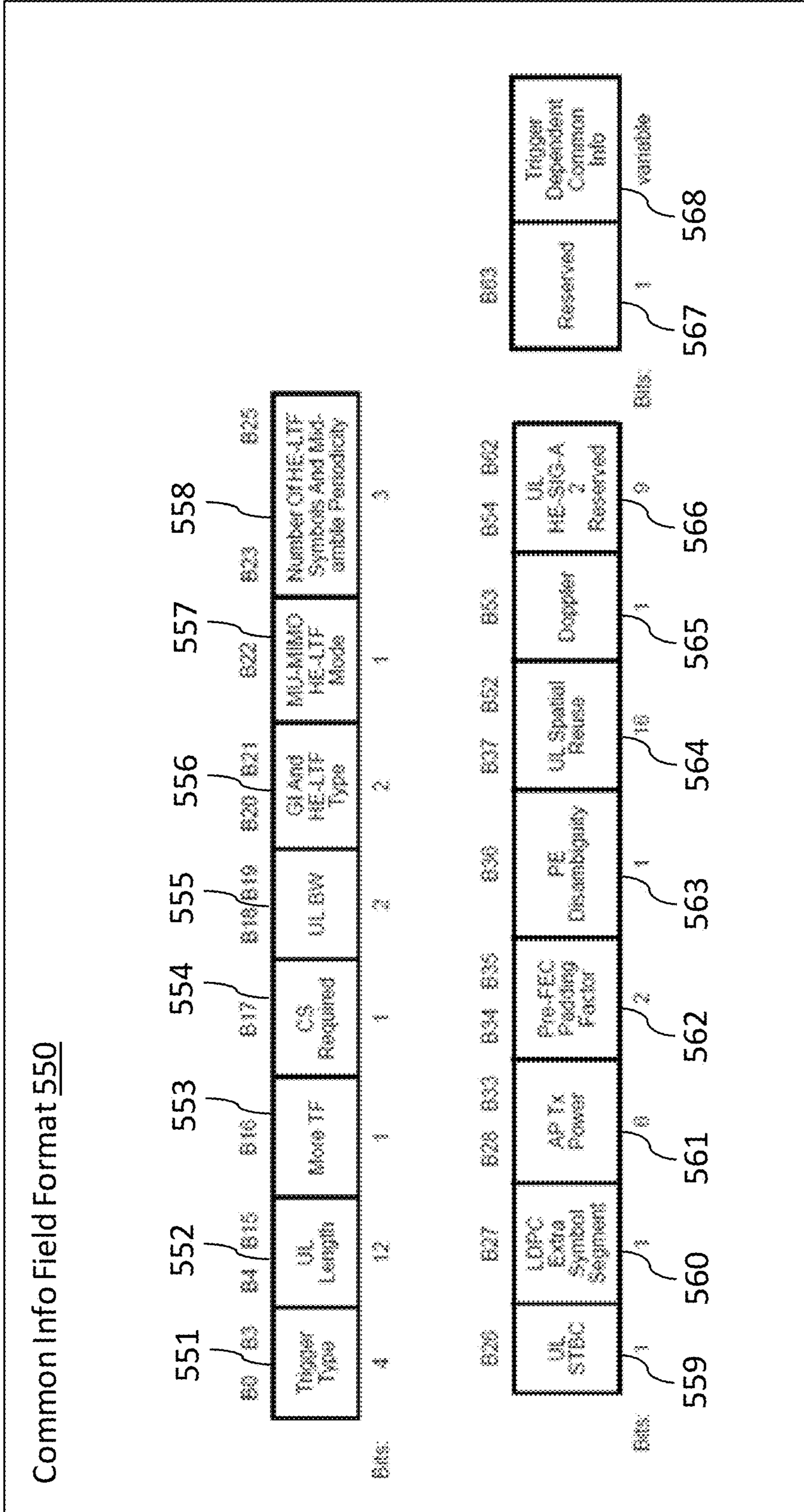

FIG. 5C

Trigger Type Subfield Encoding 590

Trigger Type subfield value	Trigger frame variant
0	Basic
1	Beamforming Report Poll (BFRP)
2	MU-BAR
3	MU-RTS
4	Buffer Status Report Poll (BSRP)
5	GCR MU-BAR
6	Bandwidth Query Report Poll (BQRP)
7	NDP Feedback Report Poll (NFRP)
8-15	Reserved

592

FIG. 5D

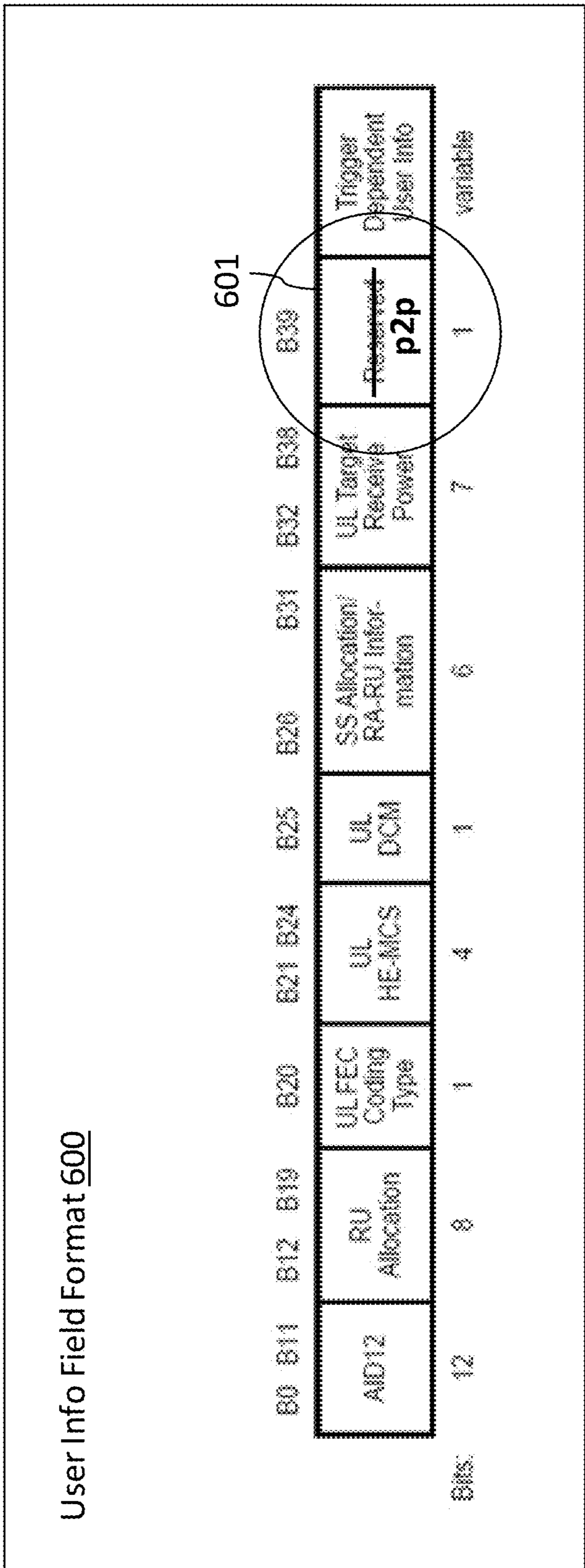

FIG. 6

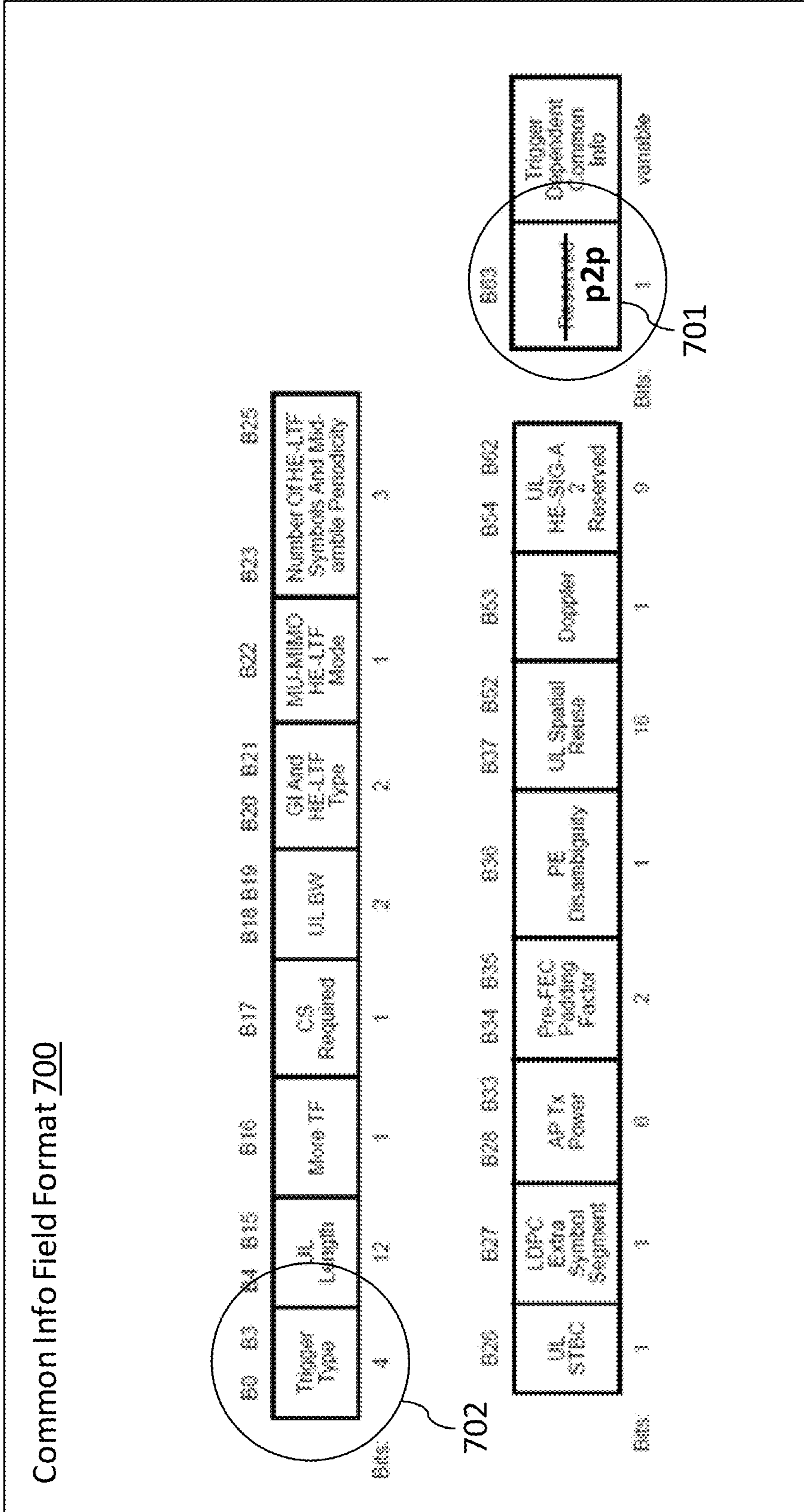

FIG. 7

Trigger Type Subfield Encoding 800

Trigger Type subfield value	Trigger frame variant
0	Basic
1	Beamforming Report Poll (BFRP)
2	MU-BAR
3	MU-RTS
4	Buffer Status Report Poll (BSRP)
5	GCR MU-BAR
6	Bandwidth Query Report Poll (BQRP)
7	NDP Feedback Report Poll (NFRP)
$N (8 \leq N \leq 15)$	BSRP-p2p

802

FIG. 8

900

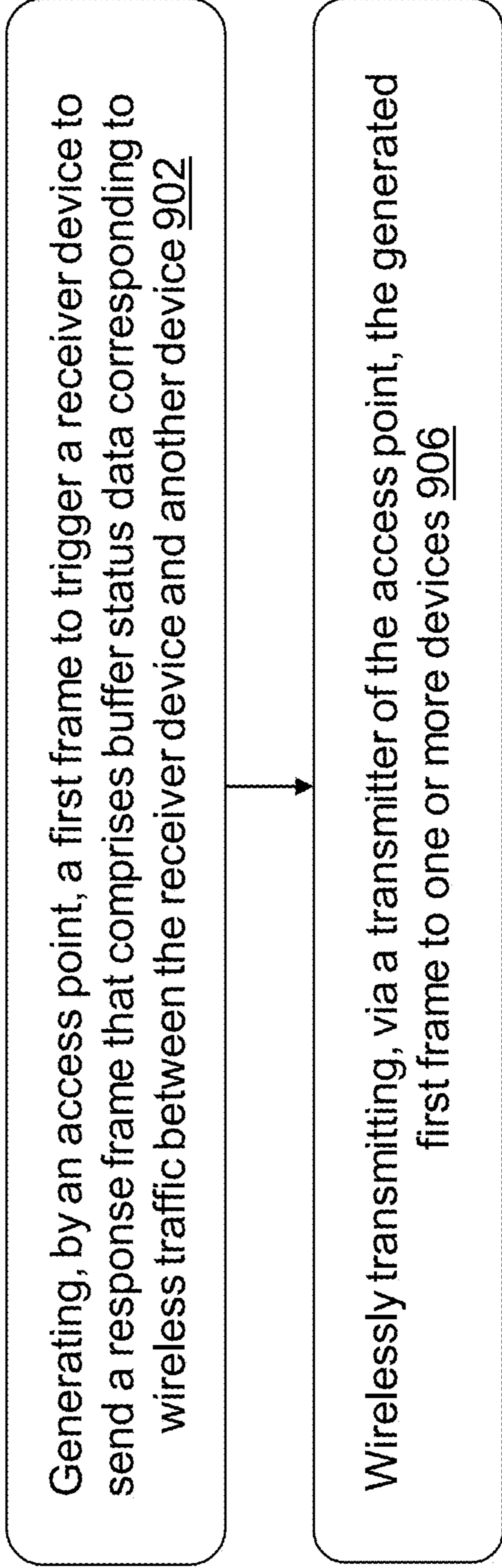

FIG. 9

QoS Control Field Format 1000

	1001	1002	1003	1004	1005
	Bits 0-3		Bit 4	Bits 5-10	Bit 7
1010	Bits 0-3	Bit 4	Bits 5-10	Bit 7	Bits 8-15
	TID	1	Ack Policy Indicator	A-MSDU Present	Queue Size
1020	Applicable frame (sub) type	QoS Data and QoS Data+CF-Ack frame sent in a nonmesh BSS by non-AP STAs that are not a TPU buffer STA or a TPU sleep STA	QoS Null frames sent in a nonmesh BSS by non-AP STAs that are not a TPU buffer STA or a TPU sleep STA		
	TID	1	Ack Policy Indicator	Reserved	Queue Size

FIG. 10A

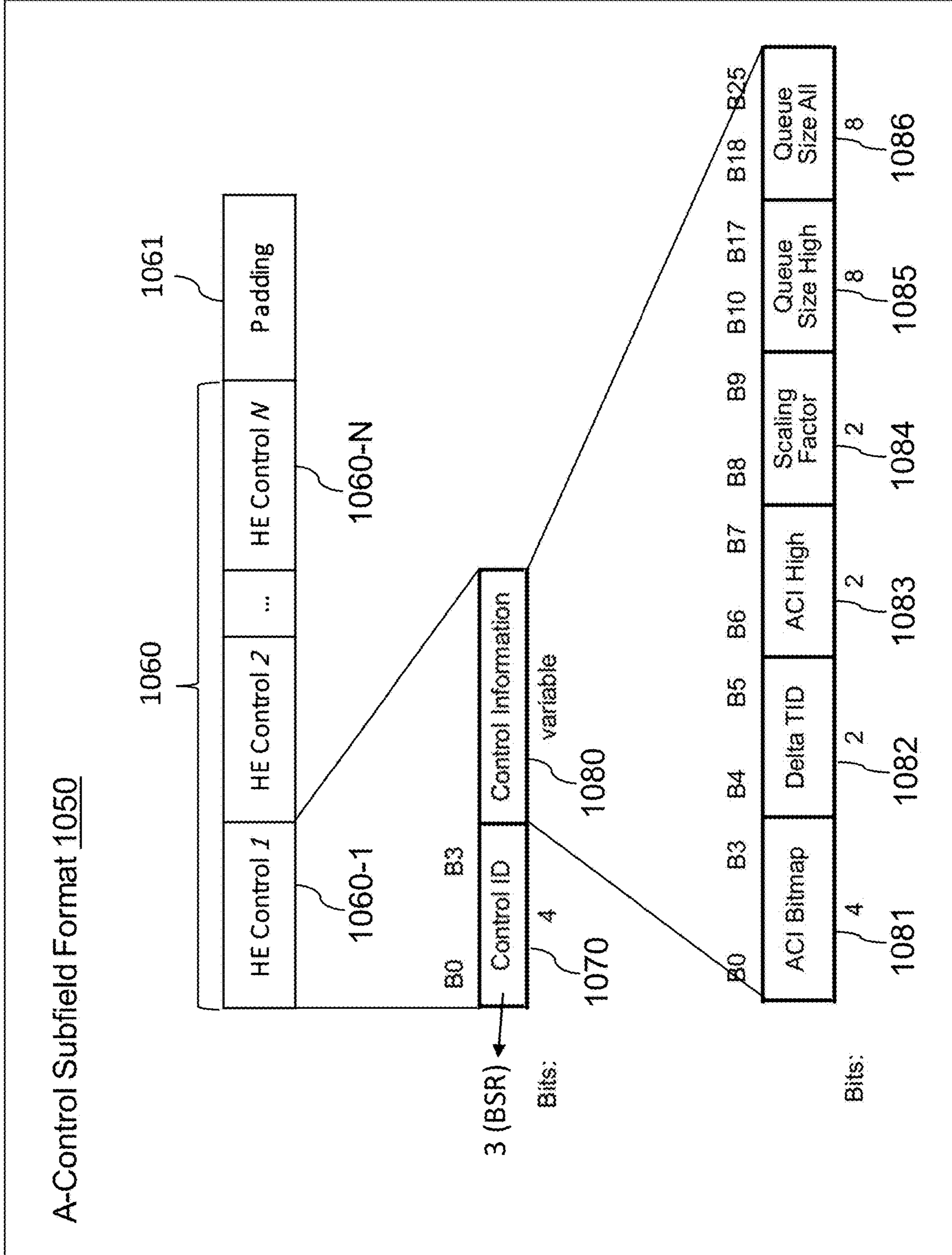

FIG. 10B

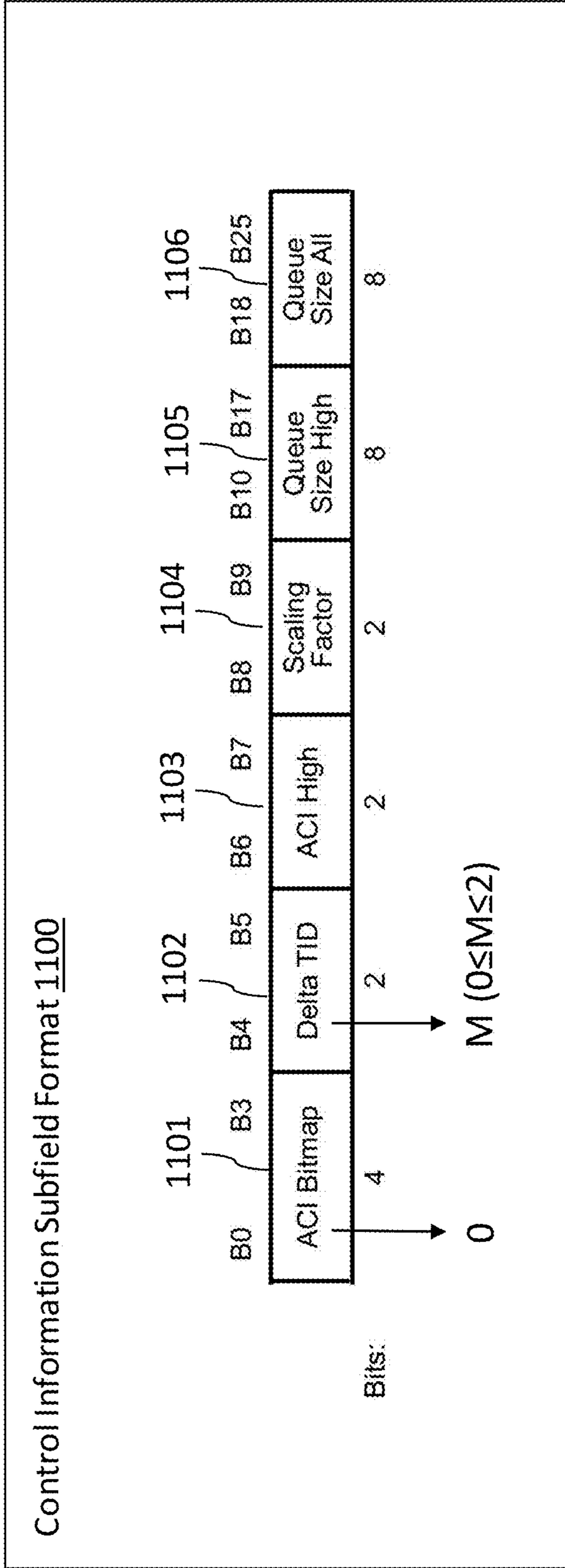

FIG. 11

QoS Control Field Format 1200

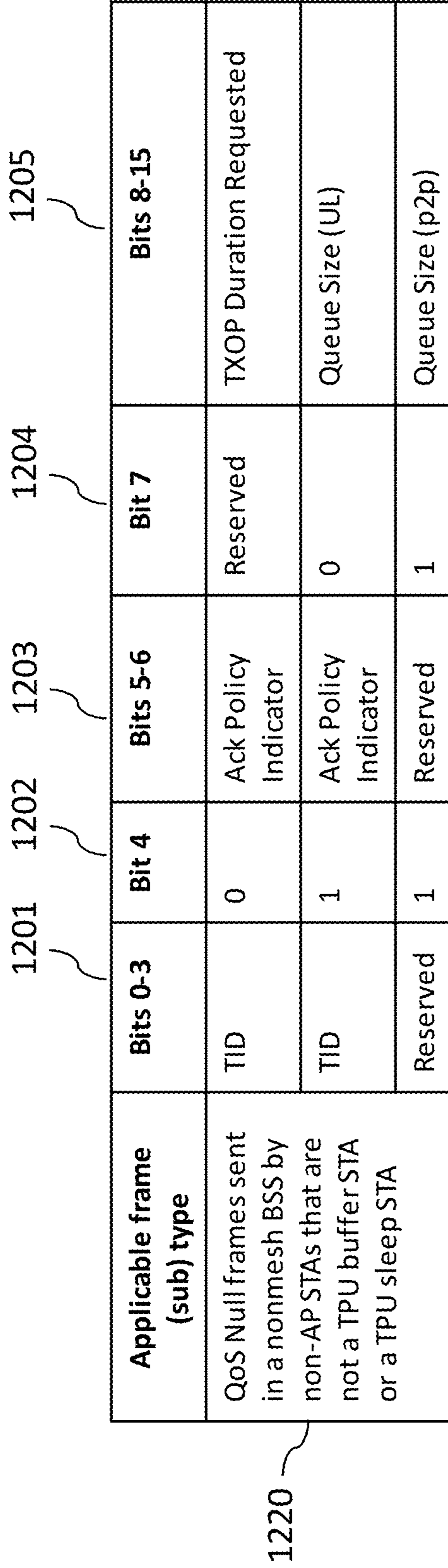

FIG. 12

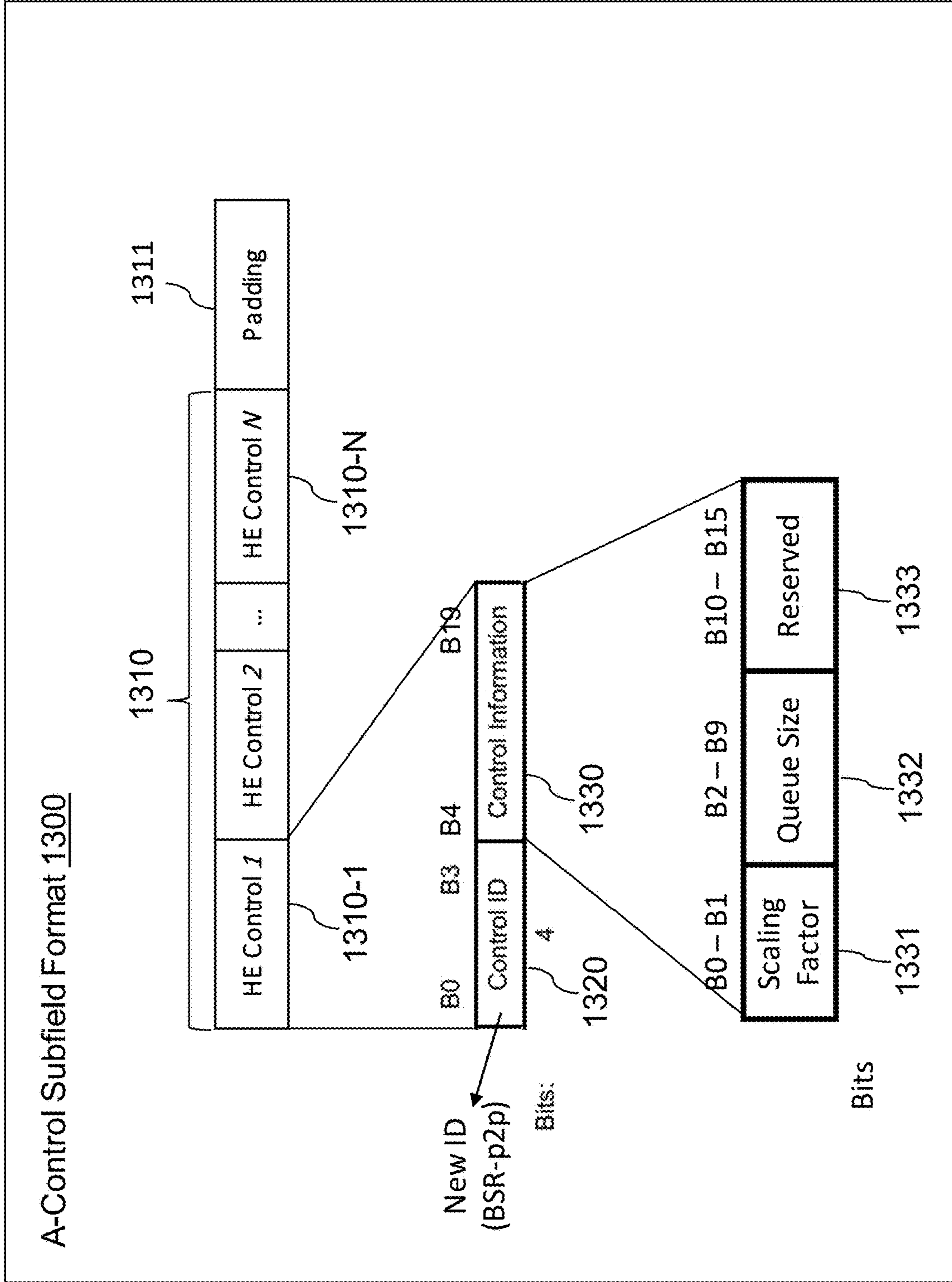

FIG. 13

1400

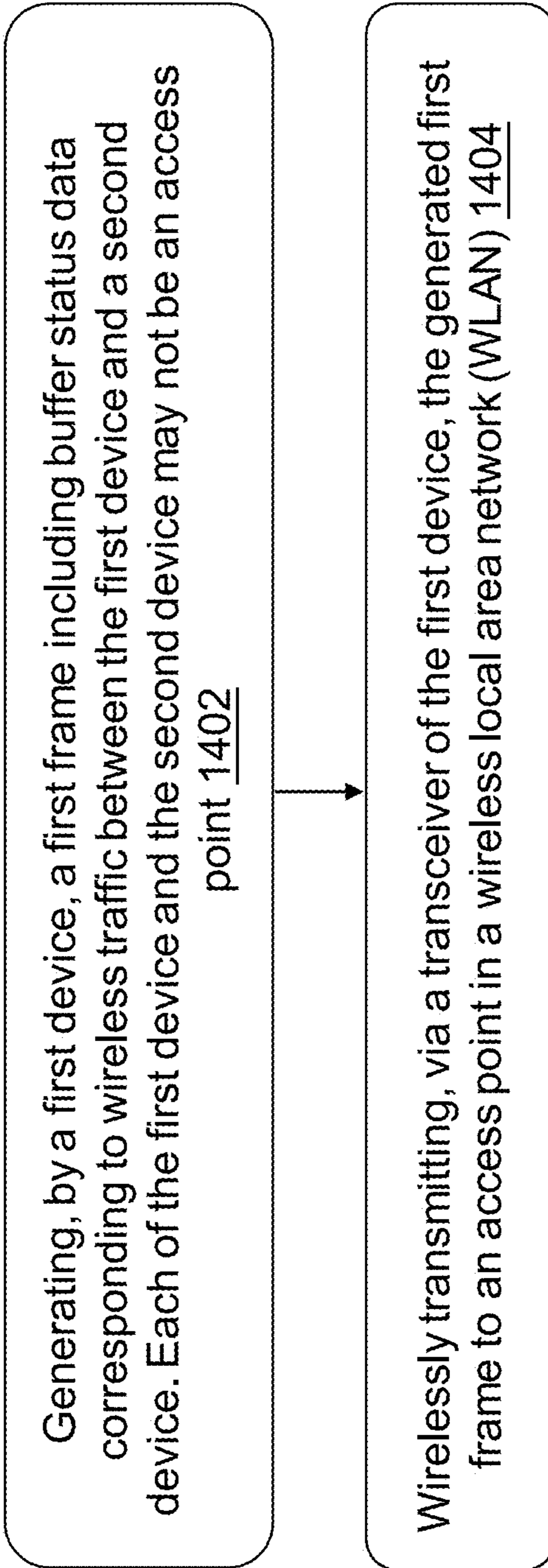

FIG. 14

**SYSTEMS AND METHODS OF REQUESTING
BUFFER STATUS FOR WIRELESS P2P
TRAFFIC**

CROSS-REFERENCE TO RELATED
APPLICATION

[0001] This application claims priority to U.S. Provisional Patent Application No. 63/333,822 filed on Apr. 22, 2022, which is incorporated by reference herein in its entirety for all purposes. This application also claims priority to U.S. Provisional Patent Application No. 63/333,872 filed on Apr. 22, 2022, which is incorporated by reference herein in its entirety for all purposes.

FIELD OF DISCLOSURE

[0002] The present disclosure is generally related to communications, including but not limited systems and methods for an access point (AP) to inquire or poll buffer status of a peer-to-peer (p2p) link, if present, to improve resource allocation.

BACKGROUND

[0003] Artificial reality such as a virtual reality (VR), an augmented reality (AR), or a mixed reality (MR) provides immersive experience to a user. In one example, a user wearing a head wearable display (HWD) can turn the user's head, and an image of a virtual object corresponding to a location of the HWD and a gaze direction of the user can be displayed on the HWD to allow the user to feel as if the user is moving within a space of artificial reality (e.g., a VR space, an AR space, or a MR space). An image of a virtual object may be generated by a console communicatively coupled to the HWD. In some embodiments, the console may have access to a network.

SUMMARY

[0004] Various embodiments disclosed herein are related to a device including one or more processors. In some embodiments, the one or more processors may be configured to generate a first frame to trigger a receiver device to send a response frame that includes buffer status data corresponding to wireless traffic between the receiver device and another device. The one or more processors may be configured to wirelessly transmit, via a transmitter, the generated first frame to one or more devices.

[0005] In some embodiments, the wireless traffic may include peer-to-peer (p2p) traffic between the receiver device and the another device. In some embodiments, in generating the first frame, the one or more processors may be configured to set a frame type field of the first frame to a type indicating a buffer status trigger frame.

[0006] In some embodiments, the first frame may include a first User Info field that relates to a first device. In generating the first frame, the one or more processors may be configured to set a subfield of the first User Info field to a first value indicating a buffer status request for wireless traffic between the first device and a second device. The first frame may include a second User Info field relating to a third device. In generating the first frame, the one or more processors may be configured to set a subfield of the second User Info field to a second value indicating a buffer status request for wireless traffic between the access point and the third device, to trigger the third device to send a response

frame that includes buffer status data corresponding to the wireless traffic between the access point and the third device.

[0007] In some embodiments, the first frame may include a Common Info field carrying information that is relevant to a plurality of users or receiver devices. In generating the first frame, the one or more processors may be configured to set a subfield of the Common Info field to a value indicating a buffer status request for wireless traffic between the receiver device and the another device.

[0008] In some embodiments, the first frame may include a Common Info field. In generating the first frame, the one or more processors may be configured to set a subfield of the Common Info field to a value to trigger a plurality of users or receiver devices to send respective response frames that include respective buffer status data corresponding to peer-to-peer (p2p) traffic.

[0009] In some embodiments, the first frame may include a frame type field. In generating the first frame, the one or more processors may be configured to set the frame type field to a type indicating a buffer status trigger frame for peer-to-peer (p2p) traffic.

[0010] In some embodiments, the first frame may include a Common Info field carrying information that is relevant to a plurality of users or receiver devices. The frame type field may be a subfield of the Common Info field.

[0011] In some embodiments, the first frame may include a frame type field. In generating the first frame, the one or more processors may be configured to set the frame type field to a type to trigger a plurality of users or receiver devices to send respective response frames that include respective buffer status data corresponding to wireless peer-to-peer (p2p) traffic.

[0012] Various embodiments disclosed herein are related to a method including generating, by an access point, a first frame to trigger a receiver device to send a response frame that includes buffer status data corresponding to wireless traffic between the receiver device and another device. The method may include wirelessly transmitting, via a transmitter of the access point, the generated first frame to one or more devices.

[0013] In some embodiments, the wireless traffic may include peer-to-peer (p2p) traffic between the receiver device and the another device. In some embodiments, in generating the first frame, the access point may set a frame type field of the first frame to a type indicating a buffer status trigger frame.

[0014] In some embodiments, the first frame may include a first User Info field that relates to a first device. In generating the first frame, the access point may set a subfield of the first User Info field to a first value indicating a buffer status request for wireless traffic between the first device and a second device. The first frame may include a second User Info field relating to a third device. In generating the first frame, the access point may set a subfield of the second User Info field to a second value indicating a buffer status request for wireless traffic between the access point and the third device, to trigger the third device to send a response frame that includes buffer status data corresponding to the wireless traffic between the access point and the third device.

[0015] In some embodiments, the first frame may include a Common Info field carrying information that is relevant to a plurality of users or receiver devices. In generating the first frame, the access point may set a subfield of the Common

Info field to a value indicating a buffer status request for wireless traffic between the receiver device and the another device.

[0016] In some embodiments, the first frame may include a Common Info field. In generating the first frame, the access point may set a subfield of the Common Info field to a value to trigger a plurality of users or receiver devices to send respective response frames that include respective buffer status data corresponding to peer-to-peer (p2p) traffic.

[0017] In some embodiments, the first frame may include a frame type field. In generating the first frame, the access point may set the frame type field to a type indicating a buffer status trigger frame for peer-to-peer (p2p) traffic. The first frame may include a Common Info field carrying information that is relevant to a plurality of users or receiver devices. The frame type field may be a subfield of the Common Info field.

[0018] In some embodiments, the first frame may include a frame type field. In generating the first frame, the access point may set the frame type field to a type to trigger a plurality of users or receiver devices to send respective response frames that include respective buffer status data corresponding to wireless peer-to-peer (p2p) traffic.

BRIEF DESCRIPTION OF THE DRAWINGS

[0019] The accompanying drawings are not intended to be drawn to scale. Like reference numbers and designations in the various drawings indicate like elements. For purposes of clarity, not every component can be labeled in every drawing.

[0020] FIG. 1 is a diagram of a system environment including an artificial reality system, according to an example implementation of the present disclosure.

[0021] FIG. 2 is a diagram of a head wearable display, according to an example implementation of the present disclosure.

[0022] FIG. 3 is a block diagram of a computing environment according to an example implementation of the present disclosure.

[0023] FIG. 4A is a diagram of a buffer status report (BSR) request and BSR responses, according to an example implementation of the present disclosure.

[0024] FIG. 4B is a diagram of a system environment including peer-to-peer (p2p) traffic in a wireless local area network (WLAN), according to an example implementation of the present disclosure.

[0025] FIG. 5A, FIG. 5B and FIG. 5C illustrate an example buffer status report poll (BSRP) trigger frame format, according to an example implementation of the present disclosure.

[0026] FIG. 5D illustrates an example trigger type subfield encoding, according to an example implementation of the present disclosure.

[0027] FIG. 6 illustrates an example User Info field format for indicating peer-to-peer (p2p) traffic, according to an example implementation of the present disclosure.

[0028] FIG. 7 illustrates an example Common Info field format for indicating p2p traffic, according to an example implementation of the present disclosure.

[0029] FIG. 8 illustrates an example trigger type subfield encoding for indicating a BSR trigger frame for p2p traffic, according to an example implementation of the present disclosure.

[0030] FIG. 9 is a flowchart showing a process of sending a request for buffer status data of p2p traffic, according to an example implementation of the present disclosure.

[0031] FIG. 10A illustrates an example quality of service (QoS) control field format, according to an example implementation of the present disclosure.

[0032] FIG. 10B illustrates an example format of an aggregate control (A-control) subfield of a control field for BSR control, according to an example implementation of the present disclosure.

[0033] FIG. 11 illustrates an example format of a control information subfield of an A-control subfield for reporting buffer status for p2p traffic, according to an example implementation of the present disclosure.

[0034] FIG. 12 illustrates an example QoS control field format for reporting buffer status for p2p traffic, according to an example implementation of the present disclosure.

[0035] FIG. 13 illustrates an example format of an A-control subfield of a control field for reporting buffer status for p2p traffic, according to an example implementation of the present disclosure.

[0036] FIG. 14 is a flowchart showing a process of reporting buffer status for p2p traffic, according to an example implementation of the present disclosure.

DETAILED DESCRIPTION

[0037] Before turning to the figures, which illustrate certain embodiments in detail, it should be understood that the present disclosure is not limited to the details or methodology set forth in the description or illustrated in the figures. It should also be understood that the terminology used herein is for the purpose of description only and should not be regarded as limiting.

[0038] FIG. 1 is a block diagram of an example artificial reality system environment 100 in which a console 110 operates. FIG. 1 provides an example environment in which devices may communicate traffic streams with different latency sensitivities/requirements. In some embodiments, the artificial reality system environment 100 includes a HWD 150 worn by a user, and a console 110 providing content of artificial reality to the HWD 150. A head wearable display (HWD) may be referred to as, include, or be part of a head mounted display (HMD), head mounted device (HMD), head wearable device (HWD), head worn display (HWD) or head worn device (HWD). In one aspect, the HWD 150 may include various sensors to detect a location, an orientation, and/or a gaze direction of the user wearing the HWD 150, and provide the detected location, orientation and/or gaze direction to the console 110 through a wired or wireless connection. The HWD 150 may also identify objects (e.g., body, hand face).

[0039] The console 110 may determine a view within the space of the artificial reality corresponding to the detected location, orientation and/or the gaze direction, and generate an image depicting the determined view. The console 110 may also receive one or more user inputs and modify the image according to the user inputs. The console 110 may provide the image to the HWD 150 for rendering. The image of the space of the artificial reality corresponding to the user's view can be presented to the user. In some embodiments, the artificial reality system environment 100 includes more, fewer, or different components than shown in FIG. 1. In some embodiments, functionality of one or more components of the artificial reality system environment 100 can

be distributed among the components in a different manner than is described here. For example, some of the functionality of the console **110** may be performed by the HWD **150**, and/or some of the functionality of the HWD **150** may be performed by the console **110**.

[0040] In some embodiments, the HWD **150** is an electronic component that can be worn by a user and can present or provide an artificial reality experience to the user. The HWD **150** may render one or more images, video, audio, or some combination thereof to provide the artificial reality experience to the user. In some embodiments, audio is presented via an external device (e.g., speakers and/or headphones) that receives audio information from the HWD **150**, the console **110**, or both, and presents audio based on the audio information. In some embodiments, the HWD **150** includes sensors **155**, eye trackers **160**, a communication interface **165**, an image renderer **170**, an electronic display **175**, a lens **180**, and a compensator **185**. These components may operate together to detect a location of the HWD **150** and/or a gaze direction of the user wearing the HWD **150**, and render an image of a view within the artificial reality corresponding to the detected location of the HWD **150** and/or the gaze direction of the user. In other embodiments, the HWD **150** includes more, fewer, or different components than shown in FIG. 1.

[0041] In some embodiments, the sensors **155** include electronic components or a combination of electronic components and software components that detect a location and/or an orientation of the HWD **150**. Examples of sensors **155** can include: one or more imaging sensors, one or more accelerometers, one or more gyroscopes, one or more magnetometers, or another suitable type of sensor that detects motion and/or location. For example, one or more accelerometers can measure translational movement (e.g., forward/back, up/down, left/right) and one or more gyroscopes can measure rotational movement (e.g., pitch, yaw, roll). In some embodiments, the sensors **155** detect the translational movement and/or the rotational movement, and determine an orientation and location of the HWD **150**. In one aspect, the sensors **155** can detect the translational movement and/or the rotational movement with respect to a previous orientation and location of the HWD **150**, and determine a new orientation and/or location of the HWD **150** by accumulating or integrating the detected translational movement and/or the rotational movement. Assuming for an example that the HWD **150** is oriented in a direction 25 degrees from a reference direction, in response to detecting that the HWD **150** has rotated 20 degrees, the sensors **155** may determine that the HWD **150** now faces or is oriented in a direction 45 degrees from the reference direction. Assuming for another example that the HWD **150** was located two feet away from a reference point in a first direction, in response to detecting that the HWD **150** has moved three feet in a second direction, the sensors **155** may determine that the HWD **150** is now located at a vector multiplication of the two feet in the first direction and the three feet in the second direction.

[0042] In some embodiments, the eye trackers **160** include electronic components or a combination of electronic components and software components that determine a gaze direction of the user of the HWD **150**. In some embodiments, the HWD **150**, the console **110** or a combination may incorporate the gaze direction of the user of the HWD **150** to generate image data for artificial reality. In some embodiments, the eye trackers **160** include two eye trackers, where

each eye tracker **160** captures an image of a corresponding eye and determines a gaze direction of the eye. In one example, the eye tracker **160** determines an angular rotation of the eye, a translation of the eye, a change in the torsion of the eye, and/or a change in shape of the eye, according to the captured image of the eye, and determines the relative gaze direction with respect to the HWD **150**, according to the determined angular rotation, translation and the change in the torsion of the eye. In one approach, the eye tracker **160** may shine or project a predetermined reference or structured pattern on a portion of the eye, and capture an image of the eye to analyze the pattern projected on the portion of the eye to determine a relative gaze direction of the eye with respect to the HWD **150**. In some embodiments, the eye trackers **160** incorporate the orientation of the HWD **150** and the relative gaze direction with respect to the HWD **150** to determine a gaze direction of the user. Assuming for an example that the HWD **150** is oriented at a direction 30 degrees from a reference direction, and the relative gaze direction of the HWD **150** is -10 degrees (or 350 degrees) with respect to the HWD **150**, the eye trackers **160** may determine that the gaze direction of the user is 20 degrees from the reference direction. In some embodiments, a user of the HWD **150** can configure the HWD **150** (e.g., via user settings) to enable or disable the eye trackers **160**. In some embodiments, a user of the HWD **150** is prompted to enable or disable the eye trackers **160**.

[0043] In some embodiments, the hand tracker **162** includes an electronic component or a combination of an electronic component and a software component that tracks a hand of the user. In some embodiments, the hand tracker **162** includes or is coupled to an imaging sensor (e.g., camera) and an image processor that can detect a shape, a location and/or an orientation of the hand. The hand tracker **162** may generate hand tracking measurements indicating the detected shape, location and/or orientation of the hand.

[0044] In some embodiments, the communication interface **165** includes an electronic component or a combination of an electronic component and a software component that communicates with the console **110**. The communication interface **165** may communicate with a communication interface **115** of the console **110** through a communication link. The communication link may be a wireless link, a wired link, or both. Examples of the wireless link can include a cellular communication link, a near field communication link, Wi-Fi, Bluetooth, or any communication wireless communication link. Examples of the wired link can include a USB, Ethernet, Firewire, HDMI, or any wired communication link. In embodiments in which the console **110** and the head wearable display **150** are implemented on a single system, the communication interface **165** may communicate with the console **110** through a bus connection or a conductive trace. Through the communication link, the communication interface **165** may transmit to the console **110** sensor measurements indicating the determined location of the HWD **150**, orientation of the HWD **150**, the determined gaze direction of the user, and/or hand tracking measurements. Moreover, through the communication link, the communication interface **165** may receive from the console **110** sensor measurements indicating or corresponding to an image to be rendered.

[0045] Using the communication interface, the console **110** (or HWD **150**) may coordinate operations on link **101** to reduce collisions or interferences. For example, the console

110 may coordinate communication between the console **110** and the HWD **150**. In some implementations, the console **110** may transmit a beacon frame periodically to announce/advertise a presence of a wireless link between the console **110** and the HWD **150** (or between two HWDs). In an implementation, the HWD **150** may monitor for or receive the beacon frame from the console **110**, and can schedule communication with the HWD **150** (e.g., using the information in the beacon frame, such as an offset value) to avoid collision or interference with communication between the console **110** and/or HWD **150** and other devices.

[0046] The console **110** and HWD **150** may communicate using link **101** (e.g., intralink). Data (e.g., a traffic stream) may flow in a direction on link **101**. For example, the console **110** may communicate using a downlink (DL) communication to the HWD **150** and the HWD **150** may communicate using an uplink (UL) communication to the console **110**.

[0047] In some embodiments, the image renderer **170** includes an electronic component or a combination of an electronic component and a software component that generates one or more images for display, for example, according to a change in view of the space of the artificial reality. In some embodiments, the image renderer **170** is implemented as a processor (or a graphical processing unit (GPU)) that executes instructions to perform various functions described herein. The image renderer **170** may receive, through the communication interface **165**, data describing an image to be rendered, and render the image through the electronic display **175**. In some embodiments, the data from the console **110** may be encoded, and the image renderer **170** may decode the data to generate and render the image. In one aspect, the image renderer **170** receives the encoded image from the console **110**, and decodes the encoded image, such that a communication bandwidth between the console **110** and the HWD **150** can be reduced.

[0048] In some embodiments, the image renderer **170** receives, from the console, **110** additional data including object information indicating virtual objects in the artificial reality space and depth information indicating depth (or distances from the HWD **150**) of the virtual objects. Accordingly, the image renderer **170** may receive from the console **110** object information and/or depth information. The image renderer **170** may also receive updated sensor measurements from the sensors **155**. The process of detecting, by the HWD **150**, the location and the orientation of the HWD **150** and/or the gaze direction of the user wearing the HWD **150**, and generating and transmitting, by the console **110**, a high resolution image (e.g., 1920 by 1080 pixels, or 2048 by 1152 pixels) corresponding to the detected location and the gaze direction to the HWD **150** may be computationally exhaustive and may not be performed within a frame time (e.g., less than 11 ms or 8 ms).

[0049] In some implementations, the image renderer **170** may perform shading, reprojection, and/or blending to update the image of the artificial reality to correspond to the updated location and/or orientation of the HWD **150**. Assuming that a user rotated their head after the initial sensor measurements, rather than recreating the entire image responsive to the updated sensor measurements, the image renderer **170** may generate a small portion (e.g., 10%) of an image corresponding to an updated view within the artificial reality according to the updated sensor measurements, and append the portion to the image in the image data from the

console **110** through reprojection. The image renderer **170** may perform shading and/or blending on the appended edges. Hence, without recreating the image of the artificial reality according to the updated sensor measurements, the image renderer **170** can generate the image of the artificial reality.

[0050] In other implementations, the image renderer **170** generates one or more images through a shading process and a reprojection process when an image from the console **110** is not received within the frame time. For example, the shading process and the reprojection process may be performed adaptively, according to a change in view of the space of the artificial reality.

[0051] In some embodiments, the electronic display **175** is an electronic component that displays an image. The electronic display **175** may, for example, be a liquid crystal display or an organic light emitting diode display. The electronic display **175** may be a transparent display that allows the user to see through. In some embodiments, when the HWD **150** is worn by a user, the electronic display **175** is located proximate (e.g., less than 3 inches) to the user's eyes. In one aspect, the electronic display **175** emits or projects light towards the user's eyes according to image generated by the image renderer **170**.

[0052] In some embodiments, the lens **180** is a mechanical component that alters received light from the electronic display **175**. The lens **180** may magnify the light from the electronic display **175**, and correct for optical error associated with the light. The lens **180** may be a Fresnel lens, a convex lens, a concave lens, a filter, or any suitable optical component that alters the light from the electronic display **175**. Through the lens **180**, light from the electronic display **175** can reach the pupils, such that the user can see the image displayed by the electronic display **175**, despite the close proximity of the electronic display **175** to the eyes.

[0053] In some embodiments, the compensator **185** includes an electronic component or a combination of an electronic component and a software component that performs compensation to compensate for any distortions or aberrations. In one aspect, the lens **180** introduces optical aberrations such as a chromatic aberration, a pin-cushion distortion, barrel distortion, etc. The compensator **185** may determine a compensation (e.g., predistortion) to apply to the image to be rendered from the image renderer **170** to compensate for the distortions caused by the lens **180**, and apply the determined compensation to the image from the image renderer **170**. The compensator **185** may provide the predistorted image to the electronic display **175**.

[0054] In some embodiments, the console **110** is an electronic component or a combination of an electronic component and a software component that provides content to be rendered to the HWD **150**. In one aspect, the console **110** includes a communication interface **115** and a content provider **130**. These components may operate together to determine a view (e.g., a field of view (FOV) of the user) of the artificial reality corresponding to the location of the HWD **150** and/or the gaze direction of the user of the HWD **150**, and can generate an image of the artificial reality corresponding to the determined view. In other embodiments, the console **110** includes more, fewer, or different components than shown in FIG. 1. In some embodiments, the console **110** is integrated as part of the HWD **150**. In some embodiments, the communication interface **115** is an electronic component or a combination of an electronic component and

a software component that communicates with the HWD 150. The communication interface 115 may be a counterpart component to the communication interface 165 to communicate with a communication interface 115 of the console 110 through a communication link (e.g., USB cable, a wireless link). Through the communication link, the communication interface 115 may receive from the HWD 150 sensor measurements indicating the determined location and/or orientation of the HWD 150, the determined gaze direction of the user, and/or hand tracking measurements. Moreover, through the communication link, the communication interface 115 may transmit to the HWD 150 data describing an image to be rendered.

[0055] The content provider 130 can include or correspond to a component that generates content to be rendered according to the location and/or orientation of the HWD 150, the gaze direction of the user and/or hand tracking measurements. In one aspect, the content provider 130 determines a view of the artificial reality according to the location and orientation of the HWD 150 and/or the gaze direction of the user of the HWD 150. For example, the content provider 130 maps the location of the HWD 150 in a physical space to a location within an artificial reality space, and determines a view of the artificial reality space along a direction corresponding to an orientation of the HWD 150 and/or the gaze direction of the user from the mapped location in the artificial reality space.

[0056] The content provider 130 may generate image data describing an image of the determined view of the artificial reality space, and transmit the image data to the HWD 150 through the communication interface 115. The content provider may also generate a hand model (or other virtual object) corresponding to a hand of the user according to the hand tracking measurement, and generate hand model data indicating a shape, a location, and an orientation of the hand model in the artificial reality space.

[0057] In some embodiments, the content provider 130 generates metadata including motion vector information, depth information, edge information, object information, etc., associated with the image, and transmits the metadata with the image data to the HWD 150 through the communication interface 115. The content provider 130 may encode and/or encode the data describing the image, and can transmit the encoded and/or encoded data to the HWD 150. In some embodiments, the content provider 130 generates and provides the image to the HWD 150 periodically (e.g., every one second).

[0058] FIG. 2 is a diagram of a HWD 150, in accordance with an example embodiment. In some embodiments, the HWD 150 includes a front rigid body 205 and a band 210. The front rigid body 205 includes the electronic display 175 (not shown in FIG. 2), the lens 180 (not shown in FIG. 2), the sensors 155, the eye trackers 160A, 160B, the communication interface 165, and the image renderer 170. In the embodiment shown by FIG. 2, the sensors 155 are located within the front rigid body 205, and may not be visible to the user. In other embodiments, the HWD 150 has a different configuration than shown in FIG. 2. For example, the image renderer 170, the eye trackers 160A, 160B, and/or the sensors 155 may be in different locations than shown in FIG. 2.

[0059] Various operations described herein can be implemented on computer systems. FIG. 3 shows a block diagram of a representative computing system 314 usable to imple-

ment the present disclosure. In some embodiments, the console 110, the HWD 150 or both of FIG. 1 are implemented by the computing system 314. Computing system 314 can be implemented, for example, as a consumer device such as a smartphone, other mobile phone, tablet computer, wearable computing device (e.g., smart watch, eyeglasses, head wearable display), desktop computer, laptop computer, or implemented with distributed computing devices. The computing system 314 can be implemented to provide VR, AR, MR experience. In some embodiments, the computing system 314 can include conventional computer components such as processors 316, storage device 318, network interface 320, user input device 322, and user output device 324.

[0060] Network interface 320 can provide a connection to a wide area network (e.g., the Internet) to which WAN interface of a remote server system is also connected. Network interface 320 can include a wired interface (e.g., Ethernet) and/or a wireless interface implementing various RF data communication standards such as Wi-Fi, Bluetooth, or cellular data network standards (e.g., 3G, 4G, 5G, 6G, 60 GHz, LTE, etc.).

[0061] The network interface 320 may include a transceiver to allow the computing system 314 to transmit and receive data from a remote device (e.g., an AP, a STA) using a transmitter and receiver. The transceiver may be configured to support transmission/reception supporting industry standards that enables bi-directional communication. An antenna may be attached to transceiver housing and electrically coupled to the transceiver. Additionally or alternatively, a multi-antenna array may be electrically coupled to the transceiver such that a plurality of beams pointing in distinct directions may facilitate in transmitting and/or receiving data.

[0062] A transmitter may be configured to wirelessly transmit frames, slots, or symbols generated by the processor unit 316. Similarly, a receiver may be configured to receive frames, slots or symbols and the processor unit 316 may be configured to process the frames. For example, the processor unit 316 can be configured to determine a type of frame and to process the frame and/or fields of the frame accordingly.

[0063] User input device 322 can include any device (or devices) via which a user can provide signals to computing system 314; computing system 314 can interpret the signals as indicative of particular user requests or information. User input device 322 can include any or all of a keyboard, touch pad, touch screen, mouse or other pointing device, scroll wheel, click wheel, dial, button, switch, keypad, microphone, sensors (e.g., a motion sensor, an eye tracking sensor, etc.), and so on.

[0064] User output device 324 can include any device via which computing system 314 can provide information to a user. For example, user output device 324 can include a display to display images generated by or delivered to computing system 314. The display can incorporate various image generation technologies, e.g., a liquid crystal display (LCD), light-emitting diode (LED) including organic light-emitting diodes (OLED), projection system, cathode ray tube (CRT), or the like, together with supporting electronics (e.g., digital-to-analog or analog-to-digital converters, signal processors, or the like). A device such as a touchscreen that function as both input and output device can be used. Output devices 324 can be provided in addition to or instead of a

display. Examples include indicator lights, speakers, tactile “display” devices, printers, and so on.

[0065] Some implementations include electronic components, such as microprocessors, storage and memory that store computer program instructions in a computer readable storage medium (e.g., non-transitory computer readable medium). Many of the features described in this specification can be implemented as processes that are specified as a set of program instructions encoded on a computer readable storage medium. When these program instructions are executed by one or more processors, they cause the processors to perform various operation indicated in the program instructions. Examples of program instructions or computer code include machine code, such as is produced by a compiler, and files including higher-level code that are executed by a computer, an electronic component, or a microprocessor using an interpreter. Through suitable programming, processor 316 can provide various functionality for computing system 314, including any of the functionality described herein as being performed by a server or client, or other functionality associated with message management services.

[0066] It will be appreciated that computing system 314 is illustrative and that variations and modifications are possible. Computer systems used in connection with the present disclosure can have other capabilities not specifically described here. Further, while computing system 314 is described with reference to particular blocks, it is to be understood that these blocks are defined for convenience of description and are not intended to imply a particular physical arrangement of component parts. For instance, different blocks can be located in the same facility, in the same server rack, or on the same motherboard. Further, the blocks need not correspond to physically distinct components. Blocks can be configured to perform various operations, e.g., by programming a processor or providing appropriate control circuitry, and various blocks might or might not be reconfigurable depending on how the initial configuration is obtained. Implementations of the present disclosure can be realized in a variety of apparatus including electronic devices implemented using any combination of circuitry and software.

1. Requesting Buffer Status Report for Wireless Peer-to-Peer (p2p) Traffic

[0067] IEEE 802.11be Extremely High Throughput (EHT) may be the next generation 802.11 IEEE standard, which may be designated Wi-Fi 7. A signaling method for requesting/polling buffer status report (BSR) may be defined, in accordance with some embodiments of the present disclosure. A BSR operation may be performed as follows. An AP may send a trigger frame (e.g., Buffer Status Report Poll (BSRP) Trigger frame) to STAs to enquire about buffer status. Buffer status may be a quantitative indication of how much traffic (e.g., quality of service (QoS) data) is queued up at a STA. The STA may indicate a buffer status in a data unit (e.g., bytes) by including either of a QoS control field or a BSR control field in frames sent to the AP. The STA may indicate a buffer status in response to a BSRP trigger frame or as an unsolicited response by itself.

[0068] FIG. 4A is a diagram 400 of a buffer status report (BSR) request (e.g., BSRP trigger frame 402) and BSR responses (e.g., high-efficiency (HE) trigger-based (TB) uplink (UL) aggregate MAC Protocol Data Unit (A-MPDU) frames 406), according to an example implementation of the

present disclosure. As shown in FIG. 4, an AP can send the BSRP trigger frame 402. After a short inter-frame space (SIFS) 404, STAs (e.g., STA1-STA4) can send their buffer statuses respectively contained in HE TB ULA-MPDU frames 406, which may be acknowledged by a multi-STA block Acknowledgment (M-BA) frame 410 after another SIFS 408. A buffer status can be contained in either a QoS-control field or a BSR HE control field in a QoS-Data frame or a QoS-Null frame. A STA may or may not acknowledge (ACK) a BSR request.

[0069] FIG. 4B is a diagram of a system environment including peer-to-peer (p2p) traffic in a wireless local area network (WLAN), according to an example implementation of the present disclosure. A first non-AP STA device 470 may be configured to send/receive UL/DL (downlink) traffic 472 to/from an AP device 460, and may be configured to send/receive p2p traffic 474 to/from a second non-AP device 480. A third non-AP STA device 490 may be configured to send/receive UL/DL traffic 492 to/from the AP device 460.

[0070] FIG. 5A, FIG. 5B and FIG. 5C illustrate examples for a BSR trigger frame format 500 (e.g., BSRP trigger frame), according to example implementations of the present disclosure. FIG. 5D illustrates an example trigger type subfield encoding 590, according to an example implementation of the present disclosure. Referring to FIG. 5A to FIG. 5D, the BSR trigger frame format 500 may include the fields of frame control 501, duration 502, receiver address 503, transmitter address 504, common information (“Common Info”) 550, user information list 510 which includes a plurality of User Info fields (e.g., user information (“User Info”) field format 520), padding 505, and/or frame check sequence (FCS) 506. The User Info field format 520 may include the subfields of association identifier (AID12) 521, RU (resource unit) allocation 522, UL FEC (forward error correction) coding type 523, UL HE-MCS (modulation coding scheme) 524, UL DCM (dual carrier modulation) 525, SS (spatial streams) allocation/RA-RU information 526, UL target receive power 527, reserved 528, and/or trigger dependent user information 529. The trigger dependent user information 529 may or may not be present in the trigger frame. The Common Info field 550 may include the subfields of trigger type 551, UL length 552, more TF (trigger frame) 553, CS (carrier sense) required 554, UL BW (bandwidth) 555, GI (guard interval) and LTF (long training field) type 556, MU (multi-user)-MIMO (multiple-input multiple-output) HE-LTF mode 557, number of HE-LTF symbols and mid-ambles periodicity 558, UL STBC (space-time block coding) 559, LDPC (low-density parity check) extra symbol segment 560, AP Tx power 561, Pre-FEC padding factor 562, PE (packet extension) disambiguity 563, UL spatial reuse 564, Doppler 565, UL HE-S1G-A2 reserved 566, reserved 567, and/or trigger dependent common information 568. The trigger type subfield 551 may be set to a value (e.g., 4) indicating BSRP as defined in an item 592 in the trigger type subfield encoding 590. The trigger dependent common information 568 may or may not be present in the trigger frame.

[0071] Referring to FIG. 5A to 5D, an AP may send a BSRP trigger frame with the trigger frame format 500. The subfield of trigger type of the BSRP trigger (e.g., trigger type 551) may be set to 4 to indicate a BSRP trigger frame (see FIG. 5D). The BSRP trigger frame may indicate to one or more STAs to report their UL buffer statuses in responding frames (e.g., QoS-Data or QoS-Null frames). These BSR

operations may be used in a target wake time (TWT) mechanism, e.g., restricted TWT (R-TWT), defined in a wireless local area network (WLAN) protocol (e.g., 802.11be). In a TWT mechanism, STAs (wireless devices such as a smart phone or a HWD) can adopt a wake time schedule that makes them wake up on a periodic basis to transmit/receive data. R-TWT can force all other 802.11be-compatible devices to finish their transmissions before a TWT service period (SP) begins. R-TWT may be used to provide prioritized access and medium access protection to a STA's peer-to-peer (p2p) traffic (e.g., p2p traffic 474 of the device 470 in FIG. 4B). This TWT mechanism (e.g., R-TWT) may require capability to report buffer status for a STA's p2p traffic to perform efficiently. For instance, an AP (e.g., AP 460 in FIG. 4B) may allocate resources (e.g., transmission opportunities (TXOP)) during an R-TWT SP for the STA's p2p traffic (e.g., the device 470's p2p traffic 474), according to the buffer status. During an on-going SP, if the AP can inquire status of a STA's peer-to-peer (p2p) traffic, it would help efficient operations (e.g., helping the AP to allocate resources efficiently). For example, a STA may indicate an empty buffer for p2p to the AP to indicate that the STA has completed delivering Latency Sensitive Traffic (LST). A TWT SP may be terminated to save power (if uplink/downlink (UL/DL) LST is also delivered), and AP can serve other STAs. The STA may indicate a non-empty buffer for p2p, to the AP close to an SP's end, to convey that the STA still has LST. The SP may be extended by the AP for the STA to deliver remaining buffered traffic. AP may also inquire buffer status itself to facilitate the above.

[0072] However, other/conventional buffer status request/poll (BSRP) trigger mechanism can solicit STA's uplink (UL) buffer status only. An AP cannot inquire status of STA's peer-to-peer (p2p) traffic using a BSRP trigger frame. There is hence a need/benefit to define new request methods for an AP to inquire/poll buffer status of p2p traffic.

[0073] To address this problem, a signaling method for requesting/polling buffer status report for p2p traffic may be provided/defined. In some embodiments, the format of a BSRP trigger frame may be redefined to indicate a request for buffer status for p2p traffic. For example, subfields/bits of the common information ("Common Info") field or the user information ("User Info") field may be redefined to indicate a request for buffer status for p2p traffic. A new trigger type for p2p traffic may defined using a trigger type field of the Common Info field.

[0074] In one approach, one or more bits (e.g., a reserved bit) in the User Info field of a BSRP trigger frame ("first p2p bit") may be used to indicate a p2p buffer status request. When the first p2p bit is set in a trigger frame sent by an AP, the trigger frame may indicate/request/trigger a STA to include buffer status for its p2p traffic in response, using a BSR procedure. For example, when the first p2p bit is set to a first value (e.g., 1), the STA may or should send buffer status of its p2p traffic in response to the trigger frame. When the first p2p bit is set to a second value (e.g., 0), the STA may send buffer status of its uplink (UL) traffic in response to the trigger frame. Because the trigger frame uses the User Info field, this triggering method may or may not be used depending on the user or STA. For example, the User Info list field may include a plurality of User Info fields among which a first User Info field may indicate, to a first user/STA, p2p buffer status request, and a second User Info field may indicate, to a second user/STA, UL buffer status request. In

some embodiments, one or more defined/re-purposed bits from any one or more fields (e.g., other than the User Info field or other than "reserved bit" of the User Info field) can be used to indicate to the STA to include its buffer status for its p2p traffic and/or other types of traffic (e.g., UL and/or DL).

[0075] In one approach, one or more bits (e.g., a reserved bit) in Common Info field of a BSRP trigger frame ("second p2p bit") may be used to indicate p2p buffer status request. When the second p2p bit is set in a trigger frame sent by an AP, the trigger frame may indicate/request/trigger a STA to include its buffer status for its p2p traffic in response, using a BSR procedure. For example, when the second p2p bit is set to a first value (e.g., 1), the STA may or should send buffer status of its p2p traffic in response to the trigger frame. When the second p2p bit is set to a second value (e.g., 0), the STA may send buffer status of its uplink traffic in response to the trigger frame. Because the trigger frame uses the Common Info field, this triggering method may be used by (or trigger) all users or all STAs receiving the trigger frame. In some embodiments, one or more defined/re-purposed bits from any one or more fields (e.g., other than the Common Info field) can be used to indicate to the STA to include its buffer status for its p2p traffic and/or other types of traffic (e.g., UL and/or DL).

[0076] In one approach, a new BSRP-p2p trigger frame may be defined to indicate p2p buffer status request. A new/specific trigger frame type for p2p traffic, e.g., "BSRP-p2p trigger frame type", may be added/introduced/defined as a value used in the trigger type field of the Common Info field. For example, a value such as 8 or any value that is not used by other types can be used. In some implementations, the frame format may be the same as or similar to that of a BSRP trigger frame. When a STA receives a BSRP-p2p trigger frame with the trigger type field set to the BSRP-p2p trigger frame type, the STA may or should include its buffer status for its p2p traffic in response, using a BSR procedure.

[0077] In one approach, an access point may include one or more processors. The one or more processors may be configured to generate a first frame to trigger a receiver device to send a response frame that includes buffer status data corresponding to wireless traffic between the receiver device and another device. The one or more processors may be configured to wirelessly transmit, via a transmitter, the generated first frame to one or more devices.

[0078] In one approach, the wireless traffic may include peer-to-peer (p2p) traffic between the receiver device and the another device. In some embodiments, in generating the first frame, the one or more processors may be configured to set a frame type field of the first frame to a type indicating a buffer status trigger frame.

[0079] In one approach, the first frame may include a first User Info field that relates to a first device. In generating the first frame, the one or more processors may be configured to set a subfield of the first User Info field to a first value indicating a buffer status request for wireless traffic between the first device and a second device. The first frame may include a second User Info field relating to a third device. In generating the first frame, the one or more processors may be configured to set a subfield of the second User Info field to a second value indicating a buffer status request for wireless traffic between the access point and the third device, to trigger the third device to send a response frame that

includes buffer status data corresponding to the wireless traffic between the access point and the third device.

[0080] In one approach, the first frame may include a Common Info field carrying information that is relevant to a plurality of users or receiver devices. In generating the first frame, the one or more processors may be configured to set a subfield of the Common Info field to a value indicating a buffer status request for wireless traffic between the receiver device and the another device.

[0081] In one approach, the first frame may include a Common Info field. In generating the first frame, the one or more processors may be configured to set a subfield of the Common Info field to a value to trigger a plurality of users or receiver devices to send respective response frames that include respective buffer status data corresponding to peer-to-peer (p2p) traffic.

[0082] In one approach, the first frame may include a frame type field. In generating the first frame, the one or more processors may be configured to set the frame type field to a type indicating a buffer status trigger frame for peer-to-peer (p2p) traffic.

[0083] In one approach, the first frame may include a Common Info field carrying information that is relevant to a plurality of users or receiver devices. The frame type field may be a subfield of the Common Info field.

[0084] In one approach, the first frame may include a frame type field. In generating the first frame, the one or more processors may be configured to set the frame type field to a type to trigger a plurality of users or receiver devices to send respective response frames that include respective buffer status data corresponding to wireless peer-to-peer (p2p) traffic.

[0085] Embodiments in the present disclosure have at least the following advantages and benefits. Embodiments in the present disclosure can provide useful techniques for inquiring the status of a STA's peer-to-peer (p2p) traffic using a BSRP trigger frame, thereby providing new request methods for an AP to inquire/poll a buffer status of p2p traffic. In some embodiments, a new request method can be provided by redefining the format of a BSRP trigger frame or by defining a new trigger frame type of BSR-p2p. In this manner, an AP can inquire/poll buffer status of p2p traffic of a particular user (e.g., using the User Info field) or all users (e.g., using the Common Info field).

[0086] FIG. 6 illustrates an example user information ("User Info") field format 600 for indicating peer-to-peer (p2p) traffic, according to an example implementation of the present disclosure. The User Info field format 600 may be the same as or similar to the User Info field format 520, except a subfield 601. In some embodiments, the subfield 601 of the User Info field format 600 may redefine the reserved bit 528 (see FIG. 5B) to indicate/request/trigger a STA to include buffer status for its p2p traffic in response, using a BSR procedure. In some embodiments, the subfield 601 may be a single bit (e.g., bit B39 of the User Info field format 600). When the bit B39 is set in a trigger frame, the trigger frame sent by an AP (e.g., AP 460) may indicate/request/trigger a STA (e.g., device 470) to include buffer status for its p2p traffic (e.g., p2p traffic 474 between the device 470 and the device 480) in response, using a BSR procedure. For example, when the bit B39 is set to a first value (e.g., 1), the STA may or should send buffer status of its p2p traffic in response to the trigger frame. When the bit B39 is set to a second value (e.g., 0), the STA may send

buffer status of its uplink (UL) traffic (e.g., UL traffic 472 from the device 470 to the AP 460) in response to the trigger frame. Because the trigger frame uses the User Info field, this triggering method may or may not be used depending on the user or STA (e.g., user or STA defined by the association ID in the AID12 subfield 521). For example, the User Info list field may include a plurality of User Info fields (each of which has the User Info field format 600) among which a first User Info field may indicate, to a first user/STA (e.g., device 470), p2p buffer status request, and a second User Info field may indicate, to a second user/STA (e.g., device 490), UL buffer status request. In some embodiments, one or more defined/re-purposed bits from any one or more fields (e.g., other than the User Info field 600 or other than "reserved bit" B39 of the User Info field)) can be used to indicate to the STA to include its buffer status for its p2p traffic and/or other types of traffic (e.g., UL and/or DL).

[0087] FIG. 7 illustrates an example common information ("Common Info") field format 700 for indicating p2p traffic, according to an example implementation of the present disclosure. The Common Info field format 700 may be the same as or similar to the Common Info field format 550, except a subfield 701. In some embodiments, the subfield 701 of the Common Info field format 700 may redefine the reserved bit 567 (see FIG. 5C) to indicate p2p buffer status request. In some embodiments, the subfield 701 may be a single bit (e.g., bit B63 of the Common Info field format 700). When the bit B63 is set in a trigger frame sent by an AP (e.g., AP 460), the trigger frame may indicate/request/trigger a STA (e.g., device 470) to include its buffer status for its p2p traffic (e.g., p2p traffic 474 between the device 470 and the device 480) in response, using a BSR procedure. For example, when the bit B63 is set to a first value (e.g., 1), the STA may or should send buffer status of its p2p traffic in response to the trigger frame. When the bit B63 is set to a second value (e.g., 0), the STA may send buffer status of its uplink traffic in response to the trigger frame. Because the trigger frame uses the Common Info field, this triggering method may be used by (or trigger) all users or all STAs receiving the trigger frame (e.g., all STAs associating with the AP 460 including device 470 and device 490). In some embodiments, one or more defined/re-purposed bits from any one or more fields (e.g., other than the Common Info field) can be used to indicate to the STA to include its buffer status for its p2p traffic and/or other types of traffic (e.g., UL and/or DL).

[0088] FIG. 8 illustrates an example trigger type subfield encoding 800 for indicating a BSR trigger frame for p2p traffic, according to an example implementation of the present disclosure. In one approach, a new BSRP-p2p trigger frame may be defined to indicate p2p buffer status request. A new trigger frame type 802 for p2p traffic, e.g., "BSRP-p2p trigger frame type", may be added/introduced/defined as a value used in the trigger type field of the Common Info field (e.g., trigger type field 702 of the Common Info field 700 in FIG. 7). For example, a value such as 8 or any value (e.g., $8 \leq N \leq 15$ when the trigger type subfield encoding 800 is used) that is not used by other types can be used. In some implementations, the frame format may be the same as or similar to that of a BSRP trigger frame (e.g., trigger frame format as shown in FIGS. 5A, 5B and 5C). When a STA (e.g., device 470) receives, from an AP (e.g., AP 460) a BSRP-p2p trigger frame with the trigger type field set to the BSRP-p2p trigger frame type, the STA

may or should include its buffer status for its p2p traffic in response, using a BSR procedure.

[0089] FIG. 9 is a flowchart showing a process 900 of sending a request for buffer status data of p2p traffic, according to an example implementation of the present disclosure. In some embodiments, the process 900 is performed by an access point (e.g., AP 460 or soft-enabled AP (soft-AP)). In some embodiments, the process 900 is performed by other entities. In some embodiments, the process 900 includes more, fewer, or different steps than shown in FIG. 10.

[0090] In one approach, the access point (e.g., AP 460) may generate 902 a first frame (e.g., a BSRP trigger frame including the User Info field format 600, a BSRP trigger frame including the Common Info format 700, or a trigger frame having a new BSRP-p2p type 802) to trigger a receiver device (e.g., device 470) to send a response frame (e.g., BSR response frame) that includes buffer status data corresponding to wireless traffic (e.g., p2p traffic 474) between the receiver device (e.g., device 470) and another device (e.g., device 480). In some embodiments, the wireless traffic may include peer-to-peer (p2p) traffic between the receiver device and the another device. In some embodiments, in generating the first frame, the access point may set a frame type field (e.g., trigger type subfield 702) of the first frame to a type indicating a buffer status trigger frame (e.g., BSRP type 592) because the first frame reuses/redefines the format of the existing BSR trigger-type frame.

[0091] In some embodiments, the first frame (e.g., a BSRP trigger frame including the User Info field format 600) may include a first User Info field that relates to a first device (e.g., User Info field format 600 with the AID12 subfield set to an association with the first device 470). In generating the first frame, the access point may set a subfield (e.g., subfield 601) of the first User Info field to a first value (e.g., 1) indicating a buffer status request for wireless traffic between the first device (e.g., device 470) and a second device (e.g., device 480). The first frame may include a second User Info field relating to a third device (e.g., User Info field format 600 with the AID12 subfield set to an association with the third device 490). In generating the first frame, the access point may set a subfield of the second User Info field (e.g., subfield 601) to a second value (e.g., 0) indicating a buffer status request for wireless traffic (e.g., UL/DL traffic 492) between the access point (e.g., AP 460) and the third device (e.g., device 490), to trigger the third device to send a response frame that includes buffer status data corresponding to the wireless traffic between the access point and the third device (e.g., UL traffic 492 from the third device 490).

[0092] In some embodiments, the first frame (e.g., a BSRP trigger frame including the Common Info format 700) may include a Common Info field carrying information that is relevant to a plurality of users or receiver devices. In generating the first frame, the access point (e.g., AP 460) may set a subfield (e.g., subfield 701) of the Common Info field (e.g., Common Info format 700) to a value (e.g., 1) indicating a buffer status request for wireless traffic between the receiver device (e.g., device 470) and the another device (e.g., device 480).

[0093] In some embodiments, the first frame (e.g., a BSRP trigger frame including the Common Info format 700) may include a Common Info field. In generating the first frame, the access point (e.g., AP 460) may set a subfield (e.g., subfield 701) of the Common Info field (e.g., Common Info

format 700) to a value (e.g., 1) to trigger a plurality of users or receiver devices (e.g., device 470 and device 490) to send respective response frames that include respective buffer status data corresponding to peer-to-peer (p2p) traffic.

[0094] In some embodiments, the first frame (e.g., a trigger frame having a new BSRP-p2p type 802) may include a frame type field (e.g., trigger type subfield 702). In generating the first frame, the access point may set the frame type field to a type (e.g., new BSRP-p2p type 802) indicating a buffer status trigger frame for peer-to-peer (p2p) traffic. The first frame may include a Common Info field carrying information that is relevant to a plurality of users or receiver devices (e.g., device 470 and device 490). The frame type field may be a subfield of the Common Info field (e.g., trigger type subfield 702 of Common Info field format 700).

[0095] In some embodiments, the first frame (e.g., a trigger frame having a new BSRP-p2p type 802) may include a frame type field (e.g., trigger type subfield 702 of Common Info field format 700). In generating the first frame, the access point may set the frame type field to a type (e.g., new BSRP-p2p type 802) to trigger a plurality of users or receiver devices (e.g., device 470 and device 490) to send respective response frames that include respective buffer status data corresponding to wireless peer-to-peer (p2p) traffic.

[0096] In one approach, the access point (e.g., AP 460) may wirelessly transmit 904, via a transmitter of the access point, the generated first frame to one or more devices (e.g., device 470 and device 490).

2. Providing Buffer Status Report for Wireless Peer-to-Peer (p2p) Traffic

[0097] FIG. 10A and FIG. 10B show two buffer status report procedures—(1) using a quality of service (QoS) control field format (FIG. 10A) and (2) using an aggregate control (A-control) subfield format (FIG. 10B).

[0098] FIG. 10A illustrates an example QoS control field format 1000, according to an example implementation of the present disclosure. The QoS control field format 1000 may include subfield 1001 (bits 0-3), subfield 1002 (bit 4), subfield 1003 (bits 5-6), subfield 1004 (bit 7), and/or subfield 1005 (bits 8-15). A STA (e.g., device 470) may report its buffer status by specifying a queue size in a QoS control field of a frame (e.g., QoS Data frame or QoS Null frame) and sending the frame to an AP (e.g., AP 460). For example, in response to a buffer status report request (e.g., BSRP trigger frame) from an AP (e.g., AP 460), a receiver STA (e.g., device 470) may send a QoS data frame or a QoS Data CF (contention free)-ACK frame 1010 to the AP to report buffer status data relating to UL traffic for a particular TID (traffic identifier). In the QoS control field of the frame 1010, the STA may set (1) the subfield 1001 to a TID; (2) the subfield 1002 to 1; (3) the subfield 1003 to an Ack policy indicator; (4) the subfield 1004 to a value indicating that A-MSDU (aggregated MAC service data unit) is present; and/or (5) the subfield 1005 to a queue size of UL traffic for the TID set in the subfield 1001. In response to a buffer status report request from the AP, a receiver STA may send a QoS Null frame 1020 to the AP to report buffer status data relating to UL traffic for a particular TID. In the QoS control field of the frame 1020, the STA may set (1) the subfield 1001 to a TID; (2) the subfield 1002 to 1; (3) the subfield 1003 to an Ack policy indicator; and/or (4) the subfield 1005 to a queue size of UL traffic for the TID set in the subfield

1001. For a QoS Null frame, the subfield **1004** may not be used (or may be “reserved”) in reporting buffer status data. **[0099]** FIG. **10B** illustrates an example format of an aggregate control (A-control) subfield **1050** of a control field for BSR control, according to an example implementation of the present disclosure. The A-control subfield format **1050** of a High Efficiency (HE) variant High Throughput (HT) control field may include the fields of a plurality of HE controls **1060** (including HE control-1 **1060-1**, HE control-2 **1060-2**, . . . , **1060-N**) and a padding **1061**. Each HE control may include the fields of control ID **1070** and control information **1080**. For BSR response, the control ID field **1070** may be set to a value (e.g., 3) indicating BSR (see Table 1). The control information field (or BSR control field) **1080** may include the subfields of ACI (Access Category Identifier) bitmap **1081**, delta TID **1082**, ACI high **1083**, scaling factor **1084**, queue size high **1085**, and/or queue size all **1086**. For example, in response to a buffer status report request (e.g., BSRP trigger frame) from an AP (e.g., AP **460**), a receiver STA (e.g., device **470**) may report its buffer status by specifying a queue size in the ‘queue size all’ subfield **1086** of a frame and sending the frame to the AP. Queue sizes may be reported for ACI indicated in the ACI bitmap subfield **1081**, which indicates the access category (or access categories) for which data stored in the STA’s buffer is intended. Each bit of the ACI bitmap subfield **1081** can indicate the presence of a service intended for a corresponding AC. A value set in the delta TID subfield **1082** may indicate the number of TIDs corresponding to the number of bits in the ACI bitmap subfield **1081** that are set to 1. For example, if (1) the number of bits in the ACI bitmap subfield that are set to 1 equals 1, and (2) the delta TID is set to value 1, the delta TID may indicate 2 TIDs. If the number of bits in the ACI bitmap subfield that are set to 1 equals 0, values 0 to 2 in the delta TID may not be applicable, e.g., may not indicate the number of TIDs. A value set in the queue size all subfield **1086** may indicate/report a combined queue size of all ACs indicated in the ACI bitmap subfield **1081**. A value set in the queue size high subfield **1085** may indicate/report a queue size of ACI indicated in the ACI high subfield **1083**.

TABLE 1

Control ID subfield values		
Control ID value	Meaning	Length of the control information subfield (bits)
0	Triggered response scheduling (TRS)	26
1	Operating mode (OM)	12
2	HE link adaptation (HLA)	26
3	Buffer status report (BSR)	26
4	UL power headroom (UPH)	8
5	Bandwidth query report (BQR)	10
6	Command and status (CAS)	8
7-14	Reserved	
15	Ones need expansion surely (ONES)	26

[0100] A WLAN protocol (e.g., 802.11be) can define a TWT mechanism, e.g., restricted TWT (R-TWT). In a TWT mechanism, STAs can adopt a wake time schedule that makes them wake up on a periodic basis to transmit/receive data. R-TWT can force all other 802.11be-compatible devices to finish/terminate their transmissions before a TWT SP begins. R-TWT may be used to provide prioritized access

and medium access protection to a STA’s p2p traffic. This TWT mechanism (e.g., R-TWT) may require capability to report buffer status for a STA’s p2p traffic to perform efficiently. For instance, an AP may allocate resources during an R-TWT SP for the STA’s p2p traffic, according to the buffer status. During an on-going SP, if the AP can inquire status of a STA’s p2p traffic, it would help efficient operations (e.g., helping the AP to allocate resources efficiently). For example, a STA may indicate an empty buffer for p2p to the AP to indicate that the STA has completed delivering Latency Sensitive Traffic (LST). A TWT SP may be terminated to save power, and the AP can serve other STAs. The STA may indicate non-empty buffer for p2p to the AP close to an SP’s end to convey that the STA still has LST. The SP may be extended to deliver remaining buffered traffic. AP may also inquire buffer status itself to facilitate the above.

[0101] The conventional buffer status report mechanism can report buffer status for a STA’s uplink traffic only. A STA cannot report buffer status of its p2p traffic. For example, a QoS control field in QoS data frames and/or QoS null frames (see FIG. **10A**) cannot indicate or report buffer status of p2p traffic. A BSR control field in an A-control subfield of a HE variant HT control field (see FIG. **10B**) cannot indicate or report buffer status of p2p traffic. There is a need/benefit to define new request methods for a STA to report buffer status of p2p traffic to an AP.

[0102] To address this problem, a QoS control field (e.g., QoS control field **1000**) or a BSR control field (e.g., control information subfield **1080**) may be redefined/repurposed to indicate (a report of) buffer status for p2p traffic. In some implementations, a BSR Control field (or other field) may be modified or redefined to indicate (a report of) p2p traffic. The BSR Control subfield may have an invalid combination of values according to some subfield encoding. For example, setting the ACI bitmap subfield (or other subfield/bit) to 0 and the delta TID subfield (or other subfield/bit) to 0 may be an invalid combination according to a Delta TID encoding. The encoding may be modified or redefined such that when (1) the ACI bitmap subfield (or other subfield/bit) is set to 0 and (2) the delta TID subfield (or other subfield/bit) is set to 0 or any non-applicable numbers (e.g., value 0 to 2), the combination of the values in the ACI bitmap subfield and the delta TID subfield may indicate that buffer status reported in the ‘queue size all’ subfield is for a STA’s p2p traffic. In this case, the ACI high subfield (or other subfield/bit) and the queue size high subfield (or other subfield/bit) may be reserved. In some embodiments, the ‘queue size all’ subfield and the queue size high subfield (or other subfields/bits) may be combined into a single queue size subfield (e.g., 16-bit queue size subfield). In this case, the ACI high subfield (or other alternative subfield/bit) may be reserved.

[0103] In some implementations, a QoS control field (or other field/bits) in QoS data frames and QoS null frames may be modified or redefined to indicate (a report of) p2p traffic. According to some definition of the QoS control field, when a STA sends a QoS null frame including a QoS control field with bit **4** thereof set to 1, bit **7** of the QoS control field may be reserved and bits **8-15** of the QoS control field may indicate a queue size. In some implementations, the bits of the QoS control field (or other field/bits) may be modified or redefined. For example, when bit **4** is set to 1 and bit **7** is set to 0, the queue size may be for a STA’s UL (uplink) traffic, belonging to TID indicated in bits **0-3**. When bit **4** is set to

1 and bit 7 is set to 1, the queue size may be for the STA's p2p traffic and TID subfield (bits 0-3) and bits 5-7 may be reserved, as a non-limiting example.

[0104] In some implementations, a new (type of) BSR-p2p control field, e.g., a BSR-p2p Control field (or other field/bits), may be added and defined for A-Control subfield (or other subfield) of the HE variant HT Control field (or other field). A new control ID may be defined/used to indicate a BSR-p2p frame. For example, a control ID value 7 or any other available value (e.g., 8 to 14 which are reserved in Table 1) may be newly defined and used. See Table 2 which includes the new control ID value. The format of the new control field may include a scaling factor subfield (e.g., 2 bits) and a queue size subfield (e.g., 8 bits). The scaling factor (SF) subfield (or other subfield/bit) may define SF octets, and the queue size subfield (or other subfield/bit) may indicate the amount of buffered p2p traffic in units of SF octets (according to the definition of SF octets as shown in Table 3, for example), that is intended for the STA's peer STA on the p2p link(s).

TABLE 2

Control ID subfield values (new control ID value added)		
Control ID value	Meaning	Length of the control information subfield (bits)
0	Triggered response scheduling (TRS)	26
1	Operating mode (OM)	12
2	HE link adaptation (HLA)	26
3	Buffer status report (BSR)	26
4	UL power headroom (UPH)	8
5	Bandwidth query report (BQR)	10
6	Command and status (CAS)	8
7	Buffer status report for p2p traffic (BSR-p2p)	16
8-14	Reserved	
15	Ones need expansion surely (ONES)	26

TABLE 3

Scaling Factor subfield encoding	
Value in Scaling Factor subfield	Scaling factor, SF (octets)
0	16
1	256
2	2048
3	32768

[0105] In one approach, a first device may include one or more processors. The one or more processors may be configured to generate a first frame including buffer status data corresponding to wireless traffic between the first device and a second device. Each of the first device and the second device may not be an access point. The one or more processors may be configured to wirelessly transmit, via a transceiver, the generated first frame to an access point in a wireless local area network (WLAN).

[0106] In one approach, the one or more processors may be further configured to wirelessly receive, via the transceiver from the access point, a second frame. In response to the second frame, the one or more processors may be configured to generate the first frame.

[0107] In one approach, the wireless traffic may include peer-to-peer (p2p) traffic between the first device and the

second device. In some embodiments, the first frame may include a control identifier field. In generating the first frame, the one or more processors may be configured to set the control identifier field to a value indicating a buffer status report frame.

[0108] In one approach, the first frame may include a bitmap field that includes a plurality of bits corresponding to a plurality of access categories. In generating the first frame, the one or more processors may be configured to set each of the plurality of bits to a first value indicating that there is no traffic associated with an access category corresponding to the bit.

[0109] In one approach, the first frame may include a number of traffic identifiers field indicating a number of traffic identifiers for which there is buffered traffic. In generating the first frame, the one or more processors may be configured to set the number of traffic identifiers field to a second value indicating that the number of traffic identifiers for which there is buffered traffic is zero.

[0110] In one approach, the first frame may include a quality of service (QoS) control field that includes a first field. In generating the first frame, the one or more processors may be configured to set the first field to a value indicating presence of wireless peer-to-peer (p2p) traffic. The QoS control field includes a second field. In generating the first frame, the one or more processors may be configured to set the second field to a value indicating a queue size of the wireless traffic between the first device and the second device.

[0111] In one approach, the first frame may include a control identifier field. In generating the first frame, the one or more processors may be configured to set the control identifier field to a value indicating a peer-to-peer (p2p) buffer status report frame. The first frame may include a queue size field. In generating the first frame, the one or more processors may be configured to set the queue size field to a value indicating a queue size of the wireless traffic between the first device and a second device.

[0112] Embodiments in the present disclosure have at least the following advantages and benefits. Embodiments in the present disclosure can provide useful techniques for a STA to report buffer status of its p2p traffic. In some embodiments, a QoS control field (e.g., QoS control field 1000 in FIG. 10A) or a BSR control field (e.g., control information subfield 1080 in FIG. 10B) may be redefined/repurposed to indicate (report of) buffer status for p2p traffic, thereby defining new request methods for a STA to report buffer status of p2p traffic to an AP.

[0113] FIG. 11 illustrates an example format of a control information subfield (or BSR control subfield) 1100 of an A-control subfield for reporting buffer status for p2p traffic, according to an example implementation of the present disclosure. The control information field (or BSR control field) 1100 may include the subfields of ACI bitmap 1101, delta TID 1102, ACI high 1103, scaling factor 1104, queue size high 1105, and/or queue size all 1106. In some implementations, the BSR Control subfield (or other field) 1100 may be modified or redefined to indicate (report of) p2p traffic. The BSR Control subfield may have an invalid combination of values according to some subfield encoding. For example, setting the ACI bitmap subfield (or other subfield/bit) to 0 and the delta TID subfield (or other subfield/bit) to 0-2 may be an invalid combination according to a Delta TID encoding. The encoding may be modified or

redefined such that when (1) the ACI bitmap subfield **1101** (or other subfield/bit) is set to 0 and (2) the delta TID subfield **1102** (or other subfield/bit) is set to 0 or any previously non-applicable number M (e.g., $0 \leq M \leq 2$), the combination of the values in the ACI bitmap subfield and the delta TID subfield may indicate that buffer status reported in the queue size all subfield **1106** is for a STA's p2p traffic. In this case, the ACI high subfield **1103** (or other subfield/bit) and the queue size high subfield **1105** (or other subfield/bit) may be reserved. For example, in response to a buffer status report request (e.g., BSRP trigger frame) from an AP (e.g., AP **460**), a receiver STA (e.g., device **470**) may report its buffer status for p2p traffic to/from a peer device (e.g., device **480**) by (1) setting both the ACI bitmap subfield **1101** and the delta TID subfield **1102** of a frame to 0, (2) specifying a queue size for the p2p traffic in the queue size all subfield **1106** of the frame, and (3) sending the frame to the AP. In some embodiments, the queue size all subfield **1106** and the queue size high subfield **1105** (or other subfields/bits) may be combined into a single queue size subfield (e.g., 16-bit queue size subfield). In this case, the ACI high subfield **1103** (or other alternative subfield/bit) may be reserved.

[0114] FIG. 12 illustrates an example QoS control field format **1200** for reporting buffer status for p2p traffic, according to an example implementation of the present disclosure. The QoS control field format **1200** may include subfield **1201** (bits **0-3**), subfield **1202** (bit **4**), subfield **1203** (bits **5-6**), subfield **1204** (bit **7**), and/or subfield **1205** (bits **8-15**). In some implementations, a QoS control field (or other field/bits) in QoS data frames and QoS null frames may be modified or redefined to indicate (report of) p2p traffic. According to some definition of the QoS control field (e.g., QoS control field **1000** in FIG. 10A), when a STA sends a QoS null frame (e.g., QoS Null frame **1020**) including a QoS control field with bit **4** (e.g., subfield **1002**) thereof set to 1, bit **7** of the QoS control field (e.g., subfield **1004**) may be reserved and bits **8-15** of the QoS control field (e.g., subfield **1005**) may indicate a queue size. In some implementations, the bits of the QoS control field (or other field/bits) may be modified or redefined. Referring to FIG. 12, when the subfield **1202** (bit **4**) of a QoS Null frame **1220** is set to 1 and the subfield **1204** (bit **7**) of the QoS Null frame **1220** is set to 0, the queue size set in the subfield **1205** may be for a STA's UL traffic, belonging to TID indicated in the subfield **1201** (bits **0-3**). When the subfield **1202** (bit **4**) is set to 1 and the subfield **1204** (bit **7**) is set to 1, the queue size may be for the STA's p2p traffic and the TID subfield **1201** (bits **0-3**) and the subfield **1203** (bits **5-6**) may be reserved, as a non-limiting example. For example, in response to a buffer status report request (e.g., BSRP trigger frame) from an AP (e.g., AP **460**), a receiver STA (e.g., device **470**) may report its buffer status for p2p traffic to/from a peer device (e.g., device **480**) by (1) setting both the subfield **1202** (bit **4**) and the subfield **1204** (bit **7**) of a QoS Null frame to 1, (2) specifying a queue size for the p2p traffic in the subfield **1205** (bits **8-15**) of the QoS Null frame, and (3) sending the QoS Null frame to the AP.

[0115] FIG. 13 illustrates an example format of an A-control subfield **1300** of a control field for reporting buffer status for p2p traffic, according to an example implementation of the present disclosure. The A-control subfield format **1300** of a HE variant HT control field may include the fields of a plurality of HE controls **1310** (including HE control-1

1310-1, HE control-2 **1310-2**, . . . , **1310-N**) and a padding **1311**. Each HE control may include the fields of control ID **1320** and control information **1330**. In some implementations, a new (type of) BSR-p2p control field, e.g., a BSR-p2p Control field (or other field/bits), may be added and defined for A-Control subfield (or other subfield) of the HE variant HT Control field (or other field). A new control ID may be defined/used to indicate a BSR-p2p frame. For example, a control ID value 7 or any other available value (e.g., 8 to 14 which are reserved in Table 1) may be newly/specifically defined and used. See Table 2 which includes the new/specific control ID value. For BSR-p2p response, the control ID field **1320** may be set to a new/specific value (e.g., 7) indicating BSR-p2p (see Table 2). The control information field (or BSR control field) **1330** may include the subfields of scaling factor **1331**, queue size **1332**, and/or reserved **1333**. In some implementations, the scaling factor subfield **1331** may be 2 bits and the queue size subfield **1332** may be 8 bits. The scaling factor (SF) subfield **1331** may define SF octets, and the queue size subfield **1332** may indicate the amount of buffered p2p traffic in units of SF octets (according to the definition of SF octets as shown in Table 3, for example), that is intended for the STA's peer STA on the p2p link(s). For example, in response to a buffer status report request (e.g., BSRP trigger frame) from an AP (e.g., AP **460**), a receiver STA (e.g., device **470**) may report its buffer status for p2p traffic to/from a peer device (e.g., device **480**) by (1) setting the control ID subfield **1320** of a frame to the new value indicating BSR-p2p, (2) specifying a queue size for the p2p traffic in the queue size subfield **1332** of the frame, and (3) sending the frame to the AP.

[0116] FIG. 14 is a flowchart showing a process **1400** of reporting buffer status for p2p traffic, according to an example implementation of the present disclosure. In some embodiments, the process **1400** is performed by a first device (e.g., STA device **470** or **490**). In some embodiments, the process **1400** is performed by other entities. In some embodiments, the process **1400** includes more, fewer, or different steps than shown in FIG. 14.

[0117] In one approach, the first device (e.g., device **470**) may generate **1402** a first frame (e.g., a frame including a control information subfield **1100**, a QoS Null frame including a QoS control field **1200**, a frame including an A-Control subfield **1300** for reporting buffer status for p2p traffic) including buffer status data corresponding to wireless traffic (e.g., p2p traffic **474**) between the first device (e.g., device **470**) and a second device (e.g., device **480**). Each of the first device and the second device may not be an access point.

[0118] In some embodiments, the first device may wirelessly receive, via the transceiver from an access point (e.g., AP **460**), a second frame (e.g., BSRP trigger frames as shown in FIG. 5A to FIG. 8). In response to the second frame, the first device may generate the first frame. In some embodiments, the wireless traffic may include peer-to-peer (p2p) traffic between the first device and the second device (e.g., p2p traffic **474**). In some embodiments, the first frame may include a control identifier field (e.g., control ID subfield **1070**). In generating the first frame, the first device may set the control identifier field to a value indicating a buffer status report frame (e.g., a value 3 indicating BSR as shown in Table 1 and Table 2), because this method reuse/define the existing A-Control subfield format for reporting buffer status for UL/DL traffic.

[0119] In some embodiments, the first frame (e.g., a frame including a control information subfield **1100**) may include a bitmap field (e.g., ACI bitmap **1101**) that includes a plurality of bits corresponding to a plurality of access categories. In generating the first frame, the first device may set each of the plurality of bits to a first value (e.g., 0) indicating that there is no traffic associated with an access category corresponding to the bit. The first frame may include a number of traffic identifiers field (e.g., delta TID **1102**) indicating a number of traffic identifiers for which there is buffered traffic. In generating the first frame, the first device may set the number of traffic identifiers field to a second value (e.g., 0) indicating that the number of traffic identifiers for which there is buffered traffic is zero.

[0120] In some embodiments, the first frame may include a quality of service (QoS) control field (e.g., QoS control field **1200**) that includes a first field (e.g., subfield **1204**). In generating the first frame, the first device may set the first field (e.g., subfield **1204**) to a value (e.g., 1) indicating presence of wireless peer-to-peer (p2p) traffic. The QoS control field includes a second field (e.g., subfield **1205**). In generating the first frame, the first device may set the second field (e.g., subfield **1205**) to a value indicating a queue size of the wireless traffic (e.g., p2p traffic **474**) between the first device (e.g., device **470**) and the second device (e.g., device **480**).

[0121] In some embodiments, the first frame may include a control identifier field (e.g., control ID **1320**). In generating the first frame, the first device may set the control identifier field to a value (e.g., value 7) indicating a peer-to-peer (p2p) buffer status report frame (see Table 2). The first frame may include a queue size field (e.g., queue size **1332**). In generating the first frame, the first device may set the queue size field to a value indicating a queue size of the wireless traffic (e.g., p2p traffic **474**) between the first device (e.g., device **470**) and a second device (e.g., device **480**).

[0122] In one approach, the first device may wirelessly transmit **1404**, via a transceiver of the first device, the generated first frame to an access point (e.g., AP **460**) in a wireless local area network (WLAN).

[0123] Having now described some illustrative implementations, it is apparent that the foregoing is illustrative and not limiting, having been presented by way of example. In particular, although many of the examples presented herein involve specific combinations of method acts or system elements, those acts and those elements can be combined in other ways to accomplish the same objectives. Acts, elements and features discussed in connection with one implementation are not intended to be excluded from a similar role in other implementations or implementations.

[0124] The hardware and data processing components used to implement the various processes, operations, illustrative logics, logical blocks, modules and circuits described in connection with the embodiments disclosed herein may be implemented or performed with a general purpose single- or multi-chip processor, a digital signal processor (DSP), an application specific integrated circuit (ASIC), a field programmable gate array (FPGA), or other programmable logic device, discrete gate or transistor logic, discrete hardware components, or any combination thereof designed to perform the functions described herein. A general purpose processor may be a microprocessor, or, any conventional processor, controller, microcontroller, or state machine. A processor also may be implemented as a combination of

computing devices, such as a combination of a DSP and a microprocessor, a plurality of microprocessors, one or more microprocessors in conjunction with a DSP core, or any other such configuration. In some embodiments, particular processes and methods may be performed by circuitry that is specific to a given function. The memory (e.g., memory, memory unit, storage device, etc.) may include one or more devices (e.g., RAM, ROM, Flash memory, hard disk storage, etc.) for storing data and/or computer code for completing or facilitating the various processes, layers and modules described in the present disclosure. The memory may be or include volatile memory or non-volatile memory, and may include database components, object code components, script components, or any other type of information structure for supporting the various activities and information structures described in the present disclosure. According to an exemplary embodiment, the memory is communicably connected to the processor via a processing circuit and includes computer code for executing (e.g., by the processing circuit and/or the processor) the one or more processes described herein.

[0125] The present disclosure contemplates methods, systems and program products on any machine-readable media for accomplishing various operations. The embodiments of the present disclosure may be implemented using existing computer processors, or by a special purpose computer processor for an appropriate system, incorporated for this or another purpose, or by a hardwired system. Embodiments within the scope of the present disclosure include program products comprising machine-readable media for carrying or having machine-executable instructions or data structures stored thereon. Such machine-readable media can be any available media that can be accessed by a general purpose or special purpose computer or other machine with a processor. By way of example, such machine-readable media can comprise RAM, ROM, EPROM, EEPROM, or other optical disk storage, magnetic disk storage or other magnetic storage devices, or any other medium which can be used to carry or store desired program code in the form of machine-executable instructions or data structures and which can be accessed by a general purpose or special purpose computer or other machine with a processor. Combinations of the above are also included within the scope of machine-readable media. Machine-executable instructions include, for example, instructions and data which cause a general purpose computer, special purpose computer, or special purpose processing machines to perform a certain function or group of functions.

[0126] The phraseology and terminology used herein is for the purpose of description and should not be regarded as limiting. The use of “including” “comprising” “having” “containing” “involving” “characterized by” “characterized in that” and variations thereof herein, is meant to encompass the items listed thereafter, equivalents thereof, and additional items, as well as alternate implementations consisting of the items listed thereafter exclusively. In one implementation, the systems and methods described herein consist of one, each combination of more than one, or all of the described elements, acts, or components.

[0127] Any references to implementations or elements or acts of the systems and methods herein referred to in the singular can also embrace implementations including a plurality of these elements, and any references in plural to any implementation or element or act herein can also

embrace implementations including only a single element. References in the singular or plural form are not intended to limit the presently disclosed systems or methods, their components, acts, or elements to single or plural configurations. References to any act or element being based on any information, act or element can include implementations where the act or element is based at least in part on any information, act, or element.

[0128] Any implementation disclosed herein can be combined with any other implementation or embodiment, and references to “an implementation,” “some implementations,” “one implementation” or the like are not necessarily mutually exclusive and are intended to indicate that a particular feature, structure, or characteristic described in connection with the implementation can be included in at least one implementation or embodiment. Such terms as used herein are not necessarily all referring to the same implementation. Any implementation can be combined with any other implementation, inclusively or exclusively, in any manner consistent with the aspects and implementations disclosed herein.

[0129] Where technical features in the drawings, detailed description or any claim are followed by reference signs, the reference signs have been included to increase the intelligibility of the drawings, detailed description, and claims. Accordingly, neither the reference signs nor their absence have any limiting effect on the scope of any claim elements.

[0130] Systems and methods described herein may be embodied in other specific forms without departing from the characteristics thereof. References to “approximately,” “about” “substantially” or other terms of degree include variations of +/-10% from the given measurement, unit, or range unless explicitly indicated otherwise. Coupled elements can be electrically, mechanically, or physically coupled with one another directly or with intervening elements. Scope of the systems and methods described herein is thus indicated by the appended claims, rather than the foregoing description, and changes that come within the meaning and range of equivalency of the claims are embraced therein.

[0131] The term “coupled” and variations thereof includes the joining of two members directly or indirectly to one another. Such joining may be stationary (e.g., permanent or fixed) or moveable (e.g., removable or releasable). Such joining may be achieved with the two members coupled directly with or to each other, with the two members coupled with each other using a separate intervening member and any additional intermediate members coupled with one another, or with the two members coupled with each other using an intervening member that is integrally formed as a single unitary body with one of the two members. If “coupled” or variations thereof are modified by an additional term (e.g., directly coupled), the generic definition of “coupled” provided above is modified by the plain language meaning of the additional term (e.g., “directly coupled” means the joining of two members without any separate intervening member), resulting in a narrower definition than the generic definition of “coupled” provided above. Such coupling may be mechanical, electrical, or fluidic.

[0132] References to “or” can be construed as inclusive so that any terms described using “or” can indicate any of a single, more than one, and all of the described terms. A reference to “at least one of ‘A’ and ‘B’” can include only ‘A’, only ‘B’, as well as both ‘A’ and ‘B’. Such references

used in conjunction with “comprising” or other open terminology can include additional items.

[0133] Modifications of described elements and acts such as variations in sizes, dimensions, structures, shapes and proportions of the various elements, values of parameters, mounting arrangements, use of materials, colors, orientations can occur without materially departing from the teachings and advantages of the subject matter disclosed herein. For example, elements shown as integrally formed can be constructed of multiple parts or elements, the position of elements can be reversed or otherwise varied, and the nature or number of discrete elements or positions can be altered or varied. Other substitutions, modifications, changes and omissions can also be made in the design, operating conditions and arrangement of the disclosed elements and operations without departing from the scope of the present disclosure.

[0134] References herein to the positions of elements (e.g., “top,” “bottom,” “above,” “below”) are merely used to describe the orientation of various elements in the FIGURES. The orientation of various elements may differ according to other exemplary embodiments, and that such variations are intended to be encompassed by the present disclosure.

What is claimed is:

1. An access point comprising:

one or more processors configured to:

generate a first frame to trigger a receiver device to send a response frame that comprises buffer status data corresponding to wireless traffic between the receiver device and another device; and

wirelessly transmit, via a transmitter, the generated first frame to one or more devices.

2. The access point according to claim 1, wherein the wireless traffic comprises peer-to-peer (p2p) traffic between the receiver device and the another device.

3. The access point according to claim 1, wherein in generating the first frame, the one or more processors are configured to:

set a frame type field of the first frame to a type indicating a buffer status trigger frame.

4. The access point according to claim 1, wherein:

the first frame includes a first User Info field that relates to a first device, and

in generating the first frame, the one or more processors are configured to set a subfield of the first User Info field to a first value indicating a buffer status request for wireless traffic between the first device and a second device.

5. The access point according to claim 4, wherein:

the first frame includes a second User Info field relating to a third device, and

in generating the first frame, the one or more processors are configured to:

set a subfield of the second User Info field to a second value indicating a buffer status request for wireless traffic between the access point and the third device, to trigger the third device to send a response frame that comprises buffer status data corresponding to the wireless traffic between the access point and the third device.

- 6.** The access point according to claim 1, wherein:
the first frame includes a Common Info field carrying information that is relevant to a plurality of users or receiver devices, and
in generating the first frame, the one or more processors are configured to set a subfield of the Common Info field to a value indicating a buffer status request for wireless traffic between the receiver device and the another device.
- 7.** The access point according to claim 1, wherein:
the first frame includes a Common Info field, and
in generating the first frame, the one or more processors are configured to set a subfield of the Common Info field to a value to trigger a plurality of users or receiver devices to send respective response frames that comprise respective buffer status data corresponding to peer-to-peer (p2p) traffic.
- 8.** The access point according to claim 1, wherein
the first frame includes a frame type field, and
in generating the first frame, the one or more processors are configured to:
set the frame type field to a type indicating a buffer status trigger frame for peer-to-peer (p2p) traffic.
- 9.** The access point according to claim 8, wherein
the first frame includes a Common Info field carrying information that is relevant to a plurality of users or receiver devices, and
the frame type field is a subfield of the Common Info field.
- 10.** The access point according to claim 1, wherein
the first frame includes a frame type field, and
in generating the first frame, the one or more processors are configured to:
set the frame type field to a type to trigger a plurality of users or receiver devices to send respective response frames that comprise respective buffer status data corresponding to wireless peer-to-peer (p2p) traffic.
- 11.** A method comprising:
generating, by an access point, a first frame to trigger a receiver device to send a response frame that comprises buffer status data corresponding to wireless traffic between the receiver device and another device; and
wirelessly transmitting, via a transmitter of the access point, the generated first frame to one or more devices.
- 12.** The method according to claim 11, wherein the wireless traffic comprises peer-to-peer (p2p) traffic between the receiver device and the another device.
- 13.** The method according to claim 11, wherein generating the first frame comprises:
setting a frame type field of the first frame to a type indicating a buffer status trigger frame.
- 14.** The method according to claim 11, wherein:
the first frame includes a first User Info field that relates to a first device, and
generating the first frame comprises setting a subfield of the first User Info field to a first value indicating a buffer status request for wireless traffic between the first device and a second device.
- 15.** The method according to claim 14, wherein:
the first frame includes a second User Info field relating to a third device, and
generating the first frame comprises:
setting a subfield of the second User Info field to a second value indicating a buffer status request for wireless traffic between the access point and the third device, to trigger the third device to send a response frame that comprises buffer status data corresponding to the wireless traffic between the access point and the third device.
- 16.** The method according to claim 11, wherein:
the first frame includes a Common Info field carrying information that is relevant to a plurality of users or receiver devices, and
generating the first frame comprises setting a subfield of the Common Info field to a value indicating a buffer status request for wireless traffic between the receiver device and the another device.
- 17.** The method according to claim 11, wherein:
the first frame includes a Common Info field, and
generating the first frame comprises:
setting a subfield of the Common Info field to a value to trigger a plurality of users or receiver devices to send respective response frames that comprise respective buffer status data corresponding to peer-to-peer (p2p) traffic.
- 18.** The method according to claim 11, wherein
the first frame includes a frame type field, and
generating the first frame comprises:
setting the frame type field to a type indicating a buffer status trigger frame for peer-to-peer (p2p) traffic.
- 19.** The method according to claim 18, wherein
the first frame includes a Common Info field carrying information that is relevant to a plurality of users or receiver devices, and
the frame type field is a subfield of the Common Info field.
- 20.** The method according to claim 11, wherein
the first frame includes a frame type field, and
generating the first frame comprises:
setting the frame type field to a type to trigger a plurality of users or receiver devices to send respective response frames that comprise respective buffer status data corresponding to wireless peer-to-peer (p2p) traffic.

* * * * *