



US 20190010518A1

(19) **United States**

(12) **Patent Application Publication**  
**Quake et al.**

(10) **Pub. No.: US 2019/0010518 A1**

(43) **Pub. Date: Jan. 10, 2019**

(54) **COMPOSITIONS AND METHODS OF DELIVERING TREATMENTS FOR LATENT VIRAL INFECTIONS**

**Publication Classification**

(71) Applicant: **The Board of Trustees of the Leland Stanford Junior University**, Stanford, CA (US)

(51) **Int. Cl.**  
*C12N 15/90* (2006.01)  
*C12N 15/86* (2006.01)  
*A61K 48/00* (2006.01)  
*C12N 9/22* (2006.01)

(72) Inventors: **Stephen R. Quake**, Palo Alto, CA (US); **Jianbin Wang**, Palo Alto, CA (US)

(52) **U.S. Cl.**  
CPC ..... *C12N 15/907* (2013.01); *Y02A 50/393* (2018.01); *C12N 15/86* (2013.01); *Y02A 50/385* (2018.01); *Y02A 50/463* (2018.01); *Y02A 50/387* (2018.01); *A61K 38/00* (2013.01); *C12N 2820/60* (2013.01); *A61K 48/005* (2013.01); *C12N 9/22* (2013.01); *Y02A 50/465* (2018.01)

(73) Assignee: **The Board of Trustees of the Leland Stanford Junior University**, Stanford, CA (US)

(21) Appl. No.: **15/877,996**

(22) Filed: **Jan. 23, 2018**

**Related U.S. Application Data**

(63) Continuation of application No. 15/362,519, filed on Nov. 28, 2016, now abandoned, which is a continuation of application No. PCT/US2015/033199, filed on May 29, 2015.

(60) Provisional application No. 62/029,072, filed on Jul. 25, 2014, provisional application No. 62/005,395, filed on May 30, 2014.

**ABSTRACT**

(57) Viral infection is a persistent cause of human disease. Guided nuclease systems of the invention target the genomes of viral infections, rendering the viruses incapacitated. The invention further provides delivery methods and compositions for antiviral therapeutics. Methods and compositions are provided for targeted delivery of antiviral therapeutics into cells of interest using, for example, viral vectors such as adenovirus, AAV, and replication incompetent HSV. These and other delivery systems can be used as vehicles to deliver DNA vectors encoding a nuclease or a cell-killing gene. These delivery methods can also be used to deliver naked DNA or RNA, protein products, plasmids containing a promoter that is active only in a latent viral state which drives a cell-killing gene, or other therapeutic agents.

**Specification includes a Sequence Listing.**

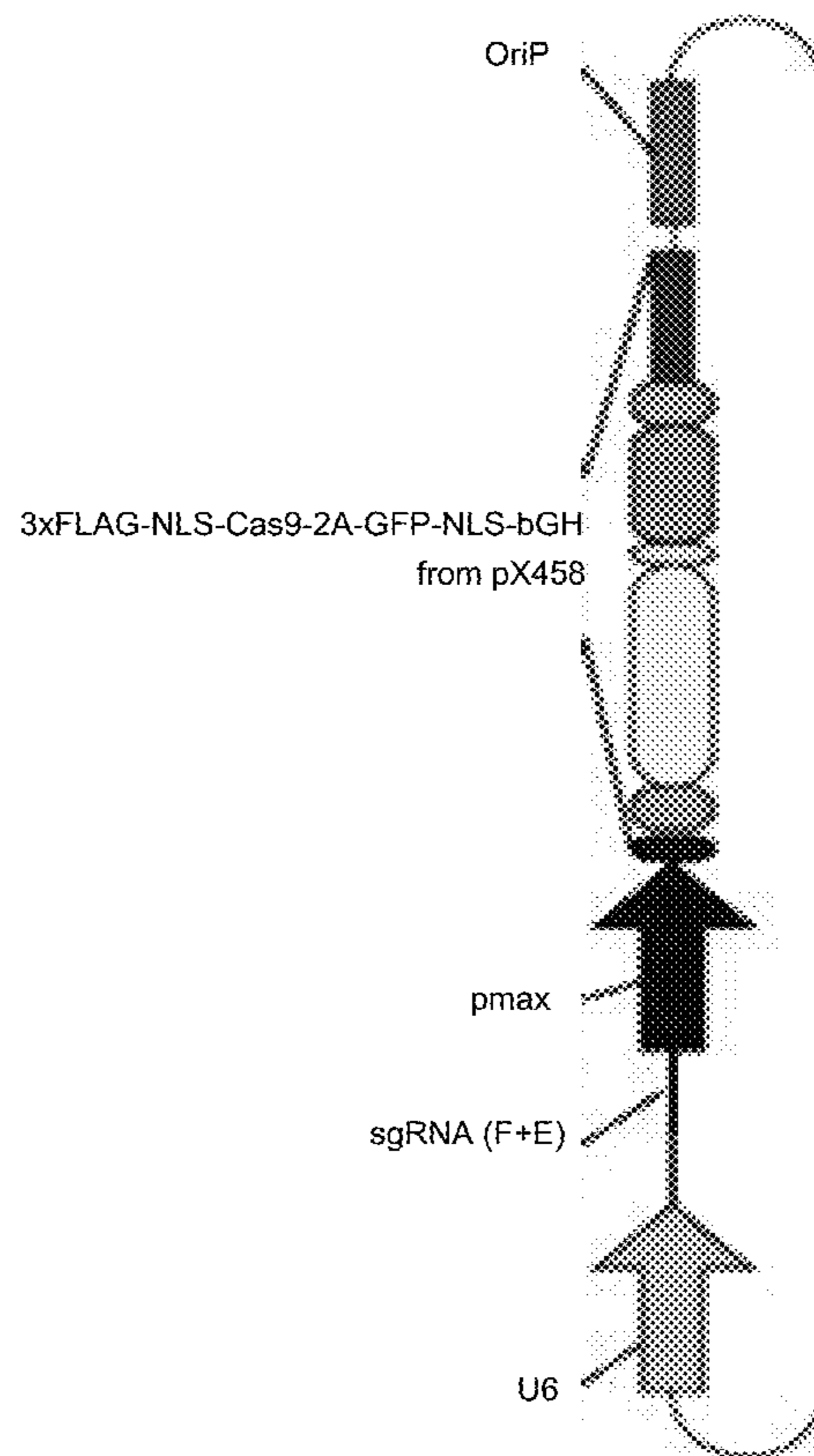

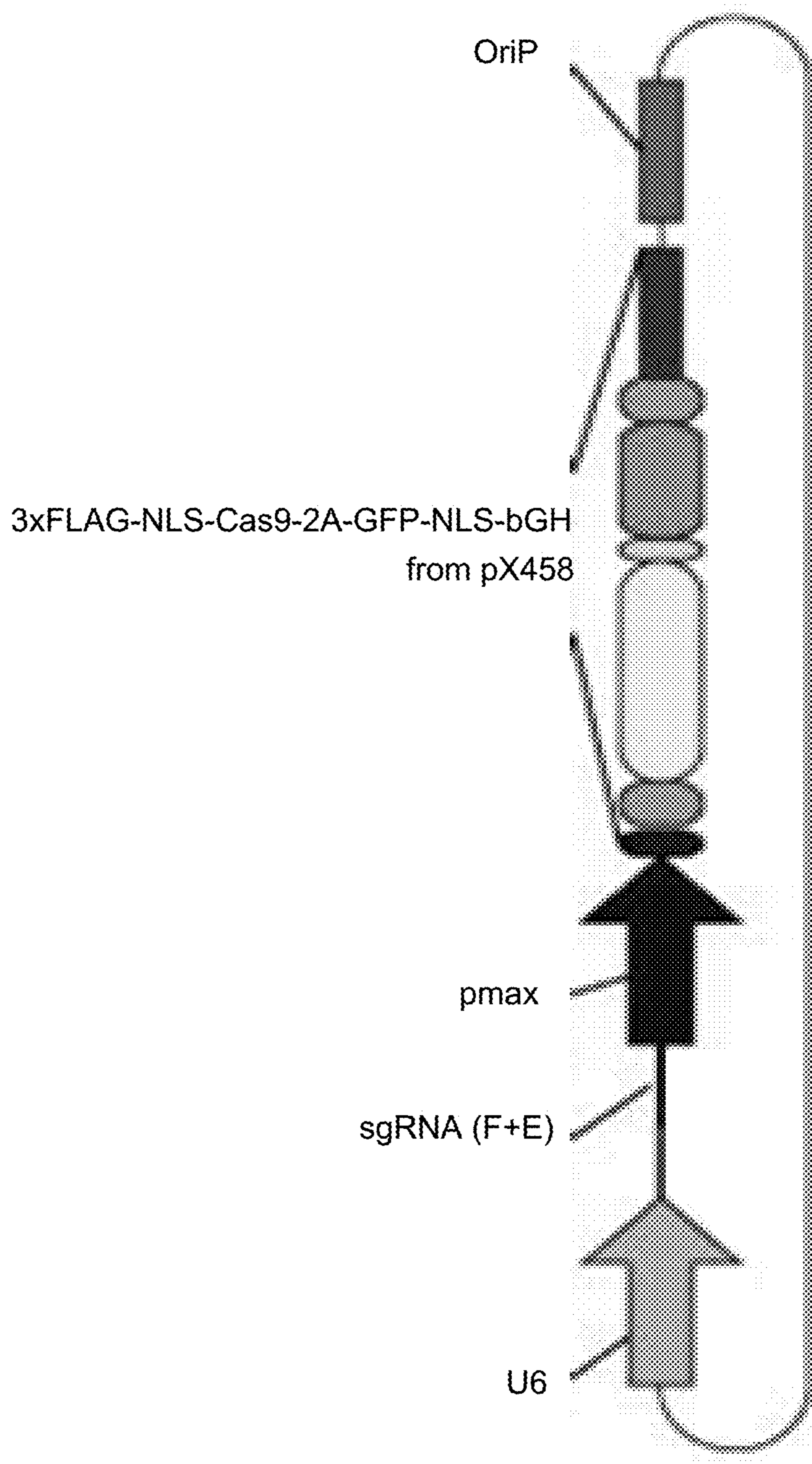

**FIG. 1A**

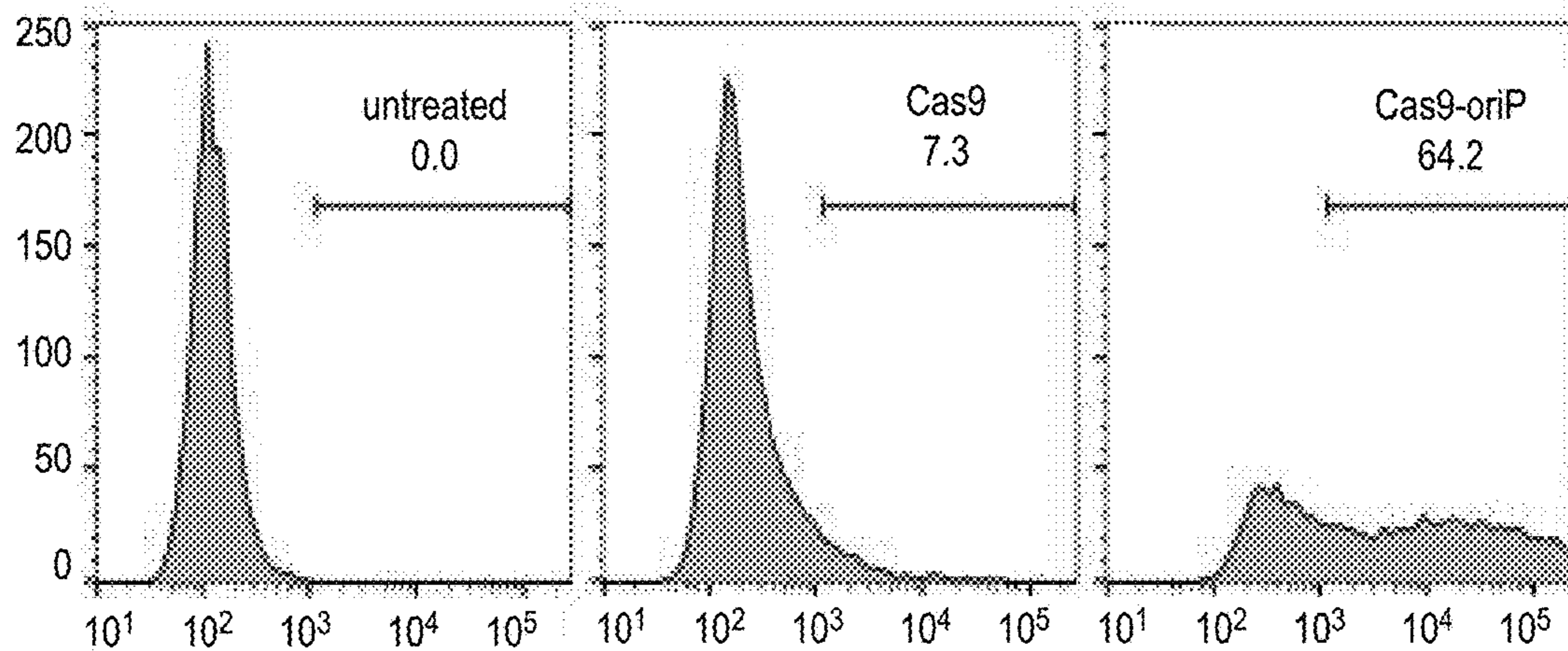

FIG. 1B

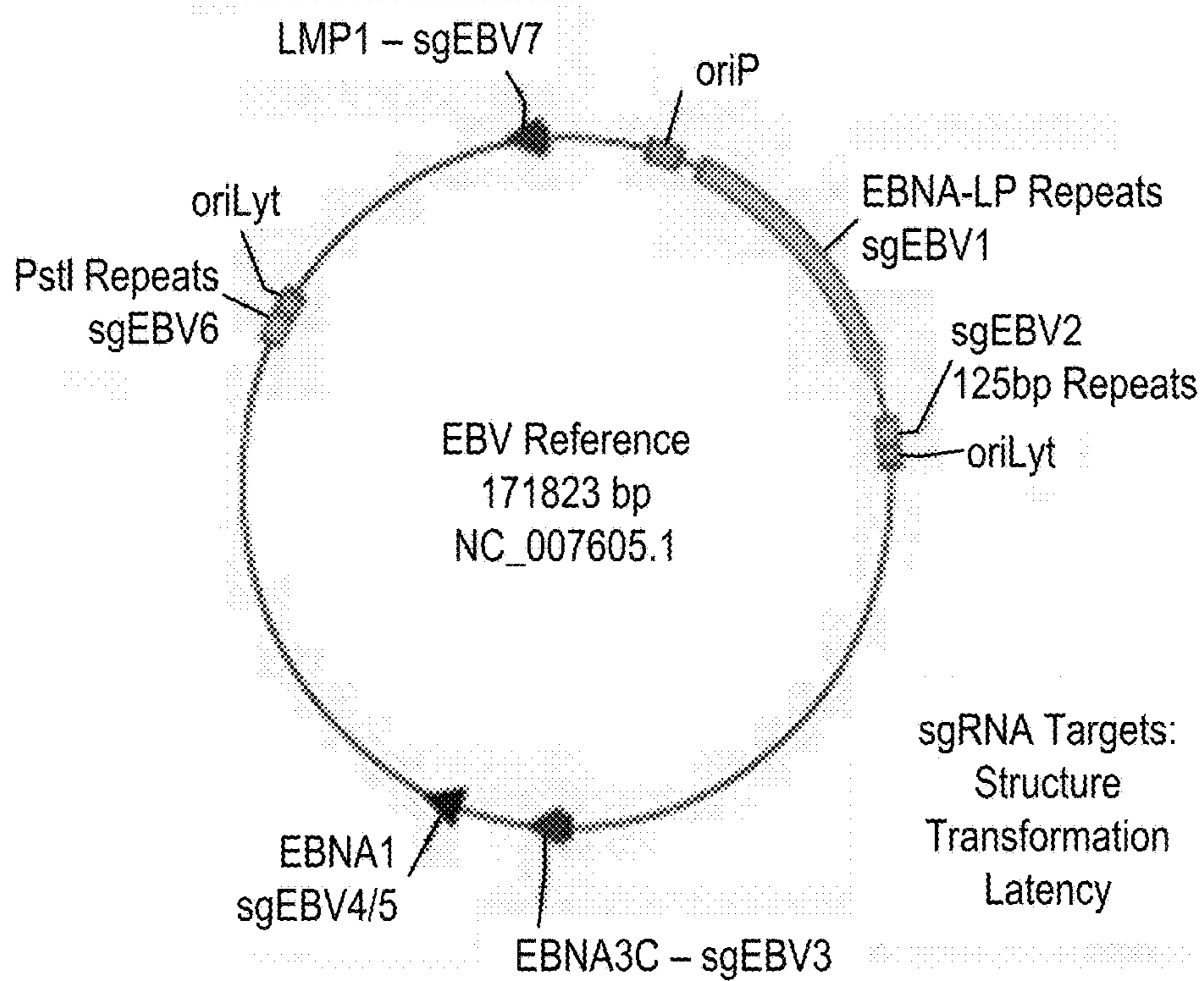

FIG. 1C

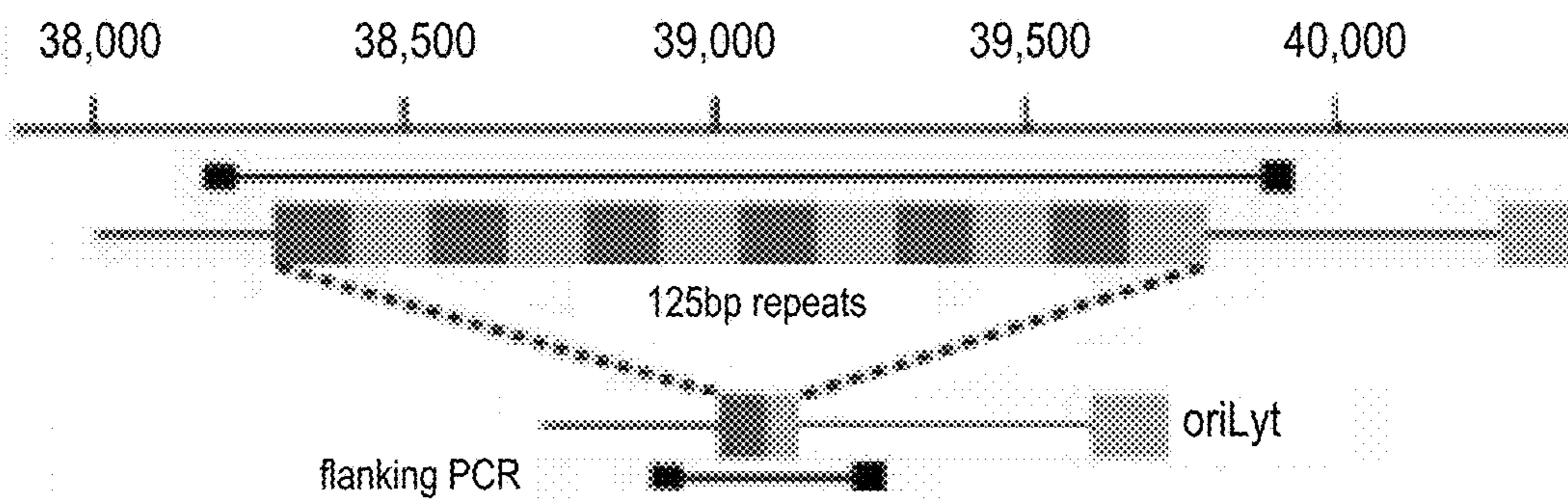

FIG. 2A

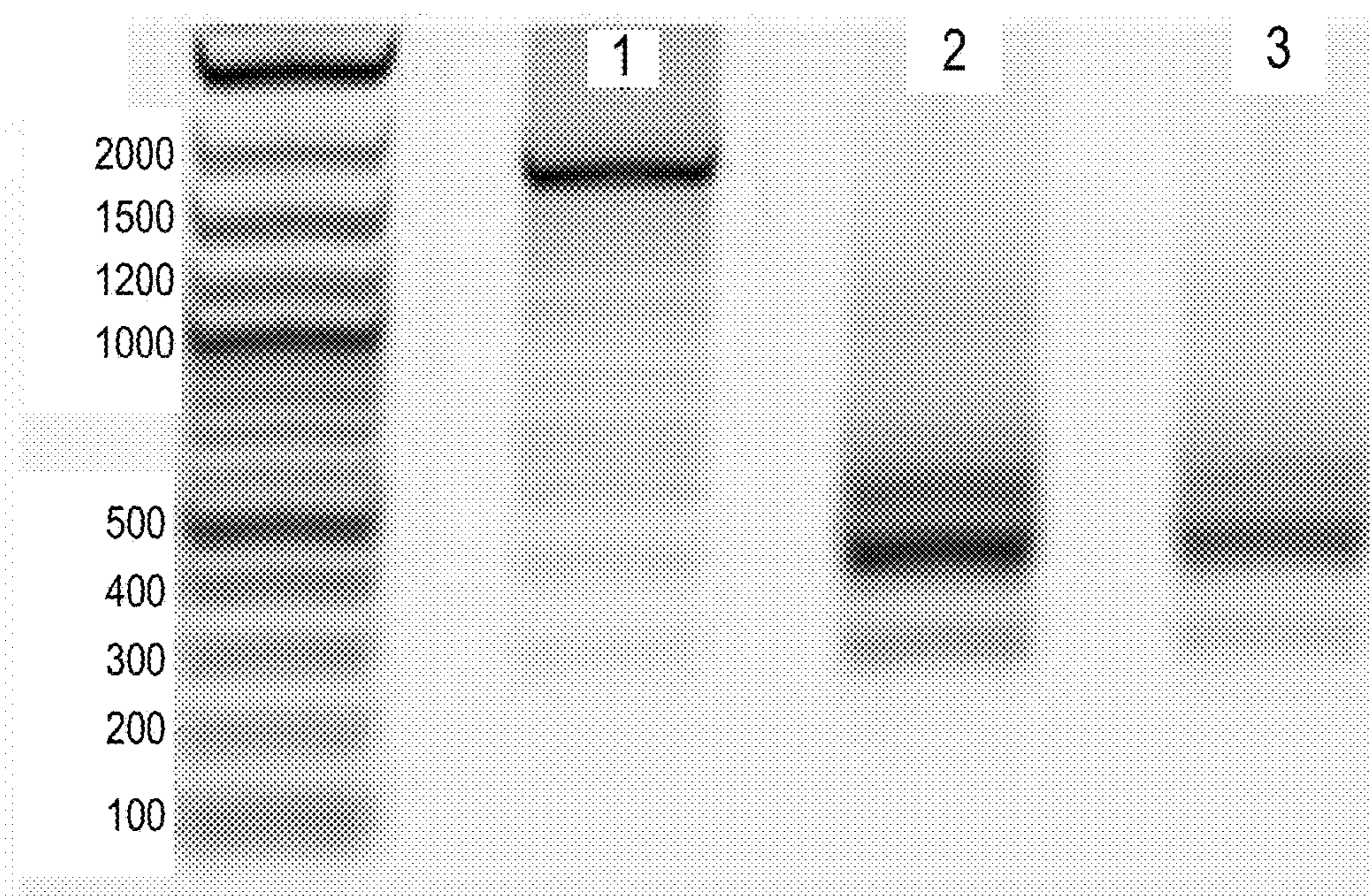

FIG. 2B

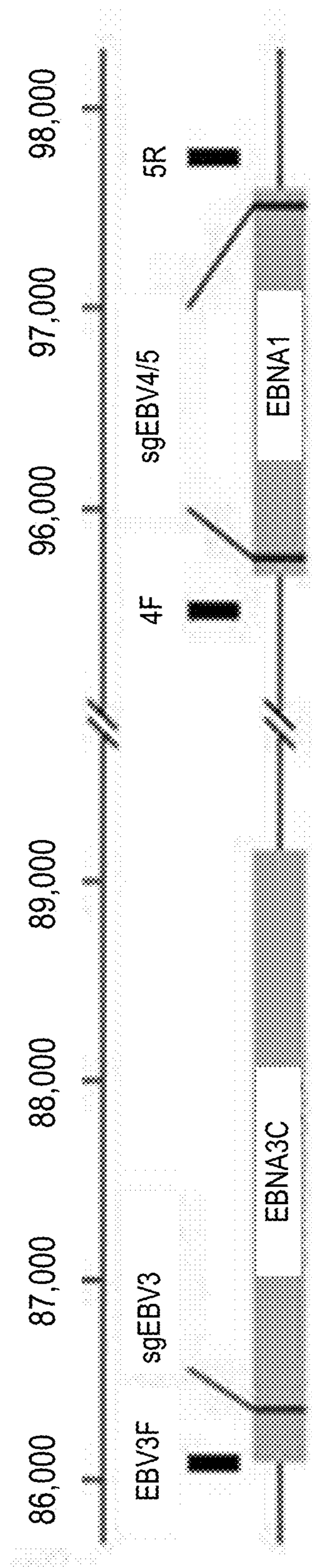
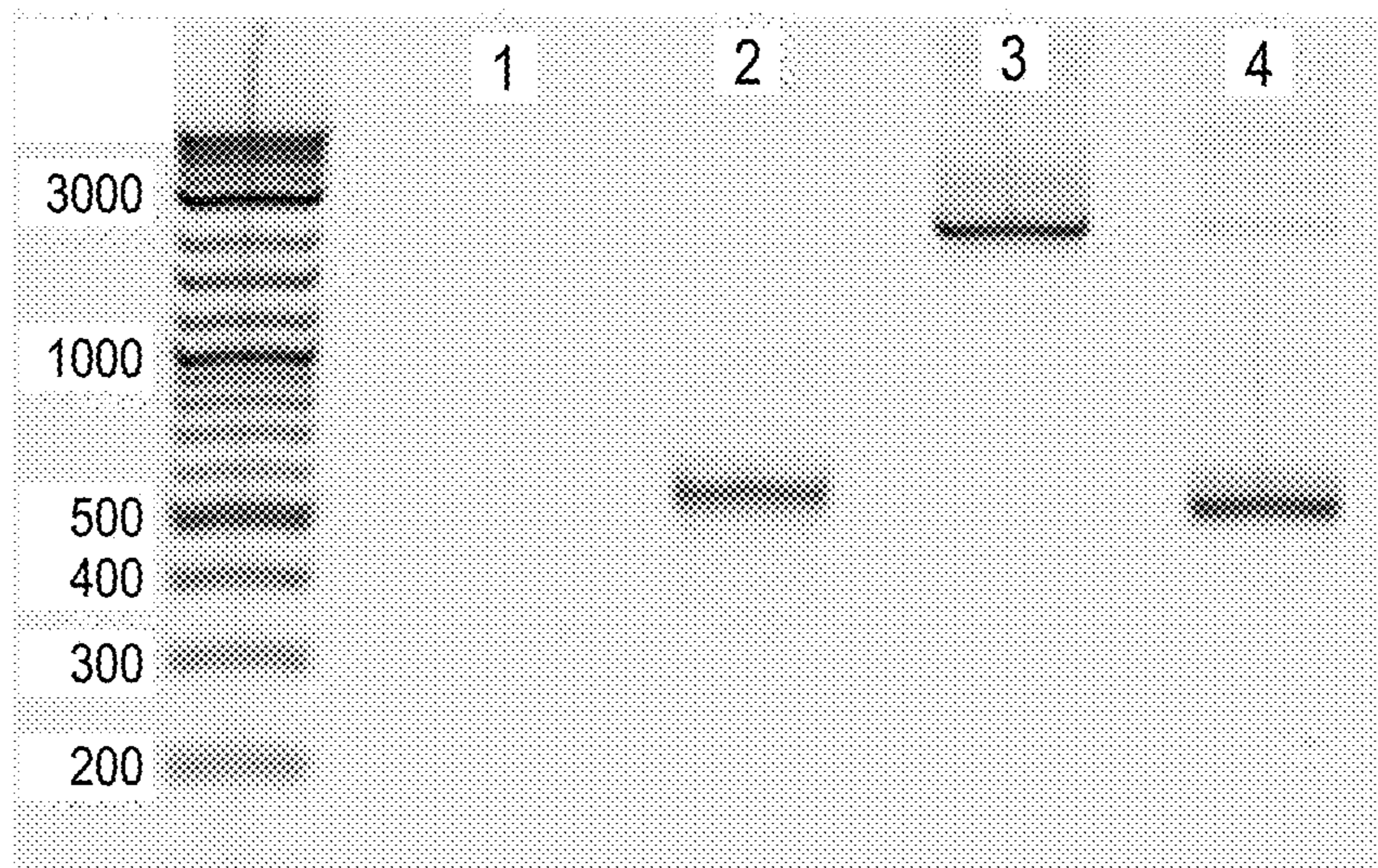
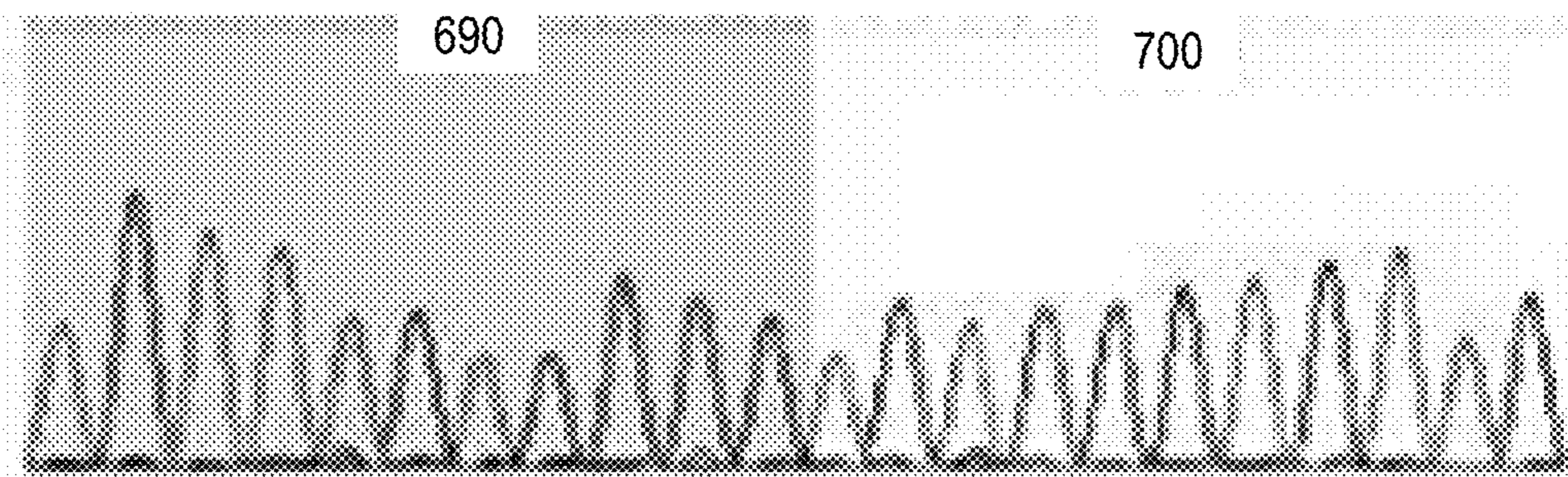

FIG. 2C



**FIG. 2D**



**FIG. 2E**

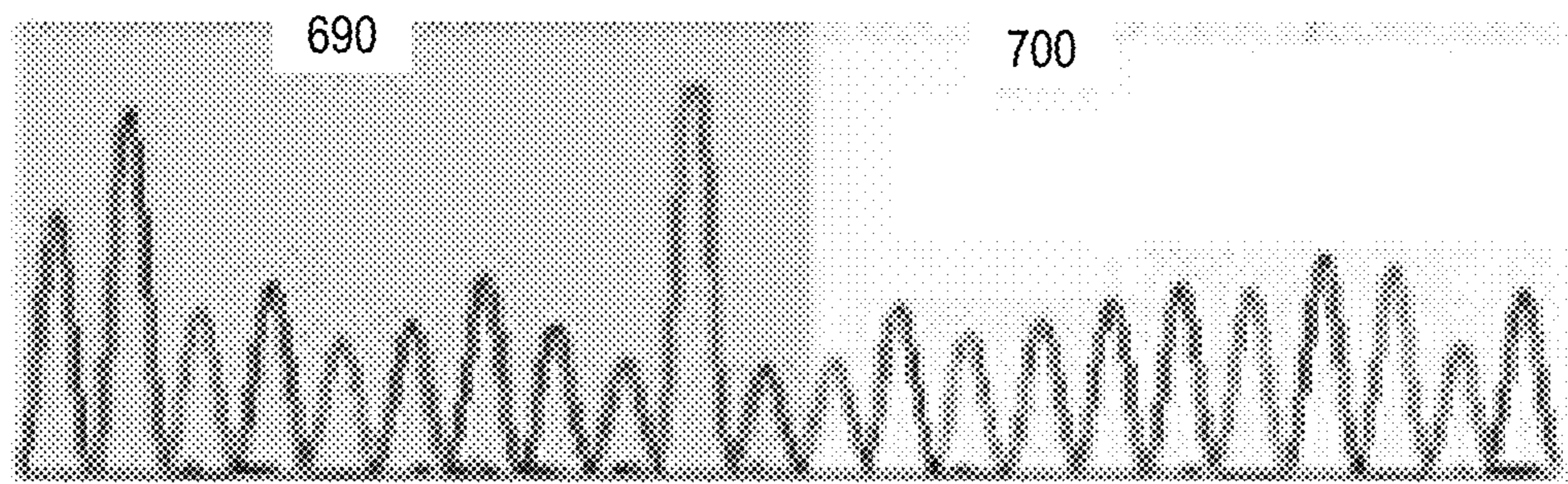

**FIG. 2F**

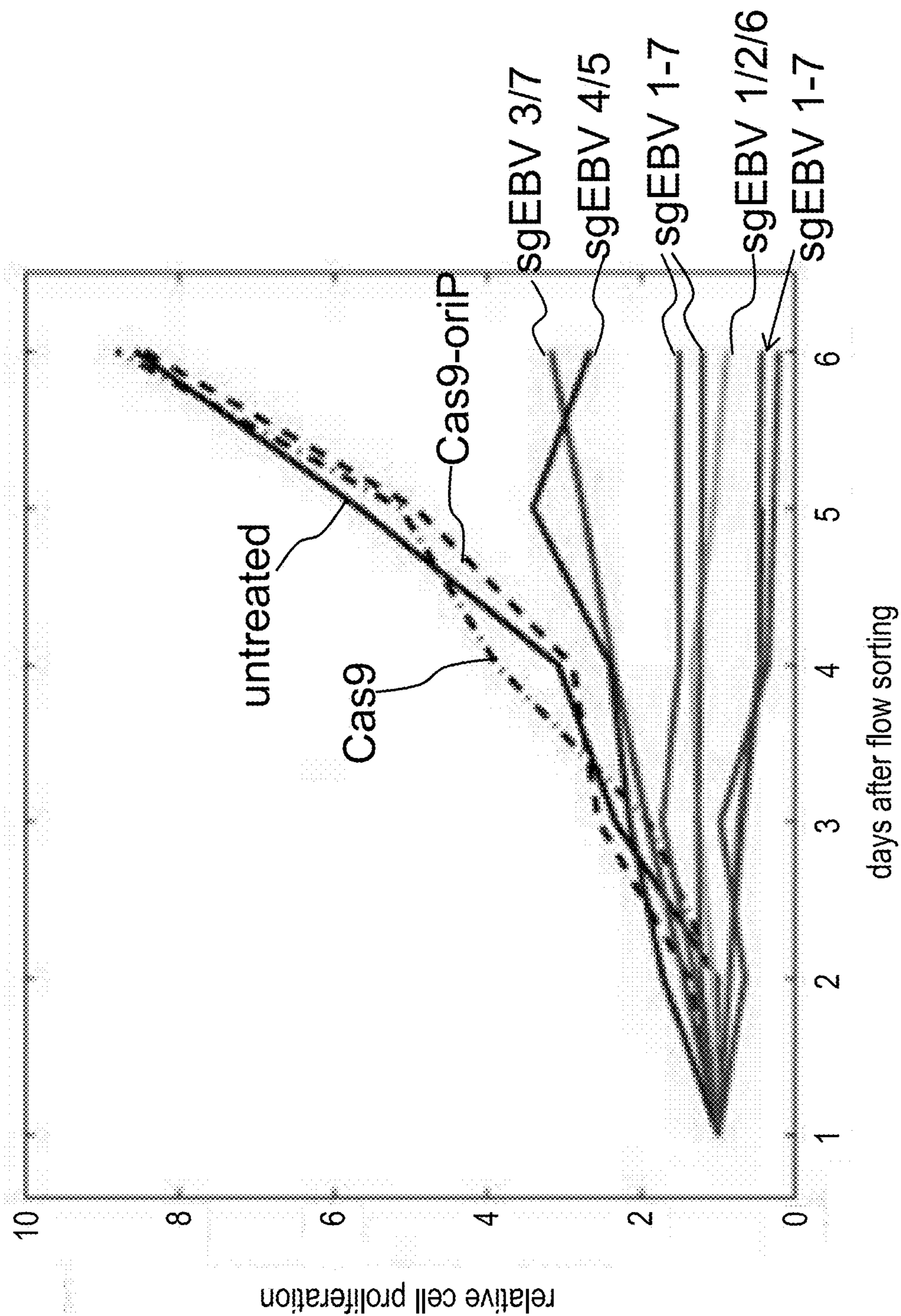

FIG. 3A

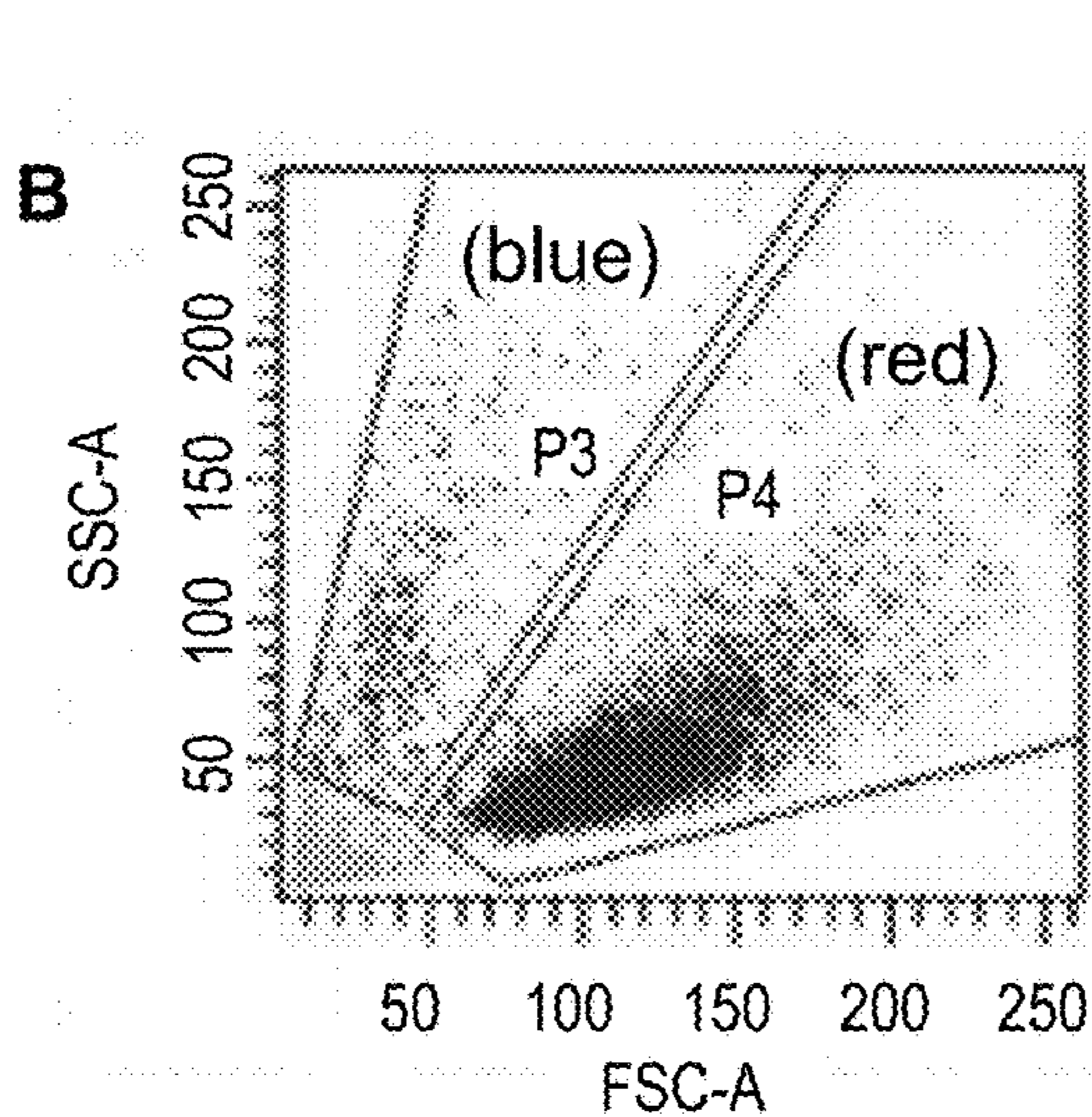

FIG. 3B

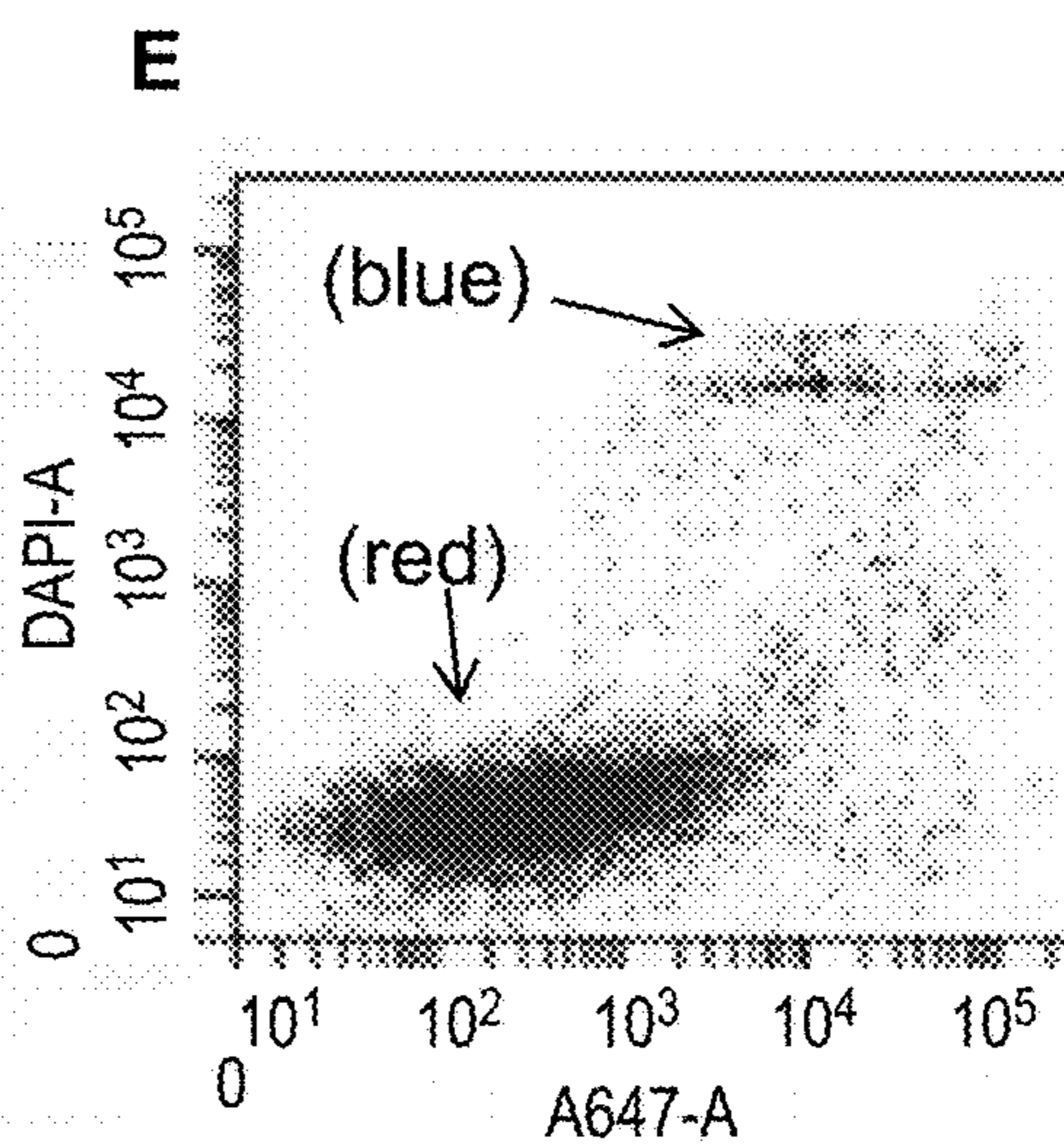

FIG. 3E

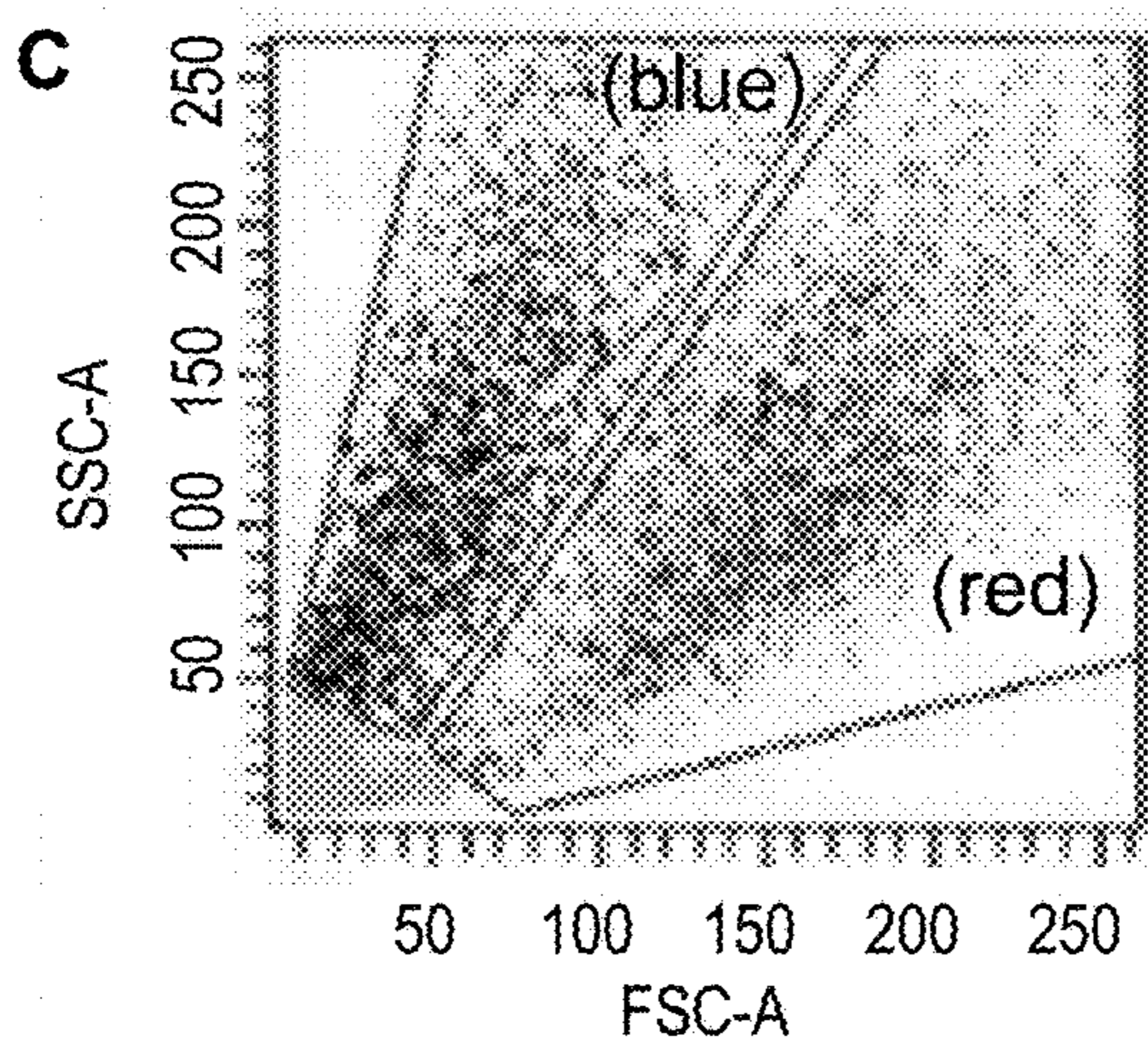

FIG. 3C

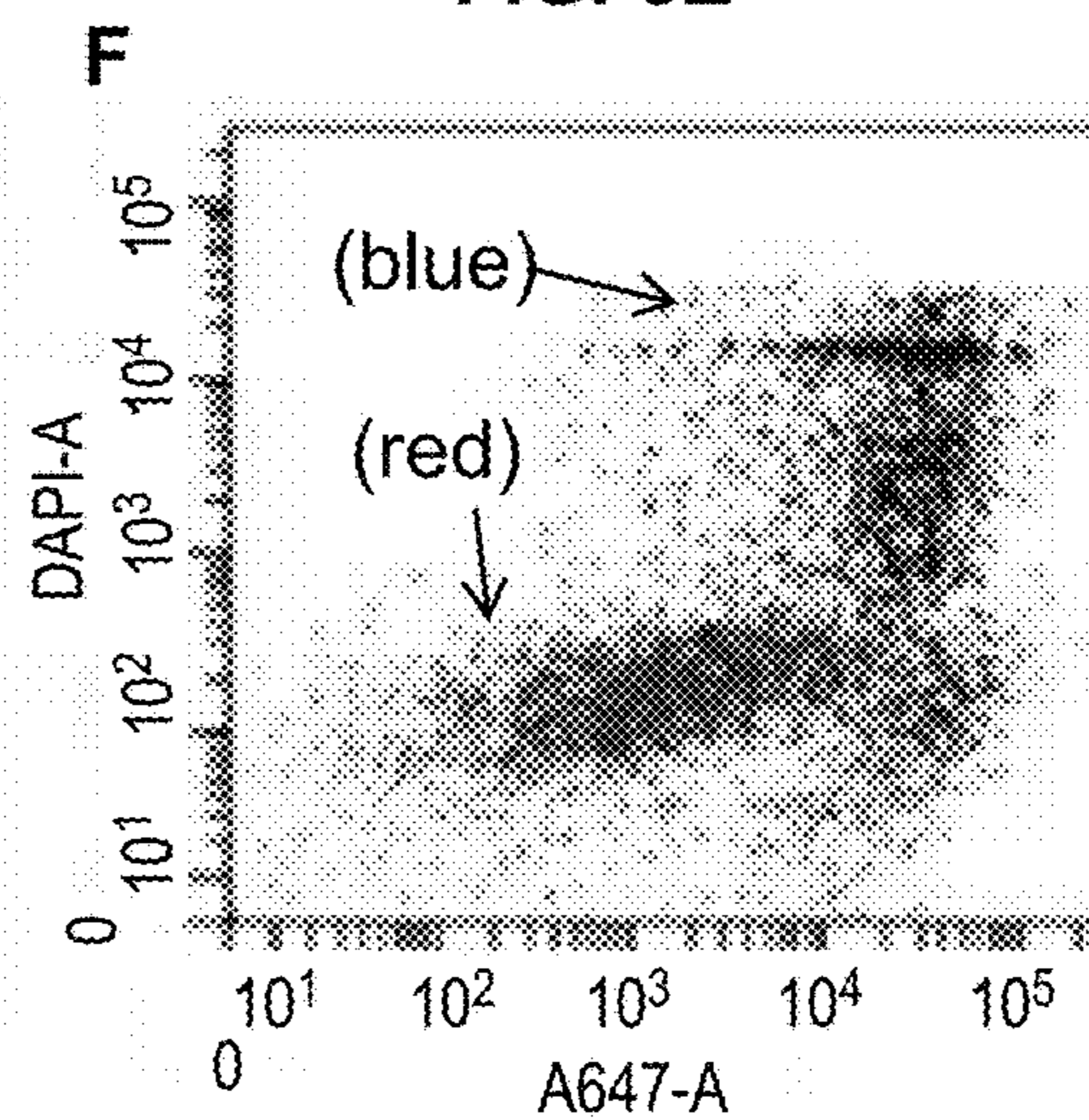

FIG. 3F

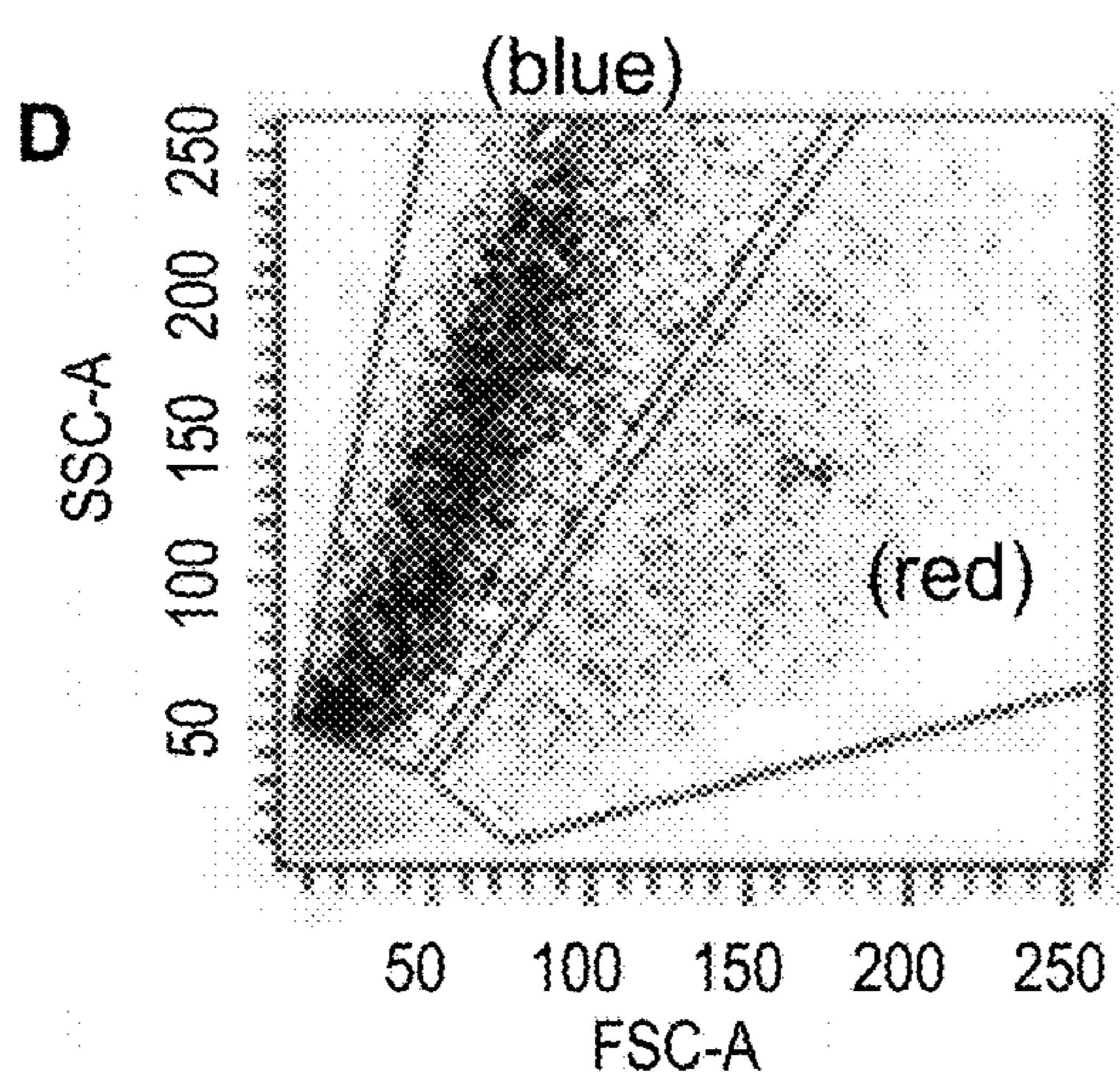

FIG. 3D

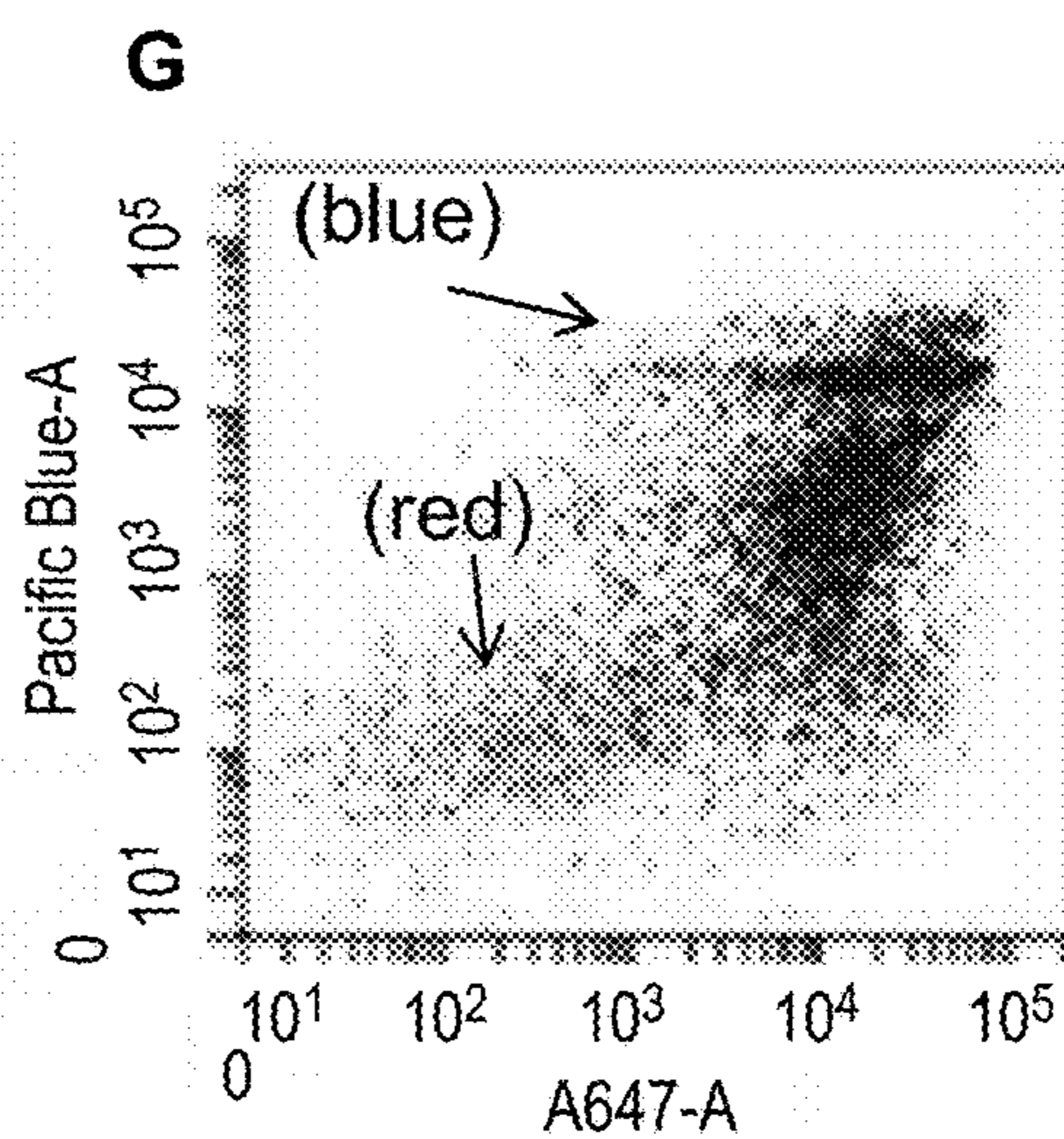
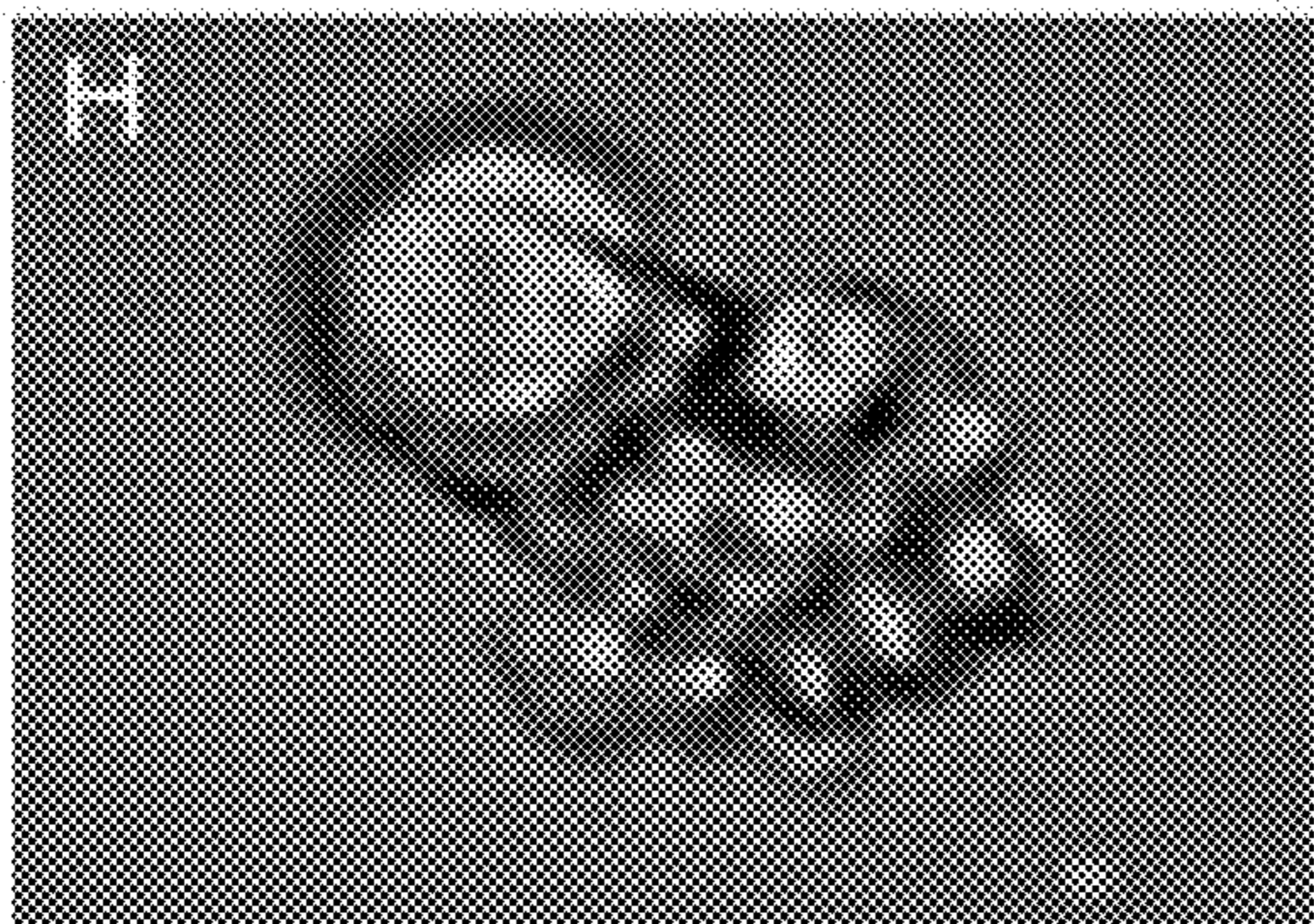
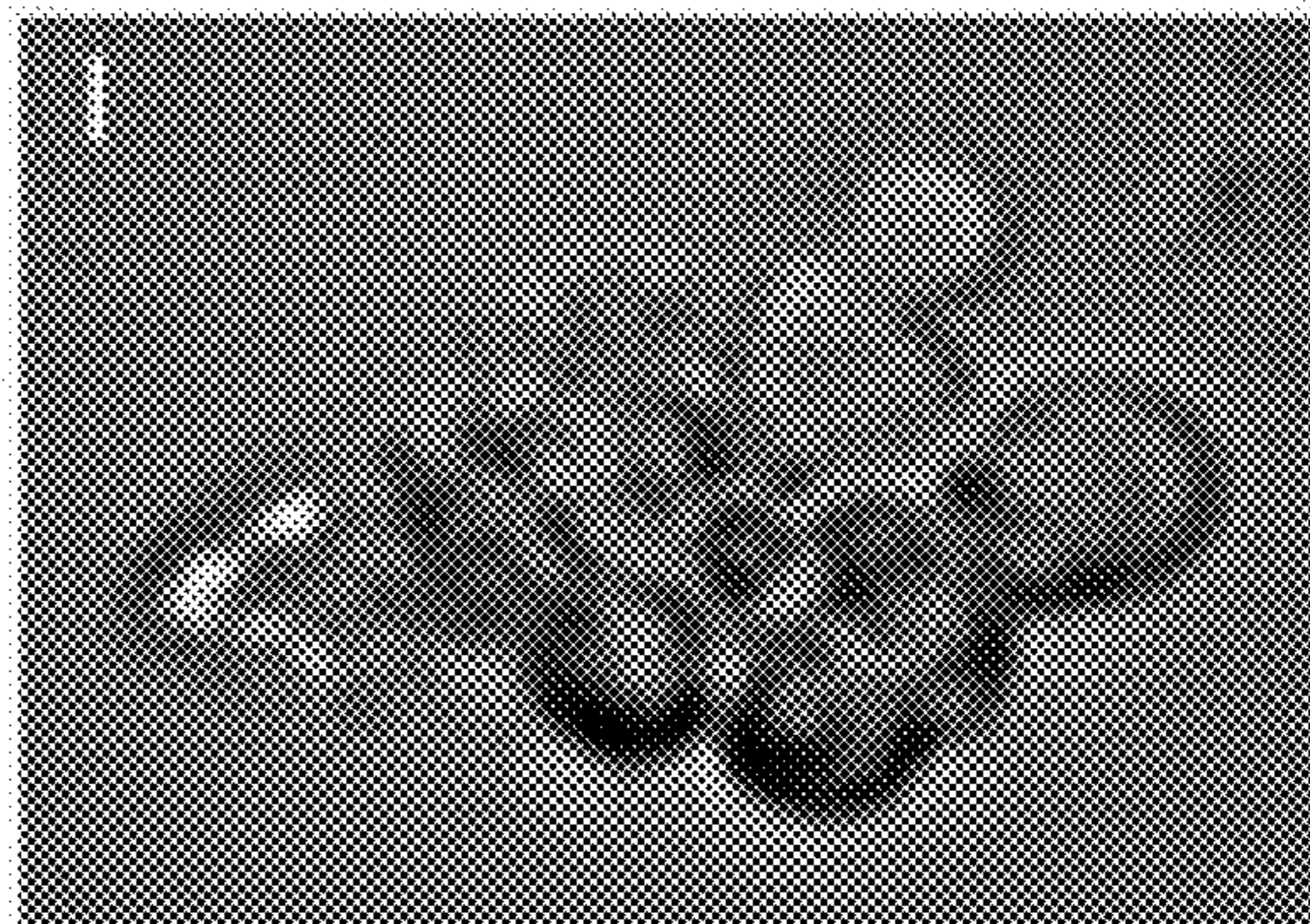

FIG. 3G

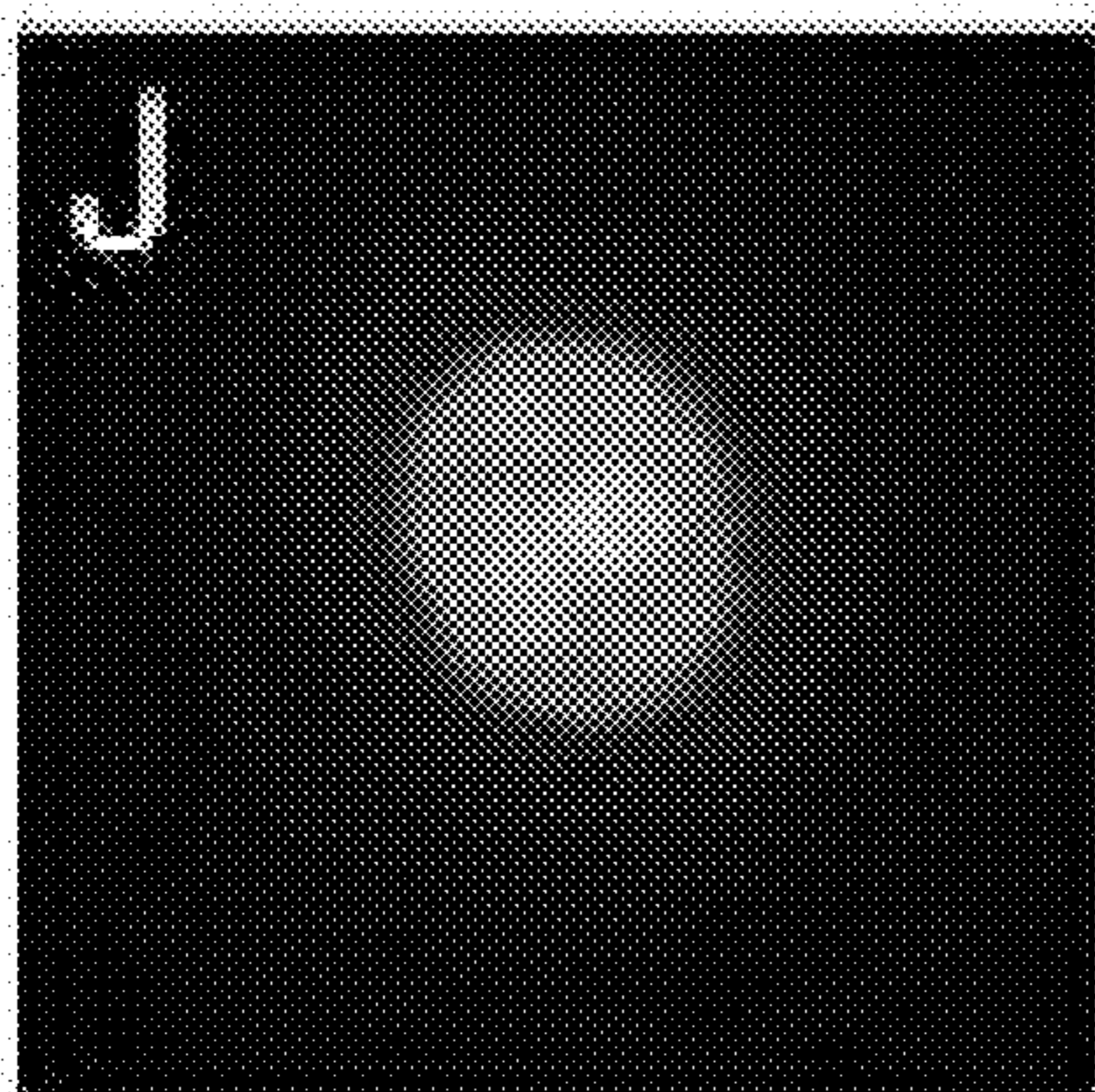



**FIG. 3H**



**FIG. 3I**



**FIG. 3J**

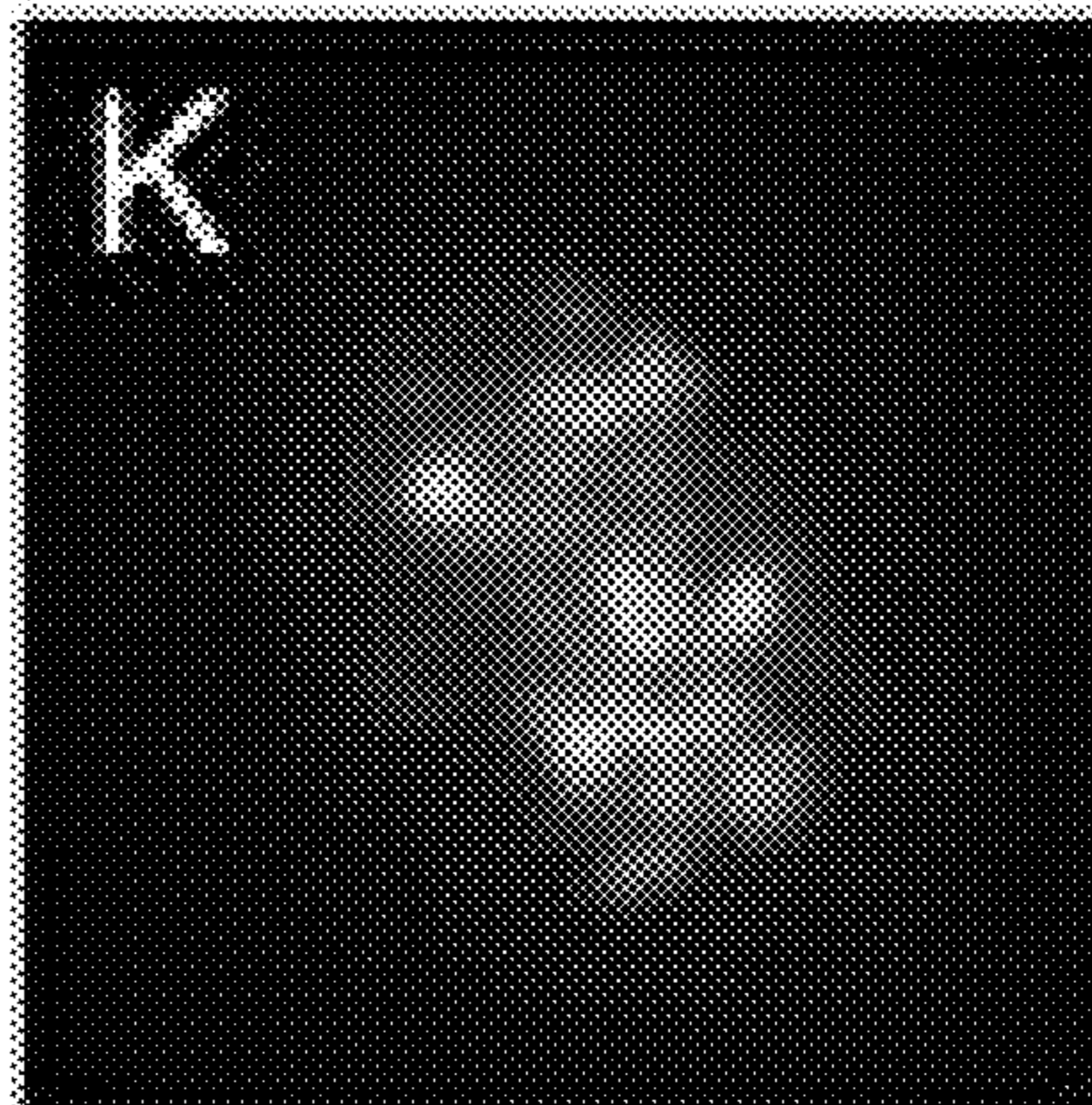

**FIG. 3K**

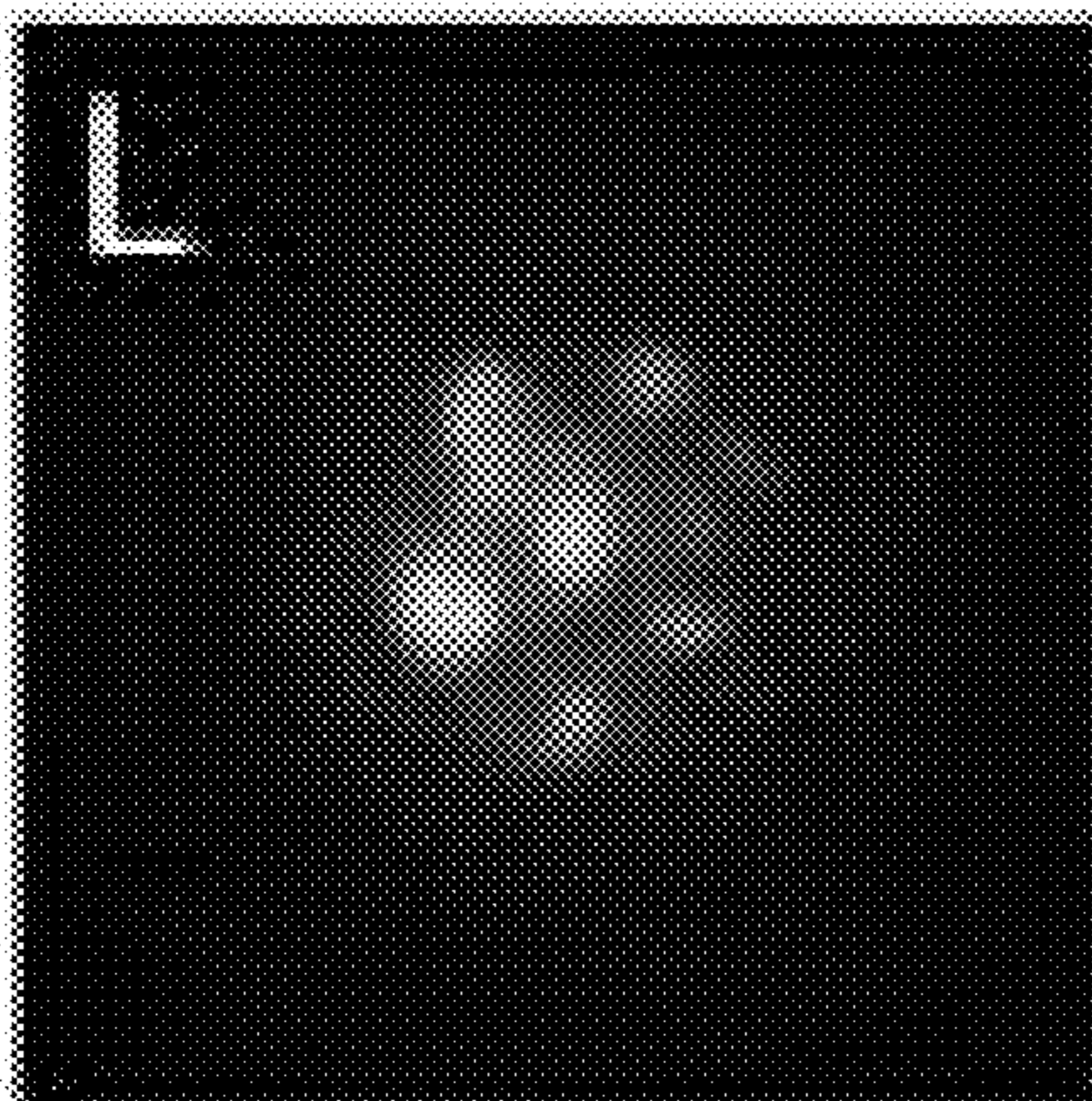

**FIG. 3L**

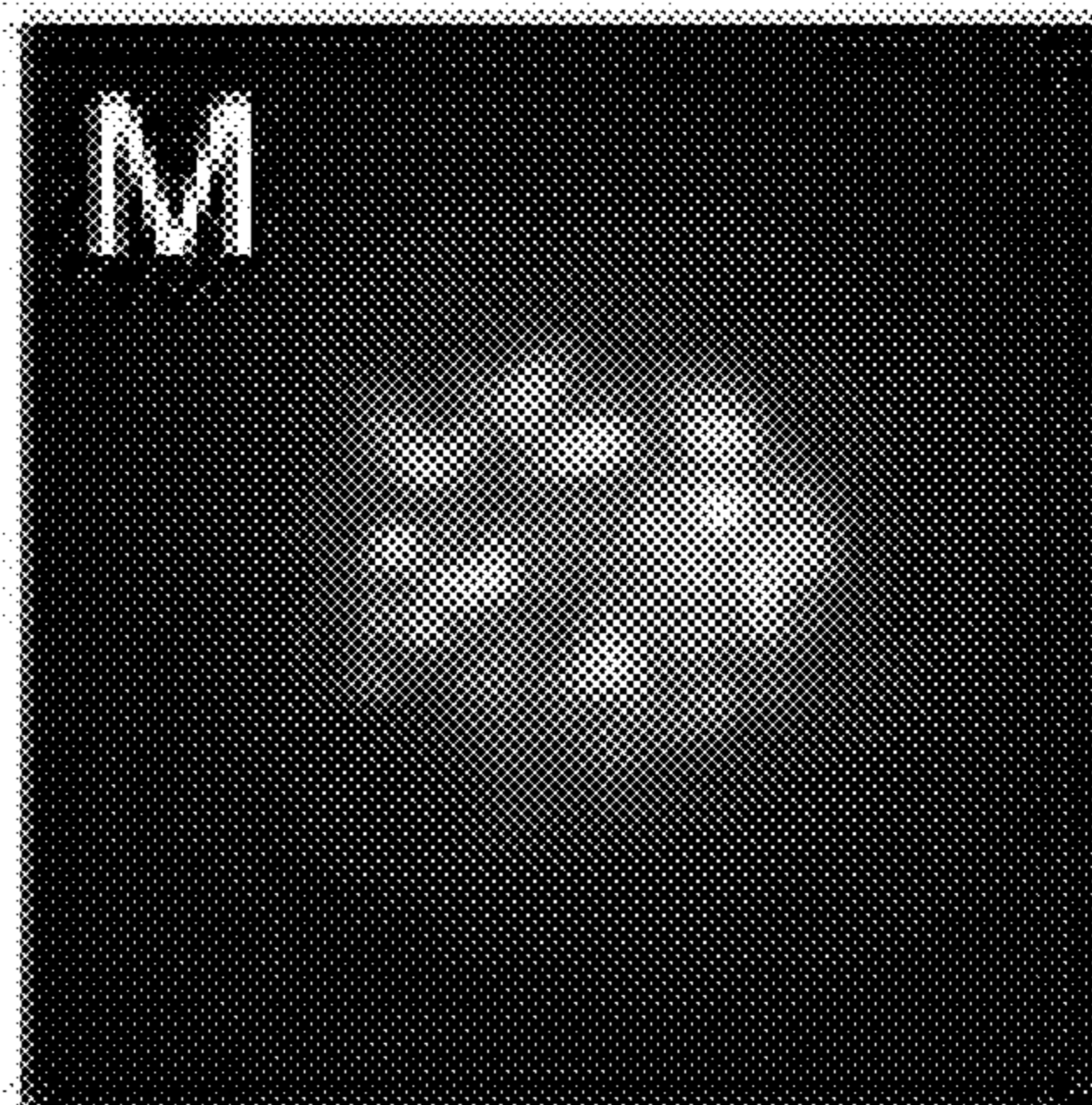

**FIG. 3M**

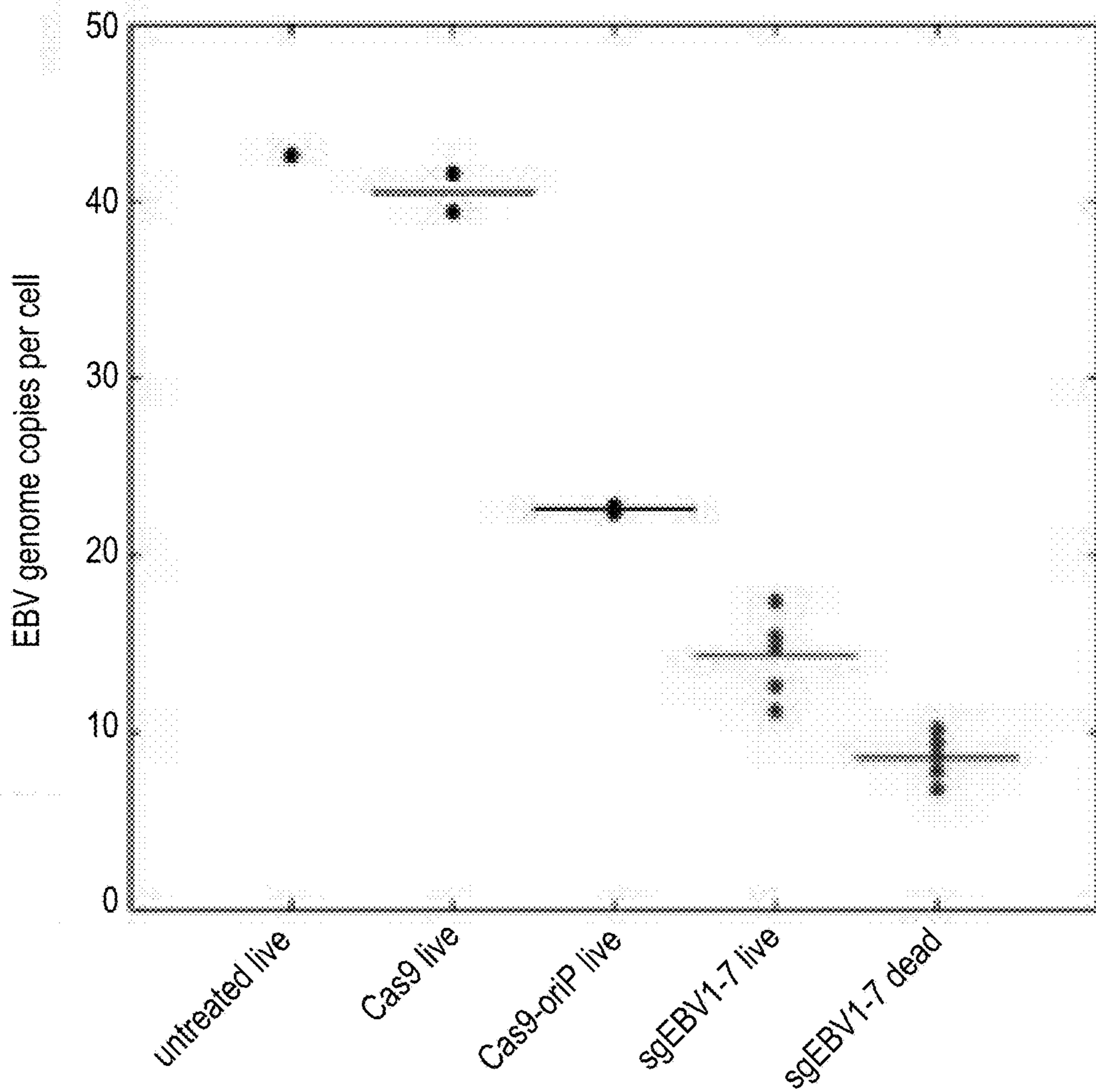
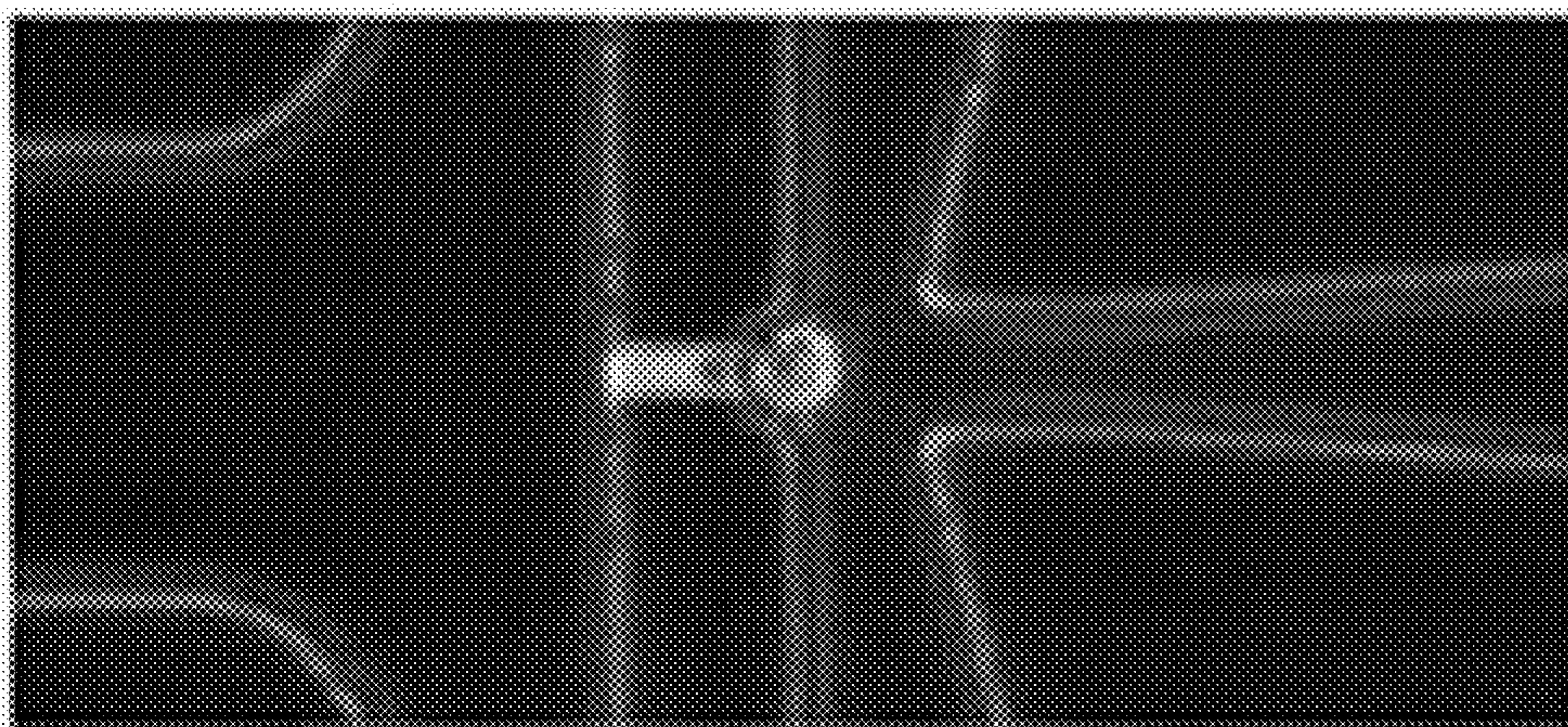
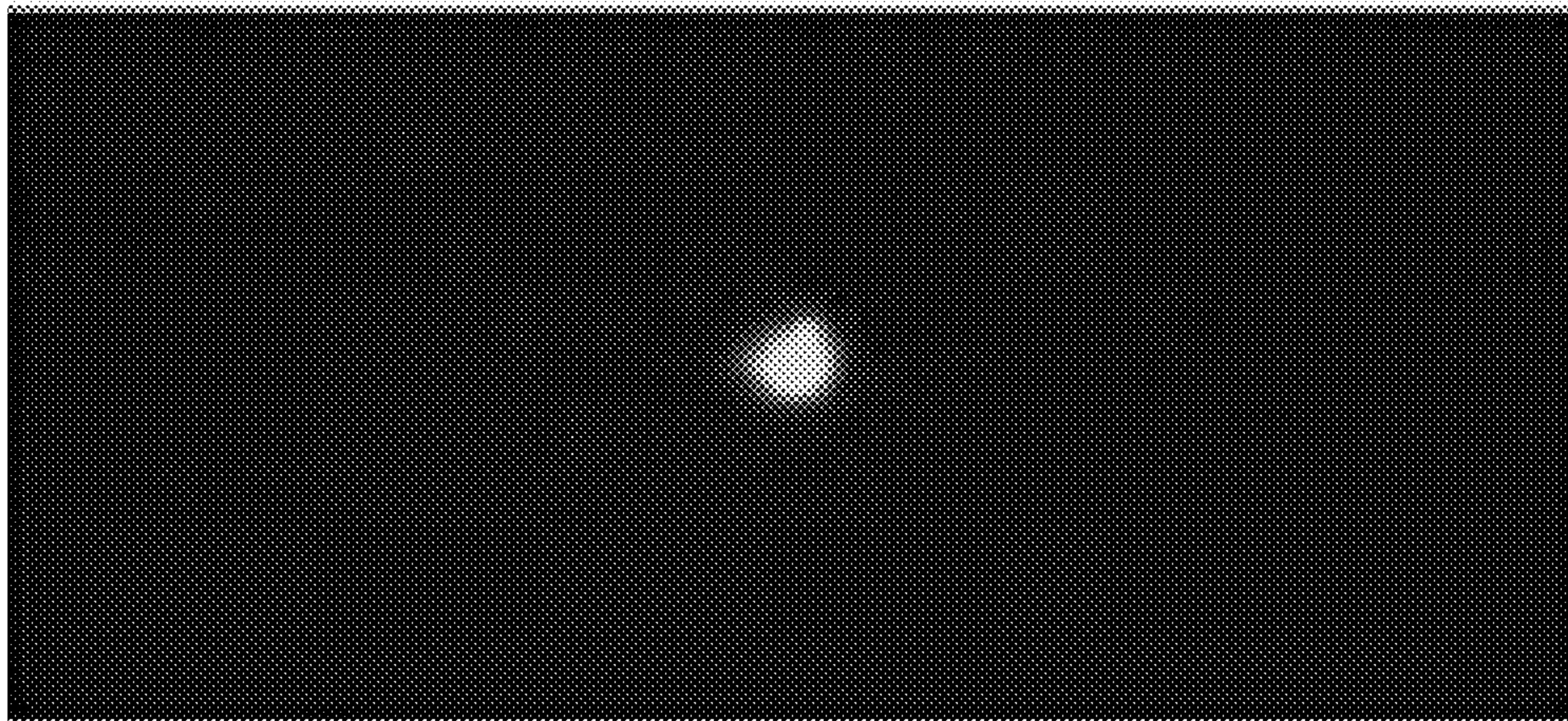

FIG. 4A

B



*FIG. 4B*



*FIG. 4C*

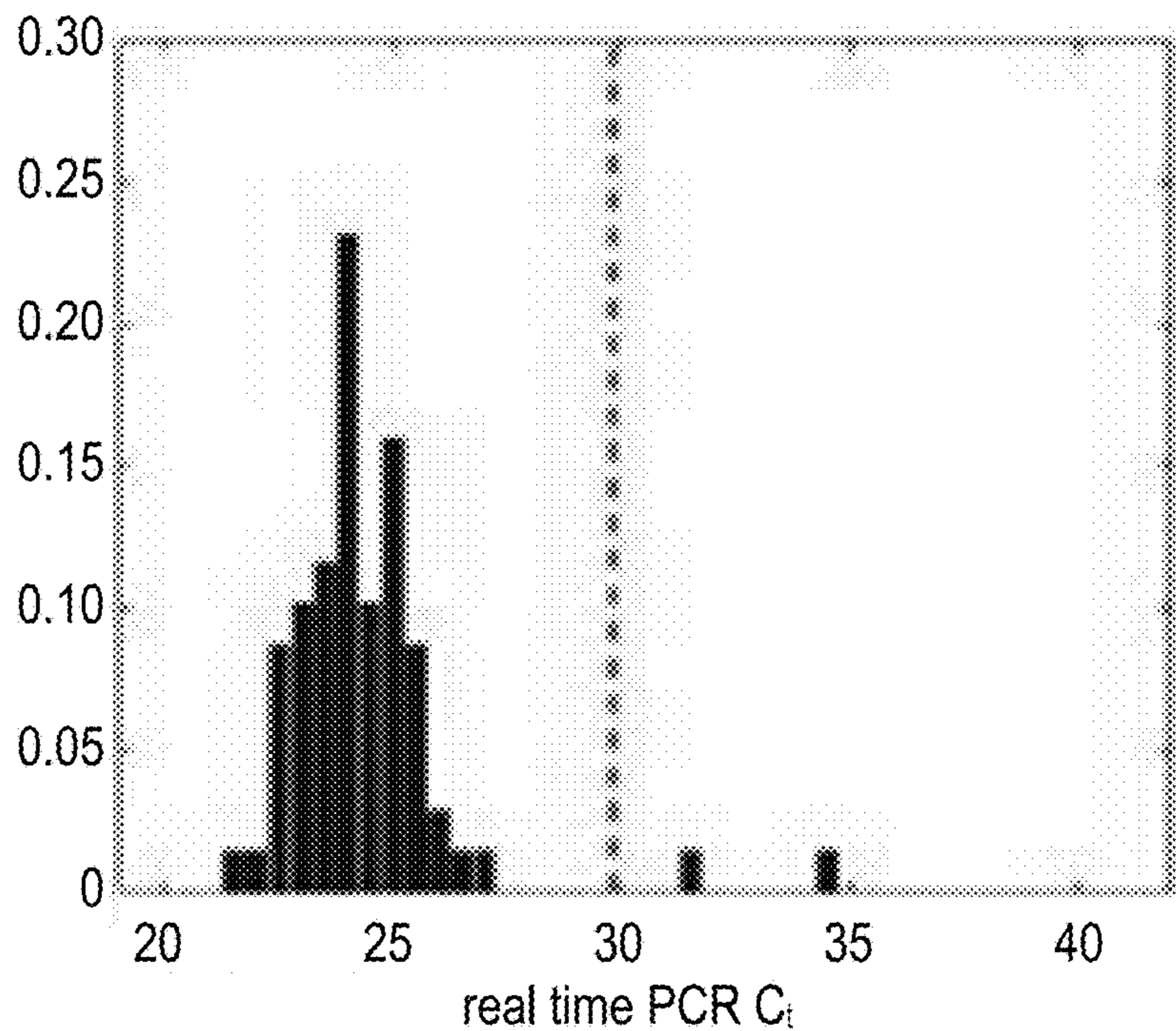

**FIG. 4D**

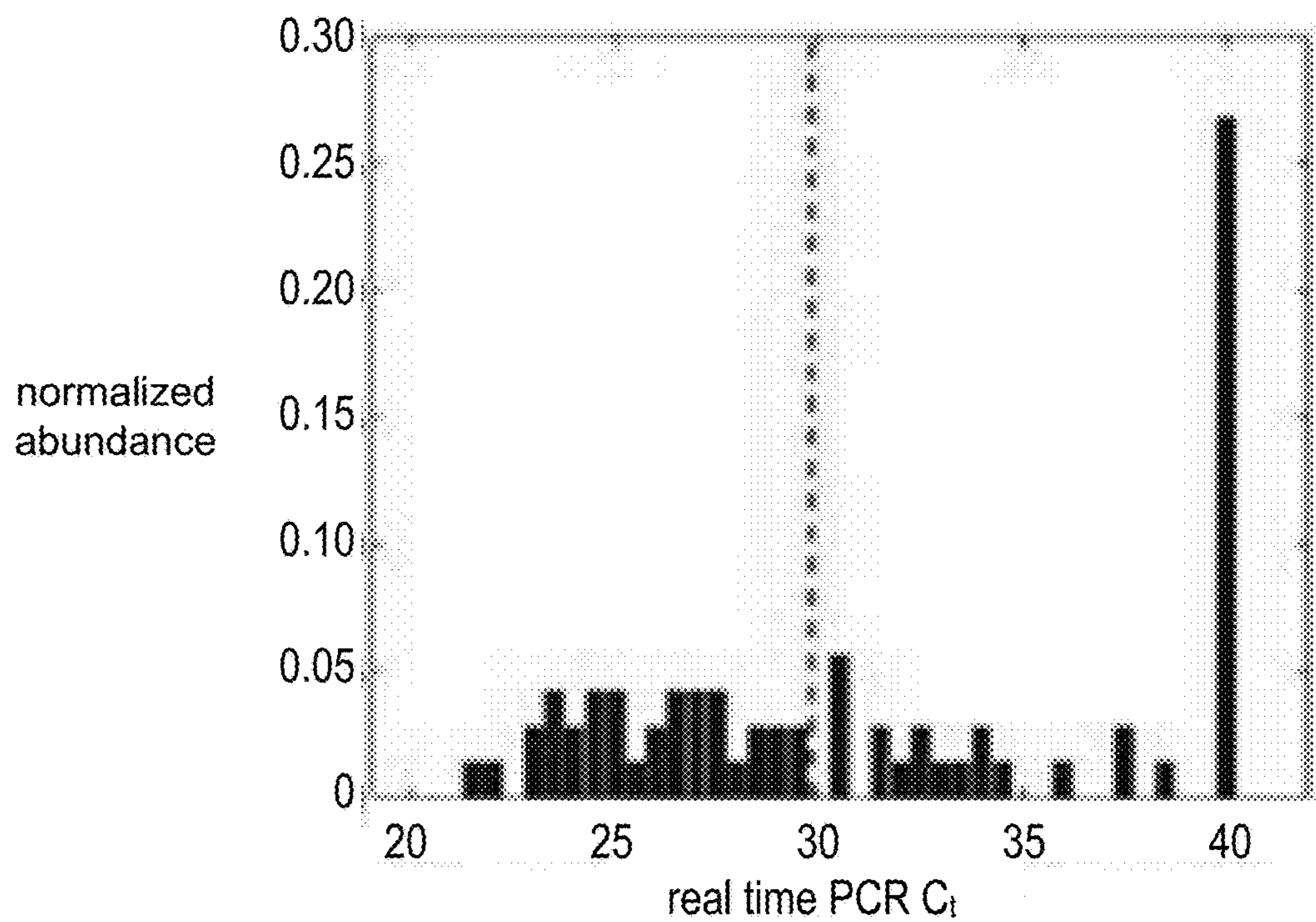

**FIG. 4E**

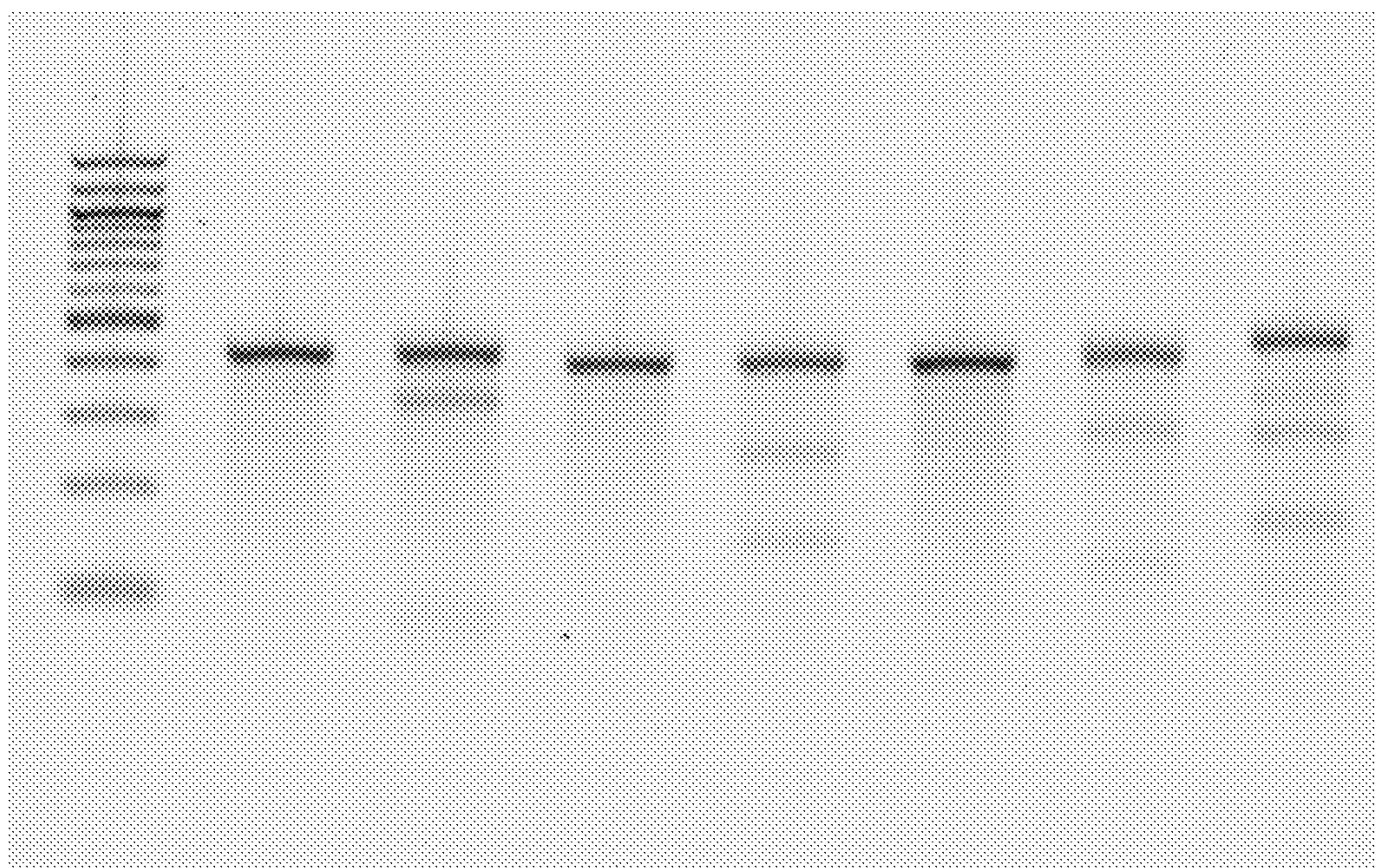

**FIG. 5**

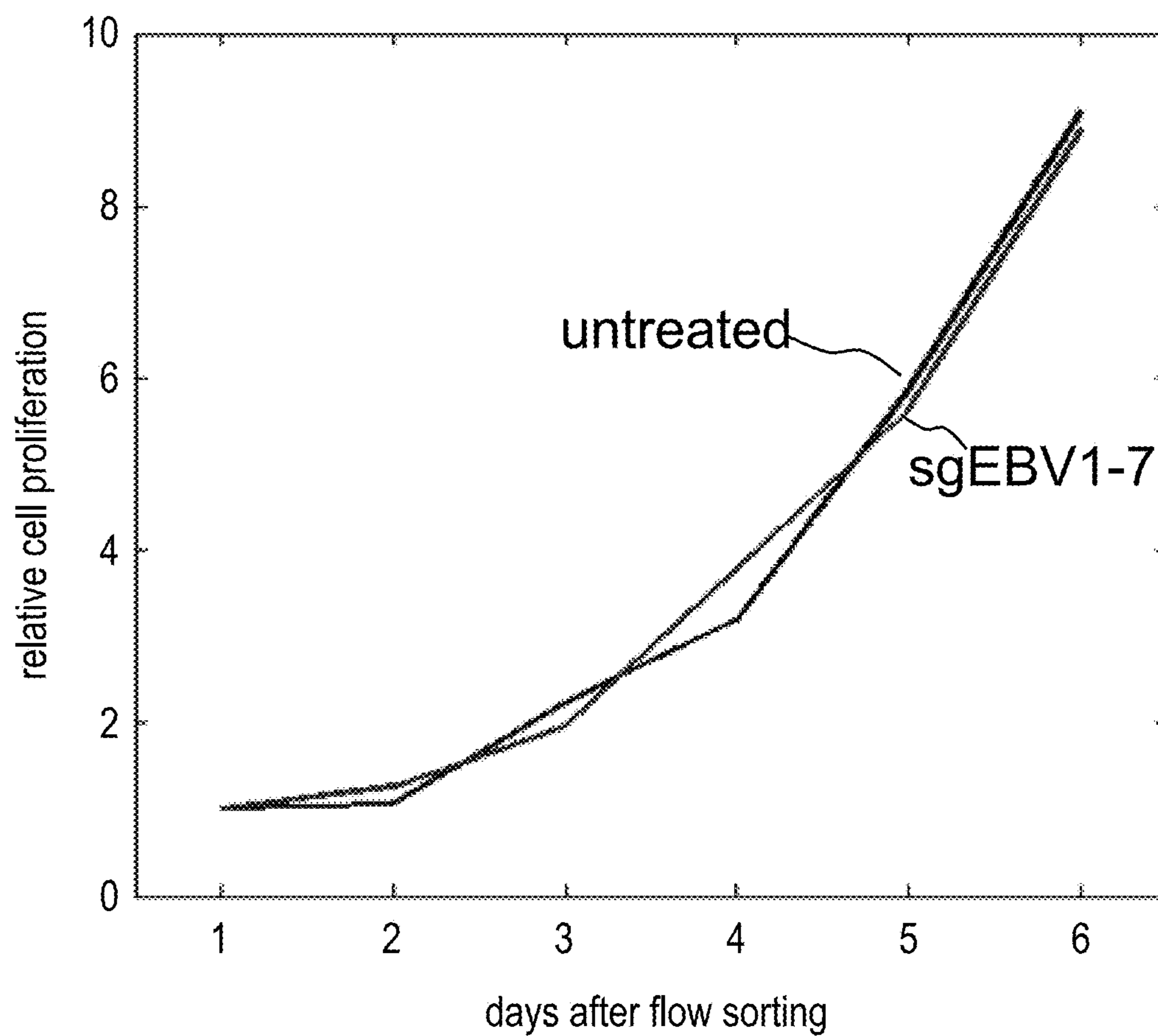

**FIG. 6**

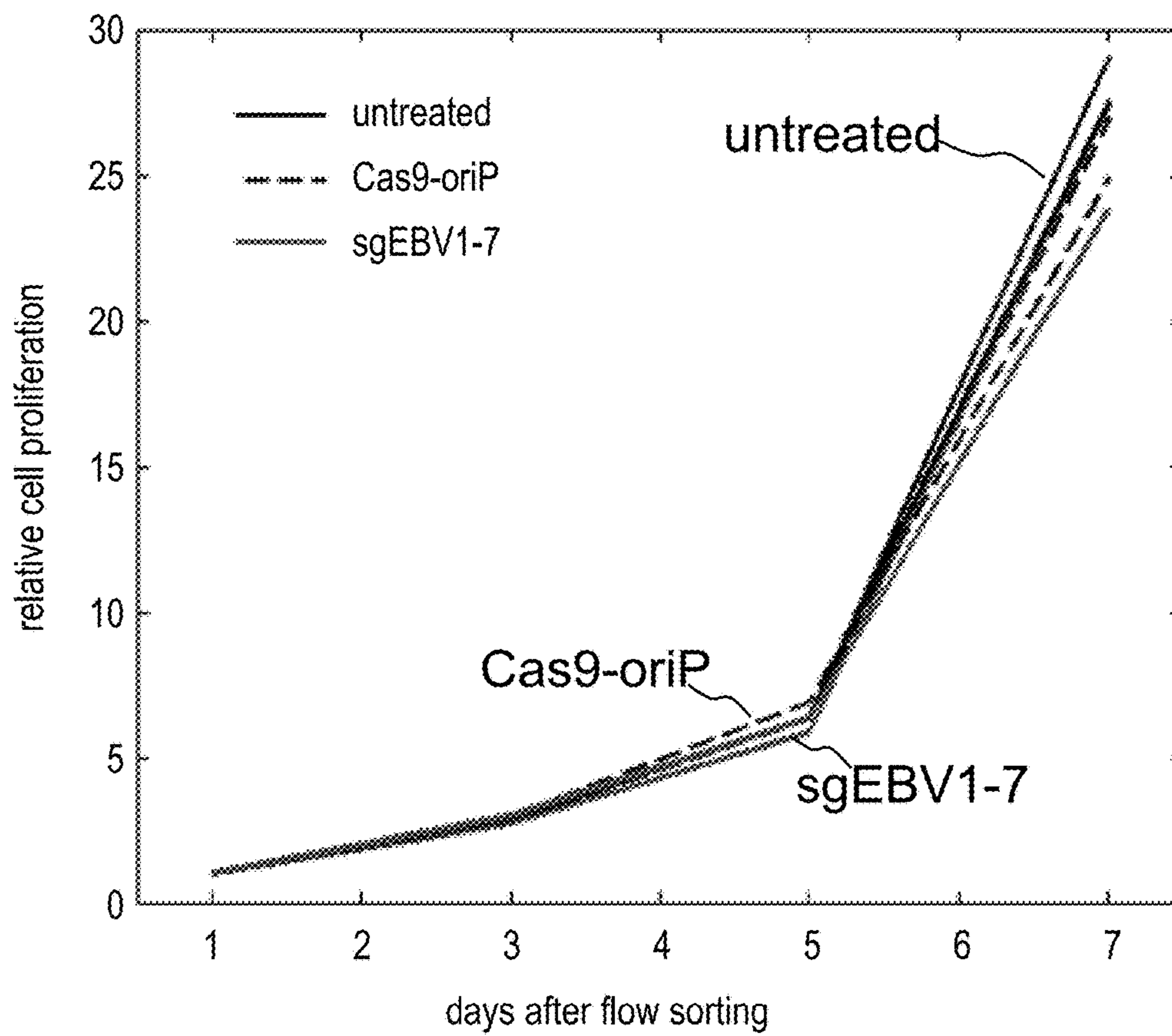

FIG. 7

Table S1. Guide RNA Target Sequences.

sgEBV1	GCCCTGGACCAACCCGGCCC (SEQ ID NO: 1)
sgEBV2	GGCCGCTGCCCCGCTCCGGG (SEQ ID NO: 2)
sgEBB3	GGAAGACAATGTGCCGCCA (SEQ ID NO: 3)
sgEBV4	TCTGGACCAGAAGGCTCCGG (SEQ ID NO: 4)
sgEBV5	GCTGCCGCGGAGGGTGATGA (SEQ ID NO: 5)
sgEBV6	GGTGGCCCACCGGGTCCGCT (SEQ ID NO: 6)
sgEBV7	GTCCTCGAGGGGGCCGTCGC (SEQ ID NO: 7)

**FIG. 8**

Table S2. PCR Primers.

sgEBV1F	TGCTAGGCCACCTTCTCAGT (SEQ ID NO: 8)
sgEBV1R	GTAGTGTGTGCCTGGGTGTG (SEQ ID NO: 9)
sgEBV2F	AGCATGGCGAAGTAGACAGG (SEQ ID NO: 10)
sgEBV2R	GCCCATTCGAACCCTACC (SEQ ID NO: 11)
sgEBV3F	TTTCAGACCCACCATGGAAT (SEQ ID NO: 12)
sgEBV3R	CCCATGAACCCAGTTAGAGG (SEQ ID NO: 13)
sgEBV4F	GGCTGCGAGTAATTGGTGAT (SEQ ID NO: 14)
sgEBV4R	CAATGCAACTTGGACGTTTTT (SEQ ID NO: 15)
sgEBV5F	GCTGAGGTTTTGAAGGATGC (SEQ ID NO: 16)
sgEBV5R	GGAGCTGAGTGACGTGACAA (SEQ ID NO: 17)
sgEBV7F	AGTAAGGGAAAGGGGGTGTG (SEQ ID NO: 18)
sgEBV7R	GACGTAGCCGCCCTACATAA (SEQ ID NO: 19)
oriP_F	CCACCAATTCCAACCATTTT (SEQ ID NO: 20)
oriP_R	CGCGGGGCAGTGCAT (SEQ ID NO: 21)
EBNA1_qF	CCTCCCTGGTTTTCCACCTAT (SEQ ID NO: 22)
EBNA1_qR	CCTCCTTCATCTCCGTCATC (SEQ ID NO: 23)
EBNA1_qP	TCCGTCATCACCCCTCCGC (SEQ ID NO: 24)

**FIG. 9**





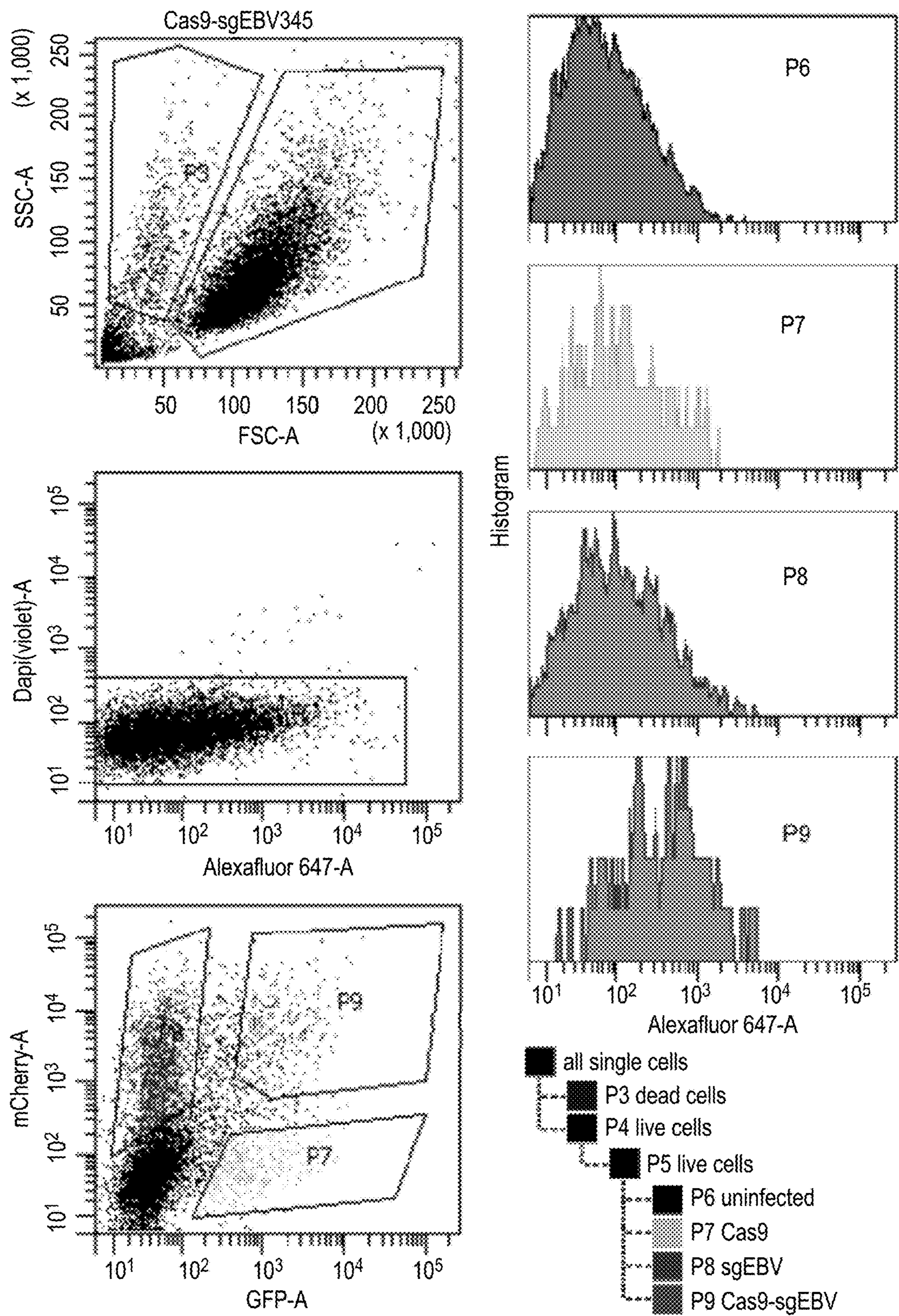

**FIG. 11**

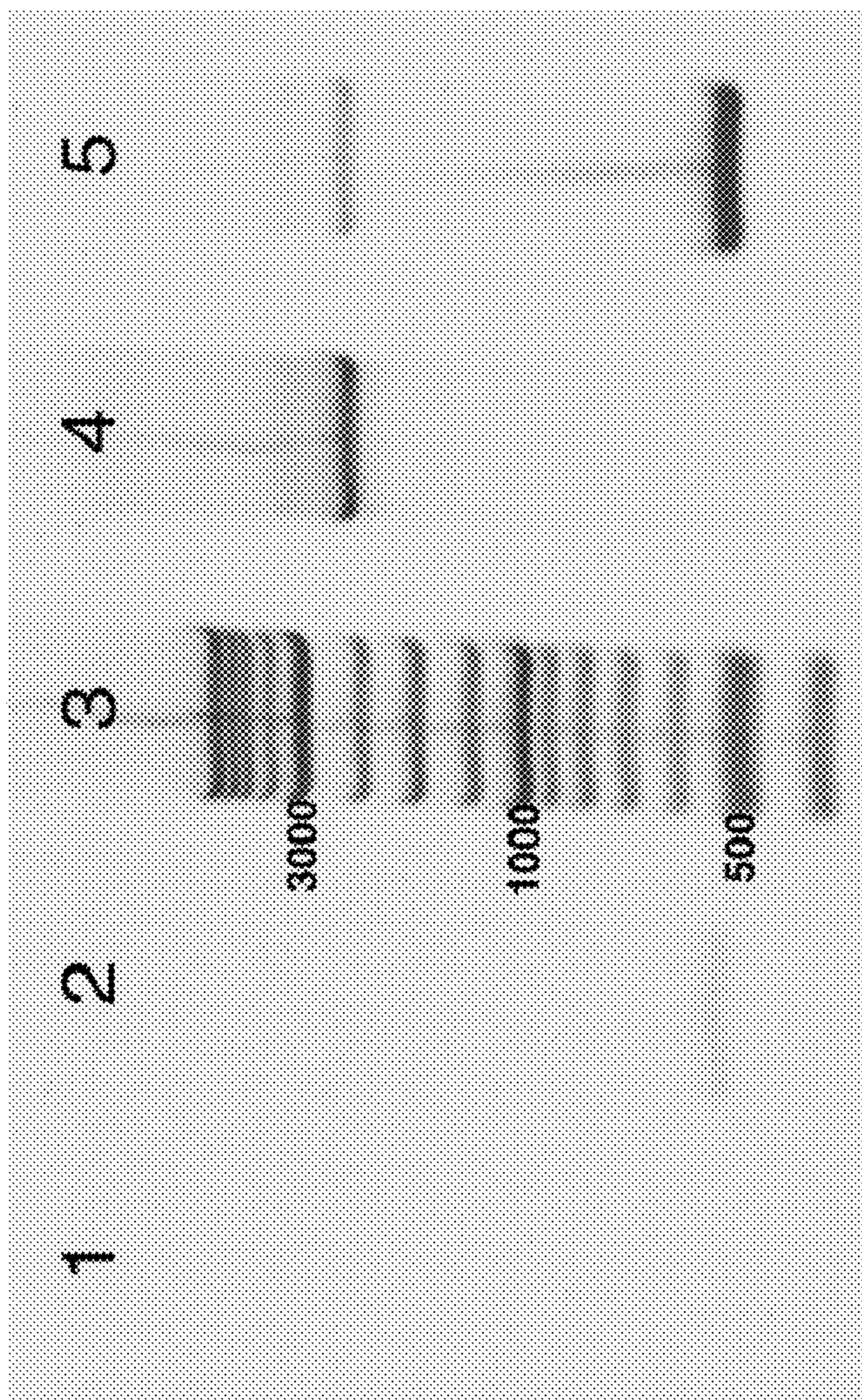
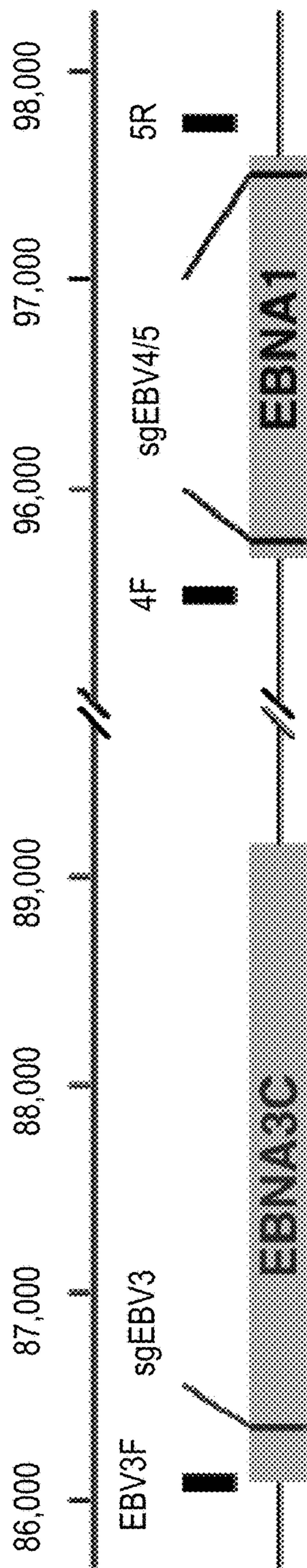

FIG. 12

**COMPOSITIONS AND METHODS OF  
DELIVERING TREATMENTS FOR LATENT  
VIRAL INFECTIONS**

CROSS-REFERENCE TO RELATED  
APPLICATION(S)

**[0001]** The present application is a Continuation of U.S. Ser. No. 15/362,519 filed Nov. 28, 2016; which is a Continuation of PCT/US2015/033199 filed May 29, 2015; which claims priority to, and the benefit of, U.S. Provisional Patent Appln. Nos. 62/029,072 filed Jul. 25, 2014, and 62/005,395 filed May 30, 2014; the contents of which are incorporated by reference in their entirety for all purposes.

STATEMENT AS TO RIGHTS TO INVENTIONS  
MADE UNDER FEDERALLY SPONSORED  
RESEARCH AND DEVELOPMENT

**[0002]** This invention was made with Government support under contracts CA134940, CA151459, HL099995, and HL099999 awarded by the National Institutes of Health. The Government has certain rights in the invention.

FIELD OF THE INVENTION

**[0003]** The invention generally relates to delivery methods, compositions and methods for selectively treating viral infections using a guided nuclease system.

BACKGROUND

**[0004]** Viral infections are a significant medical problem. Various antiviral treatments are available but they generally are directed to interrupting the replicating cycle of the virus. Thus, a particularly difficult problem is latent viral infection, as there is no effective treatment to eradicate the virus from host cells. Since latent infection can evade immune surveillance and reactivate the lytic cycle at any time, there is a persistent risk throughout the life of the infected individual. The majority of antiviral drug development has been focused on protein targets and such approaches have not been successful in eradicating the virus.

**[0005]** One example of a latent viral infection that is a particular problem is the herpesviridae virus family. Herpes is one of the most widespread human pathogens, with more than 90% of adults having been infected with at least one of the eight subtypes of herpes virus. Latent infection persists in most people; and about 16% of Americans between the ages of 14 and 49 are infected with genital herpes, making it one of the most common sexually transmitted diseases. Due to latency, there is no cure for genital herpes or for herpes simplex virus type 2 (HSV-2). Once infected, a host carries the herpes virus indefinitely, even when not expressing symptoms. Similarly, human papillomavirus, or HPV is a common virus in the human population, where more than 75% of women and men will have this type of infection at one point in their life. High-risk oncogenic HPV types are able to integrate into the DNA of the cell that can result in cancer, specifically cervical cancer. Similar to the herpesviridae virus family, HPV may remain latent.

**[0006]** The Epstein-Barr virus (EBV), also called human herpesvirus 4 (HHV-4) is another common virus in humans. Epstein-Barr is known as the cause of infectious mononucleosis (glandular fever), and is also associated with particular forms of cancer, such as Hodgkin's lymphoma, Burkitt's lymphoma, nasopharyngeal carcinoma, and con-

ditions associated with human immunodeficiency virus (HIV) such as hairy leukoplakia and central nervous system lymphomas. There is evidence that infection with the virus is associated with a higher risk of certain autoimmune diseases, especially dermatomyositis, systemic lupus erythematosus, rheumatoid arthritis, Sjögren's syndrome, and multiple sclerosis. During latency, the EBV genome circularizes and resides in the cell nucleus as episomes. To date, however, no EBV vaccine or treatment exists.

**[0007]** Viruses, such as the herpesviridae virus family, including EBV, and HPV have the ability to lie dormant within a cell indefinitely and not be fully eradicated even after treatment. The result is that the virus can reactivate and begin producing large amounts of viral progeny without the host being infected by any new outside virus. In the latent state, the viral genome persists within the host cells as episomes; stabilized and floating in the cytoplasm or nucleus. For these latent viruses, it has not been possible to find therapeutic approaches which completely eradicate such infections.

**[0008]** A newer innovative treatment is the use of nucleases to make sequence specific deletions in the viral genome. Although this treatment shows promise, one of the major challenges of this and other targeted therapies is how to effectively deliver the treatment to the cells of interest.

**[0009]** Some viral infections affect only a small number of cells, and so a general non-targeted delivery approach would be ineffective. It has been estimated that HSV, for example, latently infects only 20,000 neurons. For this and other viral infections, it is important to have a treatment that is targeted only to the cells of interest. Increasing the cell affinity and specificity can greatly improve therapeutic delivery efficiency.

SUMMARY

**[0010]** The invention generally relates to compositions and methods for delivery of antiviral therapeutics. Methods and compositions are provided for targeted delivery of antiviral therapeutics into cells of interest using, for example, viral vectors such as adenovirus, AAV, and replication incompetent HSV. These and other delivery systems can be used as vehicles to deliver nucleic acid (DNA, RNA, synthetic nucleic acids, such as PNA, LNA, etc) vectors encoding a nuclease or a cytotoxic genetic cassette. Delivery methods of the invention are useful to deliver vectors containing antiviral gene editing sequences. The invention also contemplates delivering naked DNA or RNA, protein products, plasmids containing a promoter or other regulatory sequence that is active only in a latent viral state which controls a cell-killing genetic construct, or expression of a therapeutic agent (e.g., a cytotoxic protein).

**[0011]** The invention also generally relates to compositions and methods for selectively treating viral infections using a guided nuclease system. In general terms, compositions of the invention comprise a guide RNA that targets viral genomic material for destruction by the nuclease and does not target the host cell genome.

**[0012]** Certain embodiments of the invention make use of a CRISPR/Cas9 nuclease and guide RNA (gRNA) that together target and selectively edit or destroy viral genomic material. The CRISPR (clustered regularly interspaced short palindromic repeats) is a naturally-occurring element of the bacterial immune system that protects bacteria from phage infection. The guide RNA localizes the

CRISPR/Cas9 complex to a viral target sequence. Binding of the complex localizes the Cas9 endonuclease to the viral genomic target sequence causing breaks in the viral genome. In a preferred embodiment, the guide RNA is designed to target multiple sites on the viral genome in order to disrupt viral nucleic acid and reduce the chance that it will functionally recombine.

**[0013]** The presented methods provide for a CRISPR/gRNA/Cas9 complex or other therapeutic agents to be delivered to a cell (including entire tissues) that is infected by a virus. The CRISPR/gRNA/Cas9 complexes of the invention can be delivered by viral, non-viral or other vectors. Viral vectors include retrovirus, lentivirus, adenovirus, herpesvirus, poxvirus, alphavirus, vaccinia virus or adeno-associated viruses. Delivery can also be accomplished by non-viral vectors, such as nanoparticles, cationic lipids, cationic polymers, metallic nanoparticles, nanorods, liposomes, micelles, microbubbles, cell-penetrating peptides, or lipospheres. Some non-viral vectors may be coated with polyethyleneglycol (PEG) to reduce the opsonization and aggregation of non-viral vectors and minimize the clearance by the reticuloendothelial system, leading to a prolonged circulation lifetime after intravenous administration. Aspects of the invention provide for the application of energy to delivery vectors for increased tissue-permeabilizing effects (e.g., ultrasound). The invention contemplates both systemic and localized delivery.

**[0014]** Aspects of the invention allow for CRISPR/gRNA/Cas9 complexes to be designed to target viral genomic material and not genomic material of the host. Latent viruses may be, for example, human immunodeficiency virus, human T-cell leukemia virus, Epstein-Barr virus, human cytomegalovirus, human herpesviruses 6 and 7, herpes simplex virus types 1 and 2, varicella-zoster virus, measles virus, or human papovaviruses. Aspects of the invention allow for CRISPR/gRNA/Cas9 complexes to be designed to target any virus, latent or active.

**[0015]** The presented methods allow for viral genome editing or destruction, which results in the inability of the virus to proliferate and/or induces apoptosis in infected cells, with no observed cytotoxicity to non-infected cells. Aspects of the invention involve providing a CRISPR/gRNA/Cas9 complex that selectively targets viral genomic material (DNA or RNA), delivering the CRISPR/gRNA/Cas9 complex to a cell containing the viral genome, and cutting the viral genome in order to incapacitate the virus. The presented methods allows for treatment targeted disruption of viral genomic function or, in a preferred embodiment, digestion of viral nucleic acid via multiple breaks caused by targeting multiple sites for endonuclease action in the viral genome. Aspects of the invention provide for transfection of a CRISPR/gRNA/Cas9 complex cocktail to completely suppress cell proliferation and/or induce apoptosis in infected cells. Additional aspects and advantages of the invention will be apparent upon consideration of the following detailed description thereof.

#### BRIEF DESCRIPTION OF THE DRAWINGS

**[0016]** FIGS. 1A-1C represent EBV-targeting CRISPR/Cas9 designs. (FIG. 1A) Scheme of CRISPR/Cas plasmids, adapted from Cong L et al. (2013) Multiplex Genome Engineering Using CRISPR/Cas Systems. *Science* 339:819-823. (FIG. 1B) Effect of oriP on transfection efficiency in Raji cells. Both Cas9 and Cas9-oriP plasmids have a

scrambled guide RNA. (FIG. 1C) CRISPR guide RNA targets along the EBV reference genome. Green, red and blue represent three different target sequence categories.

**[0017]** FIGS. 2A-2F represent CRISPR/Cas9 induced large deletions. (FIG. 2A) Genome context around guide RNA sgEBV2 and PCR primer locations. (FIG. 2B) Large deletion induced by sgEBV2. Lane 1-3 are before, 5 days after, and 7 days after sgEBV2 treatment, respectively. (FIG. 2C) Genome context around guide RNA sgEBV3/4/5 and PCR primer locations. (FIG. 2D) Large deletions induced by sgEBV3/5 and sgEBV4/5. Lane 1 and 2 are 3F/5R PCR amplicons before and 8 days after sgEBV3/5 treatment. Lane 3 and 4 are 4F/5R PCR amplicons before and 8 days after sgEBV4/5 treatment. (FIG. 2E and F) Sanger sequencing confirmed genome cleavage and repair ligation 8 days after sgEBV3/5 (FIG. 2E) and sgEBV4/5 (FIG. 2F) treatment. Blue and white background highlights the two ends before repair ligation.

**[0018]** FIGS. 3A-3M represent cell proliferation arrest with EBV genome destruction. (FIG. 3A) Cell proliferation curves after different CRISPR treatments. Five independent sgEBV1-7 treatments are shown here. (FIGS. 3B-D) Flow cytometry scattering signals before (FIG. 3B), 5 days after (FIG. 3C) and 8 days after (FIG. 3D) sgEBV1-7 treatments. (FIG. 3E-G) Annexin V Alexa647 and DAPI staining results before (FIG. 3E), 5 days after (FIG. 3F) and 8 days after (FIG. 3G) sgEBV1-7 treatments. Blue and red correspond to subpopulation P3 and P4 in (FIGS. 3B-D). (FIGS. 3H and I) Microscopy revealed apoptotic cell morphology after sgEBV1-7 treatment. (FIGS. 3J-M) Nuclear morphology before (FIG. 3J) and after (FIGS. 3K-M) sgEBV1-7 treatment.

**[0019]** FIGS. 4A-4E represent EBV load quantitation after CRISPR treatment. (FIG. 4A) EBV load after different CRISPR treatments by digital PCR. Cas9 and Cas9-oriP had two replicates, and sgEBV1-7 had 5 replicates. (FIGS. 4B and C) Microscopy of captured single cells for whole-genome amplification. (FIG. 4D) Histogram of EBV quantitative PCR  $C_t$  values from single cells before treatment. (FIG. 4E) Histogram of EBV quantitative PCR  $C_t$  values from single live cells 7 days after sgEBV1-7 treatment. Red dash lines in (FIG. 4D) and (FIG. 4E) represent  $C_t$  values of one EBV genome per cell.

**[0020]** FIG. 5 represents SURVEYOR assay of EBV CRISPR. Lane 1: NEB 100bp ladder; Lane 2: sgEBV1 control; Lane 3: sgEBV1; Lane 4: sgEBV5 control; Lane 5: sgEBV5; Lane 6: sgEBV7 control; Lane 7: sgEBV7; Lane 8: sgEBV4.

**[0021]** FIG. 6 represents CRISPR cytotoxicity test with EBV-negative Burkitt's lymphoma DG-75.

**[0022]** FIG. 7 represents CRISPR cytotoxicity test with primary human lung fibroblast IMR-90.

**[0023]** FIG. 8 shows a table (Table 51) of guide RNA target sequences for EBV.

**[0024]** FIG. 9 depicts Table S2.

**[0025]** FIG. 10 shows a CRISPR guide RNA with various targets along the EBV reference genome. Green, red and blue represent three different target sequence categories.

**[0026]** FIG. 11 shows the results of EBV-positive Raji cells transduced with GFP-Cas9 and three different EBV-targeting guide RNA sequences with the mCherry reporter gene, all packaged with three adenovirus lines. Five days after transduction, GFP-mCherry double positive cells (P9) revealed apoptotic signals with positive Annexin V

Alexa647 staining, whereas single positive cells (P7 and P8) showed no Annexin V staining difference from uninfected double negative cells (P6). This demonstrates that viral mediated CRISPR delivery results in reactivation of host apoptosis pathways.

**[0027]** FIG. 12 shows the results of a similar CRISPR transduction experiment. Nine days after CRISPR adenovirus transduction, PCR assays revealed sequence specific large deletions in P9, but not P7 cells. Lane 1 and 2 are 3F/5R PCR amplicons from P7 and P9. Lane 4 and 5 are 4F/5R PCR amplicons from P7 and P9. Genome context around guide RNA sgEBV3/4/5 and PCR primer locations are shown above. Therefore viral mediated CRISPR delivery successfully ablates the EBV genome.

#### DETAILED DESCRIPTION

**[0028]** The invention generally relates to compositions and methods for delivery of therapies targeting viral infection including compositions and methods for selectively targeting viral infections using a guided nuclease system. The invention provides methods and compositions that to allow effective delivery of nucleases or other cytotoxic elements to cells of interest. Methods and compositions are provided for targeted delivery of antiviral therapeutics into cells of interest using, for example, viral vectors such as adenovirus, AAV, and replication incompetent HSV. These and other delivery systems can be used as vehicles to deliver DNA vectors encoding a nuclease or a cell-killing gene. These delivery methods can also be used to deliver naked DNA or RNA, protein products, plasmids containing a promoter that is active only in a latent viral state which drives a cell-killing gene, or other therapeutic agents. Methods and compositions of the invention are designed to specifically target virus and virus-infected cells.

**[0029]** One of the treatments contemplated by the invention is the use of nucleases to target viral genomes. In some embodiments, the invention involves delivering a nuclease into a cell of interest. Nucleases have the ability to incapacitate or disrupt latent viruses within a cell by systematically causing deletions in the viral genome, thereby reducing the ability for the viral genome to replicate itself. In embodiments, the treatment comprises CRISPR/Cas and guided RNA complexes, which cause insertions, deletions, or rearrangements within the viral genome in order to incapacitate or destroy the virus.

**[0030]** Methods of the invention can be used to incapacitate or disrupt latent viruses within a cell by systematically causing large or repeated deletions in the genome, reducing the probability of reconstructing the full genome. In alternative embodiments, the CRISPR/Cas and guided RNA complexes cause insertions, deletions, or rearrangements within the viral genome in order to incapacitate or destroy the virus.

**[0031]** CRISPR (Clustered Regularly Interspaced Short Palindromic Repeats) is found in bacteria and is believed to protect the bacteria from phage infection. It has recently been used as a means to alter gene expression in eukaryotic DNA by introducing insertions or deletions as a way of increasing or decreasing transcription in the DNA of a targeted cell or population of cells. See for example, Horvath et al., *Science* (2010) 327:167-170; Terns et al., *Current Opinion in Microbiology* (2011) 14:321-327; Bhaya et al. *Annu Rev Genet* (2011) 45:273-297; Wiedenheft et al. *Nature* (2012) 482:331-338); Jinek Met al. *Science* (2012)

337:816-821; Cong L et al. *Science* (2013) 339:819-823; Jinek M et al. (2013) *eLife* 2:e00471; Mali P et al. (2013) *Science* 339:823-826; Qi LS et al. (2013) *Cell* 152:1173-1183; Gilbert L A et al. (2013) *Cell* 154:442-451; Yang H et al. (2013) *Cell* 154:1370-1379; and Wang H et al. (2013) *Cell* 153:910-918). Additionally, in the co-pending U.S. Provisional Application 62/005,395 it has been proposed as an anti-viral therapy or more broadly as a way to disrupt genomic material.

**[0032]** In an aspect of the invention, the Cas9 endonuclease causes a double strand break in at least two locations in the genome. These two double strand breaks cause a fragment of the genome to be deleted. Even if viral repair pathways anneal the two ends, there will still be a deletion in the genome. One or more deletions using the mechanism will incapacitate the viral genome. The result is that the host cell will be free of viral infection.

**[0033]** In embodiments of the invention, nucleases cleave the genome of the target virus. A nuclease is an enzyme capable of cleaving the phosphodiester bonds between the nucleotide subunits of nucleic acids. Endonucleases are enzymes that cleave the phosphodiester bond within a polynucleotide chain. Some, such as Deoxyribonuclease I, cut DNA relatively nonspecifically (without regard to sequence), while many, typically called restriction endonucleases or restriction enzymes, cleave only at very specific nucleotide sequences. In a preferred embodiment of the invention, the Cas9 nuclease is incorporated into the compositions and methods of the invention, however, it should be appreciated that any nuclease may be utilized.

**[0034]** In preferred embodiments of the invention, the Cas9 nuclease is used to cleave the genome. The Cas9 nuclease is capable of creating a double strand break in the genome. The Cas9 nuclease has two functional domains: RuvC and HNH, each cutting a different strand. When both of these domains are active, the Cas9 causes double strand breaks in the genome.

**[0035]** In some embodiments of the invention, insertions into the genome can be designed to cause incapacitation, or altered genomic expression. Additionally, insertions/deletions are also used to introduce a premature stop codon either by creating one at the double strand break or by shifting the reading frame to create one downstream of the double strand break. Any of these outcomes of the NHEJ repair pathway can be leveraged to disrupt the target gene. The changes introduced by the use of the CRISPR/gRNA/Cas9 system are permanent to the genome.

**[0036]** In some embodiments of the invention, at least one insertion is caused by the CRISPR/gRNA/Cas9 complex. In a preferred embodiment, numerous insertions are caused in the genome, thereby incapacitating the virus. In an aspect of the invention, the number of insertions lowers the probability that the genome may be repaired.

**[0037]** In some embodiments of the invention, at least one deletion is caused by the CRISPR/gRNA/Cas9 complex. In a preferred embodiment, numerous deletions are caused in the genome, thereby incapacitating the virus. In an aspect of the invention, the number of deletions lowers the probability that the genome may be repaired. In a highly-preferred embodiment, the CRISPR/Cas9/gRNA system of the invention causes significant genomic disruption, resulting in effective destruction of the viral genome, while leaving the host genome intact.

**[0038]** In some embodiments of the invention, a template sequence is inserted into the genome. In order to introduce nucleotide modifications to genomic DNA, a DNA repair template containing the desired sequence must be present during HDR. The DNA template is normally transfected into the cell along with the gRNA/Cas9. The length and binding position of each homology arm is dependent on the size of the change being introduced. In the presence of a suitable template, HDR can introduce specific nucleotide changes at the Cas9 induced double strand break.

**[0039]** Some embodiments of the invention may utilize modified version of a nuclease. Modified versions of the Cas9 enzyme containing a single inactive catalytic domain, either RuvC- or HNH-, are called ‘nickases’. With only one active nuclease domain, the Cas9 nickase cuts only one strand of the target DNA, creating a single-strand break or ‘nick’. Similar to the inactive dCas9 (RuvC- and HNH-), a Cas9 nickase is still able to bind DNA based on gRNA specificity, though nickases will only cut one of the DNA strands. The majority of CRISPR plasmids are derived from *S. pyogenes* and the RuvC domain can be inactivated by a D10A mutation and the HNH domain can be inactivated by an H840A mutation.

**[0040]** A single-strand break, or nick, is normally quickly repaired through the HDR pathway, using the intact complementary DNA strand as the template. However, two proximal, opposite strand nicks introduced by a Cas9 nickase are treated as a double strand break, in what is often referred to as a ‘double nick’ or ‘dual nickase’ CRISPR system. A double-nick induced double strand break can be repaired by either NHEJ or HDR depending on the desired effect on the gene target. At these double strand breaks, insertions and deletions are caused by the CRISPR/Cas9 complex. In an aspect of the invention, a deletion is caused by positioning two double strand breaks proximate to one another, thereby causing a fragment of the genome to be deleted.

**[0041]** As versatile as the Cas9 protein is (as either a nuclease, nickase or platform), it requires the targeting specificity of a gRNA in order to act. As discussed below, guide RNAs or single guide RNAs are specifically designed to target a virus genome.

**[0042]** A CRISPR/Cas9 gene editing complex of the invention works optimally with a guide RNA that targets the viral genome. Guide RNA (gRNA) or single guide RNA (sgRNA) leads the CRISPR/Cas9 complex to the viral genome in order to cause viral genomic disruption.

**[0043]** In an aspect of the invention, CRISPR/Cas9/gRNA complexes are designed to target specific viruses within a cell. It should be appreciated that any virus can be targeted using the composition of the invention. Identification of specific regions of the virus genome aids in development and designing of CRISPR/Cas9/gRNA complexes.

**[0044]** In an aspect of the invention, the CRISPR/Cas9/gRNA complexes are designed to target latent viruses within a cell. Once transfected within a cell, the CRISPR/Cas9/gRNA complexes cause repeated insertions or deletions to render the genome incapacitated, or due to number of insertions or deletions, the probability of repair is significantly reduced.

**[0045]** As an example, the Epstein-Barr virus (EBV), also called human herpesvirus 4 (HHV-4) is inactivated in cells by a CRISPR/Cas9/gRNA complex of the invention. EBV is a virus of the herpes family, and is one of the most common viruses in humans. The virus is approximately 122 nm to 180

nm in diameter and is composed of a double helix of DNA wrapped in a protein capsid. In this example, the Raji cell line serves as an appropriate in vitro model. The Raji cell line is the first continuous human cell line from hematopoietic origin and cell lines produce an unusual strain of Epstein-Barr virus while being one of the most extensively studied EBV models. To target the EBV genomes in the Raji cells, a CRISPR/Cas9 complex with specificity for EBV is needed. The design of EBV-targeting CRISPR/Cas9 plasmids consisting of a U6 promoter driven chimeric guide RNA (sgRNA) and a ubiquitous promoter driven Cas9 that were obtained from Addgene, Inc. Commercially available guide RNAs and Cas9 nucleases may be used with the present invention. A marker such as EGFP fused after the Cas9 protein allows selection of Cas9-positive cells (FIG. 1A).

**[0046]** In an aspect of the invention, guide RNAs are designed, whether or not commercially purchased, to target a specific viral genome. The viral genome is identified and guide RNA to target selected portions of the viral genome are developed and incorporated into the composition of the invention. In an aspect of the invention, a reference genome of a particular strain of the virus is selected for guide RNA design.

**[0047]** For example, guide RNAs that target the EBV genome are a component of the system in the present example. In relation to EBV, for example, the reference genome from strain B95-8 was used as a design guide. Within a genome of interest, such as EBV, selected regions, or genes are targeted. For example, six regions can be targeted with seven guide RNA designs for different genome editing purposes (FIG. 1C and 10 and Table S1 at FIG. 8). In relation to EBV, EBNA1 is the only nuclear Epstein-Barr virus (EBV) protein expressed in both latent and lytic modes of infection. While EBNA1 is known to play several important roles in latent infection, EBNA1 is crucial for many EBV functions including gene regulation and latent genome replication. Therefore, guide RNAs sgEBV4 and sgEBV5 were selected to target both ends of the EBNA1 coding region in order to excise this whole region of the genome. These “structural” targets enable systematic digestion of the EBV genome into smaller pieces. EBNA3C and LMP1 are essential for host cell transformation, and guide RNAs sgEBV3 and sgEBV7 were designed to target the 5' exons of these two proteins respectively.

**[0048]** In some embodiments, specific CRISPR/Cas9/gRNA complexes are introduced into a cell. A guide RNA is designed to target at least one category of sequences of the viral genome. In addition to latent infections this invention can also be used to control actively replicating viruses by targeting the viral genome before it is packaged or after it is ejected.

**[0049]** Prepackaged GFP-Cas9-adenovirus is available from Vector Biolabs (Philadelphia, Pa.). Various targeting gRNA sequences, such as sequences that target EBV can be packaged to adenovirus lines. The gRNA sequences can be housed together with the CRISPR/Cas9 complex or separately.

**[0050]** In some embodiments, a cocktail of guide RNAs may be introduced into a cell. The guide RNAs are designed to target numerous categories of sequences of the viral genome. By targeting several areas along the genome, the double strand break at multiple locations fragments the

genome, lowering the possibility of repair. Even with repair mechanisms, the large deletions render the virus incapacitated.

**[0051]** In some embodiments, several guide RNAs are added to create a cocktail to target different categories of sequences. For example, two, five, seven or eleven guide RNAs may be present in a CRISPR cocktail targeting three different categories of sequences. However, any number of gRNAs may be introduced into a cocktail to target categories of sequences. In preferred embodiments, the categories of sequences are important for genome structure, host cell transformation, and infection latency, respectively.

**[0052]** In some aspects of the invention, *in vitro* experiments allow for the determination of the most essential targets within a viral genome. For example, to understand the most essential targets for effective incapacitation of a genome, subsets of guide RNAs are transfected into model cells. Assays can determine which guide RNAs or which cocktail is the most effective at targeting essential categories of sequences.

**[0053]** For example, in the case of the EBV genome targeting, seven guide RNAs in the CRISPR cocktail targeted three different categories of sequences which are identified as being important for EBV genome structure, host cell transformation, and infection latency, respectively. To understand the most essential targets for effective EBV treatment, Raji cells were transfected with subsets of guide RNAs. Although sgEBV4/5 reduced the EBV genome by 85%, they could not suppress cell proliferation as effectively as the full cocktail (FIG. 3A). Guide RNAs targeting the structural sequences (sgEBV1/2/6) could stop cell proliferation completely, despite not eliminating the full EBV load (26% decrease). Given the high efficiency of genome editing and the proliferation arrest (FIG. 2), it was suspected that the residual EBV genome signature in sgEBV1/2/6 was not due to intact genomes but to free-floating DNA that has been digested out of the EBV genome, *i.e.* as a false positive.

**[0054]** Once CRISPR/Cas9/gRNA complexes are constructed, the complexes are introduced into a cell. It should be appreciated that complexes can be introduced into cells in an *in vitro* model or an *in vivo* model. In an aspect of the invention, CRISPR/Cas9/gRNA complexes are designed to not leave intact genomes of a virus after transfection and complexes are designed for efficient transfection.

**[0055]** Nucleases are not the only possible therapeutic agents one could deploy against latent viral infections. In cases where a small number of cells are infected and it would suffice to ablate the entire cell (as well as the latent viral genome), an aspect of the invention contemplates administration of a vector containing a promoter which is active in the latent viral state, wherein the promoter drives a cell-killing gene. HSV is a particularly interesting target for this approach as it has been estimated that only 20,000 neurons are latently infected. (Schiffer *et al*). Examples of cell-killing genes include apoptosis effectors such as BAX and BAK and proteins that destroy the integrity of the cell or mitochondrial membrane, such as BCL-2 and alpha hemolysin. (Bayles, "Bacterial programmed cell death: making sense of a paradox," *Nature Reviews Microbiology* 12 pp.63-69 (2014)). Having a promoter that is only activated in latently infected cells could be used not only in this context but also be used to increase selectivity of nuclease therapy by making activity specific to infected cells; an example of such a promoter is LAP1. (Preston and Efstatiou,

"Molecular Basis of HSV Latency and Reactivation", in *Human Herpesviruses: Biology, Therapy and Immunoprophylaxis* 2007.)

**[0056]** These agents can be delivered either as part of a viral vector (examples further described below), or as naked as DNA or RNA. Naked nucleic acids can be modified to avoid degradation.

**[0057]** Another possibility is to deliver the protein product itself either fused to a signaling molecule or packaged into a vesicle with signaling molecules on surface, or packed into a nanoparticle, vesicle, or attached to a colloid. Examples of this method of delivery have been previously explored in cancer but not applied to local delivery against latent viral infections. (See Alexis *et al*, "Nanoparticle Technologies for Cancer Therapy" in *Drug Delivery, Handbook of Experimental Pharmacology* 197, 2010.) Other delivery methods are described in detail below. For HSV and other viruses which are highly localized in terms of which cells and tissues they infect, these therapies might be delivered as a local injection or as a cream.

**[0058]** In other embodiments of the invention, physical approaches can be used to ablate cells that have latent infection, taking advantage of the fact that these are localized in diseases such as HSV. One approach is to image infected cells (for example, using fluorescent markers against viral protein, or against viral genome, or fluorescence proteins induced by viral latency promoters) and then use heat, light, or radio frequency radiation to ablate those cells. Direct contrast agents can also be used towards infected cells. Instead of fluorescence molecules, semiconductor or metallic nanoparticles, colloids, or other structures that interact strongly with light or radio frequency can be used. These can be applied locally with a cream or injections. These substances can potentially take advantage of a cooperative effect, such that infected cells attract multiple particles, thereby having the highest effect. Similar approaches have been used in cancer treatment (See for example Jain *et al* "Gold nanoparticles as novel agents for cancer therapy," *Br J Radiol* February 2012 85(1010):101-113). The present invention applies these techniques to treatment of latent viral infection.

**[0059]** In another embodiment, labeled and infected cells can be excised using microsurgery tools such as a fiber optic endoscope, which allows imaging and delivery of radiation in a highly localized manner, with single cell resolution. (See Barretto R P and Schnitzer M J. "In Vivo Optical Microendoscopy for Imaging Cells Lying Deep within Live Tissue." *Cold Spring Harb Protoc.* 2012(10) and Llewellyn M E, Barretto R P J, Delp S L & Schnitzer M J. (2008) Minimally invasive high-speed imaging of sarcomere contractile dynamics in mice and humans. *Nature.* 454 784-788).

**[0060]** Aspects of the invention involve introducing or delivering a therapeutic agent, such as the CRISPR/Cas9/gRNA complex, or any of the therapeutic agents described herein, into a cell of interest. It should be appreciated that agents can be introduced into cells in an *in vitro* model or an *in vivo* model.

**[0061]** Aspects of the invention allow for CRISPR/Cas9/gRNA to be transfected into cells by various methods, including viral vectors and non-viral vectors. Viral vectors may include retroviruses, lentiviruses, adenoviruses, and adeno-associated viruses (AAV). It should be appreciated that any viral vector may be incorporated into the present



invention to effectuate delivery of the CRISPR/Cas9/gRNA complex into a cell. Some viral vectors may be more effective than others, depending on the CRISPR/Cas9/gRNA complex designed for digestion or incapacitation. In an aspect of the invention, the vectors contain essential components such as origin of replication, which is necessary for the replication and maintenance of the vector in the host cell.

**[0062]** In an aspect of the invention, viral vectors are used as delivery vectors to deliver the complexes into a cell. Use of viral vectors as delivery vectors are known in the art. See for example WIPO Patent Application WO/2007/071994, the contents of which are incorporated by reference.

**[0063]** A retrovirus is a single-stranded RNA virus that stores its nucleic acid in the form of an mRNA genome (including the 5' cap and 3' PolyA tail) and targets a host cell as an obligate parasite. In some methods in the art, retroviruses have been used to introduce nucleic acids into a cell. Once inside the host cell cytoplasm the virus uses its own reverse transcriptase enzyme to produce DNA from its RNA genome, the reverse of the usual pattern, thus retro (backwards). This new DNA is then incorporated into the host cell genome by an integrase enzyme, at which point the retroviral DNA is referred to as a provirus. For example, the recombinant retroviruses such as the Moloney murine leukemia virus have the ability to integrate into the host genome in a stable fashion. They contain a reverse transcriptase that allows integration into the host genome. Retroviral vectors can either be replication-competent or replication-defective. In some embodiments of the invention, retroviruses are incorporated to effectuate transfection into a cell, however the CRISPR/Cas9/gRNA complexes are designed to target the viral genome.

**[0064]** In some embodiments of the invention, lentiviruses, which are a subclass of retroviruses, are used as viral vectors. Lentiviruses can be adapted as delivery vehicles (vectors) given their ability to integrate into the genome of non-dividing cells, which is the unique feature of lentiviruses as other retroviruses can infect only dividing cells. The viral genome in the form of RNA is reverse-transcribed when the virus enters the cell to produce DNA, which is then inserted into the genome at a random position by the viral integrase enzyme. The vector, now called a provirus, remains in the genome and is passed on to the progeny of the cell when it divides.

**[0065]** As opposed to lentiviruses, adenoviral DNA does not integrate into the genome and is not replicated during cell division. Adenovirus and the related AAV can be used as delivery vectors since they do not integrate into the host's genome. In some aspects of the invention, only the viral genome to be targeted is effected by the CRISPR/Cas9/gRNA complexes, and not the host's cells. Adeno-associated virus (AAV) is a small virus that infects humans and some other primate species. AAV can infect both dividing and non-dividing cells and may incorporate its genome into that of the host cell. For example, because of its potential use as a gene therapy vector, researchers have created an altered AAV called self-complementary adeno-associated virus (scAAV). Whereas AAV packages a single strand of DNA and requires the process of second-strand synthesis, scAAV packages both strands which anneal together to form double stranded DNA. By skipping second strand synthesis scAAV allows for rapid expression in the cell. Otherwise, scAAV carries many characteristics of its AAV counterpart. Meth-

ods of the invention may incorporate herpesvirus, poxvirus, alphavirus, or vaccinia virus as a means of delivery vectors.

**[0066]** In certain embodiments of the invention, non-viral vectors may be used to effectuate transfection. Methods of non-viral delivery of nucleic acids include lipofection, nucleofection, microinjection, biolistics, virosomes, liposomes, micelles, immunoliposomes, polycation or lipid: nucleic acid conjugates, naked DNA, artificial virions, and agent-enhanced uptake of DNA. Lipofection is described in e.g., U.S. Pat. Nos. 5,049,386, 4,946,787; and 4,897,355) and lipofection reagents are sold commercially (e.g., Transfectam and Lipofectin). Cationic and neutral lipids that are suitable for efficient receptor-recognition lipofection of polynucleotides include those of Felgner, WO 91/17424; WO 91/16024. Delivery can be to cells (e.g. in vitro or ex vivo administration) or target tissues (e.g. in vivo administration).

**[0067]** Synthetic vectors are typically based on cationic lipids or polymers which can complex with negatively charged nucleic acids to form particles with a diameter in the order of 100 nm. The complex protects nucleic acid from degradation by nuclease. Moreover, cellular and local delivery strategies have to deal with the need for internalization, release, and distribution in the proper subcellular compartment. Systemic delivery strategies encounter additional hurdles, for example, strong interaction of cationic delivery vehicles with blood components, uptake by the reticuloendothelial system, kidney filtration, toxicity and targeting ability of the carriers to the cells of interest. Modifying the surfaces of the cationic non-virals can minimize their interaction with blood components, reduce reticuloendothelial system uptake, decrease their toxicity and increase their binding affinity with the target cells. Binding of plasma proteins (also termed opsonization) is the primary mechanism for RES to recognize the circulating nanoparticles. For example, macrophages, such as the Kupffer cells in the liver, recognize the opsonized nanoparticles via the scavenger receptor.

**[0068]** In some embodiments of the invention, non-viral vectors are modified to effectuate targeted delivery and transfection. PEGylation (i.e. modifying the surface with polyethyleneglycol) is the predominant method used to reduce the opsonization and aggregation of non-viral vectors and minimize the clearance by reticuloendothelial system, leading to a prolonged circulation lifetime after intravenous administration. PEGylated nanoparticles are therefore often referred as "stealth" nanoparticles. The nanoparticles that are not rapidly cleared from the circulation will have a chance to encounter infected cells.

**[0069]** However, PEG on the surface can decrease the uptake by target cells and reduce the biological activity. Therefore, to attach targeting ligand to the distal end of the PEGylated component is necessary; the ligand is projected beyond the PEG "shield" to allow binding to receptors on the target cell surface. When cationic liposome is used as gene carrier, the application of neutral helper lipid is helpful for the release of nucleic acid, besides promoting hexagonal phase formation to enable endosomal escape. In some embodiments of the invention, neutral or anionic liposomes are developed for systemic delivery of nucleic acids and obtaining therapeutic effect in experimental animal model. Designing and synthesizing novel cationic lipids and polymers, and covalently or noncovalently binding gene with peptides, targeting ligands, polymers, or environmentally

sensitive moieties also attract many attentions for resolving the problems encountered by non-viral vectors. The application of inorganic nanoparticles (for example, metallic nanoparticles, iron oxide, calcium phosphate, magnesium phosphate, manganese phosphate, double hydroxides, carbon nanotubes, and quantum dots) in delivery vectors can be prepared and surface-functionalized in many different ways.

**[0070]** In some embodiments of the invention, targeted controlled-release systems responding to the unique environments of tissues and external stimuli are utilized. Gold nanorods have strong absorption bands in the near-infrared region, and the absorbed light energy is then converted into heat by gold nanorods, the so-called 'photothermal effect'. Because the near-infrared light can penetrate deeply into tissues, the surface of gold nanorod could be modified with nucleic acids for controlled release. When the modified gold nanorods are irradiated by near-infrared light, nucleic acids are released due to thermo-denaturation induced by the photothermal effect. The amount of nucleic acids released is dependent upon the power and exposure time of light irradiation.

**[0071]** In some embodiments of the invention, liposomes are used to effectuate transfection into a cell or tissue. A "liposome" as used herein refers to a small, spherical vesicle composed of lipids, particularly vesicle-forming lipids capable of spontaneously arranging into lipid bilayer structures in water with its hydrophobic moiety in contact with the interior, hydrophobic region of the bilayer membrane, and its head group moiety oriented toward the exterior, polar surface of the membrane. Vesicle-forming lipids have typically two hydrocarbon chains, particularly acyl chains, and a head group, either polar or nonpolar. Vesicle-forming lipids are either composed of naturally-occurring lipids or of synthetic origin, including the phospholipids, such as phosphatidylcholine, phosphatidylethanolamine, phosphatidic acid, phosphatidylinositol, and sphingomyelin, where the two hydrocarbon chains are typically between about 14-22 carbon atoms in length, and have varying degrees of unsaturation. The above-described lipids and phospholipids whose acyl chains have varying degrees of saturation can be obtained commercially or prepared according to published methods. Other suitable lipids for use in the composition of the present invention include glycolipids and sterols such as cholesterol and its various analogs which can also be used in the liposomes.

**[0072]** Similar to a liposome, a micelle is a small spherical vesical composed of lipids, but is arranged as a lipid monolayer, with the hydrophilic head regions of the lipid molecules in contact with surrounding solvent, sequestering the hydrophobic single-tail regions in the center of the micelle. This phase is caused by the packing behavior of single-tail lipids in a bilayer.

**[0073]** The pharmacology of a liposomal formulation of nucleic acid is largely determined by the extent to which the nucleic acid is encapsulated inside the liposome bilayer. Encapsulated nucleic acid is protected from nuclease degradation, while those merely associated with the surface of the liposome is not protected. Encapsulated nucleic acid shares the extended circulation lifetime and biodistribution of the intact liposome, while those that are surface associated adopt the pharmacology of naked nucleic acid once they disassociate from the liposome.

**[0074]** In some embodiments, the complexes of the invention are encapsulated in a liposome. Unlike small molecule

drugs, nucleic acids cannot cross intact lipid bilayers, predominantly due to the large size and hydrophilic nature of the nucleic acid. Therefore, nucleic acids may be entrapped within liposomes with conventional passive loading technologies, such as ethanol drop method (as in SALP), reverse-phase evaporation method, and ethanol dilution method (as in SNALP).

**[0075]** In some embodiments, linear polyethylenimine (L-PEI) is used as a non-viral vector due to its versatility and comparatively high transfection efficiency. L-PEI has been used to efficiently deliver genes *in vivo* into a wide range of organs such as lung, brain, pancreas, retina, bladder as well as tumor. L-PEI is able to efficiently condense, stabilize and deliver nucleic acids *in vitro* and *in vivo*.

**[0076]** Low-intensity ultrasound in combination with microbubbles has recently acquired much attention as a safe method of gene delivery. Ultrasound shows tissue-permeabilizing effect. It is non-invasive and site-specific, and could make it possible to destroy tumor cells after systemic delivery, while leave nontargeted organs unaffected. Ultrasound-mediated microbubbles destruction has been proposed as an innovative method for noninvasive delivering of drugs and nucleic acids to different tissues. Microbubbles are used to carry a drug or gene until a specific area of interest is reached, and then ultrasound is used to burst the microbubbles, causing site-specific delivery of the bioactive materials. Furthermore, the ability of albumin-coated microbubbles to adhere to vascular regions with glycocalyx damage or endothelial dysfunction is another possible mechanism to deliver drugs even in the absence of ultrasound. See Tsutsui et al., *Cardiovasc Ultrasound*. 2004; 2: 23, doi: 10.1186/1476-7120-2-23. In ultrasound-triggered drug delivery, tissue-permeabilizing effect can be potentiated using ultrasound contrast agents, gas-filled microbubbles. The use of microbubbles as nucleic acid vectors is based on the hypothesis that destruction of DNA-loaded microbubbles by a focused ultrasound beam during their microvascular transit through the target area will result in localized transduction upon disruption of the microbubble shell while sparing non-targeted areas.

**[0077]** Besides ultrasound-mediated delivery, magnetic targeting delivery could be used for delivery. Magnetic nanoparticles are usually entrapped in gene vectors for imaging the delivery of nucleic acid. Nucleic acid carriers can be responsive to both ultrasound and magnetic fields, i.e., magnetic and acoustically active lipospheres (MAALs). The basic premise is that therapeutic agents are attached to, or encapsulated within, a magnetic micro- or nanoparticle. These particles may have magnetic cores with a polymer or metal coating which can be functionalized, or may consist of porous polymers that contain magnetic nanoparticles precipitated within the pores. By functionalizing the polymer or metal coating it is possible to attach, for example, cytotoxic drugs for targeted chemotherapy or therapeutic DNA to correct a genetic defect. Once attached, the particle/therapeutic agent complex is injected into the bloodstream, often using a catheter to position the injection site near the target. Magnetic fields, generally from high-field, high-gradient, rare earth magnets are focused over the target site and the forces on the particles as they enter the field allow them to be captured and extravasated at the target.

**[0078]** Synthetic cationic polymer-based nanoparticles (~100 nm diameter) have been developed that offer enhanced transfection efficiency combined with reduced

cytotoxicity, as compared to traditional liposomes. The incorporation of distinct layers composed of lipid molecules with varying physical and chemical characteristics into the polymer nanoparticle formulation resulted in improved efficiency through better fusion with cell membrane and entry into the cell, enhanced release of molecules inside the cell, and reduced intracellular degradation of nanoparticle complexes.

**[0079]** In some embodiments, the complexes are conjugated to nano-systems for systemic therapy, such as liposomes, albumin-based particles, PEGylated proteins, biodegradable polymer-drug composites, polymeric micelles, dendrimers, among others. Davis M E, Chen Z G, Shin D M. *Nat Rev Drug Discov.* 2008;7:771-782. Long circulating macromolecular carriers such as liposomes, can exploit the enhanced permeability and retention effect for preferential extravasation from tumor vessels. See *Biomaterials.* 1995 Jan;16(2):145-8. In certain embodiments, the complexes of the invention are conjugated to or encapsulated into a liposome or polymerosome for delivery to a cell. For example, liposomal anthracyclines have achieved highly efficient encapsulation, and include versions with greatly prolonged circulation such as liposomal daunorubicin and pegylated liposomal doxorubicin. See Krishna et al., Carboxymethylcellulose-sodium based transdermal drug delivery system for propranolol, *J Pharm Pharmacol.* 1996 April; 48(4):367-70.

**[0080]** Liposomal delivery systems provide stable formulation, provide improved pharmacokinetics, and a degree of 'passive' or 'physiological' targeting to tissues. Encapsulation of hydrophilic and hydrophobic materials, such as potential chemotherapy agents, are known. See for example U.S. Pat. No. 5,466,468 to Schneider et al. issued Nov. 14, 1995 which discloses parenterally administrable liposome formulation comprising synthetic lipids; U.S. Pat. No. 5,580,571, issued Dec. 3, 1996 to Hostetler et al. which discloses nucleoside analogues conjugated to phospholipids; U.S. Pat. No. 5,626,869 to Nyqvist et al. issued May 6, 1997 which discloses pharmaceutical compositions wherein the pharmaceutically active compound is heparin or a fragment thereof contained in a defined lipid system comprising at least one amphiphatic and polar lipid component and at least one nonpolar lipid component.

**[0081]** Liposomes and polymerosomes can contain a plurality of solutions and compounds.

**[0082]** In certain embodiments, the complexes of the invention are coupled to or encapsulated in polymersomes. As a class of artificial vesicles, polymersomes are tiny hollow spheres that enclose a solution, made using amphiphilic synthetic block copolymers to form the vesicle membrane. Common polymersomes contain an aqueous solution in their core and are useful for encapsulating and protecting sensitive molecules, such as drugs, enzymes, other proteins and peptides, and DNA and RNA fragments. The polymersome membrane provides a physical barrier that isolates the encapsulated material from external materials, such as those found in biological systems. Polymersomes can be generated from double emulsions by known techniques, see Languir 2005, 21, 9183-9186, Lorceau et al. "Generation of Polymersomes from Double-Emulsions."

**[0083]** Some embodiments of the invention provide for a gene gun or a biolistic particle delivery system. A gene gun is a device for injecting cells with genetic information, where the payload may be an elemental particle of a heavy

metal coated with plasmid DNA. This technique may also be referred to as bioballistics or biolistics. Gene guns have also been used to deliver DNA vaccines. The gene gun is able to transfect cells with a wide variety of organic and non-organic species, such as DNA plasmids, fluorescent proteins, dyes, etc.

**[0084]** Aspects of the invention provide for numerous uses of delivery vectors. Selection of the delivery vector is based upon the cell or tissue targeted and the specific makeup of the CRISPR/Cas9/gRNA. For example, in the EBV example discussed above, since lymphocytes are known for being resistant to lipofection, nucleofection (a combination of electrical parameters generated by a device called Nucleofector, with cell-type specific reagents to transfer a substrate directly into the cell nucleus and the cytoplasm) was necessitated for DNA delivery into the Raji cells. The Lonza pmax promoter drives Cas9 expression as it offered strong expression within Raji cells. 24 hours after nucleofection, obvious EGFP signals were observed from a small proportion of cells through fluorescent microscopy. The EGFP-positive cell population decreased dramatically, however, <10% transfection efficiency 48 hours after nucleofection was measured (FIG. 1B). A CRISPR plasmid that included the EBV origin of replication sequence, oriP yielded a transfection efficiency >60% (FIG. 1B).

**[0085]** Once inside the cell, the CRISPR/Cas9/gRNA complexes target the viral genome. In an aspect of the invention, the complexes are targeted to viral genomes. In addition to latent infections this invention can also be used to control actively replicating viruses by targeting the viral genome before it is packaged or after it is ejected. In preferred embodiments, the CRISPR/Cas9/gRNA complexes target latent viral genomes, thereby reducing the chances of proliferation. The guided RNA complexes target a determined number of categories of sequences of the viral genome to incapacitate the viral genome. As discussed above, the Cas9 endonuclease causes a double strand break in the viral genome. By targeted several locations along the viral genome and causing not a single strand break, but a double strand break, the genome is effectively cut a several locations along the genome. In a preferred embodiment, the double strand breaks are designed so that small deletions are caused, or small fragments are removed from the genome so that even if natural repair mechanisms join the genome together, the genome is rendered incapacitated.

**[0086]** After introduction into a cell, the CRISPR/Cas9/gRNA complexes act on the viral genome. The double-strand DNA breaks generated by CRISPR are repaired with small deletions. These deletions will disrupt the protein coding and hence create knockout effects.

**[0087]** In a preferred embodiment of the invention, CRISPR/Cas9/gRNA complexes are transfected into cells containing viral genomes. The gRNAs are designed to localize the Cas9 endonuclease at several locations along the viral genome. The Cas9 endonuclease caused double strand breaks in the genome, causing small fragments to be deleted from the viral genome. Even with repair mechanisms, the deletions render the viral genome incapacitated. Engineered viral particles with higher cell affinity (e.g. RGD knob) and specificity could greatly improve delivery efficiency. Delivery of circular instead of linear DNA may also be beneficial since the circular DNA can replicate as episomes with replication origins.

**[0088]** Aspects of the invention utilize the CRISPR/Cas9/gRNA complexes for the targeted delivery. Common known pathways include transdermal, transmucal, nasal, ocular and pulmonary routes. Drug delivery systems may include liposomes, proliposomes, micelles, microspheres, gels, prod-rugs, cyclodextrins, etc. Aspects of the invention utilize nanoparticles composed of biodegradable polymers to be transferred into an aerosol for targeting of specific sites or cell populations in the lung, providing for the release of the drug in a predetermined manner and degradation within an acceptable period of time. Controlled-release technology (CRT), such as transdermal and transmucosal controlled-release delivery systems, nasal and buccal aerosol sprays, drug-impregnated lozenges, encapsulated cells, oral soft gels, iontophoretic devices to administer drugs through skin, and a variety of programmable, implanted drug-delivery devices are used in conjunction with the complexes of the invention of accomplishing targeted and controlled delivery.

**[0089]** Also the following items are within the ambit of the invention:

**[0090]** The first item relates to a therapeutic composition for treatment of a viral infection, the composition comprising:

**[0091]** a CRISPR/Cas9 endonuclease; and

**[0092]** a guide RNA that specifically targets a portion of a viral genome.

**[0093]** Item two is a preferred embodiment of the first item, wherein said CRISPR/Cas9 endonuclease and said guide RNA are co-expressed in a host cell infected by a virus.

**[0094]** Item three is a preferred embodiment of the first item and of item two, wherein said CRISPR/Cas9 endonuclease and said guide RNA are packaged in a delivery vector.

**[0095]** Item four is a preferred embodiment of item three, wherein the delivery vector is a viral vector.

**[0096]** Item five is a preferred embodiment of item four, wherein the viral vector is selected from the group consisting of retrovirus, lentivirus, adenovirus, herpesvirus, poxvirus, alphavirus, vaccinia virus and adeno-associated viruses.

**[0097]** Item six is a preferred embodiment of item three, wherein the delivery vector is a non-viral vector.

**[0098]** Item seven is a preferred embodiment of item six, wherein the non-viral vector is selected from the group consisting of a nanoparticle, a cationic lipid, a cationic polymer, a metallic nanoparticle, a nanorod, a liposome, microbubbles, cell-penetrating peptide, and a liposphere.

**[0099]** Item eight is a preferred embodiment of item seven, wherein the non-viral vector comprises polyethyleneglycol (PEG).

**[0100]** A ninth item relates to a method for treating a viral infection, the method comprising the steps of:

**[0101]** delivering to a virus-infected cell a complex comprising a CRISPR/Cas9 endonuclease and a guide RNA that specifically targets one or more portions of the genome of said virus; wherein said complex binds to and alters said viral genome but does not alter genomic material of said infected cell.

**[0102]** Item ten is a preferred embodiment of item nine, wherein said virus is latent in said virus-infected cell.

**[0103]** Item eleven is a preferred embodiment of item ten, wherein the delivering step comprises delivering said complex in viral vector.

**[0104]** Item twelve is a preferred embodiment of item eleven, wherein the viral vector is selected from the group consisting of retrovirus, lentivirus, adenovirus, herpesvirus, poxvirus, alphavirus, vaccinia virus and adeno-associated viruses.

**[0105]** Item thirteen is a preferred embodiment of item ten, wherein the delivering step comprises delivering said complex in a non-viral vector.

**[0106]** Item fourteen is a preferred embodiment of item thirteen, wherein the non-viral vector is selected from the group consisting of a nanoparticle, a cationic lipid, a cationic polymer, metallic nanoparticle, a nanorod, a liposome, microbubbles, a cell-penetrating peptide, and a liposphere.

**[0107]** Item fifteen is a preferred embodiment of item thirteen, wherein the non-viral vector comprises polyethyleneglycol (PEG).

**[0108]** Item sixteen is a preferred embodiment of item eleven or thirteen, wherein the method further comprises the step of applying energy to said vector.

**[0109]** Item seventeen is a preferred embodiment of item sixteen, wherein the energy is ultrasound or electrophoresis.

**[0110]** Item eighteen is a preferred embodiment of item nine through seventeen, wherein alters comprises causing a double strand break in the genome of said virus.

**[0111]** Item nineteen is a preferred embodiment of item nine through seventeen, wherein alters comprises causing multiple double strand breaks in the genome of said virus.

**[0112]** Item twenty is a preferred embodiment of item nine through nineteen, wherein alters comprises causing an insertion in the genome of said virus.

**[0113]** Item twenty-one is a preferred embodiment of item nine through nineteen, wherein alters comprises causing multiple insertions in the genome of said virus.

**[0114]** Also the following aspects and embodiments are within the ambit of the invention: A first aspect relates to a composition for treating a latent viral infection, the composition comprising:

**[0115]** a vector;

**[0116]** a CRISPR/Cas9 endonuclease; and

**[0117]** a guide DNA operable to target a portion of a viral genome.

**[0118]** Embodiment two is a preferred embodiment of the first aspect, wherein the vector is a viral vector.

**[0119]** Embodiment three is a preferred embodiment of embodiment two, wherein the viral vector is selected from a group consisting of retrovirus, lentivirus, adenovirus, herpesvirus, poxvirus, alphavirus, vaccinia virus, and adeno-associated viruses.

**[0120]** Embodiment four is a preferred embodiment of the first aspect, wherein the vector is a non-viral vector.

**[0121]** Embodiment five is a preferred embodiment of the fourth embodiment, wherein the non-viral vector is selected from a group consisting of nanoparticles, cationic lipids, cationic polymers, metallic nanoparticles, nanorods, liposomes, micelles, microbubbles, cell-penetrating peptides, and lipospheres.

**[0122]** Embodiment six is a preferred embodiment of the first aspect, including embodiments two to five, wherein the viral genome is an EBV genome.

**[0123]** Embodiment seven is a preferred embodiment of the first aspect, including embodiments two to six, wherein the CRISPR/Cas9 endonuclease comprises circular DNA.

**[0124]** Embodiment eight is a preferred embodiment of the first aspect, including embodiments two to six, wherein the CRISPR/Cas9 endonuclease comprises linear DNA.

**[0125]** Embodiment nine is a preferred embodiment of the first aspect, including embodiments two to eight, wherein the composition further comprises a promoter operable to be activated only in a latent viral state cell.

**[0126]** A second aspect relates to a method for delivering a therapeutic agent to a cell, the method comprising:

**[0127]** providing a composition comprising a vector, a CRISPR/Cas9 endonuclease, and a guide DNA that targets a portion of the viral genome; and

**[0128]** delivering, using a vector, the composition into a cell containing latent viral nucleic acid.

**[0129]** Embodiment eleven is a preferred embodiment of the second aspect, wherein the composition is delivered using a viral vector.

**[0130]** Embodiment twelve is a preferred embodiment of embodiment eleven, wherein the viral vector is selected from a group consisting of retrovirus, lentivirus, adenovirus, herpesvirus, poxvirus, alphavirus, vaccinia virus, and adeno-associated viruses.

**[0131]** Embodiment thirteen is a preferred embodiment of the second aspect, including embodiments eleven to twelve, wherein the composition is delivered using a non-viral vector.

**[0132]** Embodiment fourteen is a preferred embodiment of embodiment thirteen, wherein the non-viral vector is selected from a group consisting of nanoparticles, cationic lipids, cationic polymers, metallic nanoparticles, nanorods, liposomes, micelles, microbubbles, cell-penetrating peptides, and lipospheres.

**[0133]** Embodiment fifteen is a preferred embodiment of the second aspect, including embodiments eleven to fourteen, wherein the viral genome is an EBV genome.

**[0134]** Embodiment sixteen is a preferred embodiment of the second aspect, including embodiments eleven to fifteen, wherein the CRISPR/Cas9 endonuclease is circular DNA.

**[0135]** Embodiment seventeen is a preferred embodiment of the second aspect, including embodiments eleven to fifteen, wherein the CRISPR/Cas9 endonuclease is linear DNA.

**[0136]** Embodiment eighteen is a preferred embodiment of the second aspect, including embodiments eleven to seventeen, wherein the method further comprises a promoter operable to be activated only in a latent viral state cell.

**[0137]** A third aspect relates to a composition for treating a latent viral infection, the composition comprising:

**[0138]** a vector;

**[0139]** a nucleic acid comprising a promoter operable to be activated only in a latent viral state cell; and

**[0140]** a cell-killing gene that is driven by the promoter.

**[0141]** Embodiment twenty is a preferred embodiment of the third aspect, wherein the cell-killing gene is selected from a group consisting of BAX, BAK, BCL-2, and alpha-hemolysin.

**[0142]** Embodiment twenty-one is a preferred embodiment of the third aspect, wherein the composition is delivered using a viral vector.

**[0143]** Embodiment twenty-two is a preferred embodiment of embodiment twenty-one, wherein the viral vector is selected from a group consisting of retrovirus, lentivirus, adenovirus, herpesvirus, poxvirus, alphavirus, vaccinia virus, and adeno-associated viruses.

**[0144]** Embodiment twenty-three is a preferred embodiment of the third aspect, wherein the composition is delivered using a non-viral vector.

**[0145]** Embodiment twenty-four is a preferred embodiment of embodiment twenty-three, wherein the non-viral vector is selected from a group consisting of nanoparticles, cationic lipids, cationic polymers, metallic nanoparticles, nanorods, liposomes, micelles, microbubbles, cell-penetrating peptides, and lipospheres.

## EXAMPLES

**[0146]** Burkitt's lymphoma cell lines Raji, Namalwa, and DG-75 were obtained from ATCC and cultured in RPMI 1640 supplemented with 10% FBS and PSA, following ATCC recommendation. Human primary lung fibroblast IMR-90 was obtained from Coriell and cultured in Advanced DMEM/F-12 supplemented with 10% FBS and PSA.

**[0147]** Plasmids consisting of a U6 promoter driven chimeric guide RNA (sgRNA) and a ubiquitous promoter driven Cas9 were obtained from addgene, as described by Cong L et al. (2013) Multiplex Genome Engineering Using CRISPR/Cas Systems. *Science* 339:819-823. An EGFP marker fused after the Cas9 protein allowed selection of Cas9-positive cells (FIG. 1A). We adapted a modified chimeric guide RNA design for more efficient Pol-III transcription and more stable stem-loop structure (Chen B et al. (2013) Dynamic Imaging of Genomic Loci in Living Human Cells by an Optimized CRISPR/Cas System. *Cell* 155:1479-1491).

**[0148]** We obtained pX458 from Addgene, Inc. A modified CMV promoter with a synthetic intron (pmax) was PCR amplified from Lonza control plasmid pmax-GFP. A modified guide RNA sgRNA(F+E) was ordered from IDT. EBV replication origin oriP was PCR amplified from B95-8 transformed lymphoblastoid cell line GM12891. We used standard cloning protocols to clone pmax, sgRNA(F+E) and oriP to pX458, to replace the original CAG promoter, sgRNA and fl origin. We designed EBV sgRNA based on the B95-8 reference, and ordered DNA oligos from IDT. The original sgRNA place holder in pX458 serves as the negative control.

**[0149]** Lymphocytes are known for being resistant to lipofection, and therefore we used nucleofection for DNA delivery into Raji cells. We chose the Lonza pmax promoter to drive Cas9 expression as it offered strong expression within Raji cells. We used the Lonza

**[0150]** Nucleofector II for DNA delivery. 5 million Raji or DG-75 cells were transfected with 5 ug plasmids in each 100-ul reaction. Cell line Kit V and program M-013 were used following Lonza recommendation. For IMR-90, 1 million cells were transfected with 5 ug plasmids in 100 ul Solution V, with program T-030 or X-005. 24 hours after nucleofection, we observed obvious EGFP signals from a small proportion of cells through fluorescent microscopy. The EGFP-positive cell population decreased dramatically after that, however, and we measured <10% transfection efficiency 48 hours after nucleofection (FIG. 1B). We attributed this transfection efficiency decrease to the plasmid dilution with cell division. To actively maintain the plasmid level within the host cells, we redesigned the CRISPR plasmid to include the EBV origin of replication sequence, oriP. With active plasmid replication inside the cells, the transfection efficiency rose to >60% (FIG. 1B).

**[0151]** To design guide RNA targeting the EBV genome, we relied on the EBV reference genome from strain B95-8. We targeted six regions with seven guide RNA designs for different genome editing purposes (FIG. 1C and Table 51). EBNA1 is crucial for many EBV functions including gene regulation and latent genome replication. We targeted guide RNA sgEBV4 and sgEBV5 to both ends of the EBNA1 coding region in order to excise this whole region of the genome. Guide RNAs sgEBV1, 2 and 6 fall in repeat regions, so that the success rate of at least one CRISPR cut is multiplied. These “structural” targets enable systematic digestion of the EBV genome into smaller pieces. EBNA3C and LMP1 are essential for host cell transformation, and we designed guide RNAs sgEBV3 and sgEBV7 to target the 5' exons of these two proteins respectively.

**[0152]** EBV Genome Editing. The double-strand DNA breaks generated by CRISPR are repaired with small deletions. These deletions will disrupt the protein coding and hence create knockout effects. SURVEYOR assays confirmed efficient editing of individual sites (FIG. 5). Beyond the independent small deletions induced by each guide RNA, large deletions between targeting sites can systematically destroy the EBV genome. Guide RNA sgEBV2 targets a region with twelve 125-bp repeat units (FIG. 2A). PCR amplicon of the whole repeat region gave a ~1.8-kb band (FIG. 2B). After 5 or 7 days of sgEBV2 transfection, we obtained ~0.4-kb bands from the same PCR amplification (FIG. 2B). The ~1.4-kb deletion is the expected product of repair ligation between cuts in the first and the last repeat unit (FIG. 2A).

**[0153]** DNA sequences flanking sgRNA targets were PCR amplified with Phusion DNA polymerase (FIG. 9, Table S2). SURVEYOR assays were performed following manufacturer's instruction. DNA amplicons with large deletions were TOPO cloned and single colonies were used for Sanger sequencing. EBV load was measured with Taqman digital PCR on Fluidigm BioMark. A Taqman assay targeting a conserved human locus was used for human DNA normalization. 1 ng of single-cell whole-genome amplification products from Fluidigm C1 were used for EBV quantitative PCR.

**[0154]** We further demonstrated that it is possible to delete regions between unique targets (FIG. 2C). Six days after sgEBV4-5 transfection, PCR amplification of the whole flanking region (with primers EBV4F and 5R) returned a shorter amplicon, together with a much fainter band of the expected 2 kb (FIG. 2D). Sanger sequencing of amplicon clones confirmed the direct connection of the two expected cutting sites (FIG. 2F). A similar experiment with sgEBV3-5 also returned an even larger deletion, from EBNA3C to EBNA1 (FIG. 2D-E).

**[0155]** Cell Proliferation Arrest With EBV Genome Destruction. Two days after CRISPR transfection, we flow sorted EGFP-positive cells for further culture and counted the live cells daily. As expected, cells treated with Cas9 plasmids which lacked oriP or sgEBV lost EGFP expression within a few days and proliferated with a rate similar to the untreated control group (FIG. 3A). Plasmids with Cas9-oriP and a scrambled guide RNA maintained EGFP expression after 8 days, but did not reduce the cell proliferation rate. Treatment with the mixed cocktail sgEBV1-7 resulted in no measurable cell proliferation and the total cell count either remained constant or decreased (FIG. 3A). Flow cytometry scattering signals clearly revealed alterations in

the cell morphology after sgEBV1-7 treatment, as the majority of the cells shrank in size with increasing granulation (FIG. 3B-D, population P4 to P3 shift). Cells in population P3 also demonstrated compromised membrane permeability by DAPI staining (FIG. 3E-G). To rule out the possibility of CRISPR cytotoxicity, especially with multiple guide RNAs, we performed the same treatment on two other samples: the EBV-negative Burkitt's lymphoma cell line DG-75 (FIG. 6) and primary human lung fibroblast IMR90 (FIG. 7). Eight and nine days after transfection the cell proliferation rates did not change from the untreated control groups, suggesting neglectable cytotoxicity.

**[0156]** Previous studies have attributed the EBV tumorigenic ability to its interruption of host cell apoptosis (Ruf I K et al. (1999) Epstein-Barr Virus Regulates c-MYC, Apoptosis, and Tumorigenicity in Burkitt Lymphoma. *Molecular and Cellular Biology* 19:1651-1660). Suppressing EBV activities may therefore restore the apoptosis process, which could explain the cell death observed in our experiment. Annexin V staining revealed a distinct subpopulation of cells with intact cell membrane but exposed phosphatidylserine, suggesting cell death through apoptosis (FIG. 3E-G). Bright field microscopy showed obvious apoptotic cell morphology (FIG. 3H-I) and fluorescent staining demonstrated drastic DNA fragmentation (FIG. 3J-M). Altogether this evidence suggests restoration of the normal host cell apoptosis pathway after EBV genome destruction.

**[0157]** Complete Clearance Of EBV In A Subpopulation. To study the potential connection between cell proliferation arrest and EBV genome editing, we quantified the EBV load in different samples with digital PCR targeting EBNA1. Another Taqman assay targeting a conserved human somatic locus served as the internal control for human DNA normalization. On average, each untreated Raji cell has 42 copies of EBV genome (FIG. 4A). Cells treated with a Cas9 plasmid that lacked oriP or sgEBV did not have an obvious difference in EBV load difference from the untreated control. Cells treated with a Cas9-plasmid with oriP but no sgEBV had an EBV load that was reduced by ~50%. In conjunction with the prior observation that cells from this experiment did not show any difference in proliferation rate, we interpret this as likely due to competition for EBNA1 binding during plasmid replication. The addition of the guide RNA cocktail sgEBV1-7 to the transfection dramatically reduced the EBV load. Both the live and dead cells have >60% EBV decrease comparing to the untreated control.

**[0158]** Although we provided seven guide RNAs at the same molar ratio, the plasmid transfection and replication process is likely quite stochastic. Some cells will inevitably receive different subsets or mixtures of the guide RNA cocktail, which might affect the treatment efficiency. To control for such effects, we measured EBV load at the single cell level by employing single-cell whole-genome amplification with an automated microfluidic system. We loaded freshly cultured Raji cells onto the microfluidic chip and captured 81 single cells (FIG. 4B). For the sgEBV1-7 treated cells, we flow sorted the live cells eight days after transfection and captured 91 single cells (FIG. 4C). Following manufacturer's instruction, we obtained ~150 ng amplified DNA from each single cell reaction chamber. For quality control purposes we performed 4-loci human somatic DNA quantitative PCR on each single cell amplification product (Wang J, Fan H C, Behr B, Quake S R (2012) Genome-wide

single-cell analysis of recombination activity and de novo mutation rates in human sperm. Cell 150:402-412) and required positive amplification from at least one locus. 69 untreated single-cell products passed the quality control and displayed a log-normal distribution of EBV load (FIG. 4D) with almost every cell displaying significant amounts of EBV genomic DNA. We calibrated the quantitative PCR assay with a subclone of Namalwa Burkitt's lymphoma cells, which contain a single integrated EBV genome. The single-copy EBV measurements gave a Ct of 29.8, which enabled us to determine that the mean Ct of the 69 Raji single cell samples corresponded to 42 EBV copies per cells, in concordance with the bulk digital PCR measurement. For the sgEBV1-7 treated sample, 71 single-cell products passed the quality control and the EBV load distribution was dramatically wider (FIG. 4E). While 22 cells had the same EBV load as the untreated cells, 19 cells had no detectable EBV and the remaining 30 cells displayed dramatic EBV load decrease from the untreated sample.

**[0159]** Essential Targets For EBV Treatment. The seven guide RNAs in our CRISPR cocktail target three different categories of sequences which are important for EBV genome structure, host cell transformation, and infection latency, respectively. To understand the most essential targets for effective EBV treatment, we transfected Raji cells with subsets of guide RNAs. Although sgEBV4/5 reduced the EBV genome by 85%, they could not suppress cell proliferation as effectively as the full cocktail (FIG. 3A). Guide RNAs targeting the structural sequences (sgEBV1/2/6) could stop cell proliferation completely, despite not eliminating the full EBV load (26% decrease). Given the high efficiency of genome editing and the proliferation arrest (FIG. 2), we suspect that the residual EBV genome signature in sgEBV1/2/6 was not due to intact genomes but to free-

floating DNA that has been digested out of the EBV genome, i.e. as a false positive. We conclude that systematic destruction of EBV genome structure appears to be more effective than targeting specific key proteins for EBV treatment.

**[0160]** FIGS. 10 and 8 show seven CRISPR guide RNAs designed to target the EBV genome. Pre-packaged GFP-Cas9 adenovirus (Ad-GFP-Cas9) was purchased from Vector Biolabs. Three different EBV-targeting guide RNA sequences (sgEBV3/4/5) were packaged into three adenovirus lines respectively, all with mCherry reporter. EBV-positive Raji cells transduced with GFP-Cas9 and mCherry-sgEBV3/4/5 adenoviruses demonstrated the CRISPR-specific apoptosis (FIG. 11) and large DNA deletions as the EBV genome was ablated (FIG. 12) in only the GFP-mCherry double-positive subpopulation.

#### INCORPORATION BY REFERENCE

**[0161]** References and citations to other documents, such as patents, patent applications, patent publications, journals, books, papers, web contents, have been made throughout this disclosure. All such documents are hereby incorporated herein by reference in their entirety for all purposes.

#### Equivalents

**[0162]** Various modifications of the invention and many further embodiments thereof, in addition to those shown and described herein, will become apparent to those skilled in the art from the full contents of this document, including references to the scientific and patent literature cited herein. The subject matter herein contains important information, exemplification and guidance that can be adapted to the practice of this invention in its various embodiments and equivalents thereof.

---

#### SEQUENCE LISTING

<160> NUMBER OF SEQ ID NOS: 24

<210> SEQ ID NO 1

<211> LENGTH: 20

<212> TYPE: DNA

<213> ORGANISM: Artificial Sequence

<220> FEATURE:

<223> OTHER INFORMATION: Synthetic sgEBV1 guide RNA targeting Sequence

<400> SEQUENCE: 1

gccctggacc aaccggccc

20

<210> SEQ ID NO 2

<211> LENGTH: 20

<212> TYPE: DNA

<213> ORGANISM: Artificial Sequence

<220> FEATURE:

<223> OTHER INFORMATION: Synthetic sgEBV2 guide RNA targeting Sequence

<400> SEQUENCE: 2

ggccgctgcc ccgctccggg

20

<210> SEQ ID NO 3

<211> LENGTH: 19

<212> TYPE: DNA

<213> ORGANISM: Artificial Sequence

<220> FEATURE:

<223> OTHER INFORMATION: Synthetic sgEBV3 guide RNA targeting Sequence

---

-continued

---

<400> SEQUENCE: 3

ggaagacaat gtgccgcca 19

<210> SEQ ID NO 4

<211> LENGTH: 20

<212> TYPE: DNA

<213> ORGANISM: Artificial Sequence

<220> FEATURE:

<223> OTHER INFORMATION: Synthetic sgEBV4 guide RNA targeting Sequence

<400> SEQUENCE: 4

tctggaccag aaggctccgg 20

<210> SEQ ID NO 5

<211> LENGTH: 20

<212> TYPE: DNA

<213> ORGANISM: Artificial Sequence

<220> FEATURE:

<223> OTHER INFORMATION: Synthetic sgEBV5 guide RNA targeting Sequence

<400> SEQUENCE: 5

gctgccgagg agggatgatga 20

<210> SEQ ID NO 6

<211> LENGTH: 20

<212> TYPE: DNA

<213> ORGANISM: Artificial Sequence

<220> FEATURE:

<223> OTHER INFORMATION: Synthetic sgEBV6 guide RNA targeting Sequence

<400> SEQUENCE: 6

ggtggccac cgggtccgct 20

<210> SEQ ID NO 7

<211> LENGTH: 20

<212> TYPE: DNA

<213> ORGANISM: Artificial Sequence

<220> FEATURE:

<223> OTHER INFORMATION: Synthetic sgEBV7 guide RNA targeting Sequence

<400> SEQUENCE: 7

gtcctcgagg gggccgctgc 20

<210> SEQ ID NO 8

<211> LENGTH: 20

<212> TYPE: DNA

<213> ORGANISM: Artificial Sequence

<220> FEATURE:

<223> OTHER INFORMATION: Synthetic sgEBV1F PCR Primer

<400> SEQUENCE: 8

tgctaggcca cttctcagt 20

<210> SEQ ID NO 9

<211> LENGTH: 20

<212> TYPE: DNA

<213> ORGANISM: Artificial Sequence

<220> FEATURE:

<223> OTHER INFORMATION: Synthetic sgEBV1R PCR Primer

<400> SEQUENCE: 9

gtagtgtgtg cctgggtgtg 20



-continued

---

<210> SEQ ID NO 10  
<211> LENGTH: 20  
<212> TYPE: DNA  
<213> ORGANISM: Artificial Sequence  
<220> FEATURE:  
<223> OTHER INFORMATION: Synthetic sgEBV2F PCR Primer  
  
<400> SEQUENCE: 10  
  
agcatggcga agtagacagg 20  
  
<210> SEQ ID NO 11  
<211> LENGTH: 18  
<212> TYPE: DNA  
<213> ORGANISM: Artificial Sequence  
<220> FEATURE:  
<223> OTHER INFORMATION: Synthetic sgEBV2R PCR Primer  
  
<400> SEQUENCE: 11  
  
gcccattcga accctacc 18  
  
<210> SEQ ID NO 12  
<211> LENGTH: 20  
<212> TYPE: DNA  
<213> ORGANISM: Artificial Sequence  
<220> FEATURE:  
<223> OTHER INFORMATION: Synthetic sgEBV3F PCR Primer  
  
<400> SEQUENCE: 12  
  
tttcagaccc accatggaat 20  
  
<210> SEQ ID NO 13  
<211> LENGTH: 20  
<212> TYPE: DNA  
<213> ORGANISM: Artificial Sequence  
<220> FEATURE:  
<223> OTHER INFORMATION: Synthetic sgEBV3R PCR Primer  
  
<400> SEQUENCE: 13  
  
cccatgaacc cagtttagagg 20  
  
<210> SEQ ID NO 14  
<211> LENGTH: 20  
<212> TYPE: DNA  
<213> ORGANISM: Artificial Sequence  
<220> FEATURE:  
<223> OTHER INFORMATION: Synthetic sgEBV4F PCR Primer  
  
<400> SEQUENCE: 14  
  
ggctgcgagt aattggtgat 20  
  
<210> SEQ ID NO 15  
<211> LENGTH: 21  
<212> TYPE: DNA  
<213> ORGANISM: Artificial Sequence  
<220> FEATURE:  
<223> OTHER INFORMATION: Synthetic sgEBV4R PCR Primer  
  
<400> SEQUENCE: 15  
  
caatgcaact tggacgtttt t 21  
  
<210> SEQ ID NO 16  
<211> LENGTH: 20

-continued

---

<212> TYPE: DNA  
 <213> ORGANISM: Artificial Sequence  
 <220> FEATURE:  
 <223> OTHER INFORMATION: Synthetic sgEBVSF PCR Primer  
  
 <400> SEQUENCE: 16  
  
 gctgaggttt tgaaggatgc 20

<210> SEQ ID NO 17  
 <211> LENGTH: 20  
 <212> TYPE: DNA  
 <213> ORGANISM: Artificial Sequence  
 <220> FEATURE:  
 <223> OTHER INFORMATION: Synthetic sgEBVSR PCR Primer  
  
 <400> SEQUENCE: 17  
  
 ggagctgagt gacgtgacaa 20

<210> SEQ ID NO 18  
 <211> LENGTH: 20  
 <212> TYPE: DNA  
 <213> ORGANISM: Artificial Sequence  
 <220> FEATURE:  
 <223> OTHER INFORMATION: Synthetic sgEBV7F PCR Primer  
  
 <400> SEQUENCE: 18  
  
 agtaagggaa agggggtgtg 20

<210> SEQ ID NO 19  
 <211> LENGTH: 20  
 <212> TYPE: DNA  
 <213> ORGANISM: Artificial Sequence  
 <220> FEATURE:  
 <223> OTHER INFORMATION: Synthtic sgEBV7R PCR Primer  
  
 <400> SEQUENCE: 19  
  
 gacgtagccg ccctacataa 20

<210> SEQ ID NO 20  
 <211> LENGTH: 20  
 <212> TYPE: DNA  
 <213> ORGANISM: Artificial Sequence  
 <220> FEATURE:  
 <223> OTHER INFORMATION: Synthetic oriP\_F PCR Primer  
  
 <400> SEQUENCE: 20  
  
 ccaccaattc caaccatttt 20

<210> SEQ ID NO 21  
 <211> LENGTH: 15  
 <212> TYPE: DNA  
 <213> ORGANISM: Artificial Sequence  
 <220> FEATURE:  
 <223> OTHER INFORMATION: Synthetic oriP\_R PCR Primer  
  
 <400> SEQUENCE: 21  
  
 cgcggggcag tgcatt 15

<210> SEQ ID NO 22  
 <211> LENGTH: 20  
 <212> TYPE: DNA  
 <213> ORGANISM: Artificial Sequence  
 <220> FEATURE:  
 <223> OTHER INFORMATION: Synthtic EBNA1\_qF PCR Primer

-continued

---

<400> SEQUENCE: 22

cctccctggt ttccacctat 20

<210> SEQ ID NO 23

<211> LENGTH: 20

<212> TYPE: DNA

<213> ORGANISM: Artificial Sequence

<220> FEATURE:

<223> OTHER INFORMATION: Synthetic EBNA1\_qR PCR Primer

<400> SEQUENCE: 23

cctccttcat ctccgtcatc 20

<210> SEQ ID NO 24

<211> LENGTH: 18

<212> TYPE: DNA

<213> ORGANISM: Artificial Sequence

<220> FEATURE:

<223> OTHER INFORMATION: Synthetic EBNA1\_qP PCR Primer

<400> SEQUENCE: 24

tccgtcatca ccctccgc 18

---

1. A composition comprising guide RNAs for use in the treatment of latent viruses within a cell.

2-11. (canceled)

\* \* \* \* \*