



US 20130099011A1

(19) **United States**

(12) **Patent Application Publication**  
**MATSUOKA et al.**

(10) **Pub. No.: US 2013/0099011 A1**

(43) **Pub. Date: Apr. 25, 2013**

(54) **ENERGY EFFICIENCY PROMOTING  
SCHEDULE LEARNING ALGORITHMS FOR  
INTELLIGENT THERMOSTAT**

**Publication Classification**

(51) **Int. Cl.**  
**G05D 23/19** (2006.01)

(71) Applicant: **NEST LABS, INC.**, Palo Alto, CA (US)

(52) **U.S. Cl.**  
USPC ..... **236/1 C; 236/46 C; 165/11.1**

(72) Inventors: **Yoky MATSUOKA**, Palo Alto, CA (US); **Frank E. ASTIER**, Mountain View, CA (US); **Rangoli SHARAN**, Sunnyvale, CA (US); **David SLOO**, Menlo Park, CA (US); **Anthony Michael FADELL**, Portola Valley, CA (US)

(57) **ABSTRACT**

A user-friendly programmable thermostat is described that includes receiving an immediate-control input to change set point temperature, controlling temperature according to the set point temperature for a predetermined time interval, and then automatically resetting the set point temperature upon the ending of the predetermined time interval such that the user is urged to make further immediate-control inputs. A schedule for the programmable thermostat is automatically generated based on the immediate-control inputs. Methods are also described for receiving user input relating to the user's preference regarding automatically generating a schedule, and determining whether or not to automatically adopt an automatically generated schedule based on the received user input.

(73) Assignee: **NEST LABS, INC.**, Palo Alto, CA (US)

(21) Appl. No.: **13/656,200**

(22) Filed: **Oct. 19, 2012**

**Related U.S. Application Data**

(60) Provisional application No. 61/550,345, filed on Oct. 21, 2011.

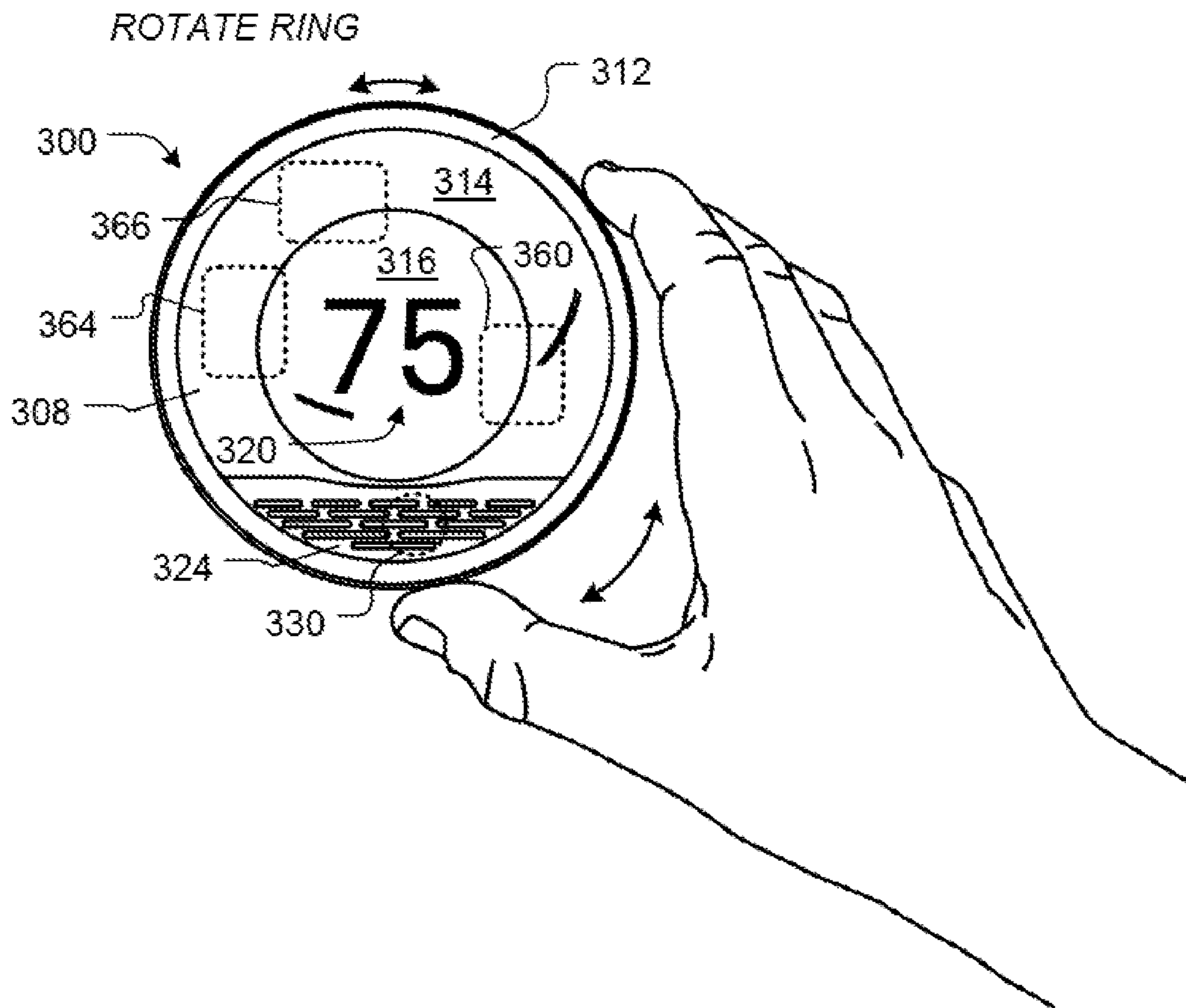

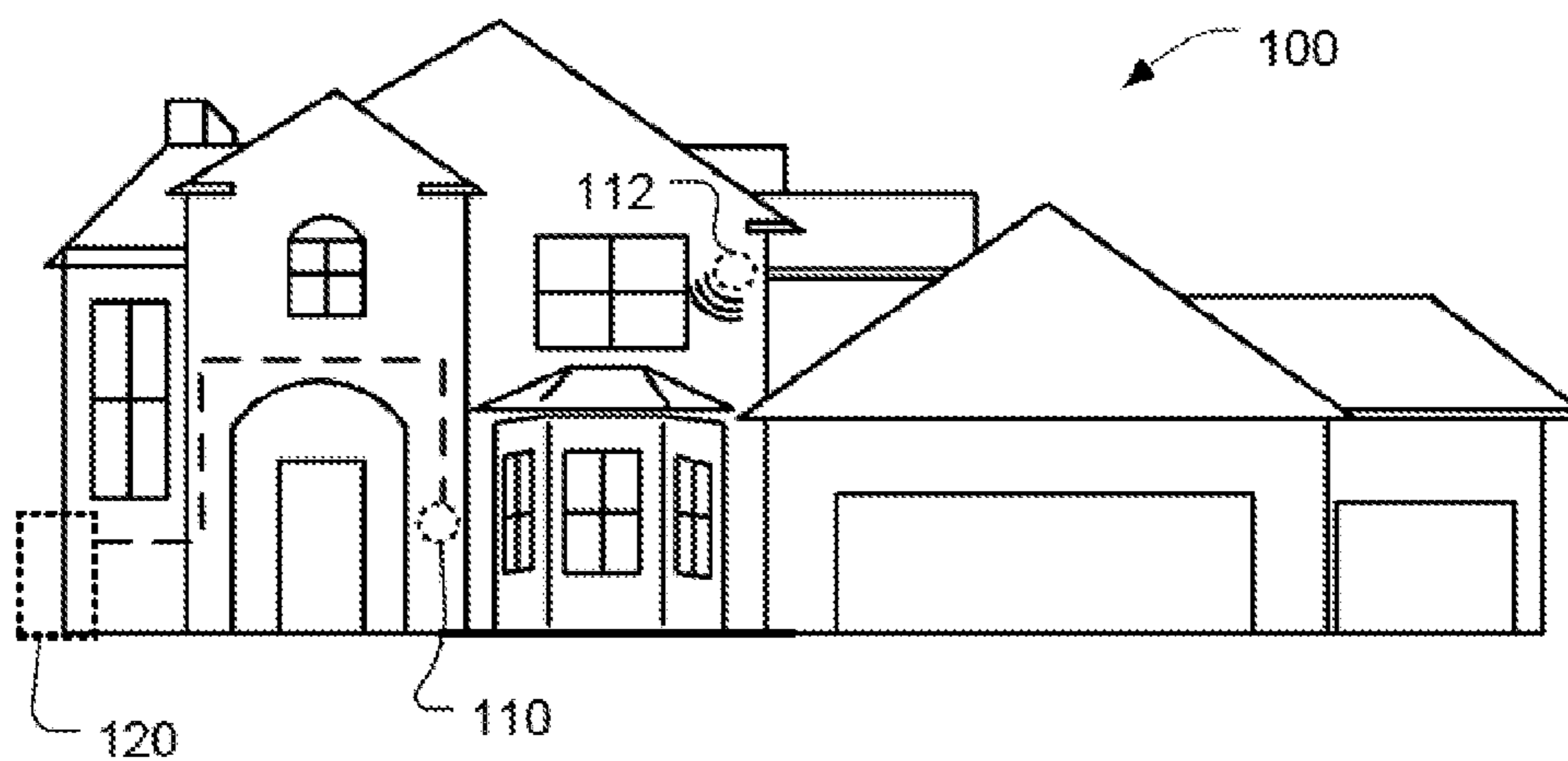

FIG. 1

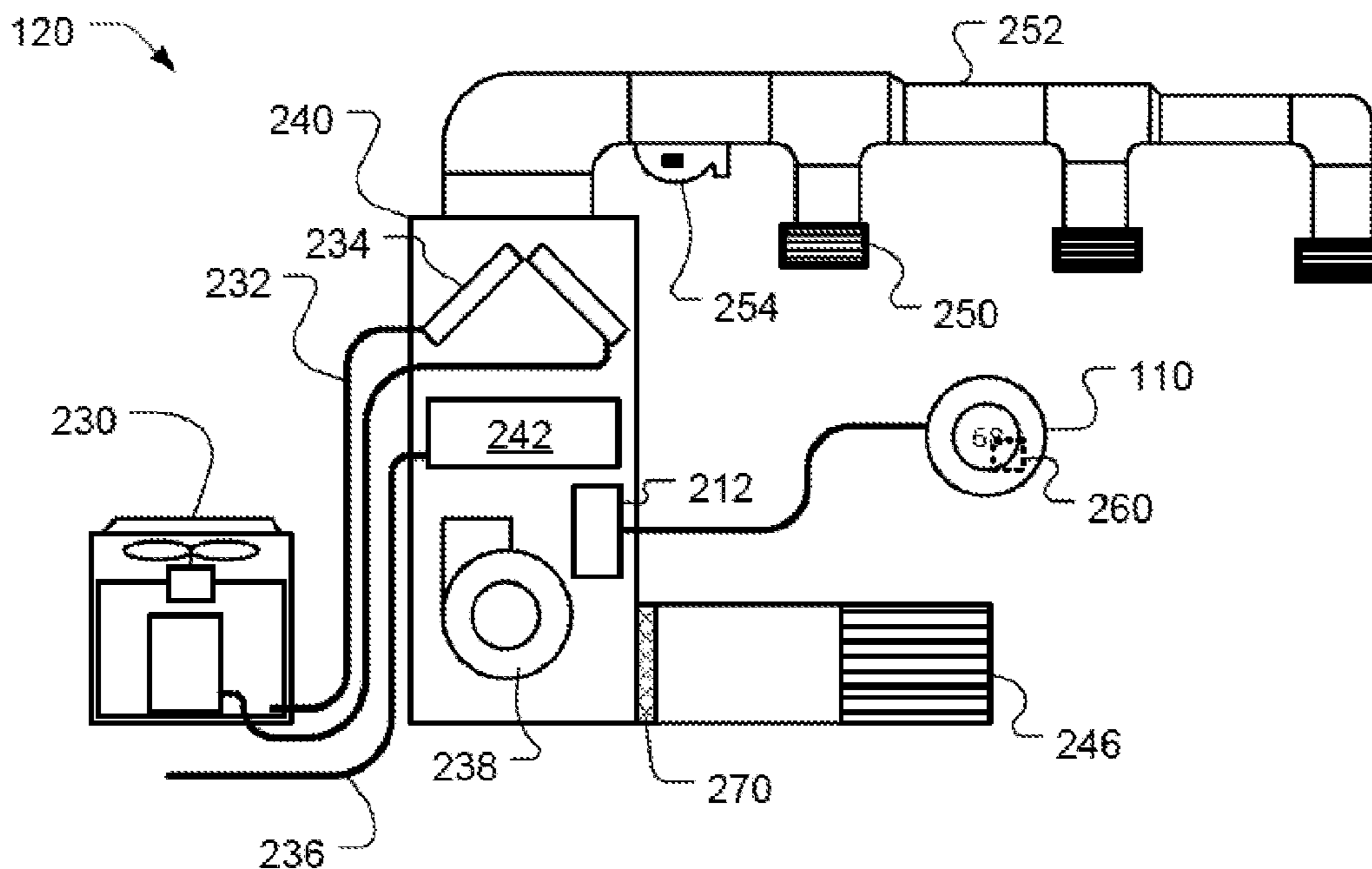

FIG. 2

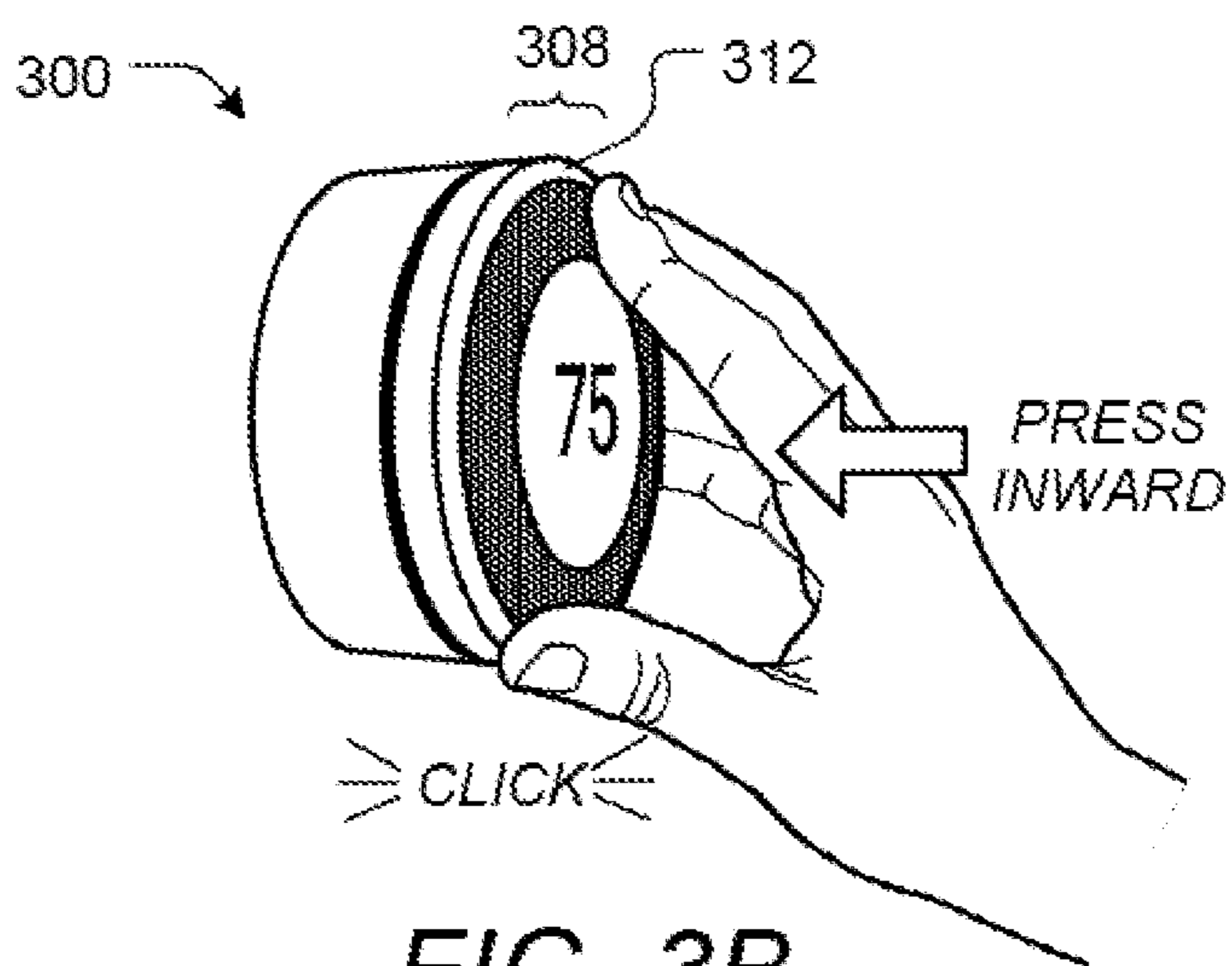
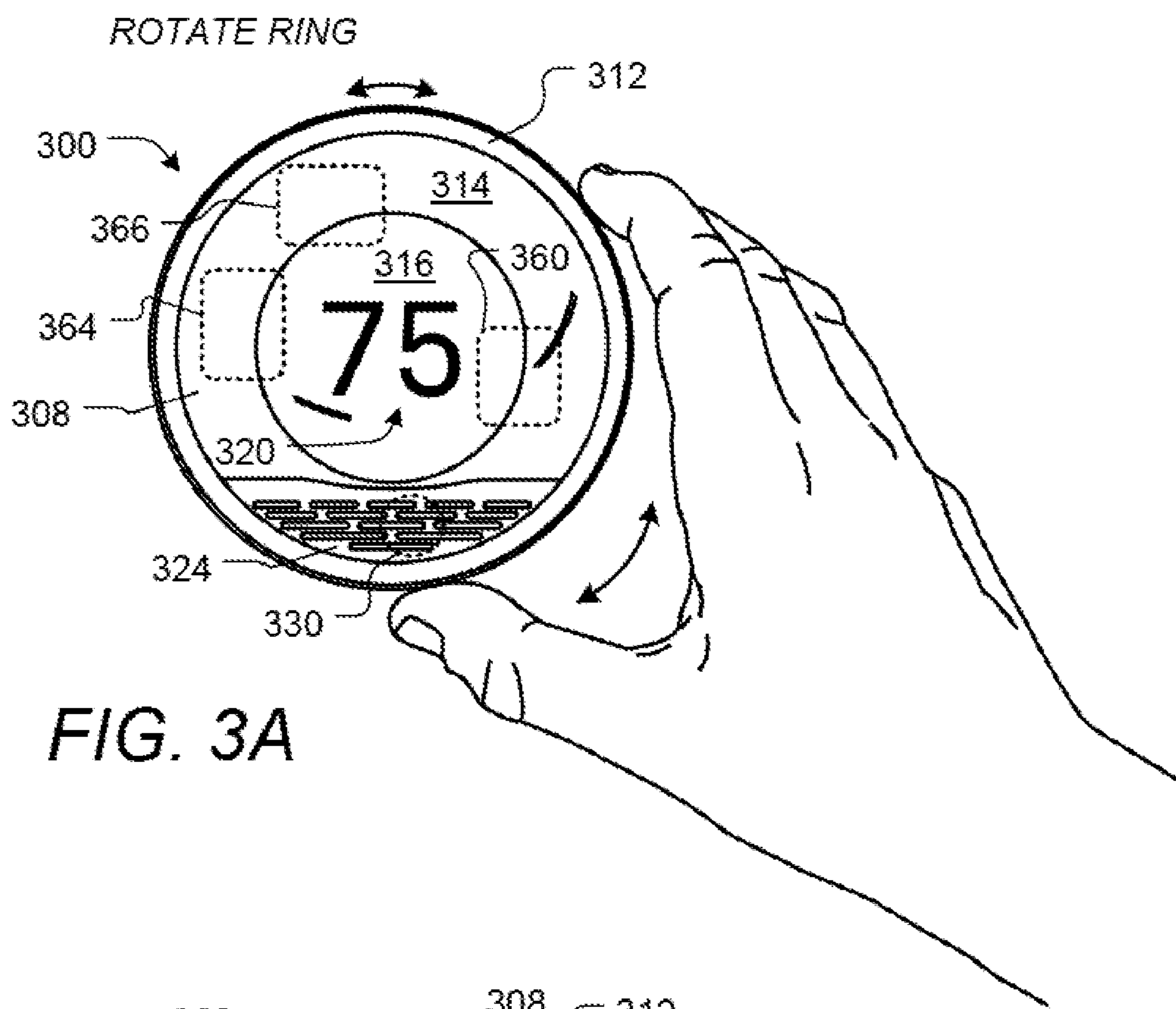

FIG. 4A

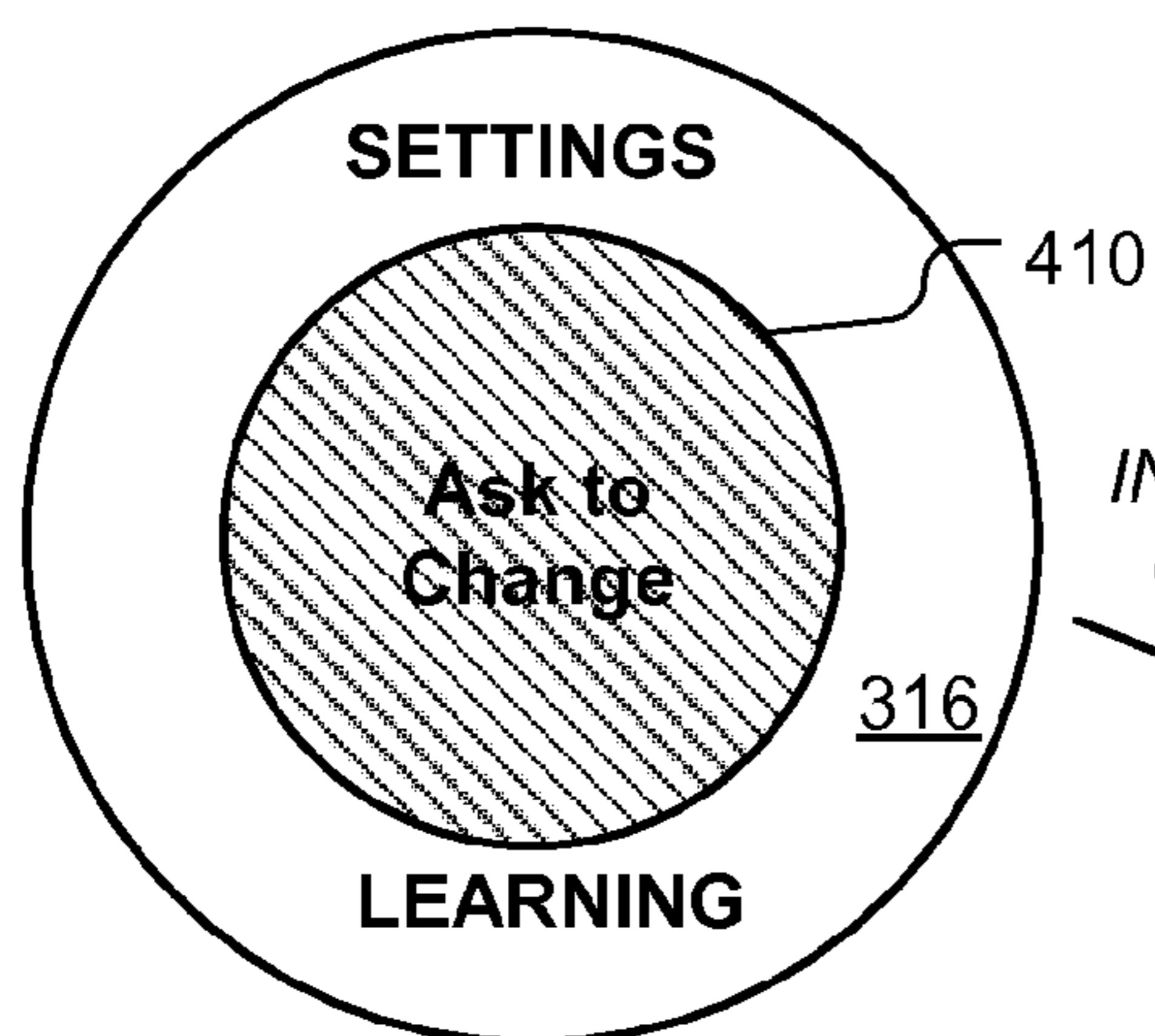

FIG. 4B

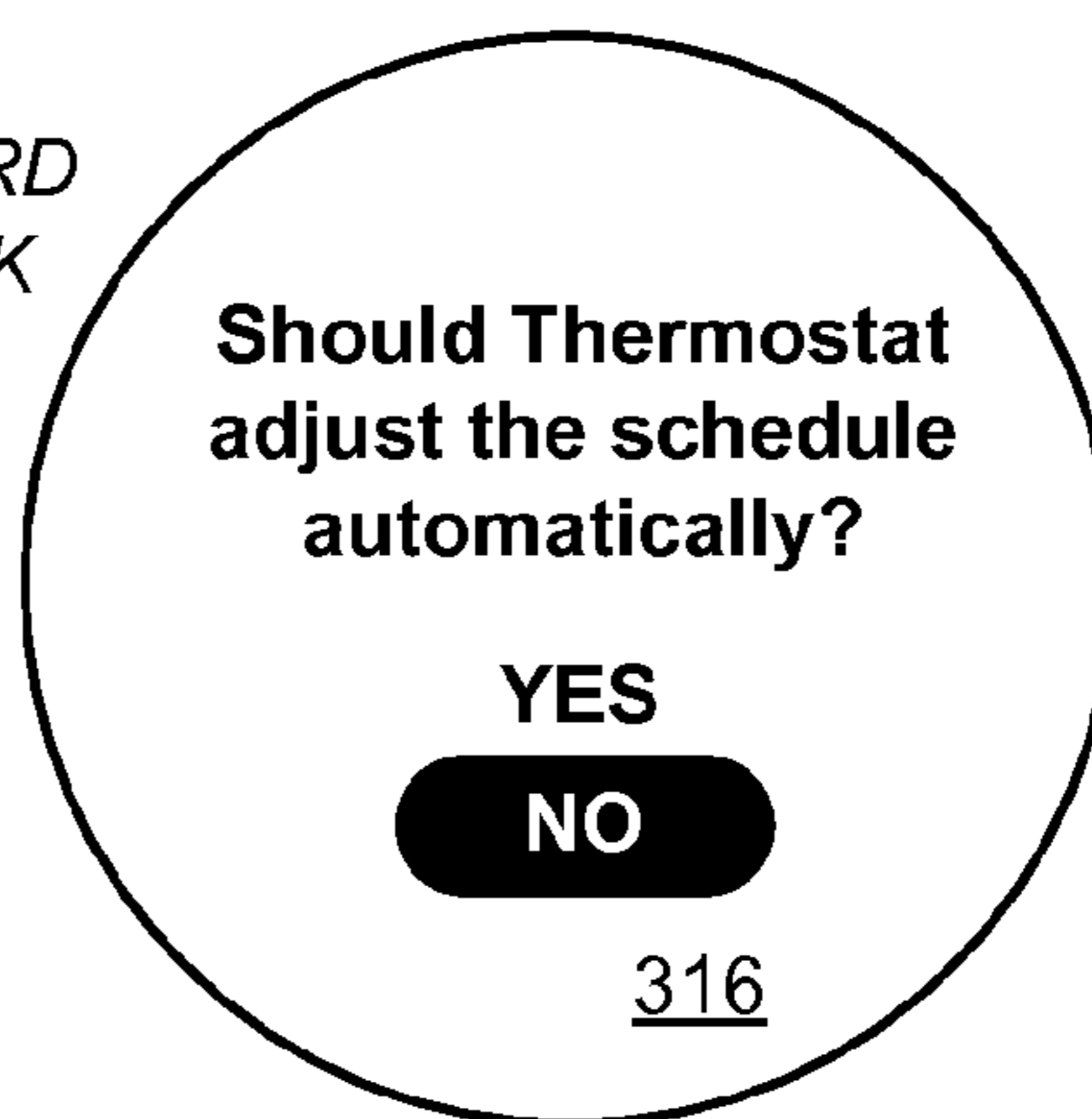
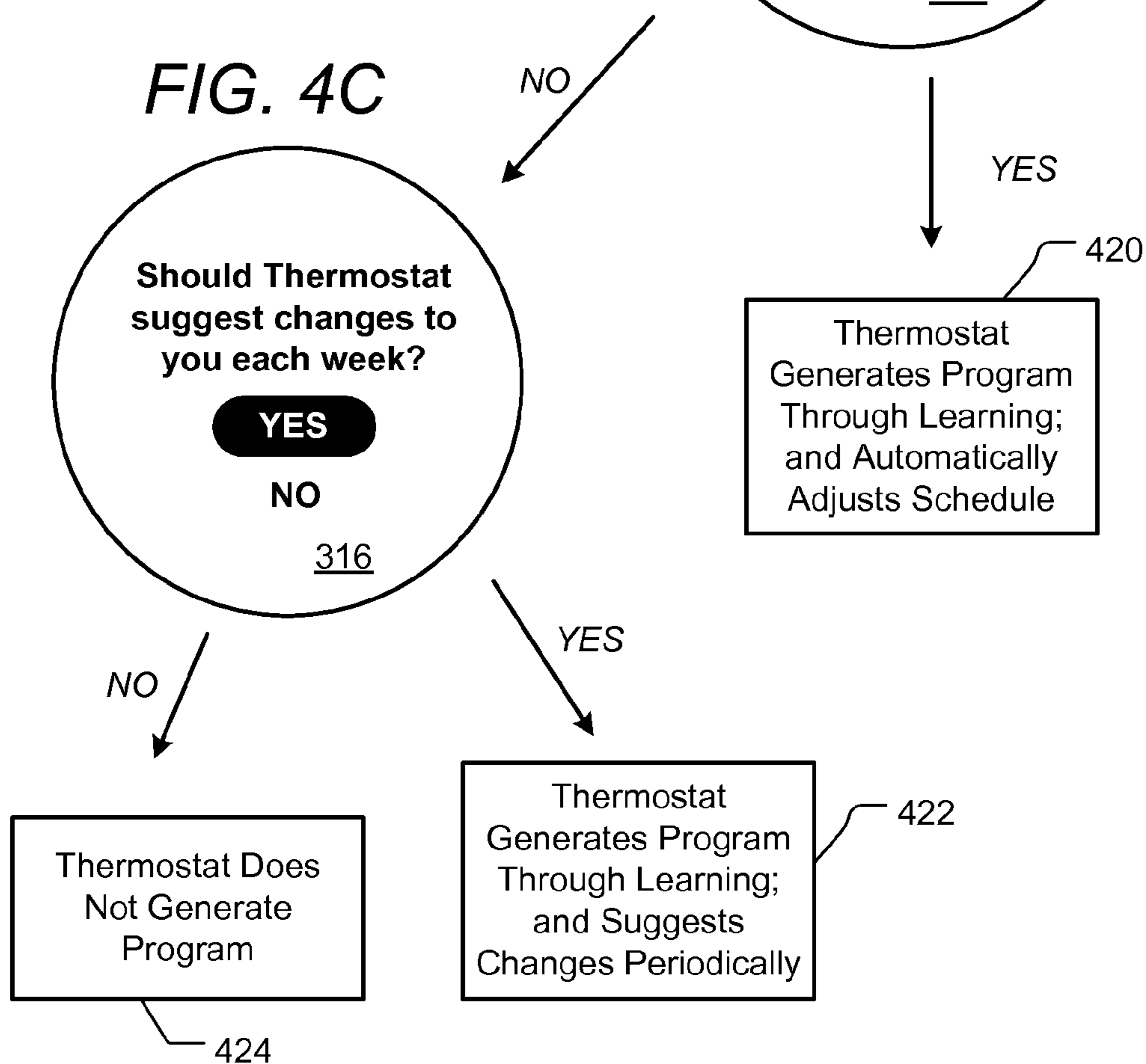

FIG. 4C



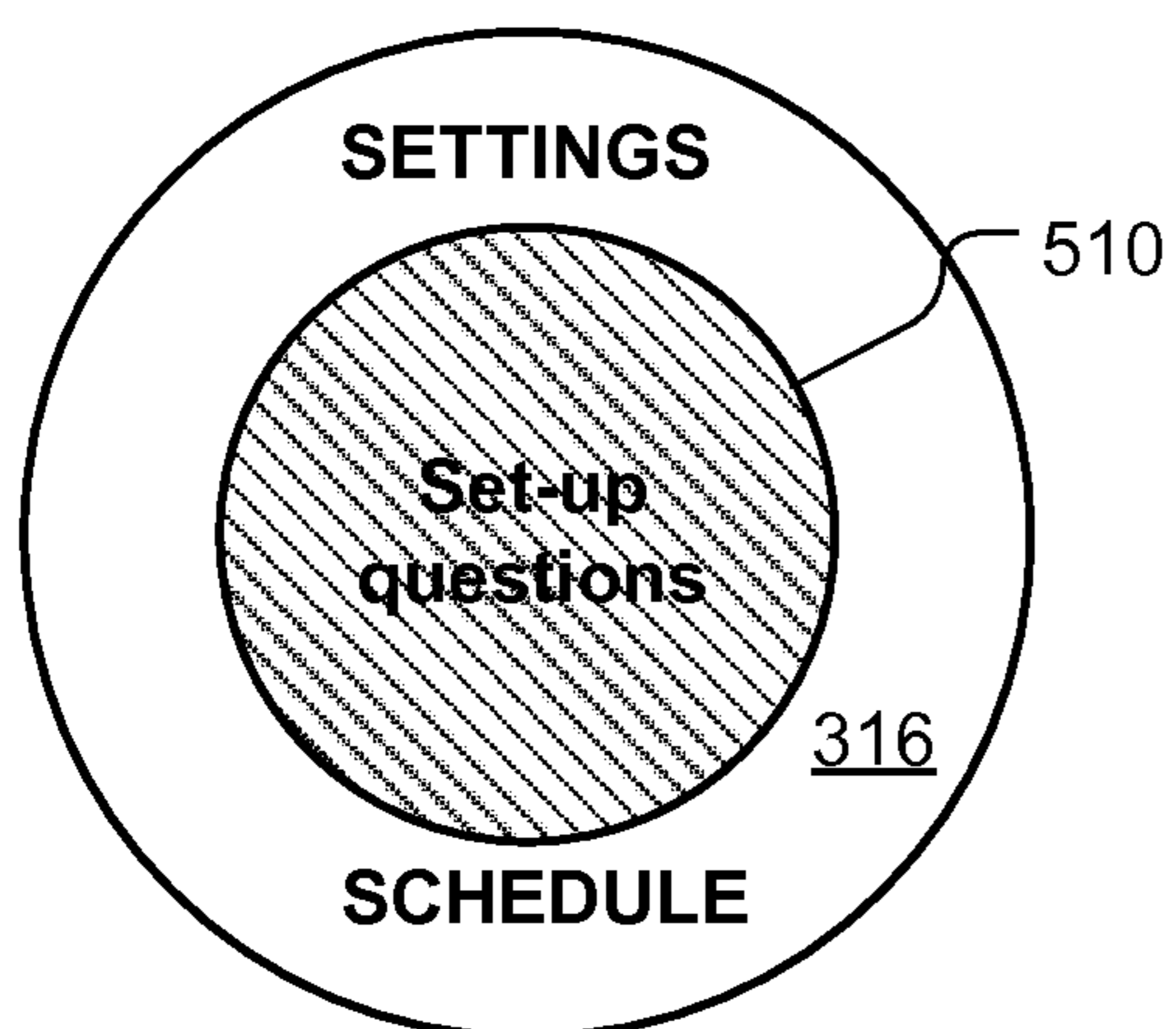

FIG. 5A

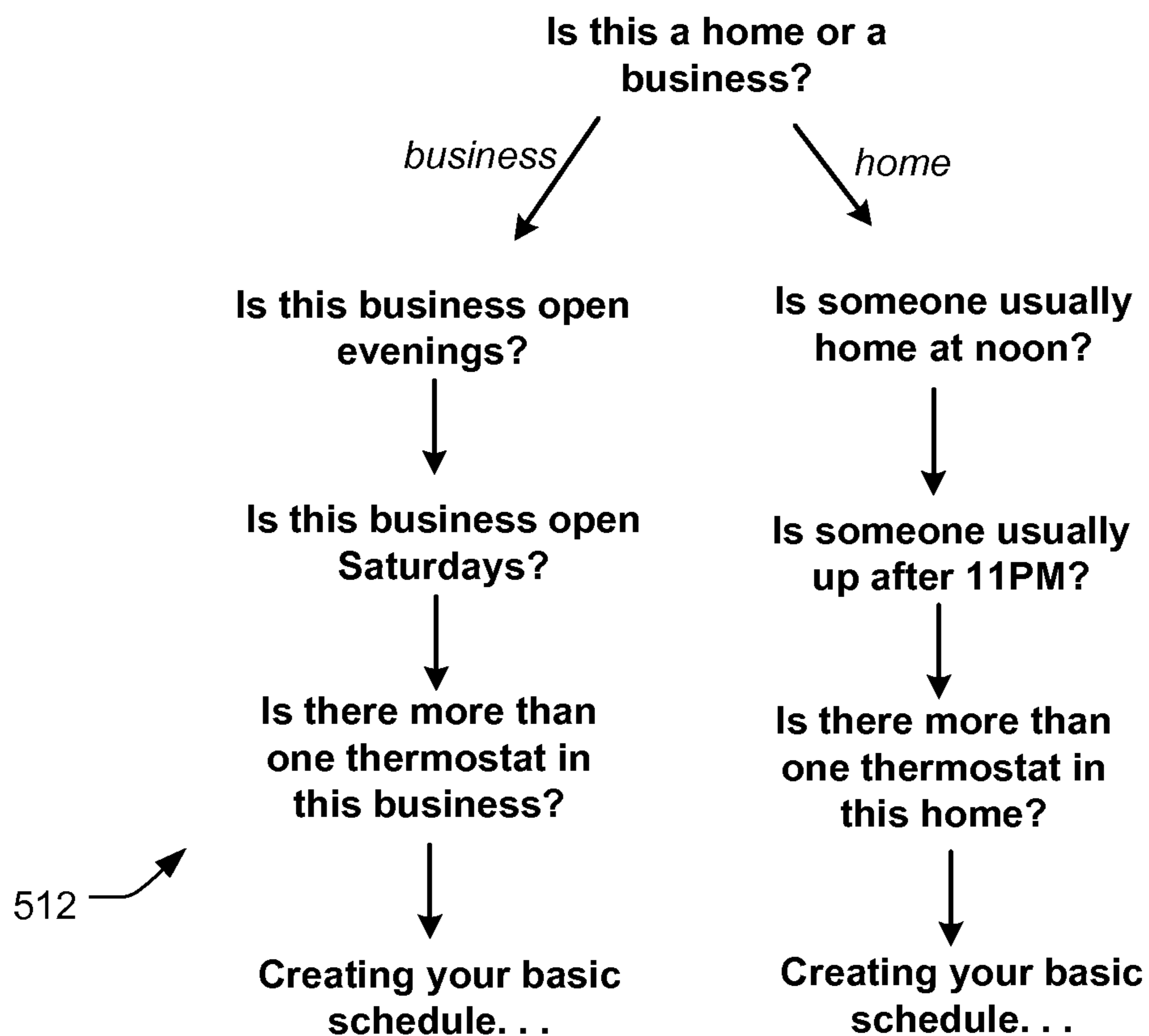
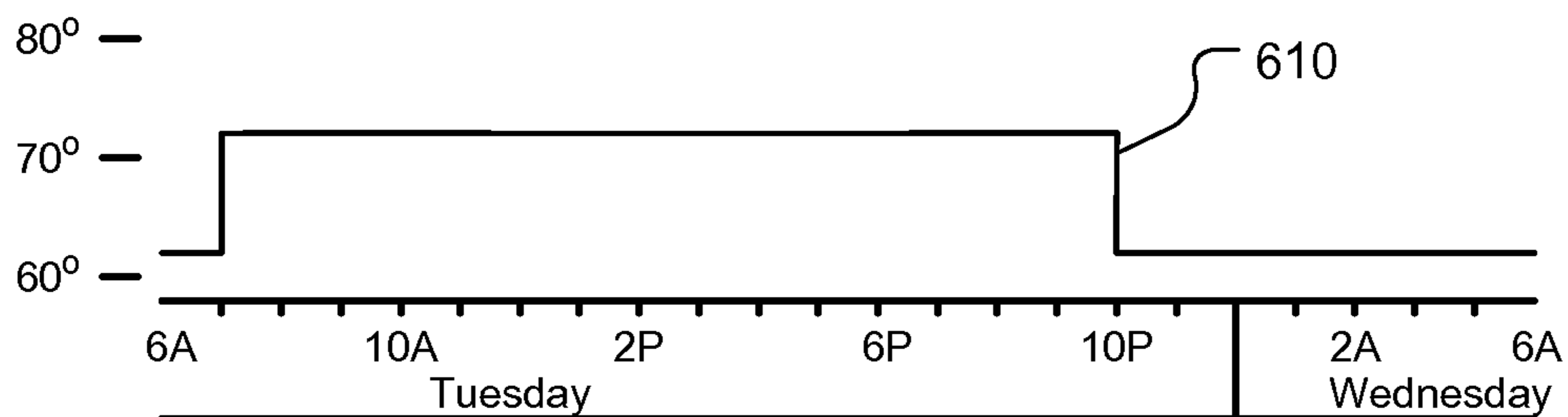
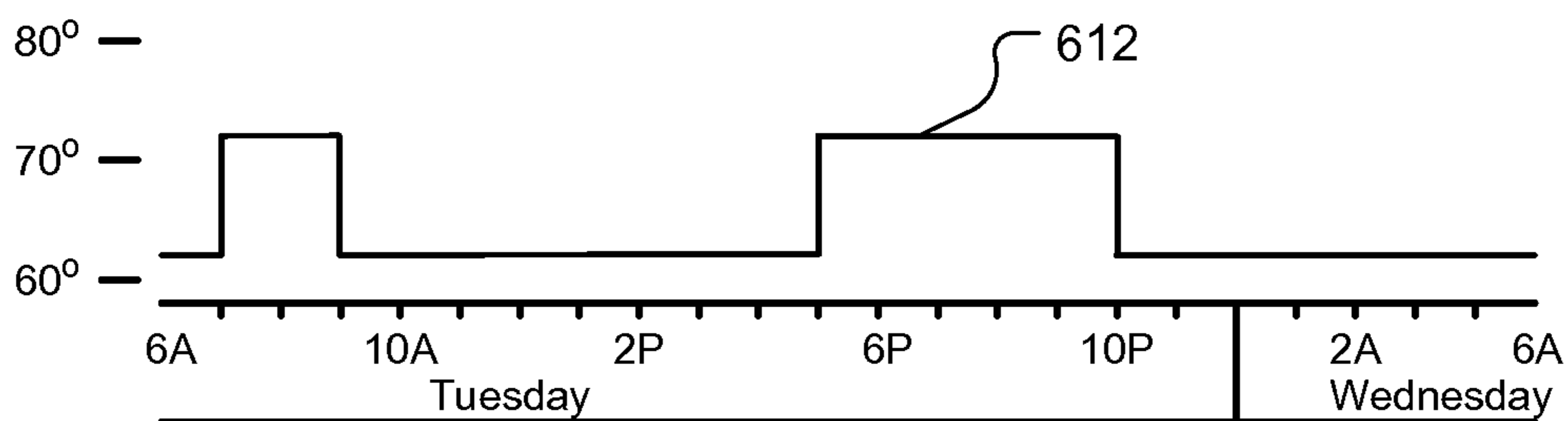

FIG. 5B



*FIG. 6A*



*FIG. 6B*

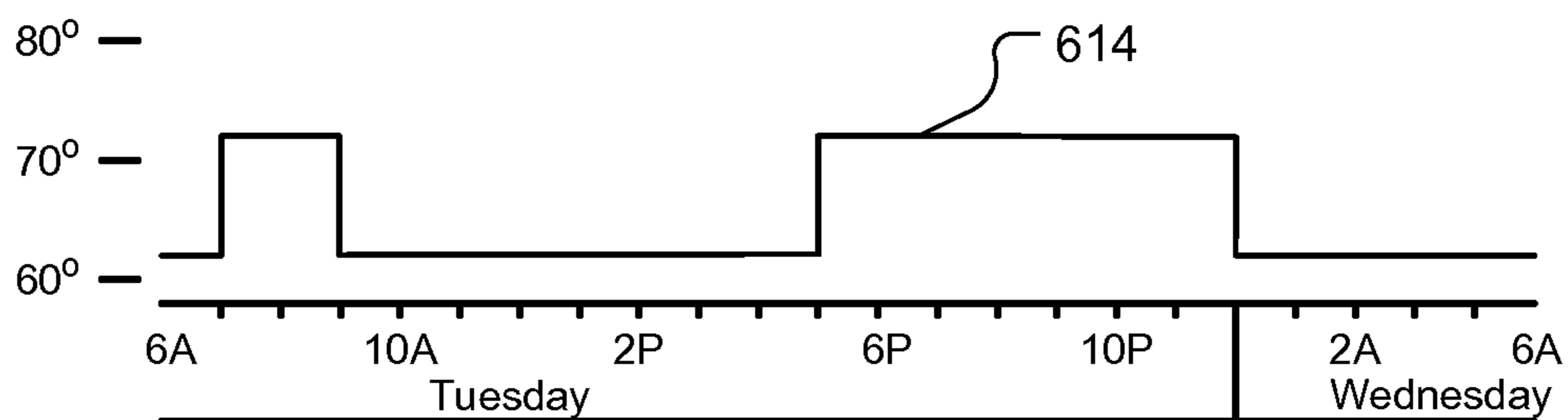

*FIG. 6C*

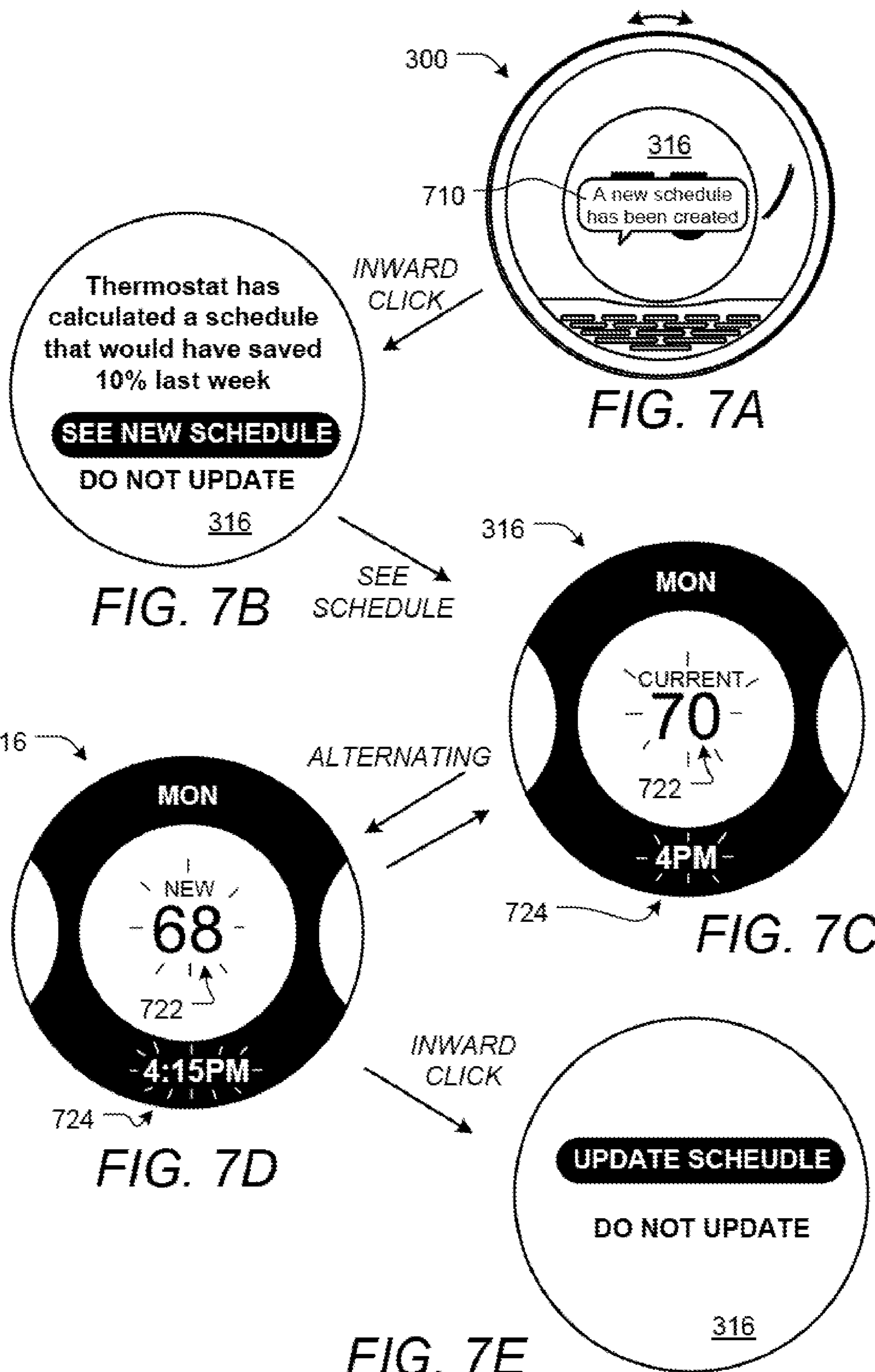

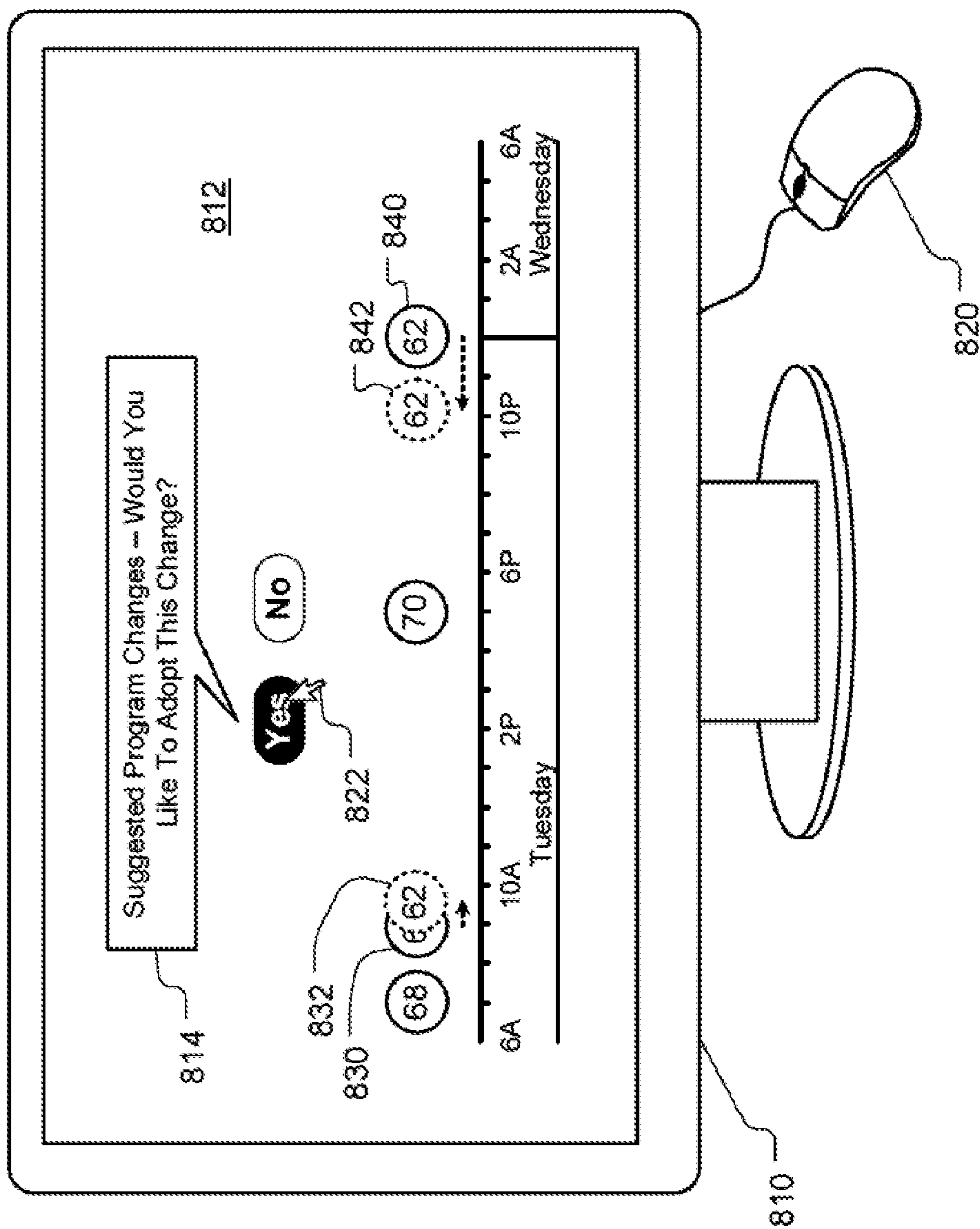

FIG. 8



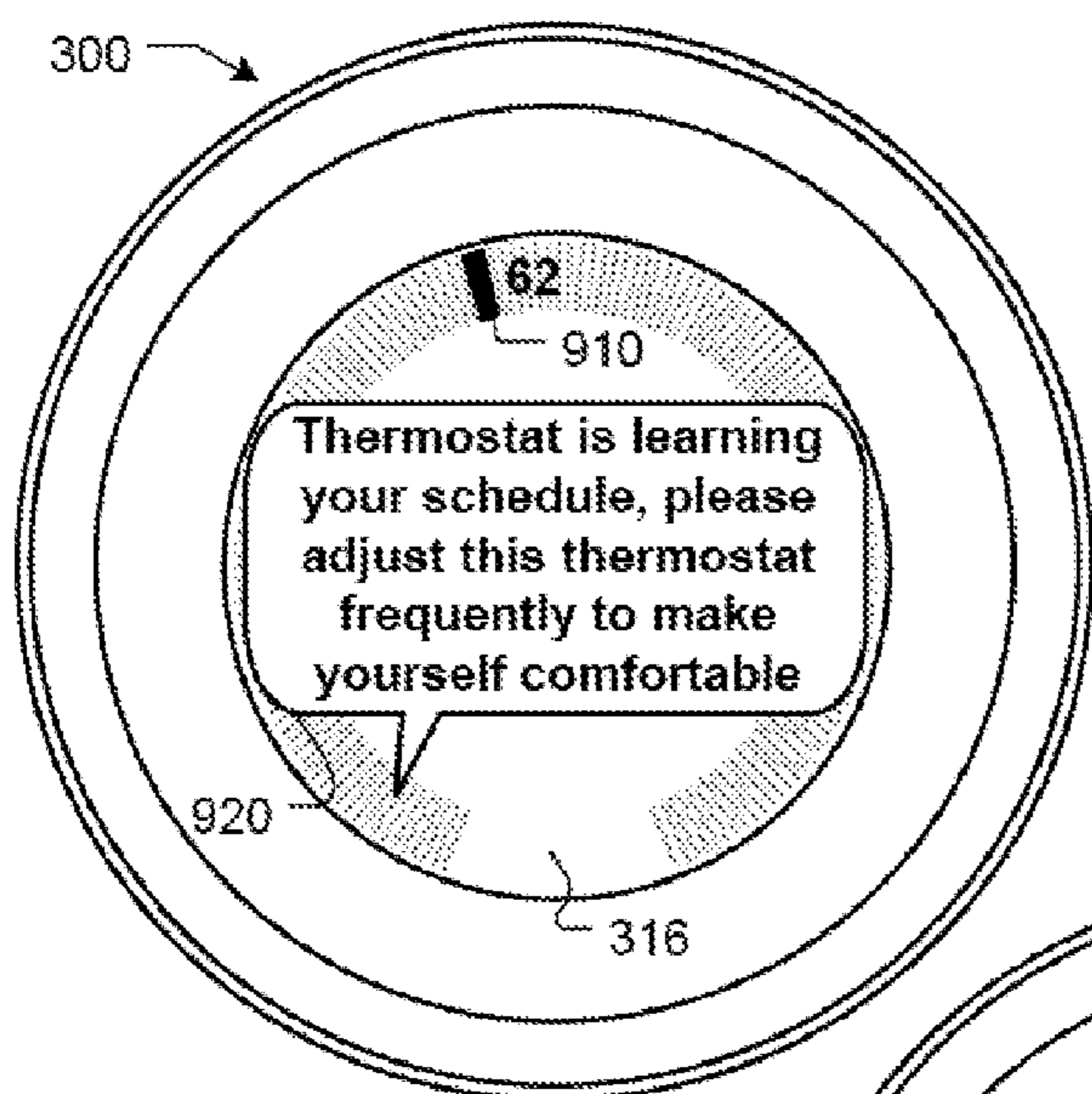

FIG. 9A

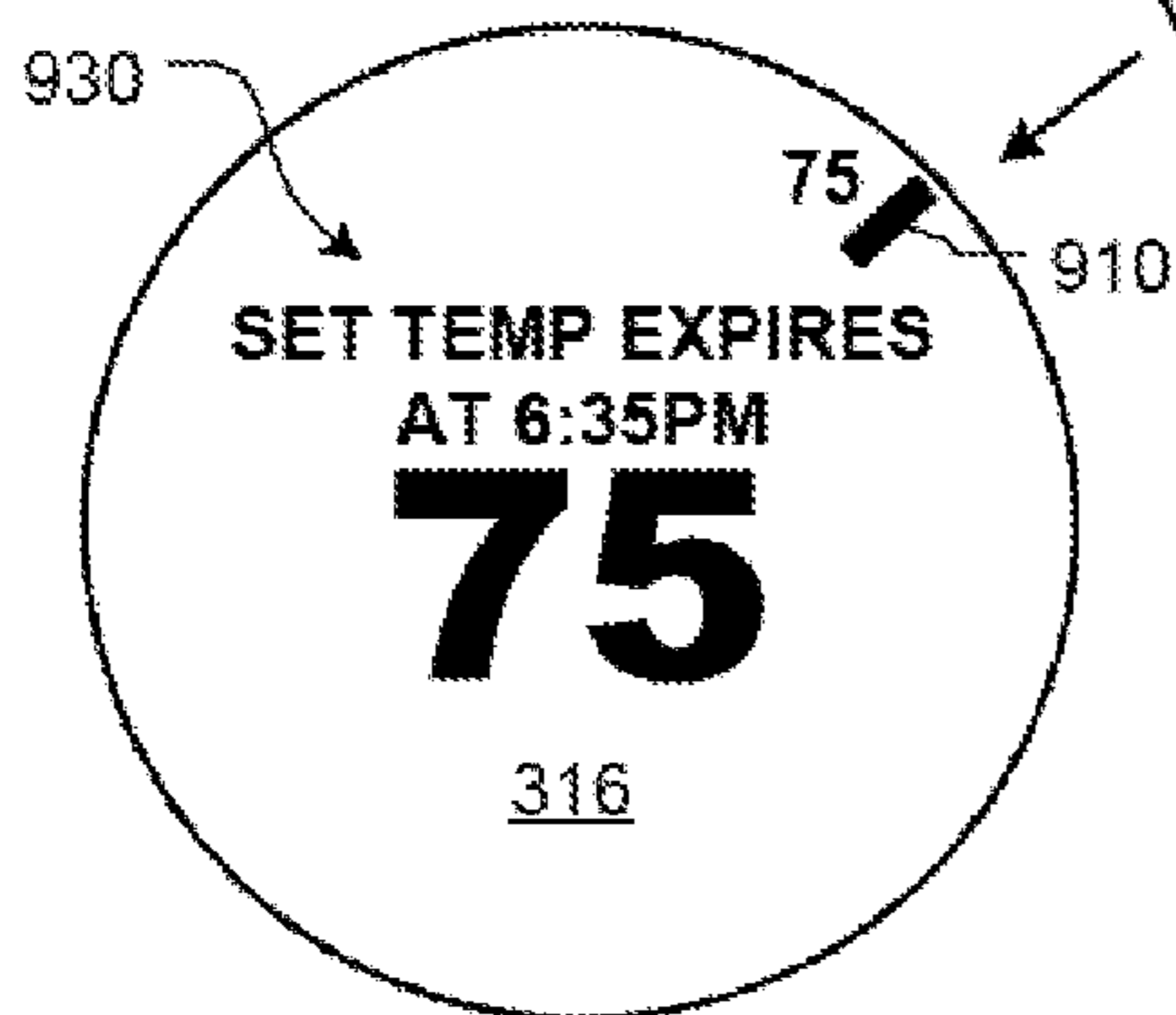
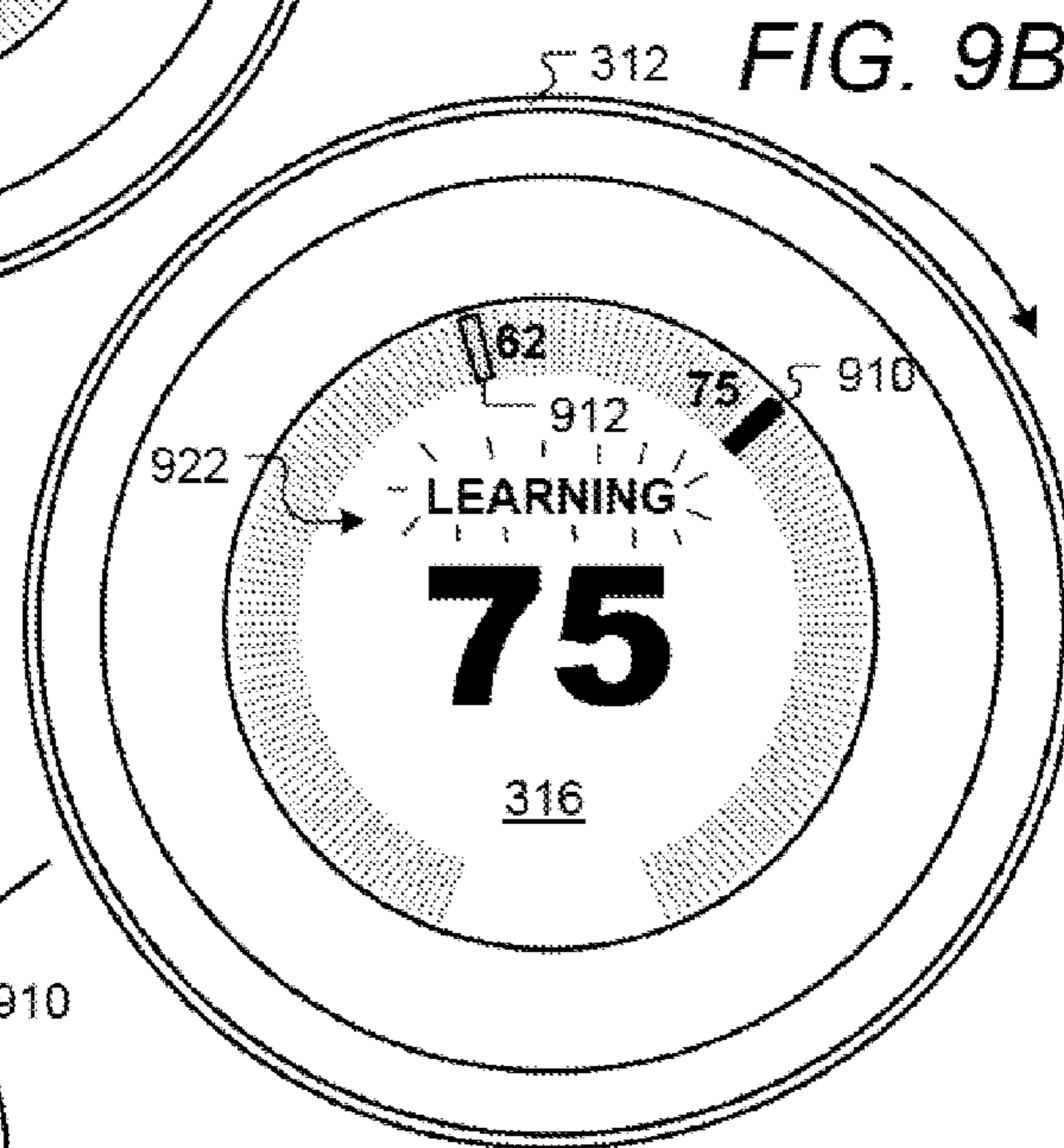

FIG. 9C

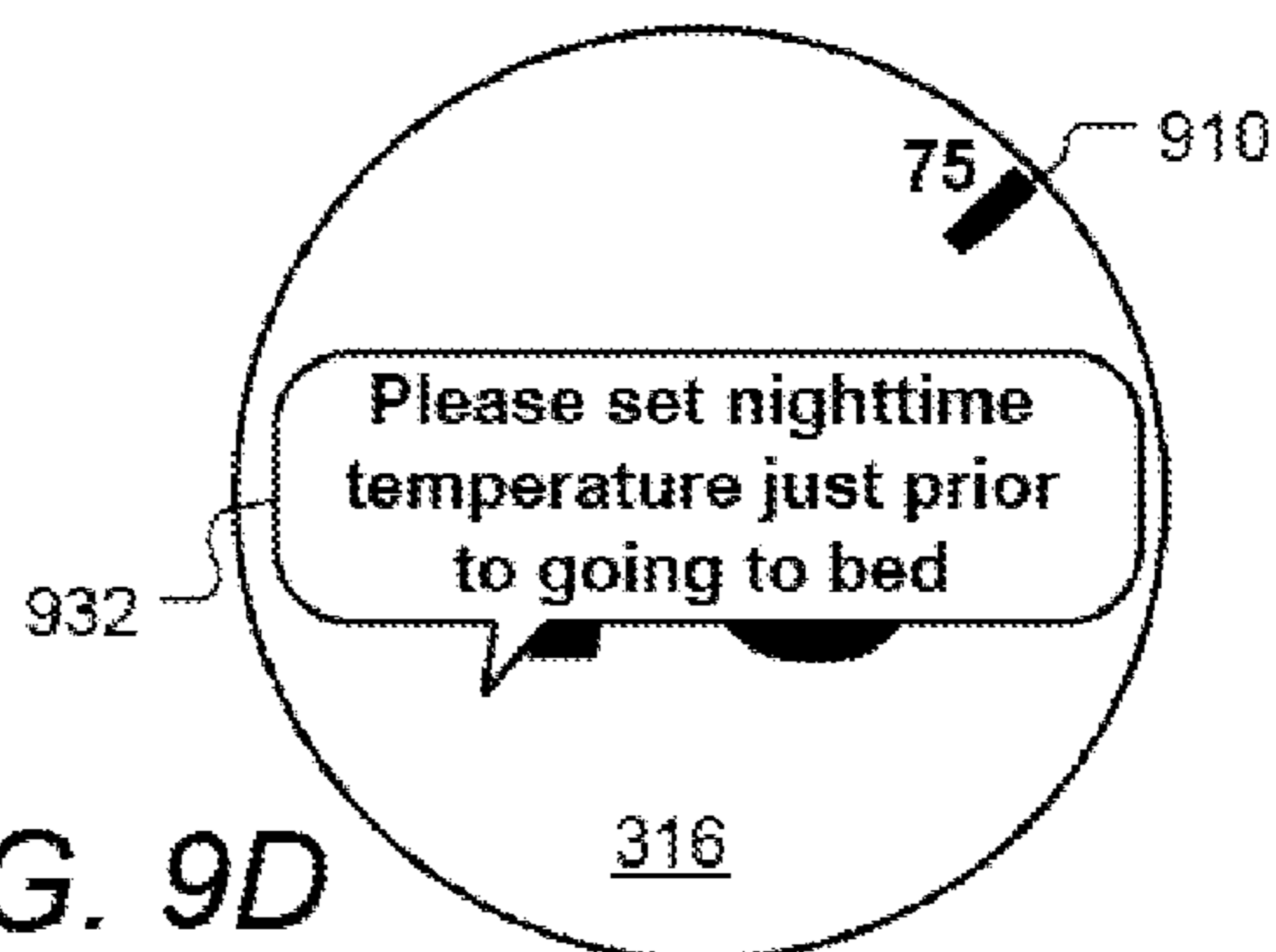

FIG. 9D

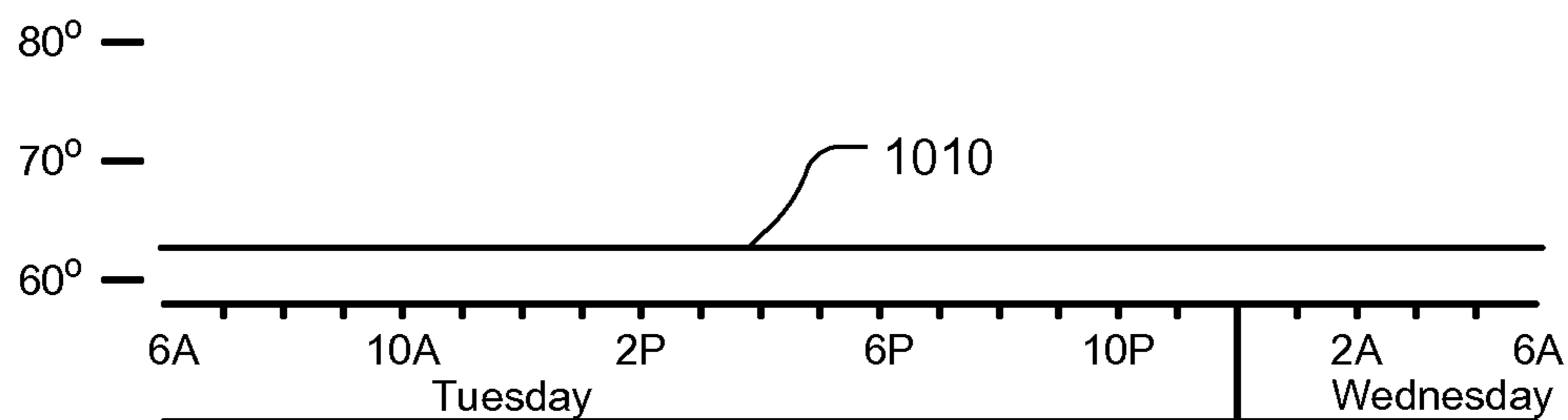

FIG. 10A

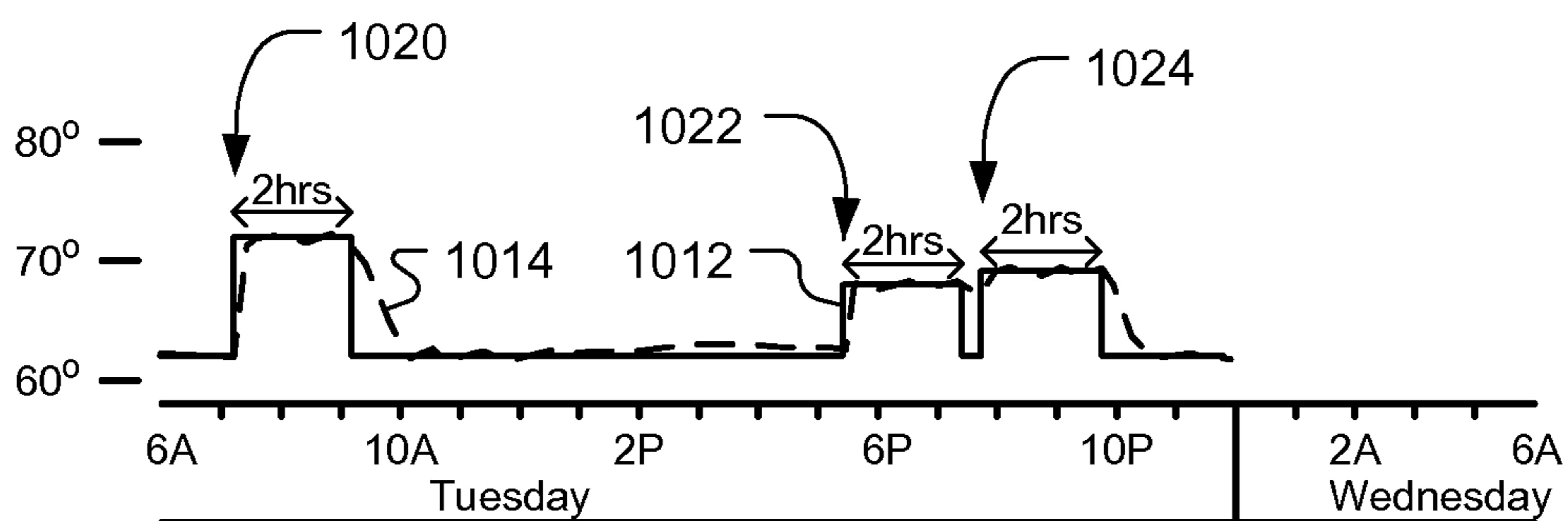

FIG. 10B

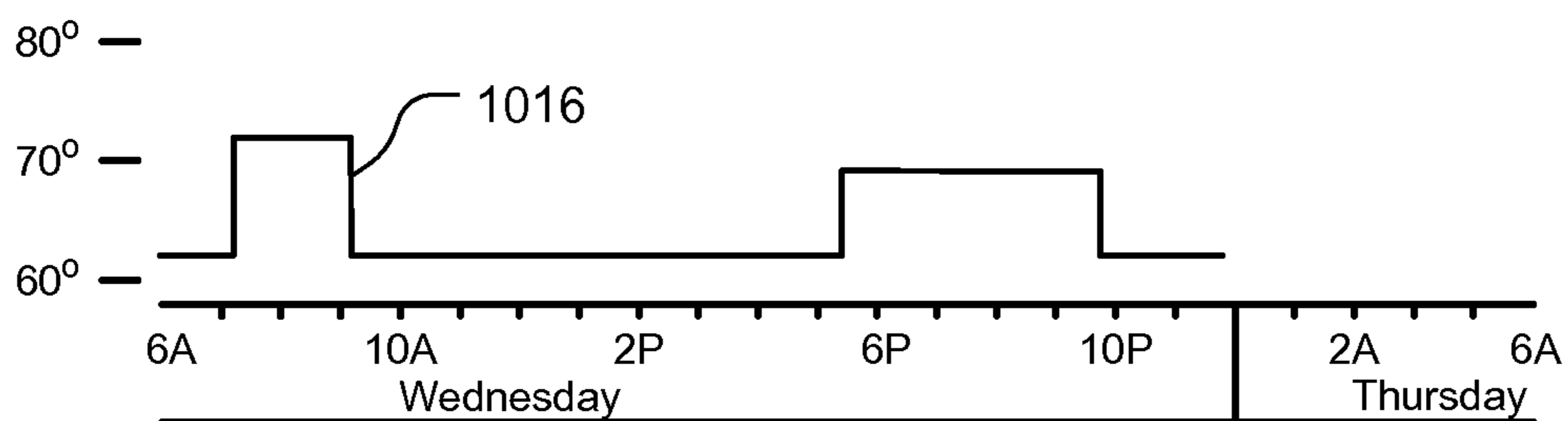

FIG. 10C

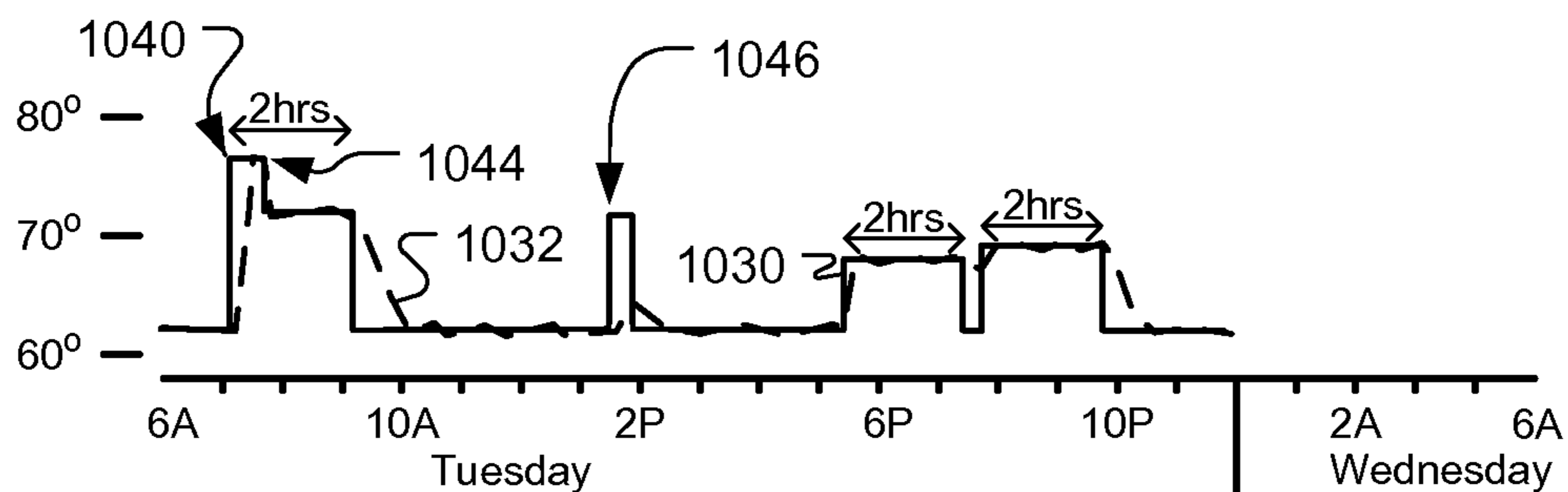

FIG. 10D

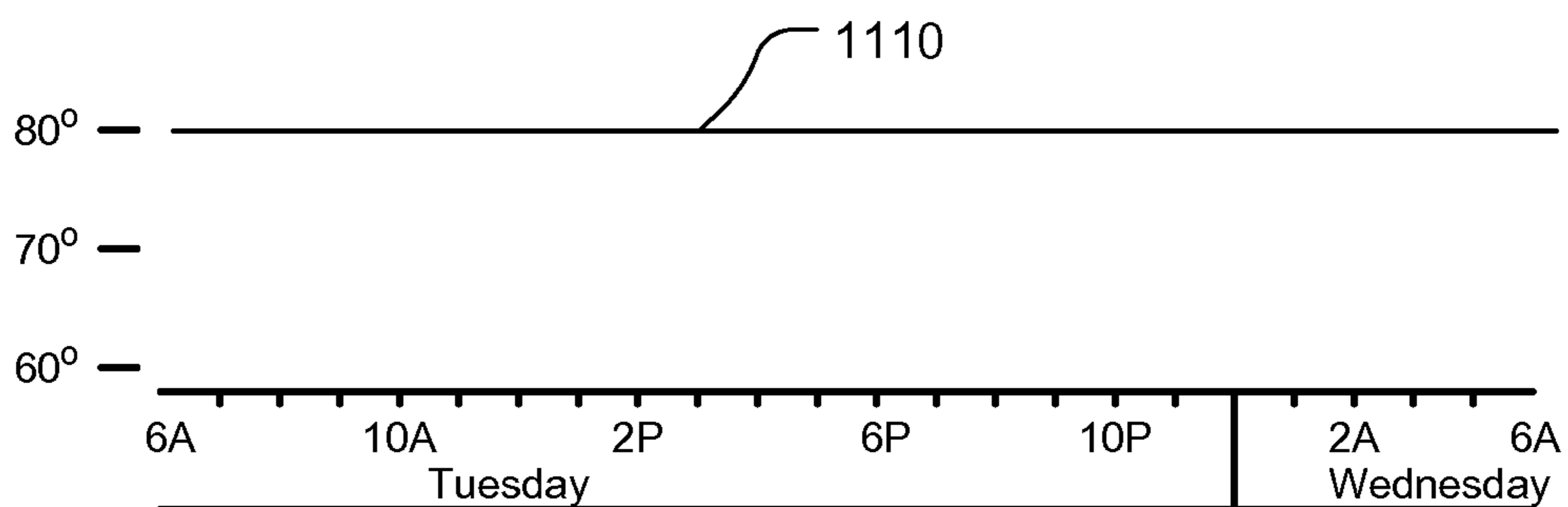

FIG. 11A

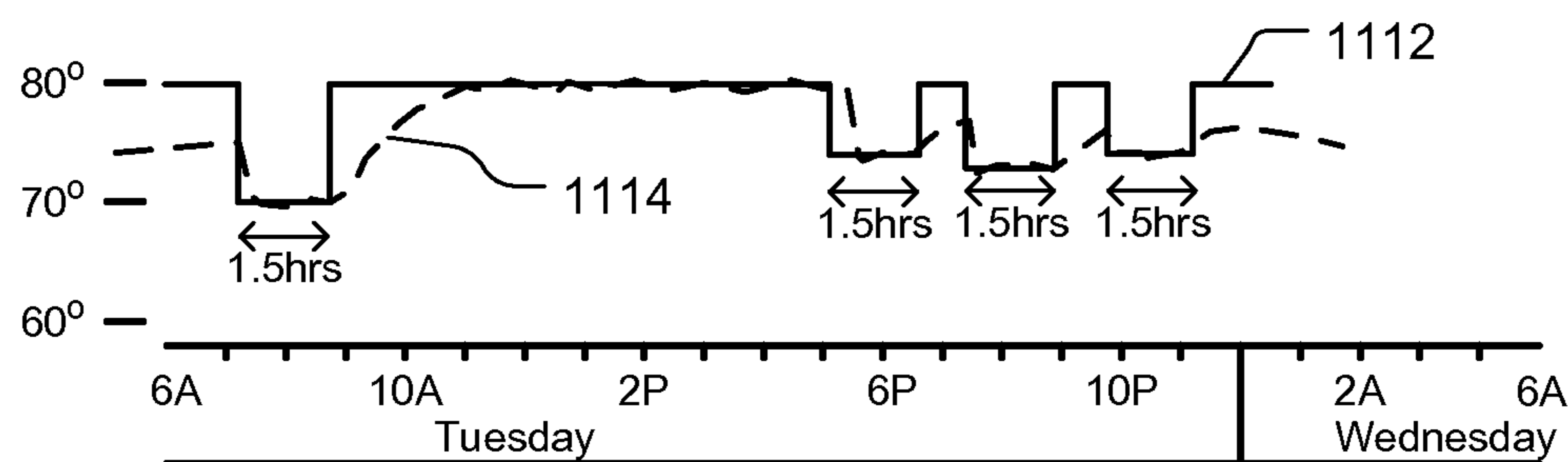

FIG. 11B

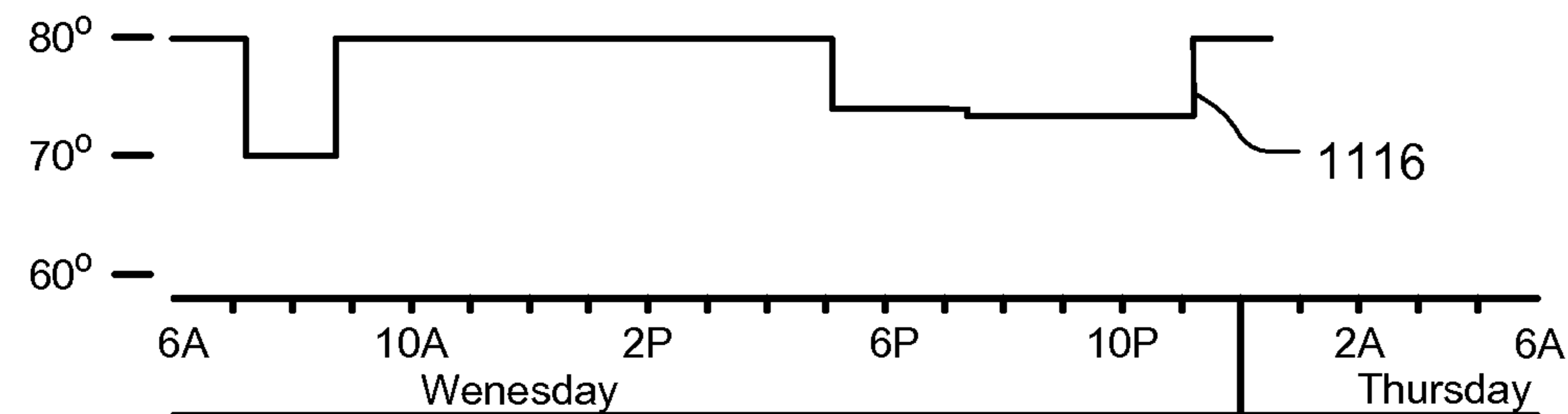

FIG. 11C

**ENERGY EFFICIENCY PROMOTING  
SCHEDULE LEARNING ALGORITHMS FOR  
INTELLIGENT THERMOSTAT**

**[0001]** This application claims the benefit of U.S. Prov. Application Ser. No. 61/550,345 filed Oct. 21, 2011, which is incorporated by reference herein.

FIELD

**[0002]** This invention relates generally to the monitoring and control of HVAC systems and/or for other systems for controlling household utilities, and/or resources. More particularly, embodiments of this invention relate to systems, methods and related computer program products for facilitating user-friendly installation and/or operation of a monitoring and control device such as a thermostat.

BACKGROUND

**[0003]** While substantial effort and attention continues toward the development of newer and more sustainable energy supplies, the conservation of energy by increased energy efficiency remains crucial to the world's energy future. According to an October 2010 report from the U.S. Department of Energy, heating and cooling account for 56% of the energy use in a typical U.S. home, making it the largest energy expense for most homes. Along with improvements in the physical plant associated with home heating and cooling (e.g., improved insulation, higher efficiency furnaces), substantial increases in energy efficiency can be achieved by better control and regulation of home heating and cooling equipment. By activating heating, ventilation, and air conditioning (HVAC) equipment for judiciously selected time intervals and carefully chosen operating levels, substantial energy can be saved while at the same time keeping the living space suitably comfortable for its occupants.

**[0004]** Historically, however, most known HVAC thermostat control systems have tended to fall into one of two opposing categories, neither of which is believed to be optimal in most practical home environments. In a first category are many simple, non-programmable home thermostats, each typically consisting of a single mechanical or electrical dial for setting a desired temperature and a single HEAT-FAN-OFF-AC switch. While being easy to use for even the most unsophisticated occupant, any energy-saving control activity, such as adjusting the nighttime temperature or turning off all heating/cooling just before departing the home, must be performed manually by the user. As such, substantial energy-saving opportunities are often missed for all but the most vigilant users. Moreover, more advanced energy-saving settings are not provided, such as the ability to specify a custom temperature swing, i.e., the difference between the desired set temperature and actual current temperature (such as 1 to 3 degrees) required to trigger turn-on of the heating/cooling unit.

**[0005]** In a second category, on the other hand, are many programmable thermostats, which have become more prevalent in recent years in view of Energy Star (US) and TCO (Europe) standards, and which have progressed considerably in the number of different settings for an HVAC system that can be individually manipulated. Unfortunately, however, users are often intimidated by a dizzying array of switches and controls laid out in various configurations on the face of the thermostat or behind a panel door on the thermostat, and seldom adjust the manufacturer defaults to optimize their own

energy usage. Thus, even though the installed programmable thermostats in a large number of homes are technologically capable of operating the HVAC equipment with energy-saving profiles, it is often the case that only the one-size-fits-all manufacturer default profiles are ever implemented in a large number of homes. Indeed, in an unfortunately large number of cases, a home user may permanently operate the unit in a "temporary" or "hold" mode, manually manipulating the displayed set temperature as if the unit were a simple, non-programmable thermostat. Thus, there is a need for a thermostat having an improved user interface that is simple, intuitive and easy to use such that the typical user is able to access many of the features such as programming energy-saving profiles.

**[0006]** At a more general level, because of the fact that human beings must inevitably be involved, there is a tension that arises between (i) the amount of energy-saving sophistication that can be offered by an HVAC control system, and (ii) the extent to which that energy-saving sophistication can be put to practical, everyday use in a large number of homes. Similar issues arise in the context of multi-unit apartment buildings, hotels, retail stores, office buildings, industrial buildings, and more generally any living space or work space having one or more HVAC systems.

**[0007]** Some attempts have been made to make programming of programmable thermostat more appealing to greater numbers of users. For example, U.S. Pat. Nos. 7,181,317 and 7,634,504 discuss methods for programming configuration information for thermostats wherein a series of interview questions are asked to a user. The user responses to the questions are stored and one or more schedule parameters can be modified based on the user responses. It is believed, however, that such approaches rely heavily or entirely on the user's answers, and as a result will be either wasteful of energy and/or unnecessarily subject the occupants to uncomfortable temperatures when people make mistakes when enter their responses to the questions.

**[0008]** U.S. Pat. No. 7,784,704 discusses a self-programmable thermostat that initially appears to function as an ordinary manual thermostat. The thermostat privately observes and learns a user's manual temperature setting habits and eventually programs itself accordingly. The thermostat looks for patterns, such as three similar manual overrides on consecutive days. Manual set point changes override current programmed set point temperatures. It is believed, however, that further improvement can be made in discussed method's ability to generate energy efficient program schedules.

SUMMARY

**[0009]** According to some embodiments a thermostat is described that includes: a housing; a ring-shaped user-interface component configured to track a rotational input motion from a user; a processing system disposed within the housing and coupled to the ring-shaped user interface component, the processing system being configured to be in operative communication with one or more temperature sensors for receiving ambient air temperature, the processing system further being configured to be in operative communication with an HVAC system control the HVAC system based at least in part on a comparison of the measured ambient temperature and a setpoint temperature, the processing system further being configured to identify a user's desire to immediately control the setpoint temperature value based on the tracked rotational input, the processing system still further being configured to

automatically reset the setpoint temperature to a less energy-consuming temperature upon an ending of a predetermined time interval and to generate, a schedule for the thermostat based at least in part on repeated identifications of the user's desire to immediately control the setpoint temperature; and an electronic display coupled to the processing system and configured to display information representative of the identified setpoint temperature value.

**[0010]** According to some embodiments, the electronic display is disposed along a front face of the thermostat housing, the ring-shaped user interface component comprises a mechanically rotatable ring that substantially surrounds the electronic display and is further configured to be inwardly pressable by the user along a direction of an axis of rotation of the rotational input motion, and the mechanically rotatable ring and the housing are mutually configured such that said mechanically rotatable ring moves inwardly along said direction of said axis of rotation when inwardly pressed. According to some embodiments the thermostat housing is generally disk-like in shape with the front face thereof being circular, and wherein the mechanically rotatable ring is generally coincident with an outer lateral periphery of said disk-like shape.

**[0011]** According to some embodiments, the electronic display is further configured to display to a user a notification relating to the generating of the schedule. According to some embodiments in cases where two or more immediate control setpoint temperature changes are identified within a short time interval of less than 90 minutes, the generating of the schedule is based on a latest of the two or more identifications. According to some embodiments, the automatic resetting of the setpoint temperature is to a base setpoint temperature of lower than 68 degrees Fahrenheit at times when the HVAC system uses heating and to a base setpoint temperature of greater than 78 degrees Fahrenheit at time when the HVAC system uses cooling. According to some embodiments the generated schedule is automatically adopted as an active schedule for the programmable thermostat.

**[0012]** According to some embodiments, a method is described for generating a schedule for a programmable thermostat used for control of an HVAC system, the thermostat comprising a housing, a ring-shaped user interface component, a processing system, and an electronic display. The described method includes: accessing an ambient air temperature measured by one or more temperature sensors; detecting and tracking rotational movements of the ring-shaped user-interface component to track at least one rotational input motion of a user; identifying a first setpoint temperature value based on the tracked rotational input motion at a first point in time; controlling the HVAC system based at least in part on a comparison of the measured ambient air temperature and the first setpoint temperature value for a predetermined time interval; automatically resetting the first setpoint temperature upon the ending of the predetermined time interval; identifying a second setpoint temperature value based on the tracked rotational input motion at a second point in time; controlling the HVAC system based at least in part on a comparison of the measured ambient air temperature and the second setpoint temperature value for the predetermined time interval; automatically resetting the second set point temperature upon the ending of the predetermined time interval; generating with the processing system, a schedule for the programmable thermostat based at least in part on the first and second setpoints and the first and second points in time; and

displaying information representative of the first and second identified setpoint temperature values on the electronic display.

**[0013]** According to some embodiments, the generated schedule is automatically adopted as an active schedule for the programmable thermostat. According to other embodiments the user is notified of the generated schedule; and user input is received as to whether or not to adopt the generated schedule as an active schedule.

**[0014]** According to some embodiments a thermostat is described that includes: a disk-like housing including a circular front face; an electronic display centrally disposed on the front face; an annular ring member disposed around the centrally disposed electronic display, said annular ring member and said housing being mutually configured such that (i) said annular ring member is rotatable around a front-to-back axis of the thermostat, and (ii) said annular ring member is inwardly pressable along a direction of the front-to back axis; a processing system disposed within the housing and coupled to the annular ring member; the processing system being configured and programmed to dynamically alter a setpoint temperature value based on a user rotation of the annular ring member; the processing system being further configured to be in operative communication with one or more temperature sensors for receiving an ambient air temperature, said processing system being still further configured to be in operative communication with an HVAC system to control the HVAC system based at least in part on a comparison of the measured ambient temperature and the setpoint temperature value; the processing system being still further configured to identify from the annular ring member user input relating to the user's preference regarding automatically generating a schedule and to determine therefrom whether or not to automatically adopt an automatically generated schedule. According to some embodiments, an audio output device is included that is coupled to said processing system, the thermostat being configured to output synthesized audible ticks through said audio output device in correspondence with user rotation of said mechanically rotatable ring.

**[0015]** As used herein the term "HVAC" includes systems providing both heating and cooling, heating only, cooling only, as well as systems that provide other occupant comfort and/or conditioning functionality such as humidification, dehumidification and ventilation.

**[0016]** As used herein the term "residential" when referring to an HVAC system means a type of HVAC system that is suitable to heat, cool and/or otherwise condition the interior of a building that is primarily used as a single family dwelling. An example of a cooling system that would be considered residential would have a cooling capacity of less than about 5 tons of refrigeration (1 ton of refrigeration=12,000 Btu/h).

**[0017]** As used herein the term "light commercial" when referring to an HVAC system means a type of HVAC system that is suitable to heat, cool and/or otherwise condition the interior of a building that is primarily used for commercial purposes, but is of a size and construction that a residential HVAC system is considered suitable. An example of a cooling system that would be considered residential would have a cooling capacity of less than about 5 tons of refrigeration.

**[0018]** As used herein the term "thermostat" means a device or system for regulating parameters such as temperature and/or humidity within at least a part of an enclosure. The

term “thermostat” may include a control unit for a heating and/or cooling system or a component part of a heater or air conditioner.

**[0019]** As used herein the term “immediate-control input” to a setpoint temperature refers to input from a user to immediately alter the currently active setpoint temperature. Thus an immediate-control input to a thermostat, also sometimes referred to as a “real time” setpoint entry, indicates a user’s desire to make an immediate change in the currently setpoint temperature in an HVAC system being controlled by the thermostat. Immediate-control inputs can be made by users either by directly manually interfacing with the thermostat, or by using a remote user interface such as by using a mobile phone, tablet computer and/or web interface on a computer.

**[0020]** As used herein the term “schedule-change input” refers to input from a user or other source to modify a programmed schedule for setpoint changes. Thus a user’s schedule-change input to a thermostat, also sometime referred to as a “non-real-time” setpoint entry or change, indicates the user’s desire to make changes to one or more of the thermostat’s programmed setpoints. In contrast to an immediate control input, where the user desires to immediately effect the currently active setpoint, a schedule-change input indicates a user’s desire to make a change (for example temperature or time) to a setpoint that will become active in the future. As in the case of immediate-control inputs, users can make schedule-change inputs either by directly manually interfacing with the thermostat, or by using a remote user interface such as by using a mobile phone, tablet computer and/or web interface on a computer.

**[0021]** It will be appreciated that these systems and methods are novel, as are applications thereof and many of the components, systems, methods and algorithms employed and included therein. It should be appreciated that embodiments of the presently described inventive body of work can be implemented in numerous ways, including as processes, apparatuses, systems, devices, methods, computer readable media, computational algorithms, embedded or distributed software and/or as a combination thereof. Several illustrative embodiments are described below.

#### BRIEF DESCRIPTION OF THE DRAWINGS

**[0022]** The inventive body of work will be readily understood by referring to the following detailed description in conjunction with the accompanying drawings, in which:

**[0023]** FIG. 1 is a diagram of an enclosure in which environmental conditions are controlled, according to some embodiments;

**[0024]** FIG. 2 is a diagram of an HVAC system, according to some embodiments;

**[0025]** FIGS. 3A-B illustrate a thermostat having a user-friendly interface, according to some embodiments;

**[0026]** FIGS. 4A-C show aspects of a user interface for a thermostat having learning and self-programming capabilities, according to some embodiments;

**[0027]** FIGS. 5A-B show aspects of a user interface for generating a program, according to some embodiments;

**[0028]** FIGS. 6A-C show examples of basic schedules generated based on answers to basic questions, such as those shown in FIG. 5B, according to some embodiments;

**[0029]** FIGS. 7A-E show aspects of a user interface for a thermostat that generates potential schedule adjustments and suggests them to a user for review and acceptance, according to some embodiments;

**[0030]** FIG. 8 shows an example of a web-based user interface for a thermostat that generates potential schedule adjustments and suggests them to a user for review and acceptance, according to some embodiments;

**[0031]** FIGS. 9A-D show aspects of a user interface for a thermostat adapted to learn and generate a schedule based on immediate-control inputs made by the occupants, according to some embodiments;

**[0032]** FIGS. 10A-D show examples of automatically generating a schedule using a “flat line” starting point and learning from immediate-control inputs, according to some embodiments; and

**[0033]** FIGS. 11A-C show examples of automatically generating a schedule using a “flat line” starting point and learning from immediate-control inputs, according to some embodiments.

#### DETAILED DESCRIPTION

**[0034]** A detailed description of the inventive body of work is provided below. While several embodiments are described, it should be understood that the inventive body of work is not limited to any one embodiment, but instead encompasses numerous alternatives, modifications, and equivalents. In addition, while numerous specific details are set forth in the following description in order to provide a thorough understanding of the inventive body of work, some embodiments can be practiced without some or all of these details. Moreover, for the purpose of clarity, certain technical material that is known in the related art has not been described in detail in order to avoid unnecessarily obscuring the inventive body of work.

**[0035]** FIG. 1 is a diagram of an enclosure in which environmental conditions are controlled, according to some embodiments. Enclosure **100**, in this example is a single-family dwelling. According to other embodiments, the enclosure can be, for example, a duplex, an apartment within an apartment building, a light commercial structure such as an office or retail store, or a structure or enclosure that is a combination of the above. Thermostat **110** controls HVAC system **120** as will be described in further detail below. According to some embodiments, the HVAC system **120** is has a cooling capacity less than about 5 tons. According to some embodiments, a remote device **112** wirelessly communicates with the thermostat **110** and can be used to display information to a user and to receive user input from the remote location of the device **112**. Although many of the embodiments are described herein as being carried out by a thermostat such as thermostat **110**, according to some embodiments, the same or similar techniques are employed using a remote device such as device **112**.

**[0036]** FIG. 2 is a diagram of an HVAC system, according to some embodiments. HVAC system **120** provides heating, cooling, ventilation, and/or air handling for the enclosure, such as a single-family home **100** depicted in FIG. 1. The system **120** depicts a forced air type heating system, although according to other embodiments, other types of systems could be used. In heating, heating coils or elements **242** within air handler **240** provide a source of heat using electricity or gas via line **236**. Cool air is drawn from the enclosure via return air duct **246** through filter **270**, using fan **238** and is heated heating coils or elements **242**. The heated air flows back into the enclosure at one or more locations via supply air duct system **252** and supply air grills such as grill **250**. In cooling, an outside compressor **230** passes gas such as a Freon through a

set of heat exchanger coils to cool the gas. The gas then goes to the cooling coils **234** in the air handlers **240** where it expands, cools and cools the air being circulated through the enclosure via fan **238**. According to some embodiments a humidifier **254** is also provided. Although not shown in FIG. **2**, according to some embodiments the HVAC system has other known functionality such as venting air to and from the outside, and one or more dampers to control airflow within the duct systems. The system is controlled by algorithms implemented via control electronics **212** that communicate with a thermostat **110**. Thermostat **110** controls the HVAC system **120** through a number of control circuits. Thermostat **110** also includes a processing system **260** such as a microprocessor that is adapted and programmed to controlling the HVAC system and to carry out the techniques described in detail herein.

[**0037**] FIGS. **3A-B** illustrate a thermostat having a user-friendly interface, according to some embodiments. Unlike so many prior art thermostats, thermostat **300** preferably has a sleek, simple, uncluttered and elegant design that does not detract from home decoration, and indeed can serve as a visually pleasing centerpiece for the immediate location in which it is installed. Moreover user interaction with thermostat **300** is facilitated and greatly enhanced over conventional designs by the design of thermostat **300**. The thermostat **300** includes control circuitry and is electrically connected to an HVAC system, such as is shown with thermostat **110** in FIGS. **1** and **2**. Thermostat **300** is wall mounted and has circular in shape and has an outer rotatable ring **312** for receiving user input. Thermostat **300** has a large frontal display area **314**. According to some embodiments, thermostat **300** is approximately 80 mm in diameter. The outer rotating ring **312** allows the user to make adjustments, such as selecting a new target temperature. For example, by rotating the outer ring **312** clockwise, the target temperature can be increased, and by rotating the outer ring **312** counter-clockwise, the target temperature can be decreased. Within the outer ring **312** is a clear cover **314** which according to some embodiments is polycarbonate. Also within the rotating ring **312** is a metallic portion **324**, preferably having a number of windows as shown. According to some embodiments, the surface of cover **314** and metallic portion **324** form a curved spherical shape gently arcing outward that matches a portion of the surface of rotating ring **312**.

[**0038**] According to some embodiments, the cover **314** is painted or smoked around the outer portion, but leaving a central display **316** clear so as to facilitate display of information to users. According to some embodiments, the curved cover **314** acts as a lens which tends to magnify the information being displayed in display **316** to users. According to some embodiments central display **316** is a dot-matrix layout (individually addressable) such that arbitrary shapes can be generated, rather than being a segmented layout. According to some embodiments, a combination of dot-matrix layout and segmented layout is employed. According to some embodiments, central display **316** is a backlit color liquid crystal display (LCD). An example of information is shown in FIG. **3A**, which are central numerals **320**. According to some embodiments, metallic portion **324** has number of openings so as to allow the use of a passive infrared proximity sensor **330** mounted beneath the portion **324**. The proximity sensor as well as other techniques can be use used to detect and/or predict occupancy, as is described further in co-pending patent application U.S. Ser. No. 12/881,430, which is incor-

porated by reference herein. According to some embodiments, occupancy information is used in generating an effective and efficient scheduled program.

[**0039**] According to some embodiments, for the combined purposes of inspiring user confidence and further promoting visual and functional elegance, the thermostat **300** is controlled by only two types of user input, the first being a rotation of the outer ring **312** as shown in FIG. **3A** (referenced hereafter as a “rotate ring” input), and the second being an inward push on the upper cap **308** (FIG. **3B**) until an audible and/or tactile “click” occurs (referenced hereafter as an “inward click” input). For further details of suitable user-interfaces and related designs which are employed, according to some embodiments, see co-pending patent application U.S. Ser. No. 13/033,573 and U.S. Ser. No. 29/386,021, both filed Feb. 23, 2011, and are incorporated herein by reference. The subject matter of the instant patent specification is further related to that of the following commonly assigned applications, each of which is incorporated by reference herein: U.S. Ser. No. 13/279,151 filed Oct. 21, 2011; U.S. Prov. Ser. No. 61/627,996 filed Oct. 21, 2011; U.S. Prov. Ser. No. 61/550,343 filed Oct. 21, 2011; and U.S. Prov. Ser. No. 61/550,346 filed Oct. 21, 2011.

[**0040**] According to some embodiments, the thermostat **300** includes a processing system **360**, display driver **364** and a wireless communications system **366**. The processing system **360** is adapted to cause the display driver **364** and display area **316** to display information to the user, and to receiver user input via the rotating ring **312**. The processing system **360**, according to some embodiments, is capable of maintaining and updating a thermodynamic model for the enclosure in which the HVAC system is installed. For further detail on the thermodynamic modeling, see U.S. patent Ser. No. 12/881,463 filed, which is incorporated by reference herein. According to some embodiments, the wireless communications system **366** is used to communicate with devices such as personal computers and/or other thermostats or HVAC system components.

[**0041**] FIGS. **4A-C** show aspects of a user interface for a thermostat having learning and self-programming capabilities, according to some embodiments. FIG. **4A** shows an example of a display **316** of thermostat **300** described with respect to FIGS. **3A-B**. The display **316** indicates that the user is making settings with respect to the thermostat’s learning functionality. The colored disk **410** indicates that the learning setting that will be entered, if selected using an inward click, relates to whether the user will be asked about changes made to the program schedule. FIG. **4B** shows the display **316** following a user selection using an inward click. In FIG. **4B**, the user is asked to if the thermostat should adjust the schedule automatically. Using the rotating ring the and inward click the user selects “yes” or “no.” If the user selects “yes,” then in step **420** the thermostat automatically generates one or more programs, such as described more fully herein. If the user selects “no,” the thermostat, according to some embodiments, the thermostat nevertheless records some or all of the user’s adjustments in set temperature and generates suggested schedule changes according to certain criteria (for example, energy or cost savings to the user). According to some embodiments, if the user answers “no” to the question about automatically adjusting the schedule, the thermostat asks the user, as shown in display **316** of FIG. **4C**, if the thermostat should suggest changes to the user each week. If the user answers “yes,” then in step **422**, the thermostat generates a

schedule based on learning from the user's immediate-control inputs in combination with other information, and periodically suggests changes to the user according to certain criteria (for example, energy saving or costs savings). If the user answers "no," then in step 424 the thermostat does not generate any program and instead always follows the program set by the user.

[0042] FIGS. 5A-B show aspects of a user interface for generating a program, according to some embodiments. In FIG. 5A, the user can select entering set-up questions relating to the schedule settings as indicated by the colored disk 510, using an inward click input while the thermostat displays the screen as shown in display 316. FIG. 5B is a flow chart showing questions that can be asked of the user in order to generate a basic schedule, according to some embodiments. As can be seen from the flow chart 512 of FIG. 5B, the user is initially asked if the thermostat is installed in a home or business. Then some basic questions are asked to generate a basic schedule, such as whether the home is usually occupied at noon, is someone usually up after 11 pm, and whether or not there is more than one thermostat in the home. Similar questions are asked if the thermostat is installed in a business. According to some embodiments, a basic schedule is generated based on the answers to the questions in FIG. 5B.

[0043] FIGS. 6A-B show examples of basic schedules generated based on answers to basic questions, such as those shown in FIG. 5B, according to some embodiments. In FIG. 6A, curve 610 shows a basic schedule for setpoints from 6 am Tuesday to 6 am Wednesday, which corresponds to a home that the user indicated is occupied during noon and the user indicated that someone is not usually up at 11 pm. As can be seen, the setpoint temperature changes at 7 am from 62 degrees to 72 degrees and then stays at 72 degrees until 10 pm when it changes back to 62 degrees. In FIG. 6B, curve 612 shows a basic schedule that corresponds to a home that the user indicated is not occupied during noon and that someone is not usually up at 11 pm. As can be seen, the set point temperature changes at 7 am from 62 degrees to 72 degrees. Then, at 9 am, the temperature is set back to 62 degrees until 5 pm, when the set point is changed to 72 degrees. The set back from 9 am to 5 pm is due to the user's indication that no one is usually home at noon. In FIG. 6C, curve 614 corresponds to a user's indication that no one is usually home at noon, and someone is usually up at 11 pm. In this case the evening set back time is set to midnight. As can be seen a basic schedule is limited by the simple questions that it is based upon, and as a result the occupants may either be uncomfortable, or energy use and costs may be higher than necessary. For example, the occupants may get up before 7 am, or they may be perfectly comfortable at 68 degrees instead of 72 degrees. According to some embodiments, further questions are asked of the user, such as whether someone is usually up at 6:30 am, or if the occupants are comfortable at 68 degrees. However, each additional question detracts from the simple user interface experience, as well as introduces potential errors based on wrong answers and/or misunderstood questions.

[0044] According to some embodiments, after generating the basic schedule based on a few simple questions such as shown in FIGS. 6A-C, the thermostat learns from the user's immediate-control inputs and periodically suggests, or automatically implements schedule changes that meet certain criteria.

[0045] FIGS. 7A-E show aspects of a user interface for a thermostat that generates potential schedule adjustments and suggests them to a user for review and acceptance, according to some embodiments. FIG. 7A shows the thermostat 300 with display 316. A message bubble 710 is overlaid on the display 316 to obtain the user's attention. According to some embodiments, one or more proximity sensors (not shown) are used to detect when an occupant is approaching the thermostat 300. Upon sensing an approaching occupant, the message bubble 710 is displayed in order to obtain the user's attention. If the user wishes further information an inward click input leads to the display 316 shown in FIG. 7B. In FIG. 7B, the thermostat indicates to the user that a new schedule has been calculated that is estimated would have saved about 10% of energy costs in the past week. The user has the choice to view the new schedule or reject it. If the user indicates a desire to see the new schedule, then an animation is displayed which alternates between FIG. 7C showing the current schedule, and FIG. 7D showing the proposed new schedule. In FIG. 7C, the current set point temperature 722 is shown and the applicable time 724 is shown below. In FIG. 7D, the new set point temperature 722 is shown and the new time 724 is shown below. If there are further changes to the schedule then those can be accessed by rotating the ring to the right or left. When the user is finished reviewing the new schedule, the user, in FIG. 7E is given the choice to update the schedule or not.

[0046] FIG. 8 shows an example of a web-based user interface for a thermostat that generates potential schedule adjustments and suggests them to a user for review and acceptance, according to some embodiments. A computer monitor 810 is used to display to a user of the thermostat suggested schedule changes. The user can use a pointing device such as mouse 820 to move a pointer 822 to provide input. In the window 812, the user is asked in bubble 814 whether the displayed schedule change should be adopted. According to some embodiments, further information, such as the estimated amount of energy savings associated with the proposed change can be displayed to aid the user in making a decision. The current schedule is shown in solid circles and the proposed changes are shown in dotted circles. For example, the set back time to 62 degrees in the morning is suggested to be changed from 9 am (shown by solid circle 830) to about 9:30 am (shown by dotted circle 832), and the evening set back to 62 degrees is suggested to be changed from midnight (shown by the solid circle 840) to about 10:15 pm (shown by the dotted circle 842). According to some embodiments, a "snap" button or similar can be provided to the user for the user to easily adopt all the suggested schedule changes. According to some embodiments, the user can also use the interface as shown in FIG. 8 to make their own adjustments and/or accept or reject particular suggested changes by clicking and dragging the circles along the time line, and/or by changing the temperature value within one or more of the circles. According to some embodiments, the interface screen such as shown in FIG. 8 can be displayed at the request of the user, or it can be shown at the request of a central server, such as is common in push technology. According to some embodiments, the decision on when to "push" a notification of a suggested schedule change can be based at least in part on an estimation of energy and/or cost savings being above a predetermined threshold or percentage value.

[0047] While simply observing and recording a user's immediate-control inputs can be useful in generating a schedule and/or adjustments to an existing scheduled program, it



has been found, unexpectedly, that the thermostat can more effectively learn and generate a scheduled program that makes the user more comfortable while saving energy and cost when the user is periodically urged to input settings to maintain or improve the user's comfort. Bothering the user by periodically urging manual input may at first appear to run counter to a user-friendly experience, but it has been found that this technique very quickly allows the thermostat to generate a schedule that improves user comfort while saving costs, and thus turns out to be very user-friendly overall.

[0048] According to some preferred embodiments, therefore, a user's set point change automatically expires after a predetermined amount of time. By automatically re-setting or setting back a user's set point adjustment after a predetermined amount of time, the user is urged to repeatedly make set point changes to maintain or improve comfort. As a result, the thermostat is able to learn and generate a much more effective schedule in terms of both comfort for the occupants as well as energy efficiency and cost savings. In this way, the thermostat can learn both the set point temperature, the occupants regard as providing comfort, as well as the times of the day when the user benefits from set point changes, as well as times of the day, such as during periods when the conditioned zone is unoccupied, when the set point temperature can be set back in order to save cost and energy while having a little or no impact on occupant comfort.

[0049] FIGS. 9A-D show aspects of a user interface for a thermostat adapted to learn and generate a schedule based on immediate-control changes made by the occupants, according to some embodiments. In FIG. 9A, the thermostat 300 uses display 316 to inform the user using message bubble 920 that the thermostat is in the process of learning in order to generate a schedule that is suitable for the occupants. The user is asked to adjust the thermostat frequently to make the user comfortable. As shown in FIG. 9A, the current set point temperature is set to 62 degrees F. as indicated by the set point tick 910. In FIG. 9B, a user adjusts the set point temperature, or makes an immediate-control input, to improve comfort by rotating the outer ring 312. The current temperature is 62 degrees F., as indicated by the current temperature tick 912, and the set point has been adjusted to 75, as indicated by the set point tick 910 and by the large central numerals. Additionally, the user is reminded that the thermostat is learning by a flashing "learning" message 922. FIG. 9C shows display 316 following an immediate-control input such as described with respect to FIG. 9B. According to some embodiments, as described above, immediate-control input expires after a predetermined amount of time so as to enhance the ability of the thermostat 300 to learn and generate effective and efficient schedules. The current temperature of 75 degrees F. is displayed in the large central numerals. The set point temperature, which was manually entered as an immediate-control input, is shown by the set point tick 910. The user is informed that the immediate-control input will automatically expire at 6:35 pm in message 930. According to an alternate embodiment, the message 930 displays a countdown timer showing how many minutes remain until the user's immediate-control input expires. FIG. 9D shows a message bubble 932 that informs the user that a comfortable nighttime temperature should be manually entered just prior to going to bed. According to some embodiments, the message such as shown in FIG. 9D is automatically displayed after a certain time of day (such as 9 pm) when one or more proximity sensors detect when an occupant is approaching the thermostat 300.

[0050] It has been found, quite unexpectedly, that in many circumstances the thermostat can more quickly and effectively generate a schedule that balances user comfort with cost and energy savings, when the starting point for gathering the user's input is a "flat-line" or constant temperature that may be quite uncomfortable to many users, but saves significant energy. For example the starting point or initial setting for the thermostat in geographic locations and times of the year when heating is predominantly called for (rather than cooling) is a constant low temperature such as 62 degrees F. In geographic locations and times of year when cooling is predominantly called for the starting "flat line" is, for example, 85 degrees F. This "flat-line" starting point, when combined with automatic re-setting or expiring of the user's immediate-control inputs after a predetermined amount of time has been found to be more effective in many situations than starting with a basic schedule based on a number of basic questions, such as showing in FIG. 5B.

[0051] FIGS. 10A-D show examples of automatically generating a schedule using a "flat line" starting point and learning from immediate-control inputs, according to some embodiments. FIG. 10A shows the starting point schedule 1010 which is a "flat line" of 62 degrees throughout the day. According to some embodiments, the starting point temperature is selected using a number of criteria. Firstly, a determination should be made as to whether heating or cooling is likely to be called for. In cases where the HVAC system being controlled by the thermostat has both heating and cooling functionality, then the determination of which to use can in many or most cases be made using a combination of geographic location (e.g. using postal or ZIP code) which is known or gathered from basic set up information, and the time of year (from the date). In some locations and times of the year, however, it may be unclear whether the user will want to predominantly use heating or cooling. According to some embodiments, the user's first immediate-control input is used in such cases. For example, if the user makes an immediate-control input to set the temperature greater than the ambient temperature, then it is assumed heating is wanted. According to other embodiments, the user is asked using a message bubble or the like, in such cases. Secondly, a determination should be made as to what temperature should be used as the base "flat line." According to some embodiments, a temperature is selected at which many or most occupants would consider at least somewhat uncomfortable such that an occupant would likely wish to make an immediate-control input to improve comfort. The base temperature should not be too uncomfortable, however, since doing so would unnecessarily subject to occupants to discomfort. It has been found that when heating is called for, a base value of between 60 and 64 degrees is suitable for many geographic locations.

[0052] According to some embodiments, the user is notified that the thermostat is trying to learn and generate a schedule, such as using a message bubble as shown in FIG. 9A. In FIG. 10B, the curve 1012 shows the user's immediate-control inputs throughout the day and curve 1014 shows the indoor temperature sensed by the thermostat. A time 1020, about 7:15 am, the user makes an immediate-control input to change the set point temperature from 62 degrees to 72 degrees. According to some embodiments, the set point temperature automatically is set to expire after a predetermined amount of time, which in this example is two hours. Thus, at about 9:15 am, the set point is automatically set back to the base line value of 62 degrees. In this example the user has

gone out of the house for the day, and so does not make any immediate-control inputs until the user returns home. At time **1022**, about 5:20 pm, the user makes an immediate-control input to adjust the set point to 68 degrees. In this example the predetermined expiry period is two hours, so the set point is automatically set back to 62 degrees at about 7:20 pm. According to some embodiments, the user is informed of the expiry time using a message such as shown in FIG. 9C. Still referring to FIG. 10B, the user at time **1024**, about 7:45 pm, the user makes an immediate-control input to adjust the set point temperature to 69 degrees. The set point is automatically set back to 62 degrees after two hours, at about 9:45 pm. In this example, the occupants have gone to bed before or not long after 9:45, so no further immediate-control inputs are made that day.

[0053] FIG. 10C shows a schedule curve **1016** that has been generated based on the user's immediate-control inputs on the previous day (as shown in FIG. 10B). The temperature is set in the morning at 7:15 am to 72 degrees until it is set back at 9:15 am to 62 degrees. At 5:20, the temperature is set to 69 degrees until it is set back at 9:45 pm to 62 degrees. Note that both the times of day and set point temperatures have been used in generating the schedule shown in FIG. 10C. Additionally, according to some embodiments, the short gap from 7:20, when the temperature was automatically set back, and 7:45 when the user made an immediate-control input, is ignored. Also, the setpoint temperatures in the evening of 68 and 69 degrees were not identical and either an average or the later set temperature was used, in this case 69 degrees.

[0054] According to some embodiments, the shortest time for a scheduled set point segment is set to 60 minutes. If two immediate-control inputs occur within the 60 minutes of each other, the later will generally be used and the earlier setting or settings will be ignored. FIG. 10D illustrates some example scenarios, with curve **1030** showing the set point temperature of the thermostat as manually and automatically adjusted, and curve **1032** shows the current indoor temperature sensed by the thermostat. At time **1040**, about 7:15 am, the an immediate-control input is made by the user change the set point to 77 degrees, but about 30 minutes later at time **1044**, about 7:45 am, the user makes an immediate-control input changing the set point to 72 degrees. Since the two immediate-control inputs occurred within a short time (in this case 30 minutes), the first setting is assumed to be erroneous and is ignored for purposes of the automatically generated schedule. Similarly, at time **1046** an immediate-control input is made and about 20 minutes later an immediate-control input resets the temperature to the base line level. Since the setting was effectively cancelled, it is assumed to be erroneous and ignored for purposes of the automatically generated schedule. If, on the other hand, the immediate-control input was not reset for 45 minutes or more, then the immediate-control input is not ignored, according to some embodiments, and segment would be created in the generated schedule for 60 minutes duration. Note that following the described rules, the immediate-control inputs as shown in curve **1030** would lead to an automatically generated schedule as shown by curve **1016** in FIG. 10C.

[0055] FIGS. 11A-C show examples of automatically generating a schedule using a "flat line" starting point and learning from immediate-control inputs, according to some embodiments. FIG. 11A shows set point curve **1110** that is an example of a "flat line" base value of 80 degrees that is suitable when cooling is believed to be predominantly called

for (e.g. based on the geographic location and time of year, as described above). In FIG. 11B, curve **1112** shows the set point settings from immediate-control inputs and automatic resets, and curve **1114** shows the ambient indoor temperature as sensed by the thermostat. In this example, the predetermined expiry time (or reset time) is 1.5 hours. At 7:10 am, the user makes an immediate-control input to 70 degrees. The set point is maintained for 1.5 hours, and at 8:40 am, the set point is automatically set back to 80 degrees. At 5:11 pm the user returns home and makes an immediate-control input to 73 degrees which is maintained for 1.5 hours. At 6:41 pm this set point "expires" and set point is automatically set back to the base value of 80 degrees. At 7:16 pm the user again makes an immediate-control input, but this time to 72 degrees. At 8:46 pm this set point "expires" and the set point is automatically set back to the base value of 80 degrees. At 9:44 pm, the user again makes an immediate-control input to 72 degrees. At 11:14 pm this set point expires, but the user makes no further immediate-control inputs. FIG. 11C shows an example of a schedule **1116** that is automatically generated based on the user input shown in curve **1112** of FIG. 11B. In schedule **1116**, a set point of 70 degrees is made between 7:10 am and 8:40 am. During the day, the house is assumed to be unoccupied (since no immediate-control inputs were made on the learning day shown in FIG. 11B), and the temperature is set back to 80 degrees. At 5:11 pm the temperature is set to 73 degrees and then from 7:16 pm to 11:14 pm the temperature is set to 72 degrees.

[0056] Note that in the examples shown in FIGS. 10A-D the predetermined expiry time is 2 hours and in the examples shown FIGS. 11A-C the predetermined expiry time is 1.5 hours. It has been found, if the period of time after which the user's immediate-control input is shorter than 30 minutes, this generally cause excessive annoyance to the occupants. On the other hand, if the time is greater than 6 hours, the resulting generated schedule is likely to be wasteful of cost and energy since periods of non-occupancy and/or sleeping are not accurately captured. According to some embodiments the time period is greater than 1 hour and less than or equal to 5 hours. According to some preferred embodiments, time periods of between 1.5 hours and 3 hours have been found to strike a very good compromise between annoyance to the occupants and energy efficiency of the resulting schedule.

[0057] According to some embodiments, the learning process described herein with respect to FIGS. 9-11 can be carried out separately for weekdays versus weekend days. For example, the "flat-line" learning method described can be carried out on a weekday as described which generates a suitable schedule for weekdays. Then, on the first weekend day, a new "flat-line" learning process is started, since it is assumed that for many people the weekday and weekend day schedules are vastly different.

[0058] According to some embodiments, the described learning processes continue even after a schedule is activated. For example, following a learning process, a schedule such as shown in FIGS. 10C and/or 11C are generated and activated. The thermostat continues to learn by watching and recording immediate-control inputs. After repeated immediate-control inputs are made, the decision is made as whether and schedule change are automatically implemented or suggested to the user. According to some embodiments, if a user makes similar immediate-control inputs three days in a row (where "similar" is defined, for example, as adjustments within 5 degrees made with 60 minutes of each other), a schedule-change is

automatically inputted (and the user notified), or the schedule-change input is suggested to the user. According to some embodiments, estimated energy and/or cost savings is also used as a criterion for implementing or suggesting schedule-change inputs.

**[0059]** According to some embodiments, the continued learning process as described above is used for adjusting, or suggesting improvements to a basic schedule generated from a basic set of questions as shown in and described with respect to FIGS. 5-6. However, it has been found that in many applications, starting with a “flat-line” works to more effectively learn the user’s preferences. According to some embodiments, the continued learning process is also carried out in cases where the user has indicated that they wish to manually enter their own scheduled program. In such cases, for example, changes to the schedule can be suggested according to the potential for energy and/or cost savings.

**[0060]** According to some embodiments, occupancy data can also be incorporated in the process of automatically generating a schedule for adoption and/or suggestion to the user. It has been found that occupancy data is particularly useful in cases using automatic set back after a time period, where the time is relatively long—such as three or more hours. In cases where the thermostat is installed in a dwelling that is relatively large, then local-proximity-based occupancy sensing may not be accurate for relatively short periods of time because occupants may simply be in a different part of the dwelling during that time period. However, if there is no occupancy sensed close to the thermostat for greater than two hours, then it is increasingly likely that the dwelling is in fact not occupied.

**[0061]** Although the foregoing has been described in some detail for purposes of clarity, it will be apparent that certain changes and modifications may be made without departing from the principles thereof. It should be noted that there are many alternative ways of implementing both the processes and apparatuses described herein. Accordingly, the present embodiments are to be considered as illustrative and not restrictive, and the inventive body of work is not to be limited to the details given herein, which may be modified within the scope and equivalents of the appended claims.

What is claimed is:

1. A thermostat comprising:

- a housing;
- a ring-shaped user-interface component configured to track a rotational input motion from a user;
- a processing system disposed within the housing and coupled to the ring-shaped user interface component, the processing system being configured to be in operative communication with one or more temperature sensors for receiving ambient air temperature, the processing system further being configured to be in operative communication with an HVAC system control the HVAC system based at least in part on a comparison of the measured ambient temperature and a setpoint temperature, the processing system further being configured to identify a user’s desire to immediately control the setpoint temperature value based on the tracked rotational input, the processing system still further being configured to automatically reset the setpoint temperature to a less energy-consuming temperature upon an ending of a predetermined time interval and to generate a schedule for the thermostat based at least in part on

- repeated identifications of the user’s desire to immediately control the setpoint temperature; and
- an electronic display coupled to the processing system and configured to display information representative of the identified setpoint temperature value.

2. A thermostat according to claim 1 wherein:

- said electronic display is disposed along a front face of the thermostat housing;

- said ring-shaped user interface component comprises a mechanically rotatable ring that substantially surrounds the electronic display and is further configured to be inwardly pressable by the user along a direction of an axis of rotation of the rotational input motion; and

- said mechanically rotatable ring and said housing are mutually configured such that said mechanically rotatable ring moves inwardly along said direction of said axis of rotation when inwardly pressed.

3. A thermostat according to claim 2 wherein said thermostat housing is generally disk-like in shape with said front face thereof being circular, and wherein said mechanically rotatable ring is generally coincident with an outer lateral periphery of said disk-like shape.

4. A thermostat according to claim 1 wherein said thermostat is configured such that said rotational input motions and said inward pressings of the ring-shaped user-interface component represent the sole physical user inputs to said thermostat.

5. A thermostat according to claim 1 wherein the predetermined time interval is at least about 1 hour and less than about 4 hours.

6. A thermostat according to claim 5 wherein the predetermined time interval is at least 1.5 hours and less than about 3 hours.

7. A thermostat according to claim 1 wherein the electronic display is further configured to display to a user a notification relating to the generating of the schedule.

8. A thermostat according to claim 1 wherein the processing system is still further configured such that in cases where two or more immediate control setpoint temperature changes are identified within a short time interval of less than 90 minutes, the generating of the schedule is based on a latest of the two or more identifications.

9. A thermostat according to claim 1 wherein the processing system is still further configured such that the automatic resetting of the setpoint temperature is to a base setpoint temperature of lower than 68 degrees Fahrenheit at times when the HVAC system uses heating and to a base setpoint temperature of greater than 78 degrees Fahrenheit at time when the HVAC system uses cooling.

10. A thermostat according to claim 1 wherein the processing system is still further configured such that the generated schedule is automatically adopted as an active schedule for the programmable thermostat.

11. A method for generating a schedule for a programmable thermostat used for control of an HVAC system, the thermostat comprising a housing, a ring-shaped user interface component, a processing system, and an electronic display, the method comprising:

- accessing an ambient air temperature measured by one or more temperature sensors;
- detecting and tracking rotational movements of the ring-shaped user-interface component to track at least one rotational input motion of a user;

identifying a first setpoint temperature value based on the tracked rotational input motion at a first point in time;  
controlling the HVAC system based at least in part on a comparison of the measured ambient air temperature and the first setpoint temperature value for a predetermined time interval;  
automatically resetting the first setpoint temperature upon the ending of the predetermined time interval;  
identifying a second setpoint temperature value based on the tracked rotational input motion at a second point in time;  
controlling the HVAC system based at least in part on a comparison of the measured ambient air temperature and the second setpoint temperature value for the predetermined time interval;  
automatically resetting the second set point temperature upon the ending of the predetermined time interval;  
generating with the processing system, a schedule for the programmable thermostat based at least in part on the first and second setpoints and the first and second points in time; and  
displaying information representative of the first and second identified setpoint temperature values on the electronic display.

**12.** A method according to claim **11** wherein the predetermined time interval is at least about 30 minutes and less than about 6 hours.

**13.** A method according to claim **12** wherein the predetermined time interval is about 2 hours.

**14.** A method according to claim **11** wherein the resetting of the first and second set points resets the set point temperature back to a base set point temperature.

**15.** A method according to claim **14** further comprising determining whether the enclosure will likely use heating based at least in part on the time of year and the geographic location of the enclosure.

**16.** A method according to claim **15** wherein the base set point temperature is lower than 65 degrees Fahrenheit, at times when it is likely that the enclosure will use heating.

**17.** A method according to claim **15** wherein the base set point temperature is greater than 78 degrees Fahrenheit, at times when it is likely that the enclosure will use cooling.

**18.** A method according to claim **11** further comprising displaying on the electronic display a notification indicating that the schedule has been generated.

**19.** A method according to claim **11** wherein the resetting of the first and second setpoints resets the setpoint temperature back to a preexisting schedule.

**20.** A method according to claim **11** further comprising automatically adopting the generated schedule as an active schedule for the programmable thermostat.

**21.** A method according to claim **11** further comprising:  
displaying on the electronic display a notification indicating that the schedule has been generated; and  
identifying user input as to whether or not to adopt the generated schedule as an active schedule.

**22.** A method according to claim **11** further comprising:  
displaying on a remote user interface a notification indicating that the schedule has been generated; and  
identifying using the remote user interface a user's desire whether or not to adopt the generated schedule as an active schedule.

**23.** A thermostat comprising:

a disk-like housing including a circular front face;  
an electronic display centrally disposed on the front face;  
an annular ring member disposed around the centrally disposed electronic display, said annular ring member and said housing being mutually configured such that (i) said annular ring member is rotatable around a front-to-back axis of the thermostat, and (ii) said annular ring member is inwardly pressable along a direction of the front-to-back axis;

a processing system disposed within the housing and coupled to the annular ring member;

said processing system being configured and programmed to dynamically alter a setpoint temperature value based on a user rotation of the annular ring member;

said processing system being further configured to be in operative communication with one or more temperature sensors for receiving an ambient air temperature, said processing system being still further configured to be in operative communication with an HVAC system to control the HVAC system based at least in part on a comparison of the measured ambient temperature and the setpoint temperature value;

said processing system being still further configured to identify from the annular ring member user input relating to the user's preference regarding automatically generating a schedule and to determine therefrom whether or not to automatically adopt an automatically generated schedule.

**24.** A thermostat according to claim **23** wherein the identified user input identifies whether or not an automatically generated schedule should be automatically adopted.

**25.** A thermostat according to claim **23** wherein the identified user input identifies whether or not the user prefers to receive future notifications regarding the adoption of an automatically generated schedule.

**26.** A thermostat according to claim **25** wherein the processing system is still further configured to based at least in part on the identified user input, determine whether or not to notify the user of an automatically generated schedule that the user may wish to adopt.

**27.** A thermostat according to claim **26** wherein the determination of whether or not to notify the user is based in part on an estimated of saving of cost and/or energy associated with the automatically generated schedule.

**28.** A thermostat according to claim **23** wherein the identified user input identifies whether or not the user prefers to manually enter a schedule for the programmable thermostat.

**29.** A thermostat according to claim **23**, further comprising an audio output device coupled to said processing system, the thermostat being configured to output synthesized audible ticks through said audio output device in correspondence with user rotation of said mechanically rotatable ring.

**30.** A thermostat according to claim **23** further comprising the one or more temperature sensors, wherein said processing system is configured and programmed to send at least one control signal to the HVAC system based at least in part on the comparison of the measured ambient air temperature and the setpoint temperature value.