

US 20070225614A1

(19) **United States**

(12) **Patent Application Publication**  
**Naghavi et al.**

(10) **Pub. No.: US 2007/0225614 A1**

(43) **Pub. Date: Sep. 27, 2007**

(54) **METHOD AND APPARATUS FOR DETERMINING VASCULAR HEALTH CONDITIONS**

006, filed on Nov. 8, 2004. Provisional application No. 60/628,173, filed on Nov. 15, 2004.

(75) Inventors: **Morteza Naghavi**, Houston, TX (US);  
**Timothy J. O'Brien**, Anoka, MN (US);  
**Craig Jamieson**, Houston, TX (US);  
**Mark C. Johnson**, Houston, TX (US)

**Publication Classification**

(51) **Int. Cl.**  
*A61B 5/01* (2006.01)  
*A61B 5/00* (2006.01)  
(52) **U.S. Cl.** ..... **600/549**

Correspondence Address:

**WONG, CABELLO, LUTSCH, RUTHERFORD & BRUCCULERI, L.L.P.**  
**20333 SH 249**  
**SUITE 600**  
**HOUSTON, TX 77070 (US)**

(57) **ABSTRACT**

The present invention provides methods and apparatus for assessing a patient's vascular health including endothelial function by monitoring changes in hemodynamic parameters responsive to the introduction of a vasostimulant. The invention provides a thermal energy measurement apparatus including a thermal energy sensor adapted to measure temperature of a body part while not substantially changing the temperature of the body part, and a display or recorder coupled to the thermal energy sensor, wherein the thermal energy sensor measures the temperature of the body part before and subsequent to the provision of a vasostimulant, and the display or recorder reports the temperature of the body part prior to the provision of the stimulant and the temperature of the body part after provision of the stimulant. Also provided are methods and apparatus providing for a second thermal energy sensor on a corresponding contralateral site to the site subject to the vasostimulant and simultaneously monitoring and recording of temperature of the contralateral site as a measure of neurovascular status and microvascular reactivity.

(73) Assignee: **ENDOTHELIX, INC.**, Houston, TX (US)

(21) Appl. No.: **11/563,676**

(22) Filed: **Nov. 27, 2006**

**Related U.S. Application Data**

(63) Continuation-in-part of application No. PCT/US05/18437, filed on May 25, 2005.

(60) Provisional application No. 60/585,773, filed on Jul. 6, 2004. Provisional application No. 60/574,255, filed on May 26, 2004. Provisional application No. 60/626,

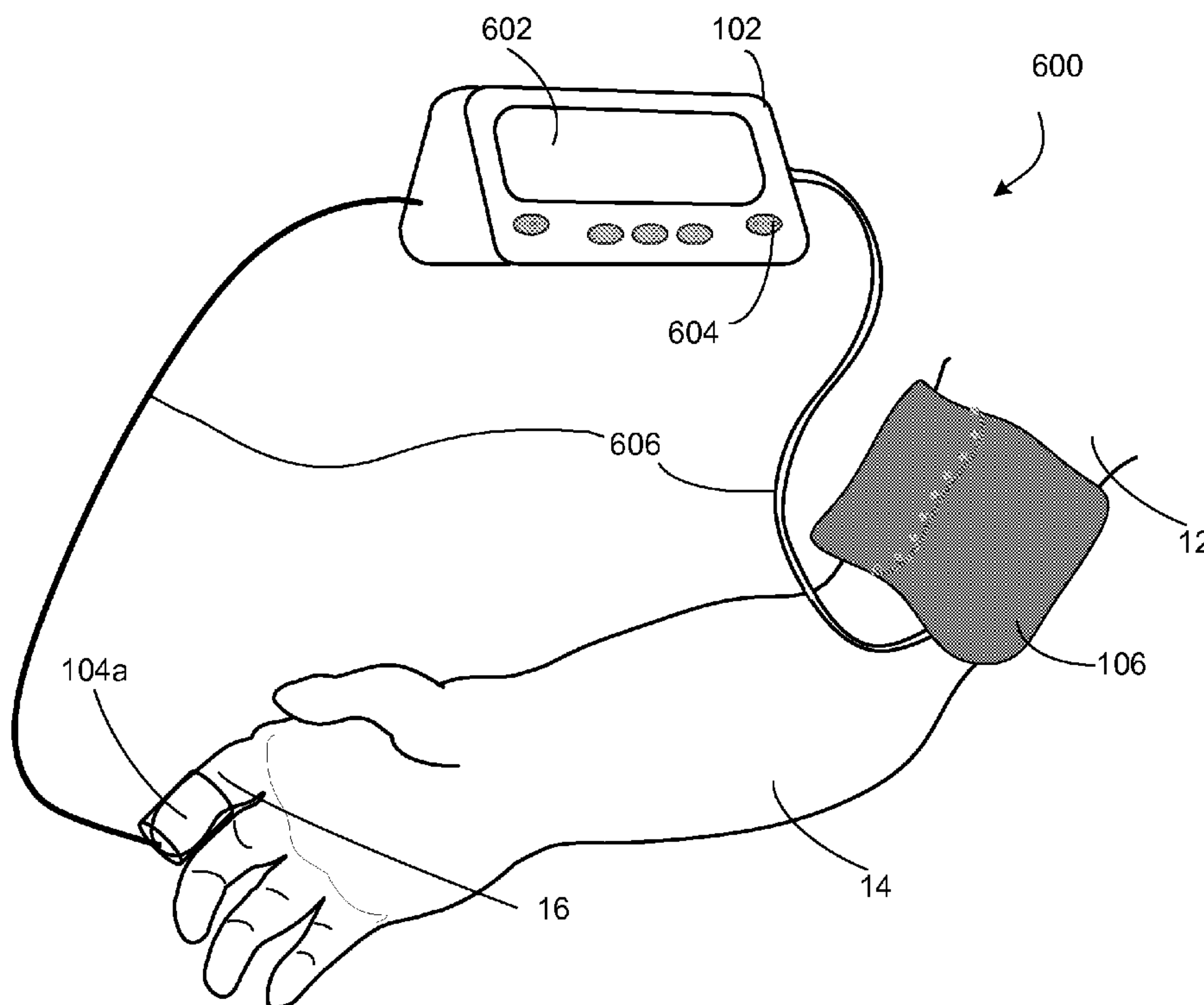

Figure 1

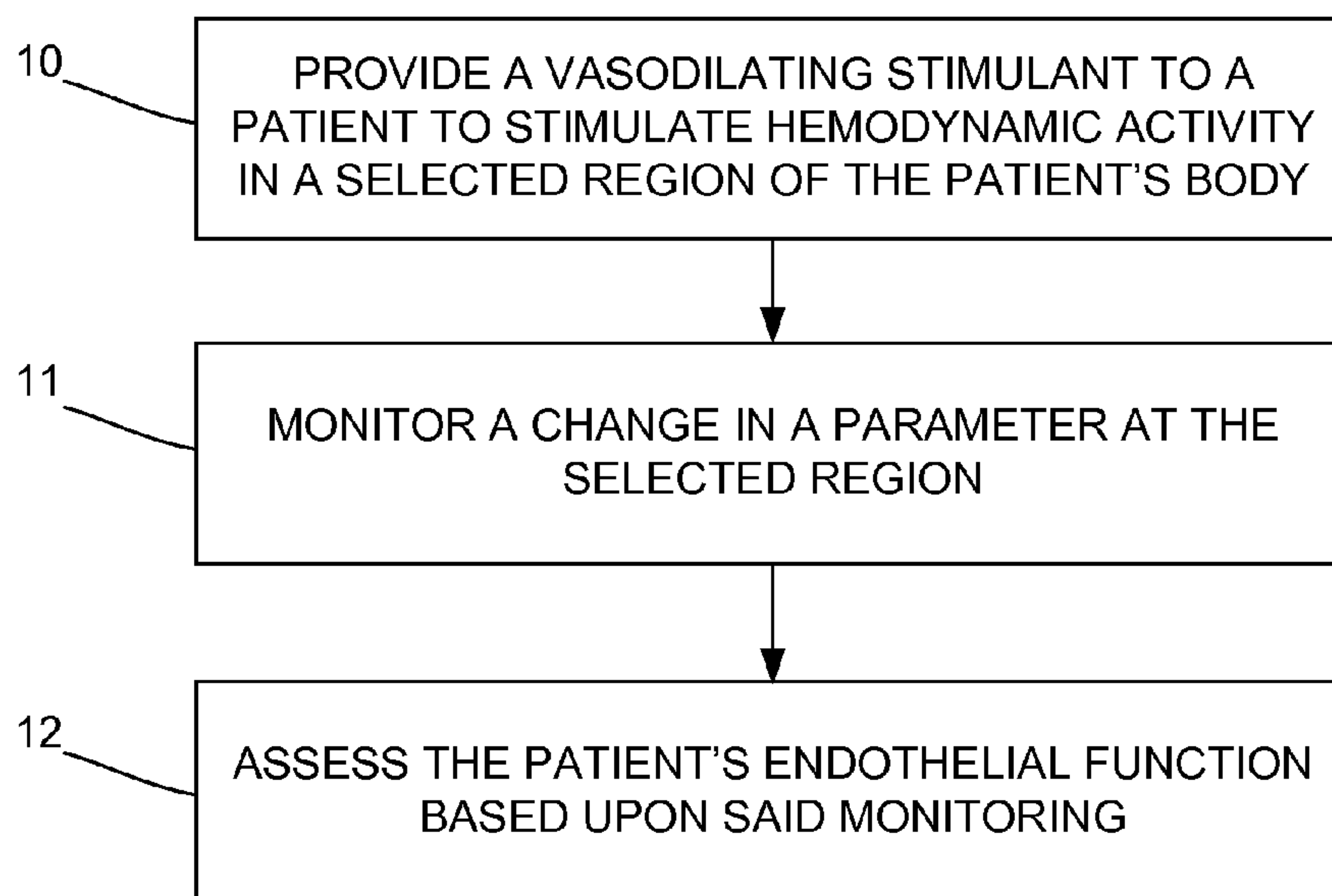

Figure 2

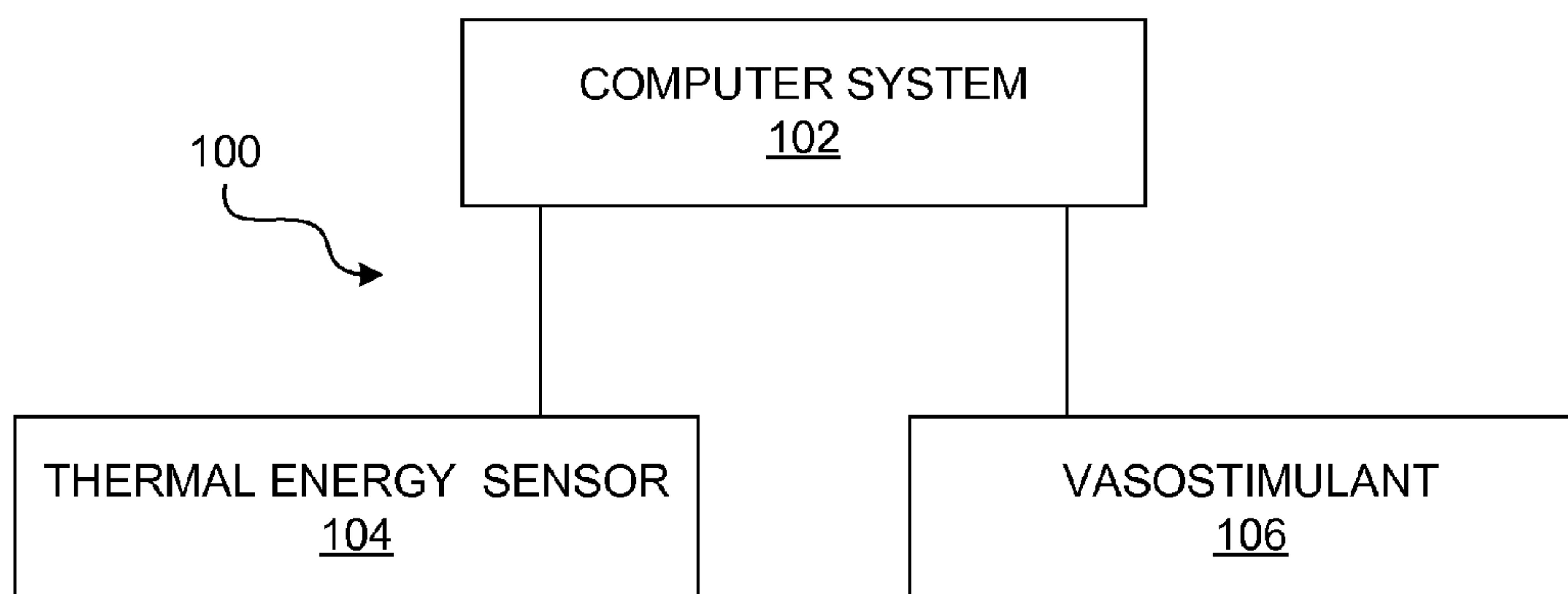

Figure 3

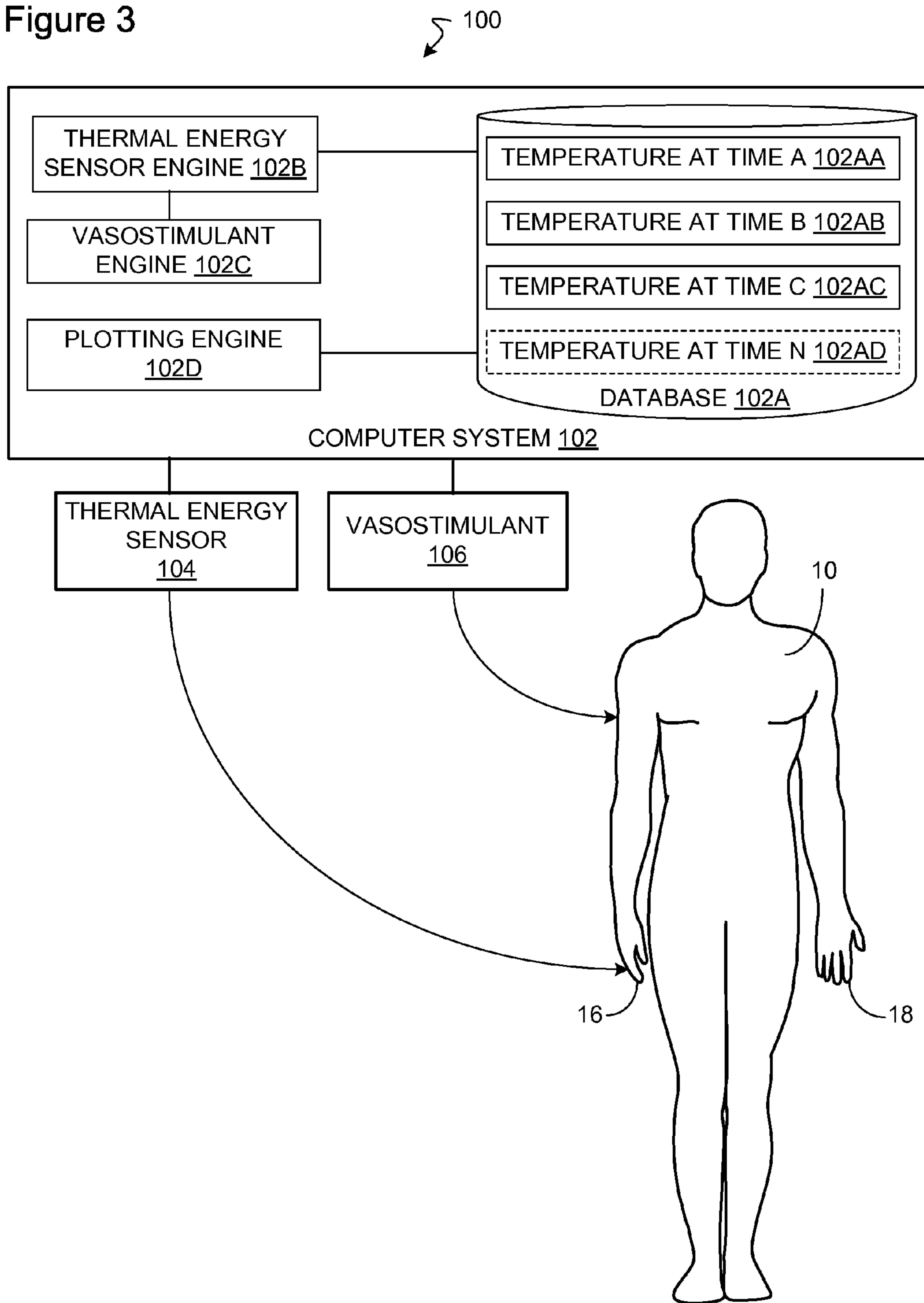

Figure 4b

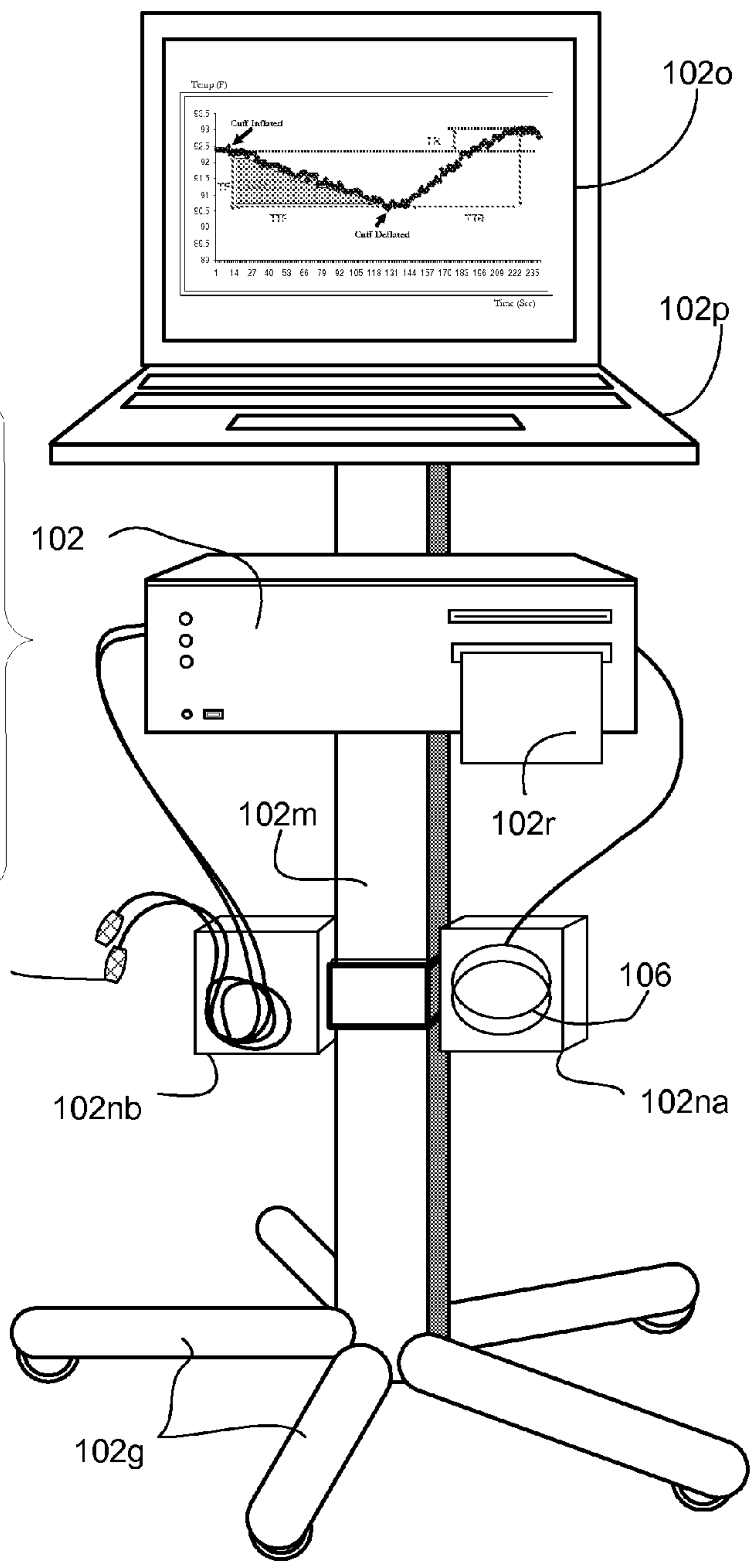

Figure 4a

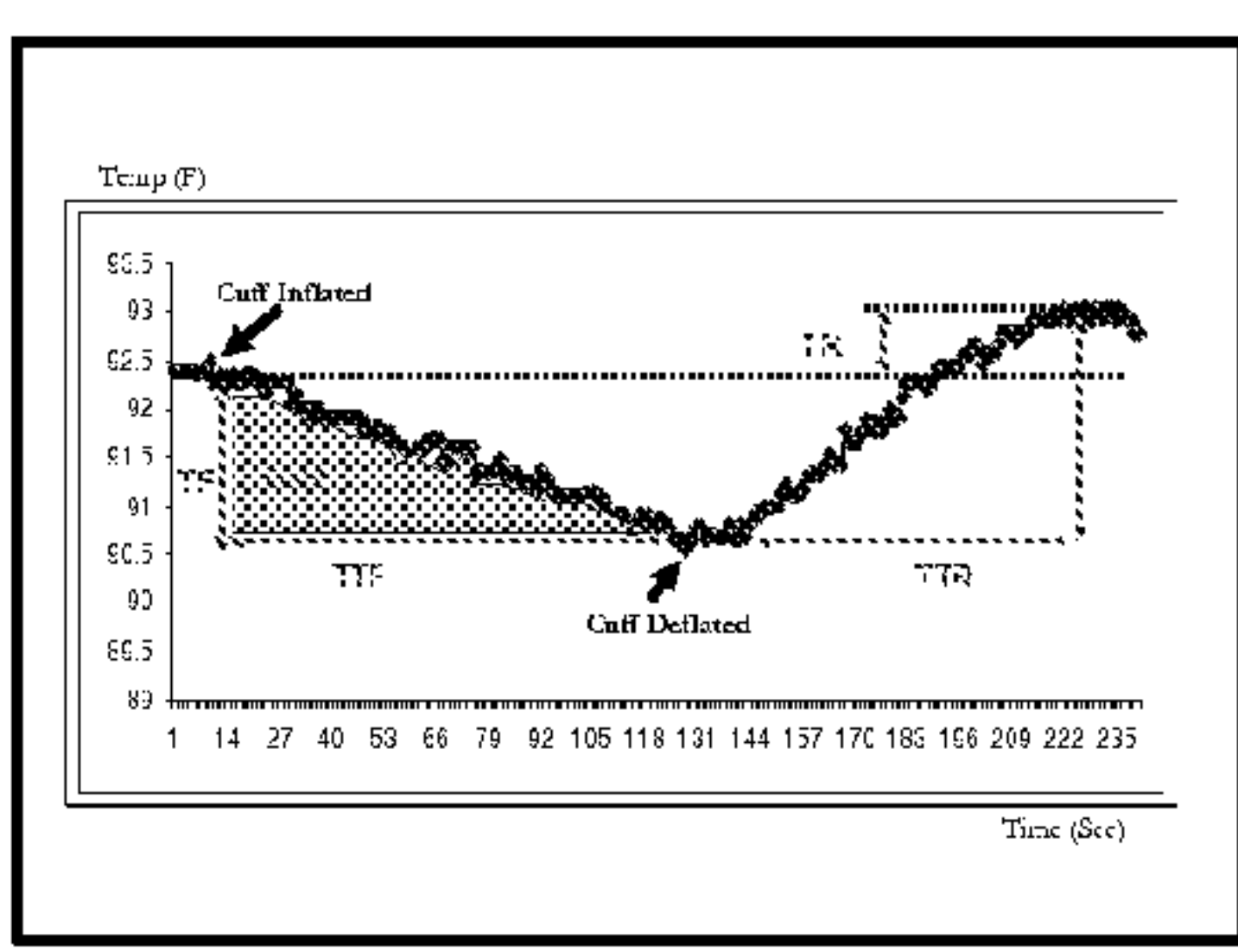
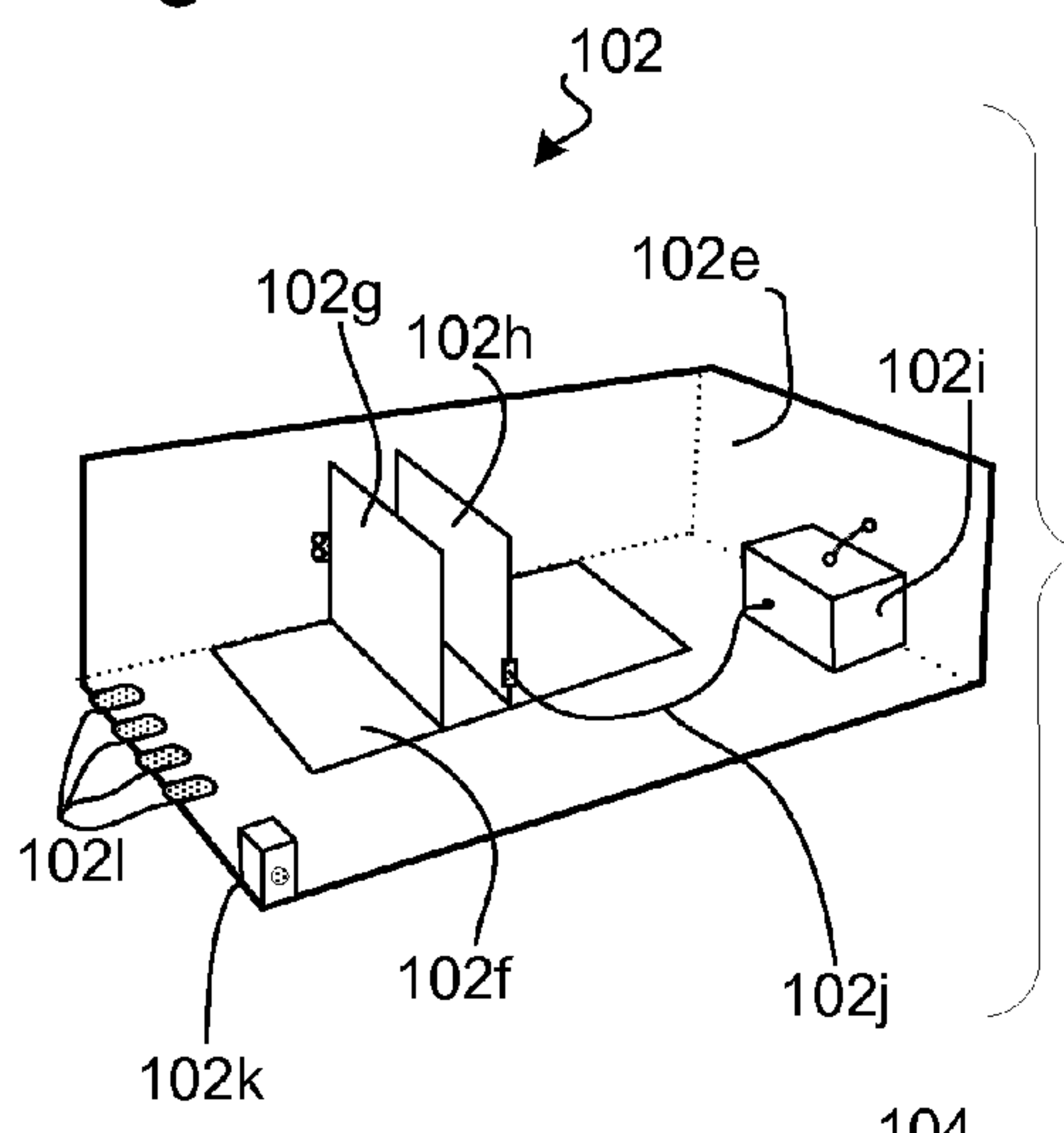

Figure 5

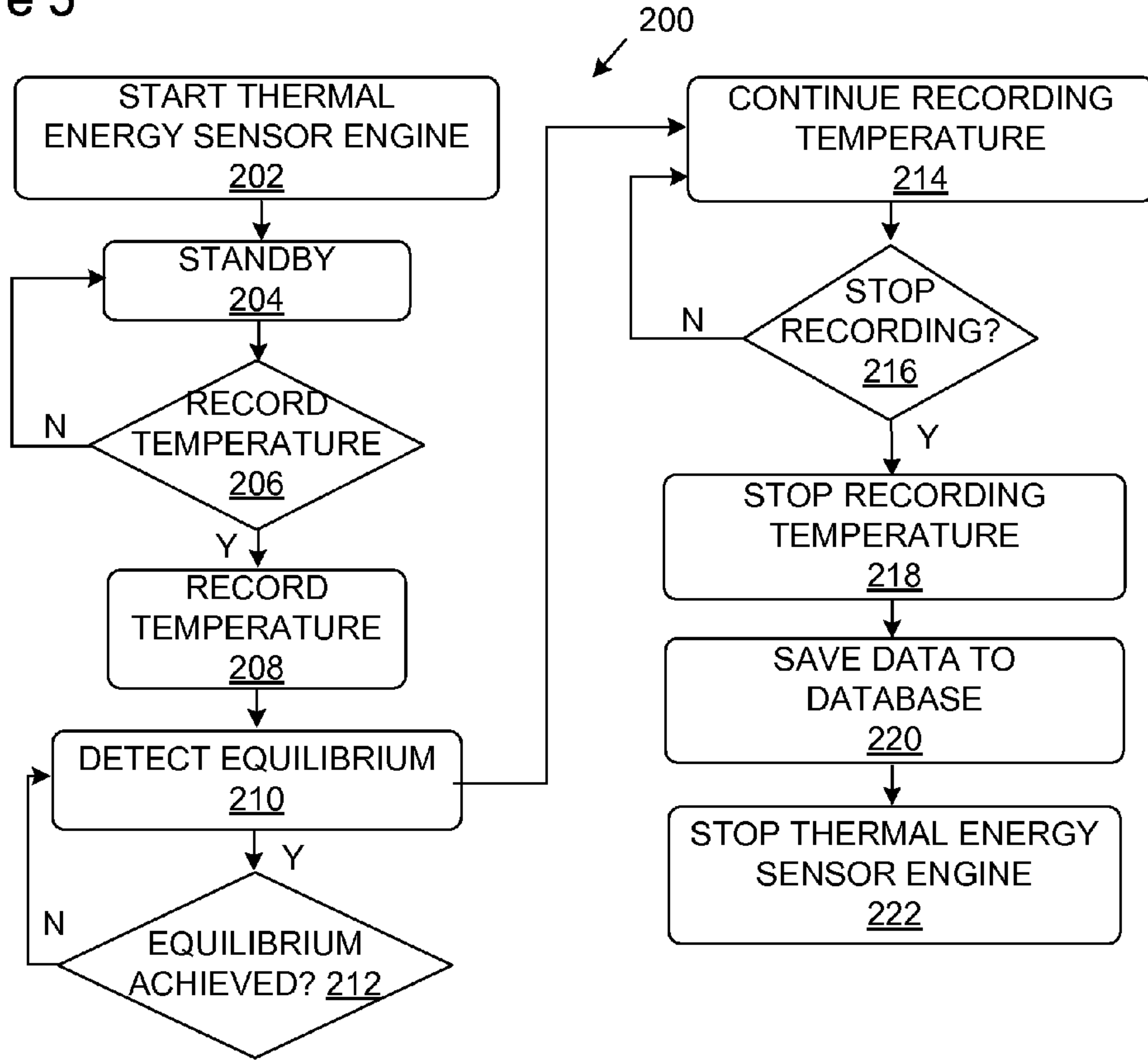

Figure 6

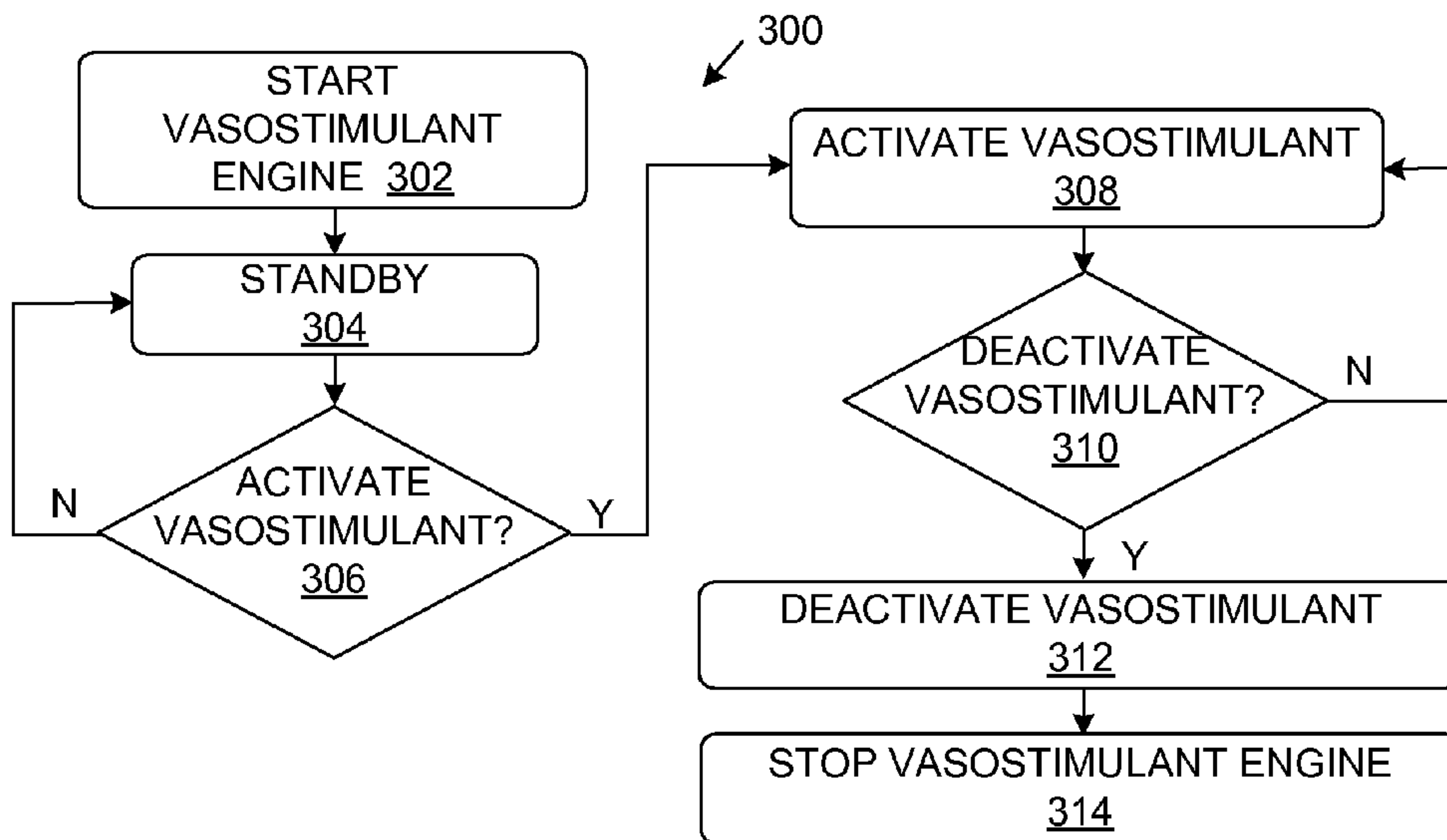



Figure 7

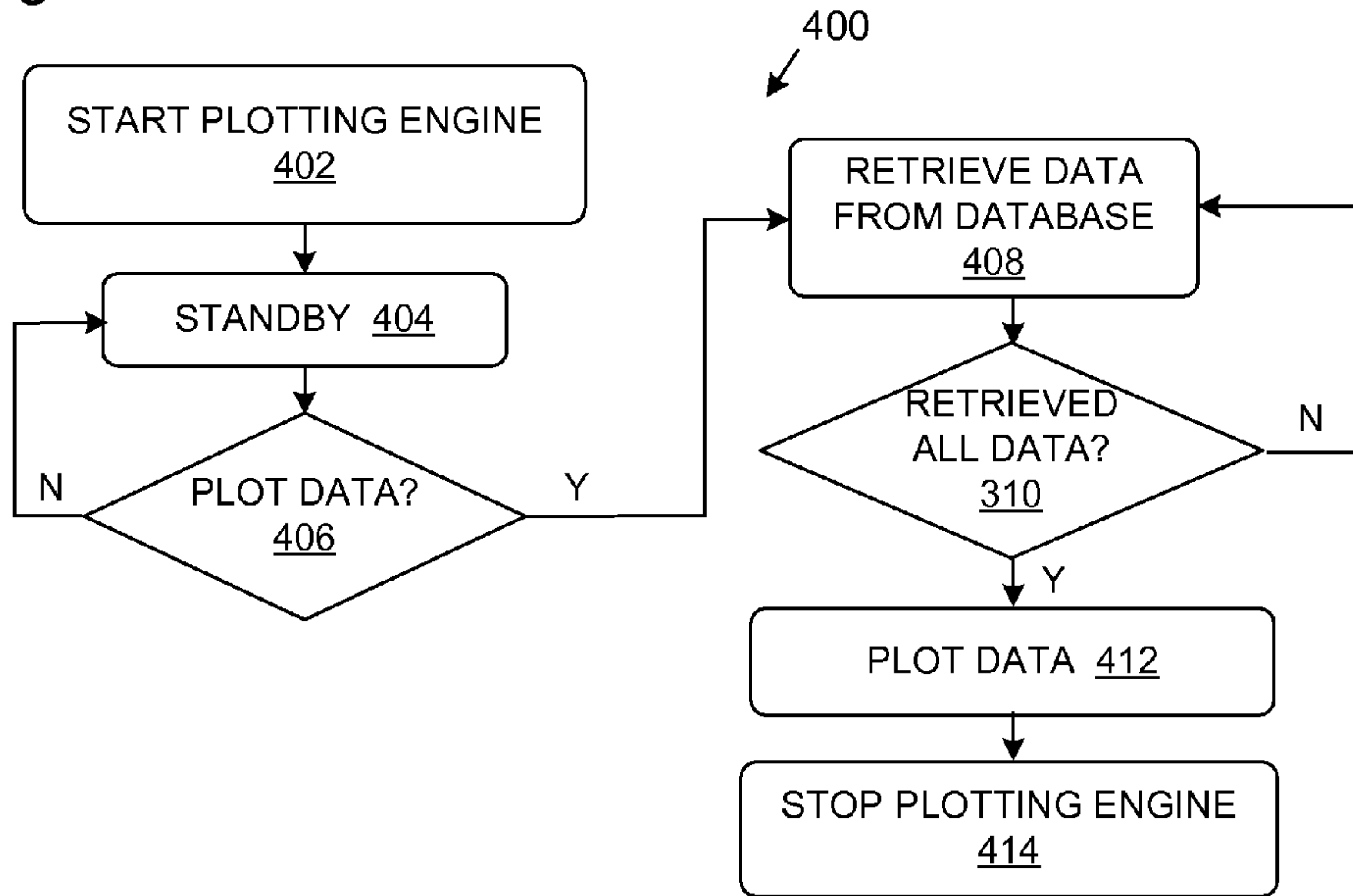

Figure 8

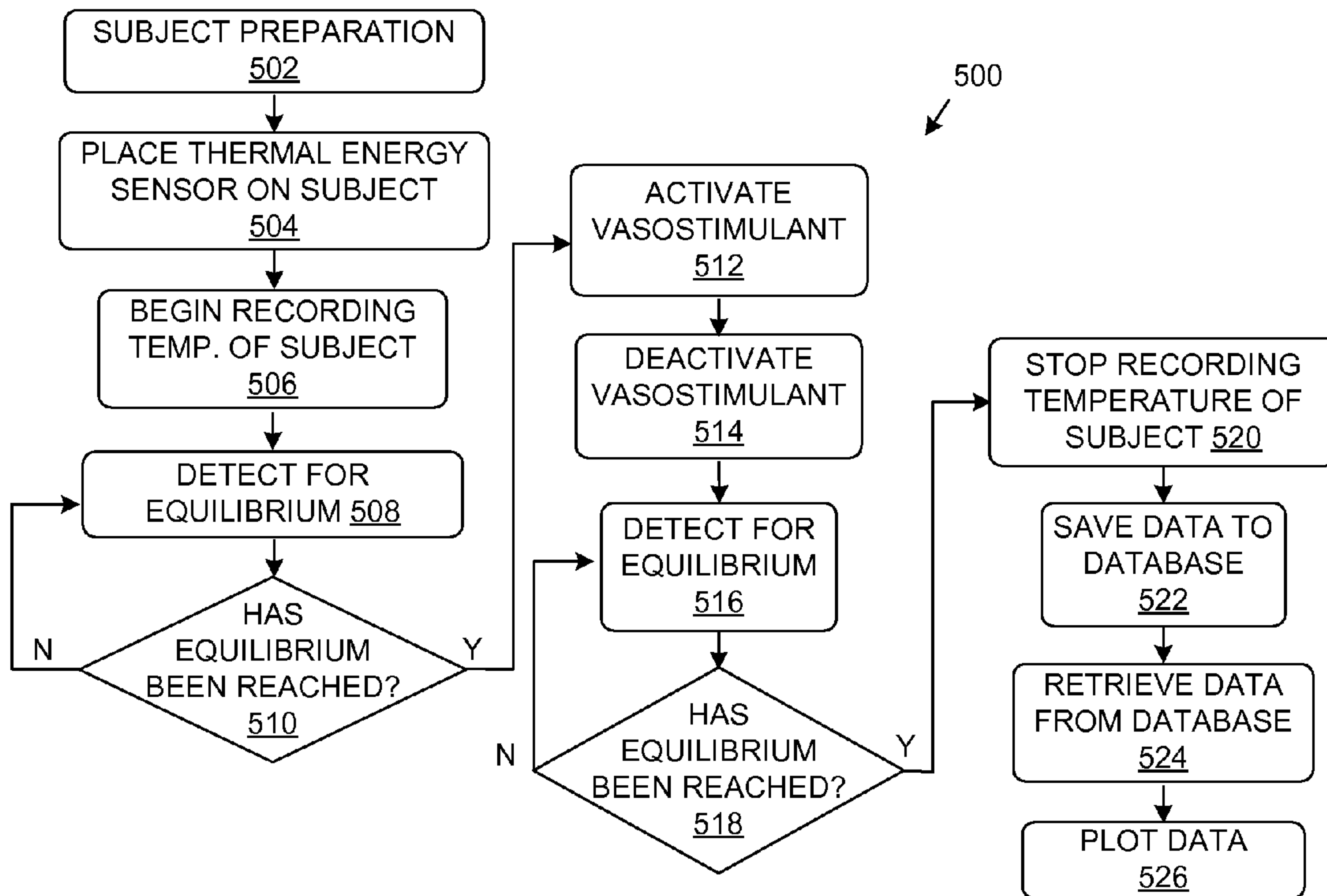

Figure 9a

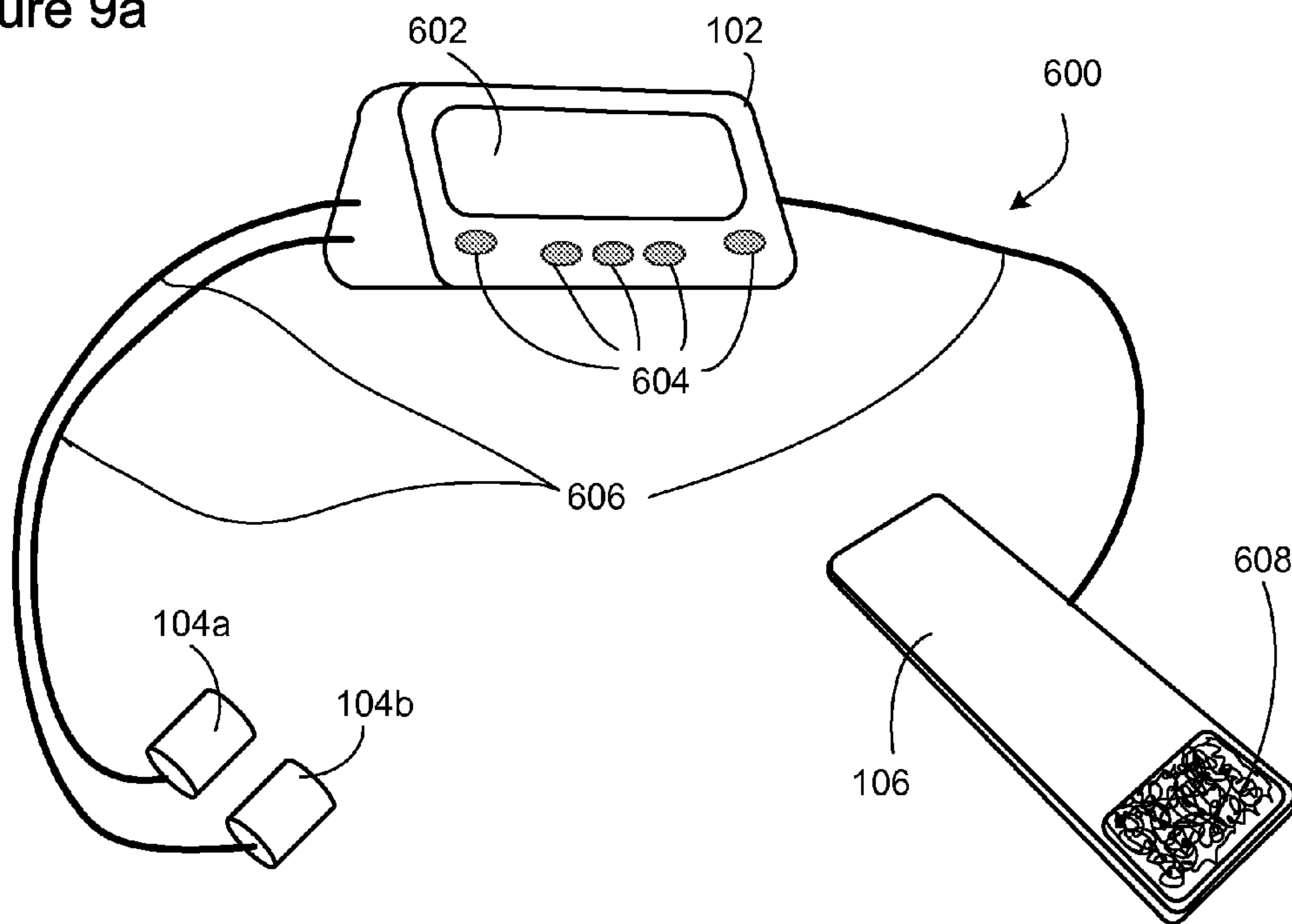

Figure 9b

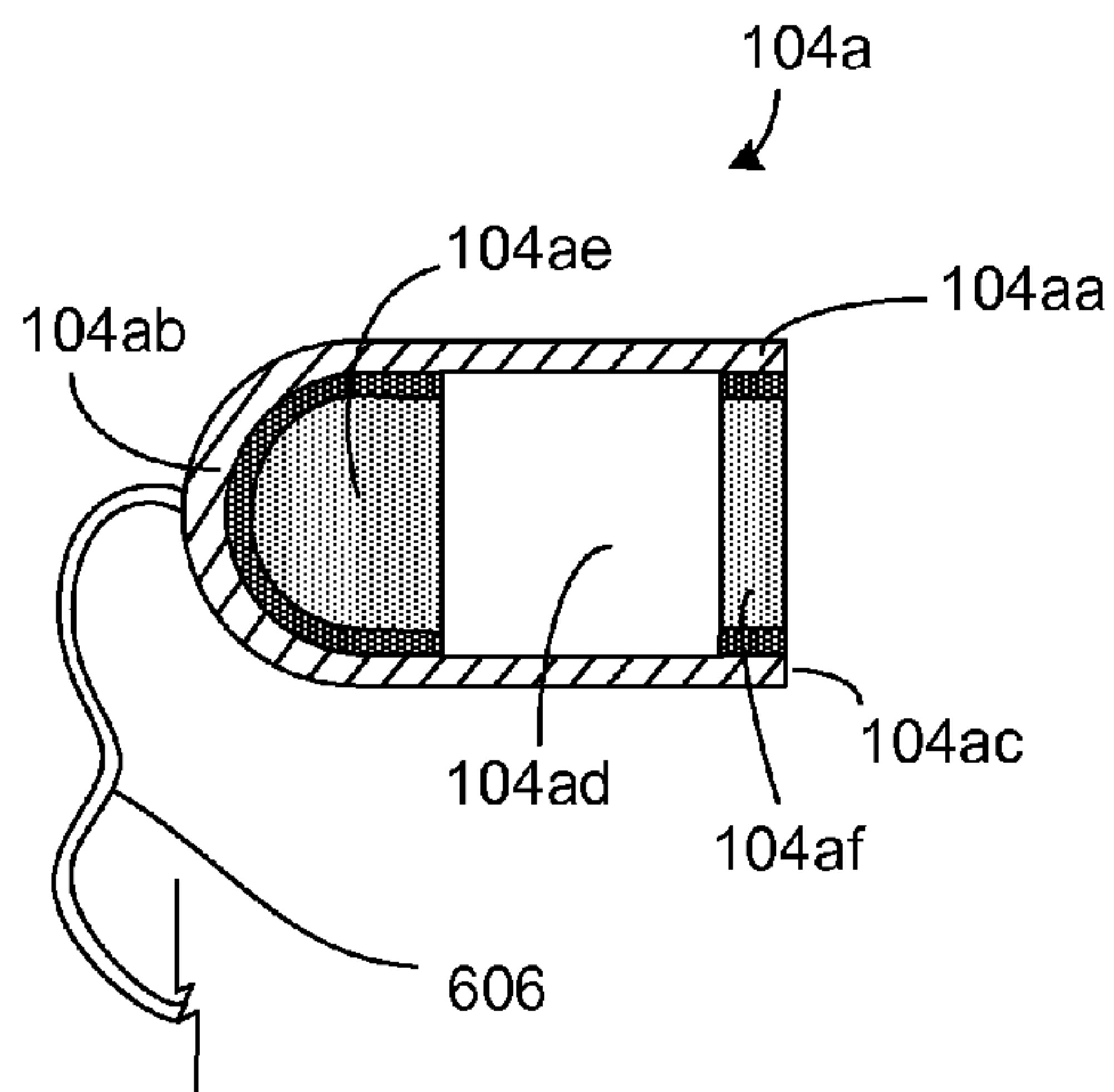

Figure 10a

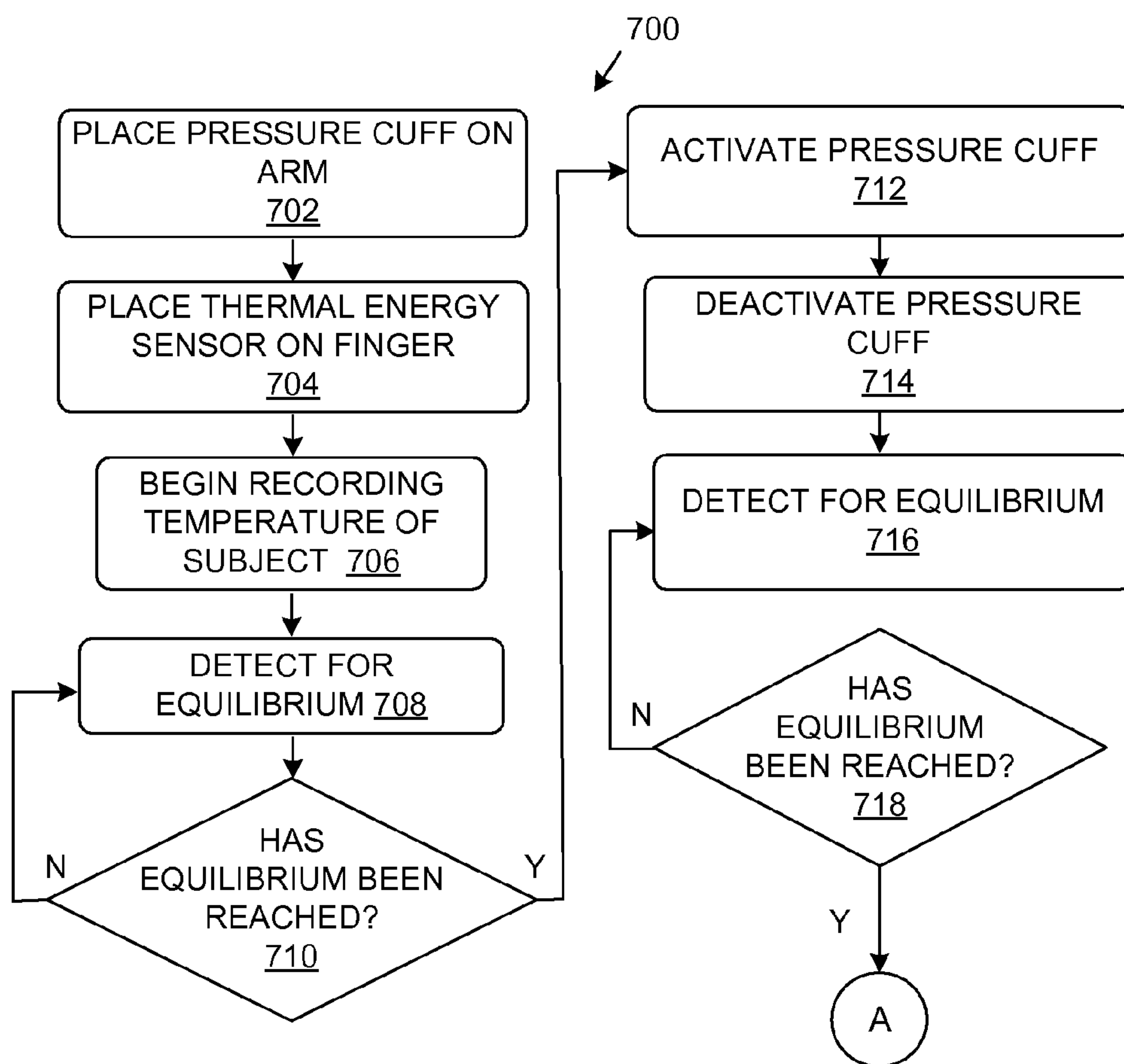

Figure 10b

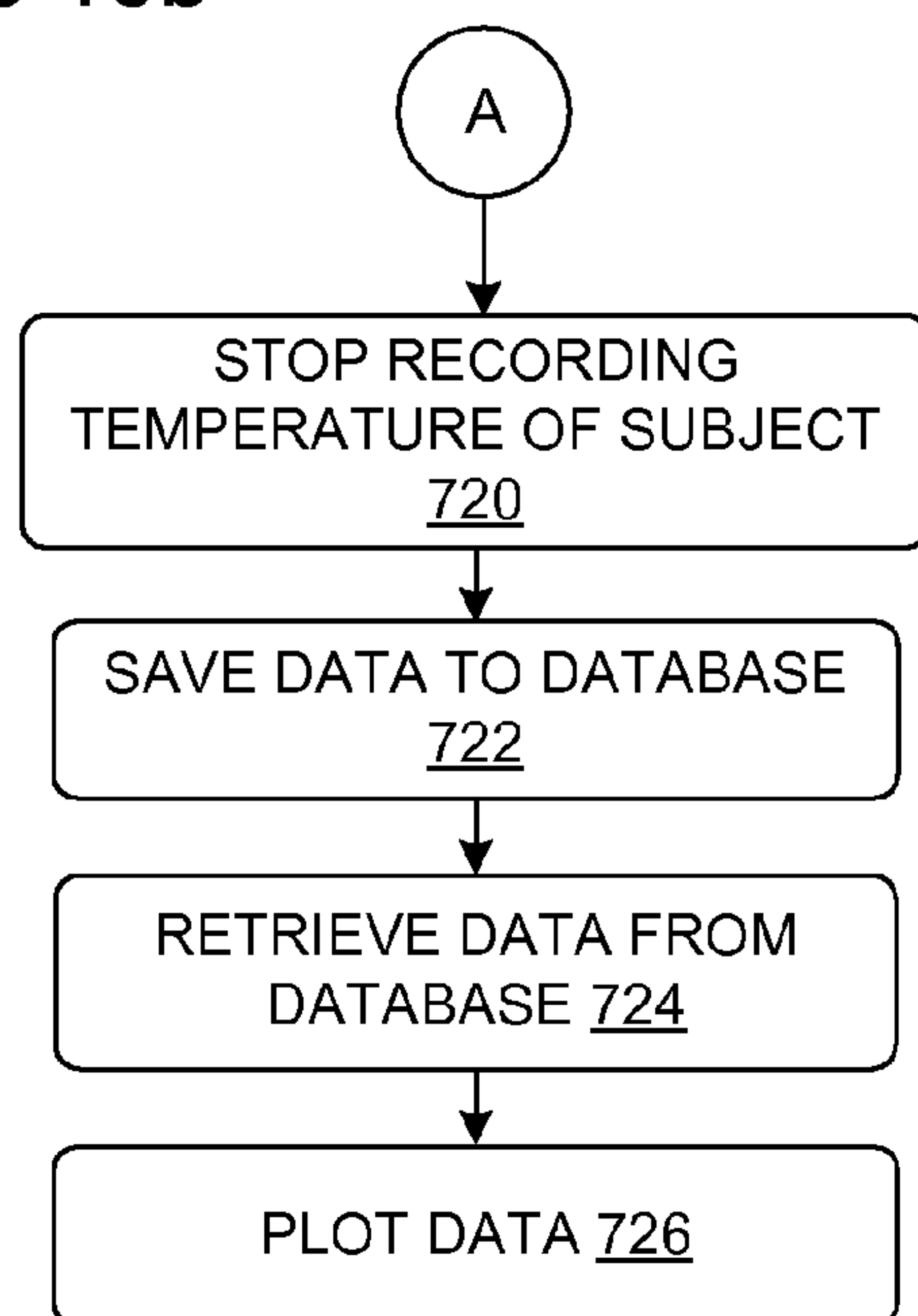



Figure 10c

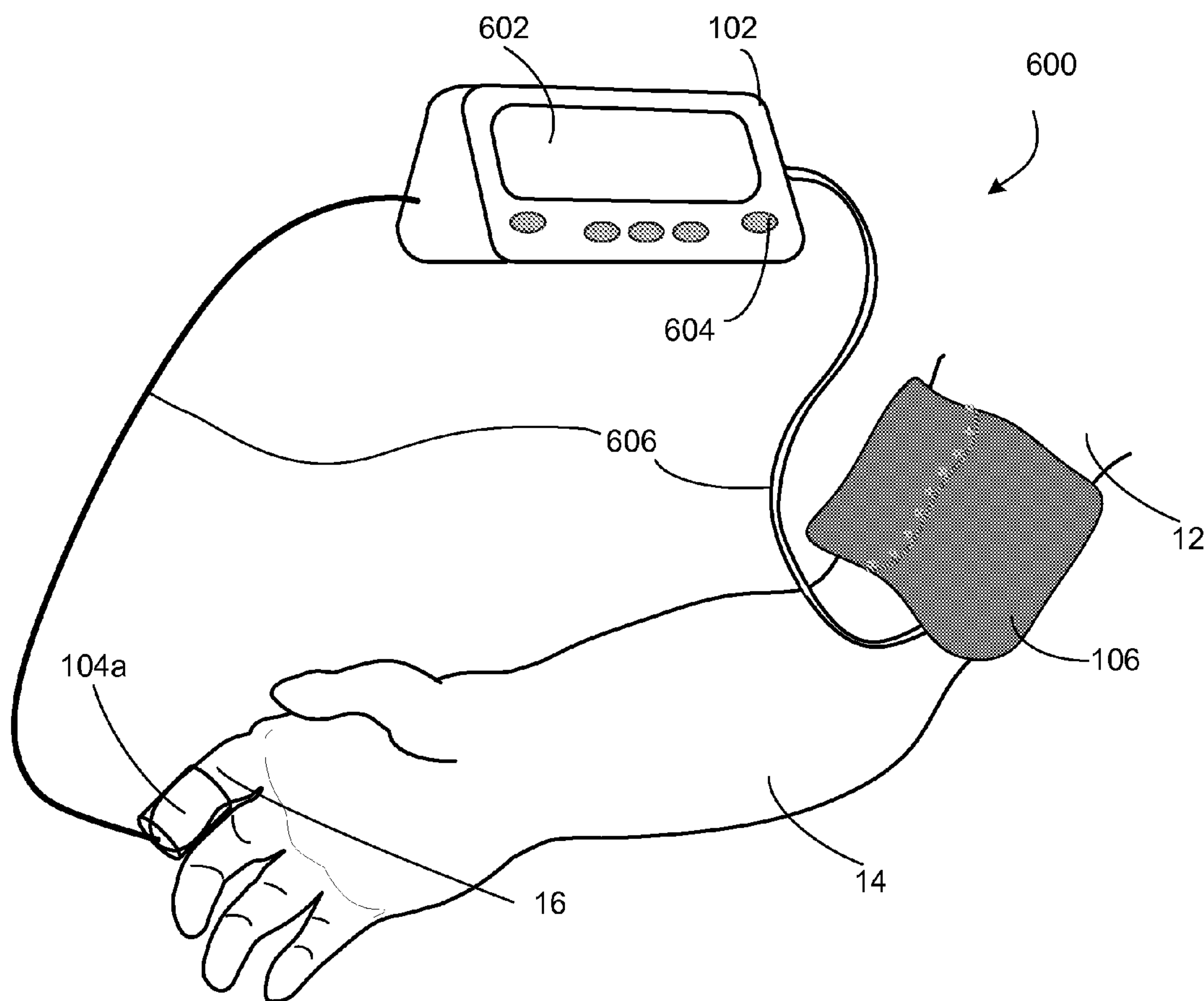

Figure 10d

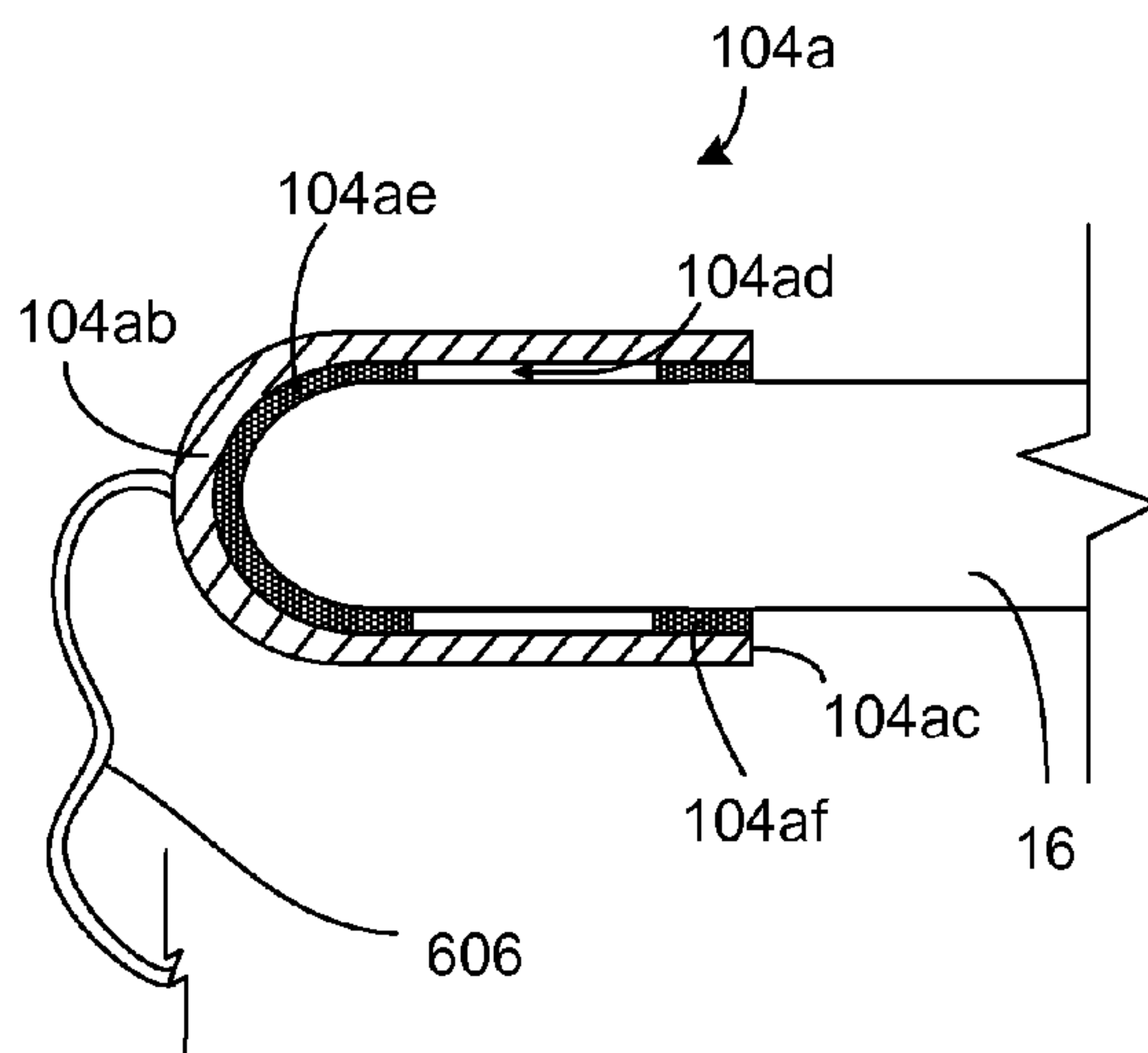

Figure 11a

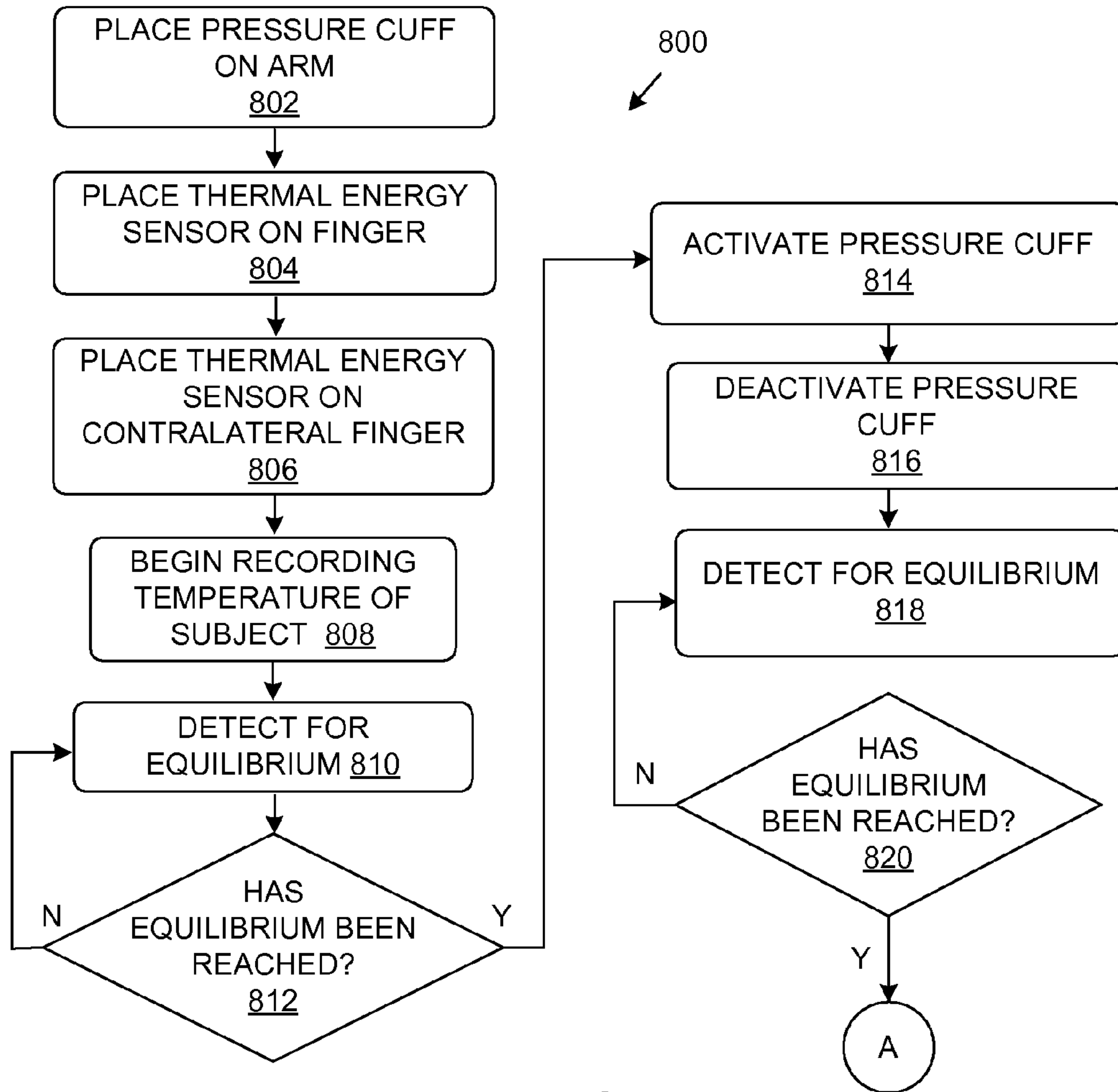
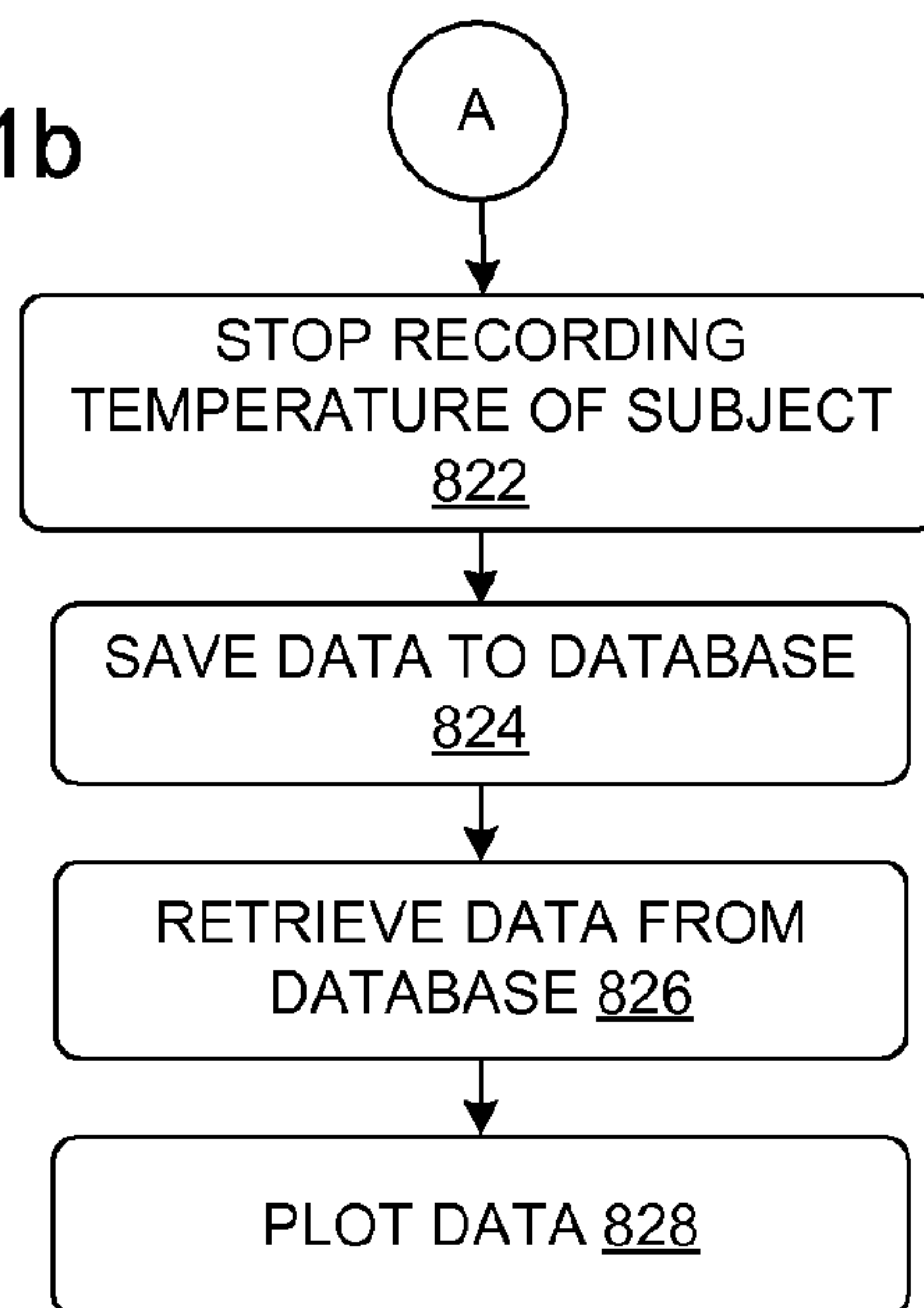

Figure 11b



11c

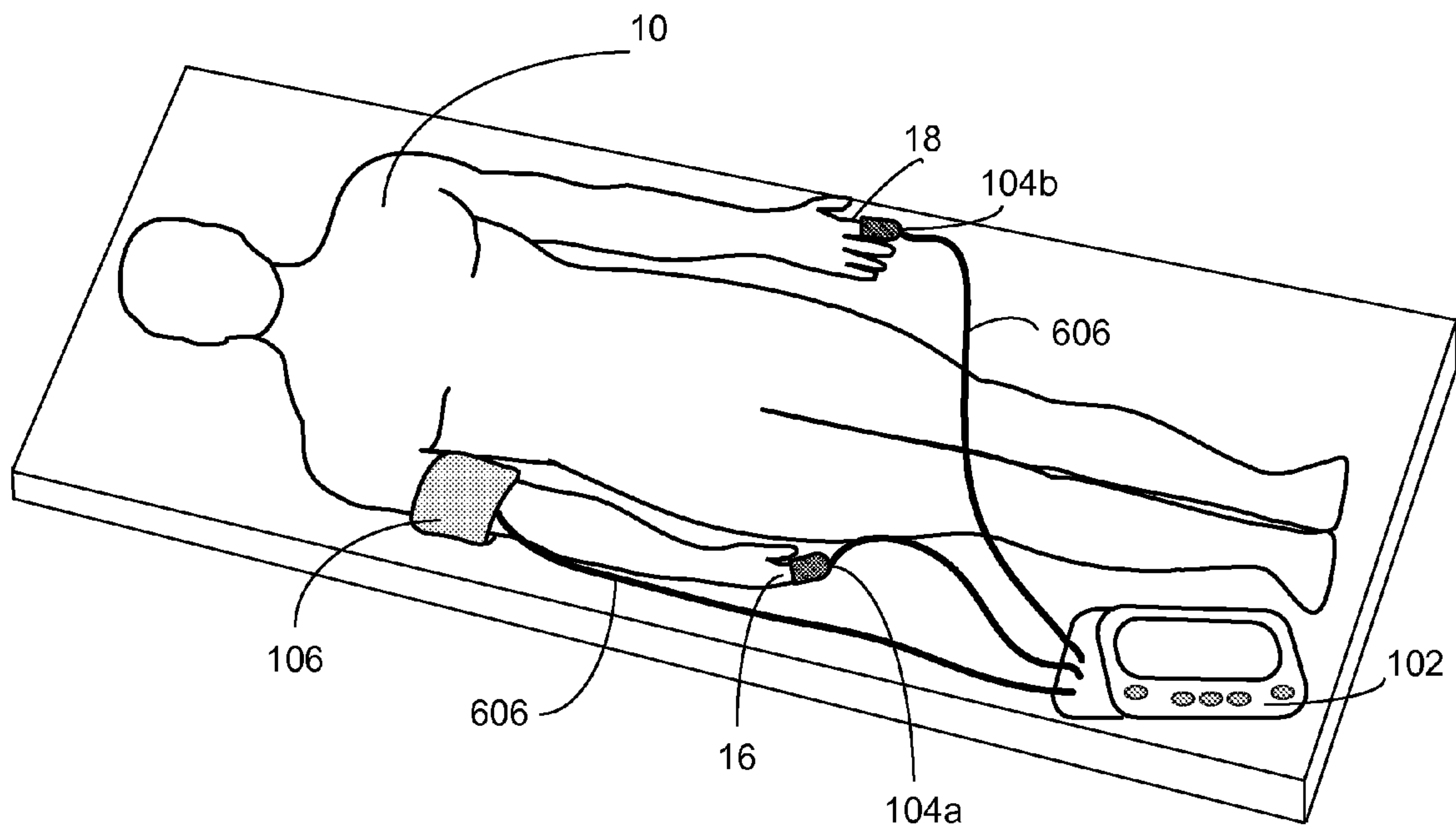

Figure 12a

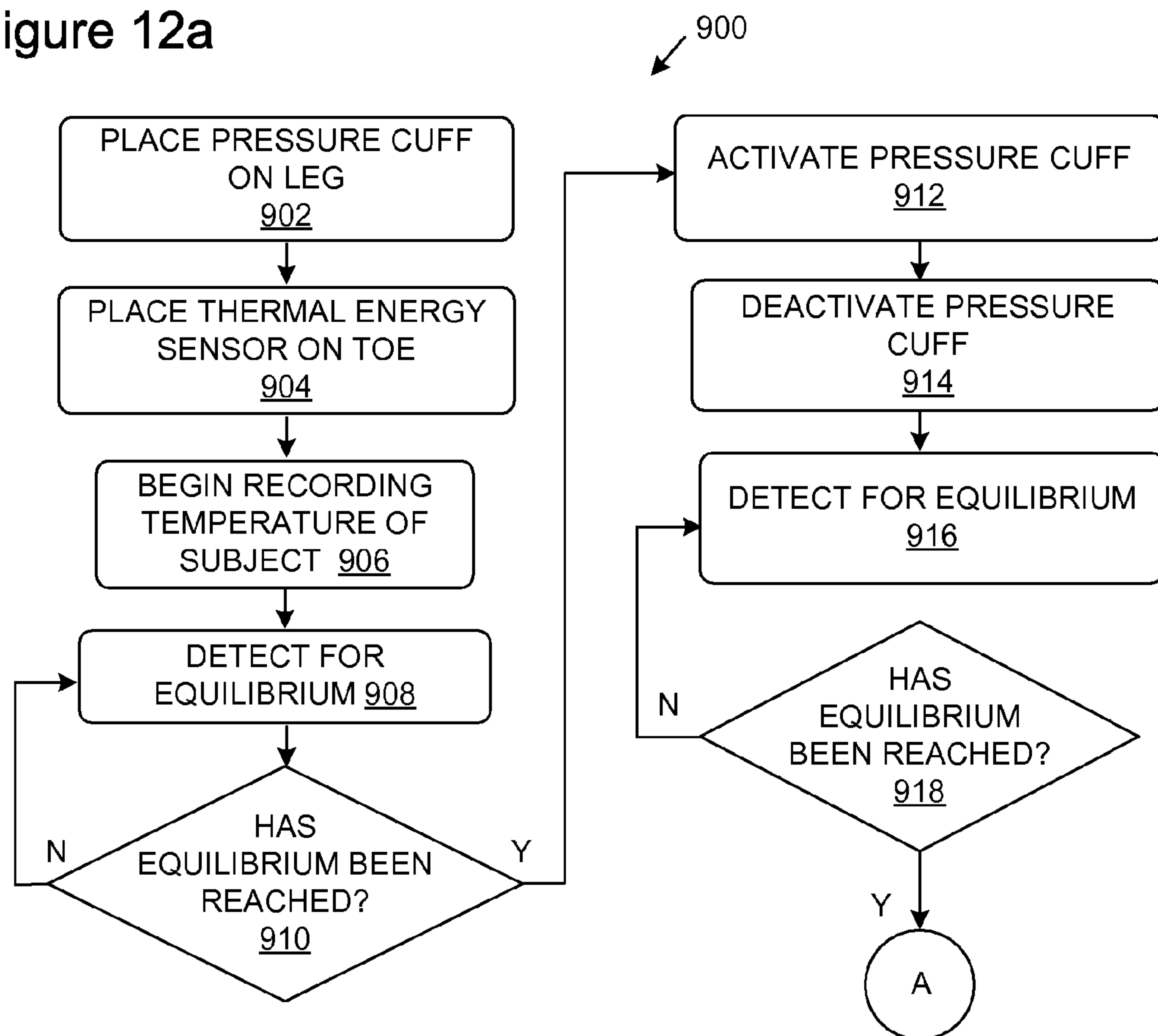

Figure 12b

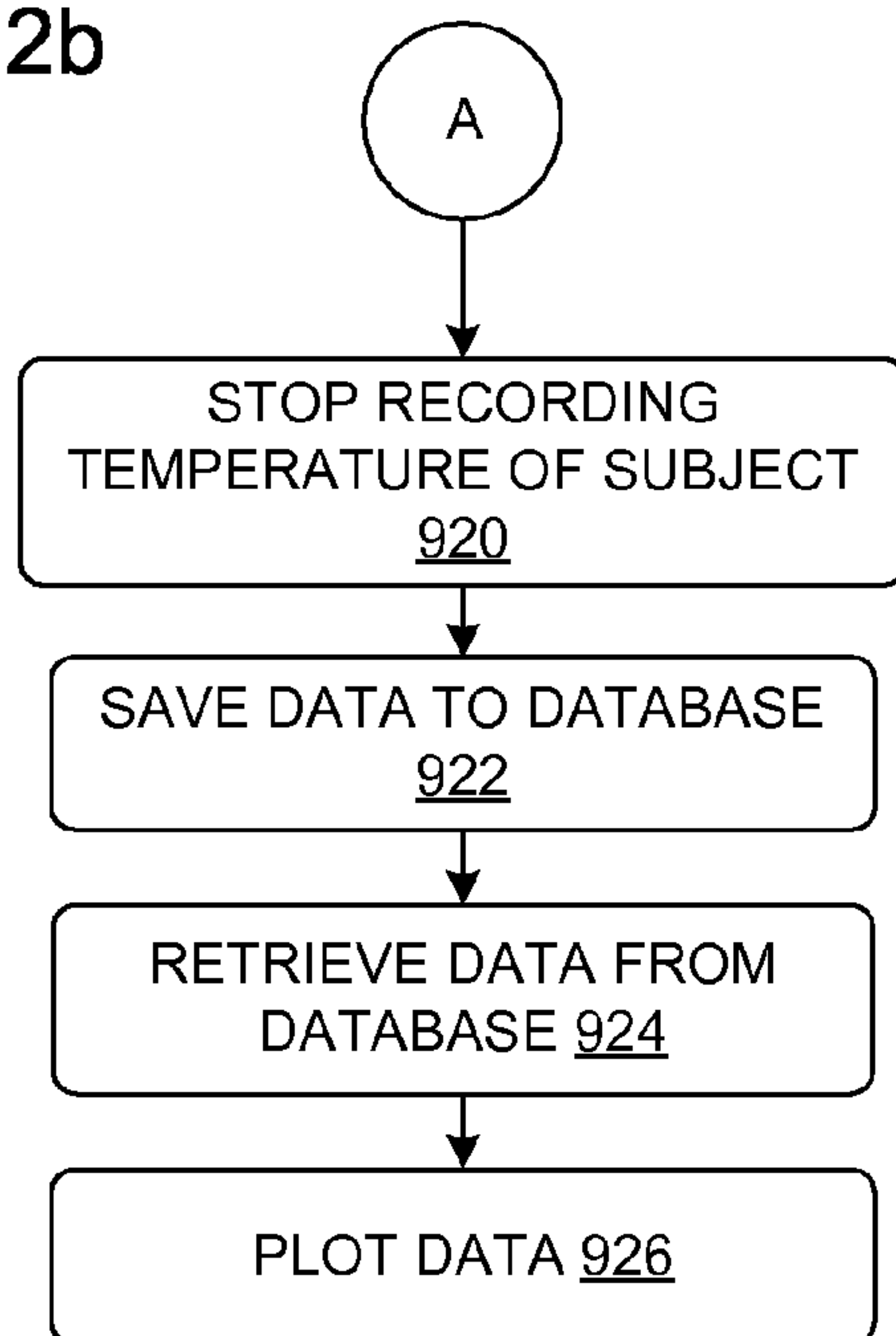

Figure 12c

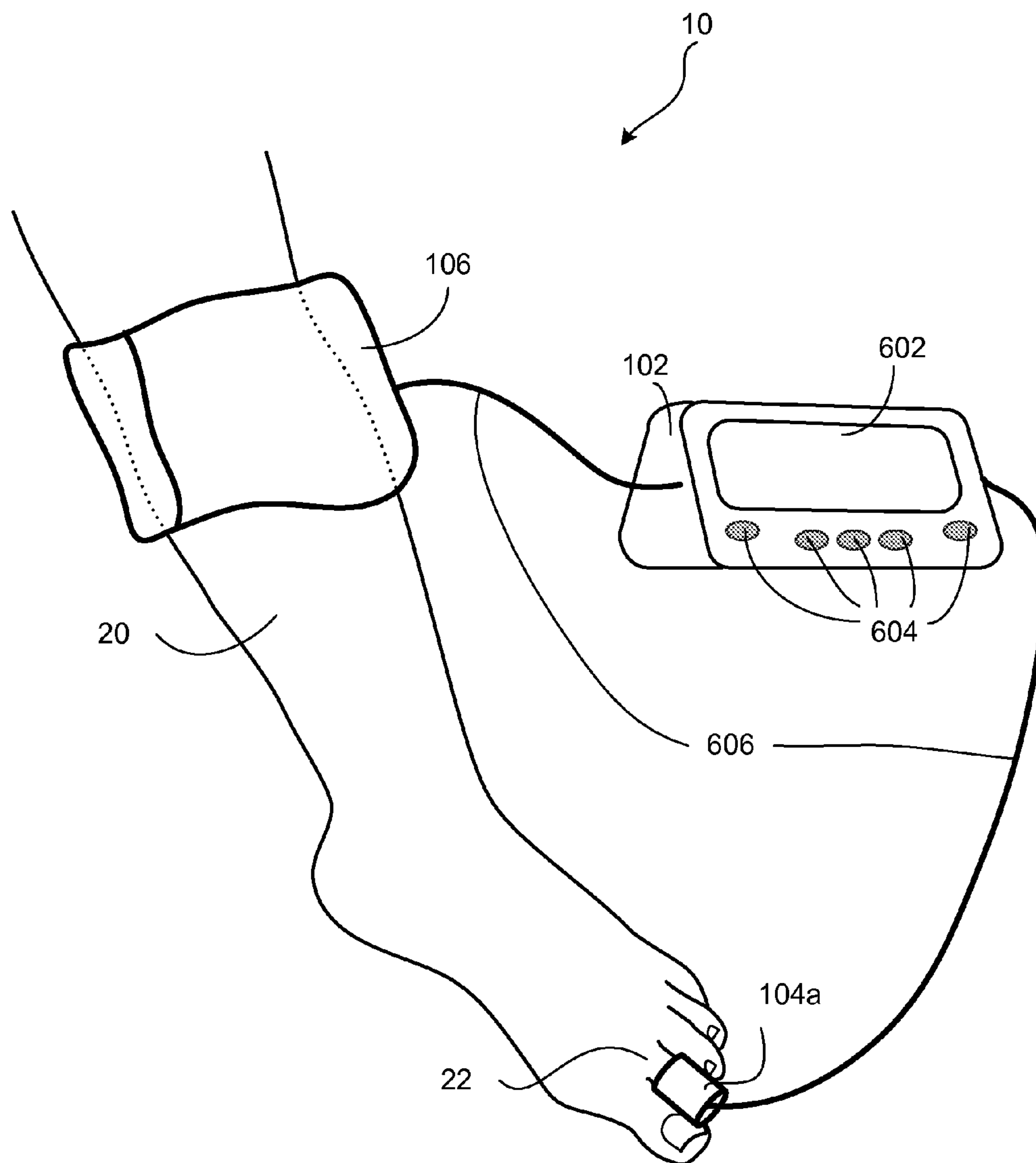

Figure 13

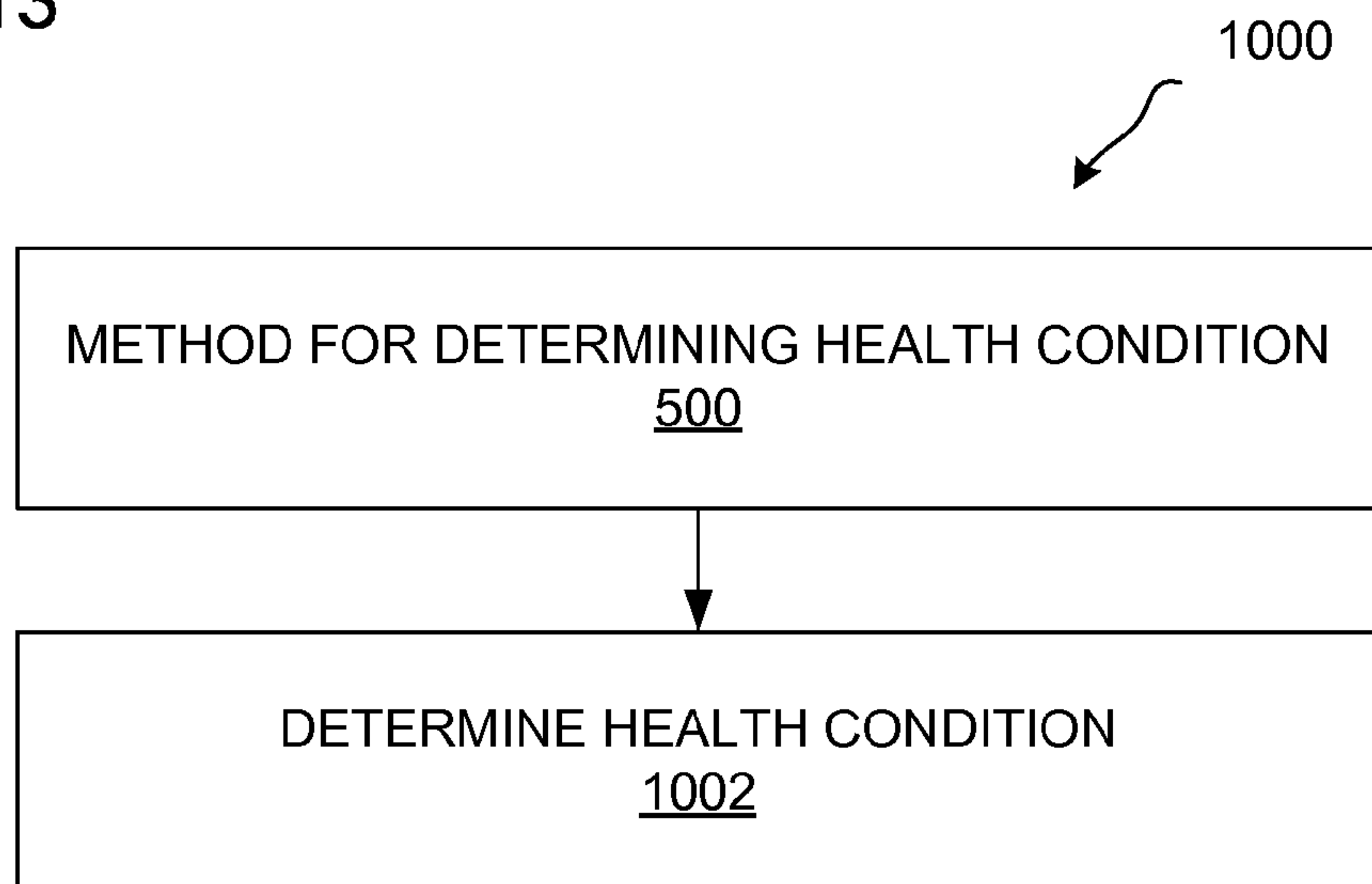

Figure 14

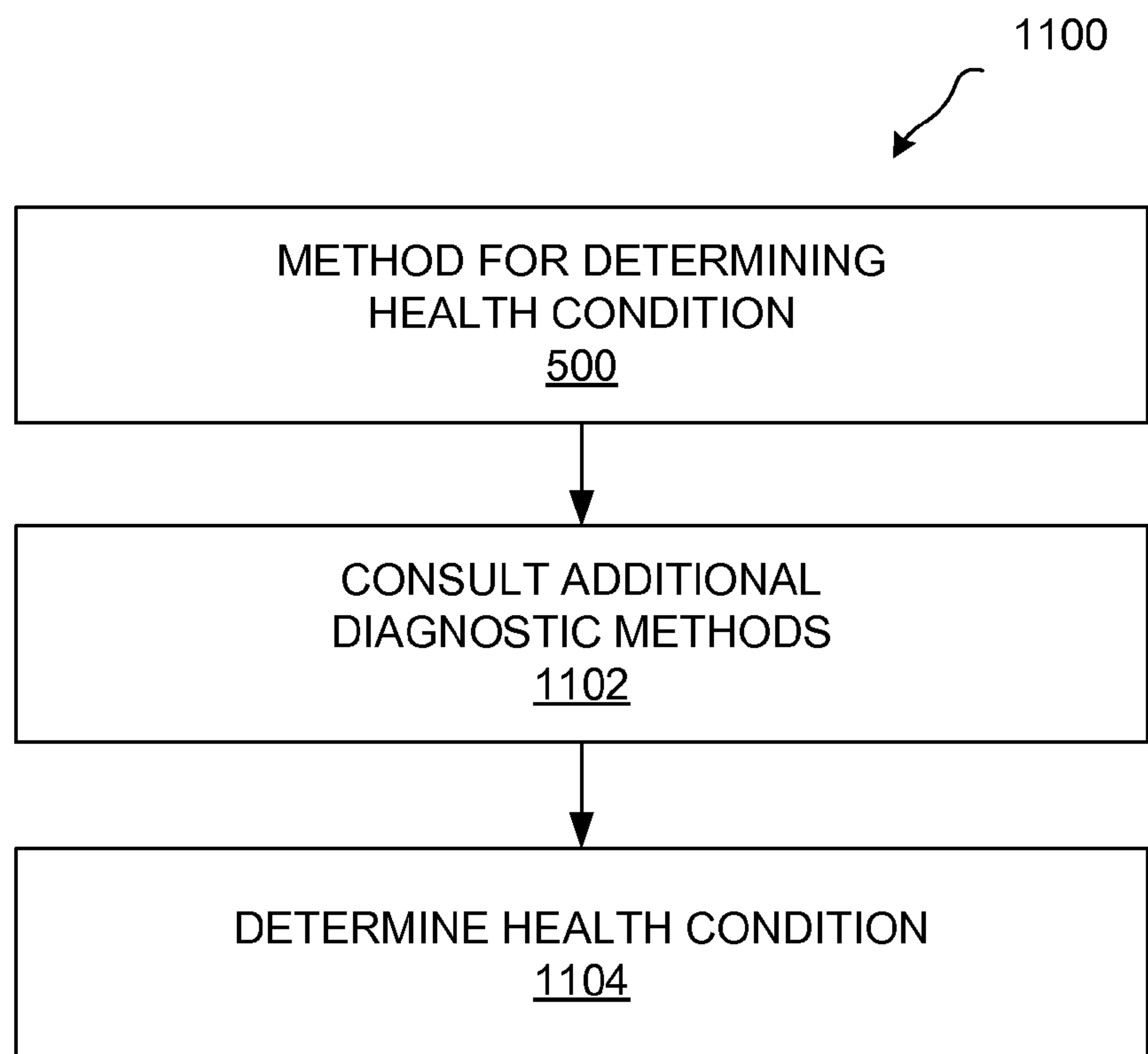



Figure 15

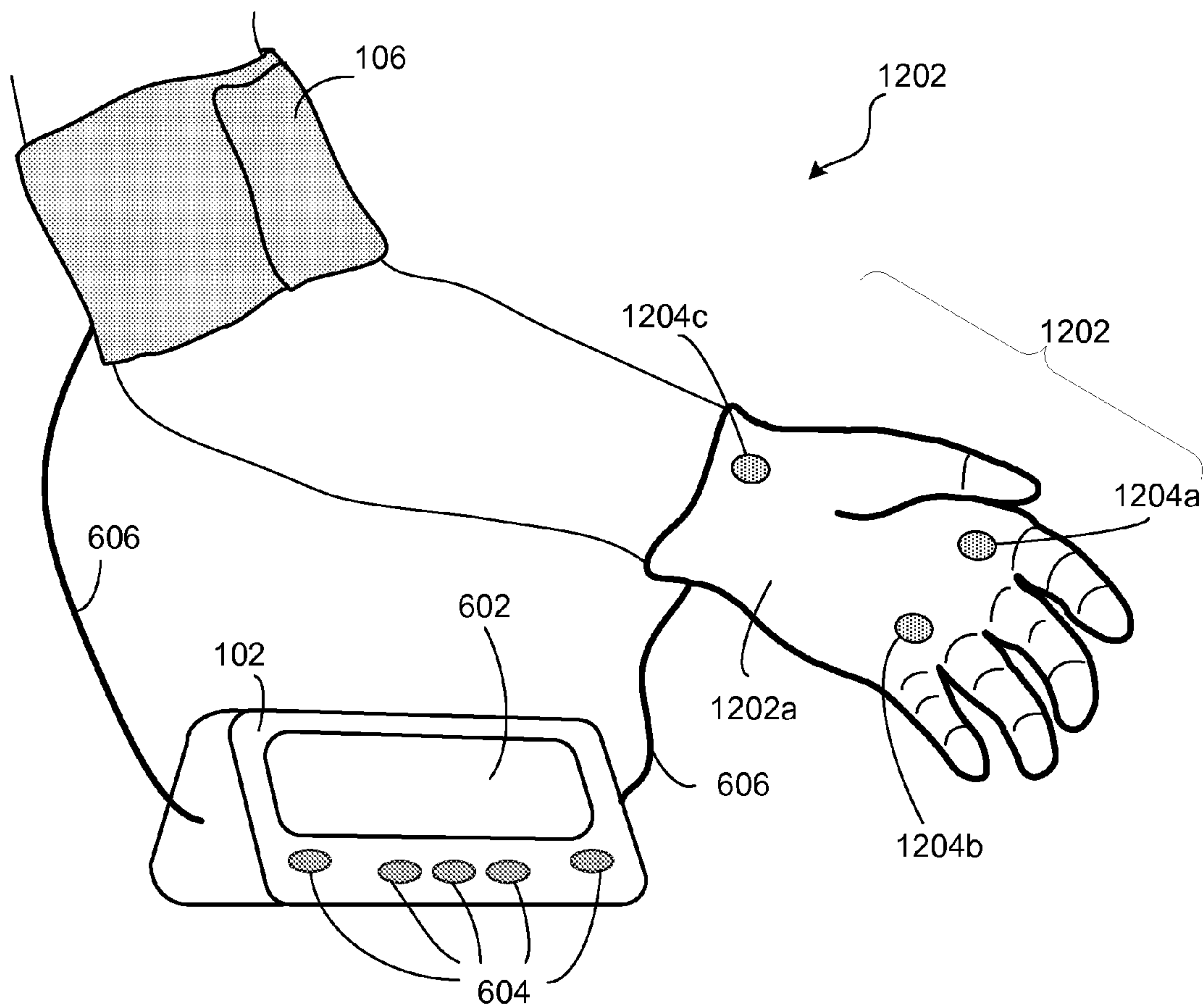

Figure 16

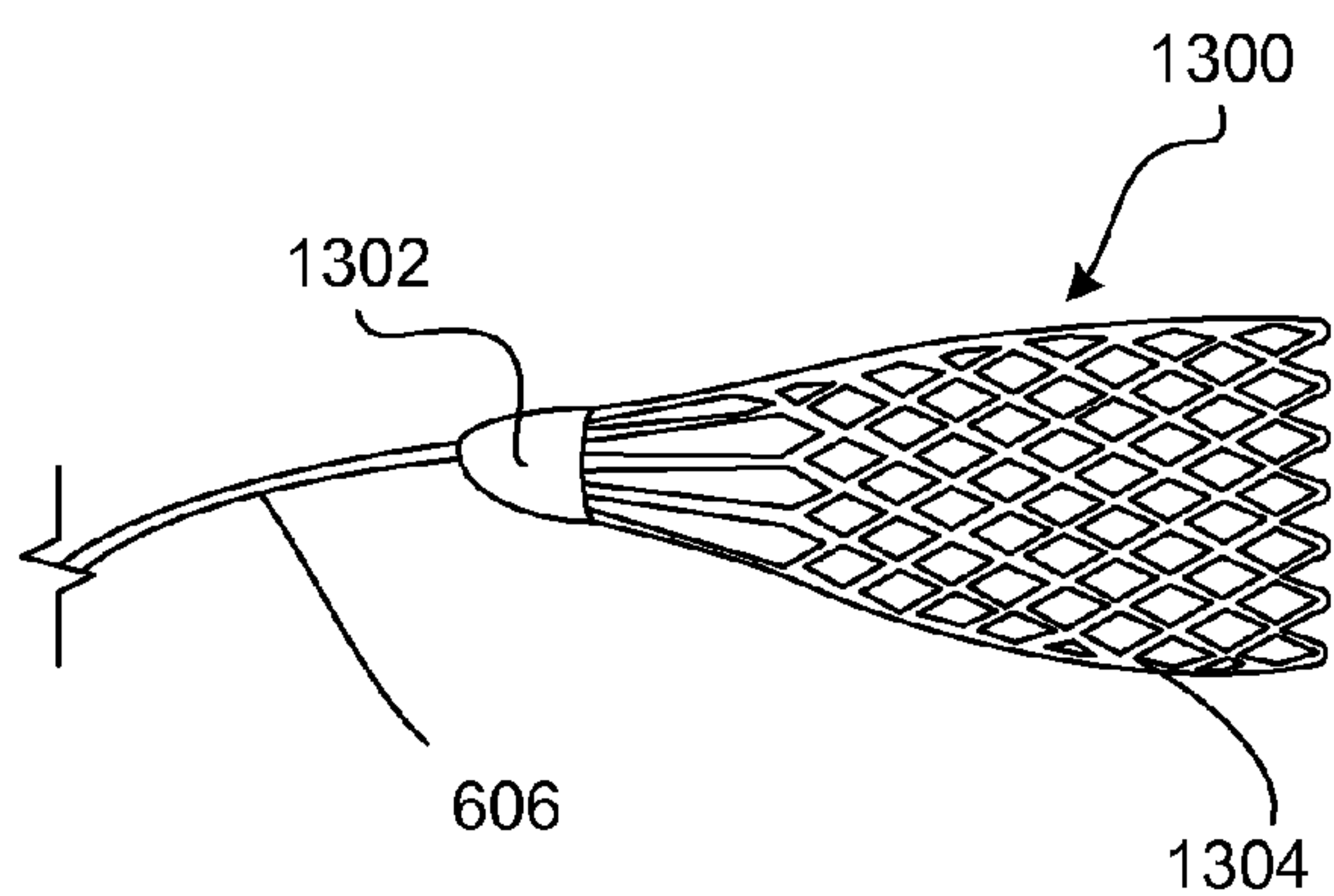

Figure 17

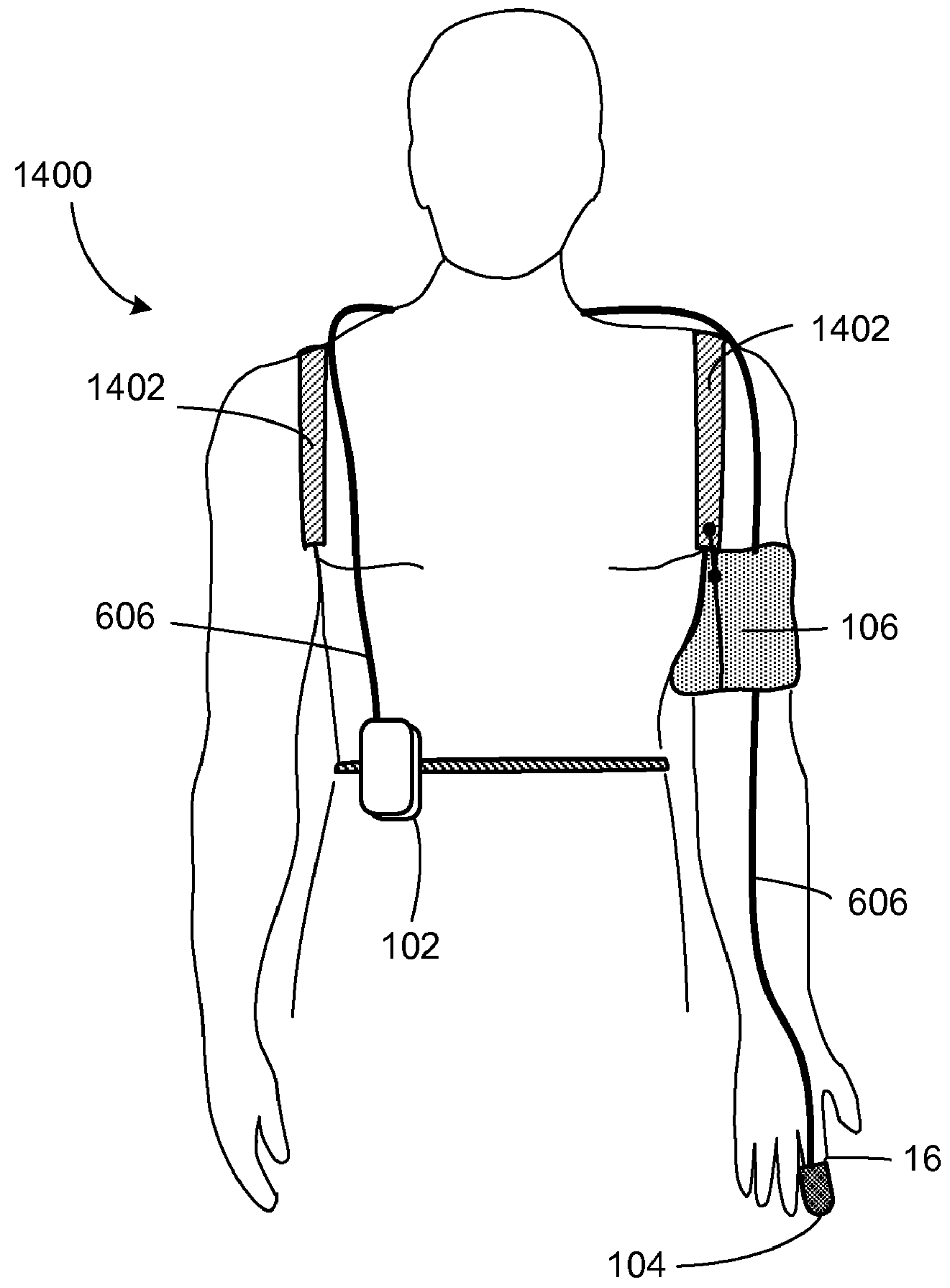

Figure 18a

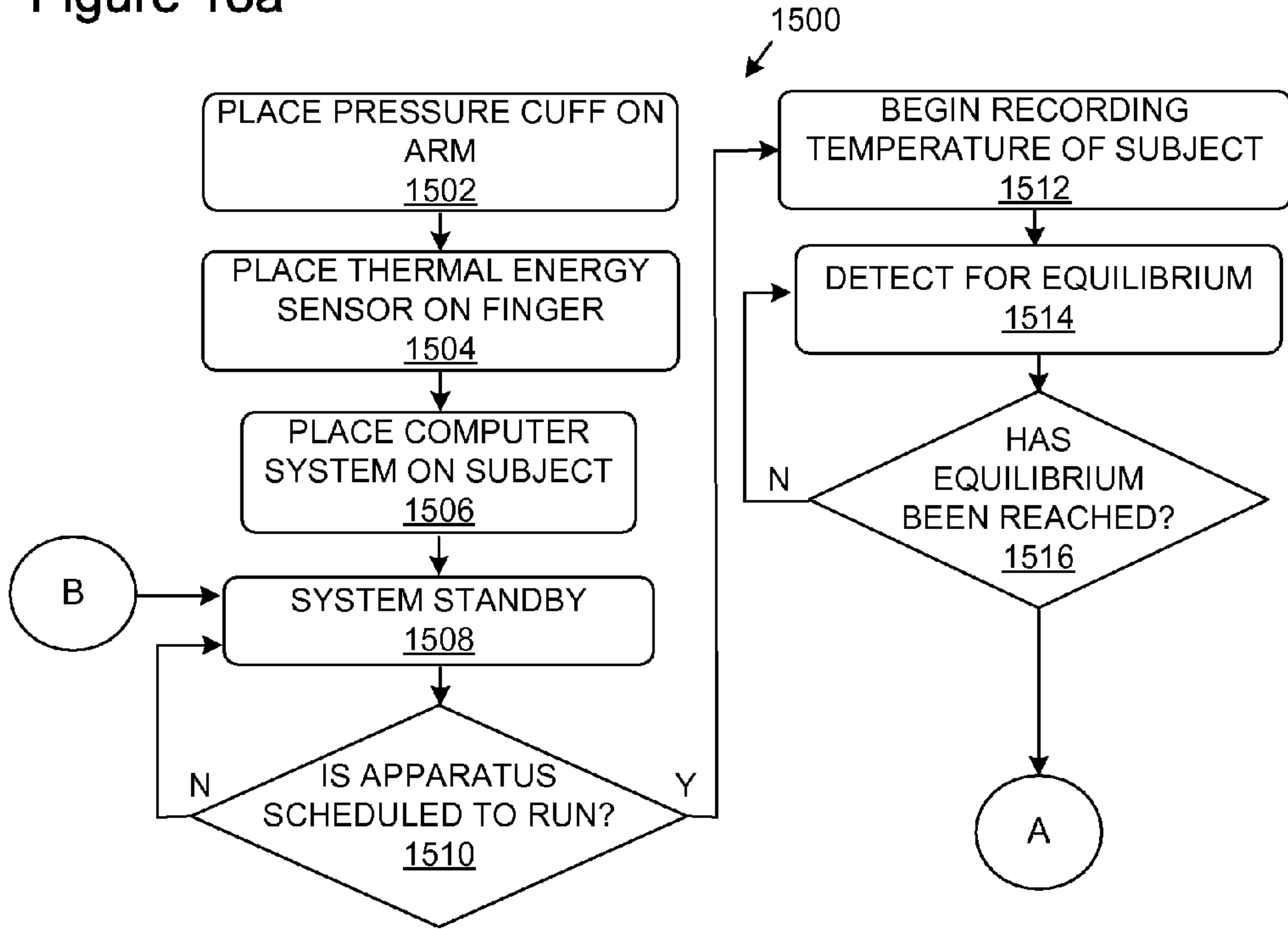

Figure 18b

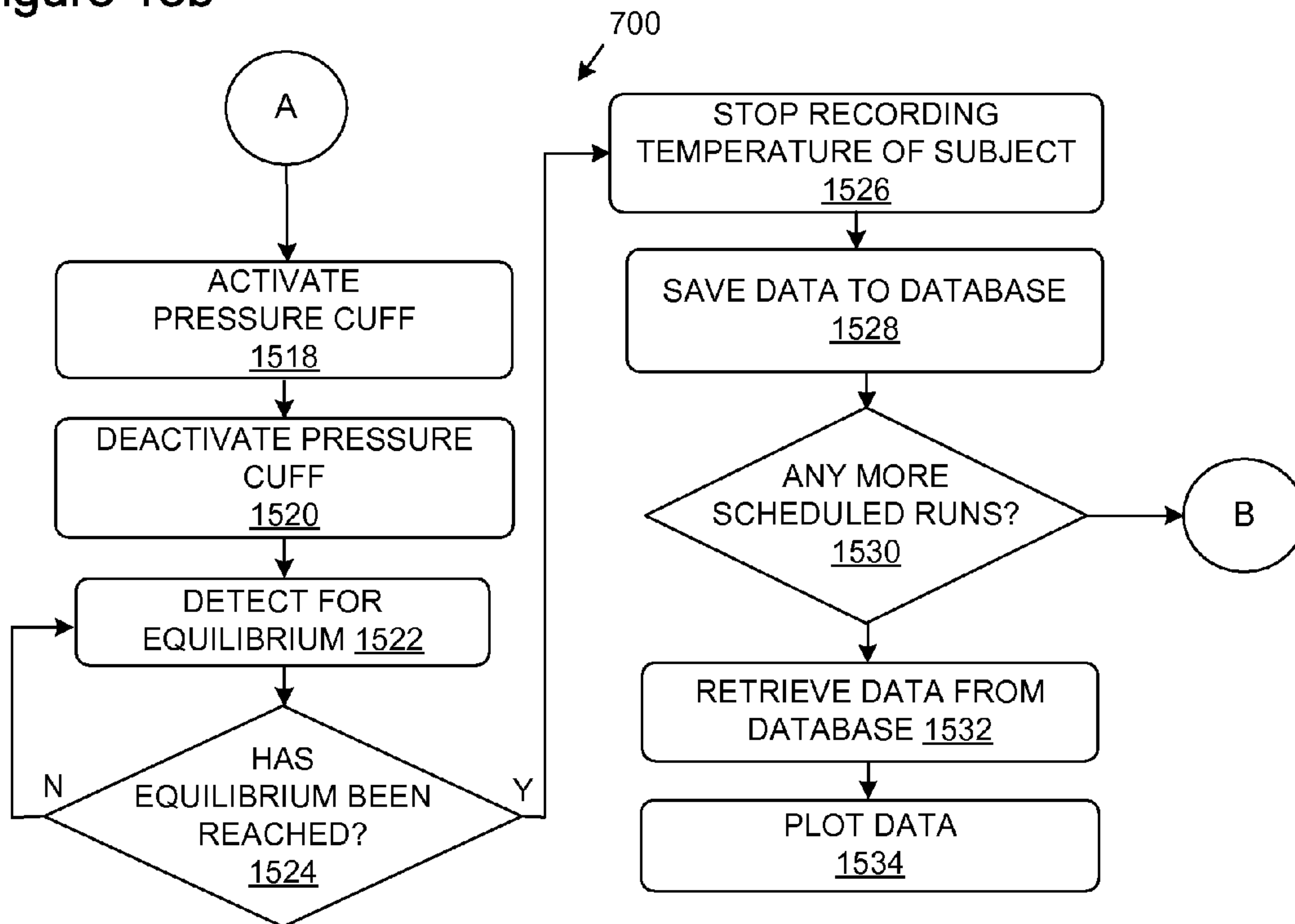

Figure 19

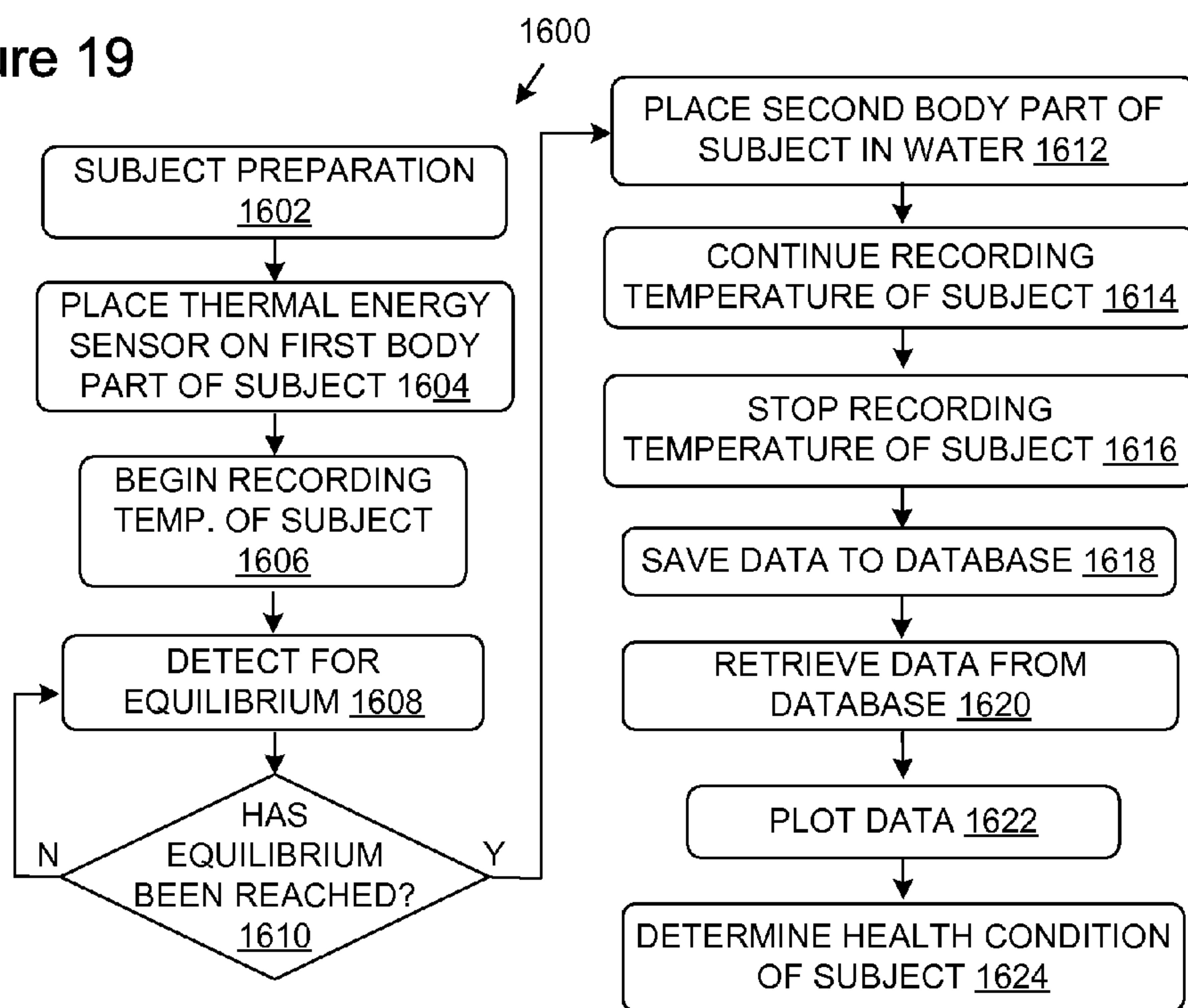

Figure 20

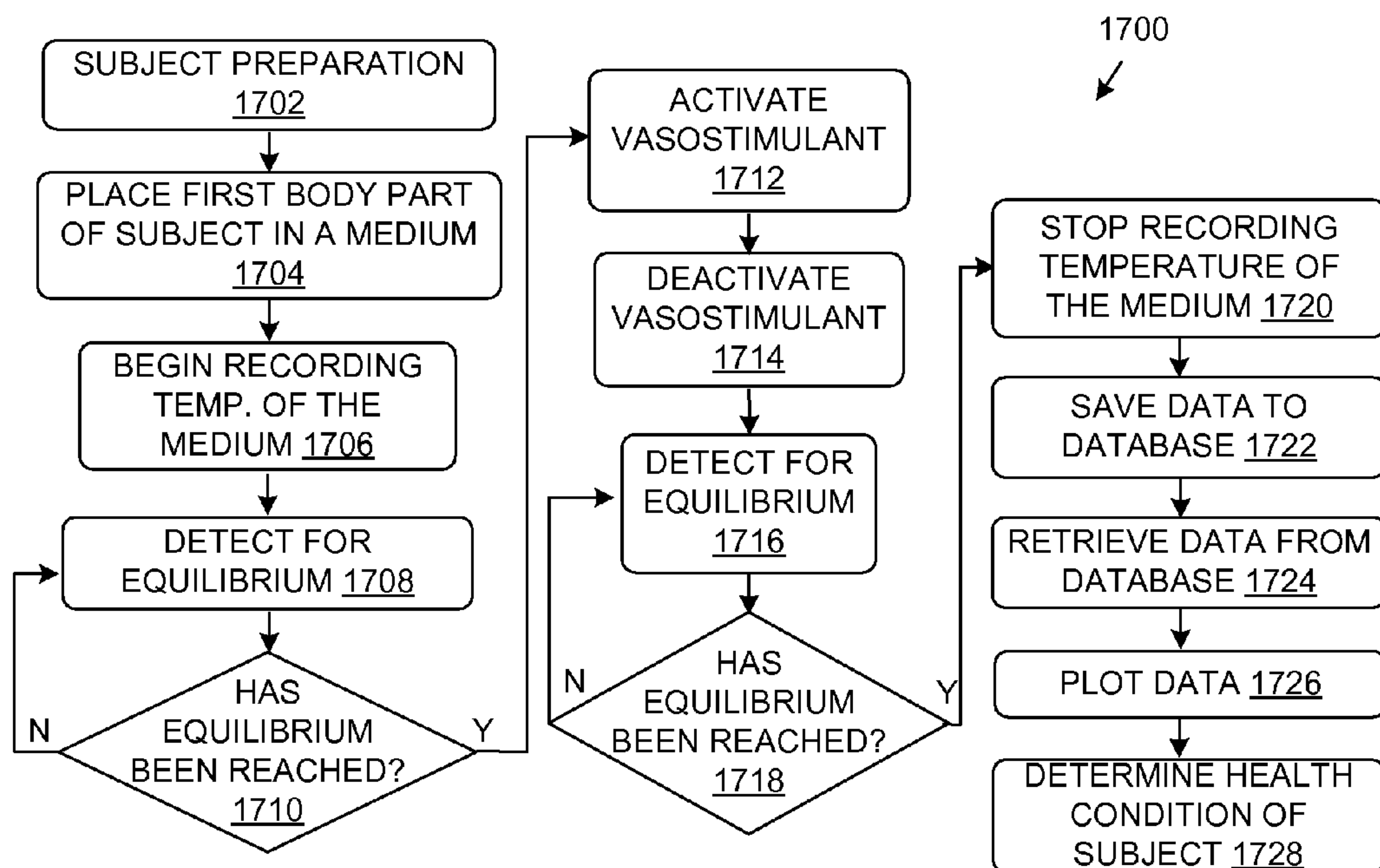

Figure 21

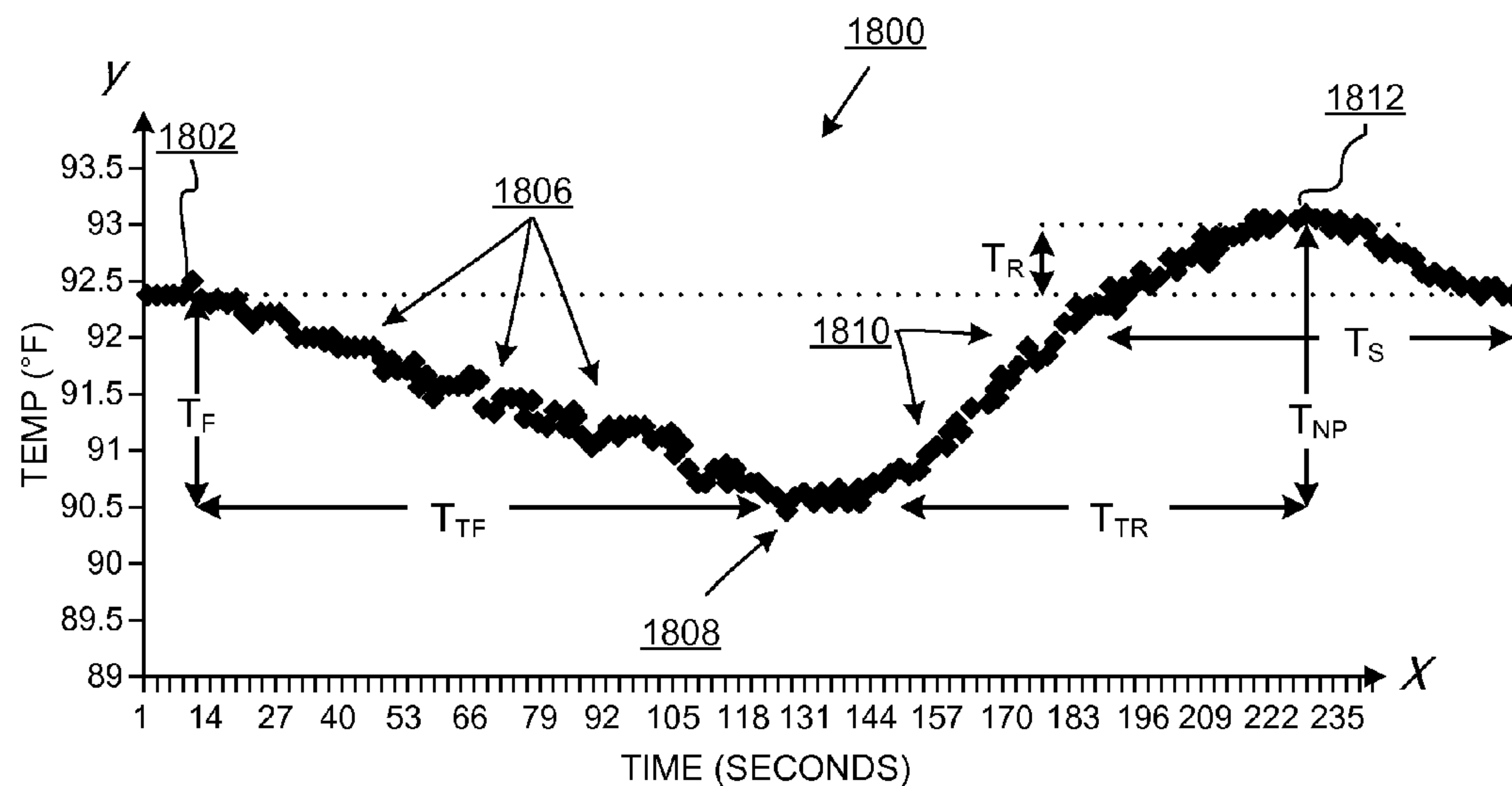

Figure 22

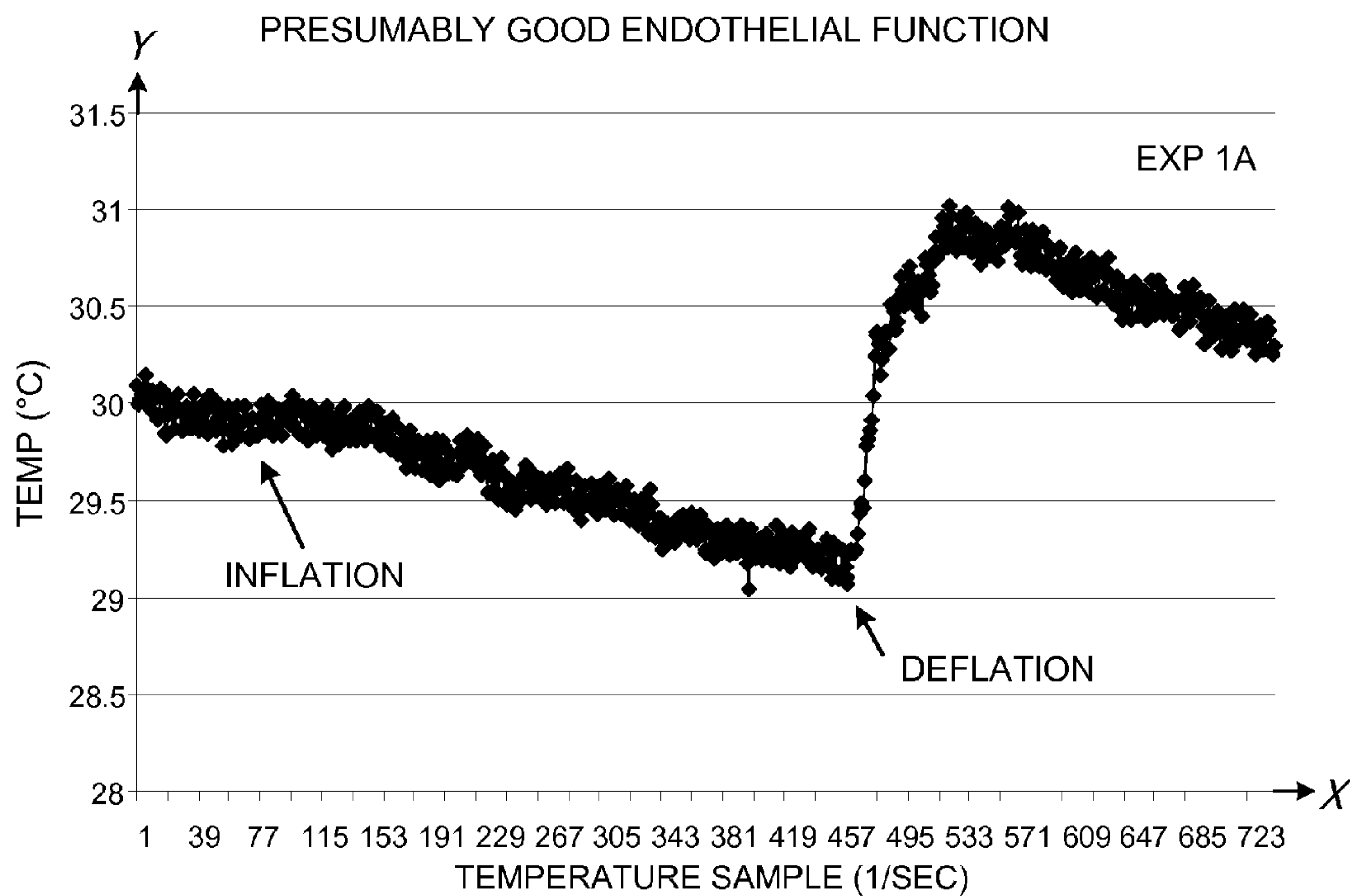



Figure 23

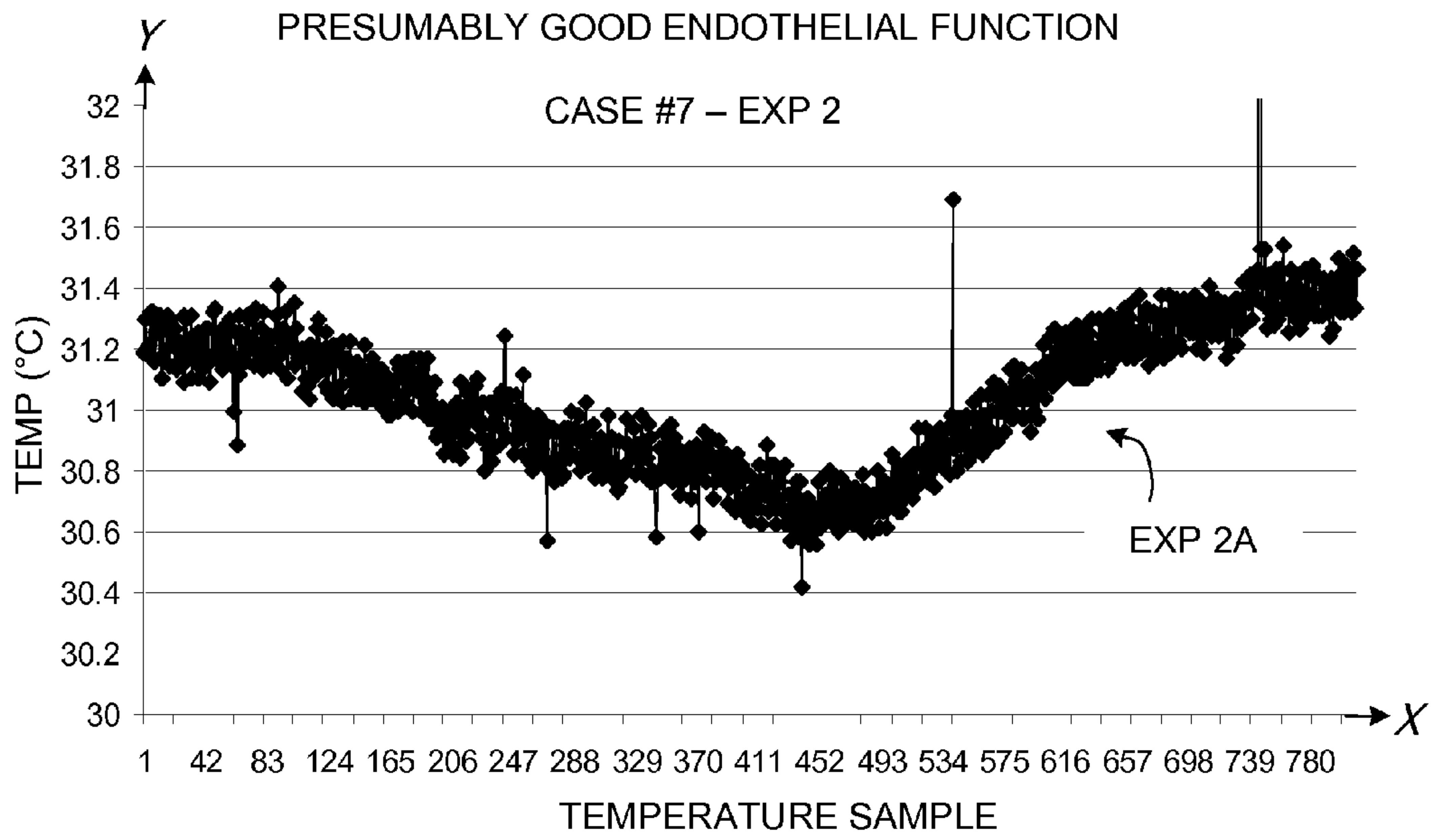

Figure 24

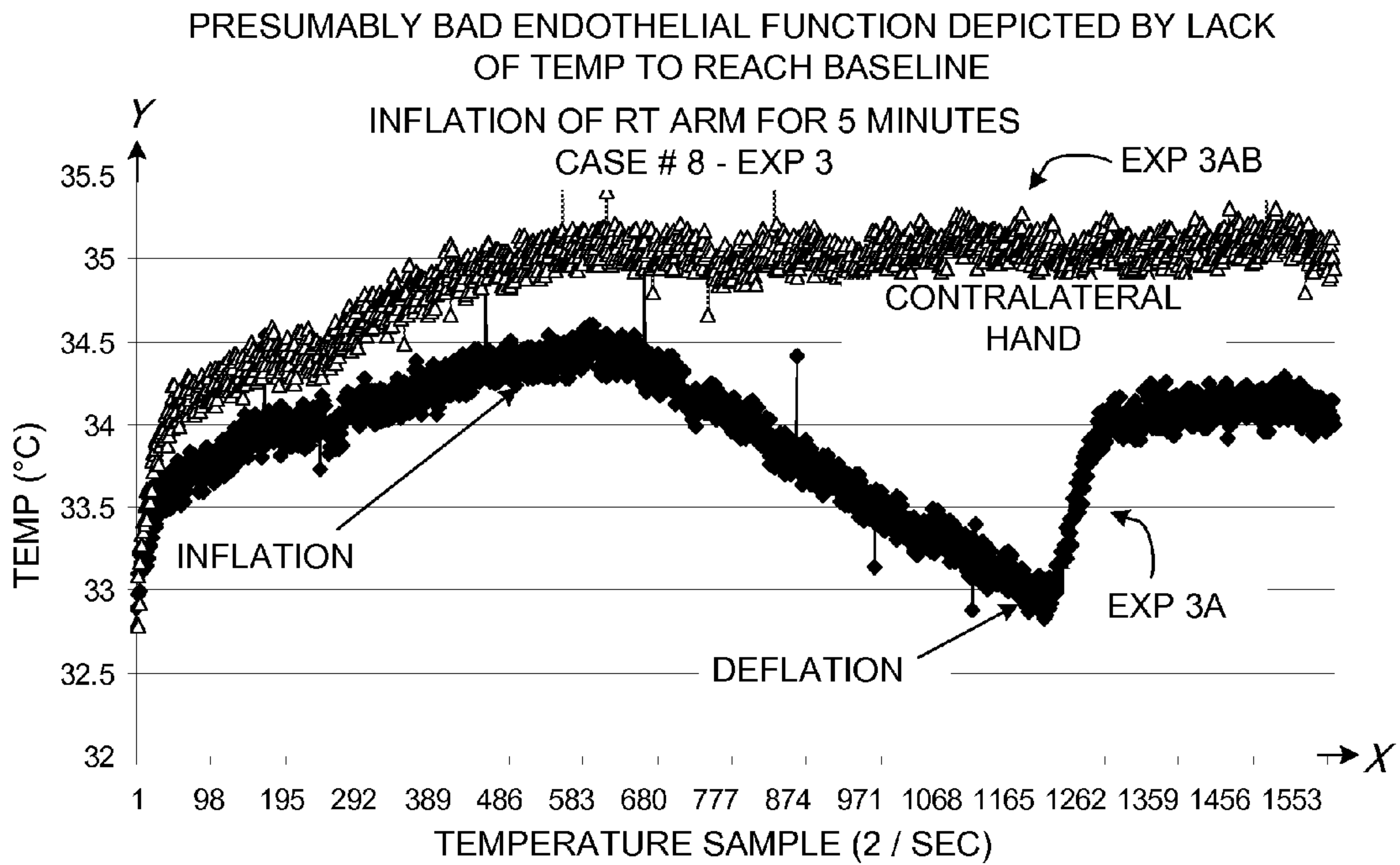



Figure 25

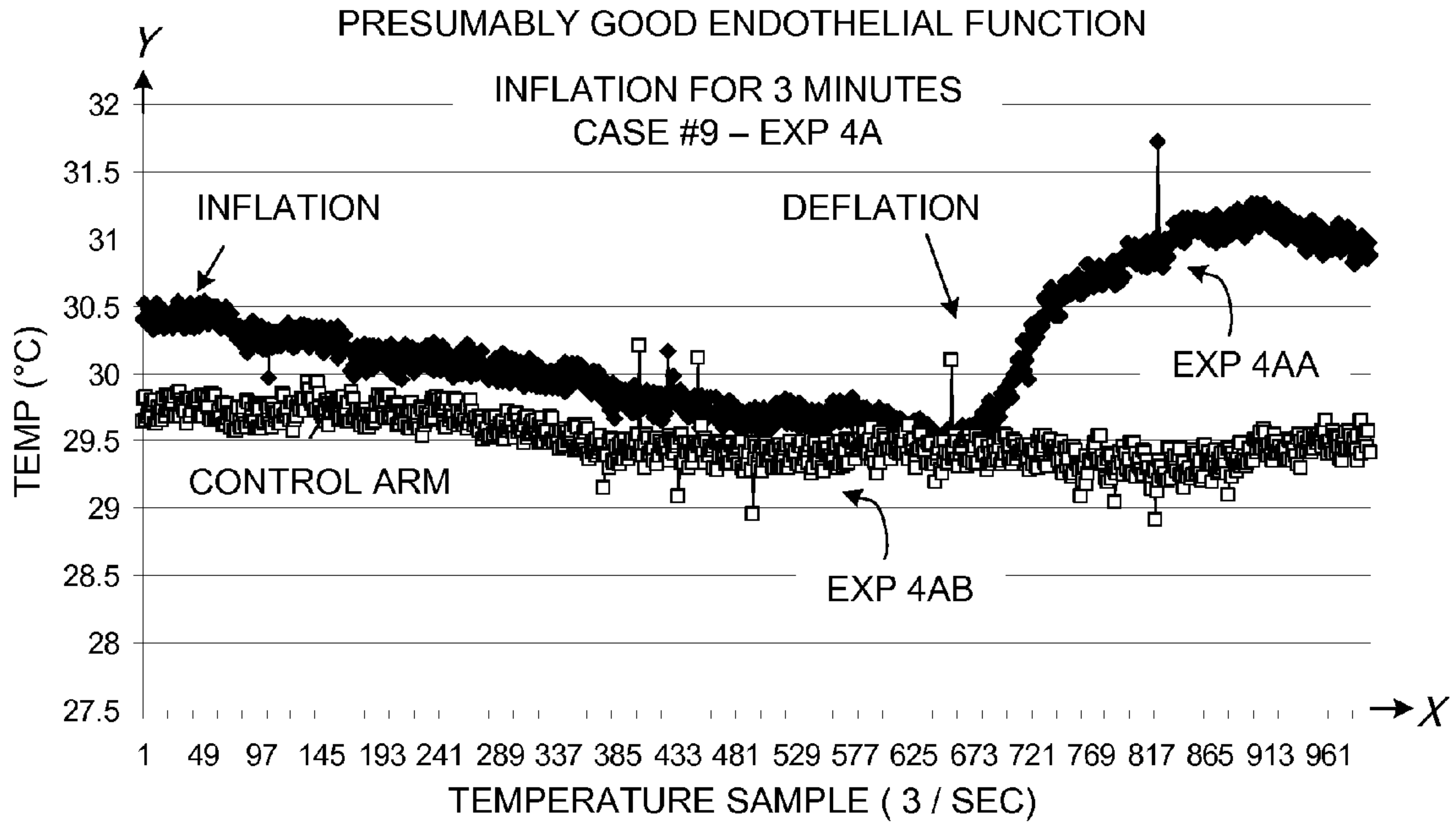

Figure 26

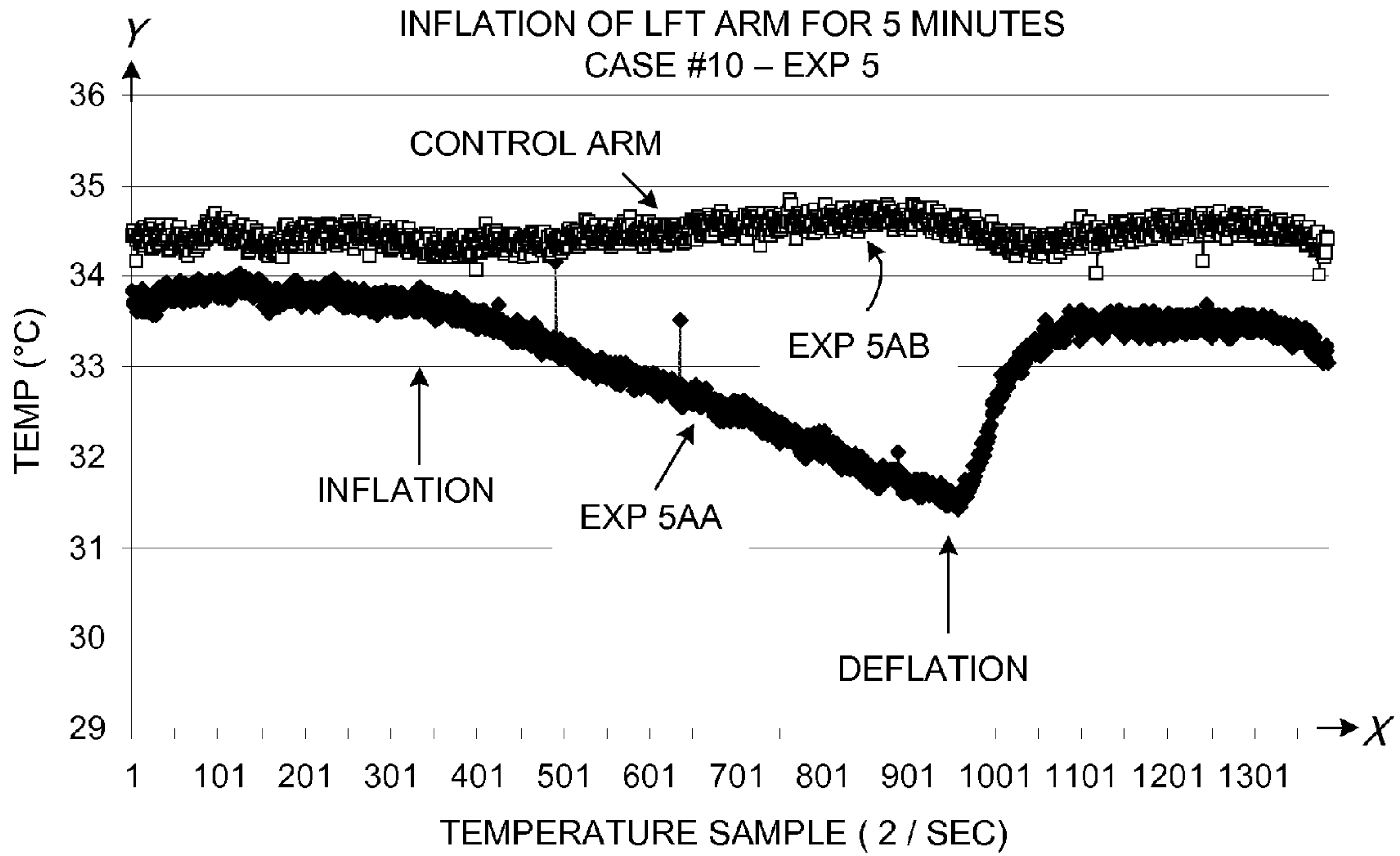

Figure 27

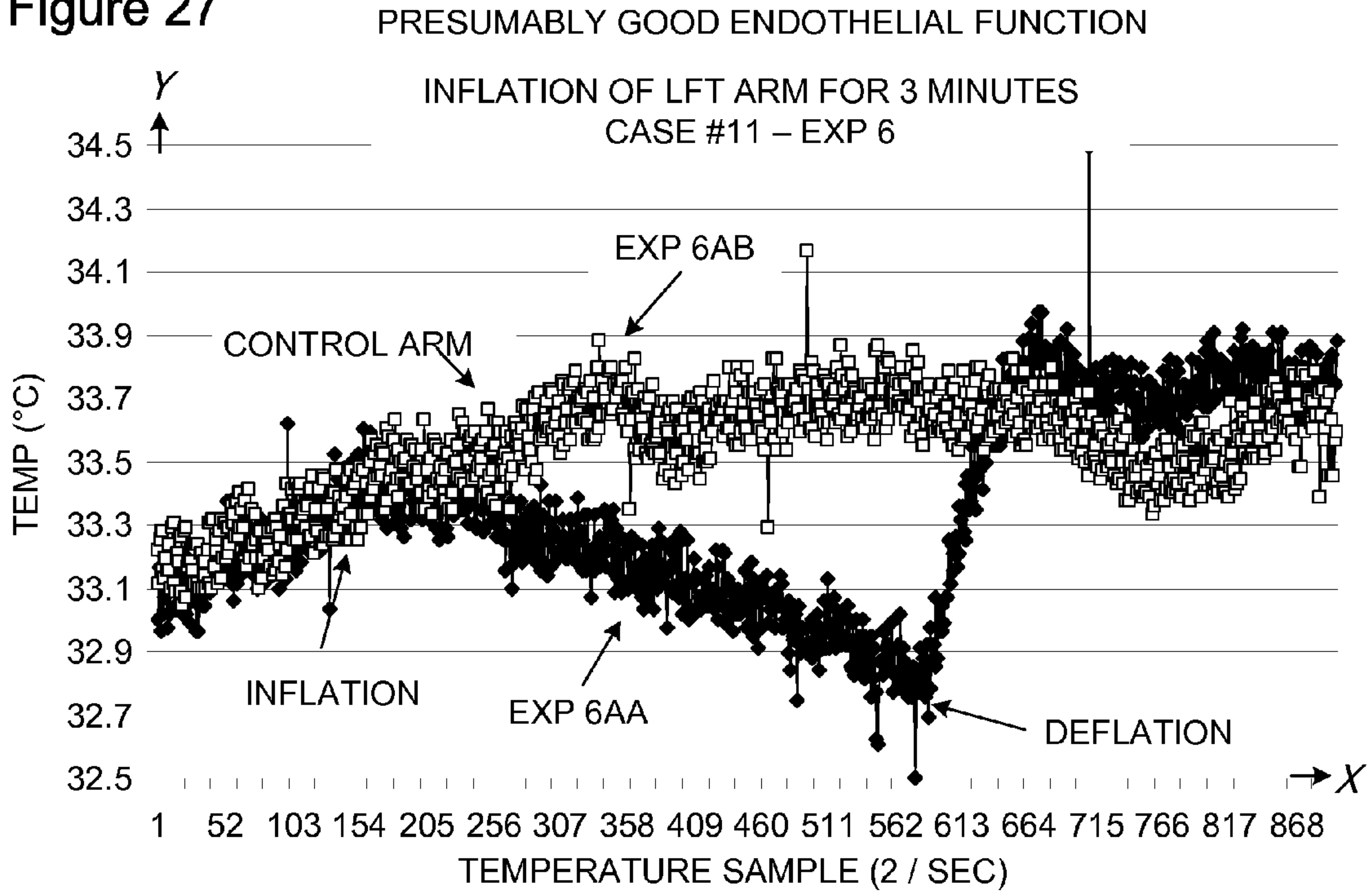

Figure 28

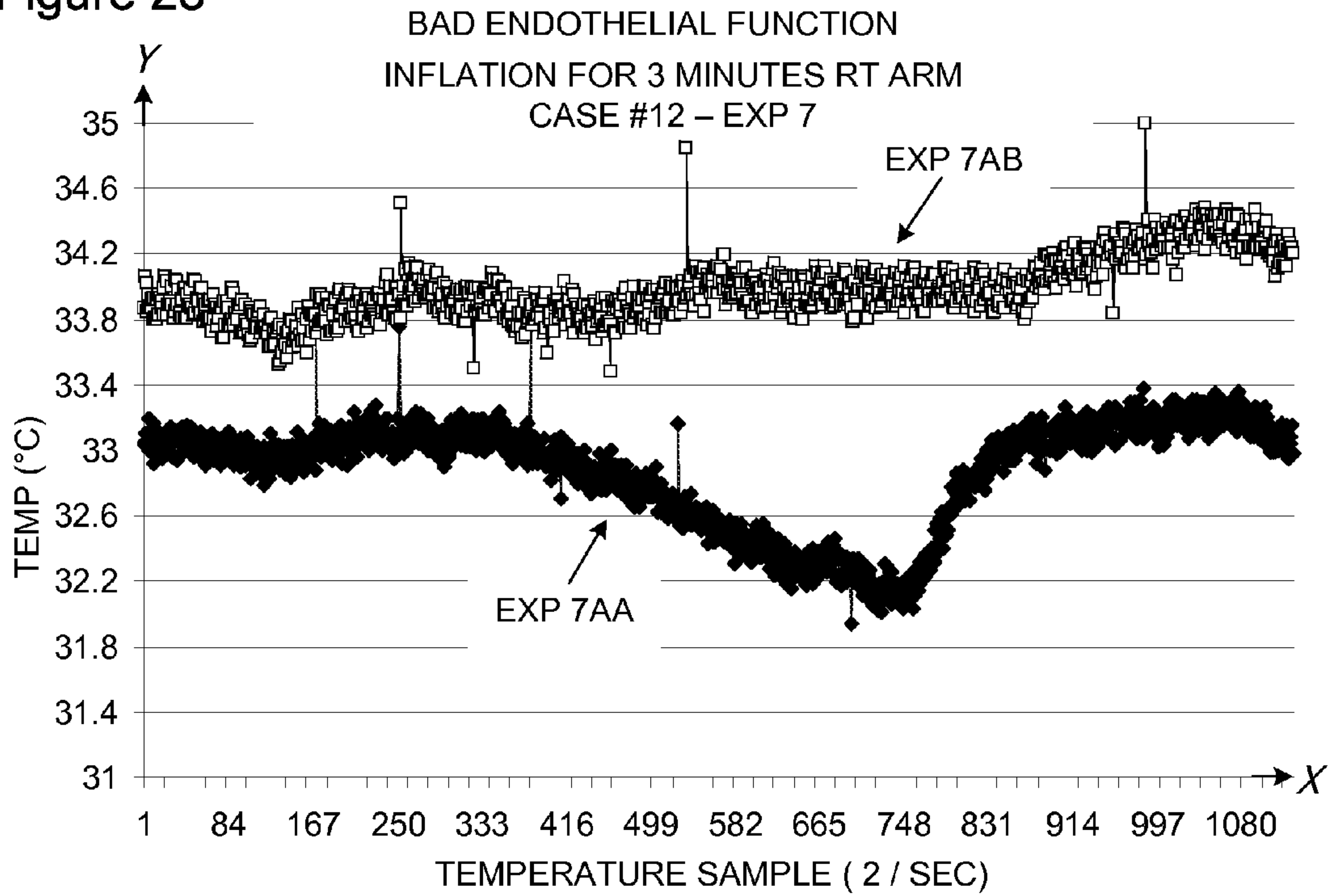

Figure 29

Graph Showing Correlation Between TR and Percentage Change in Brachial Artery Diameter

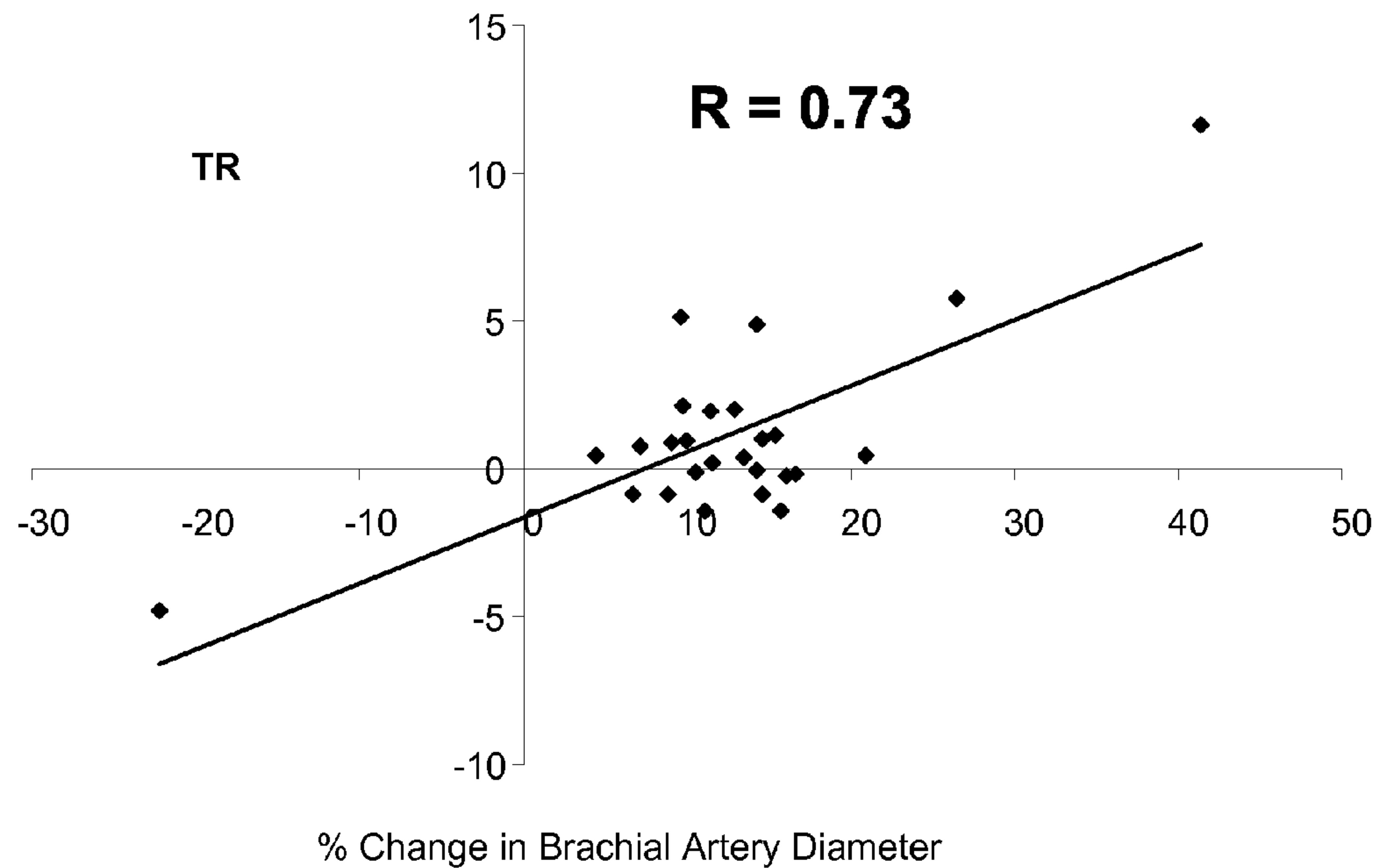

Figure 30

Graph Showing Correlation Between NP and Percentage Change in Brachial Artery Diameter

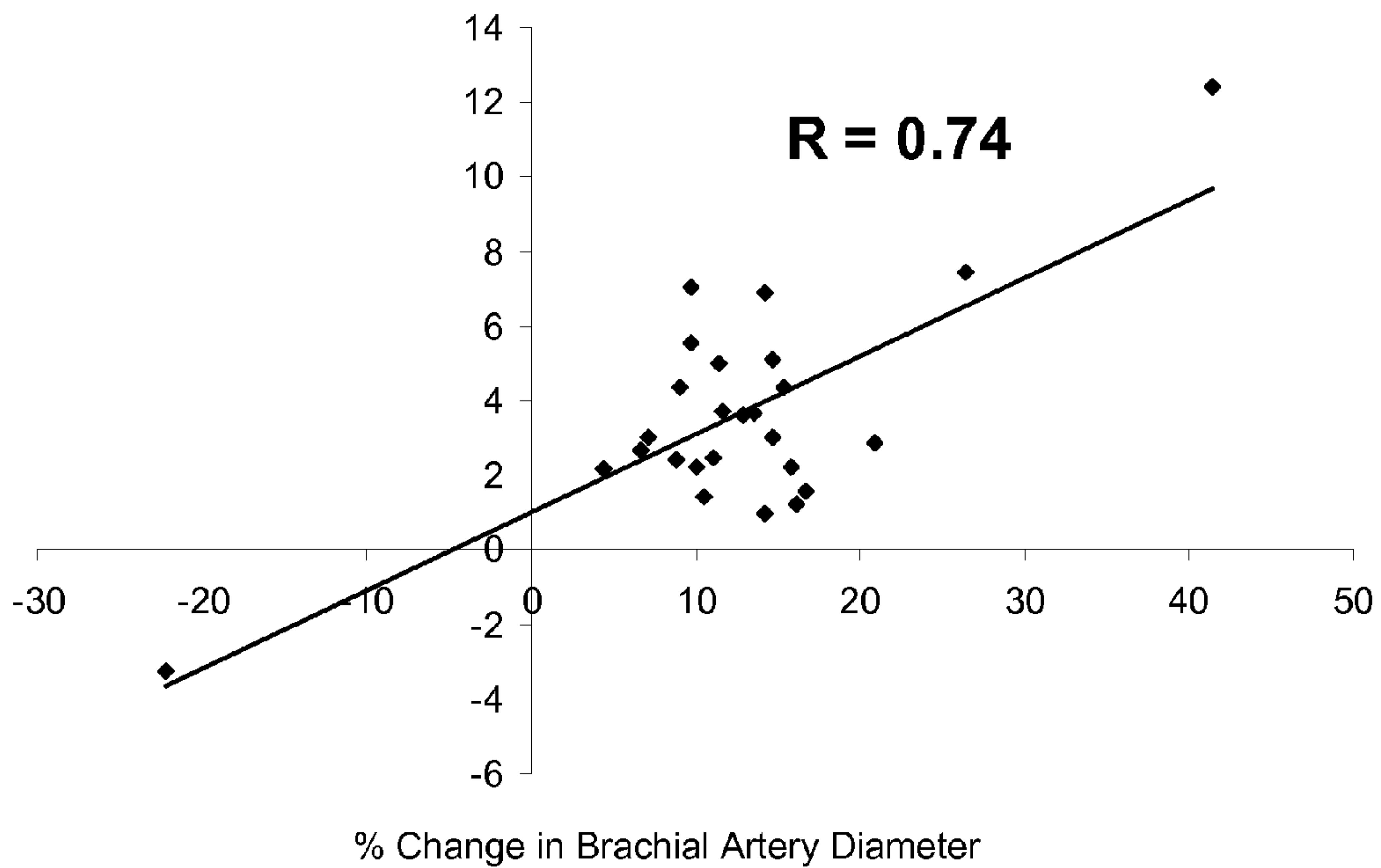

Figure 31

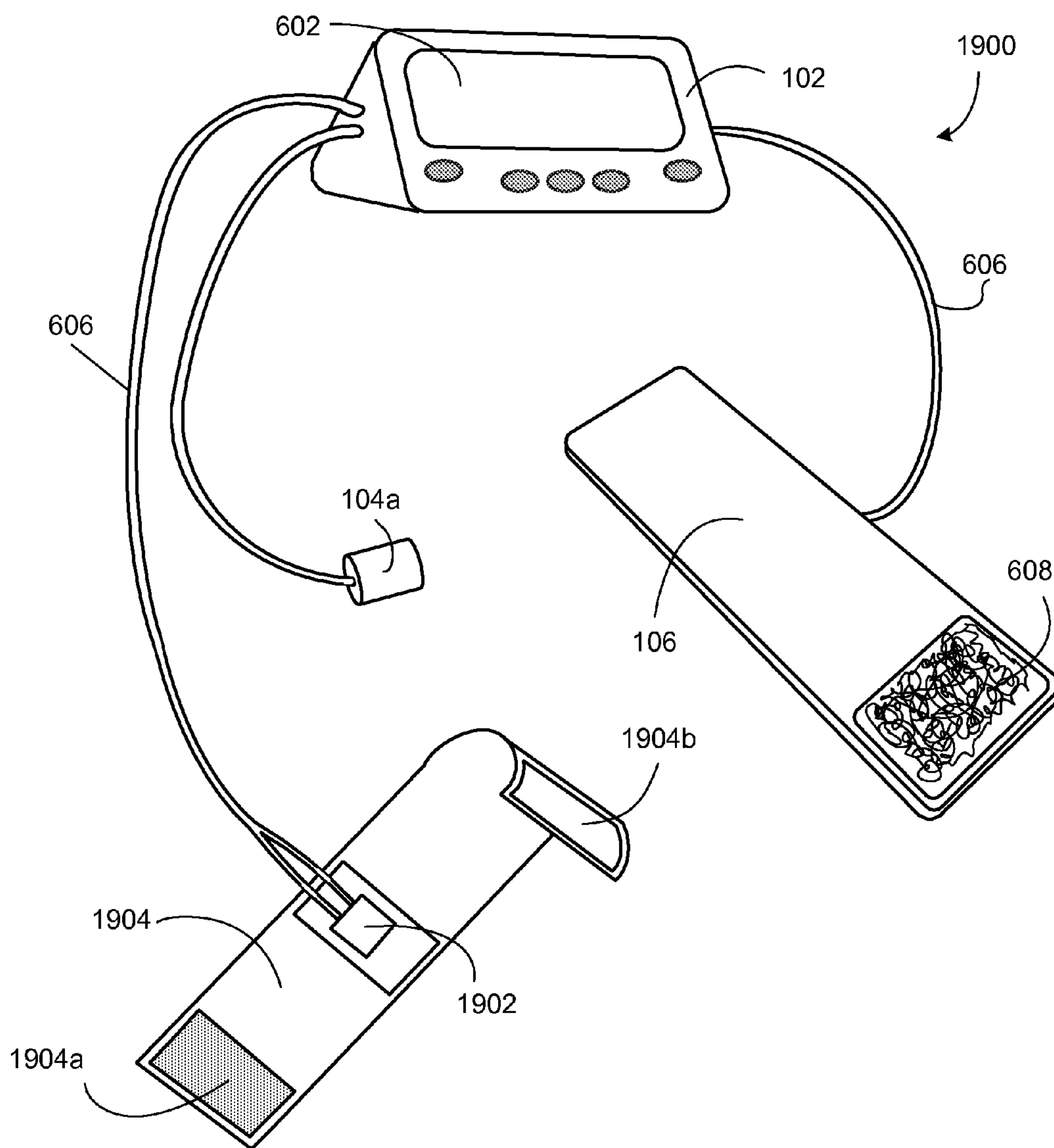

Figure 32a

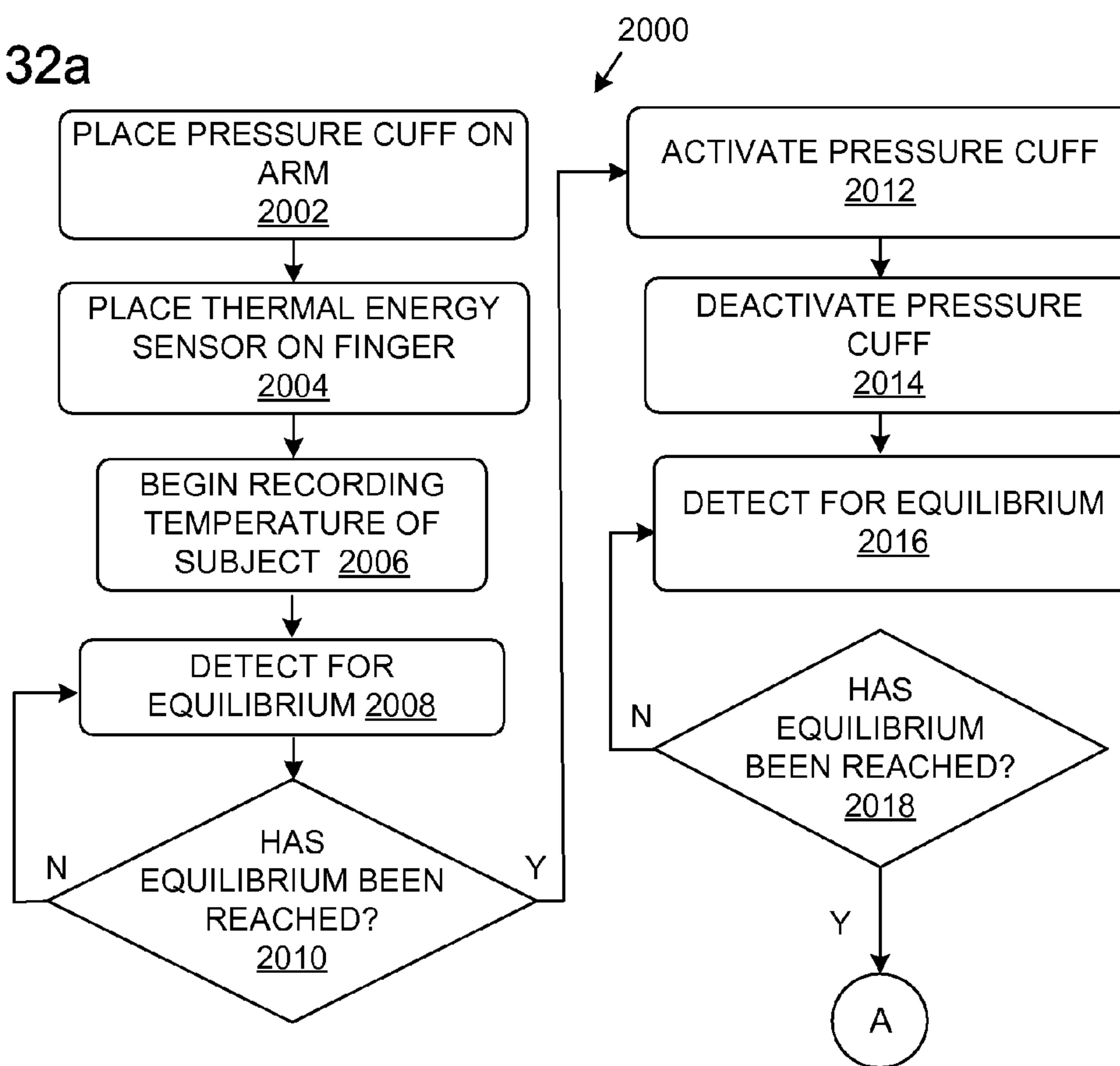

Figure 32b

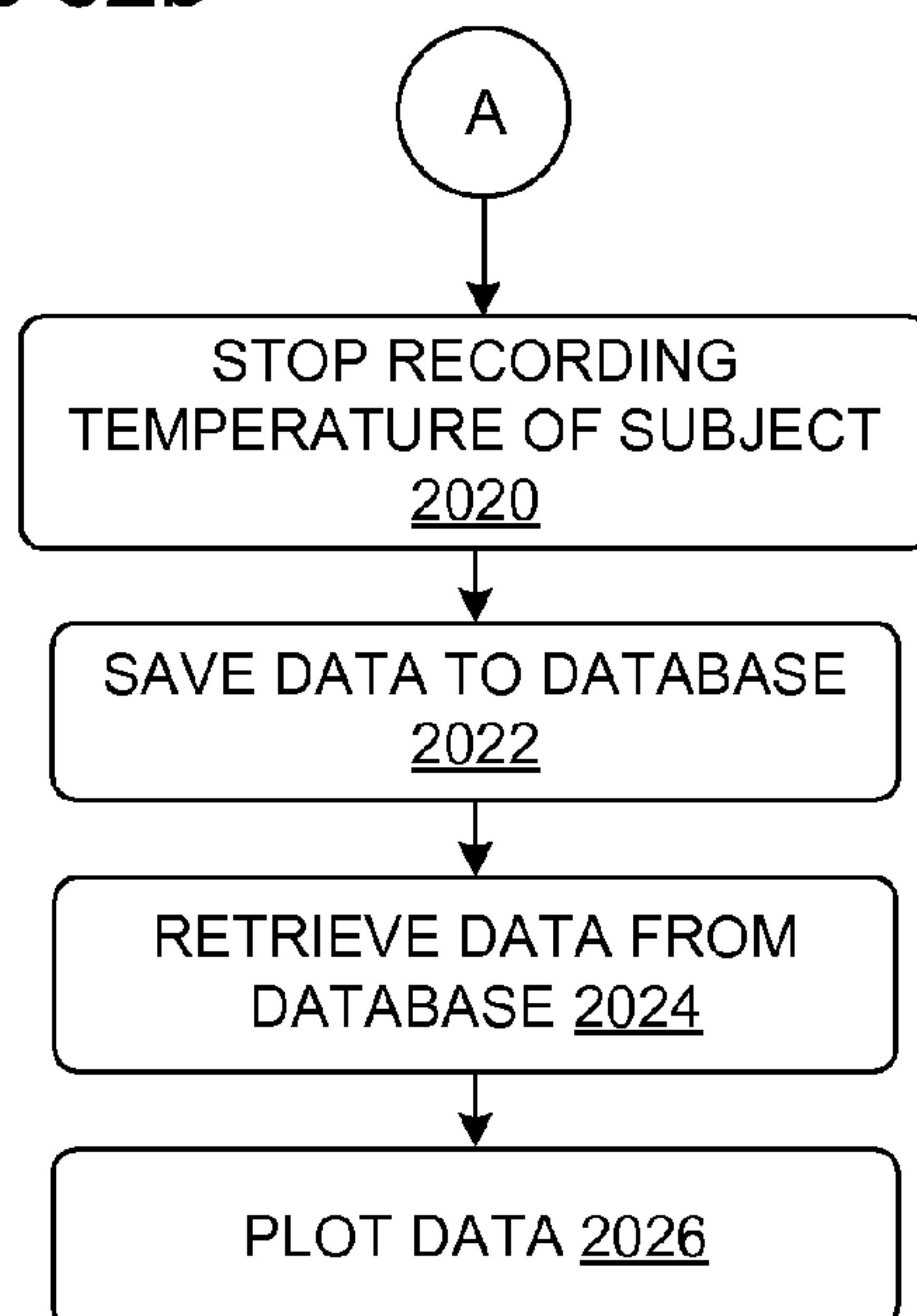

Figure 32c

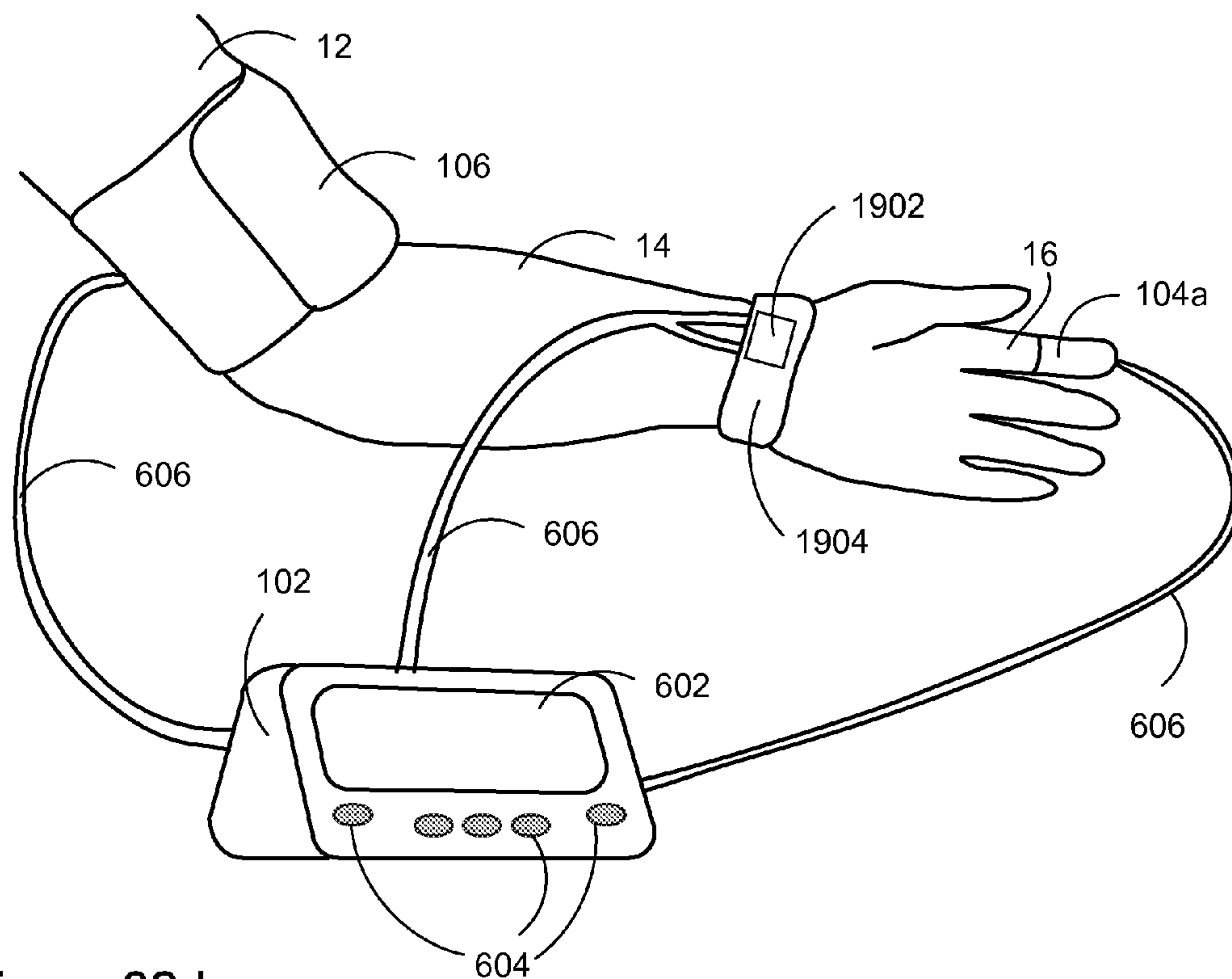

Figure 32d

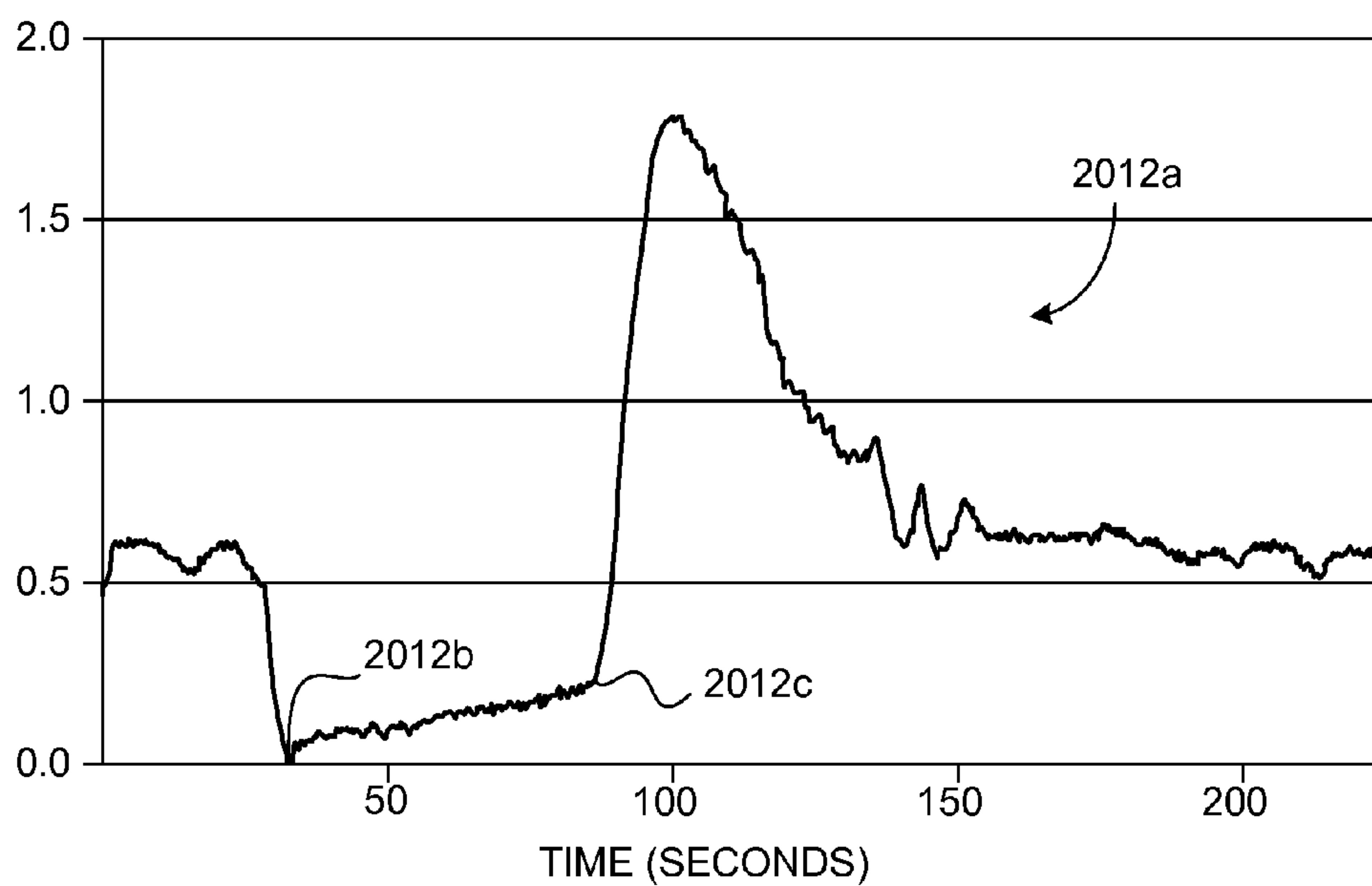



Figure 33a

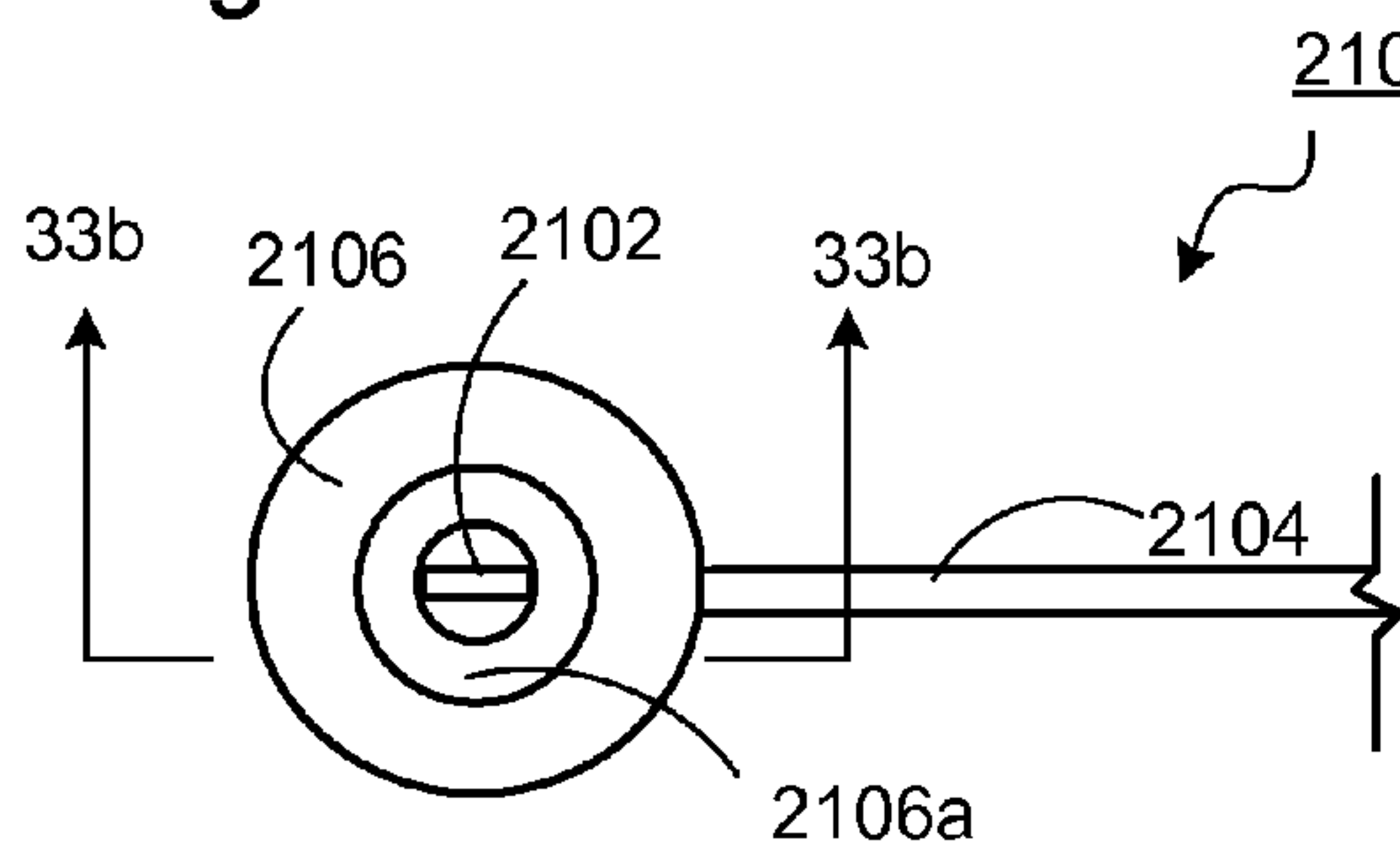

Figure 33b

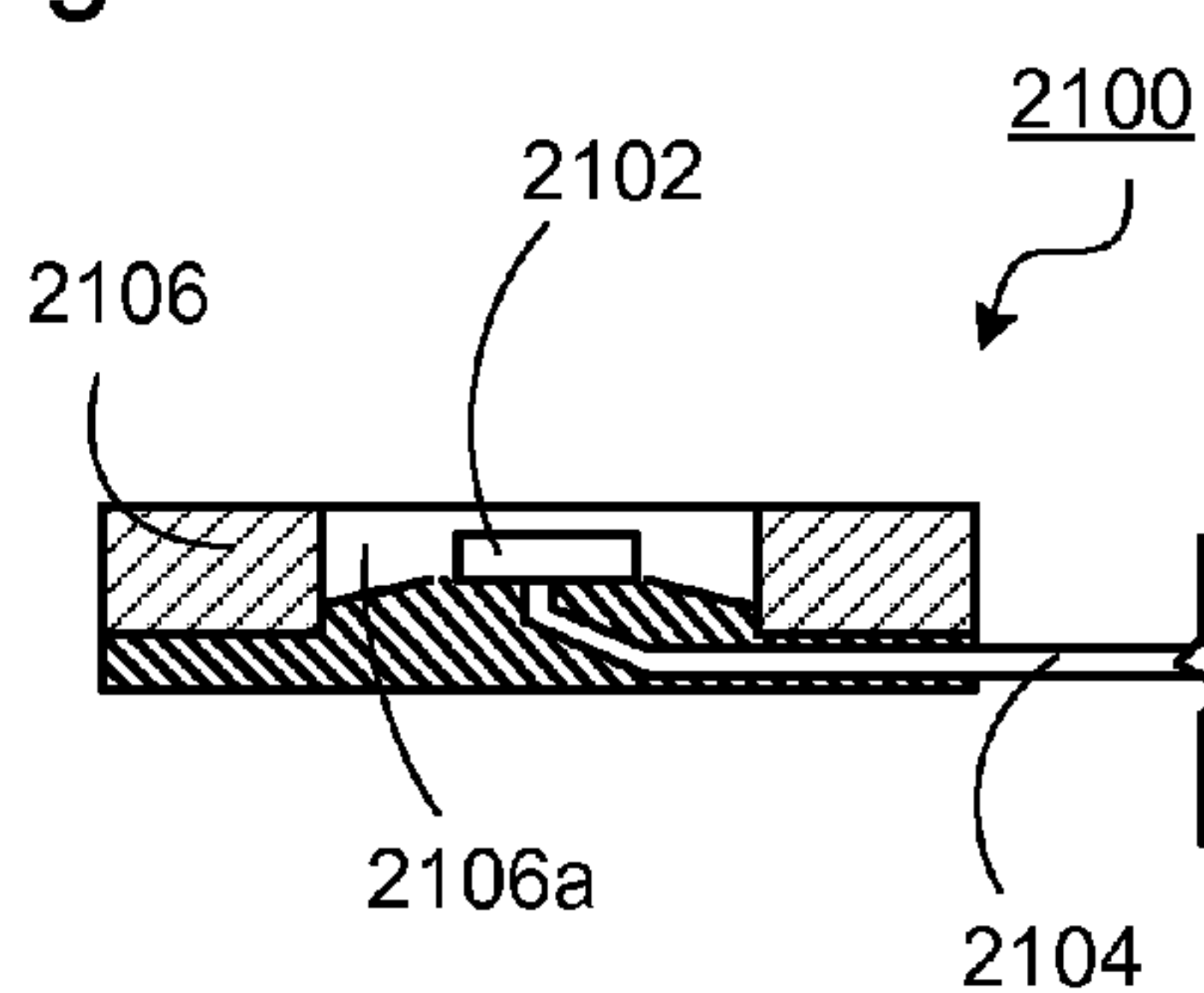

Figure 33c

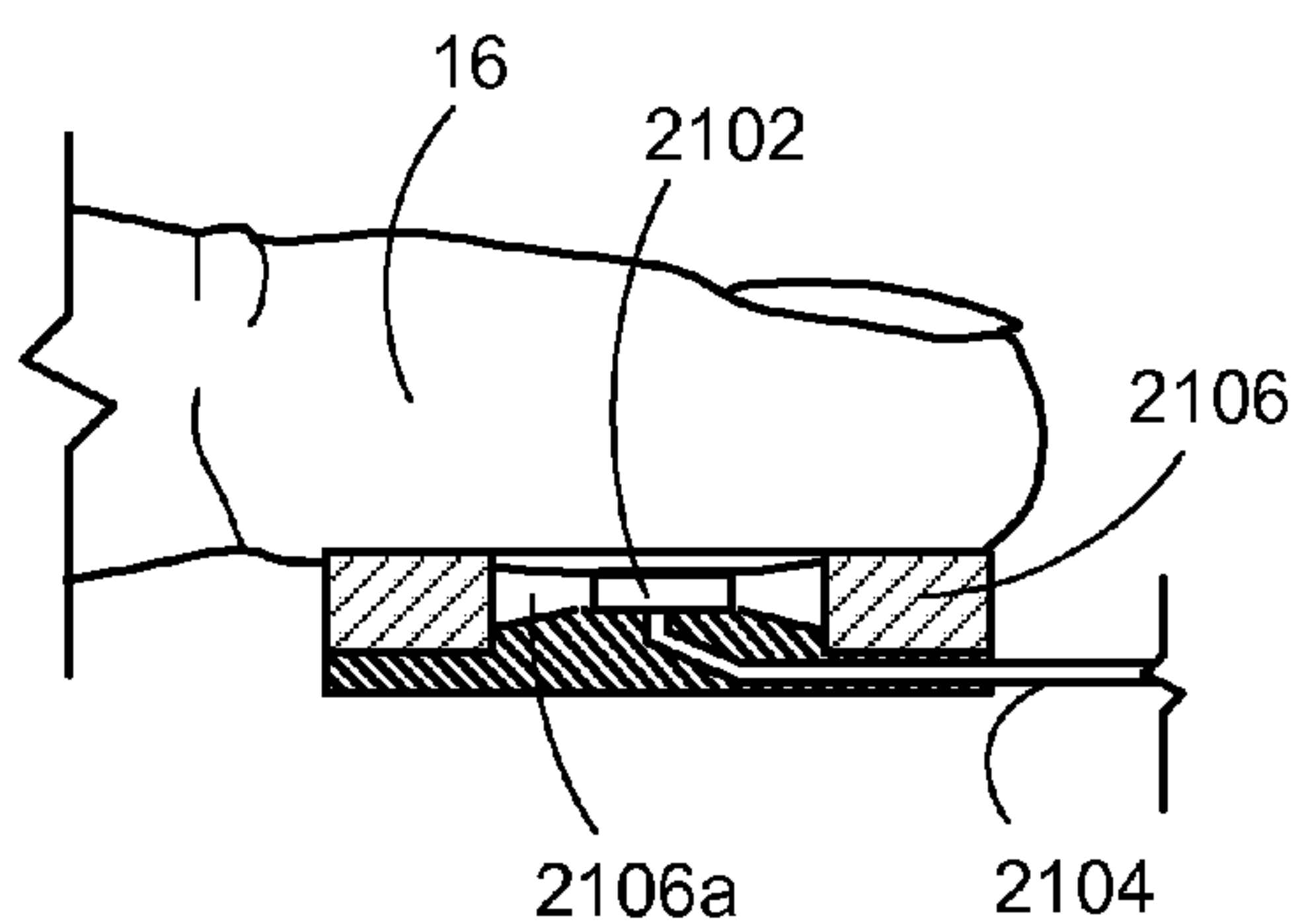

Figure 34a

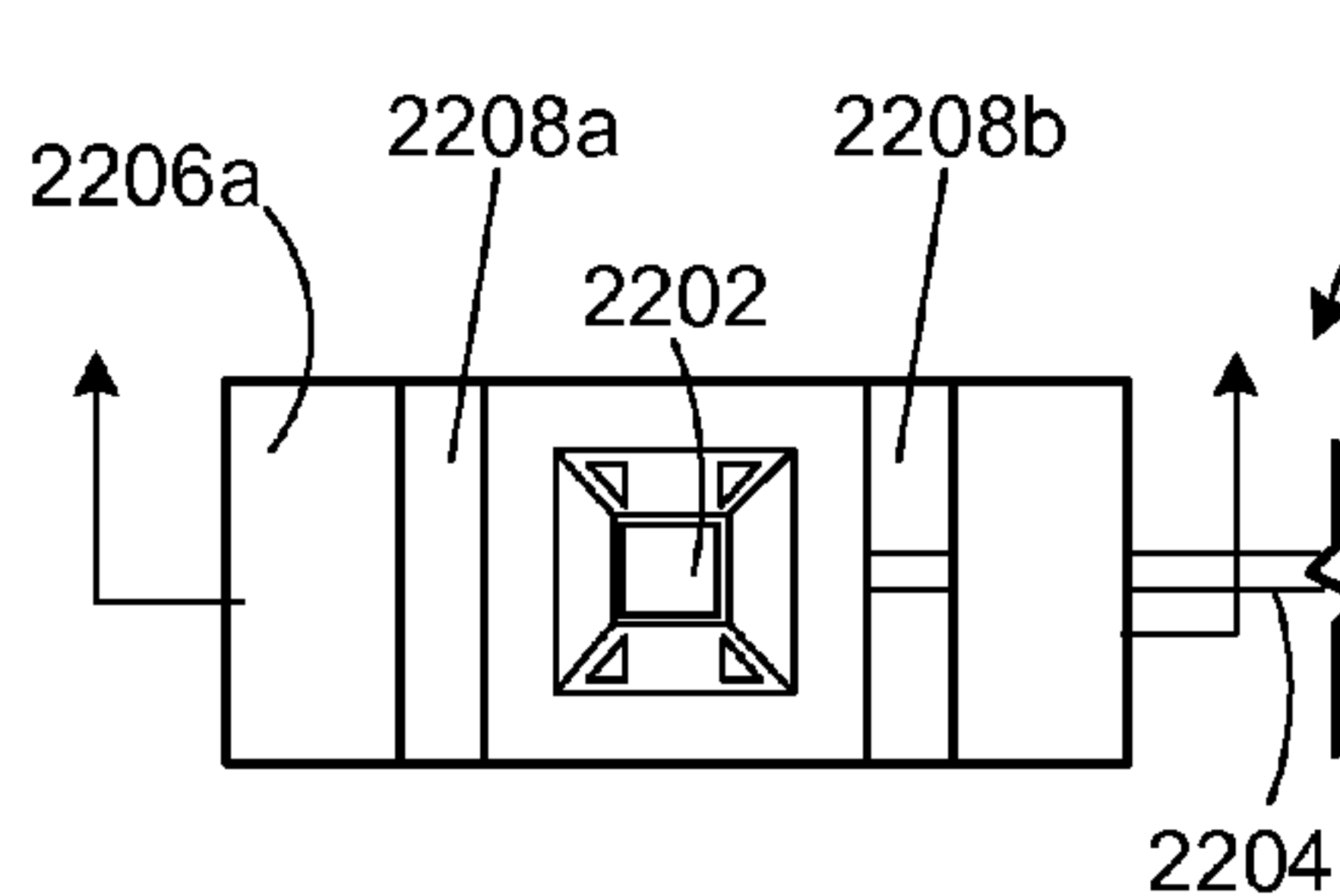

Figure 34b

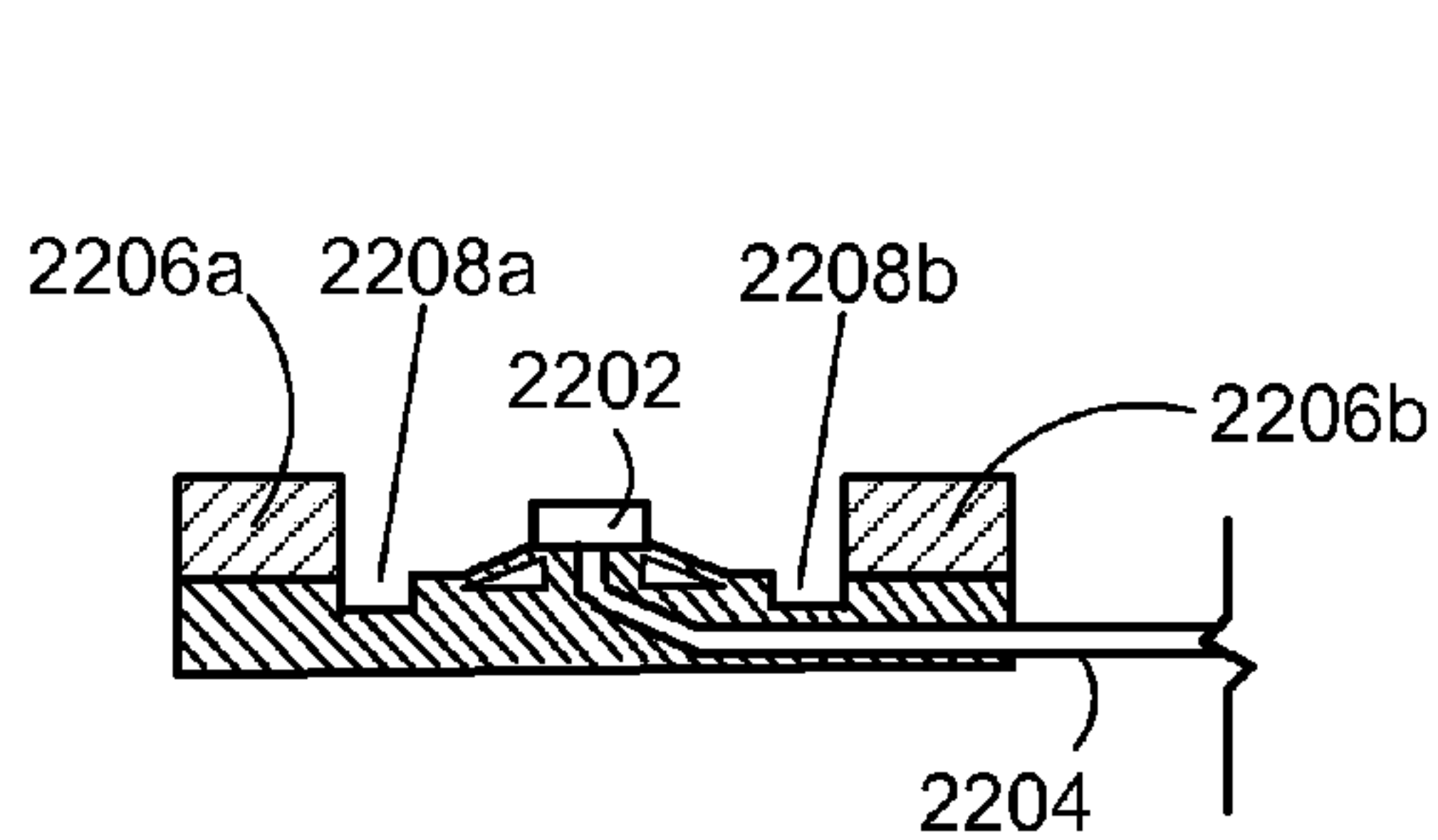

Figure 34c

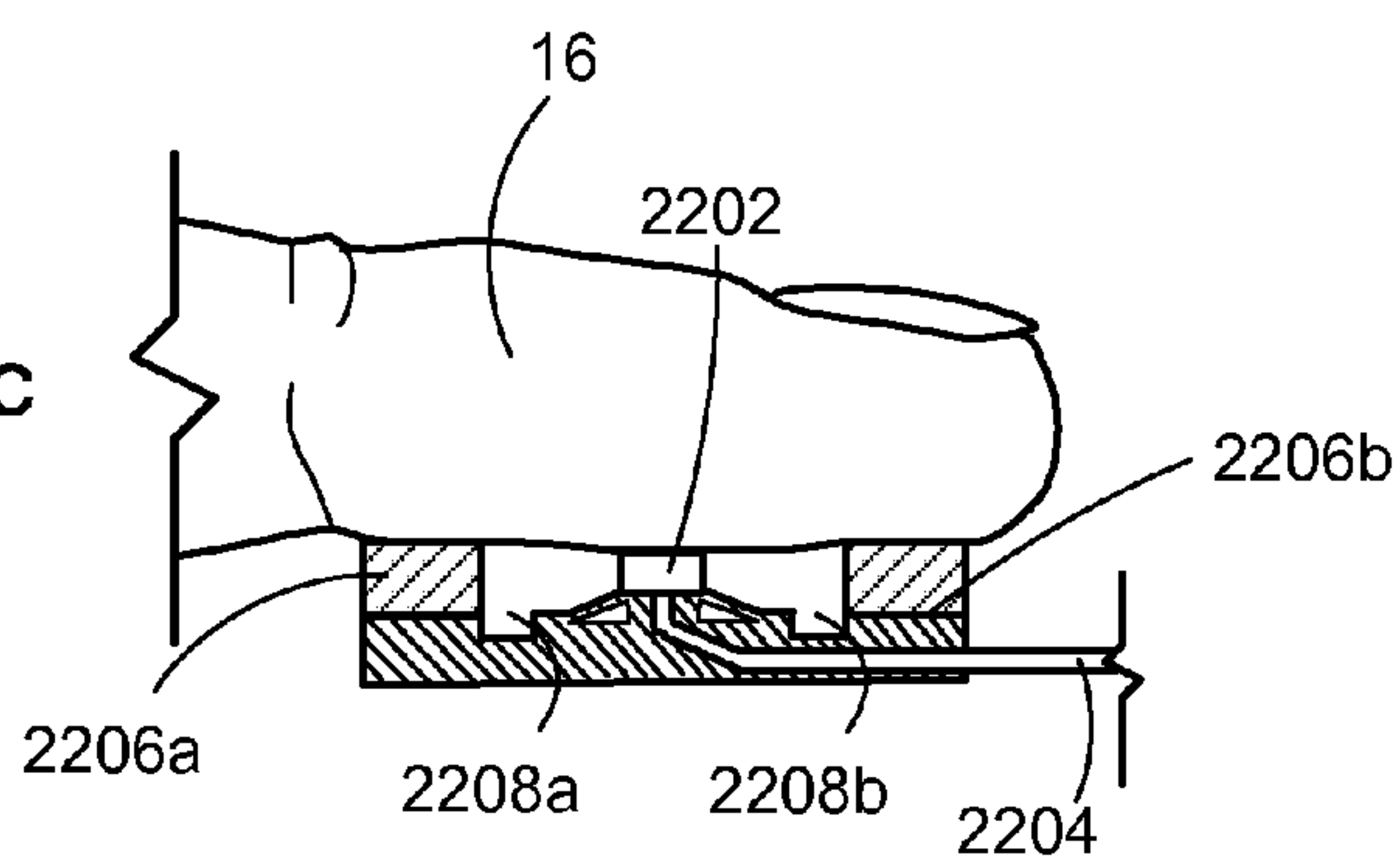

Figure 35

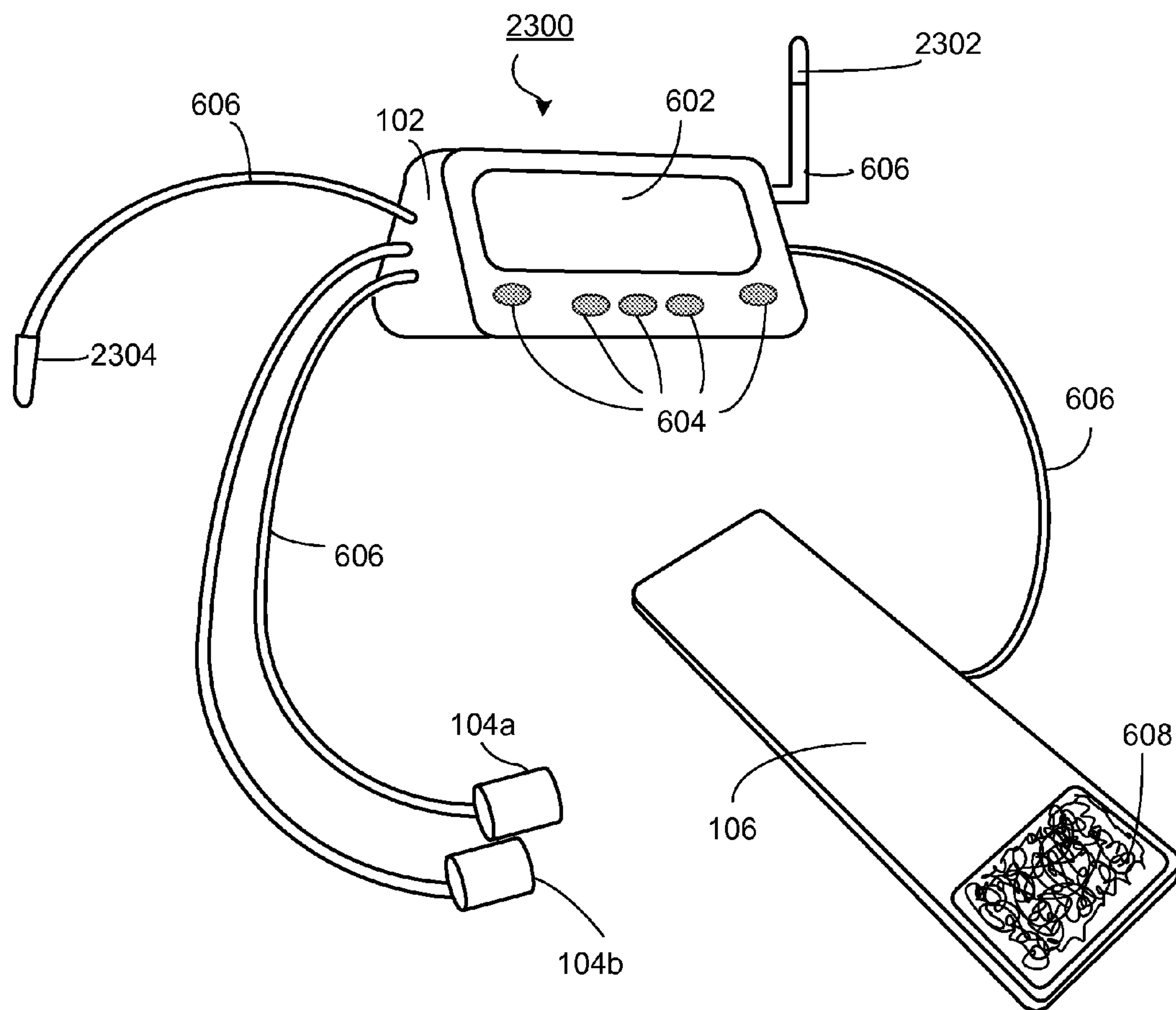

Figure 36a

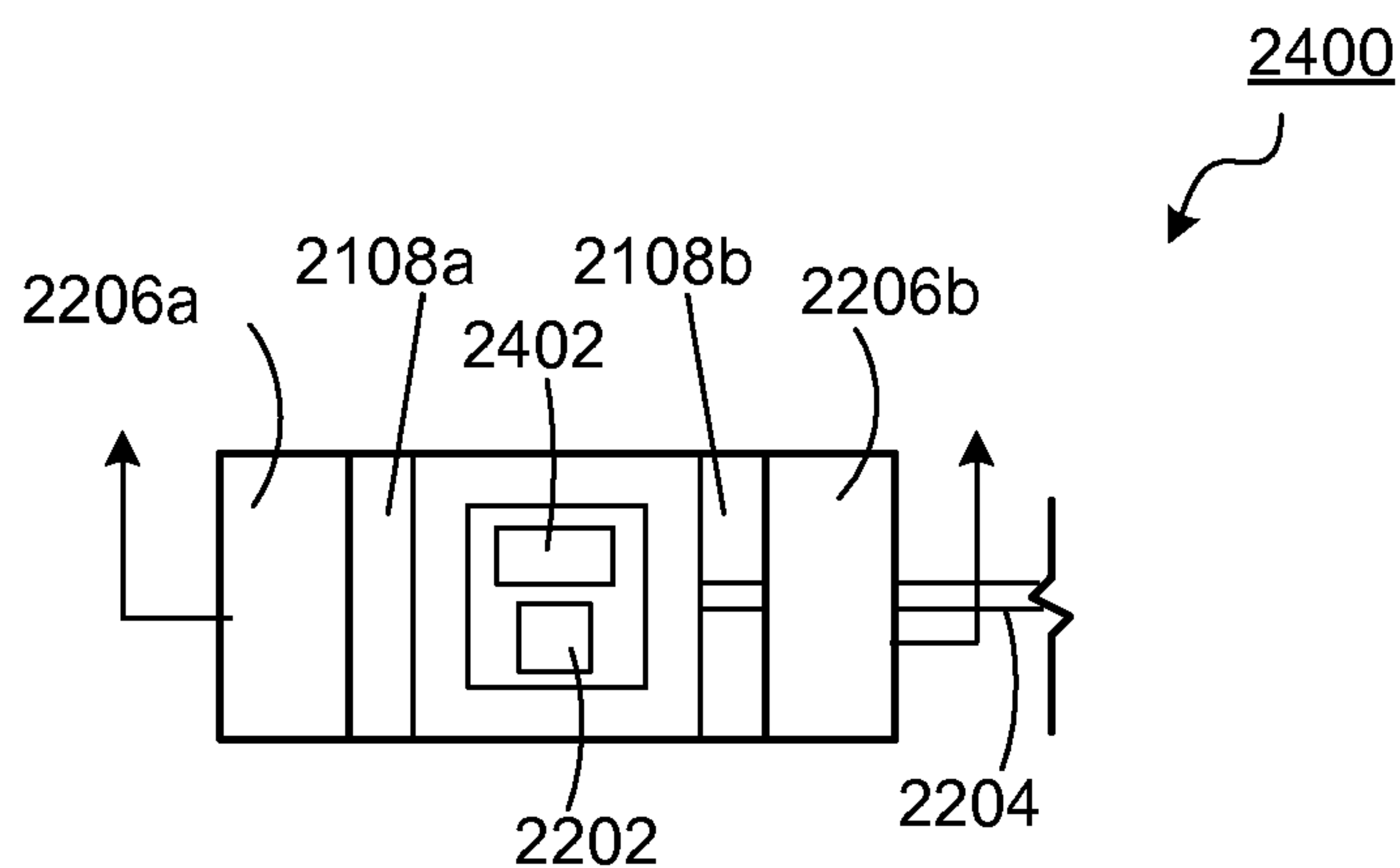

Figure 36b

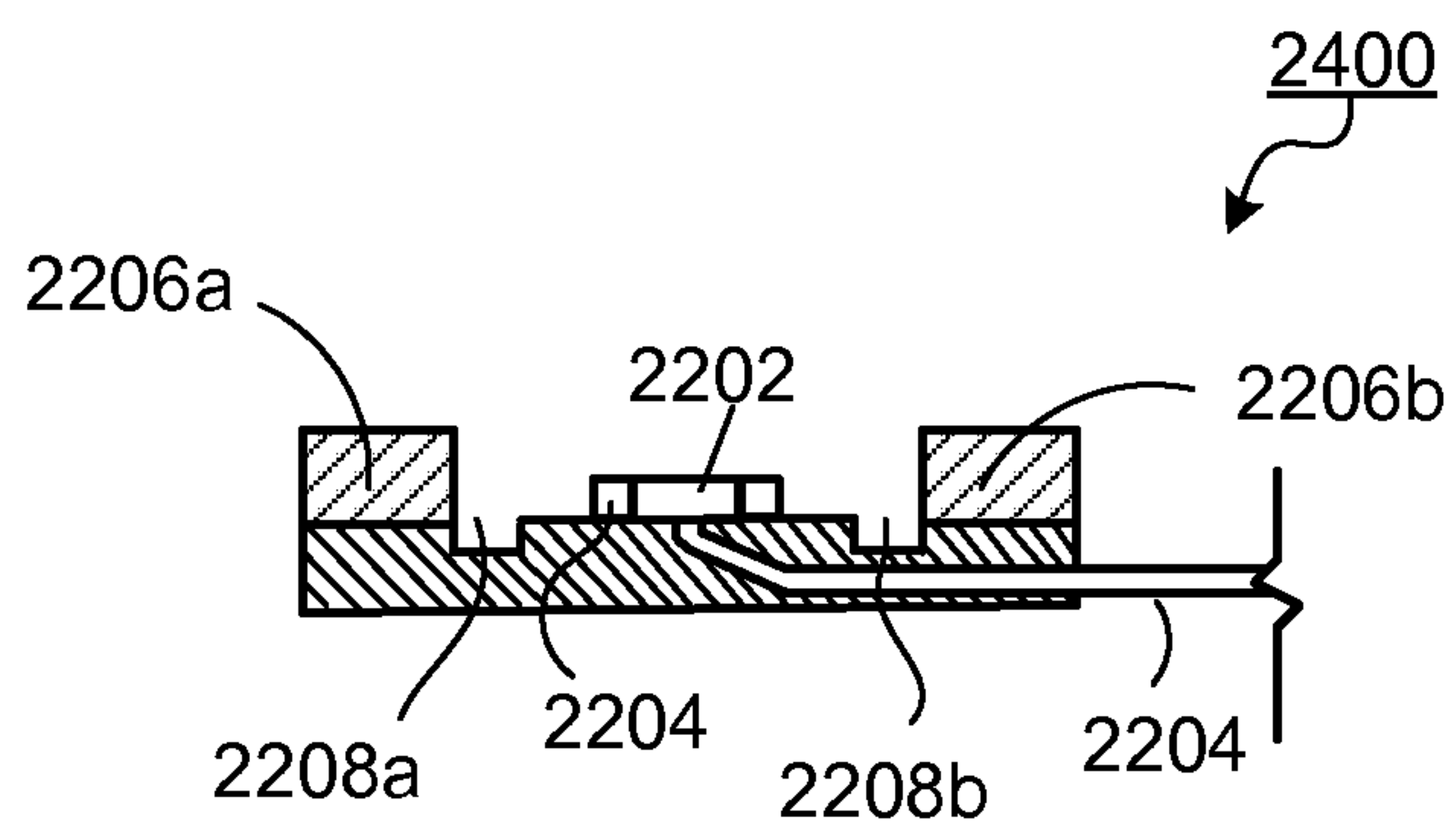

Figure 36c

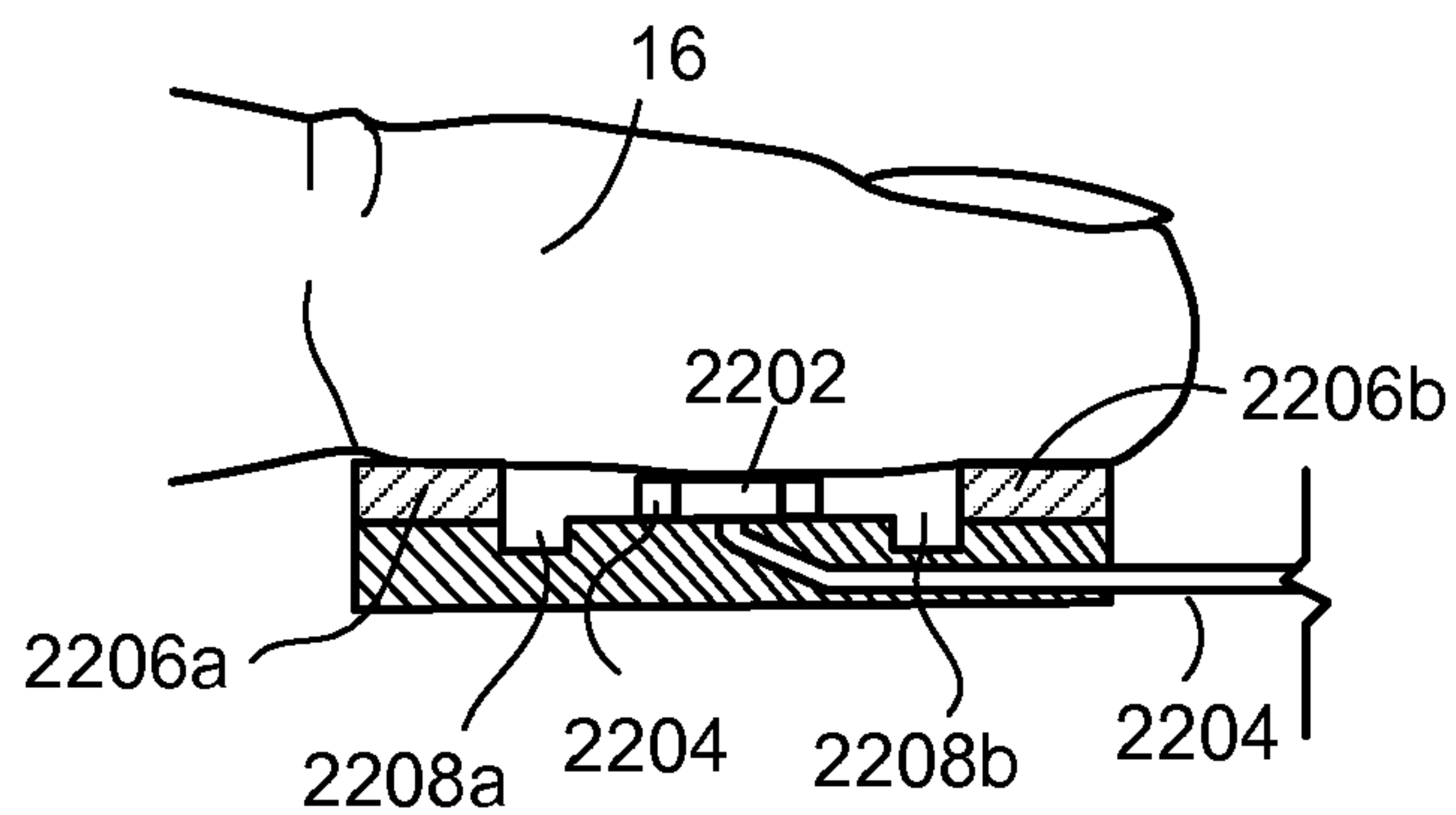

Figure 37a

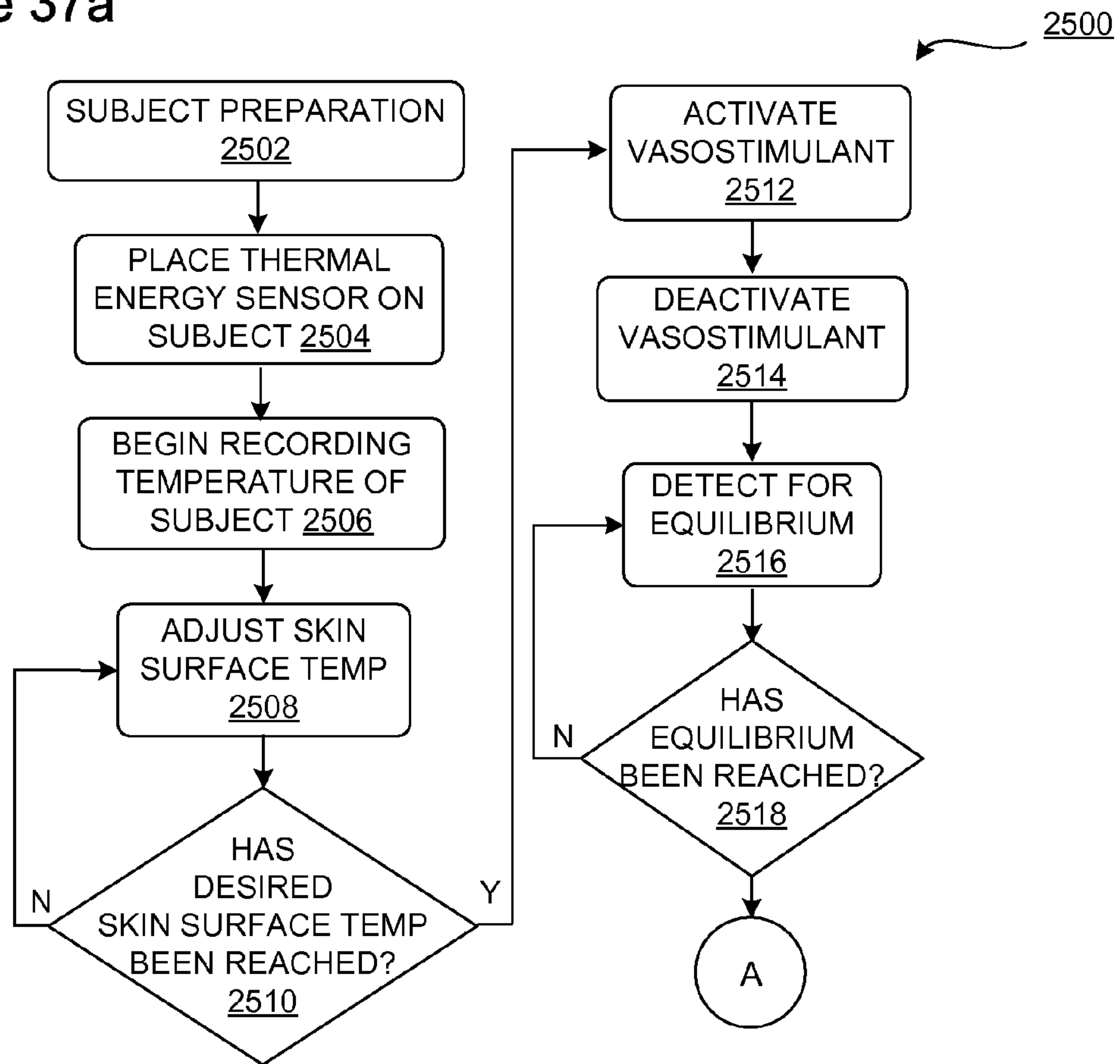

Figure 37b

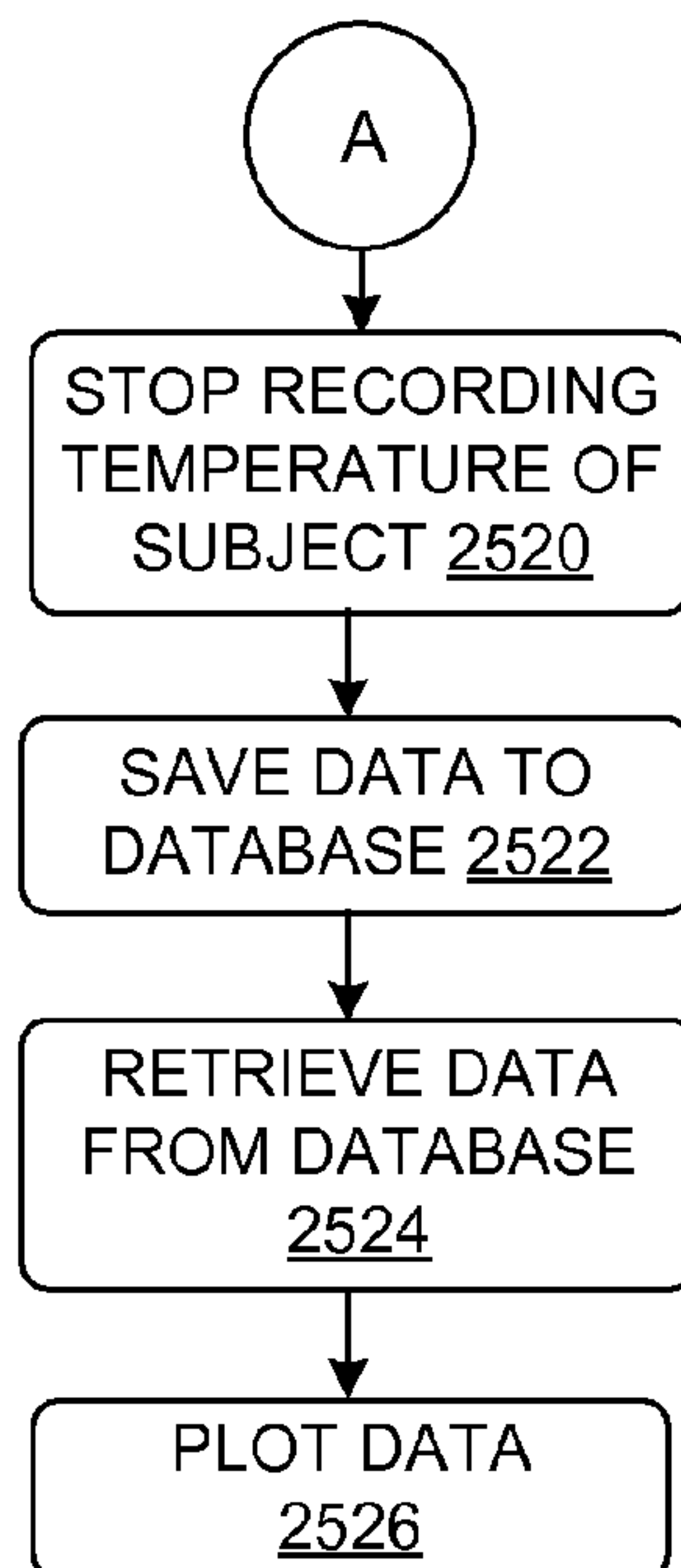

Figure 38a

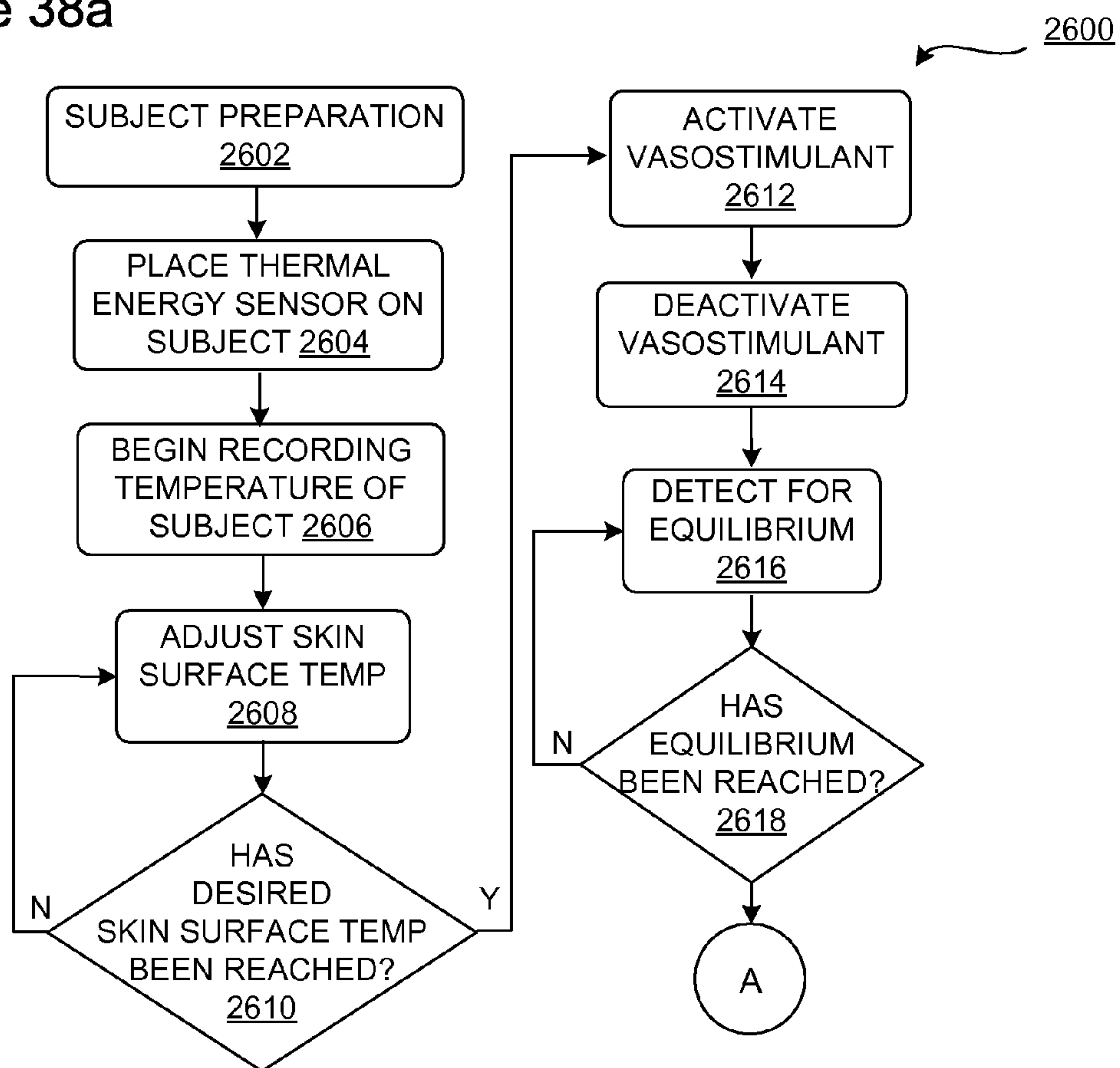

Figure 38b

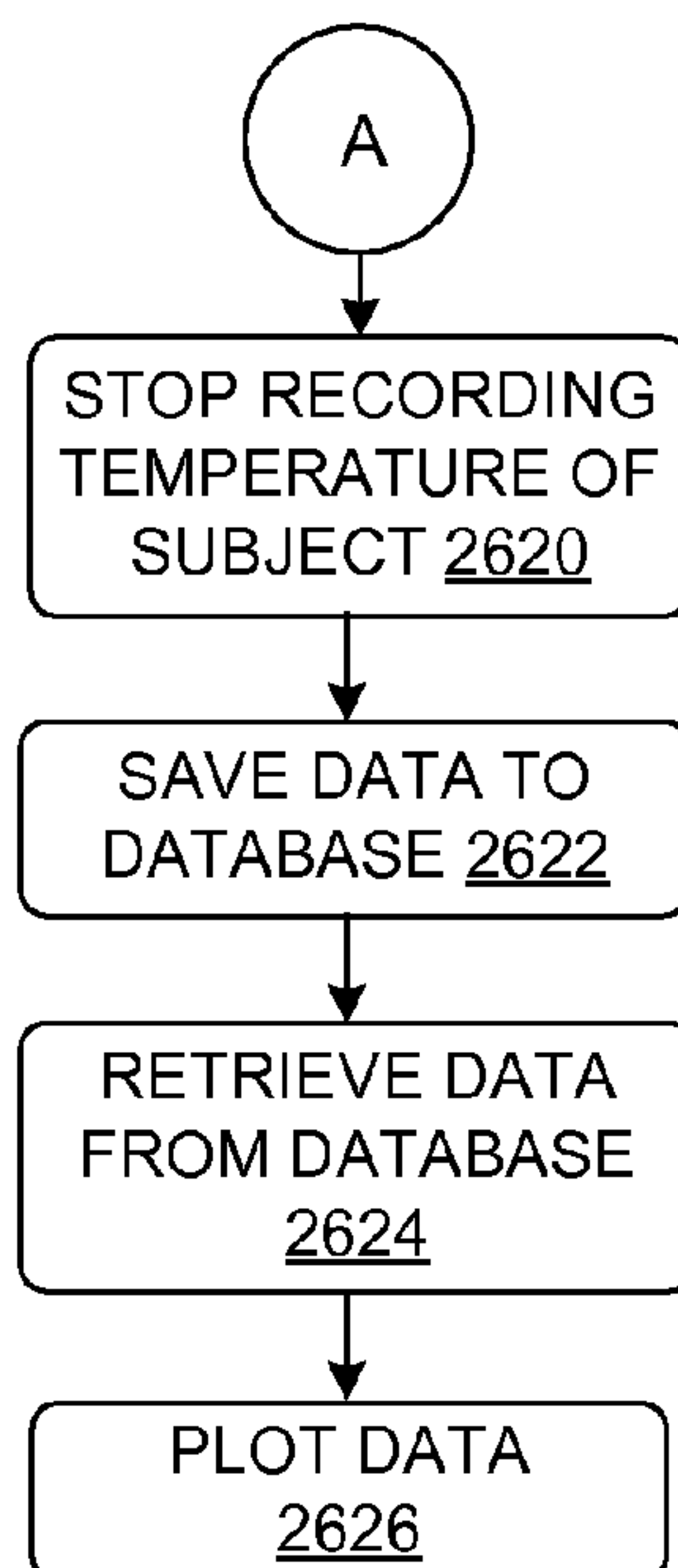

Figure 38c

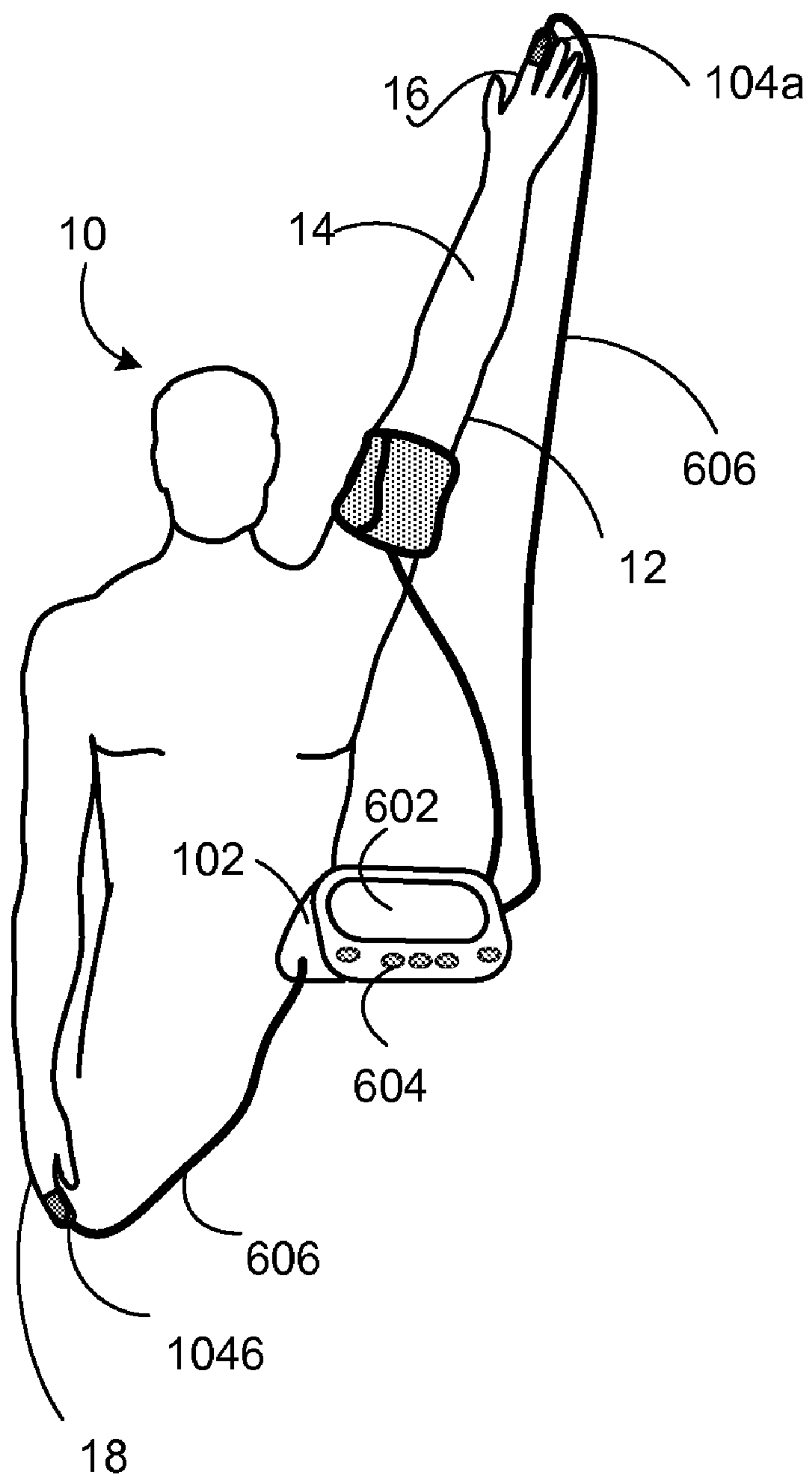



Figure 38d

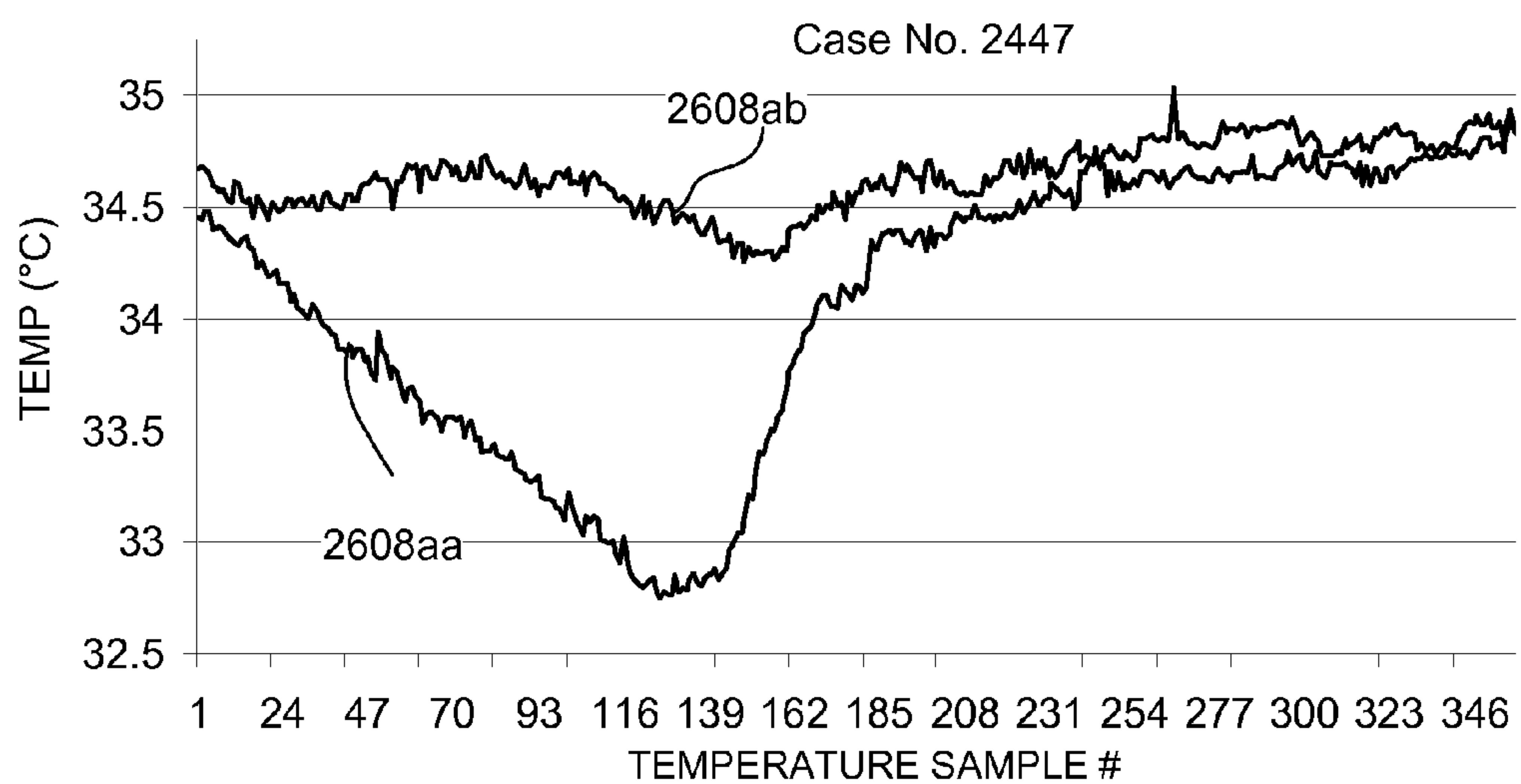

Figure 38e

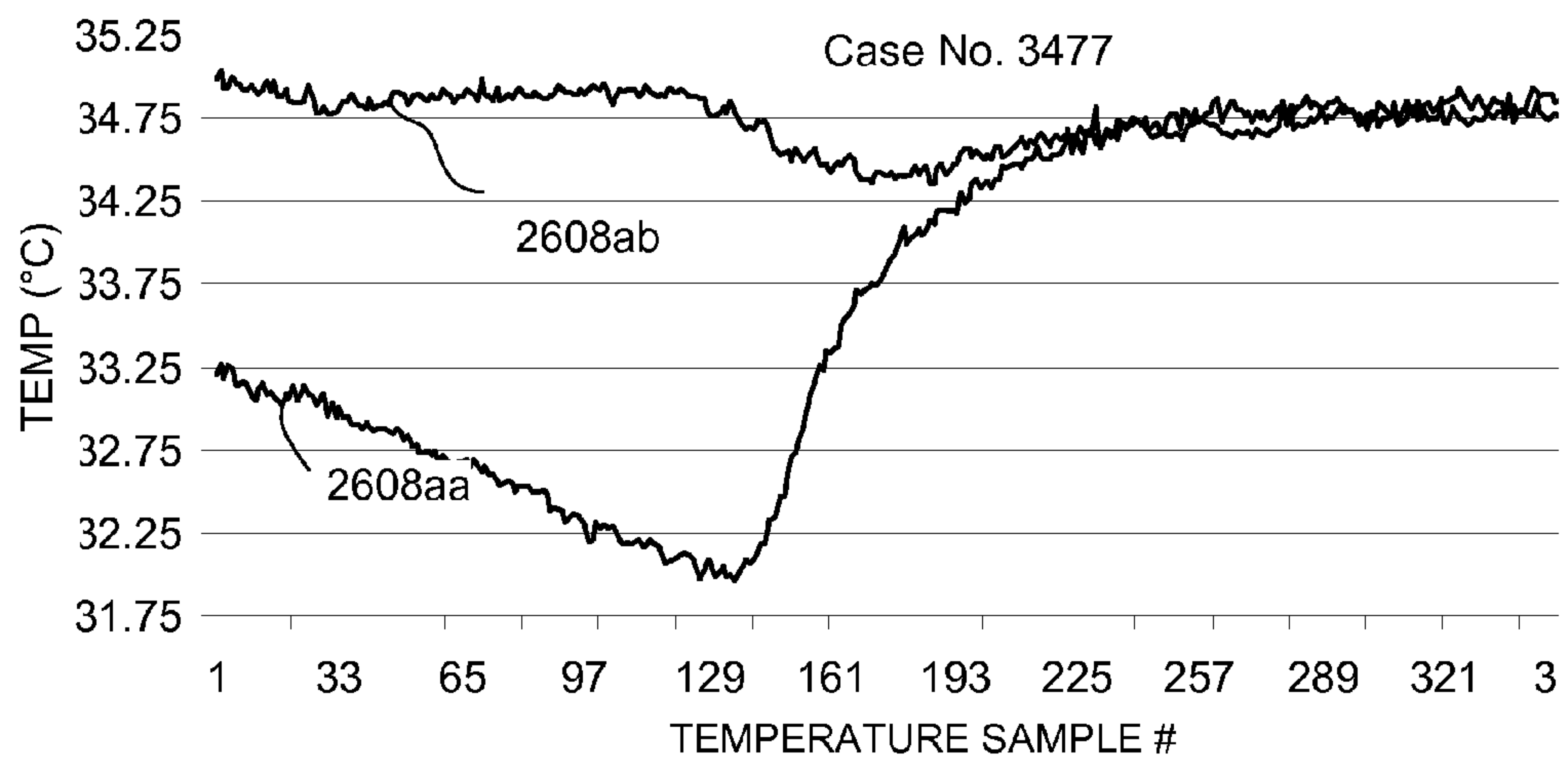

Figure 39

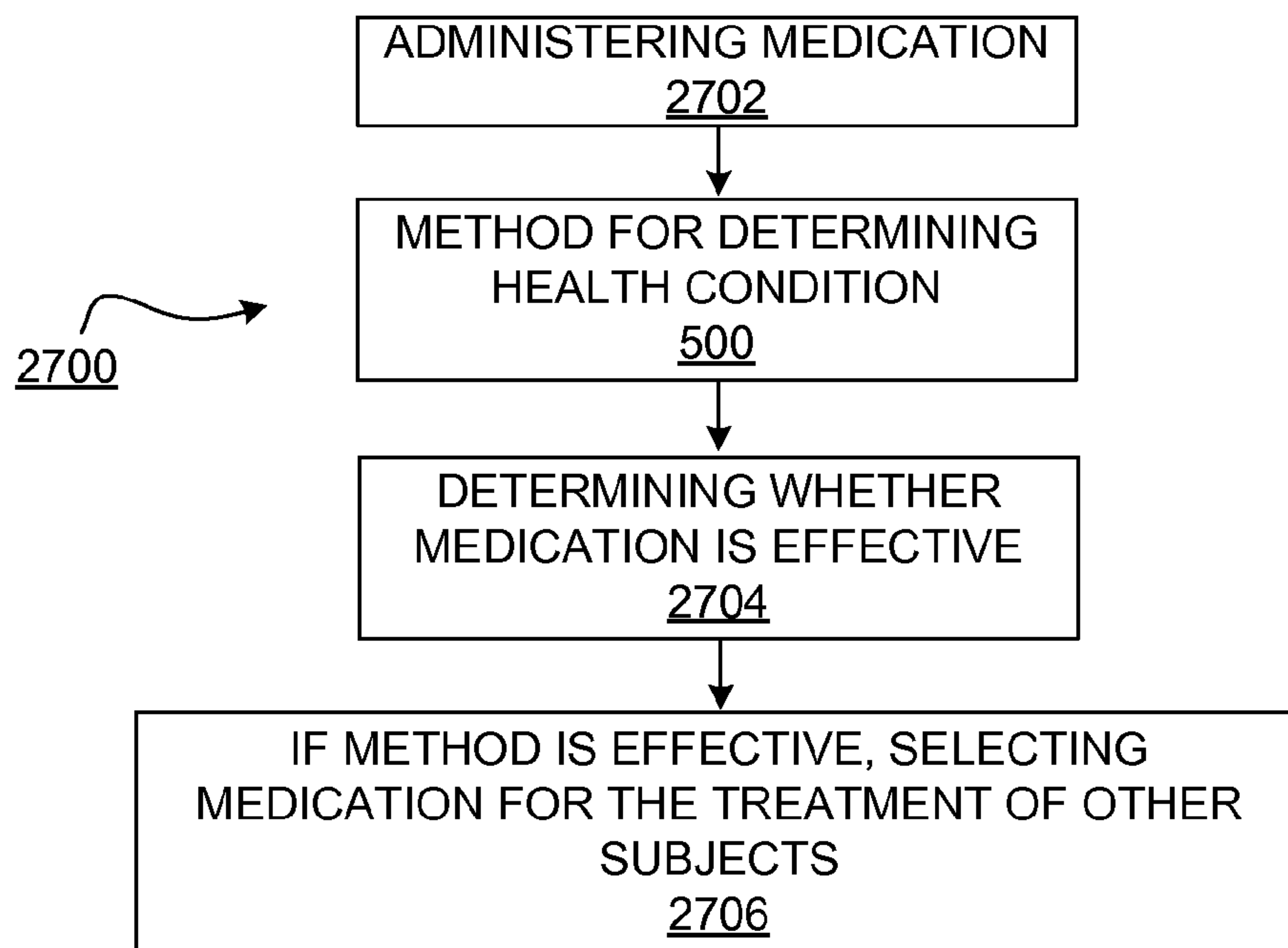

Figure 40

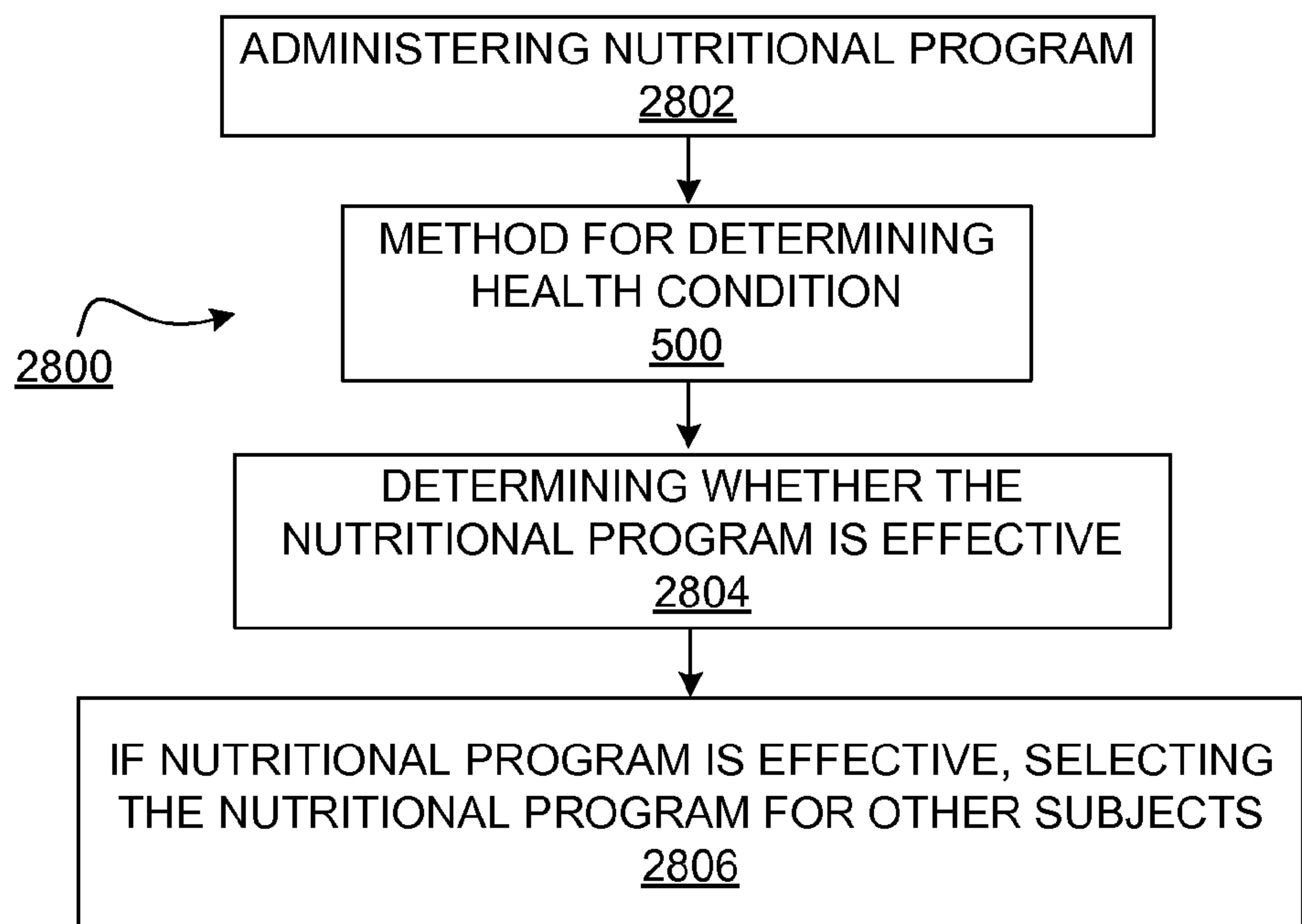

Figure 41

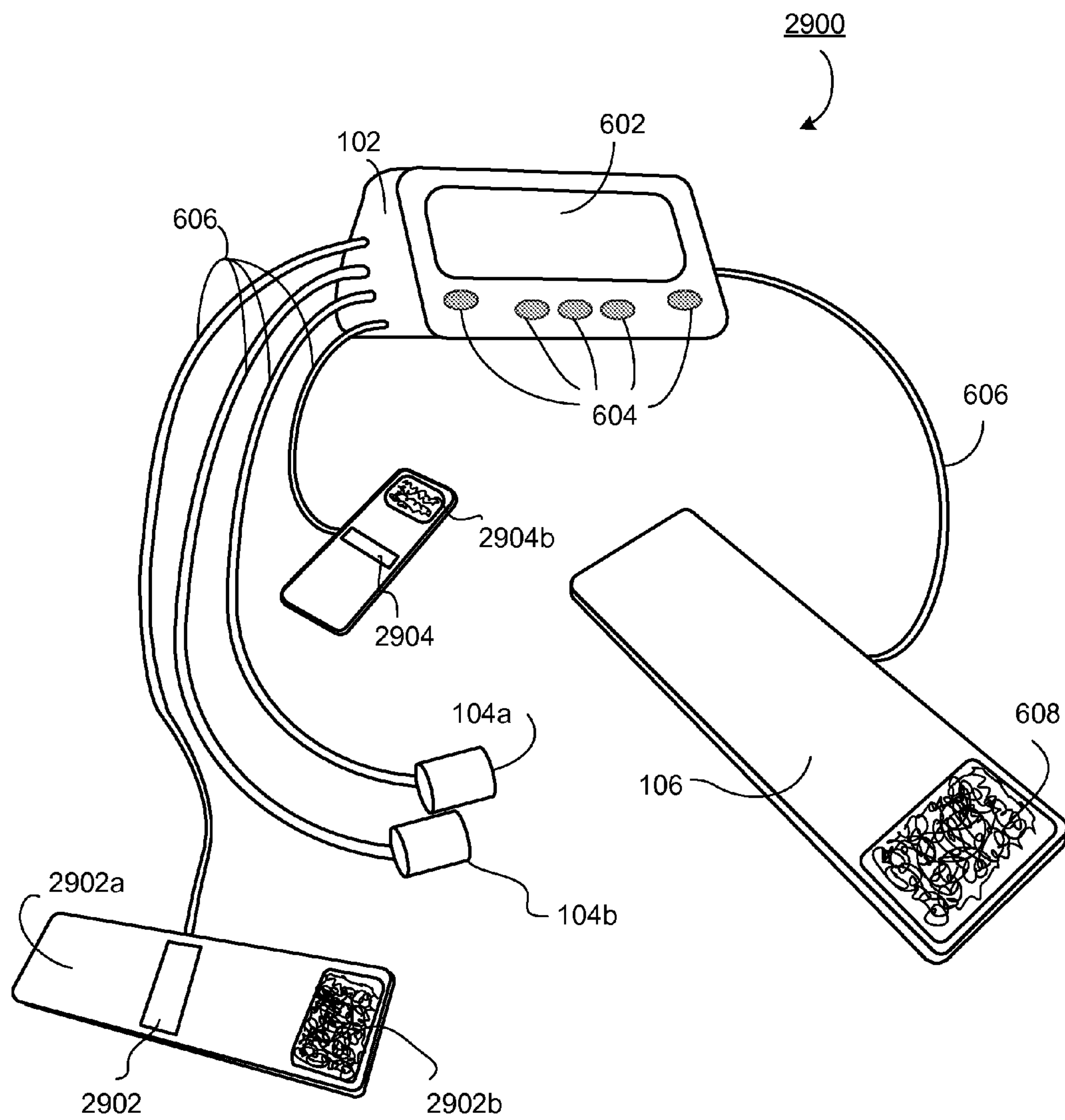

Figure 42a

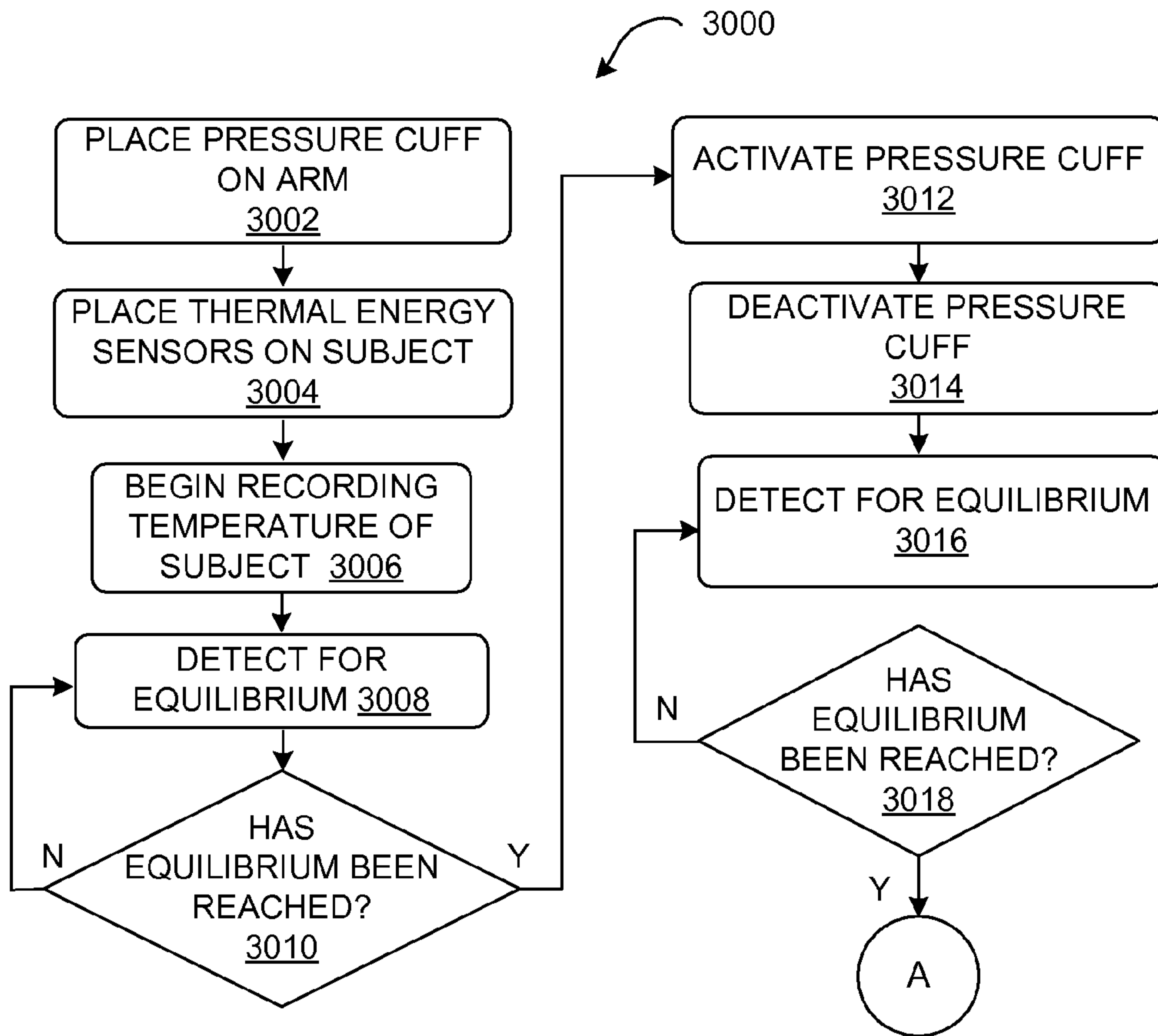

Figure 42b

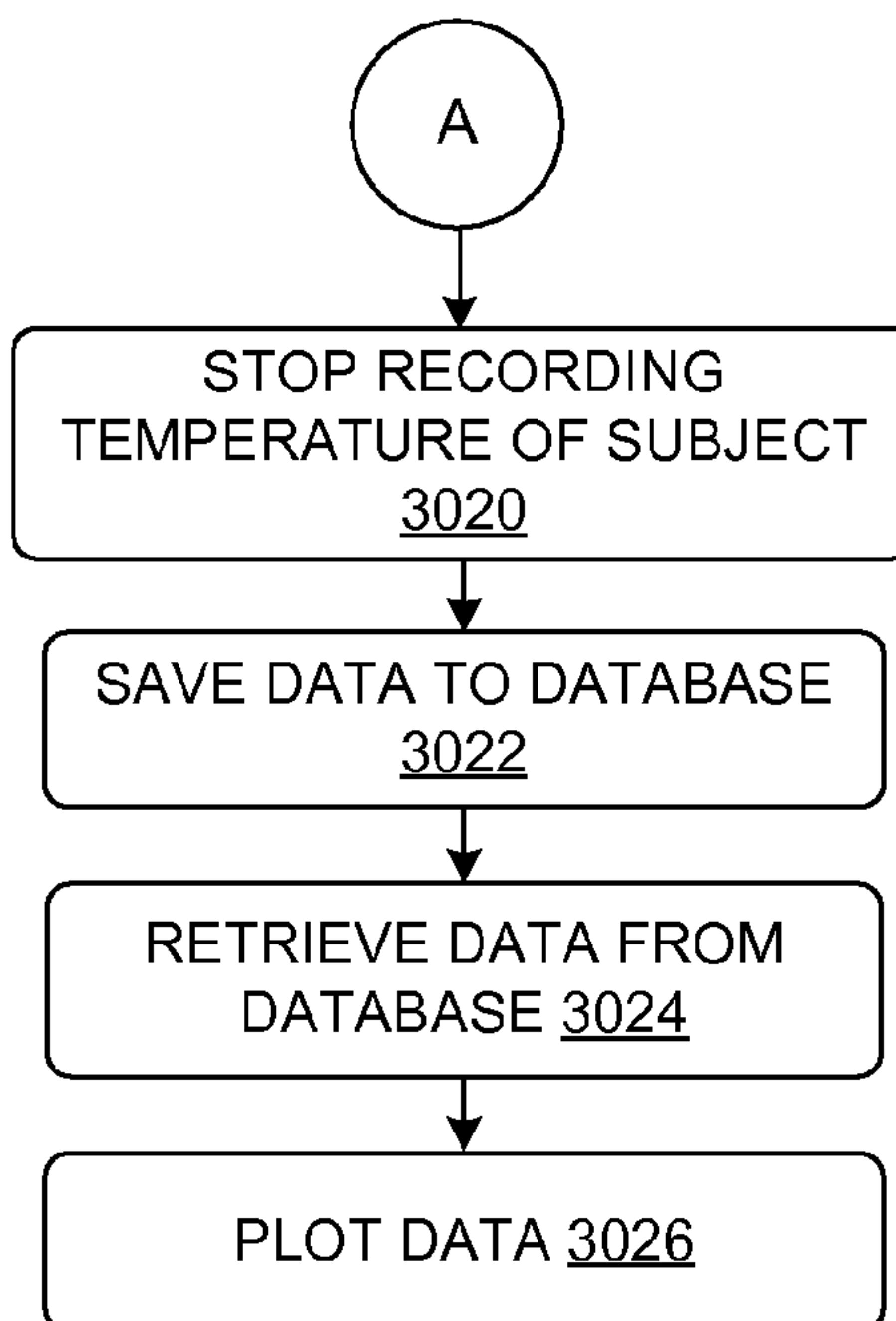

Figure 42c

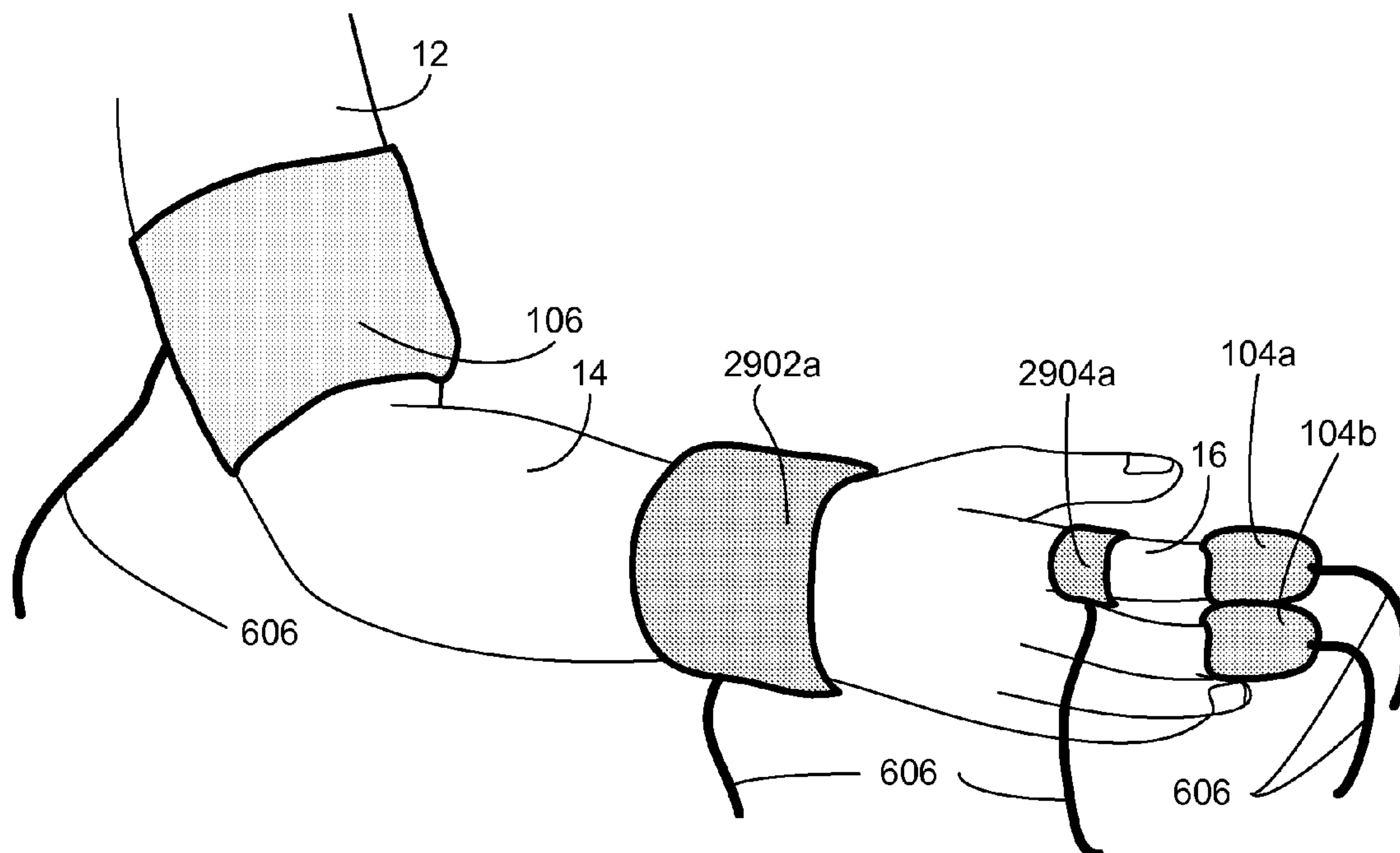

Figure 43a

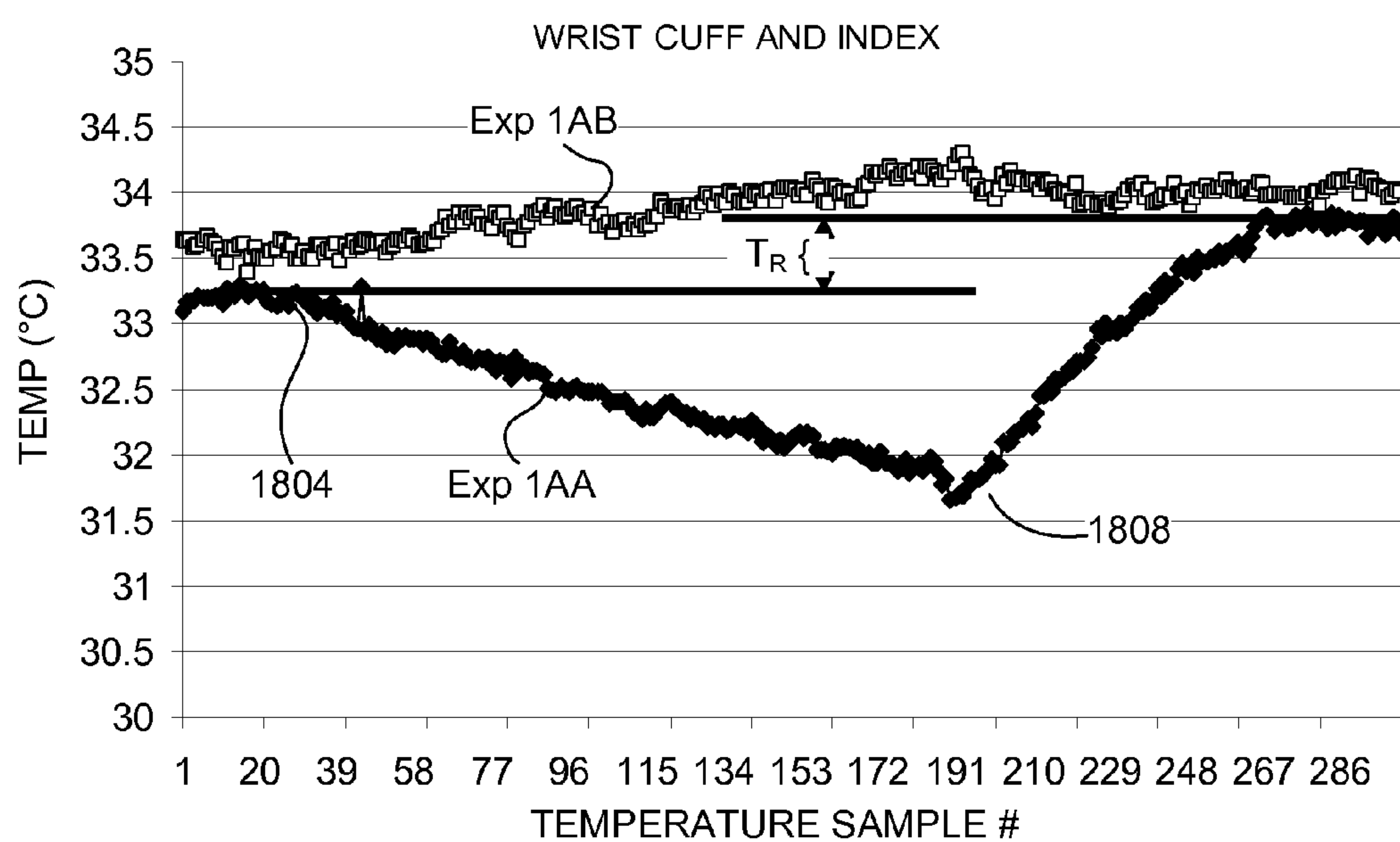

Figure 43b

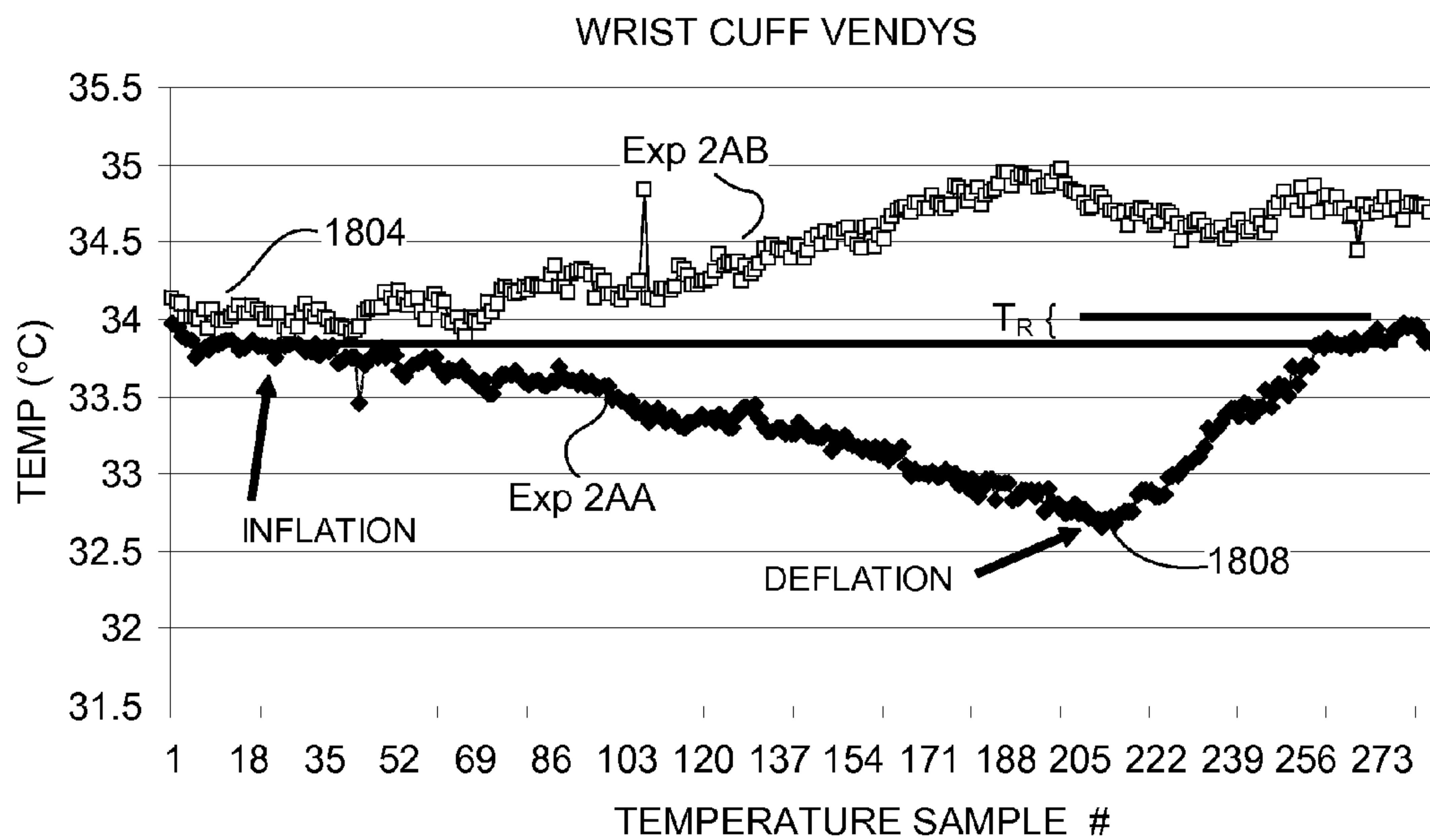

Figure 43c

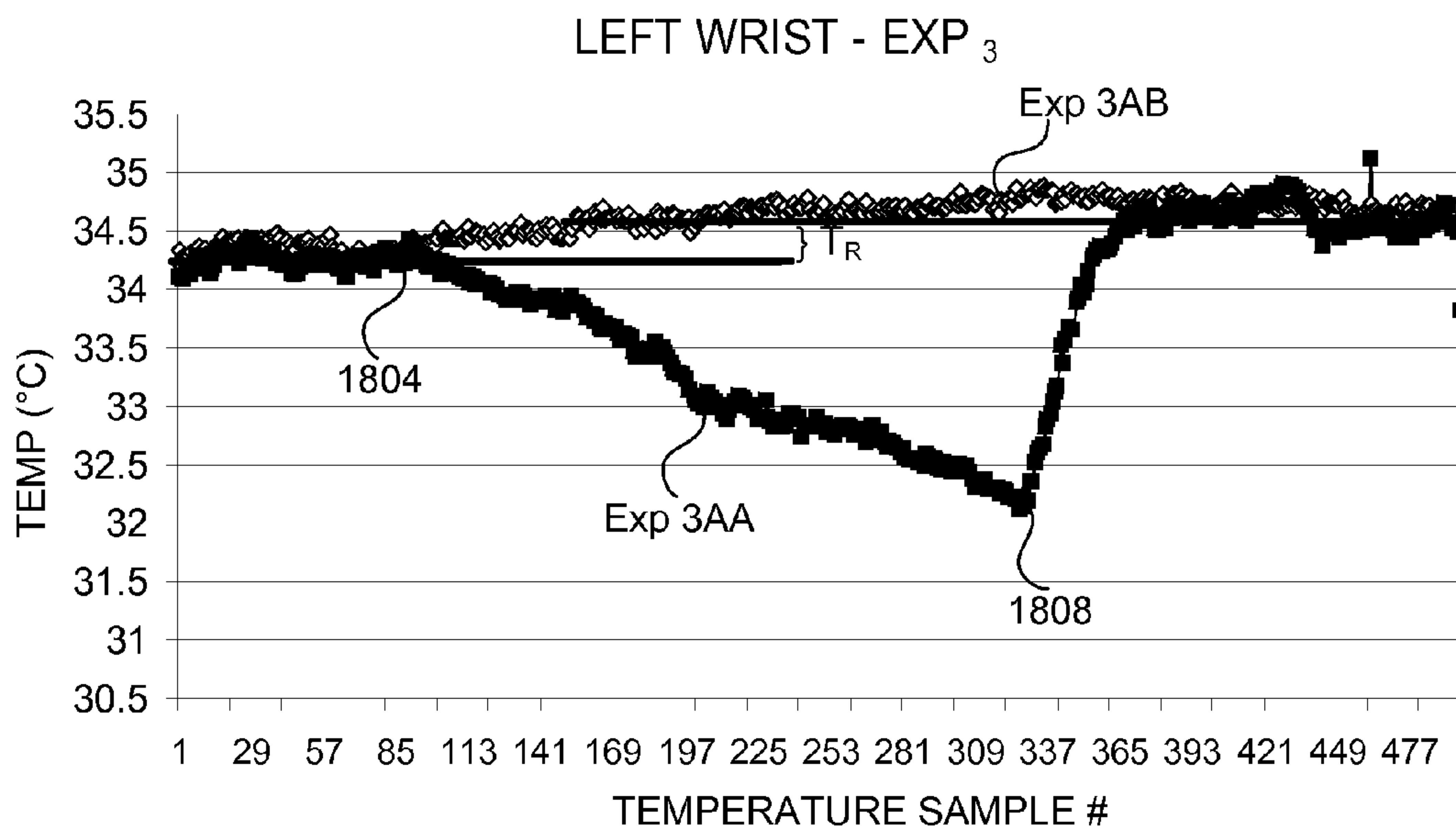
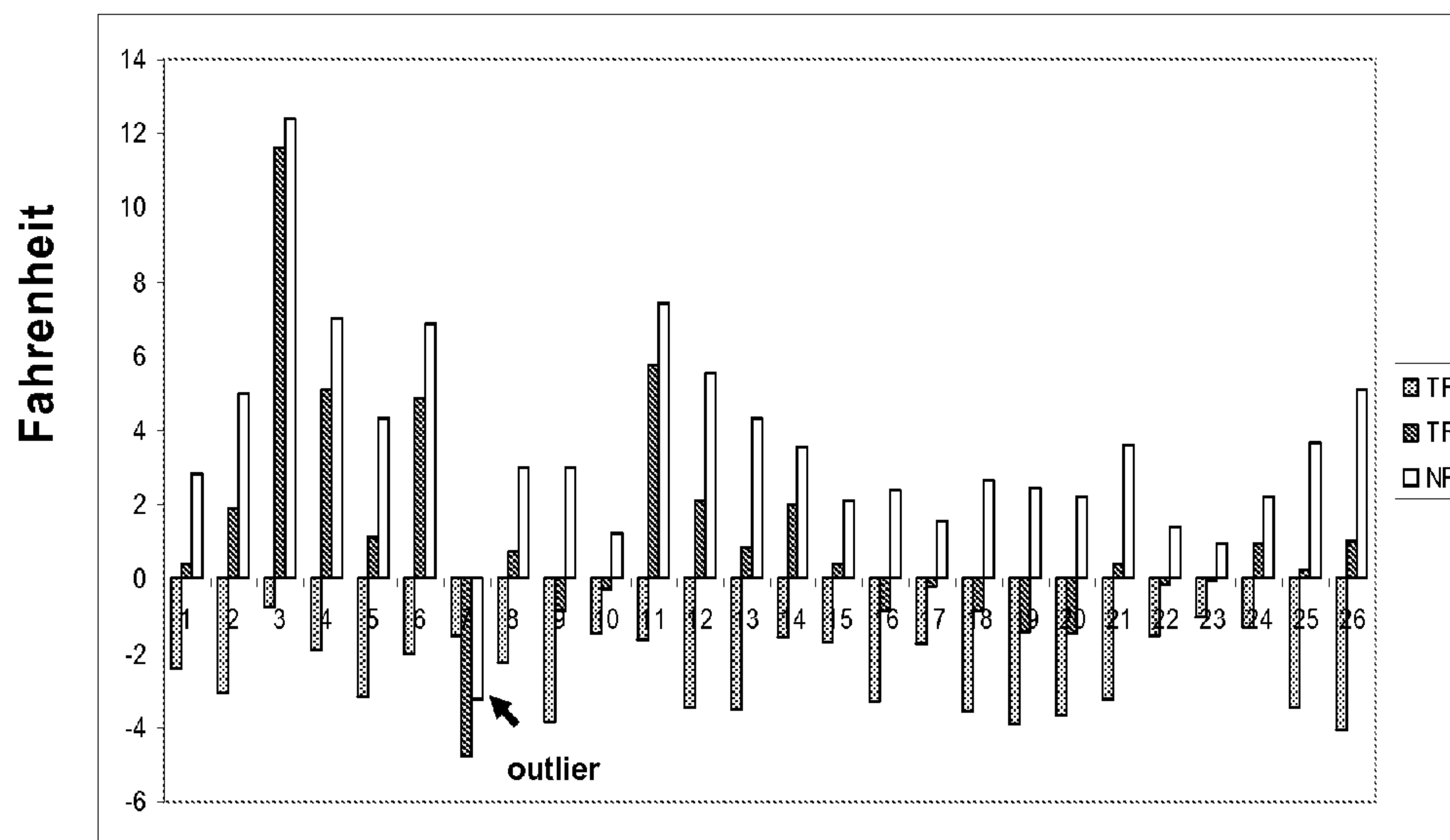



Figure 44a



TF Mean=2.50±1.03 TF Median=-2.331 TR Mean=1.10±3.05 TR Median=0.432 NP Mean=3.60±2.84 NP Median=2.997  
 TTF=Mean 237±120 TTR=Mean 114±40

Figure 44b

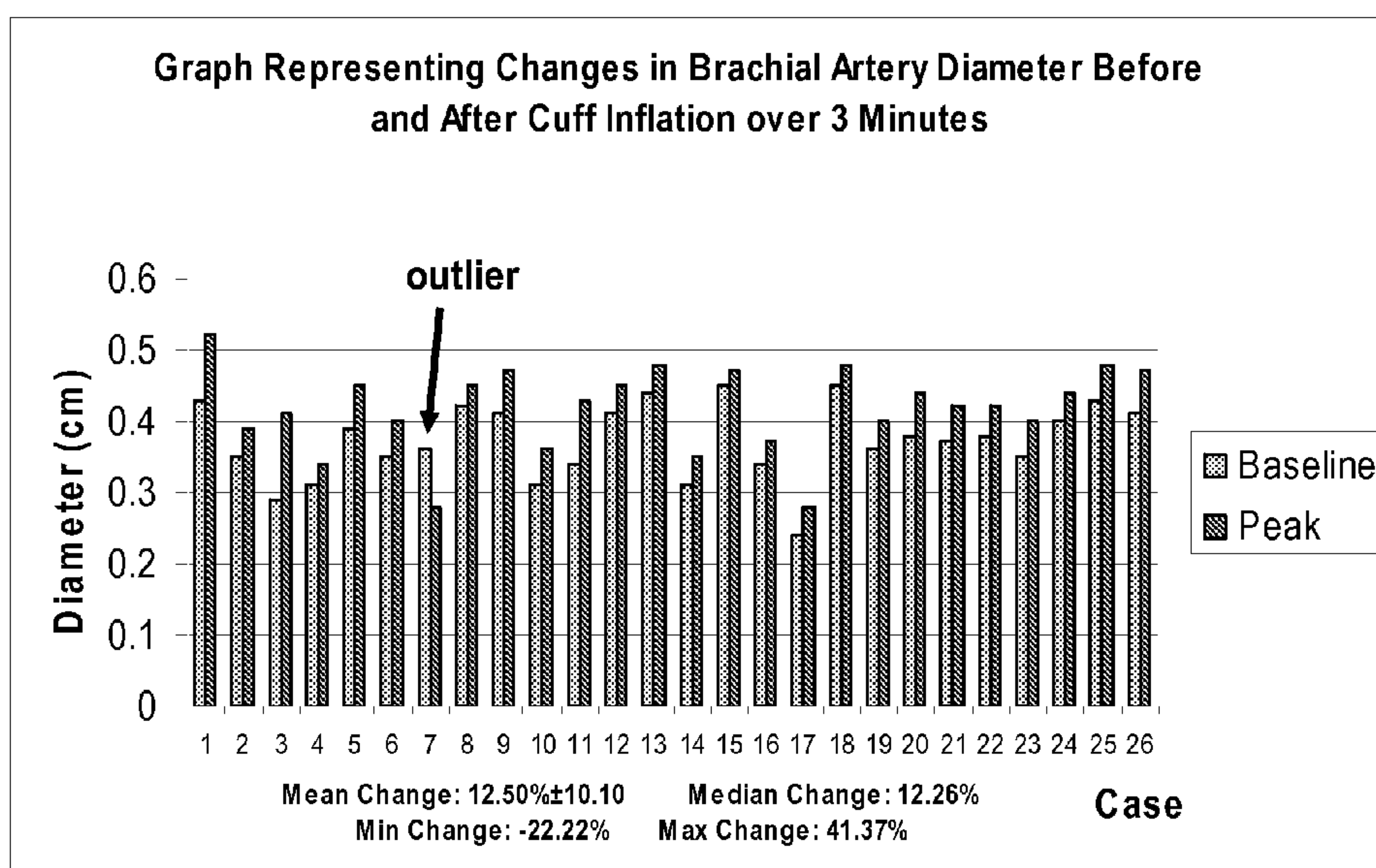

Figure 45

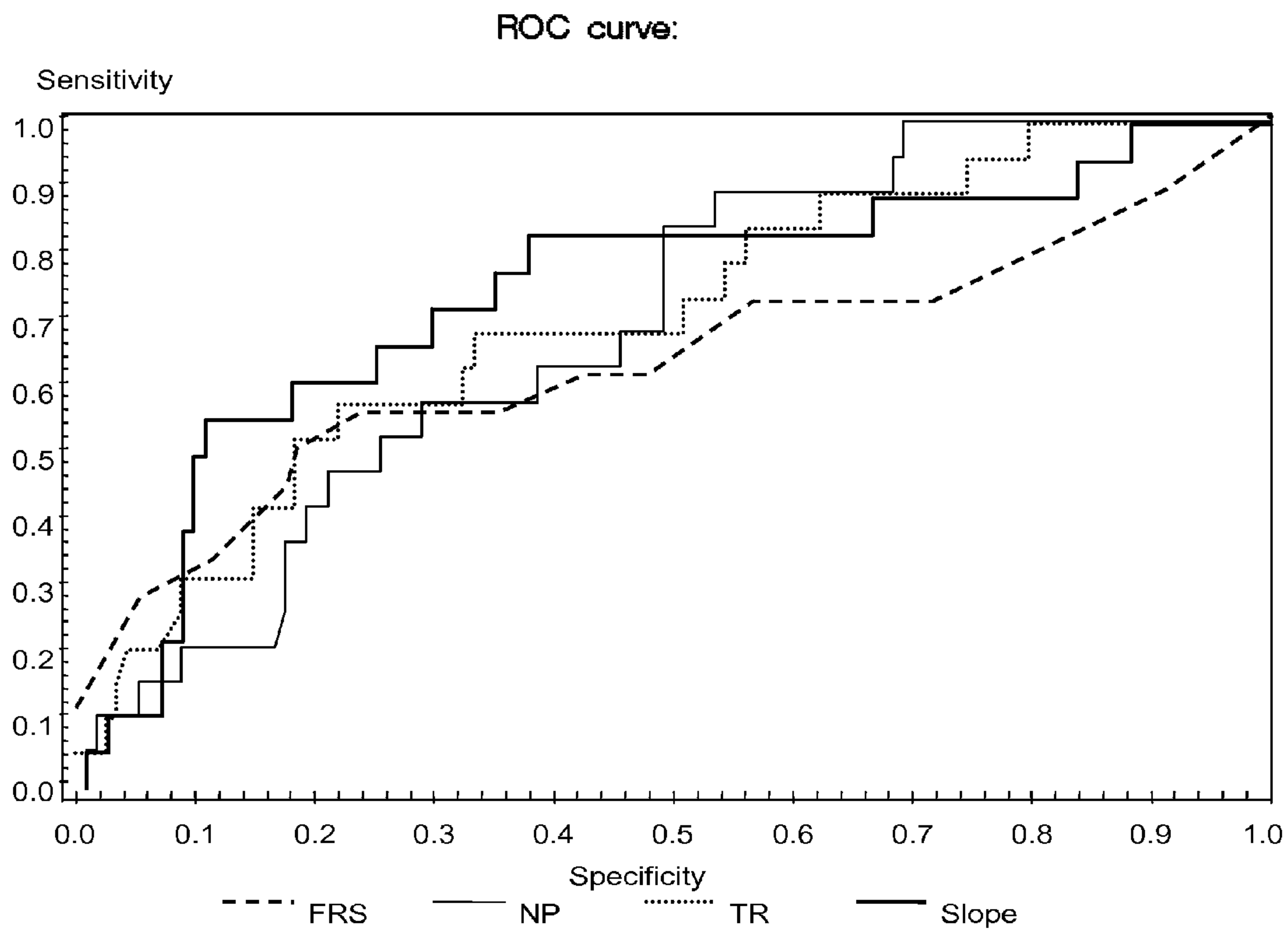

Figure 46a

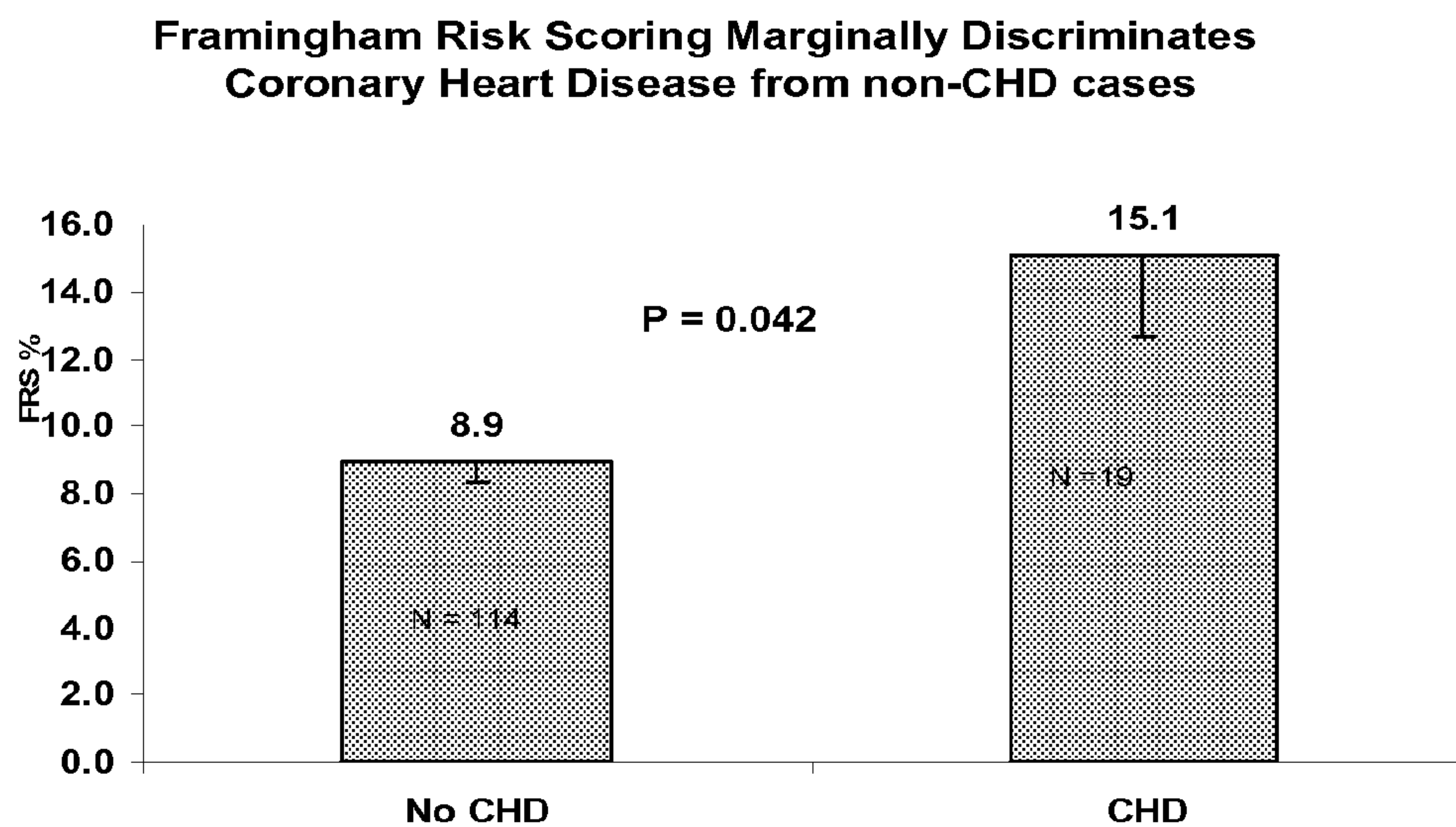

Figure 46b

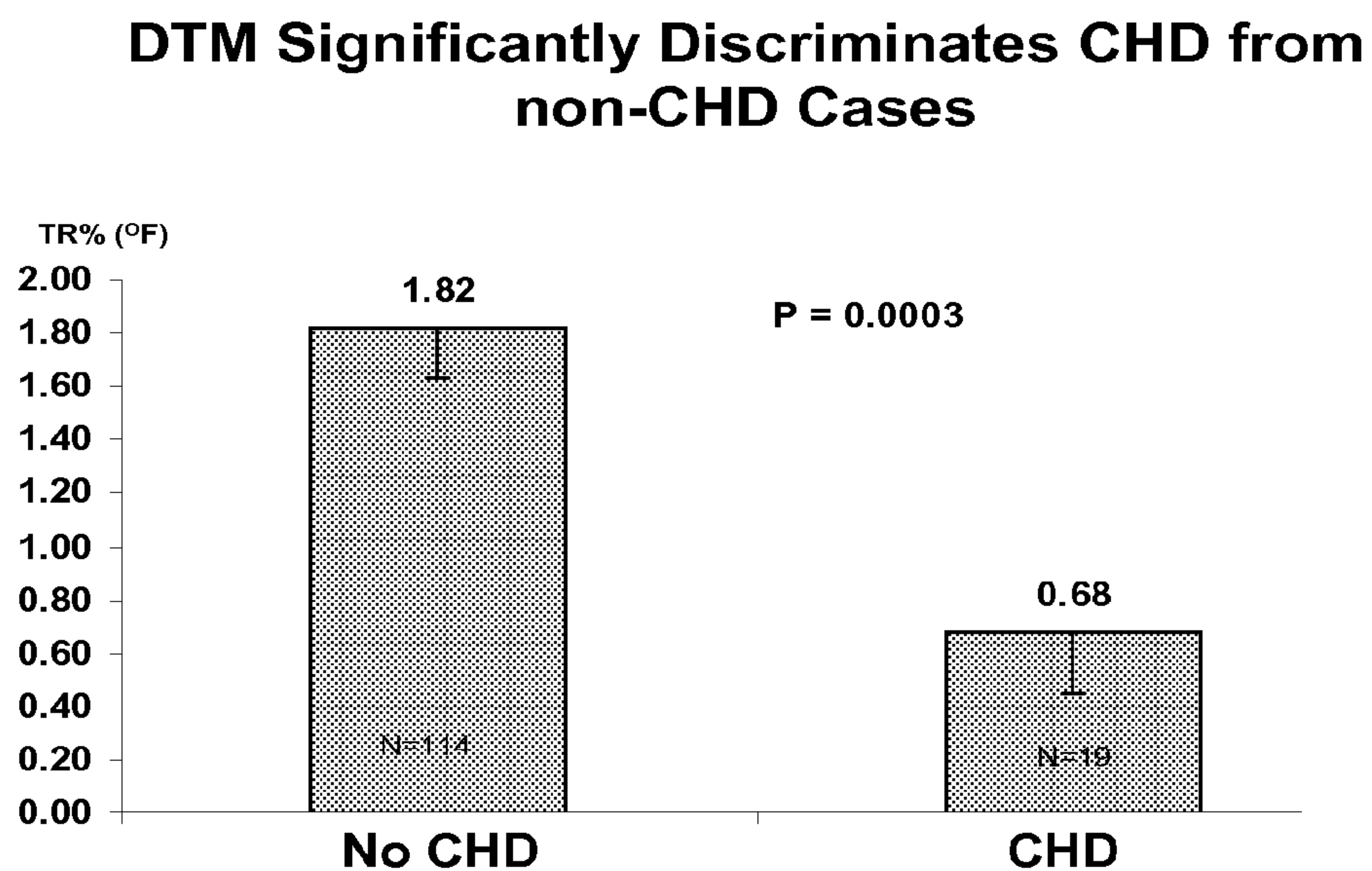

Figure 47a

**DTM Shows Consistent Graded Relationship with Framingham Estimates of 10 yr risk**

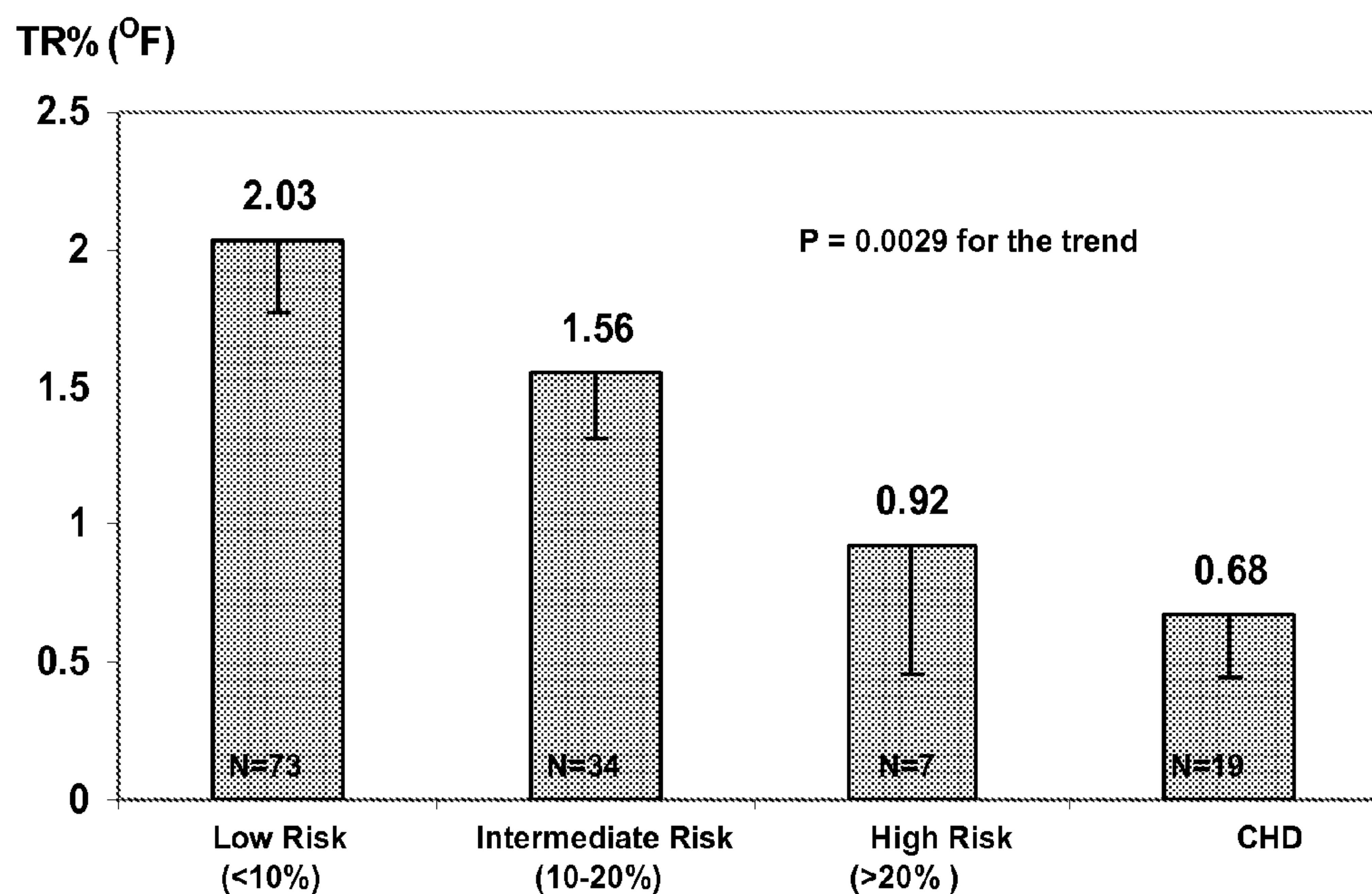

Figure 47b

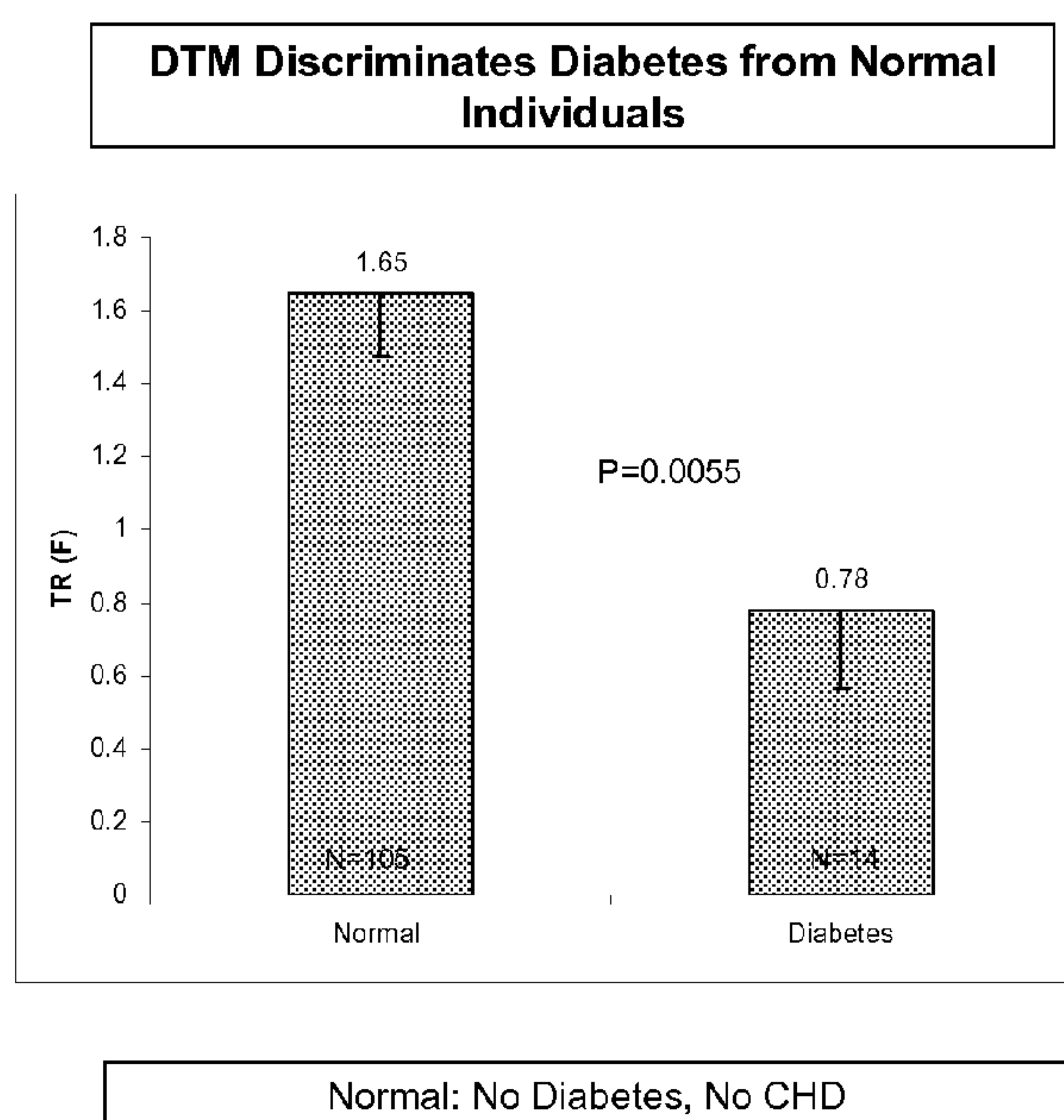

Figure 48

Unlike FRS, DTM Discriminates CHD from CHD Cases in Females and Young (<55y) Populations

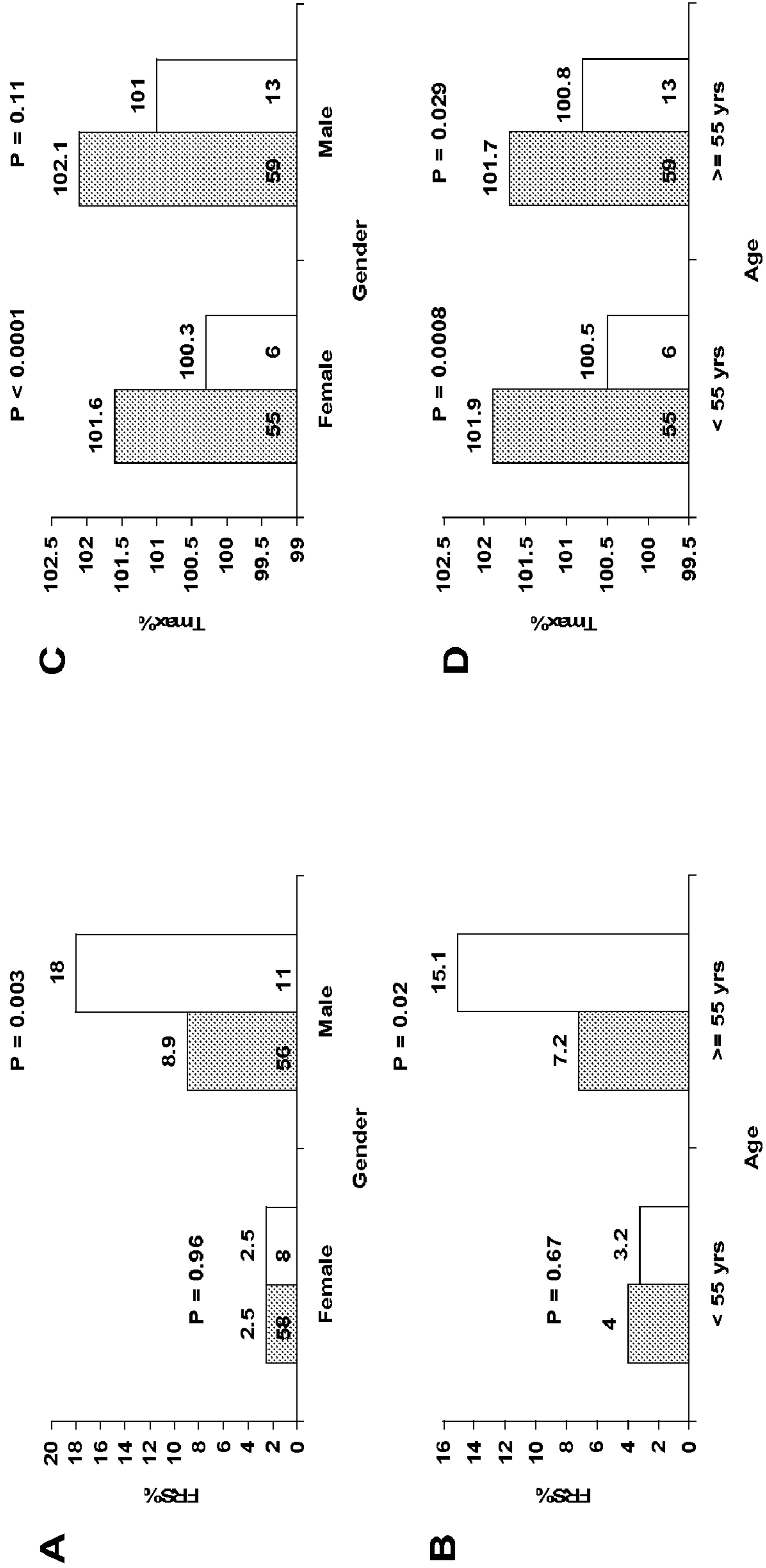
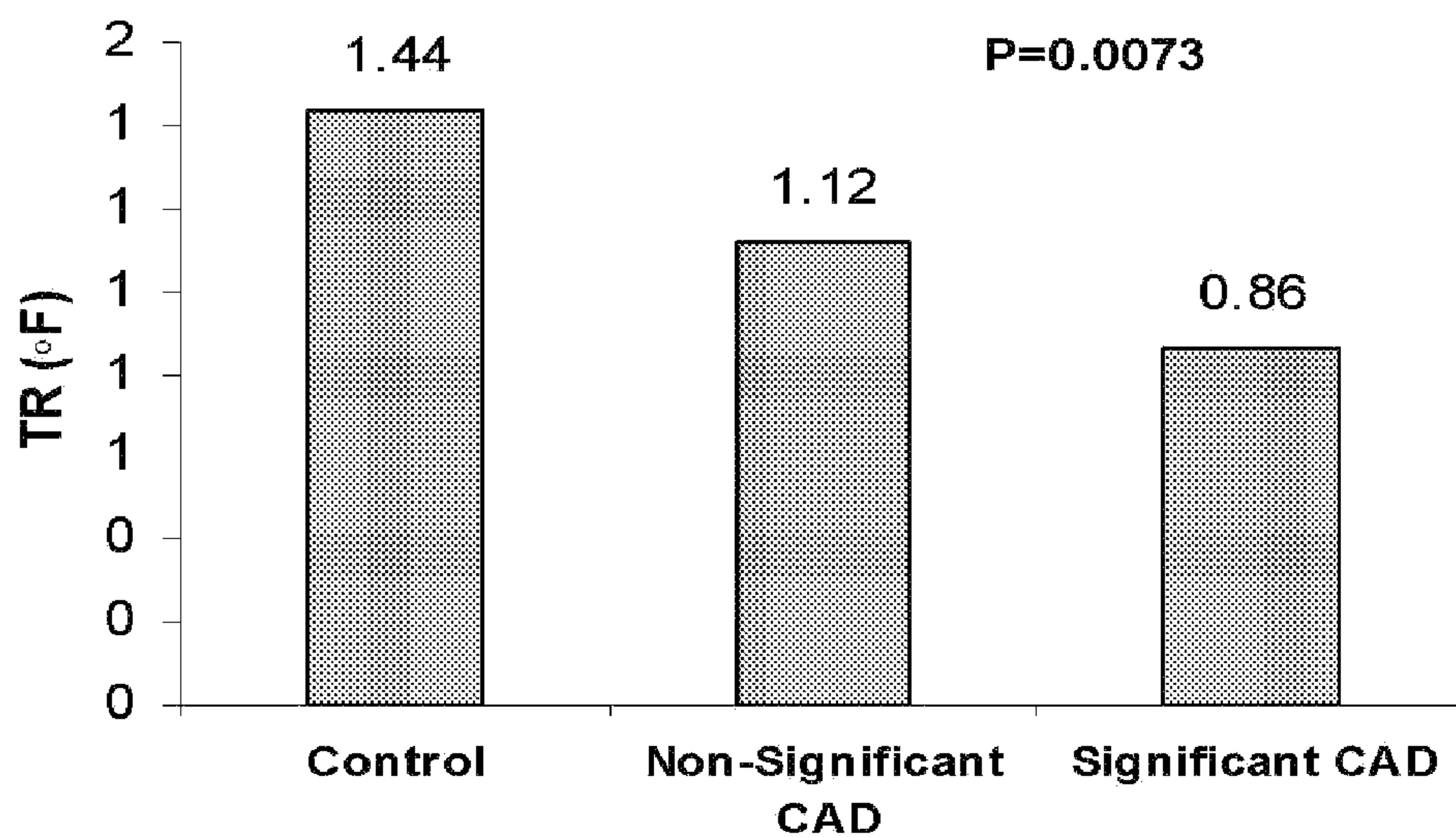



Figure 49a

### Endothelial Dysfunction Measured by Thermal Reactivity Correlates with CAD



TR: Temperature Rebound

Significant CAD:  $\geq 50\%$

Figure 49b

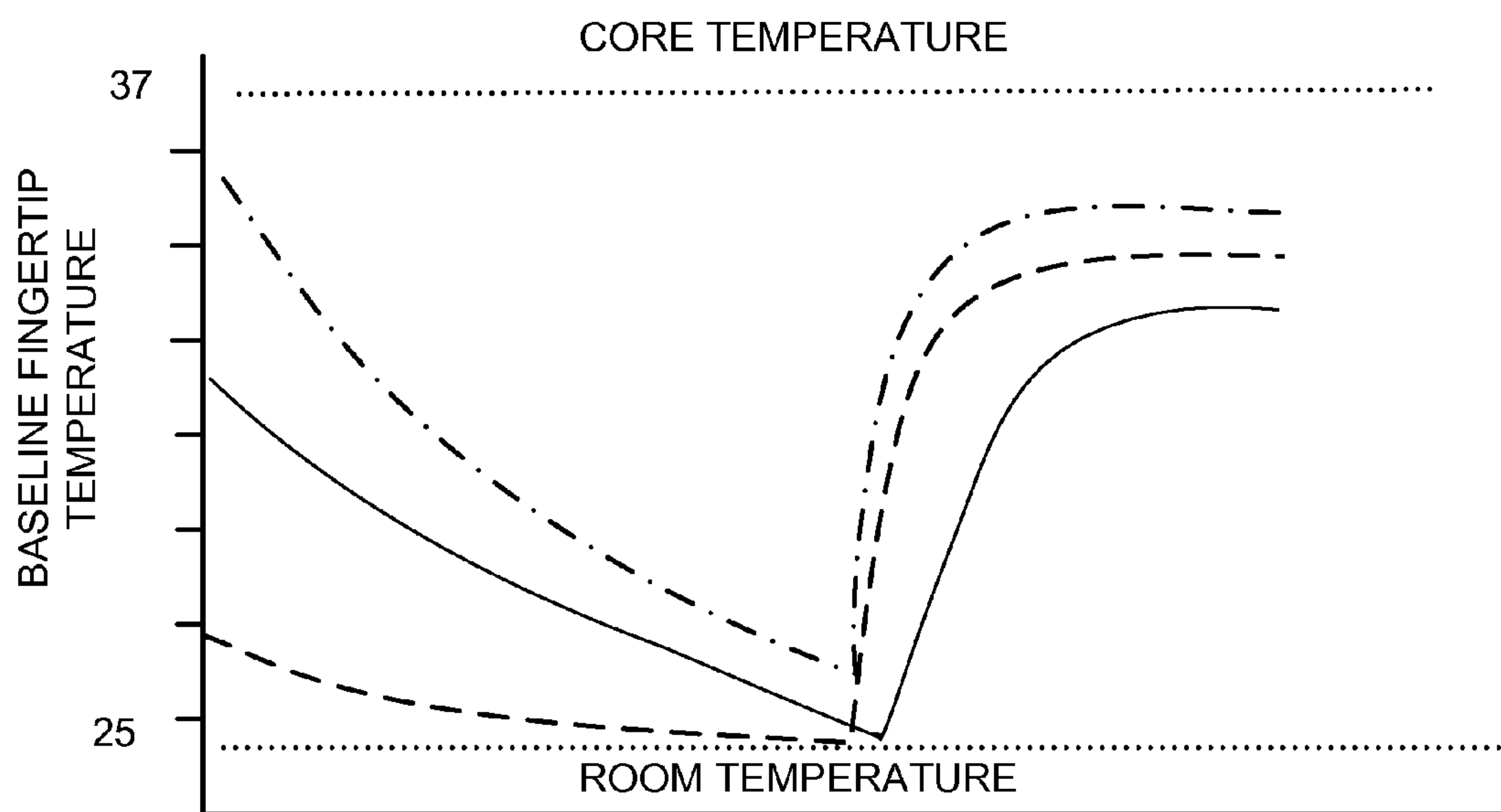



Figure 50

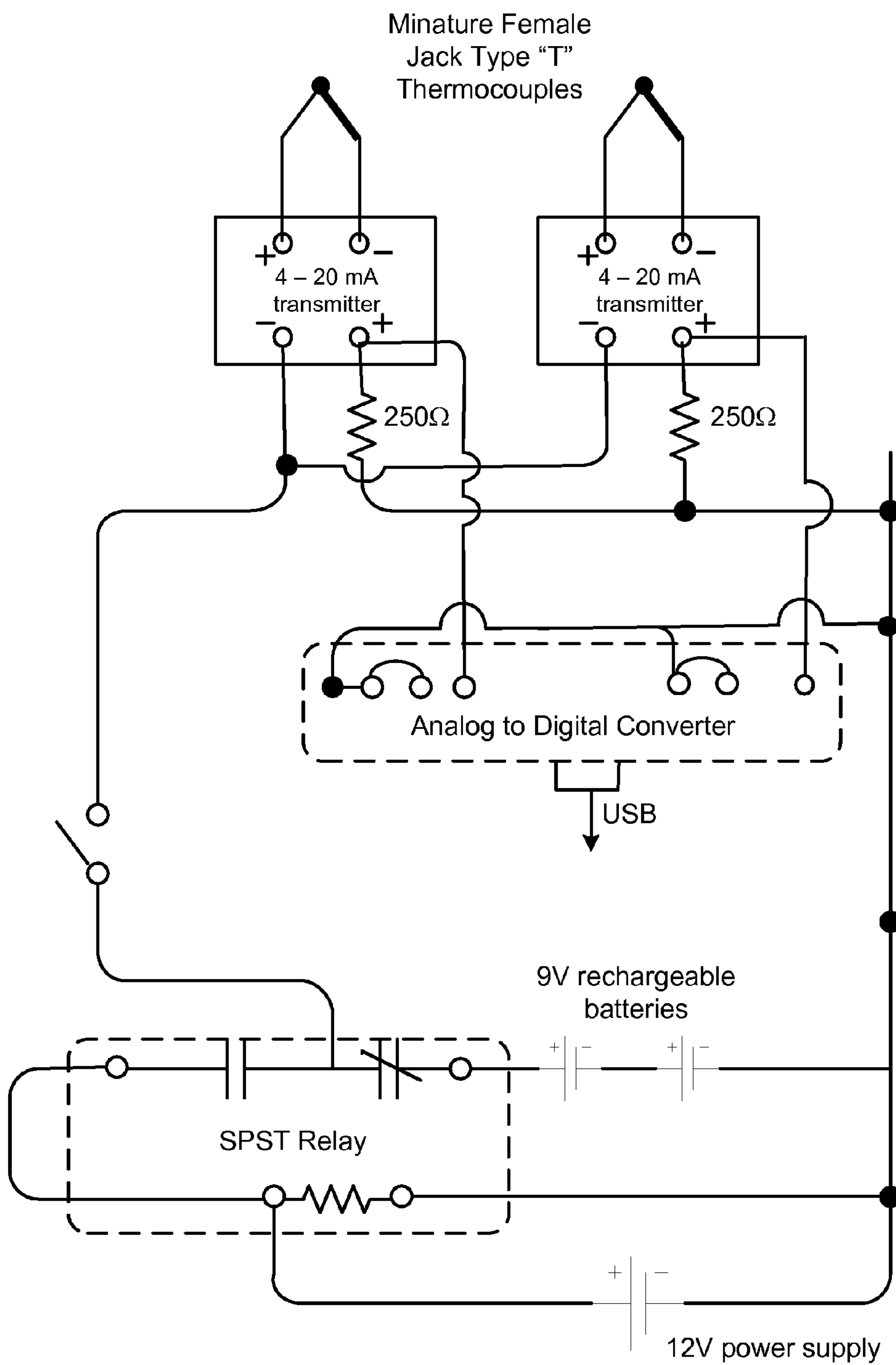

Figure 51a

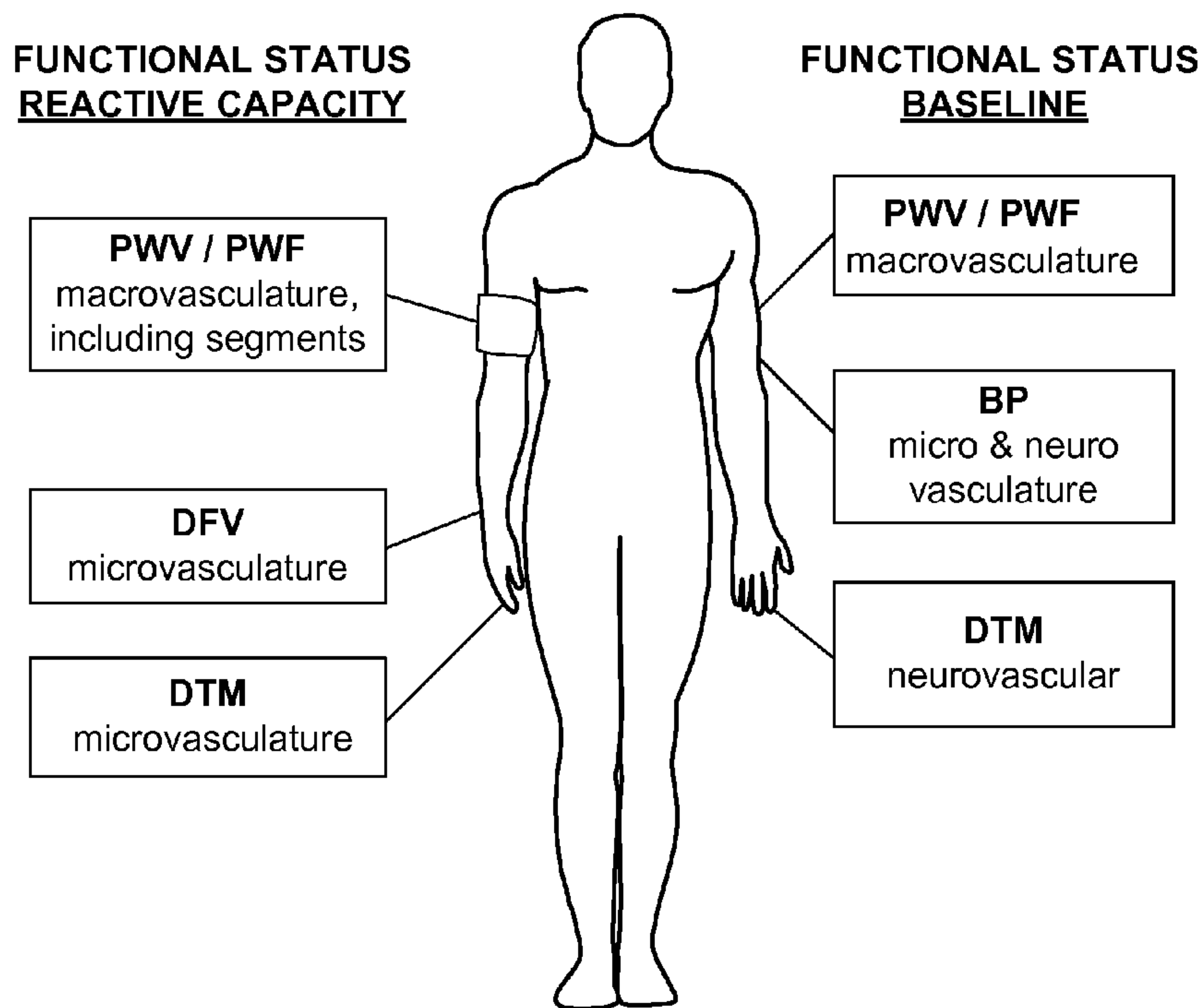

Figure 51b

**Comprehensive Assessment of Vascular Health**

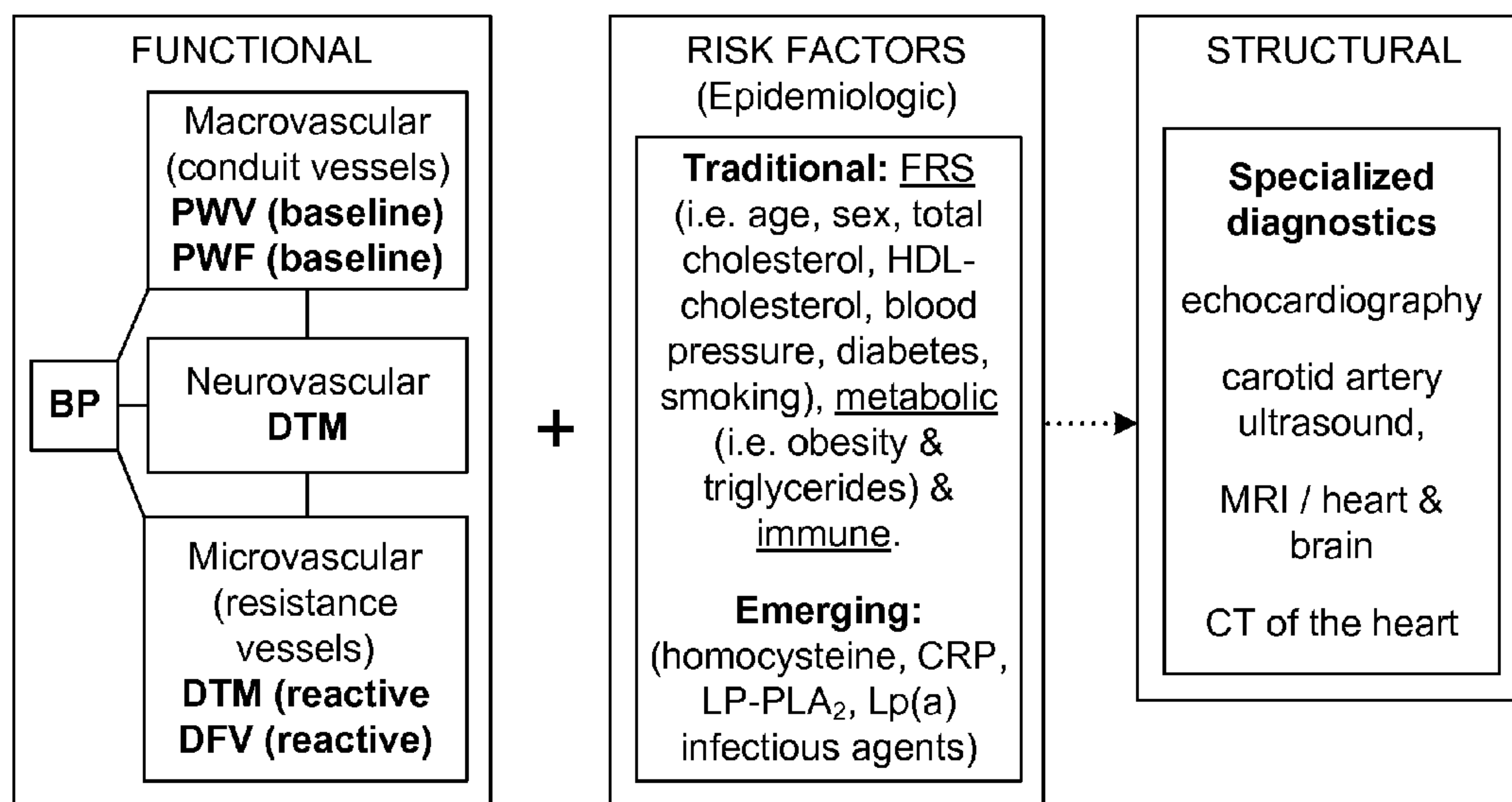



Figure 52

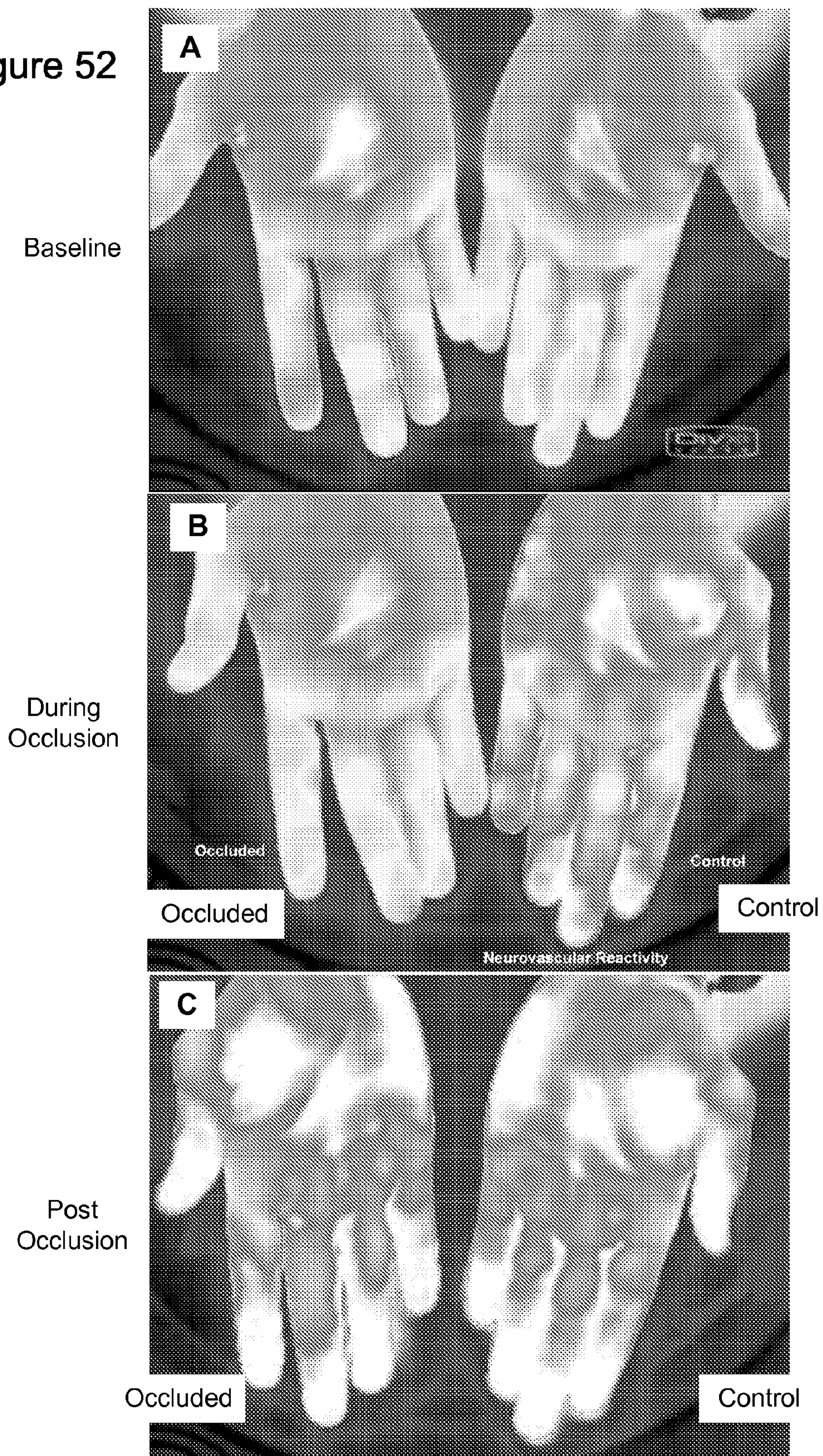



Figure 53a

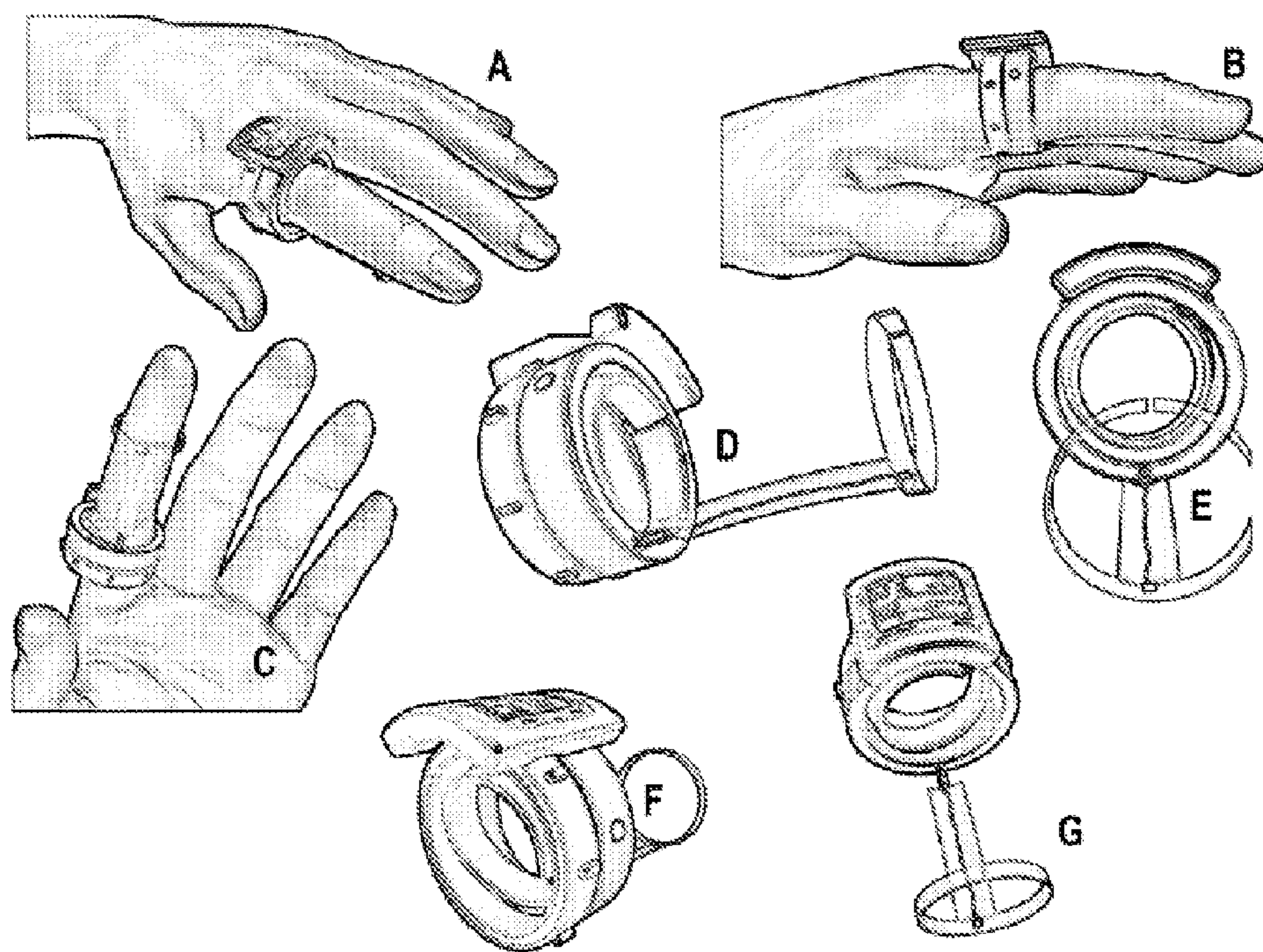

Figure 53b

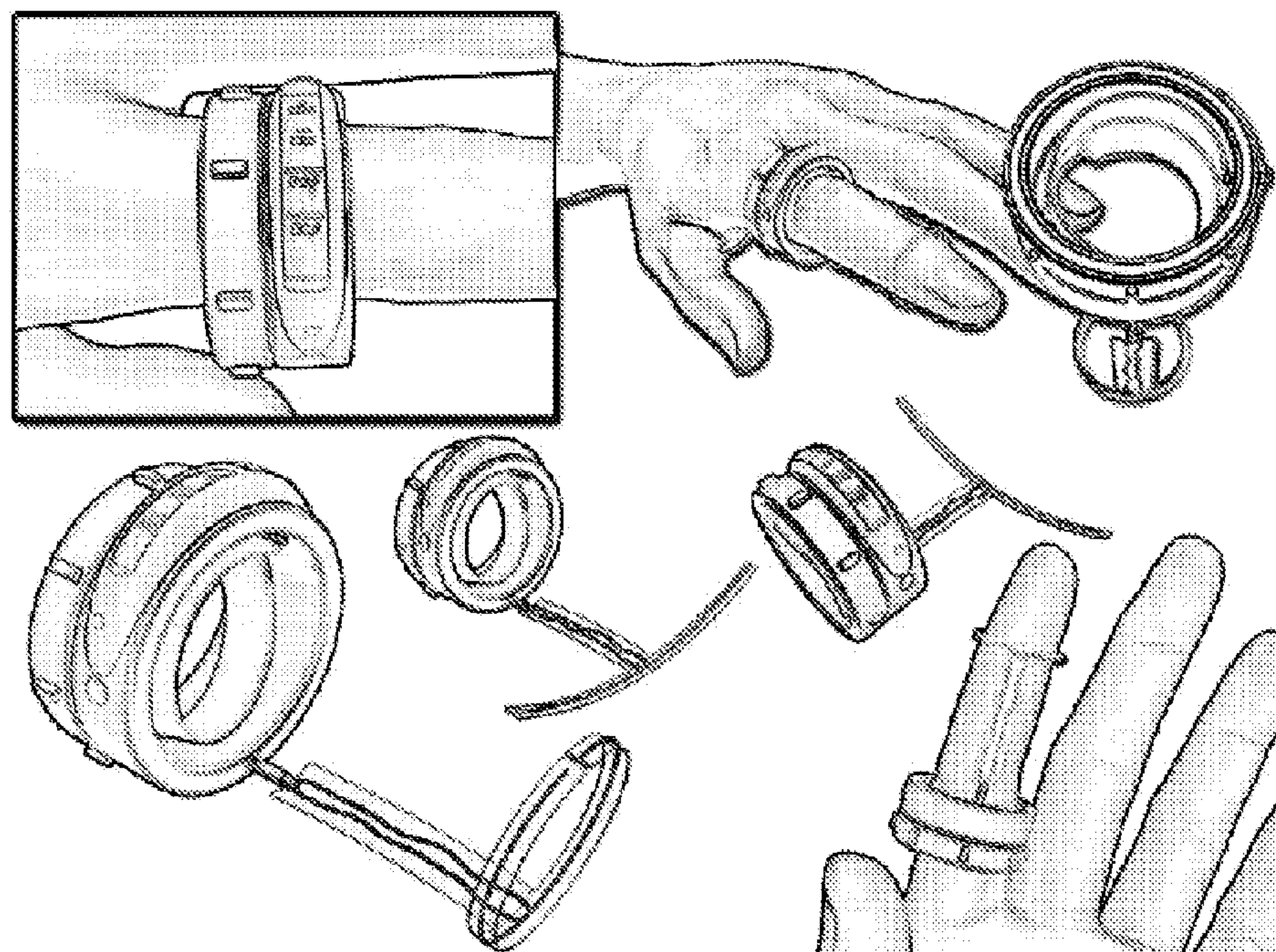
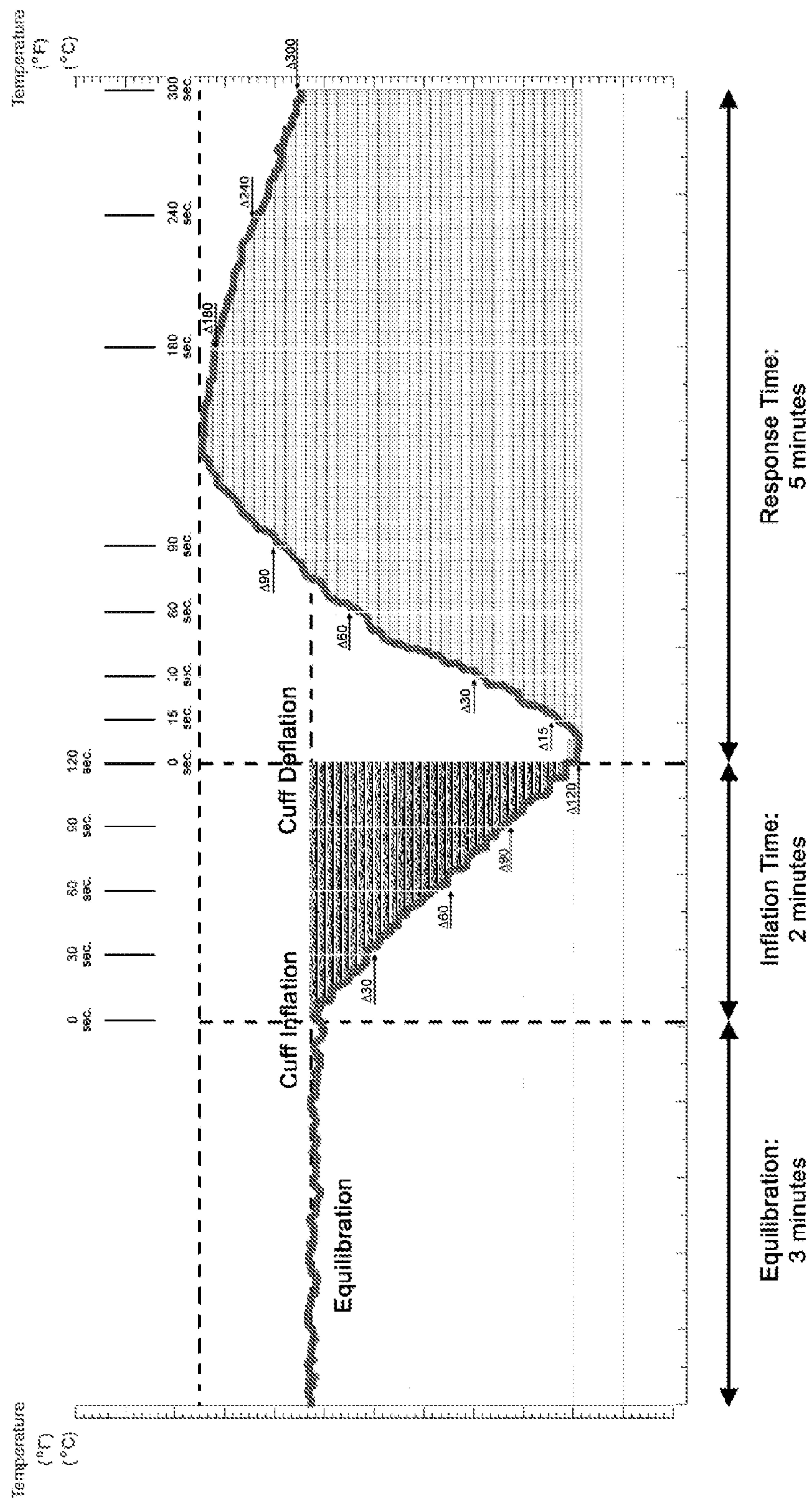



Figure 54





## METHOD AND APPARATUS FOR DETERMINING VASCULAR HEALTH CONDITIONS

### CROSS REFERENCE TO RELATED APPLICATIONS

[0001] This application is a continuation-in-part of, and claims priority under 35 USC §120 to PCT application PCT/US2005/018437, filed May 25, 2005, and published as WO2005/118516, which claims priority under 35 USC §119 to U.S. Provisional Application No. 60/574,255, filed May 26, 2004; U.S. Provisional Application No. 60/585,773, filed July 6, 2004; U.S. Provisional Application No. 60/626,006, filed Nov. 8, 2004, and U.S. Provisional Application No. 60/628,173, filed Nov. 15, 2004, the disclosures of which are incorporated herein by reference in their entirety.

### FIELD OF THE INVENTION

[0002] The present invention relates generally to the field of assessing a patient's vascular health including endothelial function by monitoring changes in hemodynamic parameters responsive to the introduction of a vasostimulant.

### BACKGROUND

[0003] The unpredictable nature of heart attack and the need for cost-effective screening in large group of asymptomatic at-risk populations is the major problem in cardiovascular healthcare. Cardiovascular disease (CVD) remains as the number one killer in the United States and most developed countries. The epidemic of CVD is growing fast in under developed societies where advanced and expensive therapies are unavailable. In the past 50 years over 200 risk factors of atherosclerosis have been reported, however, individual prediction of cardiovascular events remains problematic.

[0004] New developments in noninvasive imaging of atherosclerosis, particularly molecular imaging, are very promising, however, screening large populations to identify the subpopulation most in need of sophisticated imaging modalities remains a major challenge. Such a screening test must be low cost, highly sensitive (with accepted specificity), and widely available. Presently, lipid profiling (Total LDL, HDL, homocysteine, and, to a lesser degree, C-Reactive Protein (CRP), have been adapted for coronary risk assessment. New biochemical assays are also emerging. Although these blood tests are essential in final risk stratification and guiding therapy, given the increasing number of these tests and their less-than-desirable predictive value, measurement of a plurality of these tests for large scale screening purposes may be prohibitively expensive. On this basis, the present inventors sought a non-invasive non-imaging biomarker that would reflect the cumulative effects of multiple risk factors.

[0005] Endothelial cells form the lining of the vasculature. In addition to this barrier function, endothelial cells play a central role in multiple regulatory systems including vasomotion, inflammation, thrombosis, tissue growth and angiogenesis. When there is increased demand for blood by certain organs of the body, endothelial cells release nitric oxide (NO), which increases the diameter of arteries and thereby increases blood flow. NO release is important not only for the regulation of vascular tone but also for the modulation of cardiac contractility, vessel injury and the

development of atherosclerosis. Presence of atherosclerosis hampers the normal functioning of these cells, blocking NO-mediated vasodilation and making the arteries stiffer and less able to expand and contract. The loss of ability of an artery to respond to increased and sudden demand is called endothelial dysfunction (EDF). Endothelial dysfunction is the target organ damage of all cardiovascular risk factors and endothelial failure is the end stage that leads to clinical events in cardiovascular disease. Numerous experimental, clinical, and epidemiologic studies have shown that endothelial function is altered in presence of established risk factors such as hypertension, hypercholesterolemia, diabetes mellitus and emerging risk factors such as hyperhomocysteinemia, CRP, and fibrinogen. There have also been studies showing strong correlation with first cardiovascular events and sub clinical markers such as carotid media thickness (IMT), coronary calcium score (CSS), and ankle brachial index (ABI).

[0006] Impaired endothelial function can be detected before the development of angiographically significant plaque formation in the coronary and peripheral vasculature by measuring the response to pharmacological and physiological stressors. Endothelial function tests not only predict risks but also reflect responses to treatment. Pharmacological therapies and lifestyle changes aimed at improving cardiovascular risk also improve vascular reactivity. Flow-mediated brachial artery vasoreactivity has been shown to improve with major treatment modalities such as statin and ACE inhibitor therapy. The effect seems to be reproducible and also is reversible and follows the course of the disease and risk factors. Lastly, impaired endothelial function has been shown in the presence of genetic factors and susceptibility to atherosclerosis long before development of risk factors and clinical disease.

[0007] Atherosclerosis is a systemic metabolic-immune disease that affects the total vascular bed. Coronary atherosclerosis due to certain hemodynamic characteristics seems to pursue a faster trajectory in the development of stenotic plaques. However, stenotic plaques are considered only the tip of the iceberg. Coronary atherosclerosis has been associated with the brachial atherosclerosis and impaired brachial artery reactivity strongly correlates with impaired coronary artery reactivity. Measurement of endothelial function in the brachial artery with noninvasive techniques provides an opportunity to evaluate large patient populations that is possible with coronary imaging.

[0008] To this end, various modalities have been used for the assessment of endothelial function. Invasive modalities include measuring the vasodilator response of coronary arteries to acetylcholine or to a cold pressor test by invasive quantitative coronary angiography. A second invasive technique involves injecting the radioactive material, and then tracing the blood flow with the help of gamma ray radiations. The invasive nature of these tests limits widespread use, particularly in the asymptomatic population.

[0009] Non-invasive methods include: measurement of the percent change in diameter of the left main trunk induced by cold pressor test with two-dimensional (2-D) echocardiography; the Dundee step test measuring the blood pressure response of a person to exercise (N Tzemos, et al. *Q J Med* 95 (2002) 423-429); laser Doppler perfusion imaging and iontophoresis; high resolution B-mode ultrasound to



study vascular dimensions (T J Anderson, et al. *J. Am. Col. Cardiol.* 26(5) (1995) 1235-41); occlusive arm cuff plethysmography (S Bystrom, et al. *Scand J Clin Lab Invest* 58(7) (1998) 569-76); and digital plethysmography or peripheral arterial tonometry (PAT)(A Chenzbraun et al. *Cardiology* 95(3) (2001) 126-30).

[0010] Of these, brachial artery imaging with high-resolution ultrasound (BAUS) during reactive hyperemia is considered the gold standard method of determining peripheral vascular function. Arm cuff inflation provides a supra-systolic pressure stimulus. Ischemia reduces distal resistance and opening the cuff induces stretch in the artery. Imaging of the diameter of the artery along with measuring the peak flow defines endothelial function. However, this method requires very sophisticated equipment and operators that are only available in a few specialized laboratories worldwide. Thus, despite widespread use of BAUS in clinical research, technical challenges, poor reproducibility, and considerable operator dependency have limited the use of this technique to vascular research laboratories.

[0011] Venous occlusion plethysmography evaluates peripheral vasomotor function by measuring volume changes in the forearm by mercury strain gauges during hyperemia. This method is invasive and cumbersome. Tissue doppler imaging or flowmetry of the hand can be employed to continuously show skin perfusion before and after hyperemia using single fiber / point Doppler measurement of flow at finger tip. These techniques are also expensive and limit availability.

[0012] Alternatively, peripheral arterial tonometry (PAT) can be used to measure changes in the volume of finger as the indicator of changes in blood flow which in turn reflects changes in the diameter of brachial artery during hyperemia. This method is non-invasive but is not inexpensive and is not conducive to self-administration.

[0013] What is needed is a non-invasive, inexpensive and reproducible test that provides an individualized measure of cardiovascular risk assessment by measuring vascular reactivity and correlates positively with known and accepted risk factors.

#### SUMMARY OF THE INVENTION

[0014] The disclosures herein relate generally to vascular health and neurovascular conditions and more particularly to a method and apparatus for determining vascular reactivity and thereby determining one or more health conditions by monitoring changes in temperature. According to one aspect of the invention, the pattern of temperature change at a digit, such as a fingertip, is monitored before and after release of an occlusion to the flow of blood to the digit. It has been found that this inexpensive and reproducible technology correlates with the BAUS gold standard for assessing endothelial function. The technology is importantly conducive to self administration and to individual

[0015] According to one aspect of the present disclosure, a thermal energy measurement apparatus is provided comprising a thermal energy sensor and means for coupling the thermal energy sensor to a skin surface on a body part, the coupling means operable to couple the thermal energy sensor to the skin surface on the body part while not substantially changing the skin surface temperature of the body part.

[0016] According to one aspect of the present disclosure, a method for determining one or more health conditions is provided comprising providing a subject, measuring the skin temperature of a body part on the subject, providing a vasostimulant to the subject, measuring the skin temperature changes of the body part during and subsequent to the provision of the vasostimulant, and determining one or more health conditions for the subject based upon at least one of the skin temperature changes measured.

[0017] According to one aspect of the present disclosure, a method for determining one or more health conditions is provided comprising providing a subject, measuring the skin temperature of a first body part on the subject, placing a second body part of the subject in water, measuring the skin temperature changes of the first body part during and subsequent to the placing of the second body part in water, and determining one or more health conditions for the subject based upon at least one of the skin temperature changes measured.

[0018] According to one aspect of the present disclosure, a method for determining one or more health conditions is provided comprising providing a subject, providing a volume of a medium, placing a body part of the subject in the volume of the medium, measuring the temperature of the volume of the medium, providing a vasostimulant to the subject, measuring the temperature changes of the volume of the medium during and subsequent to the provision of the vasostimulant, and determining one or more health conditions for the subject based upon at least one of the temperature changes measured.

[0019] According to one aspect of the present disclosure, a database for diagnosing health conditions is provided comprising control data comprising a plurality of control temperature data points and temperature data comprising a baseline temperature, a temperature drop from the baseline temperature having a first slope, a lowest temperature achieved, a temperature rise from the lowest temperature achieved having a second slope, a peak temperature, and a stabilization temperature. According to one aspect of the present disclosure, a method for determining one or more health conditions is provided comprising providing a subject, measuring the baseline skin temperature of a body part on the subject, providing a vasostimulant to the subject, measuring the lowest skin temperature of the body part during and subsequent to the provision of the vasostimulant, measuring the highest skin temperature of the body part, and determining one or more health conditions for the subject based upon at least one of the skin temperature changes measured.

[0020] According to one aspect of the present disclosure, a computer program for determining one or more health conditions is provided comprising a retrieval engine adapted to retrieve a plurality of temperature data from a database, the temperature data comprising a baseline temperature, a temperature drop from the baseline temperature having a first slope, a lowest temperature achieved, a temperature rise from the lowest temperature achieved having a second slope, a peak temperature, and a stabilization temperature; a processing engine adapted to process data retrieved by the retrieval engine, and a diagnosis engine operable to determine one or more health conditions based upon the retrieved temperature data.



[0021] According to one aspect of the present disclosure a method for determining one or more health conditions is provided comprising providing a subject, measuring the blood flow rate of the subject, providing a vasostimulant to the subject, measuring the blood flow rate changes of the subject during and subsequent to the provision of the vasostimulant, and determining one or more health conditions for the subject based upon at least one of the blood flow rate changes measured.

[0022] According to one aspect of the present disclosure a method for determining one or more health conditions is provided comprising providing a subject, measuring the skin temperature of a finger on the arm of the subject, detecting an equilibrium in the skin temperature of the finger of the subject, automatically providing a vasostimulant to the subject to substantially cease blood flow to the finger, measuring the skin temperature changes of the finger after provision of the vasostimulant, automatically removing the vasostimulant to allow blood flow to the finger, measuring the skin temperature changes of the finger after the removal of the vasostimulant, and determining one or more health conditions for the subject based upon at least one of the skin temperature changes measured.

[0023] According to one aspect of the present disclosure a method for selecting a medication for the treatment of a medical condition in a subject is provided which includes administering a medication to one or more subjects, determining the health condition of the one or more subjects using the method of: measuring the skin temperature of a body part on the one or more subjects, providing a vasostimulant to the one or more subjects, measuring the skin temperature changes of the body part during and subsequent to the provision of the vasostimulant; and determining one or more health conditions for the one or more subjects based upon at least one of the skin temperature changes measured; determining whether the medication is effective in the treatment of the one or more subjects, and selecting the medication for use in treating the medical condition in other subjects if the medication is determined to be effective in the treatment of the one or more subjects.

[0024] According to one aspect of the present disclosure a method for selecting a nutritional program for a subject is provided which includes administering a nutritional program to one or more subjects, determining the health condition of the one or more subjects using the method of: measuring the skin temperature of a body part on the one or more subjects, providing a vasostimulant to the one or more subjects, measuring the skin temperature changes of the body part during and subsequent to the provision of the vasostimulant, and determining one or more health conditions for the one or more subjects based upon at least one of the skin temperature changes measured; determining whether the nutritional program is effective for the one or more subjects, and selecting the nutritional program for other subjects if the nutritional program is determined to be effective for the one or more subjects.

[0025] According to one aspect of the present disclosure a method for selecting a medication, chemical substance, medical procedure, health intervention program, and/or nutritional program for the treatment of a medical condition in a subject is provided which includes administering a medication, chemical substance, medical procedure, health

intervention program, and/or nutritional program to one or more subjects, determining the health condition of the one or more subjects using the method of: measuring the skin temperature of a body part on the one or more subjects, providing a vasostimulant to the one or more subjects, measuring the skin temperature changes of the body part during and subsequent to the provision of the vasostimulant, and determining one or more health conditions for the one or more subjects based upon at least one of the skin temperature changes measured; determining whether the medication, chemical substance, medical procedure, health intervention program, and/or nutritional program is effective in the treatment of the one or more subjects, and selecting the medication, chemical substance, medical procedure, health intervention program, and/or nutritional program for use in treating the medical condition in other subjects if the medication is determined to be effective in the treatment of the one or more subjects.

[0026] It is emphasized that this summary is not to be interpreted as limiting the scope of these inventions which are limited only by the claims herein.

#### BRIEF DESCRIPTION OF THE DRAWINGS

[0027] FIG. 1 is a flowchart of an embodiment of a method of endothelial function assessment/measurement.

[0028] FIG. 2 is a schematic view illustrating an exemplary embodiment of an apparatus for determining one or more health conditions.

[0029] FIG. 3 is a schematic view illustrating an exemplary embodiment of a computer system used with the apparatus of FIG. 2.

[0030] FIG. 3a is a schematic view illustrating an exemplary embodiment of a database used with the apparatus of FIG. 2.

[0031] FIG. 4a is a cut away perspective view illustrating an exemplary embodiment of a computer system used with the apparatus of FIG. 2.

[0032] FIG. 4b is a perspective view illustrating an exemplary embodiment of a computer system used with the apparatus of FIG. 2.

[0033] FIG. 5 is a flow chart illustrating an exemplary embodiment of the function of a thermal energy sensor engine used in the computer system of FIG. 3.

[0034] FIG. 6 is a flow chart illustrating an exemplary embodiment of the function of a vasostimulant engine used in the computer system of FIG. 3.

[0035] FIG. 7 is a flow chart illustrating an exemplary embodiment of the function of a plotting engine used in the computer system of FIG. 3.

[0036] FIG. 8 is a flow chart illustrating an exemplary embodiment of a method for determining one or more health conditions.

[0037] FIG. 9a is a perspective view illustrating an exemplary embodiment of an apparatus for determining one or more health conditions.

[0038] FIG. 9b is a cross sectional view illustrating an exemplary embodiment of a thermal energy sensor used with the apparatus of FIG. 9a.



[0039] FIG. 10a is a flow chart illustrating an exemplary embodiment of a method for determining one or more health conditions using the apparatus of FIGS. 9a and 9b.

[0040] FIG. 10b is a flow chart illustrating an exemplary embodiment of a method for determining one or more health conditions using the apparatus of FIGS. 9a and 9b.

[0041] FIG. 10c is a perspective view illustrating an exemplary embodiment of the subject of FIG. 1 coupled to the apparatus of FIGS. 9a and 9b.

[0042] FIG. 10d is a perspective view illustrating an exemplary embodiment of the subject of FIG. 1 coupled to the apparatus of FIGS. 9a and 9b.

[0043] FIG. 11a is a flow chart illustrating an exemplary embodiment of a method for determining one or more health conditions using the apparatus of FIGS. 9a and 9b.

[0044] FIG. 11b is a flow chart illustrating an exemplary embodiment of a method for determining one or more health conditions using the apparatus of FIGS. 9a and 9b.

[0045] FIG. 11c is a perspective view illustrating an exemplary embodiment of the subject of FIG. 1 coupled to the apparatus of FIGS. 9a and 9b.

[0046] FIG. 12a is a flow chart illustrating an exemplary embodiment of a method for determining one or more health conditions using the apparatus of FIGS. 9a and 9b.

[0047] FIG. 12b is a flow chart illustrating an exemplary embodiment of a method for determining one or more health conditions using the apparatus of FIGS. 9a and 9b.

[0048] FIG. 12c is a perspective view illustrating an exemplary embodiment of the subject of FIG. 1 coupled to the apparatus of FIGS. 9a and 9b.

[0049] FIG. 13 is a flow chart illustrating an exemplary embodiment of a method for determining one or more health conditions using the apparatus of FIG. 2.

[0050] FIG. 14 is a flow chart illustrating an exemplary embodiment of a method for determining one or more health conditions using the apparatus of FIG. 2.

[0051] FIG. 15 is a perspective view illustrating an exemplary embodiment of an apparatus for determining one or more health conditions.

[0052] FIG. 16 is a side view illustrating an exemplary embodiment of a thermal energy sensor.

[0053] FIG. 17 is a front view illustrating an exemplary embodiment of an apparatus for determining one or more health conditions.

[0054] FIG. 18a is a flow chart illustrating an exemplary embodiment of a method for determining one or more health conditions using the apparatus of FIG. 17.

[0055] FIG. 18b is a flow chart illustrating an exemplary embodiment of a method for determining one or more health conditions using the apparatus of FIG. 17.

[0056] FIG. 19 is a flow chart illustrating an exemplary embodiment of a method for determining one or more health conditions.

[0057] FIG. 20 is a flow chart illustrating an exemplary embodiment of a method for determining one or more health conditions.

[0058] FIG. 21 is a graph illustrating an exemplary embodiment of temperature vs. time data obtained using the apparatus of FIGS. 2, 3, and 4 using the methods of FIGS. 8a and 8b.

[0059] FIG. 22 is a graph illustrating an exemplary experimental embodiment of temperature vs. time data obtained using the apparatus of FIGS. 2, 3, and 4 using the methods of FIGS. 8a and 8b.

[0060] FIG. 23 is a graph illustrating an exemplary experimental embodiment of temperature vs. time data obtained using the apparatus of FIGS. 2, 3, and 4 using the methods of FIGS. 8a and 8b.

[0061] FIG. 24 is a graph illustrating an exemplary experimental embodiment of temperature vs. time data obtained using the apparatus of FIGS. 2, 3, and 4 using the methods of FIGS. 8a and 8b.

[0062] FIG. 25 is a graph illustrating an exemplary experimental embodiment of temperature vs. time data obtained using the apparatus of FIGS. 2, 3, and 4 using the methods of FIGS. 8a and 8b.

[0063] FIG. 26 is a graph illustrating an exemplary experimental embodiment of temperature vs. time data obtained using the apparatus of FIGS. 2, 3, and 4 using the methods of FIGS. 8a and 8b.

[0064] FIG. 27 is a graph illustrating an exemplary experimental embodiment of temperature vs. time data obtained using the apparatus of FIGS. 2, 3, and 4 using the methods of FIGS. 8a and 8b.

[0065] FIG. 28 is a graph illustrating an exemplary experimental embodiment of temperature vs. time data obtained using the apparatus of FIGS. 2, 3, and 4 using the methods of FIGS. 8a and 8b.

[0066] FIG. 29 is a graph illustrating an exemplary experimental of data obtained using the apparatus of FIGS. 2, 3, and 4 using the methods of FIGS. 8a and 8b correlated to percentage change in brachial artery diameter.

[0067] FIG. 30 is a graph illustrating an exemplary experimental embodiment of data obtained using the apparatus of FIGS. 2, 3, and 4 using the methods of FIGS. 8a and 8b correlated to percentage change in brachial artery diameter.

[0068] FIG. 31 is a perspective view illustrating an exemplary embodiment of an apparatus for determining one or more health conditions.

[0069] FIG. 32a is a flow chart illustrating an exemplary embodiment of a portion of a method for determining one or more health conditions using the apparatus of FIG. 31.

[0070] FIG. 32b is a flow chart illustrating an exemplary embodiment of a portion of a method for determining one or more health conditions using the apparatus of FIG. 31.

[0071] FIG. 32c is a perspective view illustrating an exemplary embodiment of the apparatus of FIG. 31 being used on the subject of FIG. 3 during the method of FIGS. 32a and 32b.



[0072] FIG. 32*d* is a graph illustrating an experimental embodiment of the apparatus of FIG. 31 being used on the subject of FIG. 3 during the method of FIGS. 32*a* and 32*b*.

[0073] FIG. 33*a* is a top view illustrating an exemplary embodiment of a thermal energy sensor.

[0074] FIG. 33*b* is a cross sectional view illustrating an exemplary embodiment of the thermal energy sensor of FIG. 33*a*.

[0075] FIG. 33*c* is a cross sectional view illustrating an exemplary embodiment of operation of the thermal energy sensor of FIG. 33*b*.

[0076] FIG. 34*a* is a top view illustrating an exemplary embodiment of a thermal energy sensor.

[0077] FIG. 34*b* is a cross sectional view illustrating an exemplary embodiment of the thermal energy sensor of FIG. 34*a*.

[0078] FIG. 34*c* is a cross sectional view illustrating an exemplary embodiment of operation of the thermal energy sensor of FIG. 34*b*.

[0079] FIG. 35 is a perspective view illustrating an exemplary embodiment of an apparatus for determining one or more health conditions.

[0080] FIG. 36*a* is a top view illustrating an exemplary embodiment of a thermal energy sensor.

[0081] FIG. 36*b* is a cross sectional view illustrating an exemplary embodiment of the thermal energy sensor of FIG. 36*a*.

[0082] FIG. 36*c* is a cross sectional view illustrating an exemplary embodiment of the operation of the thermal energy sensor of FIG. 36*b*.

[0083] FIG. 37*a* is a flow chart illustrating an exemplary embodiment of a portion of a method for determining one or more health conditions using the apparatus of FIG. 36*a*.

[0084] FIG. 37*b* is a flow chart illustrating an exemplary embodiment of a portion of a method for determining one or more health conditions using the apparatus of FIG. 36*a*.

[0085] FIG. 38*a* is a flow chart illustrating an exemplary embodiment of a portion of a method for determining one or more health conditions.

[0086] FIG. 38*b* is a flow chart illustrating an exemplary embodiment of a portion of a method for determining one or more health conditions.

[0087] FIG. 38*c* is a perspective view illustrating an exemplary embodiment of the subject of FIG. 3 during the method of FIGS. 38*a* and 38*b*.

[0088] FIG. 38*d* is a graph illustrating an experimental embodiment of the subject not undergoing the method of FIGS. 38*a* and 38*b*.

[0089] FIG. 38*e* is a graph illustrating an experimental embodiment of the subject undergoing the method of FIGS. 38*a* and 38*b*.

[0090] FIG. 39 is a flow chart illustrating an embodiment of a method for determining the effectiveness of a medication.

[0091] FIG. 40 is a flow chart illustrating an embodiment of a method for determining the effectiveness of a nutritional program.

[0092] FIG. 41 is a perspective view illustrating an embodiment of apparatus for determining health condition.

[0093] FIG. 42*a* is a flow chart illustrating an embodiment of a portion of a method for determining health condition using the apparatus of FIG. 41.

[0094] FIG. 42*b* is a flow chart illustrating an embodiment of a portion of a method for determining health condition using the apparatus of FIG. 41.

[0095] FIG. 42*c* is a perspective view illustrating an embodiment of the apparatus of FIG. 41 on the subject of FIG. 1 during the method of FIGS. 42*a* and 42*b*.

[0096] FIG. 43*a* is a graph illustrating an experimental embodiment of the subject undergoing the method of FIGS. 42*a* and 42*b*.

[0097] FIG. 43*b* is a graph illustrating an experimental embodiment of the subject undergoing the method of FIGS. 42*a* and 42*b*.

[0098] FIG. 43*c* is a graph illustrating an experimental embodiment of the subject undergoing the method of FIGS. 42*a* and 42*b*.

[0099] FIG. 44*a* depicts DTM data (TF, TR and NP) from a second cohort of 26 individuals. FIG. 44*b* depicts BAUS data from the same cohort as FIG. 44*a*.

[0100] FIG. 45*a* depicts ROC curve analysis of FRS, NP, TR and slope for the data of FIG. 44*a*.

[0101] FIG. 46*a* depicts the FRS scores comparing CHD with non-CHD patients in the cohort of individuals of FIG. 44*a*, while FIG. 46*b* depicts DTM TR values comparing CHD with non-CHD patients in the same cohort as FIG. 46*a*.

[0102] FIG. 47*a* depicts the graded relationship observed between TR values and FRS.

[0103] FIG. 47*b* depicts the differences in average TR values between diabetics and non diabetics.

[0104] FIG. 48 shows that DTM outperforms FRS in females and individuals <55 years of age.

[0105] FIG. 49*a* presents data correlating DTM results with CAD.

[0106] FIG. 49*b* figuratively depicts the appearance of possible temperature response curved depending on baseline fingertip temperature.

[0107] FIG. 50 depicts an embodiment of wiring for receiving signals from thermocouple leads and sending them through an analog to digital converter.

[0108] FIG. 51*a* depicts methods for functional assessment of baseline and reactive capacity in accordance with an embodiment of the invention.

[0109] FIG. 51*b* depicts a paradigm for comprehensive assessment of vascular health including functional and structural individual assessments as well as assessment based on epidemiologic risk factors.

[0110] FIG. 52 represents infrared video imaging of the two hands of the same individual before (A), during (B) and



after (C) occlusion by inflation of a blood pressure cuff on the right arm (labeled occluded).

[0111] FIGS. 53a and 53b depict several views of embodiments of a finger cuff and temperature sensor for ambulatory vascular reactivity assessment.

[0112] FIG. 54 depicts temperature response parameters.

#### DETAILED DESCRIPTION

[0113] Referring now to FIG. 1, a method for assessing endothelial function is provided that comprises providing a vasodilating stimulant to a patient to stimulate hemodynamic activity in a selected region of the patient's body, illustrated at block 10 in FIG. 1, monitoring a change in a hemodynamic parameter at the selected region, illustrated at block 11 in FIG. 1, and assessing the patient's endothelial function based upon said monitoring, illustrated at block 12 in FIG. 1. In a one embodiment, the monitored hemodynamic parameter may be a parameter such as blood temperature, blood oxygen content, blood flow rate, or the like, or a combination thereof.

[0114] Providing a vasodilating stimulant may further comprise compressing the patient's brachial artery for a predetermined period of time and ceasing the compression after that predetermined period of time. Providing a vasodilating stimulant may also comprise occluding blood flow in the patient's arm.

[0115] Additionally, the change in temperature at one of the patient's fingertips may be monitored as may the change in temperature in the patient's arm. Monitoring the change in temperature may be accomplished by placing at least two temperature sensors, for example piezoelectric sensors, proximate, e.g. on, the patient's forearm. The temperature sensors may be separated by a known distance.

[0116] Providing a vasodilating stimulant may comprise occluding blood flow in the patient's leg.

[0117] In one embodiment, a preferred method for measuring endothelial function comprises providing a vasodilating stimulant to a patient to stimulate hemodynamic activity in a selected region of the patient's body, monitoring a change in blood oxygen content at the selected region, and assessing the patient's endothelial function based upon said monitoring.

[0118] Monitoring may be accomplished by taking measurements with a pulse oximeter. The pulse oximeter may be placed proximate, e.g. on the tip of one of the patient's fingers.

[0119] In one embodiment, a second preferred method for measuring endothelial function comprises providing a vasodilating stimulant to a patient to stimulate hemodynamic activity in a selected region of the patient's body, monitoring a change in blood flow rate at the selected region, and assessing the patient's endothelial function based upon said monitoring.

[0120] Monitoring may be accomplished by taking measurements with a photoplethysmograph placed proximate, e.g. on one of the patient's fingers. Monitoring may also be accomplished by taking an ultrasound Doppler measurement. Monitoring may occur from a time prior to the

beginning of the compression until a time after ceasing, e.g. when blood flow has stabilized.

[0121] Providing a vasodilating stimulant may comprise compressing one of the patient's arteries located in an outer extremity of the patient's body for a predetermined period of time and ceasing the compression after said predetermined period of time. The outer extremity may be a leg, an arm, a wrist, and/or a finger.

[0122] The second preferred method for measuring endothelial function may further comprise plotting measured blood flow as a function of time and/or plotting the change in blood flow as a function of time.

[0123] In one embodiment, a method is provided for assessing endothelial function, comprising a providing a vasodilating stimulant to a patient to stimulate hemodynamic activity in a selected region of the patient's body; monitoring a change in a hemodynamic parameter at the selected region; and assessing the patient's endothelial function based upon said monitoring. In one such embodiment, the hemodynamic parameter is at least one of (i) blood temperature, (ii) blood oxygen content, or (iii) blood flow rate. The vasodilating stimulant may comprise compressing the patient's brachial artery or occluding blood flow in the patient's arm for a predetermined period of time, and ceasing said compression after the predetermined period of time. The monitoring may further comprise monitoring a change in temperature at one of the patient's fingertips. The vasodilating stimulant may comprise occluding blood flow in the patient's leg.

[0124] In one embodiment, the monitoring comprises monitoring a change in temperature in the patient's arm. In one embodiment, the monitoring the change in temperature in the patient's arm is accomplished by placing at least two temperature sensors proximate the patient's forearm. In one embodiment, the temperature sensors are piezoelectric sensors.

[0125] In another embodiment, the vasodilating stimulant comprises occluding blood flow in the patients' leg.

[0126] In one embodiment, a method for measuring endothelial function is provided, comprising: a) providing a vasodilating stimulant to a patient to stimulate hemodynamic activity in a selected region of the patient's body; b) monitoring a change in blood oxygen content at the selected region; and c) assessing the patient's endothelial function based upon said monitoring. In one such embodiment, the monitoring is accomplished by taking measurements with a pulse oximeter. In one such embodiment, the pulse oximeter is placed proximate the tip of one of the patient's fingers.

[0127] In one embodiment, a method is provided for measuring endothelial function, comprising: a) providing a vasodilating stimulant to a patient to stimulate hemodynamic activity in a selected region of the patient's body; b) monitoring a change in blood flow rate at the selected region; and c) assessing the patient's endothelial function based upon said monitoring. In one such embodiment, the monitoring is accomplished by taking measurements with a photoplethysmograph placed proximate the tip of one of the patient's fingers. Alternatively, monitoring is accomplished by taking an ultrasound Doppler measurement. The vasodilating stimulant may comprise compressing one of the patient's arteries located in an outer extremity of the



patient's body for a predetermined period of time; and ceasing compression after said predetermined period of time. In one embodiment, the extremity is at least one of (i) a leg, (ii) an arm, (iii) a wrist, or (iv) a finger. In one embodiment, the monitoring occurs from a time prior to the beginning of said compression until a time after said ceasing when said blood flow has stabilized. In one embodiment the measured blood flow is plotted as a function of time. In another embodiment, the change in blood flow is plotted as a function of time.

[0128] Referring now to FIG. 2, in an exemplary embodiment, an apparatus for determining one or more health conditions 100 includes a computer system 102 which is operably coupled to a thermal energy sensor 104 and a vasostimulant 106. In an exemplary embodiment, the computer system 102 may be, for example, a conventional computer system known in the art. In an exemplary embodiment, the thermal energy sensor 104 may be, for example, a conventional thermal energy sensor known in the art. In an exemplary embodiment, the thermal energy sensor 104 may be, for example, a thermocouple, a thermister, a resistance temperature detector, a heat flux sensor, a liquid crystal sensor, an infrared sensor, a thermopile, or a variety of other thermal energy sensors known in the art. In an exemplary embodiment, the thermal energy sensor is an infrared sensor that measures the thermal energy of a point on a surface. In an exemplary embodiment, thermal energy sensor is an infrared sensor that measures the thermal energy of an area on a surface. In an exemplary embodiment, the thermal energy sensor 104 may be disposable. In an exemplary embodiment, the vasostimulant 106 may be, for example, conventional vasostimulants known in the art including mechanical vasostimulants such as cuffs for compressing arteries, chemical vasostimulants such as nitroglycerin or transdermal substances, sympathetic mimetic agents, parasympathetic mimetic agents, acetylcholine, vasodilating nitrates such as, for example, nitroprusside or glyceryl trinitrate, inhibitors of endothelium-derived contracting factors such as, for example, ACE inhibitors or angiotensin II receptor antagonists, cytoprotective agents such as, for example, free radical scavengers such as superoxide dismutase endothelium dependent agents such as, for example, acetylcholine, and/or endothelium independent agents such as, for example, nitroprusside or glycerin trinitrate, psychological vasostimulants such as aptitude tests, mental arithmetic, visual stimulation, physiological vasostimulants such as the Valsalva maneuver, a tilting test, physical exercise, whole body warming, whole body cooling, local warming, local cooling, contralateral handgrip, contralateral hand cooling, and painful stimuli such as, for example, nailbed compression, and a variety of others. In an exemplary embodiment, the chemical vasostimulants may stimulate the vessel either through the endothelium or bypass the endothelium and directly affect the muscular part of the vessel wall, which is endothelium independent. In an exemplary embodiment, the vasostimulant 106 may be, for example, a neuro-vasostimulant, a neurostimulant, a vasoconstrictor, a vasodialator, an endothermal layer stimulant, or a smooth muscle cell or medial layer stimulant. In an exemplary embodiment, a neuro-vasostimulant may include, for example, having the subject drink a glass of ice water. In an exemplary embodiment, the thermal energy sensor 104 and the vasostimulant 106 are coupled to, monitored by, and/or controlled by the computer system 102 through a wireless

connection such as, for example, a wireless connection including Bluetooth technology. In an exemplary embodiment, the computer system 102 may be coupled to a variety of convention medical devices known in the art such as, for example, a conventional pulse oximeter or a conventional blood pressure monitoring device.

[0129] Referring now to FIG. 3, in an exemplary embodiment, the computer system 102 includes a database 102a. A thermal energy sensor engine 102b is operably coupled to the database 102a. A vasostimulant engine 102c is operably coupled to the database 102a and the thermal energy sensor engine 102b. A plotting engine 102d is operably coupled to the database 102a. In an exemplary embodiment, the thermal energy sensor engine 102b, vasostimulant engine 102c, and the plotting engine 102d may be, for example, a variety of conventional software engines known in the art. In several exemplary embodiment, the thermal energy sensor engine 102b is adapted to control a thermal energy sensor such as, for example, the thermal energy sensor 104 illustrated in FIG. 3, which is operably coupled to the computer system 102. In several exemplary embodiments, the vasostimulant engine 102c is adapted to control a vasostimulant such as, for example, the vasostimulant 106 illustrated in FIG. 1, which is operably coupled to the computer system 102. In several exemplary embodiments, the plotting engine 102d is adapted to retrieve data in database 102a and manipulate the data in a variety of ways including, but not limited to, sorting the data, plotting the data, and displaying the data. In an exemplary embodiment, the computer system 102 is coupled to a therapeutic device which may be operable to perform a therapeutic function such as, for example, releasing oxygen. In an exemplary embodiment, the computer system 102 is coupled to an alerting device which may be, for example, operable to contact emergency medical services.

[0130] Referring now to FIG. 3, in an exemplary embodiment, the database 102a includes a plurality of data such as, for example, a temperature at time A 102aa, a temperature at time B 102ab, a temperature at time C 102ac, up to a temperature at time n 102ad. In an exemplary embodiment, the temperature data may include temperatures taken from one thermal energy sensor such as, for example, the thermal energy sensor 104 illustrated in FIG. 3, or from a plurality of thermal energy sensors.

[0131] Referring now to FIG. 4a, in an exemplary embodiment, the computer system 102 includes a chassis 102e. A computer board 102f is mounted to the chassis 102e and includes a thermal energy sensor card 102g and a vasostimulant card 102h coupled to and extending from the computer board 102f. A pump 102i is coupled to the vasostimulant card 102h by a wire 102j. In an exemplary embodiment, the chassis 102e may include wireless interface 102k for allowing wireless communication to the computer board 102f. In an exemplary embodiment, the chassis may include a plurality of communications ports 102l mounted to a surface for allowing communication with the computer board 102f. In an exemplary embodiment, the thermal energy sensor card 102g is coupled to the thermal energy sensor 104, illustrated in FIG. 2. In an exemplary embodiment, the vasostimulant card 102h is coupled to the vasostimulant 106, illustrated in FIG. 2, through the pump 102i.

[0132] Referring now to FIG. 4b, in an exemplary embodiment, the computer system 102 is positioned on a chassis



**102m.** A plurality of storage units **102na** and **102nb** extend from opposite sides of the chassis **102m** with the storage unit **102na** providing storage for the vasostimulant **106**, described above with reference to FIG. 2, and the storage unit **102nb** providing storage for the thermal energy sensor **104**, described above with reference to FIG. 2. A display **102o** is mounted to and positioned on top of the chassis **102m** and coupled to the computer system **102** in order to display data collected by the computer system **102**. An input device **102p** is mounted to the chassis **102m** to provide input to the computer system **102** and manipulate information displayed on the display **102o**. In an exemplary embodiment, the chassis **102m** includes a plurality of wheels **102q** which are operable to allow moving of the chassis **102m**. In an exemplary embodiment, the computer system **102** is operable to produce an output **102r** which includes data collected by the computer system **102**.

[0133] Referring now to FIG. 5, in an exemplary embodiment, a method for controlling a thermal energy sensor **200** is illustrated in which a thermal energy sensor engine such as, for example, the thermal energy sensor engine **102b** illustrated in FIG. 3, is started in step **202**. Starting the thermal energy sensor engine **102b** at step **202** allows the thermal energy sensor engine **102b** to enter a standby mode at step **204**. At decision block **206**, the thermal energy sensor engine **102b** determines whether it is time to start recording temperature with a thermal energy sensor such as, for example, the thermal energy sensor **104** illustrated in FIG. 2. If it is not time to start recording temperature, the method **200** returns to step **204** where the thermal energy sensor engine **102b** remains on standby.

[0134] If it is time to start recording temperature, the thermal energy sensor engine **102b** begins recording temperature at step **206** with the thermal energy sensor **104**. The method **200** then proceeds to step **208** where the thermal energy sensor engine **102b** begins to detect for temperature equilibrium in step **210**. In an exemplary embodiment, at step **210**, the thermal energy sensor engine begins comparing successive temperature measurements made by the thermal energy sensor **104**. At decision block **212**, the thermal energy sensor engine **102b** determines whether temperature equilibrium has been achieved. In an exemplary embodiment, temperature equilibrium is achieved when temperature changes recorded by the thermal energy sensor **104** are less than 0.1 degrees C. If the equilibrium has not been achieved, the method **200** returns to step **210** where the thermal energy sensor engine **102b** detects for temperature equilibrium.

[0135] If equilibrium has been achieved, the method **200** proceeds to step **214** where the thermal energy sensor engine **102b** continues recording temperature measurements made by the thermal energy sensor **104**. At decision block **216**, the thermal energy sensor engine **102b** determines whether to stop recording. In an exemplary embodiment, the thermal energy sensor engine **102b** will stop recording when temperature measurements from the thermal energy sensor **104** have stabilized. If it is not time to stop recording, the method **200** returns to step **214** where the thermal energy sensor engine **102b** continues recording temperature measurements made by the thermal energy sensor **104**.

[0136] If it is time to stop recording, the method **200** proceeds to step **218** where the thermal energy sensor engine

**102b** stops recording temperature measurements made by the thermal energy sensor **104**. The method then proceeds to step **220** where the temperature measurements recorded by the thermal energy sensor engine **102b** are saved to a database such as, for example, the database **102** illustrated in FIG. 3. The method **200** then proceeds to step **222** where the thermal energy sensor engine **200** is stopped.

[0137] Referring now to FIG. 6, in an exemplary embodiment, a method for controlling a vasostimulant engine **300** is illustrated in which a vasostimulant engine such as, for example, the vasostimulant engine **102c** illustrated in FIG. 3, is started in step **302**. Starting the vasostimulant engine **102c** at step **302** allows the vasostimulant engine **102c** to enter a standby mode at step **304**. At decision block **306**, the vasostimulant engine **102c** determines whether to activate a vasostimulant such as, for example, the vasostimulant **106** illustrated in FIG. 3. If it is not time to activate the vasostimulant **106**, the method **300** returns to step **304** where the vasostimulant engine **300** remains on standby.

[0138] If it is time to activate the vasostimulant **106**, the method **300** proceeds to step **308** where the vasostimulant engine **102c** activates the vasostimulant **106**. At decision block **310**, the vasostimulant engine **102c** determines whether it is time to deactivate the vasostimulant **106**. If it is not time to deactivate the vasostimulant **106**, the method **300** returns to step **308** where the vasostimulant engine **102c** keeps the vasostimulant **106** activated.

[0139] If it is time to deactivate the vasostimulant **106**, the method **300** proceeds to step **312** where the vasostimulant engine **102c** deactivates the vasostimulant **106**. The method **300** then proceeds to step **314** where the vasostimulant engine **102c** is stopped.

[0140] Referring now to FIG. 7, in an exemplary embodiment, a method for controlling a plotting engine **400** is illustrated in which a plotting engine such as, for example, the plotting engine **102d** illustrated in FIG. 3, is started in step **402**. Starting the plotting engine **102d** at step **402** allows the plotting engine **102d** to enter a standby mode at step **404**. At decision block **406**, the plotting engine **102d** determines whether it is time to plot data. If it is not time to plot data, the method **400** returns to step **404** where the plotting engine **102d** remains on standby.

[0141] If it is time to plot data, the method **400** proceeds to step **408** where the plotting engine **102d** retrieves data from a database such as, for example, the database **102a** illustrated in FIG. 3. At decision block **410**, the plotting engine **102d** determines whether all of the data needed has been retrieved from database **102a**. If all the data has not been retrieved, the method **400** returns to step **408** where the plotting engine **102d** continues to retrieve data from database **102a**.

[0142] If all the data needed has been retrieved from database **102a**, the method proceeds to step **412** where the plotting engine **102d** plots the data. The method **400** then proceeds to step **414** where the plotting engine **102d** is stopped.

[0143] Referring now to FIG. 8a and 8b, in an exemplary embodiment, a method for determining one or more health conditions **500** is illustrated which begins with a subject preparation at step **502**. Subject preparation at step **502** may include, for example, having a subject such as, for example,



the subject **10** illustrated in FIG. 3, refrain from eating before carrying out the method **500**, having the subject **10** refrain from smoking before carrying out the method **500**, having the subject **10** refrain from ingesting alcohol or caffeine before carrying out the method **500**, or having the subject **10** refrain from taking any vascular medications before carrying out the method **500**, having the subject **10** refrain from exposure to cold weather before carrying out the method **500**, ensuring the subject **10** is not experiencing urinary urgency or full bladder before carrying out the method **500**, having the subject **10** refrain from physical or mental exercise before carrying out the method **500**, and a variety of other factors that may temporarily affect vascular function known in the art. In an exemplary embodiment, the subject preparation at step **502** may begin at least **12** hours prior to the method **500** proceeding to step **504**.

[0144] At step **504**, a thermal energy sensor such as, for example, the thermal energy sensor **104** illustrated in FIG. 3, may be placed on the subject **10**. In an exemplary embodiment, the thermal energy sensor **104** may be a conventional thermal energy sensor known in the art. In an exemplary embodiment, the thermal energy sensor **104** is designed such that there is a minimal area of contact between the sensor and the subject **10**. In an exemplary embodiment, when placed on the subject **10**, the thermal energy sensor **104** provides a minimal pressure to the subject **10**. In an exemplary embodiment, in operation, the thermal energy sensor **104** measures thermal energy only and does not introduce any signals into the subject **10**. In an exemplary embodiment, thermal energy measured by the thermal energy sensor **104** is not effected by insulation or perspiration. In an exemplary embodiment, the thermal energy sensor **104** does not alter the microcapillary flow in the subject **10**. In an exemplary embodiment, the thermal energy sensor **104** does not restrict movement of the subject **10** and thermal energy measurements are not effected by subject **10** movement. In an exemplary embodiment, a plurality of thermal energy sensor **104** may be positioned at different locations on the subject **10**. In an exemplary embodiment, the thermal energy sensor **104** is positioned on a body part of the subject **10** such as, for example, the finger **16**, forearm, toe, leg, an earlobe, a rectum, or a nose. In an exemplary embodiment, the thermal energy sensor **104** may be placed on the subject **10** in order to measure the thermal energy of distal resistant vessels on the subject **10**. In an exemplary embodiment, the thermal energy sensor **104** may allow the visualization of thermal response by infrared thermal energy measuring devices such as, for example, cameras, thermosensors, and/or thermocouples. In an exemplary embodiment, the thermal energy sensor **104** minimizes the temperature changes associated with the contact of the skin surface and thermal energy sensor **104** and allows the thermal energy sensor **104** to be minimally effected by factors and conditions that change skin temperature but are not associated with changes in blood flow, subcutaneous blood flow, tissue heat generation, and/or tissue heat transduction. In an exemplary embodiment, the method **500** may be carried out invasively and the thermal energy sensor **104** may be placed beneath the surface of the skin such as, for example, in the subcutaneous region, the intramuscular region, the intravascular region, within the surrounding tissue, and/or inside the body.

[0145] At step **506**, a thermal energy sensor engine such as, for example, the thermal energy sensor engine **102b** illustrated in FIG. 3, activates a thermal energy sensor such

as, for example, the thermal energy sensor **104** illustrated in FIG. 3, to begin recording the temperature of the subject **10**. In an exemplary embodiment, temperature data begins being recorded continuously. In an exemplary embodiment, the thermal energy sensor **102b** measures the skin temperature of the subject's body on which it is placed such as, for example, the hand, forearm, foot, leg, earlobe, rectum, or nose. In an exemplary embodiment, the thermal energy sensor **102b** engages the skin of the subject **10** in order to measure temperature. In an exemplary embodiment, the thermal energy sensor **102b** measures the skin temperature of the subject **10** without engaging the skin of the subject **10**. In an exemplary embodiment, the ambient temperature is held constant around the thermal energy sensor **104**. In an exemplary embodiment, the fluid flow such as, for example, the airflow, around the thermal energy sensor **104** is kept to a minimum. In an exemplary embodiment, the thermal energy sensor **104** includes an infrared thermal energy measurement device which measures the thermal response of the face or other highly vascular areas.

[0146] At step **508**, the thermal energy sensor engine **102b** begins to detect for equilibrium in the temperature of subject **10**. In an exemplary embodiment, at step **508**, the thermal energy sensor engine **102b** retrieves successive temperature measurements from the thermal energy sensor **104**.

[0147] At decision block **510**, the thermal energy sensor engine **102b** determines whether the temperature of the subject **10** has reached equilibrium. If the temperature of the subject **10** has not reached equilibrium, the temperature sensor engine proceeds back to step **508** to detect for equilibrium. In an exemplary embodiment, determining whether the temperature of the subject **10** has reached equilibrium in step **510** may include, for example, determining whether the temperature changes of a subject **10** are less than 0.1 degree C.

[0148] If the temperature changes in the subject **10** have reached equilibrium, the method proceeds to step **512** where a vasostimulant engine such as, for example, the vasostimulant engine **102c** illustrated in FIG. 3, activates a vasostimulant such as, for example, the vasostimulant **106** illustrated in FIG. 3. In an exemplary embodiment, the vasostimulant **106** may be an inflatable cuff, and activating the vasostimulant **106** at step **512** may include, for example inflating the cuff to 200 mm Hg systolic BP. In an exemplary embodiment, the vasostimulant **106** may be a chemical such as, for example, nitroglycerin, and activating the vasostimulant **106** at step **512** may include administering a predetermined amount of the chemical to the subject **10**. Further methods of providing a chemical vasostimulant **106** include injecting it into a vein or artery of the subject **10**, having the subject **10** orally inject the chemical vasostimulant **106**, having the subject **10** inhale the chemical vasostimulant **106**, having the subject **10** sublingually absorb the chemical vasostimulant **106**, and/or having the subject **10** diffuse the chemical vasostimulant **106** through their skin such as, for example, by having the subject diffuse 1% acetylcholine chloride for endothelium dependent assessment and 1% sodium nitroprusside for endothelium independent response. In an exemplary embodiment, the vasostimulant **106** may be an aptitude test, and activating the vasostimulant **106** at step **512** may include having the subject **10** begin the aptitude test. In an exemplary embodiment, providing the vasostimulant **106** may include rubbing a vasodilator cream such as, for



example, a 1% topical acetylcholine cream on the skin of the subject **10** where significant subcutaneous fat exists such as, for example, the abdominal area. The continued recording of temperature may then include visualizing the thermal response of the subject **10** with an infrared thermal measurement device. In an exemplary embodiment, the provision of the vasostimulant **106** may include provision of modifiers of vasostimulators such as, for example, LNAME, which stops production of nitric oxide, or L-Arginine, which increases the nitric oxide level of endothelial cells.

[0149] At step **514**, the vasostimulant engine **102c** may deactivate the vasostimulant **106**. In an exemplary embodiment, the vasostimulant **106** may be an inflatable cuff, and deactivating the vasostimulant **106** at step **514** may include deflating the cuff. In an exemplary embodiment, the vasostimulant **106** may be a chemical such as, for example, nitroglycerin, and deactivating the vasostimulant **106** at step **514** may include providing an amount of the chemical in step **512** such that the effects of the chemical on the subject **10** wear off in a predetermined amount of time. In an exemplary embodiment, deactivating the vasostimulant **106** at step **514** may include providing additional chemicals to the subject **10** to reverse the effects of the vasostimulant chemicals provided in step **512**. In an exemplary embodiment, the vasostimulant **106** may be an aptitude test, and deactivating the vasostimulant **106** at step **514** may include having the subject **10** cease taking the aptitude test. In an exemplary embodiment, the vasostimulant is deactivated anywhere from 2 to 5 minutes after activation in step **512**. In an exemplary embodiment, the vasostimulant is deactivated less than 5 minutes after activation in step **512**, which is less than the conventional deactivation time for tests involving vasostimulation and provides a method which reduces the pain sometimes associated with vasostimulants. In an exemplary embodiment, the vasostimulant is deactivated less than 4 minutes after activation in step **512**, which is less than the conventional deactivation time for tests involving vasostimulation and provides a method which reduces the pain sometimes associated with vasostimulants. In an exemplary embodiment, the vasostimulant is deactivated less than 3 minutes after activation in step **512**, which is less than the conventional deactivation time for tests involving vasostimulation and provides a method which reduces the pain sometimes associated with vasostimulants. In an exemplary embodiment, the vasostimulant is deactivated approximately 2 minutes after activation in step **512**, which is less than the conventional deactivation time for tests involving vasostimulation and provides a method which reduces the pain sometimes associated with vasostimulants. In an exemplary embodiment, the subject **10** may be asked to exercise the body part on which thermal energy is being detected, which allows the method **500** to simulate a longer vasostimulation in a shorter amount of time, which can also reduce the pain sometimes associated with vasostimulants.

[0150] At step **516**, the thermal energy sensor engine **102b** begins to detect for equilibrium in the temperature of subject **10**. In an exemplary embodiment, at step **516**, the thermal energy sensor engine **102b** retrieves successive temperature measurement from the thermal energy sensor.

[0151] At decision block **518**, the thermal energy sensor engine **102b** determines whether the temperature of the subject **10** has reached equilibrium. If the temperature of the

subject **10** has not reached equilibrium, the temperature sensor engine proceeds back to step **516** to detect for equilibrium. In an exemplary embodiment, determining whether the temperature of the subject **10** has reached equilibrium in step **518** may include, for example, determining whether the temperature changes of a subject **10** are less than 0.1 degree C.

[0152] If the temperature changes in the subject **10** have reached equilibrium, the method proceeds to step **520** where the temperature sensor engine **102b** stops recording the temperature of the subject **10**.

[0153] At step **522**, data acquired from measuring and recording temperature changes which began at step **506** and continued throughout the method **500** is saved by the temperature sensor engine **102b** to a database such as, for example, the database **102a** illustrated in FIG. 3.

[0154] At step **524**, a plotting engine such as, for example, the plotting engine **102d** illustrated in FIG. 3, may retrieve data from the database **102a**.

[0155] At step **526**, the plotting engine **102d** may plot out the data retrieved. In an exemplary embodiment, the data may be plotted out as temperature vs. time. In an exemplary embodiment, the plotting engine **102d** may plot out data obtained from the temperature measurements concurrent with the data being obtained. In an exemplary embodiment, the plotting engine **102d** may retrieve data taken from multiple positions on subject **10** and plot out an average of that data over time. In an exemplary embodiment, the plotting engine **102d** may retrieve data taken from subject **10** at different times and plot out an average of that data.

[0156] Referring now to FIGS. **9a** and **9b**, an alternative embodiment of an apparatus for determining one or more health conditions **600** is substantially identical in design and operation to apparatus **100** described above with reference to FIGS. **1**, **2**, **3**, **4**, **5**, **6**, **7**, **8a** and **8b** with the addition of a display **602**, a plurality of output buttons **604**, a plurality of coupling wires **606**, and vasostimulant coupling member **608**. Computer system **102** includes the display **602** and the plurality of display output buttons **604** on a surface. A plurality of the thermal energy sensors **104a** and **104b** are coupled to the computer system **102** by respective coupling wires **606**. The vasostimulator **106** is a pressure cuff and is coupled to the computer system **102** by coupling wire **606**. The pressure cuff vasostimulator **106** includes a vasostimulant coupling member **608** along an edge of its length. In an exemplary embodiment, the pressure cuff vasostimulator **106** may be adapted to measure a subject's blood pressure. Thermal energy sensor **104a** is substantially similar to thermal energy sensor **104b** and includes a tubular housing **104aa** with a hemispherical closed end **104ab** and an open end **104ac** opposite the closed end **104ab**. The housing **104aa** defines a passageway **104ad** therein, and includes a thermal energy measurement device **104ae** positioned in the passageway **104ad** and adjacent the closed end **104ab**. A coupling member **104af** is positioned in the passageway **104ad** adjacent the open end **104ac**.

[0157] Referring now to FIG. **10a**, **10b**, **10c**, and **10d**, in an exemplary embodiment, a method for determining one or more health conditions **700** using the apparatus **600** illustrated in FIGS. **9a** and **9b** is illustrated which begins with placing the pressure cuff vasostimulant **106** on arm **12** of



subject **10** at step **702**. Pressure cuff vasostimulant **106** may be secured to arm **12** by vasostimulant coupling member **608** which may include a variety of adhesive materials known in the art. In an exemplary embodiment, the subject **10** may be in a seated position during method **700**.

[0158] At step **704**, thermal energy sensor **104a** may be placed on finger **16** of the subject **10**. Finger **16** is placed in passageway **104ad** of thermal energy sensor **104a** such that a distal end of the finger **16** is coupled to thermal energy measurement device **104ae**. With finger **16** coupled to thermal energy measurement device **104ae**, coupling member **104af** secures finger **16** in thermal energy sensor **104a**.

[0159] At step **706**, a thermal energy sensor engine such as, for example, the thermal energy sensor engine **102b** illustrated in FIG. 3, activates the thermal energy sensor **104a** to begin recording the skin temperature of the finger **16** of subject **10**. In an exemplary embodiment, temperature data begins being recorded continuously. In an exemplary embodiment, the thermal energy sensor **104a** engages the skin of the finger **16** of subject **10** in order to measure temperature. In an exemplary embodiment, the thermal energy sensor **104a** measures the skin temperature of the finger **16** of subject **10** without engaging the skin of the finger **16** of subject **10**. In an exemplary embodiment, the ambient temperature is held constant around the thermal energy sensor **104a**. In an exemplary embodiment, the fluid flow such as, for example, the airflow, around the thermal energy sensor **104a** is kept to a minimum.

[0160] At step **708**, the thermal energy sensor engine **102b** begins to detect for equilibrium in the skin temperature of the finger **16** of subject **10**. In an exemplary embodiment, at step **508**, the thermal energy sensor engine **102b** retrieves successive temperature measurement from the thermal energy sensor **104a**.

[0161] At decision block **710**, the thermal energy sensor engine **102b** determines whether the skin temperature of finger **106** of subject **10** has reached equilibrium. If the skin temperature of finger **16** has not reached equilibrium, the temperature sensor engine **102b** proceeds back to step **708** to detect for equilibrium. In an exemplary embodiment, determining whether the skin temperature of the finger **16** has reached equilibrium in step **710** may include, for example, determining whether the temperature changes of the finger **16** are less than 0.1 degree C.

[0162] If the temperature changes in the finger **16** have reached equilibrium, the method proceeds to step **712** where a vasostimulant engine such as, for example, the vasostimulant engine **102c** illustrated in FIG. 3, activates the pressure cuff vasostimulant **106**. In an exemplary embodiment, activating the pressure cuff vasostimulant **106** at step **712** may include, for example, inflating the cuff to 200 mm Hg systolic BP.

[0163] At step **714**, the vasostimulant engine **102c** may deactivate the pressure cuff vasostimulant **106**. In an exemplary embodiment, deactivating the pressure cuff vasostimulant **106** at step **714** may include deflating the cuff. In an exemplary embodiment, the pressure cuff vasostimulant **106** is deactivated anywhere from 2 to 5 minutes after activation in step **712**. In an exemplary embodiment, the vasostimulant is deactivated less than 5 minutes after activation in step **712**, which is less than the conventional deactivation time

for tests involving vasostimulation and provides a method which reduces the pain sometimes associated with vasostimulants. In an exemplary embodiment, the vasostimulant is deactivated less than 4 minutes after activation in step **712**, which is less than the conventional deactivation time for tests involving vasostimulation and provides a method which reduces the pain sometimes associated with vasostimulants. In an exemplary embodiment, the vasostimulant is deactivated less than 3 minutes after activation in step **712**, which is less than the conventional deactivation time for tests involving vasostimulation and provides a method which reduces the pain sometimes associated with vasostimulants. In an exemplary embodiment, the vasostimulant is deactivated approximately 2 minutes after activation in step **712**, which is less than the conventional deactivation time for tests involving vasostimulation and provides a method which reduces the pain sometimes associated with vasostimulants. In an exemplary embodiment, the subject **10** may be asked to exercise the body part on which thermal energy is being detected, which allows the method **700** to simulate a longer vasostimulation in a shorter amount of time, which can also reduce the pain sometimes associated with vasostimulants.

[0164] At step **716**, the thermal energy sensor engine **102b** begins to detect for equilibrium in the skin temperature of the finger **16** of subject **10**. In an exemplary embodiment, at step **716**, the thermal energy sensor engine **102b** retrieves successive temperature measurement from the thermal energy sensor **104a**.

[0165] At decision block **718**, the thermal energy sensor engine **102b** determines whether the skin temperature of the finger **16** of subject **10** has reached equilibrium. If the skin temperature of the finger **16** has not reached equilibrium, the temperature sensor engine **102b** proceeds back to step **716** to detect for equilibrium. In an exemplary embodiment, determining whether the skin temperature of the finger **16** has reached equilibrium in step **718** may include, for example, determining whether the temperature changes of the finger **16** are less than 0.1 degree C.

[0166] If the temperature changes in the finger **16** have reached equilibrium, the method proceeds to step **720** where the temperature sensor engine **102b** stops recording the skin temperature of the finger **16** of subject **10**.

[0167] At step **722**, data acquired from measuring and recording temperature changes of finger **16** which began at step **706** and continued throughout the method **700** is saved by the temperature sensor engine **102b** to a database such as, for example, the database **102a** illustrated in FIG. 3.

[0168] At step **724**, a plotting engine such as, for example, the plotting engine **102d** illustrated in FIG. 3, may retrieve data from the database **102a**.

[0169] At step **726**, the plotting engine **102d** may plot out the data retrieved. In an exemplary embodiment, the data may be plotted out as temperature vs. time. In an exemplary embodiment, the plotting engine **102d** may plot out data obtained from the temperature measurements concurrent with the data being obtained.

[0170] Referring now to FIGS. **9a**, **9b**, **11a**, **11b**, and **11c**, in an exemplary embodiment, a method for determining one or more health conditions **800** using the apparatus **600** illustrated in FIGS. **9a** and **9b** is illustrated which begins



with placing the pressure cuff vasostimulant **106** on arm **12** of subject **10** at step **802**. Pressure cuff vasostimulant **106** may be secured to arm **12** by vasostimulant coupling member **608** which may include a variety of adhesive materials known in the art. In an exemplary embodiment, the subject **10** may be in a seated position during method **700**.

[0171] At step **804**, thermal energy sensor **104a** may be placed on finger **16** of the subject **10**. Finger **16** is placed in passageway **104ad** of thermal energy sensor **104a** such that a distal end of the finger **16** is coupled to thermal energy measurement device **104ae**. With finger **16** coupled to thermal energy measurement device **104ae**, coupling member **104af** secures finger **16** in thermal energy sensor **104a**.

[0172] At step **806**, thermal energy sensor **104b** may be placed on contralateral finger **18** of the subject. Contralateral finger **18** is placed in thermal energy sensor **104b** in substantially the same manner as finger **16** is placed in thermal energy sensor **104a** described above with reference to FIGS. **9a**, **9b**, **10c** and **10d**. In an exemplary embodiment, a plurality of thermal energy sensors similar to thermal energy sensor **104**, illustrated in FIG. **3**, may be placed on a plurality of contralateral body parts. In an exemplary embodiment, a contralateral body part includes any body part on the subject which is not directly affected by the vasostimulant activated in step **814** such as, for example, any body part on the subject which is not distal to the vasostimulant. In an exemplary embodiment, the thermal energy sensor **104b** may be placed on the toe **22** of the subject.

[0173] At step **808**, a thermal energy sensor engine such as, for example, the thermal energy sensor engine **102b** illustrated in FIG. **3**, activates the thermal energy sensors **104** to begin recording the skin temperature of the finger **16** and contralateral finger **18** of subject. In an exemplary embodiment, temperature data begins being recorded continuously. In an exemplary embodiment, the thermal energy sensors **104a** and **104b** engage the skin of the finger **16** and contralateral finger **18** of subject in order to measure temperature. In an exemplary embodiment, the thermal energy sensor **104a** and **104b** measure the skin temperature of the finger **16** and contralateral finger **18** of subject **10** without engaging the skin of the finger **16** and contralateral finger **18** of subject. In an exemplary embodiment, the ambient temperature is held constant around the thermal energy sensor **104a** and **104b**. In an exemplary embodiment, the fluid flow such as, for example, the airflow, around the thermal energy sensor **104a** and **104b** is kept to a minimum.

[0174] At step **810**, the thermal energy sensor engine **102b** begins to detect for equilibrium in the skin temperature of the finger **16** of subject. In an exemplary embodiment, at step **810**, the thermal energy sensor engine **102b** retrieves successive temperature measurement from the thermal energy sensor **104a**.

[0175] At decision block **812**, the thermal energy sensor engine **102b** determines whether the skin temperature of finger **16** of subject has reached equilibrium. If the skin temperature of finger **16** has not reached equilibrium, the temperature sensor engine **102b** proceeds back to step **810** to detect for equilibrium. In an exemplary embodiment, determining whether the skin temperature of the finger **16** has reached equilibrium in step **812** may include, for example, determining whether the temperature changes of the finger **16** are less than 0.1 degree C.

[0176] If the temperature changes in the finger **16** have reached equilibrium, the method proceeds to step **814** where a vasostimulant engine such as, for example, the vasostimulant engine **102c** illustrated in FIG. **3**, activates the pressure cuff vasostimulant **106**. In an exemplary embodiment, activating the pressure cuff vasostimulant **106** at step **814** may include, for example, inflating the cuff to 200 mm Hg systolic BP.

[0177] At step **816**, the vasostimulant engine **102c** may deactivate the pressure cuff vasostimulant **106**. In an exemplary embodiment, deactivating the pressure cuff vasostimulant **106** at step **816** may include deflating the cuff. In an exemplary embodiment, the pressure cuff vasostimulant **106** is deactivated anywhere from 2 to 5 minutes after activation in step **814**. In an exemplary embodiment, the vasostimulant is deactivated less than 5 minutes after activation in step **814**, which is less than the conventional deactivation time for tests involving vasostimulation and provides a method which reduces the pain sometimes associated with vasostimulants. In an exemplary embodiment, the vasostimulant is deactivated less than 4 minutes after activation in step **814**, which is less than the conventional deactivation time for tests involving vasostimulation and provides a method which reduces the pain sometimes associated with vasostimulants. In an exemplary embodiment, the vasostimulant is deactivated less than 3 minutes after activation in step **814**, which is less than the conventional deactivation time for tests involving vasostimulation and provides a method which reduces the pain sometimes associated with vasostimulants. In an exemplary embodiment, the vasostimulant is deactivated approximately 2 minutes after activation in step **814**, which is less than the conventional deactivation time for tests involving vasostimulation and provides a method which reduces the pain sometimes associated with vasostimulants. In an exemplary embodiment, the subject **10** may be asked to exercise the body part on which thermal energy is being detected, which allows the method **800** to simulate a longer vasostimulation in a shorter amount of time, which can also reduce the pain sometimes associated with vasostimulants.

[0178] At step **818**, the thermal energy sensor engine **102b** begins to detect for equilibrium in the skin temperature of the finger **16** of subject **10**. In an exemplary embodiment, at step **818**, the thermal energy sensor engine **102b** retrieves successive temperature measurement from the thermal energy sensor **104a**. At decision block **820**, the thermal energy sensor engine **102b** determines whether the skin temperature of the finger **16** of subject **10** has reached equilibrium. If the skin temperature of the finger **16** has not reached equilibrium, the temperature sensor engine **102b** proceeds back to step **818** to detect for equilibrium. In an exemplary embodiment, determining whether the skin temperature of the finger **16** has reached equilibrium in step **820** may include, for example, determining whether the temperature changes of the finger **16** are less than 0.1 degree C.

[0179] If the temperature changes in the finger **16** have reached equilibrium, the method proceeds to step **822** where the temperature sensor engine **102b** stops recording the skin temperature of the finger **16** of subject **10**. At step **824**, data acquired from measuring and recording temperature changes of finger **16** and contralateral finger **18** which began at step **808** and continued throughout the method **800** is saved by the temperature sensor engine **102b** to a database



such as, for example, the database **102a** illustrated in FIG. 3. At step **826**, a plotting engine such as, for example, the plotting engine **102d** illustrated in FIG. 3, may retrieve data from the database **102a**.

[0180] At step **828**, the plotting engine **102d** may plot out the data retrieved. In an exemplary embodiment, the data may be plotted out as temperature vs. time. In an exemplary embodiment, the data for the finger **16** and contralateral finger **18** may be plotted on the same graph. In an exemplary embodiment, the plotting engine **102d** may plot out data obtained from the temperature measurements concurrent with the data being obtained. In an exemplary embodiment, the temperature changes measured in the finger **16** may be adjusted based on the temperature changes measured in the contralateral finger **18**. For example, the adjustment may include subtracting the temperature changes measured in the contralateral finger **18** from the temperature changes measured in the finger **16**, or vice versa.

[0181] Referring now to FIGS. **9a**, **9b**, **12a**, **12b**, and **12c**, in an exemplary embodiment, a method for determining one or more health conditions **900** using the apparatus **600** illustrated in FIGS. **9a** and **9b** is illustrated which begins with placing the pressure cuff vasostimulant **106** on a leg of subject **10** at step **902**. Pressure cuff vasostimulant **106** may be secured to a leg by vasostimulant coupling member **608** which may include a variety of adhesive materials known in the art. At step **904**, thermal energy sensor **104a** may be placed on a toe of the subject **10**. A toe is placed in thermal energy sensor **104b** in substantially the same manner as finger **16** is placed in thermal energy sensor **104a** described above with reference to FIGS. **9a**, **9b**, **10c** and **10d**.

[0182] At step **906**, a thermal energy sensor engine such as, for example, the thermal energy sensor engine **102b** illustrated in FIG. 3, activates the thermal energy sensor **104a** to begin recording the skin temperature of the toe of a subject. In an exemplary embodiment, temperature data begins being recorded continuously. In an exemplary embodiment, the thermal energy sensor **104a** engages the skin of the toe in order to measure temperature. In an exemplary embodiment, the thermal energy sensor **104a** measures the skin temperature of the toe without engaging the skin of the toe. In an exemplary embodiment, the ambient temperature is held constant around the thermal energy sensor **104a**. In an exemplary embodiment, the fluid flow such as, for example, the airflow, around the thermal energy sensor **104a** is kept to a minimum.

[0183] At step **908**, the thermal energy sensor engine **102b** begins to detect for equilibrium in the skin temperature of the toe. In an exemplary embodiment, at step **908**, the thermal energy sensor engine **102b** begins comparing successive temperature measurement from the thermal energy sensor **104a**.

[0184] At decision block **910**, the thermal energy sensor engine **102b** determines whether the skin temperature of toe has reached equilibrium. If the skin temperature of toe has not reached equilibrium, the temperature sensor engine **102b** proceeds back to step **908** to detect for equilibrium. In an exemplary embodiment, determining whether the skin temperature of the toe has reached equilibrium in step **812** may include, for example, determining whether the temperature changes of the toe are less than 0.1 degree C.

[0185] If the temperature changes in the toe have reached equilibrium, the method proceeds to step **912** where a

vasostimulant engine such as, for example, the vasostimulant engine **102c** illustrated in FIG. 3, activates the pressure cuff vasostimulant **106**. In an exemplary embodiment, activating the pressure cuff vasostimulant **106** at step **912** may include, for example, inflating the cuff to 200 mm Hg systolic BP.

[0186] At step **914**, the vasostimulant engine **102c** may deactivate the pressure cuff vasostimulant **106**. In an exemplary embodiment, deactivating the pressure cuff vasostimulant **106** at step **914** may include deflating the cuff. In an exemplary embodiment, the pressure cuff vasostimulant **106** is deactivated anywhere from 2 to 5 minutes after activation in step **912**. In an exemplary embodiment, the vasostimulant is deactivated less than 5 minutes after activation in step **912**, which is less than the conventional deactivation time for tests involving vasostimulation and provides a method which reduces the pain sometimes associated with vasostimulants. In an exemplary embodiment, the vasostimulant is deactivated less than 4 minutes after activation in step **912**, which is less than the conventional deactivation time for tests involving vasostimulation and provides a method which reduces the pain sometimes associated with vasostimulants. In an exemplary embodiment, the vasostimulant is deactivated less than 3 minutes after activation in step **912**, which is less than the conventional deactivation time for tests involving vasostimulation and provides a method which reduces the pain sometimes associated with vasostimulants. In an exemplary embodiment, the vasostimulant is deactivated approximately 2 minutes after activation in step **912**, which is less than the conventional deactivation time for tests involving vasostimulation and provides a method which reduces the pain sometimes associated with vasostimulants. In an exemplary embodiment, the subject may be asked to exercise the body part on which thermal energy is being detected, which allows the method **900** to simulate a longer vasostimulation in a shorter amount of time, which can also reduce the pain sometimes associated with vasostimulants.

[0187] At step **916**, the thermal energy sensor engine **102b** begins to detect for equilibrium in the skin temperature of the toe. In an exemplary embodiment, at step **916**, the thermal energy sensor engine **102b** retrieves successive temperature measurement from the thermal energy sensor **104a**. At decision block **918**, the thermal energy sensor engine **102b** determines whether the skin temperature of the toe has reached equilibrium. If the skin temperature of the toe has not reached equilibrium, the temperature sensor engine **102b** proceeds back to step **916** to detect for equilibrium. In an exemplary embodiment, determining whether the skin temperature of the toe has reached equilibrium in step **918** may include, for example, determining whether the temperature changes of the toe are less than 0.1 degree C.

[0188] If the temperature changes in the toe has reached equilibrium, the method proceeds to step **920** where the temperature sensor engine **102b** stops recording the skin temperature of the toe. At step **922**, data acquired from measuring and recording temperature changes of toe **22** which began at step **906** and continued throughout the method **900** is saved by the temperature sensor engine **102b** to a database such as, for example, the database **102a** illustrated in FIG. 3. At step **924**, a plotting engine such as, for example, the plotting engine **102d** illustrated in FIG. 3, may retrieve data from the database **102a**. At step **926**, the



plotting engine **102d** may plot out the data retrieved. In an exemplary embodiment, the data may be plotted out as temperature vs. time. In an exemplary embodiment, the plotting engine **102d** may plot out data obtained from the temperature measurements concurrent with the data being obtained.

[0189] Referring now to FIG. 13, an alternative embodiment of a method for determining one or more health conditions **1000** is substantially identical in design and operation to method **500** described above with reference to FIGS. **8a** and **8b**, with the addition of determining health condition at step **1002**. In an exemplary embodiment, determining health condition at step **1002** may involve a health care professional analyzing the temperature data in order to diagnose a variety of health conditions for the subject **10**. In an several exemplary embodiments, determining a health condition at step **1002** includes, for example, assessing the risk of atherosclerotic cardiovascular disorder, monitoring the progression of heart failure, managing obesity, screening for high sympathetic reactivity, screening for high blood pressure, screening for white coat hypertension, screening for smooth muscle cell dysfunction, predicting the development of diabetes, determining a fitness level, assessing the vascular effects of a rheumatologic disorder, screening for Raynaud's phenomenon, predicting the risk of connective tissue disorders, determining the risk for pulmonary hypertension, monitoring a smoking cessation program, and monitoring sleep disorders such as, for example, sleep apnea.

[0190] Referring now to FIG. 14, an alternative embodiment of a method for determining one or more health conditions **1100** is substantially identical in design and operation to method **500** described above with reference to FIGS. **8a** and **8b**, with the addition of consulting additional diagnosis methods at step **1102** and determining health condition at step **1104**. In an exemplary embodiment, consulting additional diagnosis methods at step **1102** may involve measuring other parameters of subject **10** such as, for example, blood pressure, glucose level, internal temperature, and a variety of others. In an exemplary embodiment, determining health condition at step **1104** may involve a health care professional analyzing the temperature data along with data obtained from additional diagnosis methods in order to diagnose a variety of health conditions for the subject. In an several exemplary embodiments, determining a health condition at step **1002** includes, for example, assessing the risk of atherosclerotic cardiovascular disorder, monitoring the progression of heart failure, managing obesity, screening for high sympathetic reactivity, screening for high blood pressure, screening for white coat hypertension, screening for smooth muscle cell dysfunction, predicting the development of diabetes, determining a fitness level, assessing the vascular effects of a rheumatologic disorder, screening for Raynaud's phenomenon, predicting the risk of connective tissue disorders, determining the risk for pulmonary hypertension, monitoring a smoking cessation program, and monitoring sleep disorders such as, for example, sleep apnea.

[0191] Referring now to FIG. 15, an alternative embodiment of an apparatus for determining one or more health conditions **1200** is substantially identical in design and operation to apparatus **600** described above with reference to FIGS. **9a**, **9b**, **10a**, **10b**, **10c**, and **10d**, with the addition of

a thermal energy sensor **1202**. Thermal energy sensor **1202** is coupled to computer system **102** by wire **606** and includes a glove **1202a** including a plurality of thermal energy measurement devices **1204a**, **1204b**, and **1204c**, which are positioned at different locations on the glove **1202a**. Having the thermal energy measurement devices **1204a**, **1204b**, and **1204c** positioned at different locations on the glove **1202a** allows blood flow rate from device to device to be calculated. In an exemplary embodiment, glove **1202a** may extend and cover the skin surface up to the vasostimulant **106**.

[0192] Referring now to FIG. 16, an alternative embodiment of an apparatus for determining one or more health conditions **1300** is substantially identical in design and operation to apparatus **600** described above with reference to FIGS. **9a**, **9b**, **10a**, **10b**, **10c**, and **10d**, with the addition of a thermal energy sensor **1302**. Thermal energy sensor **1302** is coupled to computer system **102** by wire **606** and includes a coupler **1304** operable to couple the thermal energy sensor **1302** to subject **10** without substantially changing the temperature of the subject **10**. In an exemplary embodiment, the coupler **1304** may be a mesh material or other similar materials that limit thermal insulation of the subject **10**. In an exemplary embodiment, the coupler **1304** is operable to keep the thermal energy sensor **1302** in contact with the skin surface with minimal pressure, contact area, and insulation.

[0193] Referring now to FIG. 17, an alternative embodiment of an apparatus for determining one or more health conditions **1400** is substantially identical in design and operation to apparatus **600** described above with reference to FIGS. **9a**, **9b**, **10a**, **10b**, **10c**, and **10d**, with the addition of a support strap **1402**. The support strap **1402** allows the apparatus **1400** to be coupled to the subject for repeated use of the apparatus throughout a predetermined time period such as, for example, 24 hours. In an exemplary embodiment, support strap **902** allows ambulatory measurements to be taken of the subject.

[0194] Referring now to FIGS. **9a**, **9b**, **17**, **18a**, and **18b**, in an exemplary embodiment, a method for determining one or more health conditions **1500** using the apparatus **1400** illustrated in FIG. 17 is illustrated which begins with placing the pressure cuff vasostimulant **106** on arm **12** of subject **10** at step **1502**. Pressure cuff vasostimulant **106** may be secured to arm **12** by vasostimulant coupling member **608** and with securing strap **1402**, which keeps pressure cuff vasostimulant **102** positioned properly on arm **12**.

[0195] At step **1504**, thermal energy sensor **104** may be placed on finger **16** of the subject **10**. Finger **16** is placed in passageway **104d** of thermal energy sensor **104** such that a distal end of the finger **16** is coupled to thermal energy measurement device **104e**. With finger **16** coupled to thermal energy measurement device **104e**, coupling member **104f** secures finger **16** in thermal energy sensor **104**.

[0196] At step **1506**, computer system **102** may be positioned on subject **10**. In an exemplary embodiment, computer system **102** may be positioned on subject **10** by coupling it to a belt, waistband, or other article of clothing on subject **10**.

[0197] At step **1508**, the computer system **102** is placed on standby. In an exemplary embodiment, when computer system **102** is on standby at step **1508**, the computer system **102** is powered on but not running as to save power in the computer system **102**.



[0198] At decision block 1510, the computer system 102 checks whether the apparatus 1400 is scheduled to run. If the apparatus 1400 is not scheduled to run, the computer system is returned to standby at step 1508. In an exemplary embodiment, the apparatus may be scheduled to run periodically through a predetermined time period such as, for example, 24 hours.

[0199] If the apparatus 1400 is scheduled to run, the method 1500 proceeds to step 1512 where a thermal energy sensor engine such as, for example, the thermal energy sensor engine 102b illustrated in FIG. 3, activates the thermal energy sensor 104 to begin recording the skin temperature of the finger 16 of subject 10. In an exemplary embodiment, temperature data begins being recorded continuously. In an exemplary embodiment, the thermal energy sensor 104 engages the skin of the finger 16 of subject 10 in order to measure temperature. In an exemplary embodiment, the thermal energy sensor 104 measures the skin temperature of the finger 16 of subject 10 without engaging the skin of the finger 16 of subject 10. In an exemplary embodiment, the ambient temperature is held constant around the thermal energy sensor 104. In an exemplary embodiment, the fluid flow such as, for example, the airflow, around the thermal energy sensor 104 is kept to a minimum.

[0200] At step 1514, the thermal energy sensor engine 102b begins to detect for equilibrium in the skin temperature of the finger 16 of subject 10. In an exemplary embodiment, at step 1514, the thermal energy sensor engine 102b retrieves successive temperature measurement from the thermal energy sensor 104.

[0201] At decision block 1516, the thermal energy sensor engine 102b determines whether the skin temperature of finger 106 of subject 10 has reached equilibrium. If the skin temperature of finger 16 has not reached equilibrium, the temperature sensor engine 102b proceeds back to step 1514 to detect for equilibrium. In an exemplary embodiment, determining whether the skin temperature of the finger 16 has reached equilibrium in step 1516 may include, for example, determining whether the temperature changes of the finger 16 are less than 0.1 degree C.

[0202] If the temperature changes in the finger 16 have reached equilibrium, the method proceeds to step 1518 where a vasostimulant engine such as, for example, the vasostimulant engine 102c illustrated in FIG. 2, activates the pressure cuff vasostimulant 106. In an exemplary embodiment, activating the pressure cuff vasostimulant 106 at step 1518 may include, for example, inflating the cuff to 200 mm Hg systolic BP.

[0203] At step 1520, the vasostimulant engine 102c may deactivate the pressure cuff vasostimulant 106. In an exemplary embodiment, deactivating the pressure cuff vasostimulant 106 at step 1520 may include deflating the cuff. In an exemplary embodiment, the pressure cuff vasostimulant 106 is deactivated anywhere from 2 to 5 minutes after activation in step 1518. In an exemplary embodiment, the vasostimulant is deactivated less than 5 minutes after activation in step 1518, which is less than the conventional deactivation time for tests involving vasostimulation and provides a method which reduces the pain sometimes associated with vasostimulants. In an exemplary embodiment, the vasostimulant is deactivated less than 4 minutes after activation in step 1518, which is less than the conventional deactivation time

for tests involving vasostimulation and provides a method which reduces the pain sometimes associated with vasostimulants. In an exemplary embodiment, the vasostimulant is deactivated less than 3 minutes after activation in step 1518, which is less than the conventional deactivation time for tests involving vasostimulation and provides a method which reduces the pain sometimes associated with vasostimulants. In an exemplary embodiment, the vasostimulant is deactivated approximately 2 minutes after activation in step 1518, which is less than the conventional deactivation time for tests involving vasostimulation and provides a method which reduces the pain sometimes associated with vasostimulants. In an exemplary embodiment, the subject may be asked to exercise the body part on which thermal energy is being detected, which allows the method 1500 to simulate a longer vasostimulation in a shorter amount of time, which can also reduce the pain sometimes associated with vasostimulants.

[0204] At step 1522, the thermal energy sensor engine 102b begins to detect for equilibrium in the skin temperature of the finger 16 of subject 10. In an exemplary embodiment, at step 1522, the thermal energy sensor engine 102b retrieves successive temperature measurement from the thermal energy sensor 104.

[0205] At decision block 1524, the thermal energy sensor engine 102b determines whether the skin temperature of the finger 16 of subject 10 has reached equilibrium. If the skin temperature of the finger 16 has not reached equilibrium, the temperature sensor engine 102b proceeds back to step 1522 to detect for equilibrium. In an exemplary embodiment, determining whether the skin temperature of the finger 16 has reached equilibrium in step 1524 may include, for example, determining whether the temperature changes of the finger 16 are less than 0.1 degree C.

[0206] If the temperature changes in the finger 16 have reached equilibrium, the method proceeds to step 1526 where the temperature sensor engine 102b stops recording the skin temperature of the finger 16 of subject 10. At step 1528, data acquired from measuring and recording temperature changes of finger 16 which began at step 1512 and continued throughout the method 1500 is saved by the temperature sensor engine 102b to a database such as, for example, the database 102a illustrated in FIG. 3.

[0207] At decision block 1530, the computer system 102 checks whether there are any more scheduled runs for apparatus 1400. If there are more scheduled runs for apparatus 1400, the method 1500 returns to step 1508 where the computer system 102 goes on standby. In an exemplary embodiment, the apparatus may be scheduled to run periodically through a predetermined time period such as, for example, 24 hours.

[0208] If there are no more scheduled runs for apparatus 1400, the method proceeds to step 1532 where a plotting engine such as, for example, the plotting engine 102d illustrated in FIG. 3, may retrieve data from the database 102a.

[0209] At step 1534, the plotting engine 102d may plot out the data retrieved. In an exemplary embodiment, the data may be plotted out as temperature vs. time. In an exemplary embodiment, the plotting engine 102d may plot out data obtained from the temperature measurements concurrent with the data being obtained.



[0210] Referring now to FIG. 19, in an exemplary embodiment, a method for determining one or more health conditions 1600 is illustrated which begins with a subject preparation at step 1602. Subject preparation at step 1602 may include, for example, having a subject refrain from eating before undergoing the method 1600, having the subject refrain from smoking before undergoing the method 1600, having the subject refrain from ingesting alcohol or caffeine before undergoing the method 1600, or having the subject refrain from taking any vascular medications before undergoing the method 1600.

[0211] At step 1604, a thermal energy sensor such as, for example, the thermal energy sensor 104 illustrated in FIG. 3, may be placed on the subject. In an exemplary embodiment, the thermal energy sensor 104 may be a conventional thermal energy sensor known in the art. In an exemplary embodiment, the thermal energy sensor 104 is designed such that there is a minimal area of contact between the sensor and the subject. In an exemplary embodiment, when placed on the subject, the thermal energy sensor 104 provides a minimal pressure to the subject. In an exemplary embodiment, in operation, the thermal energy sensor 104 measures thermal energy only and does not introduce any signals into the subject. In an exemplary embodiment, thermal energy measured by the thermal energy sensor 104 is not effected by insulation or perspiration. In an exemplary embodiment, the thermal energy sensor 104 does not alter the microcapillary flow in the subject. In an exemplary embodiment, the thermal energy sensor 104 does not restrict movement of the subject and thermal energy measurements are not effected by subject movement. In an exemplary embodiment, a plurality of thermal energy sensor 104 may be positioned at different locations on the subject. In an exemplary embodiment, the thermal energy sensor 104 is positioned on a body part of the subject such as, for example, a finger, forearm, toe, leg, earlobe, or nose. In an exemplary embodiment, the thermal energy sensor 104 may be placed on the subject in order to measure the thermal energy of distal resistant vessels on the subject.

[0212] At step 1606, a thermal energy sensor engine such as, for example, the thermal energy sensor engine 102b illustrated in FIG. 3, activates a thermal energy sensor such as, for example, the thermal energy sensor 104 illustrated in FIG. 3, to begin recording the temperature of the subject. In an exemplary embodiment, temperature data begins being recorded continuously. In an exemplary embodiment, the thermal energy sensor 104 measures the skin temperature of the subjects body on which it is placed such as, for example, the hand, forearm, foot, leg, earlobe, or nose. In an exemplary embodiment, the thermal energy sensor 104 engages the skin of the subject in order to measure temperature. In an exemplary embodiment, the thermal energy sensor 104 measures the skin temperature of the subject without engaging the skin of the subject. In an exemplary embodiment, the ambient temperature is held constant around the thermal energy sensor 104. In an exemplary embodiment, the fluid flow such as, for example, the airflow, around the thermal energy sensor 104 is kept to a minimum.

[0213] At step 1608, the thermal energy sensor engine 102b begins to detect for equilibrium in the subject. In an exemplary embodiment, at step 1608, the thermal energy sensor engine 102b retrieves successive temperature measurement from the thermal energy sensor.

[0214] At decision block 1610, the thermal energy sensor engine 102b determines whether the subject has reached equilibrium. If the subject has not reached equilibrium, the temperature sensor engine proceeds back to step 1608 to detect for equilibrium. In an exemplary embodiment, determining whether the subject 10 has reached equilibrium in step 1610 may include, for example, determining whether the temperature changes of a subject are less than 0.1 degree C.

[0215] If the temperature changes in the subject have reached equilibrium, the method proceeds to step 1612 where a second body part of subject is placed in water. In an exemplary embodiment, the water may be ice water.

[0216] At step 1614, the thermal energy sensor engine 102b continues recording the temperature of the subject.

[0217] At step 1616, the thermal energy sensor engine 102b stops recording the temperature of the subject after a predetermined amount of time.

[0218] At step 1618, data acquired from measuring and recording temperature changes which began at step 1606 and continued throughout the method 1600 is saved by the temperature sensor engine 102b to a database such as, for example, the database 102a illustrated in FIG. 3.

[0219] At step 1620, a plotting engine such as, for example, the plotting engine 102d illustrated in FIG. 3, may retrieve data from the database 102a.

[0220] At step 1622, the plotting engine 102d may plot out the data retrieved. In an exemplary embodiment, the data may be plotted out as temperature vs. time. In an exemplary embodiment, the plotting engine 102d may plot out data obtained from the temperature measurements concurrent with the data being obtained.

[0221] At step 1624, a health professional may analyze the data acquired through method 1600 in order to diagnose a variety of health conditions in subject.

[0222] Referring now to FIG. 20a and 20b, in an exemplary embodiment, a method for determining one or more health conditions 1700 is illustrated which begins with a subject preparation at step 1702. Subject preparation at step 1702 may include, for example, having a subject refrain from eating before undergoing the method 1700, having the subject refrain from smoking before undergoing the method 1700, having the subject refrain from ingesting alcohol or caffeine before undergoing the method 1700, or having the subject refrain from taking any vascular medications before undergoing the method 1700.

[0223] At step 1704, a first body part of the subject is placed in a medium. In an exemplary embodiment, the medium may be a medium which has a minimum specific heat capacity and/or a maximum heat conductivity in order to provide maximum heat transfer between the body part of the subject and a thermal energy sensor such as, for example, the thermal energy sensor 104 illustrated in FIG. 2.

[0224] At step 1706, a thermal energy sensor engine such as, for example, the thermal energy sensor engine 102b illustrated in FIG. 2, activates a thermal energy sensor such as, for example, the thermal energy sensor 104 illustrated in FIG. 3, to begin recording the temperature of the medium.



[0225] At step 1708, the thermal energy sensor engine 102b begins to detect for equilibrium in the medium. In an exemplary embodiment, at step 1708, the thermal energy sensor engine 102b retrieves successive temperature measurement from the thermal energy sensor.

[0226] At decision block 1710, the thermal energy sensor engine 102b determines whether the medium has reached equilibrium. If the medium has not reached equilibrium, the temperature sensor engine 102b proceeds back to step 1708 to detect for equilibrium. In an exemplary embodiment, determining whether the medium has reached equilibrium in step 1710 may include, for example, determining whether the temperature changes of the medium are less than 0.1 degree C.

[0227] If the temperature changes in the medium have reached equilibrium, the method proceeds to step 1712 where a vasostimulant engine such as, for example, the vasostimulant engine 102c illustrated in FIG. 3, activates a vasostimulant such as, for example, the vasostimulant 106 illustrated in FIG. 2. In an exemplary embodiment, the vasostimulant 106 may be an inflatable cuff, and activating the vasostimulant 106 at step 1712 may include, for example inflating the cuff to 200 mm Hg systolic BP. In an exemplary embodiment, the vasostimulant 106 may be a chemical such as, for example, nitroglycerin, and activating the vasostimulant 106 at step 1712 may include administering a predetermined amount of the chemical to the subject. In an exemplary embodiment, the vasostimulant 106 may be an aptitude test, and activating the vasostimulant 106 at step 1712 may include having the subject begin the aptitude test.

[0228] At step 1714, the vasostimulant engine 102c may deactivate the vasostimulant 106. In an exemplary embodiment, the vasostimulant 106 may be an inflatable cuff, and deactivating the vasostimulant 106 at step 1714 may include deflating the cuff. In an exemplary embodiment, the vasostimulant 106 may be a chemical such as, for example, nitroglycerin, and deactivating the vasostimulant 106 at step 1714 may include providing an amount of the chemical in step 1712 such that the effects of the chemical on the subject wear off in a predetermined amount of time. In an exemplary embodiment, deactivating the vasostimulant 106 at step 1714 may include providing additional chemicals to the subject to reverse the effects of the vasostimulant chemicals provided in step 1712. In an exemplary embodiment, the vasostimulant 106 may be an aptitude test, and deactivating the vasostimulant 106 at step 1714 may include having the subject cease taking the aptitude test. In an exemplary embodiment, the vasostimulant is deactivated anywhere from 2 to 5 minutes after activation in step 1714. In an exemplary embodiment, the vasostimulant is deactivated less than 5 minutes after activation in step 1714, which is less than the conventional deactivation time for tests involving vasostimulation and provides a method which reduces the pain sometimes associated with vasostimulants. In an exemplary embodiment, the vasostimulant is deactivated less than 4 minutes after activation in step 1714, which is less than the conventional deactivation time for tests involving vasostimulation and provides a method which reduces the pain sometimes associated with vasostimulants. In an exemplary embodiment, the vasostimulant is deactivated less than 3 minutes after activation in step 1714, which is less than the conventional deactivation time for tests involving vasostimulation and provides a method which reduces

the pain sometimes associated with vasostimulants. In an exemplary embodiment, the vasostimulant is deactivated approximately 2 minutes after activation in step 1714, which is less than the conventional deactivation time for tests involving vasostimulation and provides a method which reduces the pain sometimes associated with vasostimulants. In an exemplary embodiment, the subject 10 may be asked to exercise the body part on which thermal energy is being detected, which allows the method 1700 to simulate a longer vasostimulation in a shorter amount of time, which can also reduce the pain sometimes associated with vasostimulants.

[0229] At step 1716, the thermal energy sensor engine 102b begins to detect for equilibrium in the temperature of the medium. In an exemplary embodiment, at step 1716, the thermal energy sensor engine 102b retrieves successive temperature measurement from the thermal energy sensor.

[0230] At decision block 1718, the thermal energy sensor engine 102b determines whether the temperature of the medium has reached equilibrium. If the temperature of the medium has not reached equilibrium, the temperature sensor engine proceeds back to step 1716 to detect for equilibrium. In an exemplary embodiment, determining whether the temperature of the medium has reached equilibrium in step 1718 may include, for example, determining whether the temperature changes of medium are less than 0.1 degree C.

[0231] If the temperature changes in the medium have reached equilibrium, the method proceeds to step 1720 where the temperature sensor engine 102b stops recording the temperature of the medium.

[0232] At step 1722, data acquired from measuring and recording temperature changes which began at step 1706 and continued throughout the method 1700 is saved by the temperature sensor engine 102b to a database such as, for example, the database 102a illustrated in FIG. 3. At step 1724, a plotting engine such as, for example, the plotting engine 102d illustrated in FIG. 3, may retrieve data from the database 102a. At step 1726, the plotting engine 102d may plot out the data retrieved. In an exemplary embodiment, the data may be plotted out as temperature vs. time. In an exemplary embodiment, the plotting engine 102d may plot out data obtained from the temperature measurements concurrent with the data being obtained.

[0233] At step 1728, a health professional may analyze the data acquired through method 1700 in order to diagnose a variety of health conditions in subject 10.

[0234] Referring now to FIG. 21, a representative experimental graph 1800 of temperature vs. time is illustrated for a healthy subject during the methods 500, 700, 800, 900, 1000, 1100, 1500, 1600, or 1700. In an exemplary embodiment, the graph 1800 may be produced by the plotting engine 102d, illustrated in FIG. 3. A baseline temperature 1802 is achieved when the subject reaches a steady temperature after having a thermal energy sensor such as, for example, the thermal energy sensor 104 illustrated in FIG. 3, coupled to them. At time 1804, the vasostimulant is activated, causing the temperature of the subject to drop, resulting in a slope 1806. At time 1808, the vasostimulant is deactivated, causing the temperature of the subject to rise, resulting in a slope 1810. The temperature of the subject crosses the baseline temperature 1802 and reaches a peak temperature 1812, after which the temperature returns back



to the baseline temperature **1802**. A number of measurements can be made from the data shown in graph **1800** including, but not limited to, the fall temperature change TF between the baseline temperature **1802** and the temperature recorded at time **1808**, the rebound temperature change TR between the baseline temperature **1802** and the peak temperature **1812**, the nadir to peak temperature change TNP between the temperature recorded at time **1808** and the peak temperature **1812**, the time to fall temperature TTF, the time to rebound temperature TTR, the time to stabilized temperature TS, the steepness of the slopes **1806** and **1810**, the area under the temperature curve bounded by the temperature curve and the temperature reached at time **1808** and between time equal zero and time **1808**, the area under the temperature curve bounded by the temperature curve and the temperature reached at time **1808** and between time **1808** and the time at peak temperature **1812**, and the area under the temperature curve bounded by the temperature curve and the temperature reached at time **1808** and between time **1808** and the time at which the temperature stabilizes.

[0235] In an exemplary embodiment, healthy vascular reactivity may be indicated by a value of TNP which is greater than TF. In an exemplary embodiment, unhealthy vascular reactivity may be indicated by a value of TNP which is less than TF. In an exemplary embodiment, unhealthy vascular reactivity may be indicated by a negative value of TR. In an exemplary embodiment, several graphs similar to graph **1800** may be taken from a subject and then averaged to get an average graph for the subject which may indicate the average response for the subject over a period of time.

[0236] In an exemplary embodiment, the value of TR may be normalized using thermodynamic equations for calculating heat flow based on the following parameters: baseline temperature **1802**, fall temperature change TF, ambient room temperature, core temperature, tissue heat capacity, tissue metabolism rate, tissue heat conduction, the mass of the testing volume, the location the method is conducted, blood flow rate, the position of the subject during the method, and a variety of other physical and/or physiological factors that may effect the value of TR. In an experimental embodiment of the method **500** described above with respect to FIGS. **8a** and **8b**, an ambient temperature of 22 degrees C. was measured. A first subject was tested and found to have a baseline temperature of 35 degrees C., a TF of 2 degrees C. and a TR of 0.5 degrees. A subject like first subject has a baseline temperature which is significantly greater than the ambient temperature, and it is expected that such a subject will experience a higher than normal TF and a lower than normal TR. Furthermore, a subject having a baseline temperature which is significantly greater than the subject's core temperature is expected to experience a higher than normal TF and a lower than normal TR. A second subject was tested and found to have a baseline temperature of 25 degrees C., a TF of 1 degrees C. and a TR of 3 degrees. A subject like second subject has a baseline temperature which is close to the ambient temperature, and it is expected that such a subject will experience a lower than normal TF and a higher than normal TR. Furthermore, a subject having a baseline temperature which is close to the subject's core temperature is expected to experience a lower than normal TF and a higher than normal TR.

[0237] Referring now to FIG. **22**, in an exemplary experimental embodiment EXP1, the method **500** was carried out on a subject, and a graph EXP1A was obtained of data relating to temperature changes of the skin on a finger of the subject. A pressure cuff was provided as the vasostimulant, and vasostimulant activation at time **1804** and deactivation at time **1808** was provided by inflating and deflating the pressure cuff. The subject exhibited a baseline temperature **1802** of approximately 30 degrees C., a temperature at time **1808** of approximately 29.1 degrees C., a peak temperature **1812** of approximately 31 degrees C., and a rebound temperature change TR of approximately 1 degree C. The subject showed presumably good endothelial function due to, for example, the positive value of rebound temperature change TR.

[0238] Referring now to FIG. **23**, in an exemplary experimental embodiment EXP2, the method **500** was carried out on a subject, and a graph EXP2A was obtained of data relating to temperature changes of the skin on a finger of the subject. A pressure cuff was provided as the vasostimulant, and vasostimulant activation at time **1804** and deactivation at time **1808** was provided by inflating and deflating the pressure cuff. The subject exhibited a baseline temperature **1802** of approximately 31.2 degrees C., a temperature at time **1808** of approximately 30.6 degrees C., a peak temperature **1812** of approximately 31.4 degrees C., and a rebound temperature change TR of approximately 0.2 degree C. The subject showed presumably good endothelial function due to, for example, the positive value of rebound temperature change TR.

[0239] Referring now to FIG. **24**, in an exemplary experimental embodiment EXP3, the method **500** was carried out on a subject, and a graph EXP3A was obtained of data EXP3AA relating to temperature changes of the skin on a finger of the subject and including data EXP3AB relating to the temperature of a contralateral finger for use as a control. A pressure cuff was provided as the vasostimulant, and vasostimulant activation at time **1804** and deactivation at time **1808** was provided by inflating and deflating the pressure cuff. Data EXP3AA exhibited a baseline temperature **1802** of approximately 34.5 degrees C., a temperature at time **1808** of approximately 33 degrees C., a peak temperature **1812** of approximately 34 degrees C., and a rebound temperature change TR of approximately negative 0.5 degrees C. Data EXP3AB exhibited a control temperature of approximately 35 degrees C. The subject showed presumably bad endothelial function due to, for example, the negative value of rebound temperature change TR.

[0240] Referring now to FIG. **25**, in an exemplary experimental embodiment EXP4, the method **500** was carried out on a subject, and a graph EXP4A was obtained of data EXP4AA relating to temperature changes of the skin on a finger of the subject and including data EXP4AB relating to the temperature of a contralateral finger for use as a control. A pressure cuff was provided as the vasostimulant, and vasostimulant activation at time **1804** and deactivation at time **1808** was provided by inflating and deflating the pressure cuff. Data EXP4AA exhibited a baseline temperature **1802** of approximately 30.5 degrees C., a temperature at time **1808** of approximately 29.5 degrees C., a peak temperature **1812** of approximately 31.2 degrees C., and a rebound temperature change TR of approximately 0.7 degrees C. Data EXP4AB exhibited a control temperature of



approximately 29.5 degrees C. The subject showed presumably good endothelial function due to, for example, the positive value of rebound temperature change TR.

[0241] Referring now to FIG. 26, in an exemplary experimental embodiment EXP5, the method 500 was carried out on a subject, and a graph EXP5A was obtained of data EXP5AA relating to temperature changes of the skin on a finger of the subject and including data EXP5AB relating to the temperature of a contralateral finger for use as a control. A pressure cuff was provided as the vasostimulant, and vasostimulant activation at time 1804 and deactivation at time 1808 was provided by inflating and deflating the pressure cuff. Data EXP5AA exhibited a baseline temperature 1802 of approximately 34 degrees C., a temperature at time 1808 of approximately 31.5 degrees C., a peak temperature 1812 of approximately 33.5 degrees C., and a rebound temperature change TR of approximately negative 0.5 degree C. Data EXP5AB exhibited a control temperature of approximately 34.5 degrees C. The subject showed presumably bad endothelial function due to, for example, the negative value of rebound temperature change TR.

[0242] Referring now to FIG. 27, in an exemplary experimental embodiment EXP6, the method 500 was carried out on a subject, and a graph EXP6A was obtained of data EXP6AA relating to temperature changes of the skin on a finger of the subject and including data EXP6AB relating to the temperature of a contralateral finger for use as a control. A pressure cuff was provided as the vasostimulant, and vasostimulant activation at time 1804 and deactivation at time 1808 was provided by inflating and deflating the pressure cuff. Data EXP6AA exhibited a baseline temperature 1802 of approximately 33.4 degrees C., a temperature at time 1808 of approximately 32.8 degrees C., a peak temperature 1812 of approximately 33.8 degrees C., and a rebound temperature change TR of approximately 0.4 degree C. Data EXP6AA exhibited a control temperature of approximately 33.7 degrees C. The subject showed presumably good endothelial function due to, for example, the positive value of rebound temperature change TR.

[0243] Referring now to FIG. 28, in an exemplary experimental embodiment EXP7, the method 500 was carried out on a subject, and a graph EXP7A was obtained of data EXP7AA relating to temperature changes of the skin on a finger of the subject and including data EXP7AB relating to the temperature of a contralateral finger for use as a control. A pressure cuff was provided as the vasostimulant, and vasostimulant activation at time 1804 and deactivation at time 1808 was provided by inflating and deflating the pressure cuff. Data EXP7AA exhibited a baseline temperature 1802 of approximately 33.1 degrees C., a temperature at time 1808 of approximately 32.1 degrees C., a peak temperature 1812 of approximately 33.1 degrees C., and a rebound temperature change TR of approximately 0.0 degree C. Data EXP7AB exhibited a control temperature of approximately 34 degrees C. The subject showed presumably bad endothelial function due, for example, to the 0.0 degree value of rebound temperature change TR.

[0244] Referring now to FIG. 29, in an exemplary experimental embodiment EXP8, the method 500 was carried out on a subject by occluding the brachial artery of the subject and measuring the temperature changes on the skin of the subjects finger before and after occlusion. While carrying

out the method 500, a conventional endothelial function test was conducted which measure the percentage change in brachial artery diameter before and after occlusion of the brachial artery. A correlation graph was created plotting rebound temperature change TR against the percentage change in brachial artery diameter. A correlation factor R of 0.73 was found between rebound temperature change TR and percentage change in brachial artery diameter, indicating that the method 500 can provide a diagnosis equivalent to the more expensive and subjective brachial artery diameter test.

[0245] Referring now to FIG. 30, in an exemplary experimental embodiment EXP9, the method 500 was carried out on a subject by occluding the brachial artery of the subject and measuring the temperature changes on the skin of the subjects finger before and after occlusion. While carrying out the method 500, a conventional endothelial function test was conducted which measure the percentage change in brachial artery diameter before and after occlusion of the brachial artery. A correlation graph was created plotting nadir to peak temperature change TNP against percentage change in brachial artery diameter. A correlation factor R of 0.74 was found between nadir to peak temperature change TNP and percentage change in brachial artery diameter, indicating that the method 500 can provide a diagnosis equivalent to the more expensive and subjective brachial artery diameter test.

[0246] Referring now to FIG. 31, an alternative embodiment of an apparatus for determining one or more health conditions 1900 is substantially identical in design and operation to apparatus 600 described above with reference to FIGS. 9a and 9b, with the provision of a Doppler probe 1902 replacing the thermal energy sensor 104b. The Doppler probe 1902 is coupled to a wristband 1904 which includes a plurality of adhesive members 1904 and 1904b on either end of the wristband 1904. In an exemplary embodiment, the thermal probe 104b, illustrated in FIG. 9a, may be included on the apparatus 1900 and the Doppler probe 1902 may be coupled to the computer system 102 by an additional coupling wire 606.

[0247] Referring now to FIG. 3, 32a, 32b, 32c, 32d, and 32e, in an exemplary embodiment, a method for determining one or more health conditions 2000 using the apparatus 1900 illustrated in FIG. 31 is illustrated which begins with placing the pressure cuff vasostimulant 106 on arm 12 of subject 10 at step 2002. Pressure cuff vasostimulant 106 may be secured to arm 12 by vasostimulant coupling member 608 which may include a variety of adhesive materials known in the art. The wristband 1904 including Doppler probe 1902 is placed on a distal portion of the forearm 14 and may be secured to the forearm 14 using adhesive members 1904a and 1904b. The Doppler probe 1902 is positioned such that it is immediately adjacent an artery in forearm 14, as illustrated in FIG. 32c.

[0248] At step 2004, thermal energy sensor 104a may be placed on finger 16 of the subject 10. Finger 16 is placed in passageway 104ad of thermal energy sensor 104a such that a distal end of the finger 16 is coupled to thermal energy measurement device 104ae. With finger 16 coupled to thermal energy measurement device 104ae, coupling member 104af secures finger 16 in thermal energy sensor 104a.

[0249] At step 2006, a thermal energy sensor engine such as, for example, the thermal energy sensor engine 102b



illustrated in FIG. 3, activates the thermal energy sensor **104a** to begin recording the skin temperature of finger **16**. In an exemplary embodiment, temperature data begins being recorded continuously. In an exemplary embodiment, the thermal energy sensor **104a** engages the skin of finger **16** in order to measure temperature. In an exemplary embodiment, the thermal energy sensor **104a** measures the skin temperature of finger **16** without engaging the skin of finger **16**.

[0250] At step **2008**, the thermal energy sensor engine **102b** begins to detect for equilibrium in the skin temperature of the finger **16** of subject **10**. In an exemplary embodiment, at step **2008**, the thermal energy sensor engine **102b** retrieves successive temperature measurement from the thermal energy sensor **104a**.

[0251] At decision block **2010**, the thermal energy sensor engine **102b** determines whether the skin temperature of finger **16** of subject **10** has reached equilibrium. If the skin temperature of finger **16** has not reached equilibrium, the temperature sensor engine **102b** proceeds back to step **2008** to detect for equilibrium. In an exemplary embodiment, determining whether the skin temperature of the finger has reached equilibrium in step **2010** may include, for example, determining whether the temperature changes of the finger **16** are less than 0.1 degree C.

[0252] If the temperature changes in the finger **16** have reached equilibrium, the method proceeds to step **2012** where a vasostimulant engine such as, for example, the vasostimulant engine **102c** illustrated in FIG. 2, activates the pressure cuff vasostimulant **106**. In an exemplary embodiment, activating the pressure cuff vasostimulant **106** at step **2012** may include, for example, inflating the cuff to 200 mm Hg systolic BP. The Doppler probe **1902** measures the speed of the blood in an artery in the forearm **14**, and, in an exemplary embodiment, the readings from the Doppler probe **1902** may be used to determine when the appropriate pressure is being applied by the pressure cuff vasostimulant **106** by determining when blood flow has substantially ceased flowing in the artery in forearm **14**. In an experimental embodiment **2012a**, illustrated in FIG. 32d, the Doppler probe **1902** showed that blood substantially ceased flowing through the artery in forearm **14** at data point **2012b**. In an exemplary embodiment, the Doppler probe **1902** can aid in ensuring that the pressure applied by the pressure cuff vasostimulant **106** is no more than is necessary to conduct the method **2000**, and prevents the method **2000** from being interrupted due to pain in the subject.

[0253] At step **2014**, the vasostimulant engine **102c** may deactivate the pressure cuff vasostimulant **106**. In an exemplary embodiment, deactivating the pressure cuff vasostimulant **106** at step **2014** may include deflating the cuff. In an exemplary embodiment, the pressure cuff vasostimulant **106** is deactivated anywhere from 2 to 5 minutes after activation in step **2012**. In an exemplary embodiment, the vasostimulant is deactivated less than 5 minutes after activation in step **2012**, which is less than the conventional deactivation time for tests involving vasostimulation and provides a method which reduces the pain sometimes associated with vasostimulants. In an exemplary embodiment, the vasostimulant is deactivated less than 4 minutes after activation in step **2012**, which is less than the conventional deactivation time for tests involving vasostimulation and provides a method which reduces the pain sometimes associated with vasos-

timulants. In an exemplary embodiment, the vasostimulant is deactivated less than 3 minutes after activation in step **2012**, which is less than the conventional deactivation time for tests involving vasostimulation and provides a method which reduces the pain sometimes associated with vasostimulants. In an exemplary embodiment, the vasostimulant is deactivated approximately 2 minutes after activation in step **2012**, which is less than the conventional deactivation time for tests involving vasostimulation and provides a method which reduces the pain sometimes associated with vasostimulants. In an exemplary embodiment, the subject may be asked to exercise the body part on which thermal energy is being detected, which allows the method **2000** to simulate a longer vasostimulation in a shorter amount of time, which can also reduce the pain sometimes associated with vasostimulants. In an experimental embodiment **2012a**, illustrated in FIG. 32d, the Doppler probe **1902** showed that blood substantially increased in flow rate through the artery in forearm **14** at data point **2012c**.

[0254] At step **2016**, the thermal energy sensor engine **102b** begins to detect for equilibrium in the skin temperature of the finger **16** of subject **10**. In an exemplary embodiment, at step **2016**, the thermal energy sensor engine **102b** retrieves successive temperature measurement from the thermal energy sensor **104a**.

[0255] At decision block **2018**, the thermal energy sensor engine **102b** determines whether the skin temperature of the finger **16** of subject **10** has reached equilibrium. If the skin temperature of the finger **16** has not reached equilibrium, the temperature sensor engine **102b** proceeds back to step **2016** to detect for equilibrium. In an exemplary embodiment, determining whether the skin temperature of the finger **16** has reached equilibrium in step **2018** may include, for example, determining whether the temperature changes of the finger **16** are less than 0.1 degree C.

[0256] If the temperature changes in the finger **16** have reached equilibrium, the method proceeds to step **2020** where the temperature sensor engine **102b** stops recording the skin temperature of the finger **16** of subject **10**.

[0257] At step **2022**, data acquired from measuring and recording temperature changes of finger **16** which began at step **2006** and continued throughout the method **2000** is saved by the temperature sensor engine **102b** to a database such as, for example, the database **102a** illustrated in FIG. 3.

[0258] At step **2024**, a plotting engine such as, for example, the plotting engine **102d** illustrated in FIG. 3, may retrieve data from the database **102a**.

[0259] At step **2026**, the plotting engine **102d** may plot out the data retrieved. In an exemplary embodiment, the data may be plotted out as temperature vs. time. In an exemplary embodiment, the plotting engine **102d** may plot out data obtained from the temperature measurements concurrent with the data being obtained.

[0260] Referring now to FIGS. 3, 9a, 33a, 33b, and 33c, an alternative embodiment of an apparatus for determining one or more health conditions **2100** is substantially identical in design and operation to apparatus **600** described above with reference to FIGS. 9a, 9b, 10a, 10b, 10c, and 10d, with the addition of a thermal energy sensor **2102** replacing the thermal energy sensors **104a** and **104b**. Thermal energy



sensor **2102** is mounted to a lead **2104** which electrically couples the thermal energy sensor **2102** to the computer system **102**. A circular adhesive **2106** defines a circular channel **2106a** centrally located on the circular adhesive **2106** and is positioned adjacent the thermal heat sensor **2102** such that the thermal heat sensor **2102** is located in the circular channel **2106a** on the circular adhesive **2106**. In operation, the finger **16** of subject **10** is coupled to the apparatus **2100** by engaging the finger **16** with the circular adhesive **2106**. With the finger **16** engaging the circular adhesive **2106**, there is contact between the skin surface of the finger **16** and the thermal energy sensor **2102**, which allows the skin temperature of the finger **16** to be measured and recorded. In an embodiment, the circular adhesive **2106** is positioned adjacent the thermal heat sensor **2102** such that with the finger **16** engaging the thermal energy sensor **2102**, a minimum pressure is applied across the finger **16** in order to not substantially change the skin surface temperature of the finger **16**. In an exemplary embodiment, a minimum pressure is a pressure which is sufficient to couple the thermal heat sensor **2102** to the skin surface of the finger **16** in order to obtain accurate temperature measurements without impeding underlying microcapillary circulation. In an embodiment, the circular adhesive **2106** is designed such that with the finger **16** engaging the thermal energy sensor **2102**, a minimum surface area of the finger **16** is covered in order to not substantially change the skin surface temperature of the finger **16**. In an exemplary embodiment, a minimum surface area is a surface area which is sufficient to couple the thermal heat sensor **2102** to the skin surface of the finger **16** in order to obtain accurate temperature measurements without impeding the exchange of heat flow between the ambient and the skin surface.

[0261] Referring now to FIGS. **3**, **9a**, **34a**, **34b**, and **34c**, an alternative embodiment of an apparatus for determining one or more health conditions **2200** is substantially identical in design and operation to apparatus **600** described above with reference to FIGS. **9a**, **9b**, **10a**, **10b**, **10c**, and **10d**, with the addition of a thermal energy sensor **2202** replacing the thermal energy sensors **104a** and **104b**. Thermal energy sensor **2202** is mounted to a lead **2204** which electrically couples the thermal energy sensor **2202** to the computer system **102**. FIG. **50** depicts an embodiment of wiring for receiving signals from thermocouple leads and sending them through an analog to digital converter.

[0262] A plurality of spaced apart rectangular adhesive members **2206a** and **2206b** are positioned adjacent the thermal heat sensor **2202** and on opposite sides of the thermal energy sensor **2202** such that a plurality of airflow channels **2208a** and **2208b** are located on opposite sides of the thermal energy sensor **2202**. In operation, the finger **16** of subject **10** is coupled to the apparatus **2200** by engaging the finger **16** with the plurality of rectangular adhesive members **2206a** and **2206b**. With the finger **16** engaging the rectangular adhesive members **2206a** and **2206b**, there is contact between the skin surface of the finger **16** and the thermal energy sensor **2202** while allowing air to flow through the airflow channels **2208a** and **2208b** on either side of the thermal energy sensor **2202**, which allows the skin temperature of the finger **16** to be measured and recorded while allowing air circulation past the finger **16** such that the apparatus **2200** does not substantially change the skin temperature of the finger **16**. In an embodiment, the rectangular adhesive members **2206a** and **2206b** are positioned adjacent

the thermal heat sensor **2202** such that with the finger **16** engaging the thermal energy sensor **2202**, a minimum pressure is applied across the finger **16** in order to not substantially change the skin surface temperature of the finger **16**. In an exemplary embodiment, a minimum pressure is a pressure which is sufficient to couple the thermal heat sensor **2202** to the skin surface of the finger **16** in order to obtain accurate temperature measurements without impeding underlying microcapillary circulation. In an embodiment, the rectangular adhesive members **2206a** and **2206b** are designed such that with the finger **16** engaging the thermal energy sensor **2202**, a minimum surface area of the finger **16** is covered in order to not substantially change the skin surface temperature of the finger **16**. In an exemplary embodiment, a minimum surface area is a surface area which is sufficient to couple the thermal heat sensor **2202** to the skin surface of the finger **16** in order to obtain accurate temperature measurements without impeding the exchange of heat flow between the ambient and the skin surface.

[0263] Referring now to FIG. **6a** and **35**, an alternative embodiment of an apparatus for determining one or more health conditions **2300** is substantially identical in design and operation to apparatus **600** described above with reference to FIGS. **9a**, **9b**, **10a**, **10b**, **10c**, and **10d**, with the addition of a room temperature measurement device **2302** which is coupled to the computer system **102** by a coupling wire **606** and a core temperature measurement device **2304** which is coupled to the computer system **102** by a coupling wire **606**. In operation, the room temperature measurement device **2302** may be a conventional room temperature measurement device **2302** known in the art and is used to measure the ambient temperature in a room where the apparatus **2300** is being used. The core temperature measurement device **2304** may be a conventional core temperature measurement device **2304** such as, for example, a conventional thermometer, and is used to measure the core temperature of the subject by, for example, placing the thermometer in the mouth, under the arm, and/or in the rectum of the subject **10**.

[0264] Referring now to FIGS. **3**, **9a**, **36a**, and **36b**, an alternative embodiment of an apparatus for determining one or more health conditions **2400** is substantially identical in design and operation to apparatus **2200** described above with reference to FIGS. **3**, **9a**, **34a**, **34b**, and **34c**, with the addition of a thermal device **2402**. Thermal device **2402** is operable to heat up or cool down using conventional heating and cooling elements known in the art.

[0265] Referring now to FIG. **37a**, **37b**, and **37c**, in an exemplary embodiment, a method for determining one or more health conditions **2500** is illustrated which begins with a subject preparation at step **2502**. Subject preparation at step **2502** may include, for example, having a subject refrain from eating before carrying out the method **2500**, having the subject refrain from smoking, ingesting alcohol or caffeine, or taking any vascular medications before carrying out the method **2500**.

[0266] At step **2504**, a thermal energy sensor such as, for example, the thermal energy sensor **2202** on apparatus **200**, illustrated in FIG. **36a** and **36b**, may be placed on the subject. The finger **16** is coupled to the apparatus **2200** by engaging the finger **16** with the plurality of rectangular adhesive members **2206a** and **2206b**. With the finger **16**



engaging the rectangular adhesive members **2206a** and **2206b**, there is contact between the skin surface of the finger **16** and the thermal energy sensor **2202** while allowing air to flow through the airflow channels **2208a** and **2208b** on either side of the thermal energy sensor **2202**, which allows the skin temperature of the finger **16** to be measured and recorded while allowing air circulation past the finger **16** such that the apparatus **2200** does not substantially change the skin temperature of the finger **16**. With the finger **16** engaging the rectangular adhesive members **2206a** and **2206b**, there is also contact between the thermal device **2402** and the finger **16**, as illustrated in FIG. **37c**. In an embodiment, the rectangular adhesive members **2206a** and **2206b** are positioned adjacent the thermal heat sensor **2202** such that with the finger **16** engaging the thermal energy sensor **2202**, a minimum pressure is applied across the finger **16** in order to not substantially change the skin surface temperature of the finger **16**. In an exemplary embodiment, a minimum pressure is a pressure which is sufficient to couple the thermal heat sensor **2202** to the skin surface of the finger **16** in order to obtain accurate temperature measurements without impeding underlying microcapillary circulation. In an embodiment, the rectangular adhesive members **2206a** and **2206b** are designed such that with the finger **16** engaging the thermal energy sensor **2202**, a minimum surface area of the finger **16** is covered in order to not substantially change the skin surface temperature of the finger **16**. In an exemplary embodiment, a minimum surface area is a surface area which is sufficient to couple the thermal heat sensor **2202** to the skin surface of the finger **16** in order to obtain accurate temperature measurements without impeding the exchange of heat flow between the ambient and the skin surface.

[0267] At step **2506**, a thermal energy sensor engine such as, for example, the thermal energy sensor engine **102b** illustrated in FIG. **3**, activates a thermal energy sensor **2402** to begin recording the temperature of the subject. In an exemplary embodiment, temperature data begins being recorded continuously. In an exemplary embodiment, the thermal energy sensor **102b** measures the skin temperature of the subject's body on which it is placed such as, for example, the hand, forearm, foot, leg, earlobe, rectum, or nose.

[0268] At step **2508**, the thermal energy sensor engine **102b** activates the thermal device **2402** in order to adjust the skin surface temperature on the finger. The thermal device **2402** may be activated to either heat or cool the skin surface of the finger in order to adjust the skin surface temperature of the finger **16**. In an exemplary embodiment, at step **2508**, the thermal energy sensor engine **102b** retrieves successive temperature measurements from the thermal energy sensor **2202** to adjust the skin surface temperature of the finger **16**.

[0269] At decision block **2510**, the thermal energy sensor engine **102b** determines whether the desired skin surface temperature of the finger **16** has been reached. If the desired temperature has not been reached, the temperature sensor engine **102b** proceeds back to step **2508** to adjust the skin temperature. In an exemplary embodiment, determining whether the desired temperature of the subject has been reached in step **2510** may include, for example, determining whether the temperature changes of a subject are less than 0.1 degree C.

[0270] If the desired temperature in the subject has been reached, the method proceeds to step **2512** where a vasostimulant engine such as, for example, the vasostimulant engine **102c** illustrated in FIG. **3**, activates a vasostimulant such as, for example, the vasostimulant **106** illustrated in FIG. **3**. In an exemplary embodiment, the vasostimulant **106** may be an inflatable cuff, and activating the vasostimulant **106** at step **2512** may include, for example inflating the cuff to 200 mm Hg systolic BP. In an exemplary embodiment, the vasostimulant **106** may be a chemical such as, for example, nitroglycerin, and activating the vasostimulant **106** at step **2512** may include administering a predetermined amount of the chemical to the subject. In an exemplary embodiment, the vasostimulant **106** may be an aptitude test, and activating the vasostimulant **106** at step **2512** may include having the subject begin the aptitude test.

[0271] At step **2514**, the vasostimulant engine **102c** may deactivate the vasostimulant **106**. In an exemplary embodiment, the vasostimulant **106** may be an inflatable cuff, and deactivating the vasostimulant **106** at step **2514** may include deflating the cuff. In an exemplary embodiment, the vasostimulant **106** may be a chemical such as, for example, nitroglycerin, and deactivating the vasostimulant **106** at step **2514** may include providing an amount of the chemical in step **2512** such that the effects of the chemical on the subject wear off in a predetermined amount of time. In an exemplary embodiment, deactivating the vasostimulant **106** at step **2514** may include providing additional chemicals to the subject to reverse the effects of the vasostimulant chemicals provided in step **2512**. In an exemplary embodiment, the vasostimulant **106** may be an aptitude test, and deactivating the vasostimulant **106** at step **2514** may include having the subject cease taking the aptitude test. In an exemplary embodiment, the vasostimulant is deactivated anywhere from 2 to 5 minutes after activation in step **2512**. In an exemplary embodiment, the vasostimulant is deactivated less than 5 minutes after activation in step **2512**, which is less than the conventional deactivation time for tests involving vasostimulation and provides a method which reduces the pain sometimes associated with vasostimulants. In an exemplary embodiment, the vasostimulant is deactivated less than 4 minutes after activation in step **2512**, which is less than the conventional deactivation time for tests involving vasostimulation and provides a method which reduces the pain sometimes associated with vasostimulants. In an exemplary embodiment, the vasostimulant is deactivated less than 3 minutes after activation in step **2512**, which is less than the conventional deactivation time for tests involving vasostimulation and provides a method which reduces the pain sometimes associated with vasostimulants. In an exemplary embodiment, the vasostimulant is deactivated approximately 2 minutes after activation in step **2512**, which is less than the conventional deactivation time for tests involving vasostimulation and provides a method which reduces the pain sometimes associated with vasostimulants. In an exemplary embodiment, the subject may be asked to exercise the body part on which thermal energy is being detected, which allows the method **2500** to simulate a longer vasostimulation in a shorter amount of time, which can also reduce the pain sometimes associated with vasostimulants.

[0272] At step **2516**, the thermal energy sensor engine **102b** begins to detect for equilibrium in the temperature of subject. In an exemplary embodiment, at step **2516**, the



thermal energy sensor engine **102b** retrieves successive temperature measurement from the thermal energy sensor.

[0273] At decision block **2518**, the thermal energy sensor engine **102b** determines whether the temperature of the subject has reached equilibrium. If the temperature of the subject has not reached equilibrium, the temperature sensor engine proceeds back to step **2516** to detect for equilibrium. In an exemplary embodiment, determining whether the temperature of the subject has reached equilibrium in step **2518** may include, for example, determining whether the temperature changes of a subject are less than 0.1 degree C.

[0274] If the temperature changes in the subject have reached equilibrium, the method proceeds to step **2520** where the temperature sensor engine **102b** stops recording the temperature of the subject.

[0275] At step **2522**, data acquired from measuring and recording temperature changes which began at step **2506** and continued throughout the method **2500** is saved by the temperature sensor engine **102b** to a database such as, for example, the database **102a** illustrated in FIG. 3.

[0276] At step **2524**, a plotting engine such as, for example, the plotting engine **102d** illustrated in FIG. 2, may retrieve data from the database **102a**.

[0277] At step **2526**, the plotting engine **102d** may plot out the data retrieved. In an exemplary embodiment, the data may be plotted out as temperature vs. time. In an exemplary embodiment, the plotting engine **102d** may plot out data obtained from the temperature measurements concurrent with the data being obtained. In an exemplary embodiment, the plotting engine **102d** may retrieve data taken from multiple positions on subject and plot out an average of that data over time. In an exemplary embodiment, the plotting engine **102d** may retrieve data taken from subject at different times and plot out an average of that data.

[0278] Referring now to FIG. **38a** and **38b**, in an exemplary embodiment, a method for determining one or more health conditions **2600** is illustrated which begins with a subject preparation at step **2602**. Subject preparation at step **2602** may include, for example, having a subject refrain from eating before carrying out the method **2600**, having the subject refrain from smoking before carrying out the method **2600**, having the subject refrain from ingesting alcohol or caffeine before carrying out the method **2600**, or having the subject refrain from taking any vascular medications before carrying out the method **2600**.

[0279] At step **2604**, a thermal energy sensor such as, for example, the thermal energy sensor **104a** on apparatus **600**, illustrated in FIG. **9a** and **9b**, may be placed on the finger **16** of subject and the thermal energy sensor **104b** may be placed on the contralateral finger **18** of subject.

[0280] At step **2606**, a thermal energy sensor engine such as, for example, the thermal energy sensor engine **102b** illustrated in FIG. 3, activates the thermal energy sensors **104a** and **104b** to begin recording the skin temperature of the finger **16** and the contralateral finger **18** of the subject. In an exemplary embodiment, temperature data begins being recorded continuously.

[0281] At step **2608**, the skin surface temperature on the finger **16** of subject is adjusted. The finger **16** of the subject is elevated, as illustrated in FIG. **38c**, such that blood flow

to the finger **16** is decreased and the temperature of the skin surface of the finger **16** decreases. In an experimental embodiment **2608a**, illustrated in FIG. **38d**, the subject did not elevate the finger **16** or the contralateral finger **18** and the finger temperature **2608aa** and the contralateral finger temperature **2608ab** both began the method **2600** at approximately 34.4 to 34.7 degrees Celsius. In an experimental embodiment **2608b**, illustrated in FIG. **38e**, the subject elevated the finger **16** and the finger temperature **2608aa** was allowed to drop such that it began the method **2600** at approximately 33.2 degrees Celsius while the contralateral finger temperature **2608ab** began the method **2600** at approximately 35 degrees Celsius. The experimental embodiments **2608a** and **2608b** show that the skin temperature of the finger **16** may be adjusted by elevating the finger **16** of the subject.

[0282] At decision block **2610**, the thermal energy sensor engine **102b** determines whether the desired skin surface temperature of the finger **16** of subject has been reached. If the desired temperature of the subject has not been reached, the temperature sensor engine **102b** proceeds back to step **2608** to detect whether the desired temperature has been reached. In an exemplary embodiment, determining whether the desired temperature of the subject has been reached in step **2610** may include, for example, determining whether the temperature changes of a subject are less than 0.1 degree C.

[0283] If the desired temperature in the subject has been reached, the method proceeds to step **2612** where a vasostimulant engine such as, for example, the vasostimulant engine **102c** illustrated in FIG. 2, activates a vasostimulant such as, for example, the vasostimulant **106** illustrated in FIG. 1. In an exemplary embodiment, the vasostimulant **106** may be an inflatable cuff, and activating the vasostimulant **106** at step **2612** may include, for example inflating the cuff to 200 mm Hg systolic BP. In an exemplary embodiment, the vasostimulant **106** may be a chemical such as, for example, nitroglycerin, and activating the vasostimulant **106** at step **2612** may include administering a predetermined amount of the chemical to the subject. In an exemplary embodiment, the vasostimulant **106** may be an aptitude test, and activating the vasostimulant **106** at step **2612** may include having the subject begin the aptitude test.

[0284] At step **2614**, the vasostimulant engine **102c** may deactivate the vasostimulant **106**. In an exemplary embodiment, the vasostimulant **106** may be an inflatable cuff, and deactivating the vasostimulant **106** at step **2614** may include deflating the cuff. In an exemplary embodiment, the vasostimulant **106** may be a chemical such as, for example, nitroglycerin, and deactivating the vasostimulant **106** at step **2614** may include providing an amount of the chemical in step **2612** such that the effects of the chemical on the subject wear off in a predetermined amount of time. In an exemplary embodiment, deactivating the vasostimulant **106** at step **2614** may include providing additional chemicals to the subject to reverse the effects of the vasostimulant chemicals provided in step **2612**. In an exemplary embodiment, the vasostimulant **106** may be an aptitude test, and deactivating the vasostimulant **106** at step **2614** may include having the subject cease taking the aptitude test. In an exemplary embodiment, the vasostimulant is deactivated anywhere from 2 to 5 minutes after activation in step **2612**. In an exemplary embodiment, the vasostimulant is deactivated



less than 5 minutes after activation in step **2612**, which is less than the conventional deactivation time for tests involving vasostimulation and provides a method which reduces the pain sometimes associated with vasostimulants. In an exemplary embodiment, the vasostimulant is deactivated less than 4 minutes after activation in step **2612**, which is less than the conventional deactivation time for tests involving vasostimulation and provides a method which reduces the pain sometimes associated with vasostimulants. In an exemplary embodiment, the vasostimulant is deactivated less than 3 minutes after activation in step **2612**, which is less than the conventional deactivation time for tests involving vasostimulation and provides a method which reduces the pain sometimes associated with vasostimulants. In an exemplary embodiment, the vasostimulant is deactivated approximately 2 minutes after activation in step **2612**, which is less than the conventional deactivation time for tests involving vasostimulation and provides a method which reduces the pain sometimes associated with vasostimulants. In an exemplary embodiment, the subject may be asked to exercise the body part on which thermal energy is being detected, which allows the method **2600** to simulate a longer vasostimulation in a shorter amount of time, which can also reduce the pain sometimes associated with vasostimulants.

[**0285**] At step **2616**, the thermal energy sensor engine **102b** begins to detect for equilibrium in the temperature of subject. In an exemplary embodiment, at step **2616**, the thermal energy sensor engine **102b** retrieves successive temperature measurement from the thermal energy sensor.

[**0286**] At decision block **2618**, the thermal energy sensor engine **102b** determines whether the temperature of the subject has reached equilibrium. If the temperature of the subject has not reached equilibrium, the temperature sensor engine proceeds back to step **2616** to detect for equilibrium. In an exemplary embodiment, determining whether the temperature of the subject has reached equilibrium in step **2618** may include, for example, determining whether the temperature changes of a subject are less than 0.1 degree C.

[**0287**] If the temperature changes in the subject have reached equilibrium, the method proceeds to step **2620** where the temperature sensor engine **102b** stops recording the temperature of the subject.

[**0288**] At step **2622**, data acquired from measuring and recording temperature changes which began at step **2606** and continued throughout the method **2600** is saved by the temperature sensor engine **102b** to a database such as, for example, the database **102a** illustrated in FIG. **3**.

[**0289**] At step **2624**, a plotting engine such as, for example, the plotting engine **102d** illustrated in FIG. **3**, may retrieve data from the database **102a**.

[**0290**] At step **2626**, the plotting engine **102d** may plot out the data retrieved. In an exemplary embodiment, the data may be plotted out as temperature vs. time. In an exemplary embodiment, the plotting engine **102d** may plot out data obtained from the temperature measurements concurrent with the data being obtained. In an exemplary embodiment, the plotting engine **102d** may retrieve data taken from multiple positions on subject and plot out an average of that data over time. In an exemplary embodiment, the plotting engine **102d** may retrieve data taken from subject at different times and plot out an average of that data.

[**0291**] Referring now to FIG. **39**, an embodiment of a method **2700** for selecting a medication for the treatment of a medical condition in a subject is substantially identical in design and operation to method **500** described above with reference to FIGS. **8a** and **8b**, with the addition of administering a medication to one or more subjects at step **2702**, determining whether the medication is effective in treatment of the medical condition of the subject at step **2704**, and, if the medication is effective in treatment of the medical condition of the subject, selecting the medication for use in treating the medical condition in other subjects at step **2706**. The method **2700** begins as step **2702** where medication is administered to one or more subjects at step **2702**. In an exemplary embodiment, the medication may be a drug which is being evaluated or screened to determine its effectiveness in treating a medical condition of the subjects. The method **2700** then proceeds to follow the method **500** where the health condition of the subject is determined as described above with reference to FIGS. **8a** and **8b**. The method then proceeds to step **2704** where it is determined whether the medication is effective in treatment of the medical condition of the subject at step **2704**. The method **2700** then proceeds to step **2706** where, if the medication is effective in treatment of the medical condition of the subject, the medication is selected for use in treating the medical condition in other subjects. In an exemplary embodiment, the method **2700** may be used to evaluate the effectiveness of any treatment given to a subject such as, for example, drugs, surgery, physical therapy, exercise, cancer treatments, non-invasive treatments, invasive treatments, nutritional regimens, and/or combinations of the foregoing.

[**0292**] Referring now to FIG. **40**, an embodiment of a method **2800** for selecting a nutritional program for a subject is substantially identical in design and operation to method **500** described above with reference to FIGS. **8a** and **8b**, with the addition of administering a nutritional program to one or more subjects at step **2802**, determining whether the nutritional program is effective for the subject at step **2804**, and, if the nutritional program is effective for the subject, selecting the nutritional program for other subjects at step **2806**. The method **2800** begins as step **2802** where a nutritional program is administered to one or more subjects at step **2802**. In an exemplary embodiment, the nutritional program may be a variety of diet and/or exercise programs which are being evaluated or screened to determine their effectiveness for subjects for example, to deal with general nutritional concerns or in obesity management. The method **2800** then proceeds to follow the method **500** where the health condition of the subject is determined as described above with reference to FIGS. **8a** and **8b**. The method then proceeds to step **2804** where it is determined whether the nutritional program is effective for the subject at step **2804**. In an exemplary embodiment, the nutritional program may be determined to be effective if the subject achieves a desired physical condition such as, for example, a lower body weight, a lower body fat percentage, a higher muscle mass, or a variety of other physical conditions known in the art. The method then proceeds to step **2806** where, if the nutritional program is effective for the subject, the nutritional program is used for other subjects. In an exemplary embodiment, the method **2800** may be used to evaluate the effectiveness of any treatment given to a subject such as, for example, drugs, surgery, physical therapy, exercise, cancer



treatments, non-invasive treatments, invasive treatments, nutritional regimens, and/or combinations of the foregoing.

[0293] Referring now to FIGS. 41, an alternative embodiment of an apparatus for determining one or more health conditions 2900 is substantially identical in design and operation to apparatus 600 described above with reference to FIGS. 3, 4, 5, 6, 7, 8a, 8b, 9a, and 9b with the addition of a wrist thermal energy sensor 2902 and an additional finger thermal energy sensor 2904. The wrist thermal energy sensor 2902 is coupled to the computer system 102 by a coupling wire 606 and includes a wrist coupler 2902a having an adhesive member 2902b on a distal end of the wrist coupler 2902a which may adhere to the wrist coupler 2902a. The finger thermal energy sensor 2904 is coupled to the computer system 102 by a coupling wire 606 and includes a finger coupler 2904a having an adhesive member 2904b on a distal end of the finger coupler 2904a which may adhere to the finger coupler 2904a.

[0294] Referring now to FIG. 42a, 42b, and 42c, in an exemplary embodiment, a method 3000 for determining one or more health conditions using the apparatus 2900 illustrated in FIG. 41 is illustrated which begins with placing the pressure cuff vasostimulant 106 on arm 12 of subject at step 3002. Pressure cuff vasostimulant 106 may be secured to arm 12 by vasostimulant coupling member 608 which may include a variety of adhesive materials known in the art. In an exemplary embodiment, the subject may be in a seated position during method 3000.

[0295] At step 3004, the thermal energy sensor 104a may be placed on finger 16 of the subject. The thermal energy sensor 104b may be placed on a finger adjacent finger 16 of subject. The finger thermal energy sensor 2904a may be also placed on finger 16 of subject by adhering adhesive member 2904c to finger coupler 2904b, as illustrated in FIG. 42c. The wrist thermal energy sensor 2902a may be placed on the wrist of subject between the forearm 14 and the finger 16 of subject by adhering adhesive member 2902c to wrist coupler 2902b, as illustrated in FIG. 42c.

[0296] At step 3006, a thermal energy sensor engine such as, for example, the thermal energy sensor engine 102b illustrated in FIG. 3, activates the thermal energy sensor 104a to begin recording the skin temperature of the finger 16, the finger adjacent the finger 16, and the wrist between the forearm 14 and the finger 16, of subject. In an exemplary embodiment, temperature data begins being recorded continuously. In an exemplary embodiment, the thermal energy sensor 104a engages the skin of the finger 16 of subject in order to measure temperature. In an exemplary embodiment, the thermal energy sensor 104a measures the skin temperature of the finger 16 of subject without engaging the skin of the finger 16 of subject. In an exemplary embodiment, the ambient temperature is held constant around the thermal energy sensor 104a. In an exemplary embodiment, the fluid flow such as, for example, the airflow, around the thermal energy sensor 104a is kept to a minimum.

[0297] At step 3008, the thermal energy sensor engine 102b begins to detect for equilibrium in the skin temperature of the finger 16, the finger adjacent the finger 16, and the wrist between the forearm 14 and the finger 16, of subject. In an exemplary embodiment, at step 3008, the thermal energy sensor engine 102b retrieves successive temperature measurement from the thermal energy sensor 104a.

[0298] At decision block 3010, the thermal energy sensor engine 102b determines whether the skin temperature of finger 16, the finger adjacent the finger 16, and the wrist between the forearm 14 and the finger 16, of subject 10 has reached equilibrium. If the skin temperature of finger 16, the finger adjacent the finger 16, and the wrist between the forearm 14 and the finger 16, has not reached equilibrium, the temperature sensor engine 102b proceeds back to step 3008 to detect for equilibrium. In an exemplary embodiment, determining whether the skin temperature of the finger 16, the finger adjacent the finger 16, and the wrist between the forearm 14 and the finger 16, has reached equilibrium in step 710 may include, for example, determining whether the temperature changes of the finger 16, the finger adjacent the finger 16, and the wrist between the forearm 14 and the finger 16, are less than 0.1 degree C.

[0299] If the temperature changes in the finger 16, the finger adjacent the finger 16, and the wrist between the forearm 14 and the finger 16, have reached equilibrium, the method proceeds to step 3012 where a vasostimulant engine such as, for example, the vasostimulant engine 102c illustrated in FIG. 3, activates the pressure cuff vasostimulant 106. In an exemplary embodiment, activating the pressure cuff vasostimulant 106 at step 3012 may include, for example, inflating the cuff to 200 mm Hg systolic BP.

[0300] At step 3014, the vasostimulant engine 102c may deactivate the pressure cuff vasostimulant 106. In an exemplary embodiment, deactivating the pressure cuff vasostimulant 106 at step 3014 may include deflating the cuff. In an exemplary embodiment, the pressure cuff vasostimulant 106 is deactivated anywhere from 2 to 5 minutes after activation in step 3012. In an exemplary embodiment, the vasostimulant is deactivated less than 5 minutes after activation in step 3012, which is less than the conventional deactivation time for tests involving vasostimulation and provides a method which reduces the pain sometimes associated with vasostimulants. In an exemplary embodiment, the vasostimulant is deactivated less than 4 minutes after activation in step 3012, which is less than the conventional deactivation time for tests involving vasostimulation and provides a method which reduces the pain sometimes associated with vasostimulants. In an exemplary embodiment, the vasostimulant is deactivated less than 3 minutes after activation in step 3012, which is less than the conventional deactivation time for tests involving vasostimulation and provides a method which reduces the pain sometimes associated with vasostimulants. In an exemplary embodiment, the vasostimulant is deactivated approximately 2 minutes after activation in step 3012, which is less than the conventional deactivation time for tests involving vasostimulation and provides a method which reduces the pain sometimes associated with vasostimulants. In an exemplary embodiment, the subject may be asked to exercise the body part on which thermal energy is being detected, which allows the method 3000 to simulate a longer vasostimulation in a shorter amount of time, which can also reduce the pain sometimes associated with vasostimulants.

[0301] At step 3016, the thermal energy sensor engine 102b begins to detect for equilibrium in the skin temperature of the finger 16, the finger adjacent the finger 16, and the wrist between the forearm 14 and the finger 16, of subject 10. In an exemplary embodiment, at step 3016, the thermal



energy sensor engine **102b** retrieves successive temperature measurement from the thermal energy sensor **104a**.

[0302] At decision block **3018**, the thermal energy sensor engine **102b** determines whether the skin temperature of the finger **16**, the finger adjacent the finger **16**, and the wrist between the forearm **14** and the finger **16**, of subject **10** has reached equilibrium. If the skin temperature of the finger **16**, the finger adjacent the finger **16**, and the wrist between the forearm **14** and the finger **16**, has not reached equilibrium, the temperature sensor engine **102b** proceeds back to step **3016** to detect for equilibrium. In an exemplary embodiment, determining whether the skin temperature of the finger **16**, the finger adjacent the finger **16**, and the wrist between the forearm **14** and the finger **16**, has reached equilibrium in step **3018** may include, for example, determining whether the temperature changes of the finger **16** are less than 0.1 degree C.

[0303] If the temperature changes in the finger **16**, the finger adjacent the finger **16**, and the wrist between the forearm **14** and the finger **16**, have reached equilibrium, the method proceeds to step **3020** where the temperature sensor engine **102b** stops recording the skin temperature of the finger **16**, the finger adjacent the finger **16**, and the wrist between the forearm **14** and the finger **16**, of subject **10**.

[0304] At step **3022**, data acquired from measuring and recording temperature changes of finger **16**, the finger adjacent the finger **16**, and the wrist between the forearm **14** and the finger **16**, which began at step **3006** and continued throughout the method **3000** is saved by the temperature sensor engine **102b** to a database such as, for example, the database **102a** illustrated in FIG. **3**.

[0305] At step **3024**, a plotting engine such as, for example, the plotting engine **102d** illustrated in FIG. **3**, may retrieve data from the database **102a**.

[0306] At step **3026**, the plotting engine **102d** may plot out the data retrieved. In an exemplary embodiment, the data may be plotted out as temperature vs. time. In an exemplary embodiment, the plotting engine **102d** may plot out data obtained from the temperature measurements concurrent with the data being obtained.

[0307] Referring now to FIG. **43a**, **43b**, and **43c**, in a plurality of exemplary experimental embodiments EXP1, EXP2, and EXP3, the method **3000** was carried out on a subject, and a plurality of graphs EXP1A, EXP2A, and EXP3A, were obtained of data relating to temperature changes of the skin on a wrist of the subject. A pressure cuff was provided as the vasostimulant, and vasostimulant activation at time **1804** and deactivation at time **1808** was provided by inflating and deflating the pressure cuff. In graph EXP1A, the temperature in a wrist EXP1AA distal to the pressure cuff and the temperature in a finger EXP1AB which was not distal to the pressure cuff were measured. The temperature in the wrist EXP1AA distal to the pressure cuff dropped as expected between times **1804** and **1808** and a positive TR was measured after time **1808**. In graph EXP2A, the temperature in a wrist EXP2AA distal to the pressure cuff and the temperature in a finger EXP2AB which was not distal to the pressure cuff were measured. The temperature in the wrist EXP2AA distal to the pressure cuff dropped as expected between times **1804** and **1808** and a positive TR was measured after time **1808**. In graph EXP3A, the tem-

perature in a wrist EXP3AA distal to the pressure cuff and the temperature in a finger EXP3AB which was not distal to the pressure cuff were measured. The temperature in the wrist EXP3AA distal to the pressure cuff dropped as expected between times **1804** and **1808** and a positive TR was measured after time **1808**. The experimental embodiments EXP1, EXP2, and EXP3, show that temperature data such as that obtained from the methods **500**, **700**, **800**, **900**, **1000**, **1100**, **1500**, **1600**, **1700**, **2000**, **2500**, or **2600** and/or the apparatus **100**, **600**, **1200**, **1300**, **1400**, **1900**, **2100**, **2200**, **2300**, or **2400** may be obtained which is substantially similar to the temperature data described above with reference to FIGS. **22**, **23**, **24**, **25**, **26**, **27**, and **28**, by obtaining such temperature data from temperature measurements made at the wrist of the subject rather than at the finger of the subject.

[0308] In several exemplary embodiment, the methods **500**, **700**, **800**, **900**, **1000**, **1100**, **1500**, **1600**, **1700**, **2000**, **2500**, **2600**, **2700**, **2800**, and **3000** may be carried out along with a variety of other diagnostic techniques known in the art in order to improve diagnostic ability to assess cardiovascular health condition. For example, magnetic resonance imaging may be carried out on the subject. Intravascular diagnostic tools such as, for example, intravascular ultrasound, may be used on the subject to diagnose cardiovascular health condition of the subject. The blood flow rate in the skin of the subject or the skin perfusion of the subject may be measured using, for example, optical spectroscopy, near infrared spectroscopy, and/or Doppler flowmetry. In an exemplary embodiment, an optical spectroscopy tracer may be administered to subject before using optical spectroscopy on the subject. In an exemplary embodiment, the blood flow rate of the subject may be measured in place of the skin temperature measurements of the subject. The blood pressure of the subject may be measured and recorded using methods such as, for example, Korotkoff sounds or oscillographic methods, measuring the blood pressure at the fingertip, and/or measuring the blood pressure at the wrist. In an exemplary embodiment, the blood pressure of the subject may be taken before the provision of the vasostimulant in methods **500**, **700**, **800**, **900**, **1000**, **1100**, **1500**, **1600**, **1700**, **2000**, **2500**, **2600**, **2700**, **2800**, and **3000**. In an exemplary embodiment, the blood pressure of the subject may be taken after the provision of the vasostimulant in methods **500**, **700**, **800**, **900**, **1000**, **1100**, **1500**, **1600**, **1700**, **2000**, **2500**, **2600**, **2700**, **2800**, and **3000**. In an exemplary embodiment, the blood pressure of the subject may be taken before, after, and during the provision of the vasostimulant in methods **500**, **700**, **800**, **900**, **1000**, **1100**, **1500**, **1600**, **1700**, **2000**, **2500**, **2600**, **2700**, **2800**, and **3000**. Determining the blood pressure of the subject before and after the provision of the vasostimulant such as, for example, a vasodilative stimulant, allows for the determination of a vasodilative index or vasoconstrictive index for the subject. A vasodilative index for a subject results from a blood pressure drop after the provision of the vasodilative stimulant which indicates dilation in the artery after provision of the vasodilative stimulant and is indicative of a healthy response in the subject. A vasoconstrictive index for a subject results from a blood pressure rise and/or lack of change in blood pressure after the provision of the vasodilative stimulant which indicates no dilation in the artery after provision of the vasodilative stimulant and is indicative of an unhealthy response in the subject. In an exemplary embodiment, an ankle-brachial blood pressure index test may be administered to the subject.



A blood marker of endothelial function may be used on the subject along with the methods 500, 700, 800, 900, 1000, 1100, 1500, 1600, 1700, 2000, 2500, 2600, 2700, 2800, and 3000. The stiffness of the artery supplying blood to the finger may be measured and recorded, for example, using arterial pulse waveform analysis during the methods 500, 700, 800, 900, 1000, 1100, 1500, 1600, 1700, 2000, 2500, 2600, 2700, 2800, and 3000. In an exemplary embodiment, stiffness of the artery may be measured and recorded before provision of the vasostimulant in methods 500, 700, 800, 900, 1000, 1100, 1500, 1600, 1700, 2000, 2500, 2600, 2700, 2800, and 3000. In an exemplary embodiment, stiffness of the artery may be measured and recorded after provision of the vaso-stimulant in methods 500, 700, 800, 900, 1000, 1100, 1500, 1600, 1700, 2000, 2500, 2600, 2700, 2800, and 3000. In an exemplary embodiment, stiffness of the artery may be measured and recorded before, during, and after provision of the vasostimulant in methods 500, 700, 800, 900, 1000, 1100, 1500, 1600, 1700, 2000, 2500, 2600, 2700, 2800, and 3000.

[0309] In several exemplary embodiments, after acquiring and/or plotting the temperature data obtained using the methods 500, 700, 800, 900, 1000, 1100, 1500, 1600, 1700, 2000, 2500, 2600, 2700, 2800, and 3000 and/or the apparatus 100, 600, 1200, 1300, 1400, 1900, 2100, 2200, 2300, 2400, or 2900, the status of atherosclerotic cardiovascular disorder in the subject may be determined. It is well known that deficiencies in endothelial function are indicative of atherosclerotic cardiovascular disorder. Use of the methods 500, 700, 800, 900, 1000, 1100, 1500, 1600, 1700, 2000, 2500, 2600, 2700, 2800, and 3000 and/or the apparatus 100, 600, 1200, 1300, 1400, 1900, 2100, 2200, 2300, 2400, or 2900, permits a health care professional to acquire temperature data which may be analyzed to determine endothelial dysfunction. In an exemplary embodiment, determining the status of atherosclerotic cardiovascular disorder includes assessing the risk of atherosclerotic cardiovascular disorder in the subject. In an exemplary embodiment, determining the status of atherosclerotic cardiovascular disorder includes monitoring the subject's response to atherosclerotic cardiovascular disorder therapies. In an exemplary embodiment, determining the status of atherosclerotic cardiovascular disorder includes using conventional methods such as, for example, a coronary calcium score, a Framingham risk score, or a carotid intima-media thickness test, along with methods 500, 700, 800, 900, 1000, 1100, 1500, 1600, 1700, 2000, 2500, 2600, 2700, 2800, and 3000 and/or the apparatus 100, 600, 1200, 1300, 1400, 1900, 2100, 2200, 2300, 2400, or 2900 to assess the risk of atherosclerotic cardiovascular disorder.

[0310] In several exemplary embodiments, after acquiring and/or plotting the temperature data obtained using the methods 500, 700, 800, 900, 1000, 1100, 1500, 1600, 1700, 2000, 2500, 2600, 2700, 2800, and 3000 and/or the apparatus 100, 600, 1200, 1300, 1400, 1900, 2100, 2200, 2300, 2400, or 2900, the status of heart failure in the subject may be determined. It is well known that deficiencies in endothelial function are indicative of heart failure. Use of the methods 500, 700, 800, 900, 1000, 1100, 1500, 1600, 1700, 2000, 2500, 2600, 2700, 2800, and 3000 and/or the apparatus 100, 600, 1200, 1300, 1400, 1900, 2100, 2200, 2300, 2400, or 2900 permits a health care professional to acquire temperature data which may be analyzed to determine endothelial dysfunction. In an exemplary embodiment, determining the status of heart failure includes monitoring

the progression of heart failure in the subject. In an exemplary embodiment, determining the status of heart failure includes monitoring the subject's response to heart failure therapies. In an exemplary embodiment, determining the status of heart failure includes using conventional methods such as, for example, a cardiac function test, along with methods 500, 700, 800, 900, 1000, 1100, 1500, 1600, 1700, 2000, 2500, 2600, 2700, 2800, and 3000 and/or the apparatus 100, 600, 1200, 1300, 1400, 1900, 2100, 2200, 2300, 2400, or 2900 to monitor the progression of heart failure in the subject.

[0311] In several exemplary embodiments, after acquiring and/or plotting the temperature data obtained using the methods 500, 700, 800, 900, 1000, 1100, 1500, 1600, 1700, 2000, 2500, 2600, 2700, 2800, and 3000 and/or the apparatus 100, 600, 1200, 1300, 1400, 1900, 2100, 2200, 2300, 2400, or 2900, the status of obesity in the subject may be determined. It is well known that deficiencies in endothelial function are indicative of obesity. Use of the above methods and/or apparatus permits a health care professional to acquire temperature data which may be analyzed to determine endothelial dysfunction. In an exemplary embodiment, determining the status of obesity includes managing the subject's obesity by determining the likelihood of the subject regaining lost weight. In an exemplary embodiment, determining the status of obesity includes using conventional methods along with the methods and/or the apparatus of the present invention to monitor the progression of obesity in the subject.

[0312] In several exemplary embodiments, after acquiring and/or plotting the temperature data obtained using the methods 500, 700, 800, 900, 1000, 1100, 1500, 1600, 1700, 2000, 2500, 2600, 2700, 2800, and 3000 and/or the apparatus 100, 600, 1200, 1300, 1400, 1900, 2100, 2200, 2300, 2400, or 2900, the status of high sympathetic reactivity in the subject may be determined. It is well known that deficiencies in endothelial function are indicative of high sympathetic reactivity. Use of these methods and/or apparatus permits a health care professional to acquire temperature data which may be analyzed to determine endothelial dysfunction. In an exemplary embodiment, determining the status of high sympathetic reactivity includes identifying whether the subject has high sympathetic reactivity. In an exemplary embodiment, determining the status of high sympathetic reactivity includes monitoring the subject's response to hypersympathetic therapies. In an exemplary embodiment, determining the status of heart failure includes using conventional methods along with methods and/or the apparatus of the present invention to identify whether the subject has high sympathetic reactivity.

[0313] In several exemplary embodiments, after acquiring and/or plotting the temperature data obtained using the methods 500, 700, 800, 900, 1000, 1100, 1500, 1600, 1700, 2000, 2500, 2600, 2700, 2800, and 3000 and/or the apparatus 100, 600, 1200, 1300, 1400, 1900, 2100, 2200, 2300, 2400, or 2900, the status of high blood pressure in the subject may be determined. It is well known that deficiencies in endothelial function are indicative of high blood pressure. Use of these methods and/or apparatus permits a health care professional to acquire temperature data which may be analyzed to determine endothelial dysfunction. In an exemplary embodiment, determining the status of high blood pressure includes screening the subject for high blood pres-



sure. In an exemplary embodiment, determining the status of high blood pressure includes monitoring the subject's response to high blood pressure therapies. In an exemplary embodiment, determining the status of high blood pressure includes using conventional methods along with the methods and/or the apparatus of the present invention to screen the subject for high blood pressure. In an exemplary embodiment, determining the status of high blood pressure includes identifying whether the subject is resistant to high blood pressure therapies. In an exemplary embodiment, determining the status of high blood pressure includes screening the subject for white coat hypertension. In an exemplary embodiment, determining the status of high blood pressure includes measuring the blood pressure of a subject and distinguishing between the different stages of hypertensive vascular disease.

[0314] In several exemplary embodiments, after acquiring and/or plotting the temperature data obtained using the methods 500, 700, 800, 900, 1000, 1100, 1500, 1600, 1700, 2000, 2500, 2600, 2700, 2800, and 3000 and/or the apparatus 100, 600, 1200, 1300, 1400, 1900, 2100, 2200, 2300, 2400, or 2900, the status of smooth muscle cell dysfunction in the subject may be determined. It is well known that deficiencies in endothelial function are indicative of smooth muscle cell dysfunction. Use of these methods and/or apparatus permits a health care professional to acquire temperature data which may be analyzed to determine endothelial dysfunction. In an exemplary embodiment, determining the status of smooth muscle cell dysfunction includes screening the subject for smooth muscle cell dysfunction. In an exemplary embodiment, determining the status of smooth muscle cell dysfunction includes monitoring the subject's response to smooth muscle cell dysfunction therapies. In an exemplary embodiment, determining the status of smooth muscle cell dysfunction includes using conventional methods along with methods and/or the apparatus of the present invention to screen the subject for smooth muscle cell dysfunction.

[0315] In several exemplary embodiments, after acquiring and/or plotting the temperature data obtained using the methods 500, 700, 800, 900, 1000, 1100, 1500, 1600, 1700, 2000, 2500, 2600, 2700, 2800, and 3000 and/or the apparatus 100, 600, 1200, 1300, 1400, 1900, 2100, 2200, 2300, 2400, or 2900, the status of diabetes in the subject may be determined. It is well known that deficiencies in endothelial function are indicative of diabetes. Use of these methods and/or apparatus permits a health care professional to acquire temperature data which may be analyzed to determine endothelial dysfunction. In an exemplary embodiment, determining the status of diabetes includes predicting whether the subject will develop diabetes. In an exemplary embodiment, determining the status of diabetes includes monitoring the status and progression of diabetes in the subject. In an exemplary embodiment, determining the status of diabetes includes monitoring the subject's response to diabetes therapies. In an exemplary embodiment, determining the status of diabetes includes using conventional methods such as, for example, a hemoglobin A1C test or measuring the subject's glucose level, along with methods and/or the apparatus of the present invention to monitor the status and progression of diabetes in the subject. In an exemplary embodiment, determining the status of diabetes in the subject includes determining the status of type-2 diabetes in the subject.

[0316] In several exemplary embodiments, after acquiring and/or plotting the temperature data obtained using the methods 500, 700, 800, 900, 1000, 1100, 1500, 1600, 1700, 2000, 2500, 2600, 2700, 2800, and 3000 and/or the apparatus 100, 600, 1200, 1300, 1400, 1900, 2100, 2200, 2300, 2400, or 2900, the status of fitness level in the subject may be determined. It is well known that deficiencies in endothelial function are indicative of fitness level. Use of these methods and/or apparatus permits a health care professional to acquire temperature data which may be analyzed to determine endothelial dysfunction. In an exemplary embodiment, determining the status of fitness level includes identifying the fitness level of the subject. In an exemplary embodiment, determining the status of fitness level includes monitoring the subject's response to fitness program. In an exemplary embodiment, determining the status of smooth muscle cell dysfunction includes using conventional methods along with methods and/or the apparatus of the present invention to identify the fitness level of the subject.

[0317] In several exemplary embodiments, after acquiring and/or plotting the temperature data obtained using the methods 500, 700, 800, 900, 1000, 1100, 1500, 1600, 1700, 2000, 2500, 2600, 2700, 2800, and 3000 and/or the apparatus 100, 600, 1200, 1300, 1400, 1900, 2100, 2200, 2300, 2400, or 2900, the status of rheumatologic and/or connective tissue disorders in the subject may be determined. It is well known that deficiencies in endothelial function are indicative of rheumatologic and/or connective tissue disorders. Use of these methods and/or apparatus permits a health care professional to acquire temperature data which may be analyzed to determine endothelial dysfunction. In an exemplary embodiment, determining the status of rheumatologic and/or connective tissue disorders includes assessing the subject for vascular effects due to rheumatologic and/or connective tissue disorders. In an exemplary embodiment, determining the status of rheumatologic and/or connective tissue disorders includes monitoring the subject's response to rheumatologic and/or connective tissue disorder therapies. In an exemplary embodiment, determining the status of rheumatologic and/or connective tissue disorders includes using conventional methods along with methods and/or the apparatus of the present invention to assess the subject for vascular effects due to rheumatologic and/or connective tissue disorders.

[0318] In several exemplary embodiments, after acquiring and/or plotting the temperature data obtained using the methods 500, 700, 800, 900, 1000, 1100, 1500, 1600, 1700, 2000, 2500, 2600, 2700, 2800, and 3000 and/or the apparatus 100, 600, 1200, 1300, 1400, 1900, 2100, 2200, 2300, 2400, or 2900, the status of pulmonary hypertension in the subject may be determined. It is well known that deficiencies in endothelial function are indicative of pulmonary hypertension. Use of these methods and/or apparatus permits a health care professional to acquire temperature data which may be analyzed to determine endothelial dysfunction. In an exemplary embodiment, determining the status of pulmonary hypertension includes assessing whether the subject is at risk for pulmonary hypertension. In an exemplary embodiment, determining the status of pulmonary hypertension includes monitoring the status and progression of pulmonary hypertension in the subject. In an exemplary embodiment, determining the status of pulmonary hypertension includes monitoring the subject's response to pulmonary hypertension therapies. In an exemplary embodiment,



determining the status of pulmonary hypertension includes using conventional methods along with methods and/or the apparatus of the present invention to monitor the status and progression of pulmonary hypertension in the subject.

[0319] In several exemplary embodiments, after acquiring and/or plotting the temperature data obtained using the methods 500, 700, 800, 900, 1000, 1100, 1500, 1600, 1700, 2000, 2500, 2600, 2700, 2800, and 3000 and/or the apparatus 100, 600, 1200, 1300, 1400, 1900, 2100, 2200, 2300, 2400, or 2900, the status of smoking cessation in the subject may be determined. It is well known that deficiencies in endothelial function are indicative of smoking. Use of these methods and/or apparatus permits a health care professional to acquire temperature data which may be analyzed to determine endothelial dysfunction. In an exemplary embodiment, determining the status of smoking cessation includes assessing whether the subject would respond positively to a smoking cessation program. In an exemplary embodiment, determining the status of smoking cessation includes monitoring the subject's success with a smoking cessation program. In an exemplary embodiment, determining the status of smoking cessation includes using conventional methods along with methods and/or the apparatus of the present invention to assess whether the subject would respond positively to a smoking cessation program.

[0320] In several exemplary embodiments, after acquiring and/or plotting the temperature data obtained using the methods 500, 700, 800, 900, 1000, 1100, 1500, 1600, 1700, 2000, 2500, 2600, 2700, 2800, and 3000 and/or the apparatus 100, 600, 1200, 1300, 1400, 1900, 2100, 2200, 2300, 2400, or 2900, the status of vascular stress in the subject may be determined without subjecting the subject to physical activity. It is well known that deficiencies in endothelial function are indicative of vascular stress. Use of these methods and/or apparatus permits a health care professional to acquire temperature data which may be analyzed to determine endothelial dysfunction. In an exemplary embodiment, determining the status of vascular stress includes monitoring the progression of vascular stress in the subject. In an exemplary embodiment, determining the status of vascular stress includes monitoring the subject's response to vascular stress therapies. In an exemplary embodiment, determining the status of vascular stress includes using conventional methods along with methods and/or the apparatus of the present invention to monitor the progression of vascular stress in the subject.

[0321] In several exemplary embodiments, after acquiring and/or plotting the temperature data obtained using the methods 500, 700, 800, 900, 1000, 1100, 1500, 1600, 1700, 2000, 2500, 2600, 2700, 2800, and 3000 and/or the apparatus 100, 600, 1200, 1300, 1400, 1900, 2100, 2200, 2300, 2400, or 2900, the status of sleep disorders such as, for example, sleep apnea, in the subject may be determined. It is well known that deficiencies in endothelial function are indicative of sleep disorders. Use of these methods and/or apparatus permits a health care professional to acquire temperature data which may be analyzed to determine endothelial dysfunction. In an exemplary embodiment, determining the status of sleep disorders includes monitoring the progression of sleep disorders in the subject. In an exemplary embodiment, determining the status of sleep disorders includes monitoring the subject's response to sleep disorder therapies. In an exemplary embodiment, determin-

ing the status of sleep disorders includes using conventional methods along with methods and/or the apparatus of the present invention to monitor the progression of sleep disorder in the subject.

[0322] In several exemplary embodiments, after acquiring and/or plotting the temperature data obtained using the methods 500, 700, 800, 900, 1000, 1100, 1500, 1600, 1700, 2000, 2500, 2600, 2700, 2800, and 3000 and/or the apparatus 100, 600, 1200, 1300, 1400, 1900, 2100, 2200, 2300, 2400, or 2900, the status of metabolic syndrome in the subject may be determined. It is well known that deficiencies in endothelial function are indicative of metabolic syndrome. Use of these methods and/or apparatus permits a health care professional to acquire temperature data which may be analyzed to determine endothelial dysfunction. In an exemplary embodiment, determining the status of metabolic syndrome includes monitoring the progression of metabolic syndrome in the subject. In an exemplary embodiment, determining the status of metabolic syndrome includes monitoring the subject's response to metabolic syndrome therapies. In an exemplary embodiment, determining the status of metabolic syndrome includes using conventional methods along with methods and/or the apparatus of the present invention to monitor whether the subject is at risk for metabolic syndrome.

[0323] In several exemplary embodiments, after acquiring and/or plotting the temperature data obtained using the methods 500, 700, 800, 900, 1000, 1100, 1500, 1600, 1700, 2000, 2500, 2600, 2700, 2800, and 3000 and/or the apparatus 100, 600, 1200, 1300, 1400, 1900, 2100, 2200, 2300, 2400, or 2900, the status of subclinical hypothyroidism in the subject may be determined. It is well known that deficiencies in endothelial function are indicative of subclinical hypothyroidism. Use of these methods and/or apparatus permits a health care professional to acquire temperature data which may be analyzed to determine endothelial dysfunction. In an exemplary embodiment, determining the status of subclinical hypothyroidism includes detecting subclinical hypothyroidism in the subject. In an exemplary embodiment, determining the status of subclinical hypothyroidism includes monitoring the subject's response to subclinical hypothyroidism therapies. In an exemplary embodiment, determining the status of subclinical hypothyroidism includes using conventional methods along with methods and/or the apparatus of the present invention to detect subclinical hypothyroidism in the subject.

[0324] In several exemplary embodiments, after acquiring and/or plotting the temperature data obtained using the methods 500, 700, 800, 900, 1000, 1100, 1500, 1600, 1700, 2000, 2500, 2600, 2700, 2800, and 3000 and/or the apparatus 100, 600, 1200, 1300, 1400, 1900, 2100, 2200, 2300, 2400, or 2900, the status of vascular dementia and/or Alzheimer's disease in the subject may be determined. It is well known that deficiencies in endothelial function are indicative of vascular dementia and/or Alzheimer's disease. Use of these methods and/or apparatus permits a health care professional to acquire temperature data which may be analyzed to determine endothelial dysfunction. In an exemplary embodiment, determining the status of vascular dementia and/or Alzheimer's disease includes screening for vascular dementia and/or Alzheimer's disease in the subject. In an exemplary embodiment, determining the status of vascular dementia and/or Alzheimer's disease includes



monitoring the subject's response to vascular dementia and/or Alzheimer's disease therapies. In an exemplary embodiment, determining the status of vascular dementia and/or Alzheimer's disease includes using conventional methods along with methods and/or the apparatus of the present invention to screen for vascular dementia and/or Alzheimer's disease in the subject.

[0325] In several exemplary embodiments, after acquiring and/or plotting the temperature data obtained using the methods 500, 700, 800, 900, 1000, 1100, 1500, 1600, 1700, 2000, 2500, 2600, 2700, 2800, and 3000 and/or the apparatus 100, 600, 1200, 1300, 1400, 1900, 2100, 2200, 2300, 2400, or 2900, the status of endothelial function in the subject may be determined. Use of these methods and/or apparatus, permits a health care professional to acquire temperature data which may be analyzed to determine endothelial dysfunction. In an exemplary embodiment, determining the status of endothelial function includes using others tests related to endothelial function such as, for example, an endothelial driven microparticles test, a VCAM1 test, an ICAM1 test, a SELECTIN test, a VWF test, a TF test, and/or a CD54 test, along with methods and/or the apparatus of the present invention to assess endothelial function.

[0326] In several exemplary embodiments, after acquiring and/or plotting the temperature data obtained using the methods 500, 700, 800, 900, 1000, 1100, 1500, 1600, 1700, 2000, 2500, 2600, 2700, 2800, and 3000 and/or the apparatus 100, 600, 1200, 1300, 1400, 1900, 2100, 2200, 2300, 2400, or 2900, the status of autonomic nervous system function in the subject may be determined. It is well known that deficiencies in endothelial function are indicative of autonomic nervous system function. Use of these methods and/or apparatus permits a health care professional to acquire temperature data which may be analyzed to determine endothelial dysfunction. In an exemplary embodiment, determining the status of autonomic nervous system function includes screening for autonomic nervous system function in the subject. In an exemplary embodiment, determining the status of autonomic nervous system function includes using conventional methods along with methods and/or the apparatus of the present invention to screen for autonomic nervous system function in the subject.

[0327] In several exemplary embodiments, after acquiring and/or plotting the temperature data obtained using the methods 500, 700, 800, 900, 1000, 1100, 1500, 1600, 1700, 2000, 2500, 2600, 2700, 2800, and 3000 and/or the apparatus 100, 600, 1200, 1300, 1400, 1900, 2100, 2200, 2300, 2400, or 2900, the status of portal hypertension in the subject may be determined. It is well known that deficiencies in endothelial function are indicative of portal hypertension. Use of these methods and/or apparatus permits a health care professional to acquire temperature data which may be analyzed to determine endothelial dysfunction. In an exemplary embodiment, determining the status of portal hypertension includes determining whether the subject will develop portal hypertension. In an exemplary embodiment, determining the status of portal hypertension includes determining the status and progression of portal hypertension in the subject. In an exemplary embodiment, determining the status of portal hypertension includes determining the response of the subject to portal hypertension disease therapies. In an exemplary embodiment, determining the status of

portal hypertension includes using conventional methods along with methods and/or the apparatus of the present invention to screen for portal hypertension in the subject.

[0328] In several exemplary embodiments, after acquiring and/or plotting the temperature data obtained using the methods 500, 700, 800, 900, 1000, 1100, 1500, 1600, 1700, 2000, 2500, 2600, 2700, 2800, and 3000 and/or the apparatus 100, 600, 1200, 1300, 1400, 1900, 2100, 2200, 2300, 2400, or 2900, the status of cancer in the subject may be determined. It is well known that deficiencies in endothelial function are indicative of cancer. Use of these methods and/or apparatus permits a health care professional to acquire temperature data which may be analyzed to determine endothelial dysfunction. In an exemplary embodiment, determining the status of cancer includes determining whether the subject will develop cancer. In an exemplary embodiment, determining the status of cancer includes determining the status and progression of cancer in the subject. In an exemplary embodiment, determining the status of cancer includes determining the response of the subject to cancer disease therapies. In an exemplary embodiment, determining the status of cancer includes using conventional methods along with methods and/or the apparatus of the present invention to screen for cancer in the subject.

[0329] In several exemplary embodiments, after acquiring and/or plotting the temperature data obtained using the methods 500, 700, 800, 900, 1000, 1100, 1500, 1600, 1700, 2000, 2500, 2600, 2700, 2800, and 3000 and/or the apparatus 100, 600, 1200, 1300, 1400, 1900, 2100, 2200, 2300, 2400, or 2900, the status of renal function in the subject may be determined. It is well known that deficiencies in endothelial function are indicative of renal function. Use of these methods and/or apparatus permits a health care professional to acquire temperature data which may be analyzed to determine endothelial dysfunction. In an exemplary embodiment, determining the status of renal function includes determining whether the subject will develop renal function. In an exemplary embodiment, determining the status of renal function includes determining the status and progression of renal function in the subject. In an exemplary embodiment, determining the status of renal function includes determining the response of the subject to renal function disease therapies. In an exemplary embodiment, determining the status of renal function includes using conventional methods along with methods and/or the apparatus of the present invention to screen for renal function in the subject.

[0330] In several exemplary embodiments, after acquiring and/or plotting the temperature data obtained using the methods 500, 700, 800, 900, 1000, 1100, 1500, 1600, 1700, 2000, 2500, 2600, 2700, 2800, and 3000 and/or the apparatus 100, 600, 1200, 1300, 1400, 1900, 2100, 2200, 2300, 2400, or 2900, the status of hypertension in the subject may be determined. It is well known that deficiencies in endothelial function are indicative of hypertension. Use of these methods and/or apparatus permits a health care professional to acquire temperature data which may be analyzed to determine endothelial dysfunction. In an exemplary embodiment, determining the status of hypertension includes determining whether the subject will develop hypertension. In an exemplary embodiment, determining the status of hypertension includes determining the status and progression of hypertension in the subject. In an exemplary embodiment,



determining the status of hypertension includes determining the response of the subject to hypertension disease therapies. In an exemplary embodiment, determining the status of hypertension includes using conventional methods along with methods and/or the apparatus of the present invention to screen for hypertension in the subject.

[0331] In several exemplary embodiments, after acquiring and/or plotting the temperature data obtained using the methods **500, 700, 800, 900, 1000, 1100, 1500, 1600, 1700, 2000, 2500, 2600, 2700, 2800, and 3000** and/or the apparatus **100, 600, 1200, 1300, 1400, 1900, 2100, 2200, 2300, 2400, or 2900**, the status of cerebral vascular disease in the subject may be determined. It is well known that deficiencies in endothelial function are indicative of cerebral vascular disease. Use of these methods and/or the apparatus permits a health care professional to acquire temperature data which may be analyzed to determine endothelial dysfunction. In an exemplary embodiment, determining the status of cerebral vascular disease includes determining whether the subject will develop cerebral vascular disease. In an exemplary embodiment, determining the status of hypertension includes determining the status and progression of cerebral vascular disease in the subject. In an exemplary embodiment, determining the status of cerebral vascular disease includes determining the response of the subject to stroke therapies. In an exemplary embodiment, determining the status of cerebral vascular disease includes using conventional methods along with methods and/or the apparatus of the present invention to screen for cerebral vascular disease in the subject. In an embodiment, cerebral vascular disease may include, for example, strokes.

[0332] In several exemplary embodiments, after acquiring and/or plotting the temperature data obtained using the methods **500, 700, 800, 900, 1000, 1100, 1500, 1600, 1700, 2000, 2500, 2600, 2700, 2800, and 3000** and/or the apparatus **100, 600, 1200, 1300, 1400, 1900, 2100, 2200, 2300, 2400, or 2900**, the status of dementia and/or memory loss in the subject may be determined. It is well known that deficiencies in endothelial function are indicative of dementia and/or memory loss. Use of these methods and/or the apparatus permits a health care professional to acquire temperature data which may be analyzed to determine endothelial dysfunction. In an exemplary embodiment, determining the status of dementia and/or memory loss includes determining whether the subject will develop dementia and/or memory loss. In an exemplary embodiment, determining the status of dementia includes determining the status and progression of dementia and/or memory loss in the subject. In an exemplary embodiment, determining the status of dementia and/or memory loss includes determining the response of the subject to dementia and/or memory loss disease therapies. In an exemplary embodiment, determining the status of dementia and/or memory loss includes using conventional methods along with methods and/or the apparatus of the present invention to screen for dementia and/or memory loss in the subject.

[0333] In several exemplary embodiments, after acquiring and/or plotting the temperature data obtained using the methods **500, 700, 800, 900, 1000, 1100, 1500, 1600, 1700, 2000, 2500, 2600, 2700, 2800, and 3000** and/or the apparatus **100, 600, 1200, 1300, 1400, 1900, 2100, 2200, 2300, 2400, or 2900**, the status of vision loss in the subject may be determined. It is well known that deficiencies in endothelial

function are indicative of vision loss. Use of these methods and/or the apparatus permits a health care professional to acquire temperature data which may be analyzed to determine endothelial dysfunction. In an exemplary embodiment, determining the status of vision loss includes determining whether the subject will develop vision loss. In an exemplary embodiment, determining the status of vision loss includes determining the status and progression of vision loss in the subject. In an exemplary embodiment, determining the status of vision loss includes determining the response of the subject to vision loss disease therapies. In an exemplary embodiment, determining the status of vision loss includes using conventional methods along with methods and/or the apparatus of the present invention to screen for vision loss in the subject.

[0334] In several exemplary embodiments, after acquiring and/or plotting the temperature data obtained using the methods **500, 700, 800, 900, 1000, 1100, 1500, 1600, 1700, 2000, 2500, 2600, 2700, 2800, and 3000** and/or the apparatus **100, 600, 1200, 1300, 1400, 1900, 2100, 2200, 2300, 2400, or 2900**, the status of heart attack and/or angina in the subject may be determined. It is well known that deficiencies in endothelial function are indicative of heart attack and/or angina. Use of these methods and/or the apparatus permits a health care professional to acquire temperature data which may be analyzed to determine endothelial dysfunction. In an exemplary embodiment, determining the status of heart attack and/or angina includes determining whether the subject will develop heart attacks and/or angina. In an exemplary embodiment, determining the status of heart attack and/or angina includes determining the status and progression of heart attacks and/or angina in the subject. In an exemplary embodiment, determining the status of heart attack and/or angina includes determining the response of the subject to heart attack and/or angina therapies. In an exemplary embodiment, determining the status of heart attack and/or angina includes using conventional methods along with methods and/or the apparatus of the present invention to screen for heart attacks and/or angina in the subject.

[0335] In several exemplary embodiments, after acquiring and/or plotting the temperature data obtained using the methods **500, 700, 800, 900, 1000, 1100, 1500, 1600, 1700, 2000, 2500, 2600, 2700, 2800, and 3000** and/or the apparatus **100, 600, 1200, 1300, 1400, 1900, 2100, 2200, 2300, 2400, or 2900**, the status of erectile dysfunction in the subject may be determined. It is well known that deficiencies in endothelial function are indicative of erectile dysfunction. Use of these methods and/or the apparatus permits a health care professional to acquire temperature data which may be analyzed to determine endothelial dysfunction. In an exemplary embodiment, determining the status of erectile dysfunction includes determining whether the subject will develop erectile dysfunction. In an exemplary embodiment, determining the status of erectile dysfunction includes determining the status and progression of erectile dysfunction in the subject. In an exemplary embodiment, determining the status of erectile dysfunction includes determining the response of the subject to erectile dysfunction therapies. In an exemplary embodiment, determining the status of erectile dysfunction includes using conventional methods along with methods and/or the apparatus of the present invention to screen for erectile dysfunction in the subject.



[0336] In several exemplary embodiments, after acquiring and/or plotting the temperature data obtained using the methods 500, 700, 800, 900, 1000, 1100, 1500, 1600, 1700, 2000, 2500, 2600, 2700, 2800, and 3000 and/or the apparatus 100, 600, 1200, 1300, 1400, 1900, 2100, 2200, 2300, 2400, or 2900, the status of peripheral artery disease in the subject may be determined. It is well known that deficiencies in endothelial function are indicative of peripheral artery disease. Use of these methods and/or the apparatus permits a health care professional to acquire temperature data which may be analyzed to determine endothelial dysfunction. In an exemplary embodiment, determining the status of peripheral artery disease includes determining whether the subject will develop peripheral artery disease. In an exemplary embodiment, determining the status of peripheral artery disease includes determining the status and progression of peripheral artery disease in the subject. In an exemplary embodiment, determining the status of peripheral artery disease includes determining the response of the subject to peripheral artery disease therapies. In an exemplary embodiment, determining the status of peripheral artery disease includes using conventional methods along with methods and/or the apparatus of the present invention to screen for peripheral artery disease in the subject.

[0337] In several exemplary embodiments, after acquiring and/or plotting the temperature data obtained using the methods 500, 700, 800, 900, 1000, 1100, 1500, 1600, 1700, 2000, 2500, 2600, 2700, 2800, and 3000 and/or the apparatus 100, 600, 1200, 1300, 1400, 1900, 2100, 2200, 2300, 2400, or 2900, the status of pregnancy in the subject may be determined. It is well known that deficiencies in endothelial function are indicative of pregnancy. Use of these methods and/or the apparatus permits a health care professional to acquire temperature data which may be analyzed to determine endothelial dysfunction. In an exemplary embodiment, determining the status of pregnancy includes determining the status and progression of pregnancy in the subject. In an exemplary embodiment, determining the status of pregnancy includes determining the status of preeclampsia in the subject. In an exemplary embodiment, determining the status of pregnancy includes using conventional methods along with methods and/or the apparatus of the present invention to screen for pregnancy in the subject.

[0338] In several exemplary embodiments, after acquiring and/or plotting the temperature data obtained using the methods 500, 700, 800, 900, 1000, 1100, 1500, 1600, 1700, 2000, 2500, 2600, 2700, 2800, and 3000 and/or the apparatus 100, 600, 1200, 1300, 1400, 1900, 2100, 2200, 2300, 2400, or 2900, the status of migraine headaches in the subject may be determined. It is well known that deficiencies in endothelial function are indicative of migraine headaches. Use of these methods and/or the apparatus permits a health care professional to acquire temperature data which may be analyzed to determine endothelial dysfunction. In an exemplary embodiment, determining the status of migraine headaches includes determining whether the subject will develop migraine headaches. In an exemplary embodiment, determining the status of migraine headaches includes determining the status and progression of migraine headaches in the subject. In an exemplary embodiment, determining the status of migraine headaches includes determining the response of the subject to migraine headaches therapies. In an exemplary embodiment, determining the status of migraine headaches includes using conventional methods along with meth-

ods and/or the apparatus of the present invention to screen for migraine headaches in the subject. In an exemplary embodiment, a migraine headache may include headaches such as, for example, vascular headaches, migraine variants, and a variety of other headaches known in the art.

[0339] In several exemplary embodiments, after acquiring and/or plotting the temperature data obtained using the methods 500, 700, 800, 900, 1000, 1100, 1500, 1600, 1700, 2000, 2500, 2600, 2700, 2800, and 3000 and/or the apparatus 100, 600, 1200, 1300, 1400, 1900, 2100, 2200, 2300, 2400, or 2900, the status of Prinzmetal's angina in the subject may be determined. It is well known that deficiencies in endothelial function are indicative of Prinzmetal's angina. Use of these methods and/or the apparatus permits a health care professional to acquire temperature data which may be analyzed to determine endothelial dysfunction. In an exemplary embodiment, determining the status of Prinzmetal's angina includes determining whether the subject will develop Prinzmetal's angina. In an exemplary embodiment, determining the status of Prinzmetal's angina includes determining the status and progression of Prinzmetal's angina in the subject. In an exemplary embodiment, determining the status of Prinzmetal's angina includes determining the response of the subject to Prinzmetal's angina therapies. In an exemplary embodiment, determining the status of Prinzmetal's angina includes using conventional methods along with methods and/or the apparatus of the present invention to screen for Prinzmetal's angina in the subject.

[0340] In several exemplary embodiments, after acquiring and/or plotting the temperature data obtained using the methods 500, 700, 800, 900, 1000, 1100, 1500, 1600, 1700, 2000, 2500, 2600, 2700, 2800, and 3000 and/or the apparatus 100, 600, 1200, 1300, 1400, 1900, 2100, 2200, 2300, 2400, or 2900, the status of HIV in the subject may be determined. It is well known that deficiencies in endothelial function are indicative of HIV. Use of these methods and/or the apparatus permits a health care professional to acquire temperature data which may be analyzed to determine endothelial dysfunction. In an exemplary embodiment, determining the status of HIV includes determining whether the subject has contracted HIV. In an exemplary embodiment, determining the status of HIV includes determining the status and progression of HIV in the subject. In an exemplary embodiment, determining the status of HIV includes determining the response of the subject to HIV therapies. In an exemplary embodiment, determining the status of HIV includes using conventional methods along with methods and/or the apparatus of the present invention to screen for HIV in the subject.

[0341] In several exemplary embodiments, after acquiring and/or plotting the temperature data obtained using the methods 500, 700, 800, 900, 1000, 1100, 1500, 1600, 1700, 2000, 2500, 2600, 2700, 2800, and 3000 and/or the apparatus 100, 600, 1200, 1300, 1400, 1900, 2100, 2200, 2300, 2400, or 2900, the status of diabetic foot in the subject may be determined. It is well known that deficiencies in endothelial function are indicative of diabetic foot. Use of these methods and/or the apparatus permits a health care professional to acquire temperature data which may be analyzed to determine endothelial dysfunction. In an exemplary embodiment, determining the status of diabetic foot includes determining whether the subject has diabetic foot. In an exemplary embodiment, determining the status of diabetic foot



includes determining the status and progression of diabetic foot in the subject. In an exemplary embodiment, determining the status of diabetic foot includes determining the response of the subject to diabetic foot therapies. In an exemplary embodiment, determining the status of diabetic foot includes using conventional methods along with methods and/or the apparatus of the present invention to screen for diabetic foot in the subject. In an exemplary embodiment, determining the status of diabetic foot includes measuring the autonomic nervous systemic function in the subject such as, for example, by looking at the changes in temperature in the contralateral finger **18** on subject **10** after provision of the vasostimulant. In an exemplary embodiment, an increase in temperature in the contralateral finger **18** of subject **10** indicates a healthy autonomic nervous system function in the subject.

[0342] In several exemplary embodiments, after acquiring and/or plotting the temperature data obtained using the methods **500, 700, 800, 900, 1000, 1100, 1500, 1600, 1700, 2000, 2500, 2600, 2700, 2800, and 3000** and/or the apparatus **100, 600, 1200, 1300, 1400, 1900, 2100, 2200, 2300, 2400, or 2900**, the effectiveness of cholesterol lowering medications in the subject may be determined. It is well known that deficiencies in endothelial function are indicative of the effectiveness of cholesterol lowering medications. Use of these methods and/or the apparatus permits a health care professional to acquire temperature data which may be analyzed to determine endothelial dysfunction. In an exemplary embodiment, determining the effectiveness of cholesterol lowering medications includes determining the effectiveness of cholesterol lowering medications from the family of statins such as, for example, Lipitor and/or mevalonate.

[0343] In several exemplary embodiments, after acquiring and/or plotting the temperature data obtained using the methods **500, 700, 800, 900, 1000, 1100, 1500, 1600, 1700, 2000, 2500, 2600, 2700, 2800, and 3000** and/or the apparatus **100, 600, 1200, 1300, 1400, 1900, 2100, 2200, 2300, 2400, or 2900**, additional diagnosis techniques such as, for example, determining a coronary calcium score, determining a Framingham risk score, determining a carotid intima media thickness, conducting a c-reactive protein test, determining a Lp-PLA2 level, and/or a variety of other techniques which may be used to provide a comprehensive determination of health condition with the methods of the present invention in order to determine the health condition of the subject.

[0344] In several exemplary embodiments, after acquiring and/or plotting the temperature data obtained using the methods **500, 700, 800, 900, 1000, 1100, 1500, 1600, 1700, 2000, 2500, 2600, 2700, 2800, and 3000** and/or the apparatus **100, 600, 1200, 1300, 1400, 1900, 2100, 2200, 2300, 2400, or 2900**, additional diagnosis techniques such as, for example, change in oxygen saturation in the body part in which temperature is being measured, change in Doppler flow in the body part in which temperature is being measured, change in pressure in the body part in which temperature is being measured, and/or change in blood flow measured by near infrared spectroscopy in the body part in which temperature is being measured, may be used to provide a comprehensive determination of health condition with the methods of the present invention in order to determine the health condition of the subject.

[0345] In several exemplary embodiments, after acquiring and/or plotting the temperature data obtained using the methods **500, 700, 800, 900, 1000, 1100, 1500, 1600, 1700, 2000, 2500, 2600, 2700, 2800, and 3000** and/or the apparatus **100, 600, 1200, 1300, 1400, 1900, 2100, 2200, 2300, 2400, or 2900**, additional risk assessment methods such as, for example, intravascular optical coherent tomography, coronary fractional flow reserve, intravascular ultrasound radiofrequency backscatter analysis or Virtual Histology, urinary albumin, serum fibrinogen, IL6, CD40/CD40L, serum amyloid A, ankle brachial index, MRI, coronary calcium score, carotid intima thickness, Framingham risk score, C-reactive protein tests, waist circumference, blood insulin level, PAI-1 test, t-PA test, glucose tolerance tests, fasting plasma glucose level, HDL cholesterol level, fasting plasma insulin test, homeostasis model assessment, BMI, body fat level, visceral fat test, subcutaneous fat test, white blood cell count, Neutrophil/lymphocyte ratio, platelet function test, combinations thereof, and/or a variety of other cardiovascular risk assessment methods may be used to provide a comprehensive determination of health condition with the methods of the present invention in order to determine the health condition of the subject. In an exemplary embodiment, ankle-brachial index is the blood pressure measured at the ankle level over the blood pressure measured at the arm level. A ratio of 0.9 or less is considered unhealthy and an indication of peripheral artery disease. Using the methods and/or the apparatus of the present invention, temperature measurements at the ankle level and the arm level can be used to create a ration substantially similar to the ankle brachial index. Furthermore, multiple temperature measurements of a subject using the methods and/or the apparatus of the present invention at different body parts on the subject may provide a more comprehensive assessment of health condition.

[0346] In several exemplary embodiments, after acquiring and/or plotting the temperature data obtained using the methods **500, 700, 800, 900, 1000, 1100, 1500, 1600, 1700, 2000, 2500, 2600, 2700, 2800, and 3000** and/or the apparatus **100, 600, 1200, 1300, 1400, 1900, 2100, 2200, 2300, 2400, or 2900**, additional diagnostic methods which include factors or markers related to endothelial function, endothelial activation, or endothelial damage, such as, for example, plasma and urinary level of asymmetrical (ADMA) and symmetrical (SDMA dimethylarginine, exhaled nitric oxide, serum homocysteine, an endothelial driven microparticles test, a VCAM1 test, an ICAM1 test, a SELECTIN test, a VWF test, a TF test, and/or a CD54 test, endothelial progenitor cells, myelo-peroxidase (MPO), increased neutrophil/lymphocyte ratio, endothelin-1, thrombomodulin, tissue factor and tissue factor pathway inhibitor, markers of inflammation such as, for example, granulocyte-macrophage colony-stimulating factor (GM-CSF) and macrophage chemoattractant protein-1 (MCP-1) nitric oxide and its metabolites nitrates and nitrites, almost nitrosylated proteins, a selectin such as, for example, soluble endothelium, leukocyte, and platelet selecting, markers of oxidative stress including but not limited to free radical measurements of the blood or through the skin, TBAR, and/or extra cellular super oxide dismutase activity, vascular stiffness or compliance, combinations thereof, and/or a variety of other endothelial related techniques may be used to provide a comprehensive



determination of health condition with the methods of the present invention in order to determine the health condition of the subject.

[0347] In several exemplary embodiments, after acquiring and/or plotting the temperature data obtained using the methods 500, 700, 800, 900, 1000, 1100, 1500, 1600, 1700, 2000, 2500, 2600, 2700, 2800, and 3000 and/or the apparatus 100, 600, 1200, 1300, 1400, 1900, 2100, 2200, 2300, 2400, or 2900, additional diagnostic methods which measure parameters which change in the subject during these methods along with temperature such as, for example, skin color, nail capilloroscopy, ultrasound brachial artery imaging, forearm plethysmography, fingertip plethysmography, oxygen saturation change, pressure change, near-infrared spectroscopy measurements, Doppler flow change, peripheral arterial tomometry, combinations thereof, and/or a variety of other endothelial related techniques may be used to provide a comprehensive determination of health condition with the methods of the present invention in order to determine the health condition of the subject.

[0348] In several exemplary embodiments, additional diagnosis techniques may be used to acquire a measure of endothelium independent vascular reactivity along with the measure of endothelium dependent vascular reactivity which may be acquired by the methods 500, 700, 800, 900, 1000, 1100, 1500, 1600, 1700, 2000, 2500, 2600, 2700, 2800, and 3000, and a ratio of the endothelium dependent vascular reactivity over the endothelium independent vascular reactivity or a composite index of the endothelium dependent vascular reactivity and the endothelium independent vascular reactivity may be calculated to determine the health condition of the subject. Additional diagnosis techniques may also be used to acquire a measure of parameters which change in the subject during these methods along with temperature along with the measure of endothelium dependent vascular reactivity which may be acquired by the methods, and a ratio of the parameters which change in the subject during the methods along with temperature over the endothelium dependent vascular reactivity or a composite index of the parameters which change in the subject during the methods along with temperature and the endothelium dependent vascular reactivity may be calculated to determine the health condition of the subject. In an exemplary embodiment, a ratio or composite index may include variables determined using the methods 500, 700, 800, 900, 1000, 1100, 1500, 1600, 1700, 2000, 2500, 2600, 2700, 2800, and 3000 on a variety of body parts on the subject. In an exemplary embodiment, a ratio or composite index may include variables determined using these methods and a variety of additional diagnostic methods such as the diagnostic methods described above. In an exemplary embodiment, a composite index is the operation of a plurality of factors using any mathematical operator.

[0349] In several exemplary embodiments, along with acquiring and/or plotting the temperature data obtained using the methods 500, 700, 800, 900, 1000, 1100, 1500, 1600, 1700, 2000, 2500, 2600, 2700, 2800, and 3000 and/or the apparatus 100, 600, 1200, 1300, 1400, 1900, 2100, 2200, 2300, 2400, or 2900, a medication may be administered to the subject for the treatment of a medical condition. These methods and/or the apparatus help to determine whether the medication is effective in the treatment of the medical

condition and, if the medication is determined to be effective, the medication may be selected in treating that medical condition in other subjects.

[0350] In several exemplary embodiments, along with acquiring and/or plotting the temperature data obtained using the methods 500, 700, 800, 900, 1000, 1100, 1500, 1600, 1700, 2000, 2500, 2600, 2700, 2800, and 3000 and/or the apparatus 100, 600, 1200, 1300, 1400, 1900, 2100, 2200, 2300, 2400, or 2900, a nutritional program may be administered to the subject. The methods and/or the apparatus of the present invention help to determine whether the nutritional program is effective for the subject and, if the nutritional program is determined to be effective, the nutritional program may be selected for other subjects.

[0351] In several exemplary embodiments, along with acquiring and/or plotting the temperature data obtained using the methods 500, 700, 800, 900, 1000, 1100, 1500, 1600, 1700, 2000, 2500, 2600, 2700, 2800, and 3000 and/or the apparatus 100, 600, 1200, 1300, 1400, 1900, 2100, 2200, 2300, 2400, or 2900, a chemical agent, medical procedure, or health intervention program may be administered to the subject for the treatment of a medical condition. The methods and/or the apparatus of the present invention help to study the effects of the chemical agent, medical procedure and or health intervention program in treating the subject for the medical condition. In an exemplary embodiment, a health intervention program includes, but is not limited to, a program of smoking cessation, a program of drinking cessation, a dietary program, and/or an exercise program.

[0352] A thermal energy measurement apparatus has been described that includes a thermal energy sensor and means for coupling the thermal energy sensor to a skin surface of a body part, the coupling means operable to couple the thermal energy sensor to the skin surface of the body part while not substantially changing the skin temperature of the body part. In an exemplary embodiment, the means for coupling the thermal energy sensor to the skin surface of the body part comprises a mesh. In an exemplary embodiment, the means for coupling the thermal energy sensor to the skin surface of the body part comprises a non-insulating material. In an exemplary embodiment, the thermal energy sensor is adapted to measure skin temperature. In an exemplary embodiment, the means for coupling the thermal energy sensor to the skin surface of the body part is operable to hold the thermal energy sensor in contact with skin surface on the body part. In an exemplary embodiment, the thermal energy sensor comprises a plurality of thermal energy sensors.

[0353] In an exemplary embodiment, a computer system is coupled to the thermal energy sensor. In an exemplary embodiment, the computer system is coupled to the thermal energy sensor by a wireless connection. In an exemplary embodiment, the wireless connection comprises Bluetooth technology. In an exemplary embodiment, the computer system is chosen from the group consisting of a cellular phone, a PDA, a personal computing device, and combinations thereof.

[0354] In an exemplary embodiment, the computer system is coupled to a therapeutic device, the therapeutic device operable to perform a therapeutic function. In an exemplary embodiment, the therapeutic function includes the release of oxygen. In an exemplary embodiment, the computer system is coupled to an alerting device. In an exemplary embodi-



ment, the alerting device is operable to contact emergency medical services. In an exemplary embodiment, the computer system is coupled to a pulse oximeter. In an exemplary embodiment, the computer system is coupled to a blood pressure monitoring device. In an exemplary embodiment, the computer system is coupled to a Doppler probe. In an exemplary embodiment, the computer system is coupled to a room temperature measurement device. In an exemplary embodiment, the computer system is coupled to a core temperature measurement device.

[0355] In an exemplary embodiment, the means for coupling the thermal energy sensor to the body part comprises a ring. In an exemplary embodiment, the means for coupling the thermal energy sensor to the body part comprises a watch. In an exemplary embodiment, the means for coupling the thermal energy sensor to the body part comprises a bracelet. In an exemplary embodiment, the thermal energy sensor comprises a probe operable to measure thermal energy of the skin surface of the body part without contacting the body part. In an exemplary embodiment, the means for coupling the thermal energy sensor to the body part comprises an article of clothing. In an exemplary embodiment, the means for coupling the thermal energy sensor to the body part comprises an adhesive. In an exemplary embodiment, the means for coupling the thermal energy sensor to the body part is disposable. In an exemplary embodiment, the thermal energy sensor is operable to measure thermal energy over a time period. In an exemplary embodiment, the means for coupling the thermal energy sensor to a skin surface of a body part comprises an adhesive. In an exemplary embodiment, the apparatus further comprises an airflow channel defined by the means for coupling the thermal energy sensor to a skin surface of a body part located between the thermal energy sensor and the adhesive. In an exemplary embodiment, the means for coupling the thermal energy sensor to a skin surface of a body part is operable to apply a minimum pressure across a body part in order to not substantially change the skin surface temperature of the body part. In an exemplary embodiment, the means for coupling the thermal energy sensor to a skin surface of a body part is operable to couple to a minimum surface area of the body part in order to not substantially change the skin surface temperature of the body part.

[0356] In an exemplary embodiment, the apparatus further comprises a second thermal energy sensor and a means for coupling the second thermal energy sensor to a contralateral body part. In an exemplary embodiment, the means for coupling the thermal energy sensor to the skin surface of the body part comprises a glove. In an exemplary embodiment, the means for coupling the thermal energy sensor to the skin surface of the body part does not substantially change a microcapillary blood flow underlying the skin surface. In an exemplary embodiment, the apparatus further comprises a thermal device operable to adjust the skin surface temperature of the body part.

[0357] In an exemplary embodiment, the thermal energy sensor comprises a thermocouple. In an exemplary embodiment, the thermal energy sensor comprises a thermister. In an exemplary embodiment, the thermal energy sensor comprises a resistance temperature detector. In an exemplary embodiment, the thermal energy sensor comprises a heat flux detector. In an exemplary embodiment, the thermal

energy sensor comprises a liquid crystal sensor. In an exemplary embodiment, the thermal energy sensor comprises a thermopile. In an exemplary embodiment, the thermal energy sensor comprises an infrared sensor. In an exemplary embodiment, the infrared sensor measures thermal energy of a point on a surface. In an exemplary embodiment, the infrared sensor measures thermal energy of an area on a surface.

[0358] A method for determining one or more health conditions has been described that includes providing a subject, measuring the skin temperature of a body part on the subject, providing a vasostimulant to the subject, measuring the skin temperature changes of the body part during and subsequent to the provision of the vasostimulant, and determining one or more health conditions for the subject based upon at least one of the skin temperature changes measured. In an exemplary embodiment, the measuring the skin temperature of the body part of the subject comprises coupling a thermal energy measurement apparatus to the body part.

[0359] In an exemplary embodiment, the providing a vasostimulant comprises providing a neuro-vasostimulant. In an exemplary embodiment, the neuro-vasostimulant comprises the subject consuming a glass of ice water. In an exemplary embodiment, the providing a vasostimulant comprises providing a neurostimulant. In an exemplary embodiment, the providing a vasostimulant comprises compressing an artery on the subject for a period of time followed by ceasing the compression. In an exemplary embodiment, the vasostimulant is provided for 5 minutes or less. In an exemplary embodiment, the vasostimulant is provided for 4 minutes or less. In an exemplary embodiment, the vasostimulant is provided for 3 minutes or less. In an exemplary embodiment, the vasostimulant is provided for approximately 2 minutes. In an exemplary embodiment, the method further includes having the subject exercise the body part on which thermal energy is being measured after provision of the vasostimulant.

[0360] In an exemplary embodiment, the skin temperature of the body part is measured on a distal location to the artery. In an exemplary embodiment, the artery comprises a brachial artery. In an exemplary embodiment, the providing a vasostimulant comprises administering a chemical agent to the subject which effects vascular function. In an exemplary embodiment, the chemical agent comprises a vasoconstrictor. In an exemplary embodiment, the chemical agent comprises a vasodilator. In an exemplary embodiment, the chemical agent comprises a neurostimulator. In an exemplary embodiment, the chemical agent is nitroglycerin. In an exemplary embodiment, the nitroglycerin is administered sublingually.

[0361] In an exemplary embodiment, the measuring the skin temperature changes of the body part during and subsequent to the provision of the vasostimulant comprises measuring the lowest skin temperature of the body part. In an exemplary embodiment, the measuring the skin temperature changes of the body part during and subsequent to the provision of the vasostimulant comprises measuring the time required to achieve the lowest skin temperature of the body part. In an exemplary embodiment, the measuring the skin temperature changes of the body part during and subsequent to the provision of the vasostimulant comprises measuring the highest skin temperature of the body part. In an exem-



plary embodiment, the measuring the skin temperature changes of the body part during and subsequent to the provision of the vasostimulant comprises measuring the temperature difference between the highest skin temperature of the body part and the skin temperature of the body part prior to the provision of the vasostimulant. In an exemplary embodiment, the difference between the highest skin temperature of the body part and the skin temperature of the body part prior to the provision of the vasostimulant is normalized based on the skin temperature of the body part prior to the provision of the vasostimulant. In an exemplary embodiment, the measuring the skin temperature changes of the body part during and subsequent to the provision of the vasostimulant comprises measuring the temperature difference between the highest skin temperature of the body part and the lowest skin temperature of the body part. In an exemplary embodiment, the measuring the skin temperature changes of the body part during and subsequent to the provision of the vasostimulant comprises measuring the time required for the skin temperature of the body part to stabilize subsequent to the provision of the vasostimulant.

[0362] In an exemplary embodiment, the determining one or more health conditions for the subject based upon at least one of the temperature changes measured comprises determining the slope of the skin temperature changes of the body part from the skin temperatures of the body part upon the provision of the vasostimulant up to the lowest skin temperature of the body part achieved. In an exemplary embodiment, the determining one or more health conditions for the subject based upon at least one of the temperature changes measured comprises determining the slope of the skin temperature changes of the body part from the lowest skin temperature of the body part achieved up to the highest skin temperature of the body part achieved. In an exemplary embodiment, the determining one or more health conditions for the subject based upon at least one of the temperature changes measured comprises plotting the temperature changes over time and measuring the area bounded by the skin temperature curve, the lowest skin temperature of the body part achieved, the time at which the vasostimulant was provided, and the time at which the lowest skin temperature of the body part was achieved.

[0363] In an exemplary embodiment, the determining one or more health conditions for the subject based upon at least one of the temperature changes measured comprises plotting the temperature changes over time and measuring the area bounded by the skin temperature curve, the lower skin temperature of the body part achieved, the time at which the lowest skin temperature of the body part was achieved, and the time at which the highest skin temperature of the body part was achieved.

[0364] In an exemplary embodiment, the determining one or more health conditions for the subject based upon at least one of the temperature changes measured comprises determining endothelial function.

[0365] In an exemplary embodiment, the determining one or more health conditions for the subject based upon at least one of the temperature changes measured comprises screening for autonomic nervous system function. In an exemplary embodiment, the determining one or more health conditions for the subject based upon at least one of the temperature changes measured comprises analyzing the temperature

response to the vasostimulant in order to assess cardiovascular risk for atherosclerotic cardiovascular disorder. In an exemplary embodiment, the determining one or more health conditions for the subject based upon at least one of the temperature changes measured comprises analyzing the temperature response to the vasostimulant in order to monitor the subject's response to atherosclerotic cardiovascular disorder therapies. In an exemplary embodiment, the determining one or more health conditions for the subject based upon at least one of the temperature changes measured comprises analyzing the temperature response to the vasostimulant along with additional diagnosis techniques in order to assess cardiovascular risk for atherosclerotic cardiovascular disorder. In an exemplary embodiment, the additional diagnosis techniques comprise a coronary calcium score. In an exemplary embodiment, the additional diagnosis techniques comprise a Framingham risk score. In an exemplary embodiment, the additional diagnosis techniques comprise a carotid intima-media thickness test.

[0366] In an exemplary embodiment, the determining one or more health conditions for the subject based upon at least one of the temperature changes measured comprises analyzing the temperature response to the vasostimulant in order to monitor the progression of heart failure in the subject. In an exemplary embodiment, the determining one or more health conditions for the subject based upon at least one of the temperature changes measured comprises analyzing the temperature response to the vasostimulant in order to monitor the subject's response to heart failure therapies. In an exemplary embodiment, the determining one or more health conditions for the subject based upon at least one of the temperature changes measured comprises analyzing the temperature response to the vasostimulant along with additional diagnosis techniques in order to monitor the progression of heart failure in the subject. In an exemplary embodiment, the additional diagnosis techniques comprise a cardiac function test.

[0367] In an exemplary embodiment, the determining one or more health conditions for the subject based upon at least one of the temperature changes measured comprises analyzing the temperature response to the vasostimulant for use in obesity management of the subject. In an exemplary embodiment, the determining one or more health conditions for the subject based upon at least one of the temperature changes measured comprises analyzing the temperature response to the vasostimulant along with additional diagnosis techniques for use in obesity management of the subject.

[0368] In an exemplary embodiment, the determining one or more health conditions for the subject based upon at least one of the temperature changes measured comprises analyzing the temperature response to the vasostimulant in order to identify whether the subject has high sympathetic reactivity. In an exemplary embodiment, the determining one or more health conditions for the subject based upon at least one of the temperature changes measured comprises analyzing the temperature response to the vasostimulant in order to monitor the subject's response to hypersympathetic therapies. In an exemplary embodiment, the determining one or more health conditions for the subject based upon at least one of the temperature changes measured comprises analyzing the temperature response to the vasostimulant along with additional diagnosis techniques in order to identify whether the subject has high sympathetic reactivity. In an



exemplary embodiment, the determining one or more health conditions for the subject based upon at least one of the temperature changes measured comprises analyzing the temperature response to the vasostimulant in order to screen the subject for susceptibility to high blood pressure.

[0369] In an exemplary embodiment, the determining one or more health conditions for the subject based upon at least one of the temperature changes measured comprises analyzing the temperature response to the vasostimulant in order to monitor the subject's response to high blood pressure therapies. In an exemplary embodiment, the determining one or more health conditions for the subject based upon at least one of the temperature changes measured comprises analyzing the temperature response to the vasostimulant along with additional diagnosis techniques in order to screen the subject for susceptibility to high blood pressure. In an exemplary embodiment, the determining one or more health conditions for the subject based upon at least one of the temperature changes measured comprises analyzing the temperature response to the vasostimulant in order to identify whether the subject is resistant to high blood pressure therapies.

[0370] In an exemplary embodiment, the determining one or more health conditions for the subject based upon at least one of the temperature changes measured comprises analyzing the temperature response to the vasostimulant in order to screen the subject for white coat hypertension. In an exemplary embodiment, the determining one or more health conditions for the subject based upon at least one of the temperature changes measured comprises analyzing the temperature response to the vasostimulant along with additional diagnosis techniques in order to screen the subject for white coat hypertension.

[0371] In an exemplary embodiment, the method further comprises measuring and recording the blood pressure of the subject, wherein the determining one or more health conditions for the subject based upon at least one of the temperature changes measured comprises distinguishing between different stages of hypertensive vascular disease. In an exemplary embodiment, the determining one or more health conditions for the subject based upon at least one of the temperature changes measured comprises analyzing the temperature response to the vasostimulant along with additional diagnosis techniques in order to distinguish between different stages of hypertensive vascular disease. In an exemplary embodiment, the determining one or more health conditions for the subject based upon at least one of the temperature changes measured comprises screening the subject for smooth muscle cell (SMC) dysfunction.

[0372] In an exemplary embodiment, the determining one or more health conditions for the subject based upon at least one of the temperature changes measured comprises monitoring the subject's response to smooth muscle cell (SMC) dysfunction therapies. In an exemplary embodiment, the determining one or more health conditions for the subject based upon at least one of the temperature changes measured comprises analyzing the temperature response to the vasostimulant along with additional diagnosis techniques in order to screen the subject smooth muscle cell (SMC) dysfunction.

[0373] In an exemplary embodiment, the determining one or more health conditions for the subject based upon at least

one of the temperature changes measured comprises analyzing the temperature response to the vasostimulant in order to predict whether the subject will develop diabetes. In an exemplary embodiment, the determining one or more health conditions for the subject based upon at least one of the temperature changes measured comprises analyzing the temperature response to the vasostimulant in order to monitor the status and progression of the subject's diabetes. In an exemplary embodiment, the determining one or more health conditions for the subject based upon at least one of the temperature changes measured comprises analyzing the temperature response to the vasostimulant in order to monitor the subject's response to diabetes therapies. In an exemplary embodiment, the determining one or more health conditions for the subject based upon at least one of the temperature changes measured comprises analyzing the temperature response to the vasostimulant along with additional diagnosis techniques in order to monitor the status and progression of the subject's diabetes. In an exemplary embodiment, the additional diagnosis techniques comprise a hemoglobin A1C test. In an exemplary embodiment, the additional diagnosis techniques comprise measuring the subject's glucose level.

[0374] In an exemplary embodiment, the determining one or more health conditions for the subject based upon at least one of the temperature changes measured comprises analyzing the temperature response to the vasostimulant in order to determine a fitness level in the subject. In an exemplary embodiment, the determining one or more health conditions for the subject based upon at least one of the temperature changes measured comprises analyzing the temperature response to the vasostimulant in order to determine the subject's response to a fitness program. In an exemplary embodiment, the determining one or more health conditions for the subject based upon at least one of the temperature changes measured comprises analyzing the temperature response to the vasostimulant along with additional diagnosis techniques in order to determine a fitness level in the subject.

[0375] In an exemplary embodiment, the determining one or more health conditions for the subject based upon at least one of the temperature changes measured comprises assessing the subject for vascular effects due to a rheumatologic disorder. In an exemplary embodiment, the determining one or more health conditions for the subject based upon at least one of the temperature changes measured comprises monitoring the subject's response to treatment for a rheumatologic disorder. In an exemplary embodiment, the determining one or more health conditions for the subject based upon at least one of the temperature changes measured comprises analyzing the temperature response to the vasostimulant along with additional diagnosis techniques in order to assess the subject for vascular effects due to a rheumatologic disorder. In an exemplary embodiment, the body part is a finger, whereby the determining one or more health conditions for the subject based upon at least one of the temperature changes measured comprises screening the subject for Raynaud's phenomenon. In an exemplary embodiment, the determining one or more health conditions for the subject based upon at least one of the temperature changes measured comprises analyzing the temperature response to the vasostimulant along with additional diagnosis techniques in order to screen the subject for Raynaud's phenomenon.



[0376] In an exemplary embodiment, the determining one or more health conditions for the subject based upon at least one of the temperature changes measured comprises predicting whether the subject is at risk for a connective tissue disorder. In an exemplary embodiment, the connective tissue disorder is presclerodema. In an exemplary embodiment, the determining one or more health conditions for the subject based upon at least one of the temperature changes measured comprises monitoring the subject's response to treatment for presclerodema. In an exemplary embodiment, the determining one or more health conditions for the subject based upon at least one of the temperature changes measured comprises analyzing the temperature response to the vasostimulant along with additional diagnosis techniques in order to predict whether the subject is at risk for a connective tissue disorder.

[0377] In an exemplary embodiment, the determining one or more health conditions for the subject based upon at least one of the temperature changes measured comprises analyzing the temperature response to the vasostimulant in order to determine whether the subject is at risk for pulmonary hypertension. In an exemplary embodiment, the determining one or more health conditions for the subject based upon at least one of the temperature changes measured comprises analyzing the temperature response to the vasostimulant in order to monitor the status and progression of the subject's pulmonary hypertension. In an exemplary embodiment, the determining one or more health conditions for the subject based upon at least one of the temperature changes measured comprises analyzing the temperature response to the vasostimulant in order to monitor the subject's response to pulmonary hypertension therapies. In an exemplary embodiment, the determining one or more health conditions for the subject based upon at least one of the temperature changes measured comprises analyzing the temperature response to the vasostimulant along with additional diagnosis techniques in order to monitor the status and progression of the subject's pulmonary hypertension.

[0378] In an exemplary embodiment, the determining one or more health conditions for the subject based upon at least one of the temperature changes measured comprises analyzing the temperature response to the vasostimulant in order to determine whether the subject would respond positively to a smoking cessation program. In an exemplary embodiment, the determining one or more health conditions for the subject based upon at least one of the temperature changes measured comprises analyzing the temperature response to the vasostimulant in order to monitor the subject's smoking cessation. In an exemplary embodiment, the determining one or more health conditions for the subject based upon at least one of the temperature changes measured comprises analyzing the temperature response to the vasostimulant in order to monitor the subject's success with a smoking cessation program. In an exemplary embodiment, the determining one or more health conditions for the subject based upon at least one of the temperature changes measured comprises analyzing the temperature response to the vasostimulant along with additional diagnosis techniques in order to determine whether the subject would respond positively to a smoking cessation program.

[0379] In an exemplary embodiment, the determining one or more health conditions for the subject based upon at least one of the temperature changes measured comprises ana-

lyzing the temperature response to the vasostimulant in order to monitor vascular stress of the subject without subjecting the subject to physical activity.

[0380] In an exemplary embodiment, the determining one or more health conditions for the subject based upon at least one of the temperature changes measured comprises analyzing the temperature response to the vasostimulant in order to monitor the progression of sleep disorder in the subject. In an exemplary embodiment, the determining one or more health conditions for the subject based upon at least one of the temperature changes measured comprises analyzing the temperature response to the vasostimulant in order to monitor the subject's response to sleep disorder therapy. In an exemplary embodiment, the determining one or more health conditions for the subject based upon at least one of the temperature changes measured comprises analyzing the temperature response to the vasostimulant along with additional diagnosis techniques in order to monitor the progression of sleep disorder in the subject. In an exemplary embodiment, the method further comprises measuring the heart rate of the subject, wherein the measuring the heart rate and the measuring the skin temperature changes of the body part are performed at least partially while the subject is sleeping in order to detect sleep disorders.

[0381] In an exemplary embodiment, the method is carried out a plurality of times over a designated time interval. In an exemplary embodiment, the method further comprises administering a magnetic resonance imaging test to the subject. In an exemplary embodiment, the method further comprises diagnosing an intravascular property of the subject using intravascular diagnostic tools. In an exemplary embodiment, the intravascular diagnostic tools comprise intravascular ultrasound. In an exemplary embodiment, the method further comprises measuring and recording a blood flow rate of the subject. In an exemplary embodiment, the blood flow rate is measured using optical spectroscopy. In an exemplary embodiment, the blood flow rate is measured using near infrared spectroscopy. In an exemplary embodiment, the method further comprises measuring and recording a room temperature. In an exemplary embodiment, the method further comprises measuring and recording a core temperature of the subject. In an exemplary embodiment, the method further comprises measuring and recording a tissue heat capacity of the subject. In an exemplary embodiment, the method further comprises measuring and recording a tissue metabolic rate of the subject.

[0382] In an exemplary embodiment, the method further comprises measuring and recording the blood pressure of the subject. In an exemplary embodiment, the blood pressure of the subject is measured using Korotkoff sounds or oscillometric methods. In an exemplary embodiment, the blood pressure of the subject is measured using fingertip blood pressure. In an exemplary embodiment, the blood pressure of the subject is measured using wrist blood pressure. In an exemplary embodiment, the method further comprises determining a vasodilative index for the subject. In an exemplary embodiment, the method further comprises determining a vasoconstrictive index for the subject. In an exemplary embodiment, the blood pressure of the subject is measured before the provision of the vasostimulant. In an exemplary embodiment, the blood pressure of the subject is measured after the provision of the vasostimulant. In an exemplary



embodiment, the blood pressure of the subject is measured before, during, and after the provision of the vasostimulant.

[0383] In an exemplary embodiment, the determining one or more health conditions for the subject based upon at least one of the temperature changes measured comprises analyzing the temperature response to the vasostimulant in order to monitor the subject's response to mental stress. In an exemplary embodiment, the monitoring the subject's response to mental stress comprises detecting whether or not the subject is telling the truth. In an exemplary embodiment, the determining one or more health conditions for the subject based upon at least one of the temperature changes measured comprises analyzing the temperature response to the vasostimulant along with additional diagnosis techniques in order to monitor the subject's response to mental stress.

[0384] In an exemplary embodiment, the method further comprises providing a thermal measuring device operable to measure and record the skin temperature of a body part. In an exemplary embodiment, the thermal measuring device comprises a ring. In an exemplary embodiment, the thermal measuring device comprises a watch. In an exemplary embodiment, the thermal measuring device comprises a bracelet.

[0385] In an exemplary embodiment, the method further comprises measuring the skin temperature changes on a contralateral body part of the subject. In an exemplary embodiment, the contralateral body part comprises a plurality of contralateral body parts. In an exemplary embodiment, the body part is a first hand on the subject, and the contralateral body part is a second hand on the subject. In an exemplary embodiment, the body part is a first foot on the subject, and the contralateral body part is a second foot on the subject. In an exemplary embodiment, the body part is a finger on the subject, and the contralateral body part is a toe on the subject.

[0386] In an exemplary embodiment, the determining one or more health conditions for the subject based upon at least one of the temperature changes measured comprises analyzing the temperature response to the vasostimulant in order to monitor the progression of metabolic syndrome in the subject. In an exemplary embodiment, the determining one or more health conditions for the subject based upon at least one of the temperature changes measured comprises analyzing the temperature response to the vasostimulant in order to monitor the subject's response to metabolic syndrome therapy. In an exemplary embodiment, the determining one or more health conditions for the subject based upon at least one of the temperature changes measured comprises analyzing the temperature response to the vasostimulant along with additional indicative criteria in order to detect whether the subject is at risk for metabolic syndrome.

[0387] In an exemplary embodiment, the body part comprises a finger. In an exemplary embodiment, the body part comprises a hand. In an exemplary embodiment, the body part comprises a forearm. In an exemplary embodiment, the body part comprises a leg. In an exemplary embodiment, the body part comprises a foot. In an exemplary embodiment, the body part comprises an earlobe. In an exemplary embodiment, the body part comprises a nose. In an exemplary embodiment, the measuring and recording the skin temperature of a body part comprises multiple temperature measurement at different points on the body part.

[0388] In an exemplary embodiment, the determining one or more health conditions for the subject based upon at least one of the temperature changes measured comprises analyzing the temperature response to the vasostimulant to detect subclinical hypothyroidism in the subject. In an exemplary embodiment, the determining one or more health conditions for the subject based upon at least one of the temperature changes measured comprises analyzing the temperature response to the vasostimulant in order to monitor the subject's response to subclinical hypothyroidism therapy. In an exemplary embodiment, the determining one or more health conditions for the subject based upon at least one of the temperature changes measured comprises analyzing the temperature response to the vasostimulant along with additional indicative criteria in order to detect subclinical hypothyroidism in the subject.

[0389] In an exemplary embodiment, the determining one or more health conditions of the subject based upon at least one of the temperature changes measured comprises a software program which diagnoses the subject based on the temperature changes measured.

[0390] In an exemplary embodiment, the determining one or more health conditions of the subject based upon at least one of the temperature changes measured comprises analyzing the temperature response to the vasostimulant in order to screen the subject for vascular dementia. In an exemplary embodiment, the determining one or more health conditions of the subject based upon at least one of the temperature changes measured comprises analyzing the temperature response to the vasostimulant in order to monitor the subject's response to treatment for vascular dementia. In an exemplary embodiment, the determining one or more health conditions of the subject based upon at least one of the temperature changes measured comprises analyzing the temperature response to the vasostimulant along with other diagnostic methods in order to screen the subject for vascular dementia.

[0391] In an exemplary embodiment, the determining one or more health conditions of the subject based upon at least one of the temperature changes measured comprises analyzing the temperature response to the vasostimulant in order to screen the subject for Alzheimer's disease. In an exemplary embodiment, the determining one or more health conditions of the subject based upon at least one of the temperature changes measured comprises analyzing the temperature response to the vasostimulant along with other diagnostic methods in order to screen the subject for Alzheimer's disease.

[0392] In an exemplary embodiment, the determining one or more health conditions of the subject based upon at least one of the temperature changes measured comprises determining whether the subject will develop portal hypertension. In an exemplary embodiment, the determining one or more health conditions of the subject based upon at least one of the temperature changes measured comprises determining the status and progression of portal hypertension in the subject. In an exemplary embodiment, the determining one or more health conditions of the subject based upon at least one of the temperature changes measured comprises determining the response of the subject to portal hypertension disease therapies. In an exemplary embodiment, the determining one or more health conditions of the subject based











one of the temperature changes measured comprises determining whether the subject has diabetic foot. In an exemplary embodiment, the determining one or more health conditions of the subject based upon at least one of the temperature changes measured comprises determining the status and progression of diabetic foot in the subject. In an exemplary embodiment, the determining one or more health conditions of the subject based upon at least one of the temperature changes measured comprises determining the response of the subject to diabetic foot therapies. In an exemplary embodiment, the determining one or more health conditions of the subject based upon at least one of the temperature changes measured comprises analyzing the temperature response to the vasostimulant along with additional diagnosis techniques in order to diagnose the subject for diabetic foot.

[0408] In an exemplary embodiment, the method further comprises administering an ankle-brachial blood pressure index test to the subject. In an exemplary embodiment, the determining one or more health conditions for the subject based upon at least one of the temperature changes measured comprises analyzing the temperature response to the vasostimulant in order to assess the subjects endothelial function. In an exemplary embodiment, the determining one or more health conditions for the subject based upon at least one of the temperature changes measured comprises analyzing the temperature response to the vasostimulant along with additional diagnosis techniques in order to assess the subjects endothelial function. In an exemplary embodiment, the additional diagnosis techniques comprise using a blood marker of endothelial function. In an exemplary embodiment, the additional diagnosis techniques comprise an endothelial driven microparticles test. In an exemplary embodiment, the additional diagnosis techniques comprise a VCAM1 test. In an exemplary embodiment, the additional diagnosis techniques comprise an ICAM1 test. In an exemplary embodiment, the additional diagnosis techniques comprise a SELECTIN test. In an exemplary embodiment, the additional diagnosis techniques comprise a VWF test. In an exemplary embodiment, the additional diagnosis techniques comprise an oxygen saturation measurement at a fingertip. In an exemplary embodiment, the additional diagnosis techniques comprise a CD54 test.

[0409] In an exemplary embodiment, the determining one or more health conditions of the subject based upon at least one of the temperature changes measured comprises monitoring the pregnancy of the subject. In an exemplary embodiment, the monitoring the pregnancy of the subject comprises diagnosing the subject for preeclampsia.

[0410] In an exemplary embodiment, the method further comprises measuring the blood pressure of the subject. In an exemplary embodiment, the method further comprises changing the skin temperature of the body part. In an exemplary embodiment, the changing the skin temperature of the body part comprises heating and/or cooling the body part with a thermal device. In an exemplary embodiment, the changing the skin temperature of the body part comprises elevating the body part. In an exemplary embodiment, the method further comprises measuring a blood speed through an artery of the subject which supplies blood to the body part. In an exemplary embodiment, the blood speed is measured before, during, and after the provision of the vasostimulant. In an exemplary embodiment, the method

further comprises measuring and recording the stiffness of an artery supplying blood to the body part. In an exemplary embodiment, the stiffness of the artery is measured and recorded using arterial pulse waveform analysis. In an exemplary embodiment, the stiffness of the artery is measured and recorded before providing the vasostimulant. In an exemplary embodiment, the stiffness of the artery is measured and recorded after providing the vasostimulant. In an exemplary embodiment, the stiffness of the artery is measured and recorded before, during, and after providing the vasostimulant.

[0411] In an exemplary embodiment, the ambient temperature around the thermal energy sensor is held constant. In an exemplary embodiment, the fluid flow around the thermal energy sensor is kept to a minimum. In an exemplary embodiment, the determining one or more health conditions comprises determining a coronary calcium score. In an exemplary embodiment, the determining one or more health conditions comprises determining a Framingham risk score. In an exemplary embodiment, the determining one or more health conditions comprises determining a carotid intima media thickness. In an exemplary embodiment, the determining one or more health conditions comprises conducting a c-reactive protein test. In an exemplary embodiment, the determining one or more health conditions comprises determining an Lp-PLA2 level.

[0412] In an exemplary embodiment, the method further comprises acquiring a measure of endothelium dependent vascular reactivity, using additional non-endothelial related diagnosis techniques to acquire a measure of endothelium independent vascular reactivity, calculating a ratio of the measure of endothelium dependent vascular reactivity over the measure of endothelium independent vascular reactivity, and determining a health condition of the subject. In an exemplary embodiment, the method further comprises acquiring a measure of endothelium dependent vascular reactivity, using additional diagnosis techniques to acquire a measure of parameters other than temperature that change upon provision of the vasostimulant, calculating a ratio of the measure of endothelium dependent vascular reactivity over the measure of parameters other than temperature that change upon provision of the vasostimulant, and determining a health condition of the subject. In an exemplary embodiment, the providing a vasostimulant comprises providing a modifier of vasostimulators. In an exemplary embodiment, the modifier of vasostimulators comprises an LNAME compound. In an exemplary embodiment, the modifier of vasostimulators comprises an L-Arginine compound.

[0413] In an exemplary embodiment, the determining one or more health conditions of the subject based upon at least one of the temperature changes measured comprises determining whether the effectiveness of cholesterol lowering medications in the subject. In an exemplary embodiment, the cholesterol lowering medications are from the family of statins. In an exemplary embodiment, the cholesterol lowering medications include Lipitor. In an exemplary embodiment, the cholesterol lowering medications include mevlonate.

[0414] In an exemplary embodiment, the method further includes measuring the change in oxygen saturation of the body part. In an exemplary embodiment, the method further



includes measuring the change in Doppler flow of the body part. In an exemplary embodiment, the method further includes measuring the change in pressure of the body part. In an exemplary embodiment, the method further includes measuring the change in blood flow of the body part by near infrared spectroscopy. In an exemplary embodiment, the method further includes using an additional diagnostic techniques in order to determine the health condition of the patient selected from the group consisting of: intravascular optical coherent tomography, coronary fractional flow reserve, intravascular ultrasound radiofrequency backscatter analysis or Virtual Histology, urinary albumin, serum fibrinogen, IL6, CD40/CD40L, serum amyloid A, ankle brachial index, MR1, coronary calcium score, carotid intima thickness, vascular stiffness tests, C-reactive protein tests, waist circumference, blood insulin level, PAI-1 test, t-PA test, glucose tolerance tests, fasting plasma glucose level, HDL cholesterol level, fasting plasma insulin test, homeostasis model assessment, BMI, body fat level, visceral fat test, subcutaneous fat test, white blood cell count, Neutrophil/lymphocyte ratio, platelet function tests, and combinations thereof

[0415] In an exemplary embodiment, the method further includes using an additional diagnostic techniques in order to determine the health condition of the patient selected from the group consisting of: plasma and urinary level of asymmetrical (ADMA) and symmetrical (SDMA) dimethylarginine, exhaled nitric oxide, serum homocysteine, an endothelial driven microparticles test, a VCAM1 test, an ICAM1 test, a SELECTIN test, a VWF test, a TF test, a CD54 test, endothelial progenitor cells, myelo-peroxidase (MPO), increased neutrophil/lymphocyte ratio, endothelin-1, thrombomodulin, tissue factor and tissue factor pathway inhibitor, markers of inflammation such as, for example, granulocyte-macrophage colony-stimulating factor (GM-CSF) and macrophage chemoattractant protein-1 (MCP-1) nitric oxide and its metabolites nitrates and nitrites, almost nitrosylated proteins, a selectin such as, for example, soluble endothelium, leukocyte, and platelet selecting, markers of oxidative stress including but not limited to free radical measurements of the blood or through the skin, TBAR, and/or extra cellular super oxide dismutase activity, vascular stiffness or compliance, and combinations thereof.

[0416] In an exemplary embodiment, the method further includes using an additional diagnostic techniques in order to determine the health condition of the patient selected from the group consisting of: skin color, nail capillaroscopy, ultrasound brachial artery imaging, forearm plethysmography, fingertip plethysmography, oxygen saturation change, pressure change, near-infrared spectroscopy measurements, Doppler flow change, peripheral artery tomometry, and combinations thereof. In an exemplary embodiment, the method further includes acquiring a measure of endothelium dependent vascular reactivity, using additional non-endothelial related diagnosis techniques to acquire a measure of endothelium independent vascular reactivity, calculating a composite index of the measure of endothelium dependent vascular reactivity and the measure of endothelium independent vascular reactivity, and determining a health condition of the subject. In an exemplary embodiment, the method further includes acquiring a measure of endothelium dependent vascular reactivity, using additional diagnosis techniques to acquire a measure of parameters other than temperature that change upon provision of the vasostimu-

lant, calculating a composite index of the measure of endothelium dependent vascular reactivity and the measure of parameters other than temperature that change upon provision of the vasostimulant, and determining a health condition of the subject.

[0417] A method for determining one or more health conditions has been described comprising providing a subject, measuring the skin temperature of a first body part on the subject, placing a second body part of the subject in water, measuring the skin temperature changes of the first body part during and subsequent to the placing of the second body part in water, and determining one or more health conditions for the subject based upon at least one of the skin temperature changes measured.

[0418] A method for determining one or more health conditions has been described comprising providing a subject, providing a volume of a medium, placing a body part of the subject in the volume of the medium, measuring the temperature of the volume of the medium, providing a vasostimulant to the subject, measuring the temperature changes of the volume of the medium during and subsequent to the provision of the vasostimulant, and determining one or more health conditions for the subject based upon at least one of the temperature changes measured.

[0419] A database for diagnosing health conditions has been described comprising control data comprising a plurality of control temperature data points and temperature data comprising a baseline temperature, a temperature drop from the baseline temperature having a first slope, a lowest temperature achieved, a temperature rise from the lowest temperature achieved having a second slope, a peak temperature, and a stabilization temperature.

[0420] A method for determining one or more health conditions has been described comprising providing a subject, measuring the baseline skin temperature of a body part on the subject, providing a vasostimulant to the subject, measuring the lowest skin temperature of the body part during and subsequent to the provision of the vasostimulant, measuring the highest skin temperature of the body part, and determining one or more health conditions for the subject based upon at least one of the skin temperature changes measured. In an exemplary embodiment, the determining one or more health conditions for the subject based upon at least one of the skin temperature changes measured comprises diagnosing healthy vascular reactivity due to the temperature difference between the highest skin temperature measured and the lowest skin temperature measured being greater than the difference between the baseline temperature measured and the lowest skin temperature measured. In an exemplary embodiment, the determining one or more health conditions for the subject based upon at least one of the skin temperature changes measured comprises diagnosing unhealthy vascular reactivity due to temperature difference between the highest skin temperature measured and the lowest skin temperature measured being less than the difference between the baseline temperature measured and the lowest skin temperature measured. In an exemplary embodiment, the determining one or more health conditions for the subject based upon at least one of the skin temperature changes measured comprises diagnosing unhealthy vascular reactivity due to temperature difference between the highest skin temperature measured and the baseline temperature measured being negative.



[0421] A computer program for determining one or more health conditions has been described comprising a retrieval engine adapted to retrieve a plurality of temperature data from a database, the temperature data comprising a baseline temperature, a temperature drop from the baseline temperature having a first slope, a lowest temperature achieved, a temperature rise from the lowest temperature achieved having a second slope, a peak temperature, and a stabilization temperature; a processing engine adapted to process data retrieved by the retrieval engine, and a diagnosis engine operable to determine one or more health conditions based upon the retrieved temperature data. In an exemplary embodiment, the diagnosis engine may diagnose healthy vascular reactivity due to the temperature difference between the peak temperature and the lowest temperature being greater than the difference between the baseline temperature and the lowest temperature. In an exemplary embodiment, the diagnosis engine may diagnose unhealthy vascular reactivity due to temperature difference between the peak temperature and the lowest temperature being less than the difference between the baseline temperature and the lowest temperature. In an exemplary embodiment, the diagnosis engine may diagnose unhealthy vascular reactivity due to temperature difference between the peak temperature and the baseline temperature being negative.

[0422] A method for determining one or more health conditions has been described which includes providing a subject, measuring the blood flow rate of the subject, providing a vasostimulant to the subject, measuring the blood flow rate changes of the subject during and subsequent to the provision of the vasostimulant, and determining one or more health conditions for the subject based upon at least one of the blood flow rate changes measured. In an exemplary embodiment, the blood flow rate is measured using optical spectroscopy. In an exemplary embodiment, the method further comprises administering an optical spectroscopy tracer to the subject.

[0423] A method for determining one or more health conditions has been described which includes providing a subject, measuring the skin temperature of a finger on the arm of the subject, detecting an equilibrium in the skin temperature of the finger of the subject, automatically providing a vasostimulant to the subject to substantially cease blood flow to the finger, measuring the skin temperature changes of the finger after provision of the vasostimulant, automatically removing the vasostimulant to allow blood flow to the finger, measuring the skin temperature changes of the finger after the removal of the vasostimulant, and determining one or more health conditions for the subject based upon at least one of the skin temperature changes measured. In an exemplary embodiment, the providing a vasostimulant comprises inflating an inflatable cuff on an arm of the subject to a pressure which is higher than a blood pressure of the subject. In an exemplary embodiment, the blood pressure of the subject is a measured blood pressure. In an exemplary embodiment, the blood pressure of the subject is a known blood pressure. In an exemplary embodiment, the blood pressure of the subject is an estimated blood pressure. In an exemplary embodiment, the method further comprises measuring the skin temperature of a contralateral body part on the subject.

[0424] A method for selecting a medication for the treatment of a medical condition in a subject has been described

which includes administering a medication to one or more subjects, determining the health condition of the one or more subjects using the method of: measuring the skin temperature of a body part on the one or more subjects, providing a vasostimulant to the one or more subjects, measuring the skin temperature changes of the body part during and subsequent to the provision of the vasostimulant; and determining one or more health conditions for the one or more subjects based upon at least one of the skin temperature changes measured; determining whether the medication is effective in the treatment of the one or more subjects, and selecting the medication for use in treating the medical condition in other subjects if the medication is determined to be effective in the treatment of the one or more subjects.

[0425] A method for selecting a nutritional program for a subject has been described which includes administering a nutritional program to one or more subjects, determining the health condition of the one or more subjects using the method of: measuring the skin temperature of a body part on the one or more subjects, providing a vasostimulant to the one or more subjects, measuring the skin temperature changes of the body part during and subsequent to the provision of the vasostimulant, and determining one or more health conditions for the one or more subjects based upon at least one of the skin temperature changes measured; determining whether the nutritional program is effective for the one or more subjects, and selecting the nutritional program for other subjects if the nutritional program is determined to be effective for the one or more subjects.

[0426] A system for selecting a medication for the treatment of a medical condition in a subject has been described which includes means for administering a medication to one or more subjects, means for determining the health condition of the one or more subjects comprising: means for measuring the skin temperature of a body part on the one or more subjects, means for providing a vasostimulant to the one or more subjects, means for measuring the skin temperature changes of the body part during and subsequent to the provision of the vasostimulant, and means for determining one or more health conditions for the one or more subjects based upon at least one of the skin temperature changes measured; means for determining whether the medication is effective in the treatment of the one or more subjects, and means for selecting the medication for use in treating the medical condition in other subjects if the medication is determined to be effective in the treatment of the one or more subjects.

[0427] A system for selecting a nutritional program for a subject has been described which includes means for administering a nutritional program to one or more subjects, means for determining the health condition of the one or more subjects comprising: means for measuring the skin temperature of a body part on the one or more subjects, means for providing a vasostimulant to the one or more subjects, means for measuring the skin temperature changes of the body part during and subsequent to the provision of the vasostimulant, and means for determining one or more health conditions for the one or more subjects based upon at least one of the skin temperature changes measured; means for determining whether the nutritional program is effective for the one or more subjects, and means for selecting the



nutritional program for other subjects if the nutritional program is determined to be effective for the one or more subjects.

[0428] A method for selecting a medication for the treatment of a medical condition in a subject has been described which includes administering a medication to one or more subjects, determining a health condition of the one or more subjects using the apparatus of any one of the claims 1 to 44, determining whether the medication is effective in the treatment of the one or more subjects, and selecting the medication for use in treating a medical condition in other subjects if the medication is determined to be effective in the treatment of the one or more subjects.

[0429] A method for selecting a nutritional program for a subject has been described which includes administering a nutritional program to one or more subjects, determining a health condition of the one or more subjects using the apparatus of the present invention, determining whether the nutritional program is effective for the one or more subjects, and selecting the nutritional program for other subjects if the nutritional program is determined to be effective for the one or more subjects.

[0430] A method for selecting a chemical substance for the treatment of a medical condition has been described which includes administering a chemical substance to a subject, determining a health condition of the one or more subjects using the method of the present invention, and studying the effects of the chemical substance on the subject.

[0431] A method for selecting a medical procedure for the treatment of a medical condition has been described which includes performing a medical procedure on a subject, determining a health condition of the one or more subjects using the method of the present invention, and studying the effects of the medical procedure on the subject.

[0432] A method for selecting a health intervention program for the treatment of a subject has been described which includes administering a health intervention program on a subject, determining a health condition of the one or more subjects using the method of the present invention, and studying the effects of the health intervention program on the subject.

[0433] A method for determining one or more health conditions has been described which includes providing a subject, measuring the temperature of a body part on the subject, providing a vasostimulant to the subject, measuring the temperature changes of the body part during and subsequent to the provision of the vasostimulant, and determining one or more health conditions for the subject based upon at least one of the temperature changes measured.

Correlation with the Ultrasound Based Method of Measuring Brachial Artery Reactivity

[0434] Change in brachial artery diameter (BAD) during reactive hyperemia is conventionally used to assess endothelial function. A hypothesis that changes in digit temperature would correlate with brachial artery reactivity and thus provide a novel and simple method for assessing endothelial function was tested.

[0435] Using a sensitive digital thermal monitoring (DTM) device, changes were measured in temperature at the index fingertip of 30 healthy volunteers (mean age 42±13,

15 males) before, during and after brachial artery occlusion (200 mmHg, 2-5 minutes). Data was analyzed on 26 of these volunteers. Simultaneously, maximum changes in BAD and peak systolic flow velocity (PSV) by Brachial Artery Ultrasound Scanning were measured. Several parameters including TF (maximum temperature fall during cuff inflation), TR (maximum temperature rebound post-deflation), NP (nadir to peak), TTR (time to TR), TTF (time to TF) were measured and correlated with BAD. Subjects were instructed to fast starting the night before the testing and to refrain smoking, alcohol ingestion or caffeine and taking any vasoactive medications the day of the testing.

[0436] The device comprised a computer-based thermometry system (0.01° F. thermal resolution), and two fingertip thermocouple probes. Different designs of finger-tip probes such as fingertip cap, pen-design, and flat-probe were tested in preliminary experiments. In choosing the design, minimum area of skin-probe contact, minimum pressure on fingertip, and minimum change in the baseline temperature were considered as key factors (i.e. does not change local temperature by insulation or perspiration, does not firmly attach to the fingertip to minimize alteration of the skin micro-capillary flow, does not restrict movement of the finger and such movements do not interfere with temperature measurement). The device measures temperature only and does not introduce any signal to the body. See FIG. 11c and FIG. 16. The thermal probes were placed on the tip of index fingers on each hand. The index finger of the right arm was used for the test in all cases and the left index finger was used as control. The temperature was continuously recorded and saved on a PC. After five minutes equilibration period to reach stable baseline temperature at the fingertip, the blood pressure cuff was inflated. Initially it was planned for the cuff to be inflated to 50 mm Hg over supra-systolic BP, however, the inflation pressure was later standardized to 200 mm Hg. The temperature was continuously recorded throughout the experiment. (Five minutes before occlusion and up to three minutes deflation).

[0437] BAUS was performed following a standard protocol similar to that described previously (Corretti, M. C., et al., *J. Am Coll Cardiol* 39(2) (2002) 257-65). Longitudinal brachial artery images were taken with a high resolution (14 MHz) linear array vascular ultrasound scanning transducer (Vivid 7/Vivid 7 PRO, GE Medical Systems). Subjects were studied under ambient conditions while in the supine position in a temperature-controlled room. After a five minute equilibration period to reach stable baseline temperature at the fingertip, two baseline images of the brachial artery were obtained approximately 4-5 cm above the antecubital fossa. A blood pressure cuff (Hokanson, Bellevue, Wash.) placed proximal to the imaging transducer on the upper arm was inflated to 200 mm Hg for about 4 minutes. Brachial artery diameter was measured at four adjacent points and an average measurement was used for analysis. Peak Systolic Velocity (PSV) using pulse wave Doppler measurements were obtained at baseline, before inflation and immediately after deflation. Brachial artery dimensions were measured at 30, 60, 90, 120 and 180 seconds post-deflation.

[0438] Descriptive tables including central and peripheral statistical measures were created based on information obtained from twenty six cases. Multiple parameters were measured from each test (BAUS and DTM). Student t-Test



and Pearson correlation test were used to compare and correlate numerical measurements.

[0439] The average age of 26 subjects (eleven male) was 42 years (SD 13.21) with a Body Mass Index (BMI) of 25.6 (SD 4.56). Four participants had risk factors including hypertension, hyperlipidemia and family history of premature coronary artery disease. However, due to very small sample size no sub-group analysis could be made.

[0440] FIG. 21 shows a representative graph of temperature changes at the fingertip during brachial artery hyperemia induced by cuff inflation. As seen in the graph multiple parameters were defined as following: TF ( $T_F$ ) denotes fall of temperature from baseline to nadir. TTF ( $T_{TF}$ ) denotes time to reach the maximum TF. TR ( $T_R$ ) denotes rebound of temperature above the baseline. TTR ( $T_{TR}$ ) represents time to reach  $T_R$ . NP ( $N_P$ ) denotes temperature changes from nadir to peak. All temperature readings were in Fahrenheit and time measurement was in seconds.

[0441] The cumulative results showed mean values of TF, TR, and NP were  $2.50 \pm 1.03$ ,  $1.10 \pm 3.05$ , and  $3.60 \pm 2.84^\circ F$ , respectively. Mean TTR was  $114 \pm 40$  seconds. Mean changes in BAD and PSV were  $12.5 \pm 10.1\%$  and  $109 \pm 10\%$ , respectively. TR was negative in 10 cases,  $-4.78$  to  $-0.05$  (mean  $-1.08$ , SD  $-1.39$ ) and NP was negative in one case (case no 7 discussed as outlier). There was a significant difference in average TR and NP between males (TR  $0.76 \pm 1.93$ , NP  $3.44 \pm 1.64$ ) and females (TR  $1.43 \pm 3.70$ , NP  $3.64 \pm 3.64$ ). TF in males was  $2.78 \pm 0.90$  and in females was  $2.16 \pm 1.01$ . Also a correlation analysis between TR, NP, and TF with age and BMI showed a significant trend towards lower TR and NP but higher TF with increasing age. TTF and TTR were  $237 \pm 120$  and  $114 \pm 40$  respectively. Inflation time (TTF) varied due to the tolerance factor of each subject.

[0442] As previously mentioned, the change in BAD correlated with TR ( $r=0.73$  as depicted in FIG. 29), NP ( $r=0.74$  as depicted in FIG. 30), age ( $r=-0.23$ ) and BMI ( $r=-0.43$ ). Males showed significantly lower TR (0.76 vs. 1.43) and less increase in BAD (12.35 vs. 15.09) than females. All p values were less than 0.05. Mean change in PSV was  $109 \pm 10\%$ . FIG. 44b shows the distribution of percentage changes in brachial artery diameter measured by USVR. An average change of 12.50% (SD=10.10%) was recorded. The changes varied from  $-22.22\%$  to 41.37%. Such a relationship was not seen between the diameter changes and TF ( $R=0.1252$ ) indicating that the strong correlation seen between the diameter changes and temperature changes is only related to the reactivity of the artery that occur after the deflation. For distribution of change in peak systolic velocity before inflation and immediately after deflation, an average change of 109% (SD=10%) was seen. The changes varied from 46% to 260%. There was a weak inverse correlation ( $R=0.3244$ ) seen between changes in peak systolic velocity and percentage changes in brachial artery diameter. As expected, there was no correlation seen between changes in peak systolic velocity changes and changes in TF, TR, and NP. Males showed significantly lower TR (0.76 vs. 1.43) and less increase in BAD (12.35 vs. 15.09) than females. All p values were less than 0.05.

[0443] As seen in FIG. 44a, case number 7 presented a severe vasoconstrictive response to cuff inflation and deflation. Both BAUS and DTM findings showed negative values for BAD ( $-22\%$ ), TR ( $-4.78 F$ ), and NP ( $-3.24 F$ ). The

subject was a 29 year old female (BMI 20.02) with no documented risk factors. Data was analyzed with and without the outlier. Removal of the outlier did not have a significant change on TR and BAD correlation.

[0444] In conclusion in this study in 26 healthy looking volunteers, the novel and simplified method of the invention for assessment of endothelial function and vascular reactivity in the arm was evaluated and compared with the traditional method endothelial function measurement in the brachial artery. Temperature changes at the fingertip showed a consistent pattern throughout the study as illustrated in the FIG. 21. The pattern starts with an initial fall (TF) during the cuff inflation followed by a rebound (TR and NP). The measurements show the fact that skin blood flow can be measured by monitoring temperature, and change in blood flow strongly correlates with change in temperature. In the study, TF shows lack of blood circulation while the cuff is inflated that also affects local metabolism and heat production. The overall effect is a gradual decline in fingertip temperature at a rate of 0.5-2 degree F. per minute in normal room temperature.

[0445] TR and NP indicate the hyperemia induced brachial artery dilation as well as the vasodilatory capacity of the vascular bed (small arteries and microvessels) distal to the cuff. TR specifically denotes the ability of the arterial bed to compensate for the duration of the ischemia and to create an overflow above the baseline level. In normal conditions one would expect a positive TR. The higher the TR, the higher the vasodilatory response of the arterial bed. TR close to zero indicates a lack of strong vasodilatory response and in case of negative TR it must represent a vasospastic response or a complete lack of vasodilation. NP and TR largely overlap and both show similar information with TR being more sensitive marker of overflow.

[0446] In the comparison of BAUS and DTM, the percentage change in brachial artery diameter (BAD) correlated well with TR ( $r=0.73$ ) and NP ( $r=0.74$ ) as expected. Time to reach maximum TR (TTR) was approximately two minutes (Mean  $114 \pm 40$  seconds) and lasts for 1-2 minutes. This clearly explains the close correlation between temperature changes and changes in BAD which is also well known to max after the first minute. In the study, both showed a delayed response starting in about 30 seconds after deflating the cuff. In contrast, changes in peak systolic velocity (an indicator of distal resistance) did not correlate with TR or NP ( $r=0.07$ ) suggesting that TR and NP may not represent microcapillary and resistant vessels, instead they best correlated with changes in BAD as a conduit artery. The significance of measuring vasoreactivity of resistance vessels (microvascular) vs conduit vessels (macrovascular) lies in the underlying physiology of the response. It is thought that changes in BAD as a conduit artery purely reflects the function of endothelial cells at brachial artery level whereas Distal Resistant Vessel Response (PSV) reflects the vascular tone in arterioles and microvessels which are largely controlled by neurogenic mechanisms through media layer. The latter is also called endothelial-independent vasoreactivity and can be measured by vasodilating agents that directly affect smooth muscle cells (nitrates).

[0447] Contemplating the relationship between BAD and PSV (Brachial Response vs Distal Resistant Vessel Response), PSV is a known measure of distal vascular



resistance. In this study, a weak correlation was found between PSV and BAD ( $r=0.32$ ). Poor correlation between BAD and PSV is known and was reported previously by others. In our study we did not find any significant correlation between TR or NP and PSV. One explanation would be that the vasoreactivity response measured by TR and NP are most related to BAD changes and least related to PSV. PSV increased in 100% of the cases which can be easily explained by Bernoulli's law. The temperature changes are more likely to reflect the response of conduit arteries (i.e. brachial, radial, ulnar) than resistant vessels (arterioles and microvessels).

[0448] This analysis showed no correlation between TF or TTF and BAD, TR, NP, or PSV, indicating that within the range of cuff inflation time used in our study, the longer inflation and ischemia time did not result in higher reactivity. In our study the average inflation time TTF was  $237\pm 120$  seconds. The variation was permitted according to subject's comfort level. In cases of long inflation time, one would expect higher TF and higher PSV and possibly higher BAD. However such a long TTF cannot be easily tolerated.

[0449] Skin microcirculation is divided into nutritional circulation and thermoregulatory circulation. It is well known that the thermoregulatory circulation that accounts for the majority of fingertip skin circulation is tightly controlled by autonomic nervous system. The thermoregulatory control mechanism is effected through arteriovenous shunts that bypass pre-capillary part of the side to the post-capillary of venous side. These networks of small arterioles are highly innervated and in cases of sympathetic stimuli such as mental stress and cold exposure, their contraction increase distal resistance and results in rerouting blood flow to AV shunts. This phenomenon explains cold fingers in fingertips during adrenergic stress. The side effect of this phenomenon on digital thermal monitoring of vascular reactivity (DTM) can be significant. However, such a "noise" effect is not limited to digital thermography. Indeed, studies have shown that BAUS is similarly affected by such sympathetic conditions. To minimize the effects of these conditions on endothelial function measurement, the International Task Force for Brachial Artery Reactivity has proposed certain guidelines for subject preparation and BAUS measurement to standardize the technique. Similar considerations can be exercised for DTM. However, the fact that this technique is much more simplified and can be repeated easily (potentially at the comfort home and ambulatory monitoring), makes it possible to have a more accurate assessment of endothelial function in those with hyperadrenergic conditions.

[0450] Importantly, significant temperature changes in control arms were found in some individuals that may reflect the neuroregulatory response to the cuff inflation and deflation. A consistent pattern in the temperature changes of the contralateral finger was not found, although most TR and some TF responses were negative in the contralateral finger. This contralateral vasomotion is believed to show the neurogenic factors involved in the arm-cuff based vascular reactivity test and provides, for the first time, the ability to provide characterization of this influence in different individuals.

[0451] Physiologic stimuli such as local pain, pressure, and ischemia are known to create systemic effects mostly

mediated by autonomic (sympathetic and parasympathic) nervous system. DTM provides a mechanism to correlate primary and secondary autonomic disorders shown by heart rate variability, and orthostatic hypo and hyper-tension in coronary heart disease and a host of other disorders, with the thermal behavior of contralateral finger.

[0452] Blood pressure measurement, which can be subject to high variability and White Coat effect, has evolved over time into ambulatory monitoring including use outside of the hospital. Similarly, measurement of brachial vasoreactivity, including as measured by DTM, may show marked variations including diurnal, postprandial, positional, exercise and stress related variability. Solutions to control for variability issues include multiple measurements and standardized settings for measurement. A requirement for multiple measurements cannot be met by BAUS, which is a very complicated, cumbersome and expensive measurement. In contrast, DTM has great potential to provide an endothelial function measurement device capable of ambulatory monitoring. Such a device, including combined with blood pressure monitoring device, can provide an excellent tool for screening and monitoring of vascular function at minimum cost. In addition, skin temperature monitoring with vascular challenge can measure endothelial function in multiple vascular beds (e.g. wrist, arm, thigh, calf) to make a more comprehensive assessment of total body vascular health.

Skin Temperature and Vascular, Metabolic and Neuroregulatory Function

[0453] In one embodiment of the invention, changes in skin temperature before, during, and after an ischemia challenge are measured and related to the underlying vascular, metabolic, and neuroregulatory functions of the tissues. In one embodiment, repeated measurement of the temperature response as well as testing temperature responses in multiple vascular beds including the arm, forearm, wrist, and both legs provides a more comprehensive assessment. For example, the aforementioned AV shunts in digital capillaries can affect distal microvessel resistance and therefore the flow measurement or response to ischemic challenge can vary depending on the opening of these AV shunts as a consequence of sympathetic drive. One way to measure the AV shunt effect is to simultaneously measure temperature at the distal finger tips as well as proximal to the finger tip such as on the wrist or forearm. By comparing temperature changes in these two locations, one can create a differential signature plot that indicates the activity of the sympathetic nervous system and/or AV shunting.

[0454] In one embodiment, measurements on the contralateral hand to that receiving a vascular challenge are used to establish a vascular, metabolic, and neuroregulatory profile for the patient. The present inventors have surprisingly found that, rather than being considered as "noise" to be discounted or controlled, in certain embodiments of the present invention, measurement of skin temperature on the contralateral hand is utilized to provide important insights into the vascular reactivity profile of the individual. In contrast to the test hand to which a vascular challenge is applied, for example by occlusion of the brachial artery feeding the test hand, the contralateral hand is also monitored by a fingertip temperature measurement on the corresponding digit of the contralateral hand but without vascular



challenge to the vasculature feeding the contralateral hand. Since 85% of skin circulation is thermoregulatory and tightly controlled by the sympathetic system, changes in the contralateral finger temperature can be quite diagnostic. In some individuals the temperature of contralateral fingers goes up in the inflation phase while in other individuals the temperature of the contralateral finger declines in the deflation phase. In some patients, the contralateral finger temperature goes up in the inflation phase and declines in the deflation phase. The contralateral finger response reflects both the activity of the sympathetic nervous system but also the ability of both the nervous system and the vasculature to work together to respond appropriately to vascular challenge.

[0455] In certain embodiments, DTM is combined with other modalities for assessing neurovascular regulation including the cold pressor test, and the tilt test. In one method of measuring vascular reactivity and endothelial function, DTM is employed together with the cold pressor test in any other place in the body that does not affect the thermal measurement. In preferred embodiments, the contralateral hand or foot is exposed to cold such as by emersion in cold water for 1-5 minutes, ordinarily sufficient to stimulate a significant vascular response. In normal subjects, the reaction is vasodilation of vessels which would result in increased fingertip temperature in the hand not exposed to the cold challenge but in patients with cardiovascular risk factors, this effect is hampered and the dilation may be replaced with constriction. In alternative or additional embodiments, DTM is employed together with a tilt test, which tests the effect of the body's position in temperature changes at the fingertip. It is expected that those with high sympathetic response or increased vasoreactivity will show different temperature changes compared to normal subjects. In certain subjects with extreme vasoreactivity, a significant drop in finger temperature may be manifest as a consequence of the tilt test.

[0456] This technology and multiple embodiments of the device disclosed herein for thermal monitoring can be used for numerous, physiologic measurement as well as health and disease monitoring applications. Such applications include monitoring of fingertip skin temperature in response to hyperemia for Obesity Management (predicting regaining weight). Obese people may have lower basal metabolic rate that can create different temperature response during the test. For example, lower heat production can be seen as higher TF. Higher burning rate can be seen as lower TF (given other factors constant) which is associated with lack of blood supply and oxygen.

[0457] It is well known that tissue temperature is a direct result of blood perfusion, but other parameters also contribute. These parameters can be classified as:

[0458] 1) Anthropometric factors, such as tissue composition, skin thickness, fat content, surface area, tissue volume, body mass index, age and gender, among others.

[0459] 2) Environmental factors, ambient temperature, the presence of air currents, unequal radiation, air humidity and posture.

[0460] 3) Hemodynamic factors, due to the presence of large proximal conduit arteries and small vessels and

capillaries, which respond differently to occlusion and reperfusion, and have different contributions to tissue temperature.

[0461] 4) Physiological factors, i.e. body temperature, skin temperature, tissue metabolism, response of conduit vessel diameter to hypoxia and ischemia, microvasculature response, and the activation of arteriovenous anastomoses.

Different embodiments of this invention characterize and quantify the effect of different factors that affect the baseline temperature and temperature response observed after brachial artery occlusion.

[0462] In one embodiment, monitoring of fingertip skin temperature in response to hyperemia (DTM) is used to screen for hypersympathetic patients. The microvessel resistant component of the DTM measurement can be extreme in certain subjects and analysis of DTM results will identify these subjects. Hypersympathetic subjects can be distinguished based on their vasospastic response and severe drop in temperature and reduced TR response.

[0463] In one embodiment, DTM is used for screening for smooth muscle cell dysfunction (SMC). The variables of slope versus rebound level are analyzed to discriminate between endothelial dysfunction, which is a hallmark of atherosclerosis, and medial dysfunction, which is a hallmark of hypertension.

[0464] In one embodiment, Blood Pressure monitoring (BP) is combined with DTM. The combination of BP and DTM is particularly suitable for the management of hypertension. DTM and BP measurement are facilitated by an integrated device that provides monitoring of blood pressure in conjunction with a pressure cuff used to provide vascular occlusion as part of a DTM measurement. In one embodiment the BP aspect of the combined device relies on conventional oscillometric measurement of blood pressure. In an alternate embodiment, blood pressure measurement is implemented by measuring radial artery waveforms to calculate systolic, diastolic and mean pressures. Using different ischemia challenge protocols, one can distinguish between different stages of hypertensive vascular disease. Subjects in later stages of the disease whose vasodilatory capacity is severely reduced may show lower TR. Longer duration of ischemia may distinguish this group with the earlier stages of hypertension where the vasodilatory capacity is relatively high. In another embodiment, DTM and/or combinations of DTM and glucose monitoring is employed for management of diabetes. As with hypertension, using different ischemia challenge protocols, one can distinguish between different stages of diabetic vascular disease. However, in diabetic patients a reduced vasodilatory reservoir of the vascular system may be expected. In both cases, DTM can provide useful information about the status of the disease and repeated measurements can provide insights into trends.

Using Vascular Reactivity as Indicator of Cardiovascular Health

[0465] Having determined that Digital Thermal Monitoring (DTM) during reactive hyperemia provides a novel non-invasive, non-imaging method having the potential to aid in the assessment of peripheral vascular function and to predict clinically unapparent coronary heart disease (CHD), DTM was compared in a cohort of individuals against



history of CHD and against Framingham 10-year Risk Score or Estimation (FRS). A sensitive screening test for early atherosclerotic vascular disease should correlate with the magnitude of Framingham Risk Estimates, and should predict CHD vs. absence of CHD. However, Framingham risk estimates are not intended to predict presence of CHD but risk of future CHD events based on population studies. The Framingham Heart Study risk algorithm encompasses only coronary heart disease, not other heart and vascular diseases and was based on a study population that was almost all Caucasian. Wilson PWF, et al. "Prediction of coronary heart disease using risk factor categories" *Circulation* 97 (1998) 1837-1847. In addition, the Framingham Risk Score is heavily weighted by age and sex and thus has low predictive value for individuals under 55 and for women. Nonetheless, a more than 20% 10-year estimated risk is regarded as CHD-equivalent. It is noted that new guidelines consider diabetes as a CHD equivalent. An incremental predictive value over FRS for CHD would suggest a complementary or alternative clinical utility and provided an impetus for the study.

[0466] Methods and Study Conditions: 133 subjects (51% male, average age 54, including 19 with known CAD) completed a medical questionnaire and underwent DTM during reactive hyperemia using 2 minute cuff occlusion.

[0467] In order to optimize accurate measurement of vascular response to the test, at least 12 hr prior to the test all vasoactive medications are withdrawn. Similarly other non-drug vasoactive compounds such as caffeine, alcohol, exposure to cold weather, urinary urgency or full bladder, physical or mental exercise, and all other factors that may temporarily affect vascular function were controlled.

Study population	133
CVD (y/n)	(19/114)
Sex (m/f)	(67/66)
Age (yrs)	54 ± 10
Body Mass Index (BMI)	25.6 ± 4.56
Hypertension	33
Hyperlipidemia	24
Diabetes	14
Active Smoker	7
Family History of Heart Attack	59

[0468] A VENDYS vascular reactivity experimental procedure was conducted as follows:

Step	
1)	Attach the thermistor to the distal palmar pad of the middle finger of the hand, and tape it.
2)	Allow the initial temperature before the occlusion is started to stabilize for at least 2 minutes.
3)	Then start the occlusion of the blood by placing the blood pressure cuff on the arm at about 200 mm of Hg.
4)	Note the temperature continuously right from the stabilization of the temperature. Keep the occlusion for about 5 minutes.
5)	Then suddenly release the occlusion after 5 minutes and keep on monitoring the increase in the temperature of the finger for about another 3 minutes.
6)	Plot the readings of the temperature against the time and do the further analysis from the curve obtained.

-continued

Step	
7)	The results were compared with other markers of cardiovascular health including the presence of known existing cardiovascular disease and the Framingham Risk Score.

[0469] The Framingham Risk Score (FRS) is a coronary prediction algorithm that seeks to provide an estimate of total CHD risk (risk of developing one of the following: angina pectoris, myocardial infarction, or coronary disease death) over the course of 10 years. Separate score sheets are used for men and women and the factors used to estimate risk include age, total blood cholesterol, HDL cholesterol, blood pressure, cigarette smoking, and diabetes mellitus. Relative risk for CHD is estimated by comparison to low risk Framingham participants of the same age, optimal blood pressure, total cholesterol 160-199 mg/dL, HDL cholesterol 45 mg/dL for men or 55 mg/dL for women, non-smoker and no diabetes. In the present study, to exclude any bias from the influence of diabetes, comparisons between VENDYS parameters and Framingham risk estimates were conducted with diabetes counted as a risk factor for CHD, and separately with diabetes considered as a Coronary Heart Disease (CHD)-equivalent condition.

[0470] For the present study, sitting blood pressure was recorded in the left arm before DTM testing, using an Omron HEM 705 CP semi-automated sphygmomanometer (Omron Healthcare, Inc., Bannockburn, Ill., USA). Digital thermal measurement (DTM) was carried using a VENDYS 5000BC™ DTM system (Endothelix, Inc., Houston, Tex., USA). The device comprises a computer-based thermometry system (0.01° F. thermal resolution) designed and implemented as disclosed herein and including two fingertip thermocouple probes, coupled to a PC. The experimental protocol and data collection are controlled by software implementing the steps of FIG. 5. The probes are designed to minimize the area of skin-probe contact, pressure on fingertip, and drift in the baseline temperature. A standard sphygmomanometer cuff and compressor permits controlled occlusion-hyperemia.

[0471] Subjects fasted overnight and refrained from smoking, alcohol or caffeine ingestion and use of any vasoactive medications on the day of the testing. Subjects remained seated, with the forearms supported at knee level. VENDYS™ DTM probes (Endothelix, Inc., Houston, Tex., USA) were affixed to the index finger of each hand. After a period of stabilization of basal skin temperature, the right upper arm cuff was rapidly inflated to 200 mmHg for 2 minutes, and then rapidly deflated to invoke reactive hyperemia distally. Temperature was measured in both fingers throughout the protocol, until approximately three minutes after cuff deflation. DTM was performed according to an automated operator-independent protocol.

[0472] Whole blood was analyzed for Total Cholesterol, LDL-Cholesterol, Triglycerides and HDL-Cholesterol by Cardiocheck.



[0473] The following primary parameters were calculated:

Measures reflecting the ischemic stimulus/thermal debt	
TS	Starting fingertip temperature
Tmin (=Nadir (N))	Lowest temperature observed after cuff inflation
TF	(Temperature Fall) = TS - Tmin
TTF	Time from cuff release to TF
Parameters reflecting thermal recovery/vascular reactivity	
Tmax	Highest temperature observed after cuff deflation
TR	Tmax - TS; temperature recovery/rebound
NP	(Nadir-to-Peak) = Tmax - Tmin
TTR	Time from cuff release to TR
Slope	NP/(TTR - TTF)
AUC	Area under temperature-time curve at various time points
Additional DTM parameters of thermal debt and recovery referenced to start temperature (TS)	
TF %	(TF/TS) × 100
TR %	(TR/TS) × 100
Tmax %	(Tmax/TS) × 100
NP %	(NP/TS) × 100
Slope %	NP %/TTR

[0474] Normalizing VENDYS Indices—“Relative” Values (percentage change): Because fingertip start temperature varies between individuals, and the DTM technology is based on monitoring changes in temperature, all absolute values were transformed to relative values. For example: Relative TR (TR %)=(TR/TS)×100.

[0475] Results: The variables of temperature fall from baseline ( $T_F$ ), time to temperature fall ( $T_{TF}$ ), repayment slope  $S_R$  (1810), time to temperature rebound ( $T_{TR}$ ), rebound temperature over baseline ( $T_R$ ) and the nadir to peak temperature ( $T_{NP}$ ) as generally depicted in FIG. 13 were analyzed for the study participants. The results were subject to statistical analysis. As shown below, the variables of  $T_R$ ,  $T_{NP}$  and  $S_R$  showed the difference between the CVD patients and of the patients not having evidence of CVD was highly significant. DTM discriminated between CHD and non-CHD subjects more than FRE, particularly in women and in those  $\leq 55$  yrs. In Receiver Operating Characteristic (ROC) analysis, with CHD as the response variable, Area Under the Curve (AUC) for FRE, TR %, and slope % were 0.60, 0.71, and 0.73, respectively ( $p < 0.01$ ).

Variable	CVD = Yes (N = 19)	CVD = No (N = 114)	T-test (p-value)
	Mean ± STD	Mean ± STD	
$T_F$ (c)	1.19 ± 0.63	1.20 ± 0.53	0.996
$T_R$ (c)	0.34 ± 0.38	0.89 ± 0.92	0.0003
$T_{NP}$ (c)	1.53 ± 0.51	2.08 ± 0.90	0.0005
$S_R$ (c/min)	0.62 ± 0.36	0.93 ± 0.45	0.006
$T_{TF}$ (min)	2.83 ± 1.52	2.30 ± 0.3	0.218
$T_{TR}$ (min)	2.95 ± 1.45	2.47 ± 0.92	0.196

[0476] DTM parameters, corrected for starting skin temperature (TS), (post-occlusion temperature recovery, TR %, nadir-to-peak temperature gain (NP %) and slope of recovery %) were lower in subjects reporting CHD (2 tailed p values 0.006 or less). As depicted in FIGS. 47 a and b, DTM discriminated between CHD and non-CHD subjects more than FRS, particularly in women and in those  $\leq 55$  yrs. In

univariate Receiver Operating Characteristic Curve (ROC) analysis, with CHD as the response variable was conducted. ROC Curves plot the true positive rate against the false positive rate for the different possible cut points of a diagnostic test. ROC analysis shows the tradeoff between sensitivity and specificity (any increase in sensitivity will be accompanied by a decrease in specificity). The closer the curve follows the left-hand border and then the top border of the ROC space, the more accurate the test. FIG. 45 depicts ROC curve analysis comparing NP, TR and Slope values obtained by DTM testing with that of Framington Risk Scoring for the study population.

[0477] The accuracy of a given test depends on how well the test separates the group being tested into those with and without the disease in question. One measure of accuracy is determined by an Area Under ROC curve (AUC) analysis. A value of 0.90-1=excellent (A); 0.80-0.90=good (B); 0.70-0.80=fair (C); 0.60-0.70=poor (D) and 0.50-0.60=fair (F). AUC analysis for FRS, TR %, NP %, slope % and Tmax % gave values of 0.60, 0.71, 0.69, 0.73, and 0.71 respectively. Combining TR % with FRS increased the AUC to 0.794. Thus, DTM complemented FRS in distinguishing between cohorts with and without self-reported CHD and represents a new biomarker for inapparent CHD, particularly in women and in younger individuals.

[0478] As the data shows in FIG. 46b, the TR and NP DTM values easily discriminated healthy individuals from CHD patients. In contrast, in this study FRS only marginally discriminated CHD from non-CHD as the data shows in FIG. 46a. Importantly, and as shown in FIG. 48, unlike FRS, DTM is able to identify CHD in females and young (<55 yrs) populations.

[0479] Furthermore, as shown in FIG. 47b, the TR value of DTM showed highly significant differences from non-diabetics with a P of 0.0055.

[0480] Indeed and as depicted in the data analysis of FIG. 47a, TR values obtained by DTM from this cohort revealed a graded relationship between Framingham risk, this trend having a P=0.0029. In sum, DTM was shown to be better than blood pressure and lipid profile in correlating with heart disease. If not better than FRS in detection of CHD, DTM provides a complement FRS. Also, DTM can be used to differentiate a very high risk group (with CCS>90<sup>th</sup> percentile) from those with CCS=0 and or those with CCS=0 & no risk factors. Importantly, in contrast to FRS which is solely a population based risk predictor, DTM provides information on individuals. A combination of FRS and DTM provides more information than each alone, and provides a favorable combination.

#### Correlation with Coronary Angiography

[0481] Endothelial dysfunction (ED) precedes and predicts coronary heart disease. The present inventors hypothesized that impaired vascular reactivity (a surrogate of endothelial dysfunction) detected by a digital thermal monitoring (DTM) device, which measures temperature changes at the fingertip during a reactive hyperemia test, can predict angiographically significant coronary artery disease (CAD).

[0482] Methods: 153 patients were studied: 118 undergoing coronary angiography and 35 noncardiac age-matched controls. A DTM device (VENDYS™) was used to measure vascular reactivity and endothelial function during a



2-minute suprasystolic cuff inflation and subsequent 3-minute cuff deflation procedure. Coronary angiography defined significant CAD as >1 major vessel with >50% stenosis.

[0483] Results: AS depicted in FIG. 49a, of 118 who underwent coronary angiography, 99 had significant CAD and 19 had <50% stenosis. After adjustment for traditional risk factors of coronary heart disease, temperature rebound (TR) measured by VENDYS™ independently detected patients with significant CAD (P=0.007). See Figure.

[0484] Conclusions: DTM, a non-invasive, non-imaging, inexpensive, bedside test, significantly correlated with invasive coronary angiography for the detection of coronary artery disease. Further studies are needed to evaluate the clinical utility of this novel method to improve existing risk stratification.

Normalization of Values:

[0485] In one embodiment, the value of  $T_R$  is normalized using thermodynamic equations for calculating heat flow based on the following parameters in reference to FIG. 21: baseline temperature **1802**, fall temperature change  $T_F$ , ambient room temperature, core temperature, tissue heat capacity, tissue metabolism rate, tissue heat conduction, the mass of the testing volume, the location the method is conducted, blood flow rate, the position of the subject **10** during the method, and a variety of other physical and/or physiological factors that may effect the value of  $T_R$ . In an experimental embodiment of the method **500** described above with respect to FIG. 8, an ambient temperature of 22 degrees C. was measured. A first subject was tested and found to have a baseline temperature of 35 degrees C., a  $T_F$  of 2 degrees C. and a  $T_R$  of 0.5 degrees. A subject like first subject has a baseline temperature which is significantly greater than the ambient temperature, and it is expected that such a subject will experience a higher than normal  $T_F$  and a lower than normal  $T_R$ . Furthermore, a subject having a baseline temperature which is significantly greater than the subject's core temperature is expected to experience a higher than normal  $T_F$  and a lower than normal  $T_R$ . A second subject was tested and found to have a baseline temperature of 25 degrees C., a  $T_F$  of 1 degrees C. and a  $T_R$  of 3 degrees. A subject like second subject has a baseline temperature which is close to the ambient temperature, and it is expected that such a subject will experience a lower than normal  $T_F$  and a higher than normal  $T_R$ . Furthermore, a subject having a baseline temperature which is close to the subject's core temperature is expected to experience a lower than normal  $T_F$  and a higher than normal  $T_R$ .

[0486] In addition to differences between individuals, it has been observed that in a given individual, if tested on different occasions, may have "intra-individual" variability in measurements of vascular reactivity. This is similar to blood pressure variability where is well recognized that measurement of brachial vasoreactivity may show marked variations including diurnal, postprandial, and positional variability. In addition, other variables including for example, ambient temperature and recent exercise or anxiety may influence results. For example, a subject having a baseline temperature which is significantly greater than the room temperature, as depicted in FIG. 49b, is expected to experience a higher than normal  $T_F$  and a lower than normal  $T_R$ . On another occasion the same subject will be found to

have a low baseline temperature such as for example 25 degrees C., a  $T_F$  of 1 degree C. and a  $T_R$  of 3 degrees. In this second instance the subject has a baseline temperature which is close to the ambient temperature, and it is expected that the subject will experience a lower than normal  $T_F$  and a higher than normal  $T_R$ . Certain of these variables can be controlled by multiple measurements and standardized settings for measurement.

[0487] However, even though vascular reactivity graphs obtained by measuring the temperature of a finger before, during and after vasostimulation by cuff occlusion may appear grossly different as can be seen in FIG. 23 and 24, the overall pattern of the response, i.e. the slope of the repayment curve ( $S_R$ ) and whether or not the rebound temperature exceeds baseline, will be characteristic of the individual's vascular reactivity and health. In one embodiment of the invention, individual variability is normalized mathematically.

Multiple Measurements

[0488] Similar to blood pressure measurements, endothelial function and vascular reactivity are highly variable physiologic parameters. Multiple measurements and averaging of such variables are expected to provide a more accurate assessment. For example, as shown in table . . . three measurements in an individual can help categorize vascular reactivity in three groups, reactive, moderately reactive, and poorly reactive.

Based on 3 measurements	Reactive >90 <sup>th</sup> %	Moderately Reactive	Poorly Reactive <10 <sup>th</sup> %
Reactive	+++		
	++	+	
	++		+
(ReTest)	+	+	+
Moderately Reactive		+++	
	+	++	
		++	+
(ReTest)	+	+	+
Poorly Reactive			+++
		+	++
	+		++
(ReTest)	+	+	+

Thermodoppler:

[0489] Methods and apparatus for comprehensive assessment of vascular function are provided by combining temperature changes with changes in peak systolic Doppler velocity measurement by Doppler ultrasonography. This combination of thermography and Doppler ultrasonography is herein termed "thermodoppler." For example, and with an apparatus such as that as depicted in FIG. 31, shown in place in FIG. 32c, the radial artery can be placed under continuous Doppler measurement together with fingertip or palm thermal monitoring before and after cuff occlusion test. In one embodiment, the probe is bidirectional Doppler probe **1902** which is placed over the radial artery and held in place by any number of attachments known in the art, including adhesives or, for example, a wrist band **1904**. Doppler data as seen in FIG. 32d is obtained by continuous monitoring of peak systolic Doppler velocity decreases after occlusion from its maximum immediately after release of the cuff (cuff



deflation) and declining over time to base velocity before occlusion. This response inversely correlates with distal vascular resistance. Immediately after releasing the cuff, resistance is minimum. Upon perfusion the resistance increases back to baseline resistance. The speed of return to baseline resistance, the area **2011** under the produced curve as well as the slope, can be used to study the function of the resistant vasculature. Decreased vasodilative capacity (microvessels resume resistance quickly) after occlusion is indicative of inability of the vasculature to remain dilated and maintain high blood perfusion.

[0490] The Doppler pulse velocity curve can be used as a non-invasive correlate of metabolic and biochemical factors affecting the distal microvascular resistance (e.g. lactate concentration, pH, calcium ion, etc. In summation, the curve can be calibrated to study, non-invasively, factors affecting vascular health.

#### Comprehensive Measures of Vascular Health, Including Both Macrovascular and Microvascular Analysis

[0491] In one embodiment of the present invention, methods and apparatus for determining and comparing the microvascular and the macrovascular response of an individual are provided. As depicted figuratively in FIG. **51b**, a comprehensive assessment of vascular health includes at three components: functional status of the individual, risk factor assessment based on epidemiologic studies, and structural studies of the individual. The present invention contributes new non-invasive methods and apparatus for functional assessment as well as important combinations of the functional assessment with risk factor and structural analysis.

[0492] Functional assessment in accordance with an embodiment of the invention includes three compartments: the microvasculature, the macrovasculature and the neurovasculature. The macrovasculature is composed of large and relatively large conduit vessels, such as for example in the arms, the brachial and radial arteries. The microvasculature is made up of resistance vessels, the arterioles and capillaries. The microvasculature is strongly influenced by the neurovascular system. As shown in FIG. **51a**, in accordance with an embodiment of the invention, an individual's baseline functional status is determined by measuring blood pressure, which is influenced by both the microvasculature and the neurovasculature.

[0493] Digital thermal monitoring has been determined by the present inventors to provide a powerful measure of neuroreactivity. It has been surprisingly found that when a vascular challenge is applied to a target body such as an arm, the corresponding contralateral remote body reacts as instructed by the neurovasculature. Thus, if blood is occluded from a right arm (target body), a normal neurovasculature senses the need for greater perfusion and directs increased blood flow in the contralateral left arm (remote body). If the individual has a healthy microvasculature, the neurovascular instruction to increase blood flow is effective to induce vasodilation in the contralateral microvasculature and an increase blood flow. This increase in blood flow can be detected by instrumentalities including for example with a thermocouple, thermister, resistance temperature detector, heat flux detector, liquid crystal sensor, thermopile, or an infrared sensor. Increased blood flow in the contralateral remote body part can also be detected by skin color, nail

capilloroscopy, fingertip plethysmography, oxygen saturation change, laser Doppler, near-infrared spectroscopy measurement, and peripheral arterial tonometry.

[0494] In accordance with an embodiment of the invention, baseline functional status of the macrovasculature is determined using Pulse Wave Velocity (PWV) and/or Pulse Wave Flow (PWF) analysis.

[0495] As shown in FIG. **51a**, functional assessment of reactive capacity for the individual is determined using Pulse Wave Velocity (PWV) and/or Pulse Wave Flow (PWF) analysis for the macrovasculature after challenge, such as with a chemical or physical vasostimulant. The functional capacity of the microvasculature is determined using Doppler Flow Velocity (DFV) and/or Digital Thermal Monitoring (DTM) subsequent to vascular challenge.

#### Infrared Imaging

[0496] In one embodiment of the invention, infrared imaging is used for thermographic assessment of endothelial dysfunction. Temperatures before, during, and after vasostimulation, such as may be provided by cuff occlusion, are measured by infrared camera. Infrared (IR) thermography is employed to study vascular health before, during, and after a direct vascular stimulant such as nitrate or cuff occlusion. For example, infrared imaging of both hands or feet during cuff occlusion test (before cuff occlusion, during and post occlusion) using infrared thermography results in a comprehensive vascular and neurovascular assessment of vascular response in both hands or feet. FIG. **52** depicts the results of IR thermography of two hands of the same individual where the brachial artery is occluded by an inflated blood pressure cuff on the individual's right arm. In this application, quantitative measurements of temperature changes are generated by numerical analysis of each depth of color in the image. The technique typically utilizes a color map of the thermal image as shown in FIG. **52**.

[0497] In one embodiment, IR thermography is used to assess the condition of a diabetic foot including an assessment of vascular function and reactivity in diabetic patients who are at risk developing foot ulcers or "diabetic foot" as a consequence of vascular disturbances and severely compromised perfusion or ischemia of the foot. Heterogeneity in skin perfusion and vascular health can be seen. The technique can also be used to indicate development of diabetic neuropathy.

[0498] Baseline imaging of the feet of a diabetic patient is performed. Imaging is performed after administration of nitrite/nitrate compound e.g. nitroglyceride (NTG). Point IR measurement of temperature such as aural thermography can be used for assessment of total body vascular response to vascular stimulant such as nitrate. In such cases a higher temperature response indicates a better vascular function.

[0499] In one embodiment, a method and apparatus is provided for using a combination of infrared thermography, digital temperature measurements of vascular reactivity and Doppler ultrasonography simultaneously.

#### Miniature DTM Device with Finger Occlusion Cuff:

[0500] One embodiment of a miniature DTM device (MDTMD) is shown in FIG. **53A**. Another embodiment is shown in FIG. **53B**. The MDTMD is placed on a finger such as the index finger, and is dimensioned such that the device



does not interfere with normal functioning. The embodiment of the device depicted in FIGS. 53A and 53B consists of three sub-units: (a) an occluding band placed close to the base of the finger. The band consists of two rings, one stationary that has a display unit mounted on it, and the other which can be twisted so as to deploy the inflation. Both are connected with a thick band that enables the tightening mechanism and ensures a snug and comfortable cushioning. Sub-unit (b) is a temperature sensing band placed closer to the finger tips, and sub-unit (c) is a data acquisition and transmission system (DATS), mounted on the occluding band. This system also contains a display unit that shows the pressure and temperature reading along with a sensor. In one embodiment, a remote telemedic computer system receives, analyzes and presents the data to medical staff almost instantaneously. In other embodiments, optional additional measuring devices may include an oximeter, which records the instantaneous heart rate of the soldier, and a plethysmographic device to read the blood pressure.

[0501] Device functionality is briefly described below, elaborating on the physical operating principles. Upon activation, the occluding band first compresses the artery in the finger, causing ischemia (i.e. interruption in the flow of blood to the finger tips). After a pre-set or programmable occlusion time, the finger tips—having been deprived of normal blood circulation—attain a reduced surface temperature closer to ambient. Following this period of constriction, the occluding band can be manually loosened by pressing a button on the occluding band, thereby immediately restoring blood flow. The subsequent time-variations of the finger-tip temperature are measured by the sensor.

[0502] Referring again to FIG. 53A depicting an embodiment of a Miniaturized DTM Device. Depiction A is a top view of the MDTM device that shows the display unit. B shows the side view, note the thin plastic ring close to the finger tip that mounts the skin temperature sensor. In an alternative embodiment, the temperature sensor is disposed in a stretch tube-shape (sleeve) over the finger, for example from the base of the finger to near the tip or last interphalangeal crease. This embodiment may be preferred where the fingertip is needed for sensory controlled functions of the finger.

[0503] Depiction C of FIG. 53, shows the cable connecting the skin temperature sensor and the occluding band, while D shows a close up view of the MDTMD. Depiction E is an end-on view. A strap connects the two rings that lock themselves when the top ring is twisted. The strap is also to ensure a snug and comfortable fit. In F, a button on the stationary ring is to deploy the deflation process ensuring that two rings come back to their original position. G depicts another projection illustrating the MDTMD. The device is dimensioned not to interfere with normal subject prehensile or ambulatory function, and will work by triggering reactive hyperemia followed by temperature measurement using micro-transducers.

#### DTM Parameters

[0504] The graph presented in FIG. 54 illustrates different parameters that can be calculated from a temperature fall and rebound curve determined by temperature measurements in conjunction with a reactive hyperemia test. This includes the delta of temperature and AUC between different time points.

[0505] It is understood that variations may be made in the foregoing without departing from the scope of the disclosed embodiments. Furthermore, the elements and teachings of the various illustrative embodiments may be combined in whole or in part some or all of the illustrated embodiments. Although illustrative embodiments have been shown and described, a wide range of modification, change and substitution is contemplated in the foregoing disclosure and in some instances, some features of the embodiments may be employed without a corresponding use of other features. Accordingly, it is appropriate that the appended claims be construed broadly and in a manner consistent with the scope of the embodiments disclosed herein.

#### 1. A thermal energy measurement apparatus, comprising:

a thermal energy sensor adapted to measure temperature of a body part while not substantially changing the temperature of the body part, and

a display or recorder coupled to the thermal energy sensor, wherein the thermal energy sensor measures the temperature of the body part before and subsequent to the provision of a vasostimulant, and the display or recorder reports the temperature of the body part prior to the provision of the stimulant and the temperature of the body part after provision of the stimulant.

2. The apparatus of claim 1, where the vasostimulant is physical such as an occlusive means for providing a reactive hyperemia stimulant by interrupting the blood flow to the body part for a period of time followed by ceasing the interruption of blood flow.

3. The apparatus of claim 1, where the vasostimulant is chemical such as a local or systemic administration of the stimulant for inducing vascular dilation or constriction.

4. The apparatus of claim 1, wherein the vasostimulant is a vascular or neurovascular stimulant.

5. The apparatus of claim 1, further comprising a plotting engine that plots a temperature curve at least between the temperature of the body part prior to the provision of the vasostimulant and the temperature of the body part after provision of the vasostimulant.

6. The apparatus of claim 1, wherein the apparatus records one or more parameters selected from the group consisting of: lowest temperature of the body part; the highest temperature of the body part; the difference between the highest temperature of the body part and the temperature of the body part prior to the provision of the vasostimulant; the difference between the highest temperature of the body part and the lowest temperature of the body part; the time required for the temperature of the body part to stabilize subsequent to the provision of the vasostimulant; the slope of the temperature changes of the body part from the temperatures of the body part upon the provision of the vasostimulant up to the lowest temperature of the body part achieved; the slope of the temperature changes of the body part from the lowest temperature of the body part achieved up to the highest temperature of the body part achieved; the area bounded by the temperature curve, the lower temperature of the body part achieved, the time at which the lowest temperature of the body part was achieved, and the time at which the highest temperature of the body part was achieved.

7. The apparatus of claim 1, wherein the device further comprises a unit for measuring a hemodynamic parameter such as blood flow velocity using ultrasound Doppler.



8. The apparatus of claim 1, wherein the device further comprises a unit for measuring a vascular physiologic parameter such as pulse wave velocity.

9. The apparatus of claim 1, wherein the device further comprises a unit for measuring and recording hemodynamic parameters using near infrared light such as photoplethysmography.

10. The apparatus of claim 1, wherein the device further comprises a unit for measuring a hemodynamic parameter using laser Doppler flowmetry.

11. The apparatus of claim 1, wherein the device further comprises a unit for measuring blood pressure.

12. The apparatus of claim 1, wherein the device further comprises a unit for measuring vital signs such as body temperature, heart rate, and blood oxygen.

13. The apparatus of claim 1, wherein the thermal energy sensor comprises a plurality of thermal energy sensors.

14. The apparatus of claim 1, further comprising one or more further monitoring units selected from a group consisting of a unit for: skin color, nail capillaroscopy, ultrasound brachial artery imaging, forearm plethysmography, fingertip plethysmography, oxygen saturation change, blood pressure or vital signs monitoring device, Doppler flow measurement, arterial pulse waveform analysis, near-infrared spectroscopy measurement, peripheral arterial tonometry, and aortic augmentation index.

15. The apparatus of claim 1, further comprising one or more units for measuring room temperature measurement, core temperature measurement, and combinations thereof.

16. The apparatus of claim 1, comprising a computer system that is coupled to the thermal energy sensor by a wireless connection.

17. The apparatus of claim 16, wherein the wireless connection comprises Bluetooth technology.

18. The apparatus of claim 16, wherein the computer system is chosen from the group consisting of a cellular phone, a PDA, a personal computing device, and combinations thereof.

19. The apparatus of claim 1, further comprising a unit for measuring tissue metabolic rate.

20. The apparatus of claim 1, further comprising a unit for measuring tissue heat capacity.

21. The apparatus of claim 16, wherein the computer system is coupled to an alerting device.

22. The apparatus of claim 11, wherein the blood pressure of the subject is measured using finger blood pressure and/or wrist blood pressure.

23. The apparatus of claim 1, further comprising a pulse oximeter.

24. The apparatus of claim 1, wherein the thermal energy sensor is adapted to be coupled to a surface of the body part by an attachment selected from a group consisting of a: mesh sleeve, ring, non-insulating material, mesh, disposable adhesive, watch, bracelet, or an article of clothing such as a glove.

25. The apparatus of claim 1, wherein the thermal energy sensor comprises a probe operable to measure thermal energy of the surface of the body part without contacting the body part.

26. The apparatus of claim 1, wherein the thermal energy sensor is operable to measure thermal energy over a time period.

27. The apparatus of claim 1, further comprising a second thermal energy sensor adapted for measurement of tempera-

ture of a corresponding contralateral body part while not substantially changing the temperature of the body part.

28. The apparatus of claim 27, is used to evaluate neurovascular reactivity of the subject and thereby to evaluate vascular and neurovascular health.

29. The apparatus of claim 1, wherein the thermal energy sensor is selected from among a group consisting of: a thermocouple, thermister, resistance temperature detector, heat flux detector, liquid crystal sensor, thermopile, and an infrared sensor.

30. The apparatus of claim 1, further comprising a Doppler flow measurement device and is capable of continuous monitoring of Doppler flow velocity at an arterial site.

31. The apparatus of claim 1, further comprising a recording and calculating computer for continuously evaluating temperatures measured by the sensor in response to the vasostimulant, wherein the computer calculates one or more vascular responsiveness determinants selected from TF, TR, NP, SF and SR of the temperature response to the vasostimulant.

32. A method for assessment of vascular reactivity in an individual comprising:

locating a thermal energy sensor on a target site on the individual, wherein the thermal energy sensor does not alter microcapillary flow, and establishing a stable baseline temperature with the thermal energy sensor at the site;

providing a vasostimulant to the individual;

determining a temperature response to the vasostimulant; and

establishing a vascular reactivity assessment for the individual based on the temperature response.

33. The method of claim 32, wherein the vasostimulant comprises occluding a blood supply to the target site for a predetermined period of time and ceasing occlusion thereafter.

34. The method of claim 32, wherein the target site is an extremity.

35. The method of claim 32, further comprising measuring blood pressure in the individual.

36. The method of claim 32, further comprising monitoring a temperature response on a site remote from the target site.

37. The method of claim 32, comprising locating a second thermal energy sensor on a corresponding contralateral site to the site subject to the vasostimulant and simultaneously monitoring and recording of temperature of the contralateral site.

38. The method of claim 32, wherein the temperature is monitored successively from an establishment of the baseline until at least a peak temperature response.

39. The method of claim 38, wherein the successively monitored temperature is displayed as a plot of temperature versus time.

40. The method of claim 32, wherein one or more numerical values are obtained from the temperature response, the values selected from the group consisting of one or more of: TF, TR, NP, SF, SR, and area under the curve.

41. The method of claim 32, wherein the health condition is selected from the group consisting of: endothelial function, autonomic nervous system function, risk for athero-



sclerotic cardiovascular disorder, progression of heart failure, obesity, high sympathetic reactivity, high blood pressure, white coat hypertension, hypertension, smooth muscle cell dysfunction, status and progression of diabetes, fitness, sleep disorders such as sleep apnea, rheumatologic disease, Raynaud's, connective tissue disorders, pulmonary hypertension, smoking, vascular stress, sleep disorders, metabolic syndrome, subclinical hypothyroidism, vascular dementia, Alzheimer's, portal hypertension, cancer, renal function, cerebral vascular disease, stroke, memory loss, vision loss, heart attack, angina, erectile dysfunction, peripheral arterial disease, migraine headaches, Prinzmetal's angina, pregnancy and preeclampsia, infections, HIV and AIDS, diabetic foot, anxiety and excessive stress, and high cholesterol as well as monitoring response to therapies for the aforementioned health conditions.

**42.** The method of claim 32, wherein the health condition is selected from the group consisting of post surgery and vascular interventions monitoring, monitoring wound healing and wound care management, and assessment of neurovasculopathy.

**43.** The method of claim 32, further comprising considering the vascular reactivity assessment in light of a status of the individual for one or more additional tests selected from the group consisting of: coronary calcium score, Framingham risk score, carotid intima-media thickness test, cardiac function test, magnetic resonance imaging test, intravascular ultrasound; assessing a endothelial function, including by an endothelial driven microparticles test, a VCAM1 test, an ICAM1 test, a SELECTIN test, a VWF test, c-reactive protein test, an Lp-PLA2 level, a CD54 test, and ankle-brachial blood pressure index test.

**44.** The method of claim 32, further comprising measuring a hemodynamic parameter in the subject using optical spectroscopy.

**45.** The method of claim 32, further comprising measuring and recording a room temperature and/or a core temperature of the subject.

**46.** The method of claim 32, further comprising measuring and recording a tissue heat capacity and/or a tissue metabolic rate of the subject.

**47.** The method of claim 32, further comprising measuring and recording the blood pressure of the subject, including by Korotkoff sounds and/or oscillometric methods.

**48.** The method of claim 32, further comprising determining an oxygen saturation measurement at a fingertip.

**49.** The method of claim 32, further comprising measuring a blood flow velocity through an artery of the subject which supplies blood to the body part before, during, and after the provision of the vasostimulant.

**50.** The method of claim 32, further comprising measuring and recording the stiffness of an artery supplying blood to the body part by arterial pulse waveform analysis.

**51.** The method of claim 32, wherein the device acquires a measure of endothelium dependent vascular reactivity by the temperature response to the vasostimulant; acquires a measure of endothelium independent vascular reactivity by input of additional non-endothelial related diagnosis techniques; calculates a ratio of the measure of endothelium dependent vascular reactivity over the measure of endothelium independent vascular reactivity; and thereby determines a health condition of the subject.

**52.** The method of claim 32, further comprising determining one or more health conditions by considering results of additional diagnostic techniques selected from the group consisting of: intravascular optical coherent tomography, coronary fractional flow reserve, intravascular ultrasound radiofrequency backscatter analysis or Virtual Histology, urinary albumin, serum fibrinogen, IL6, CD40/CD40L, serum amyloid A, ankle brachial index, MRI, coronary calcium score, carotid intima-media thickness, Framingham risk score, C-reactive protein tests, waist circumference, blood insulin level, PAI-1 test, t-PA test, glucose tolerance tests, fasting plasma glucose level, HDL cholesterol level, fasting plasma insulin test, homeostasis model assessment, BMI, body fat level, visceral fat test, subcutaneous fat test, white blood cell count, Neutrophil/lymphocyte ratio, platelet function test, and combinations thereof.

**53.** The method of claim 32, further comprising determining one or more health conditions by considering results of additional diagnostic techniques selected from the group consisting of: plasma and urinary level of asymmetrical (ADMA) and symmetrical (SDMA) dimethylarginine, exhaled nitric oxide, serum homocysteine, an endothelial driven microparticles test, a VCAM1 test, an ICAM1 test, a SELECTIN test, a VWF test, a TF test, a CD54 test, endothelial progenitor cells, myeloperoxidase (MPO), increased neutrophil/lymphocyte ratio, endothelin-1, thrombomodulin, tissue factor and tissue factor pathway inhibitor, markers of inflammation such as, for example, granulocyte-macrophage colony-stimulating factor (GM-CSF) and macrophage chemoattractant protein-1 (MCP-1) nitric oxide and its metabolites nitrates and nitrites, almost nitrosylated proteins, a selectin such as, for example, soluble endothelium, leukocyte, and platelet selecting, markers of oxidative stress including but not limited to free radical measurements of the blood or through the skin, TBAR, and/or extra cellular superoxide dismutase activity, vascular stiffness or compliance, and combinations thereof.

**54.** The method of claim 32, further comprising performing one or more additional diagnostic techniques in order to determine the health condition of the patient, the techniques selected from the group consisting of: skin color, nail capillaroscopy, ultrasound brachial artery imaging, forearm plethysmography, fingertip plethysmography, oxygen saturation change, pressure change, near-infrared spectroscopy measurements, Doppler flow, peripheral arterial tonometry, and combinations thereof.

**55.** A treatment for improving vascular function, wherein the treatment is determined to be efficacious in improving vascular function based on an increase in normalized TR, SlopeR and/or NP digital thermal monitoring values as a consequence of the treatment.

**56.** The treatment of claim 55, wherein the treatment is a drug treatment.

**57.** The treatment of claim 55, wherein the treatment is a nutritional program.

**58.** A method for determining influence of a treatment on vascular function, comprising:

determining one or more normalized values selected from a TF, TR, SlopeR and/or NP value for a patient by digital thermal monitoring;

administering the treatment to the patient;

monitoring the patient for any change in one or more of the normalized values by periodic repeat determinations in the patient;

establishing that the treatment influences vascular function if a significant change in one or more of the normalized values result from administration of the agent.

**59.** A computer program encoded on a computer-readable medium having a computer program recorded thereon and arranged to be loaded into a program memory of a computer and to cause the computer to execute at least the following steps for determining one or more health conditions:

retrieving a plurality of temperature data from a database, the temperature data derived from operation of the apparatus of claim 1, and including a baseline temperature of a target body part prior to administration of the vasostimulant and a temperature at a set time after administration of the vasostimulant;

calculating a difference between the baseline temperature and the temperature at a set time after administration of the vasostimulant; and

displaying the calculated difference.

**60.** The computer program of claim 59, wherein the temperature data further comprises one or more values selected from the group consisting of:

a temperature drop from the baseline temperature having a first slope;

a lowest temperature achieved;

a temperature rise from the lowest temperature achieved having a second slope;

a peak temperature; and

a stabilization temperature.

\* \* \* \* \*