



US011734654B2

(12) **United States Patent**
Silva et al.

(10) **Patent No.:** **US 11,734,654 B2**
(45) **Date of Patent:** ***Aug. 22, 2023**

(54) **WIRELESS-ENABLED KIOSK FOR RECYCLING CONSUMER DEVICES**

(71) Applicant: **ecoATM, LLC**, San Diego, CA (US)

(72) Inventors: **John Silva**, San Diego, CA (US); **Jeffrey Ploetner**, San Diego, CA (US); **Mark Vincent Bowles**, San Diego, CA (US); **John Andrew Beane**, San Diego, CA (US); **Michael Librizzi**, San Diego, CA (US); **Randal Erman**, San Diego, CA (US)

(73) Assignee: **ecoATM, LLC**, San Diego, CA (US)

(*) Notice: Subject to any disclaimer, the term of this patent is extended or adjusted under 35 U.S.C. 154(b) by 0 days.

This patent is subject to a terminal disclaimer.

(21) Appl. No.: **17/445,575**

(22) Filed: **Aug. 20, 2021**

(65) **Prior Publication Data**

US 2022/0292464 A1 Sep. 15, 2022

Related U.S. Application Data

(60) Continuation of application No. 16/575,003, filed on Sep. 18, 2019, now Pat. No. 11,126,973, which is a (Continued)

(51) **Int. Cl.**

G06Q 10/00 (2023.01)

G06Q 10/30 (2023.01)

(Continued)

(52) **U.S. Cl.**

CPC **G06Q 10/30** (2013.01); **G06Q 20/18** (2013.01); **G06Q 20/202** (2013.01);

(Continued)

(58) **Field of Classification Search**

None

See application file for complete search history.

(56) **References Cited**

U.S. PATENT DOCUMENTS

3,808,439 A 4/1974 Renius
4,248,334 A 2/1981 Hanley et al.

(Continued)

FOREIGN PATENT DOCUMENTS

CA 2760863 11/2010
CA 2818533 A1 5/2012

(Continued)

OTHER PUBLICATIONS

2006 Florida Statutes Title XXXIII, Chapter 538, Sections 538.03 and 538.04, 7 pages.

(Continued)

Primary Examiner — Fateh M Obaid

(74) *Attorney, Agent, or Firm* — Perkins Coie LLP

(57) **ABSTRACT**

Wireless-enabled kiosk systems and associated methods for recycling and performing other processes with mobile phones and other electronic devices are described herein. In various embodiments, the present technology includes systems and methods for wirelessly connecting a consumer-operated kiosk with an electronic device to facilitate processing (e.g., purchasing) the device. In some embodiments, the present technology includes using a wireless link to identify a device, evaluate a device, resolve device issues to enable purchase of the device, locate a device, etc. Various other aspects of the present technology are described herein.

30 Claims, 25 Drawing Sheets

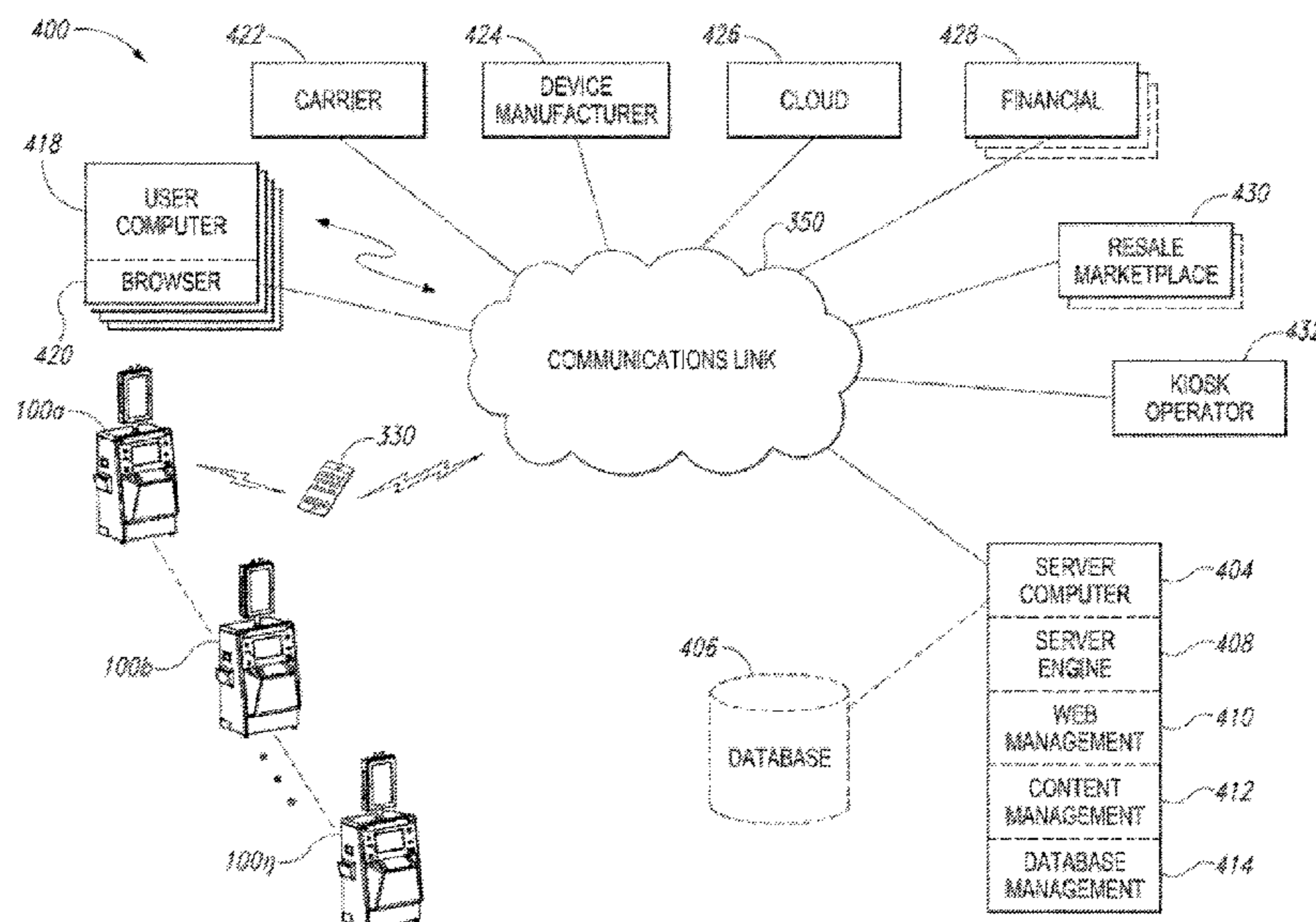

Related U.S. Application Data

- division of application No. 14/873,158, filed on Oct. 1, 2015, now Pat. No. 10,475,002.
- (60) Provisional application No. 62/059,129, filed on Oct. 2, 2014.
- (51) **Int. Cl.**
H04W 4/80 (2018.01)
G07F 7/06 (2006.01)
G06Q 30/0201 (2023.01)
G06Q 20/18 (2012.01)
G06Q 20/20 (2012.01)
- (52) **U.S. Cl.**
 CPC *G06Q 20/208* (2013.01); *G06Q 30/0201* (2013.01); *G06Q 30/0206* (2013.01); *G07F 7/06* (2013.01); *H04W 4/80* (2018.02); *G06Q 10/00* (2013.01); *G06Q 20/20* (2013.01); *Y02W 30/82* (2015.05); *Y02W 90/00* (2015.05)

(56) **References Cited**

U.S. PATENT DOCUMENTS

4,519,522 A 5/1985 McElwee
 4,593,820 A 6/1986 Antonie
 4,715,709 A 12/1987 Sekine et al.
 4,821,118 A 4/1989 Lafreniere
 4,845,636 A 7/1989 Walker
 4,870,357 A 9/1989 Young et al.
 4,878,736 A 11/1989 Hekker et al.
 4,893,789 A 1/1990 Novorsky
 4,927,051 A 5/1990 Falk et al.
 4,951,308 A 8/1990 Bishop et al.
 5,025,344 A 6/1991 Maly et al.
 5,027,074 A 6/1991 Haferstat
 5,077,462 A 12/1991 Newell et al.
 5,091,773 A 2/1992 Fouche et al.
 5,105,149 A 4/1992 Tokura
 5,216,502 A 6/1993 Katz
 5,280,170 A 1/1994 Baldwin
 5,319,459 A 6/1994 Mochizuki et al.
 5,339,096 A 8/1994 Beaufort et al.
 5,419,438 A 5/1995 Squyres et al.
 5,436,554 A 7/1995 Decker
 5,570,920 A 11/1996 Crisman et al.
 5,572,444 A 11/1996 Lentz et al.
 5,610,710 A 3/1997 Canfield et al.
 5,717,780 A 2/1998 Mitsumune et al.
 5,747,784 A 5/1998 Walter et al.
 5,748,084 A 5/1998 Isikoff
 5,775,806 A 7/1998 Allred
 5,839,058 A 11/1998 Phillips et al.
 5,871,371 A 2/1999 Rothenberger et al.
 5,920,338 A 7/1999 Katz
 5,949,901 A 9/1999 Nichani et al.
 5,965,858 A 10/1999 Suzuki et al.
 5,966,654 A 10/1999 Croughwell et al.
 5,987,159 A 11/1999 Nichani
 5,988,431 A 11/1999 Roe
 6,029,851 A 2/2000 Jenkins et al.
 6,041,229 A 3/2000 Turner
 6,055,512 A 4/2000 Dean et al.
 6,100,986 A 8/2000 Rydningen
 6,170,702 B1 1/2001 Zettler et al.
 6,181,805 B1 1/2001 Koike et al.
 6,228,008 B1 5/2001 Pollington et al.
 6,234,812 B1 5/2001 Ivers et al.
 6,259,827 B1 7/2001 Nichani
 6,264,104 B1 7/2001 Jenkins et al.
 6,330,354 B1 12/2001 Companion et al.
 6,330,958 B1 12/2001 Ruskin
 6,393,095 B1 5/2002 Robinson
 6,462,644 B1 10/2002 Howell et al.
 6,529,837 B1 3/2003 Kang

6,535,637 B1 3/2003 Wootton et al.
 6,573,886 B1 6/2003 Lehtinen et al.
 6,587,581 B1 7/2003 Matsuyama et al.
 6,595,684 B1 7/2003 Casagrande et al.
 6,597,552 B1 7/2003 Griepentrog et al.
 6,633,377 B1 10/2003 Weiss et al.
 6,667,800 B1 12/2003 Larsson et al.
 6,748,296 B2 6/2004 Banerjee et al.
 6,754,637 B1 6/2004 Stenz
 6,758,370 B2 7/2004 Cooke et al.
 6,798,528 B1 9/2004 Hartman
 6,822,422 B2 11/2004 Sagawa
 6,842,596 B2 1/2005 Morii et al.
 6,854,656 B2 2/2005 Matsumori
 6,947,941 B1 9/2005 Koon
 D512,964 S 12/2005 Kissinger et al.
 7,069,236 B1 6/2006 Tsunenari
 7,076,449 B2 7/2006 Tsunenari et al.
 7,086,592 B2 8/2006 Wagner et al.
 7,178,720 B1 2/2007 Strubbe et al.
 7,234,609 B2 6/2007 DeLazzer et al.
 7,251,458 B2 7/2007 O'Connell
 7,268,345 B2 9/2007 Schultz
 7,334,729 B2 2/2008 Brewington
 7,407,392 B1 8/2008 Cooke et al.
 7,408,674 B2 8/2008 Moro et al.
 7,455,226 B1 11/2008 Hammond et al.
 7,520,666 B2 4/2009 Pevzner et al.
 7,529,687 B1 5/2009 Phan
 7,567,344 B2 7/2009 LeBlanc et al.
 7,642,687 B2 1/2010 Kageyama et al.
 7,646,193 B2 1/2010 Suzuki et al.
 7,649,450 B2 1/2010 Campion et al.
 7,702,108 B2 4/2010 Amon et al.
 7,735,125 B1 6/2010 Alvarez et al.
 7,761,331 B2 7/2010 Low et al.
 7,783,379 B2 8/2010 Beane et al.
 7,848,833 B2 12/2010 Li
 7,881,965 B2 2/2011 Bowles et al.
 7,890,373 B2 2/2011 Junger
 D640,199 S 6/2011 Wilson
 8,010,402 B1 8/2011 Sharma et al.
 8,019,588 B1 9/2011 Wohlberg et al.
 8,025,229 B2 9/2011 Hammond et al.
 8,031,930 B2 10/2011 Wang et al.
 8,107,243 B2 1/2012 Guccione et al.
 8,112,325 B2 2/2012 Foy et al.
 8,142,199 B1 3/2012 Almouli
 8,195,511 B2 6/2012 Bowles et al.
 8,200,533 B2 6/2012 Librizzi et al.
 8,200,736 B2 6/2012 Shi
 8,215,546 B2 7/2012 Lin et al.
 8,239,262 B2 8/2012 Bowles et al.
 8,254,883 B2 8/2012 Uchida
 8,266,008 B1 9/2012 Siegel et al.
 8,340,815 B2 12/2012 Peters et al.
 8,369,987 B2 2/2013 Claessen
 8,401,914 B1 3/2013 Kim
 8,417,234 B2 4/2013 Sanding et al.
 8,423,404 B2 4/2013 Bowles et al.
 8,429,021 B2 4/2013 Kraft et al.
 8,463,646 B2 6/2013 Bowles
 8,536,472 B2 9/2013 Wu et al.
 8,543,358 B2 9/2013 Trabona
 8,566,183 B1 10/2013 Bonar et al.
 8,606,633 B2 12/2013 Tarbert et al.
 8,718,717 B2 5/2014 Vaknin et al.
 8,755,783 B2 6/2014 Brahami et al.
 8,806,280 B2 8/2014 Stephenson
 8,823,794 B2 9/2014 Suzuki et al.
 8,824,136 B1 9/2014 Interian et al.
 8,743,215 B1 11/2014 Lee
 8,922,643 B2 12/2014 Ji et al.
 9,010,627 B1 4/2015 Prasad et al.
 9,043,026 B2 5/2015 Lien et al.
 9,124,056 B1 9/2015 Lewis, Jr.
 9,189,911 B2 11/2015 Kavli et al.
 9,195,979 B2 11/2015 Geller
 9,256,863 B2 2/2016 Chayon et al.

(56)

References Cited

U.S. PATENT DOCUMENTS

9,317,989 B2	4/2016	Grow et al.	2003/0179371 A1	9/2003	Rangarajan et al.
9,355,515 B2	5/2016	Brahami et al.	2003/0191675 A1	10/2003	Murashita
9,367,982 B2	6/2016	Chayun et al.	2003/0197782 A1	10/2003	Ashe
9,378,606 B2	6/2016	Chayun et al.	2003/0204289 A1	10/2003	Banerjee et al.
9,390,442 B2	7/2016	Lyle	2004/0012825 A1	1/2004	Tesavis
9,497,563 B2	11/2016	Hornung et al.	2004/0088231 A1	5/2004	Davis
9,582,101 B2	2/2017	Chang et al.	2004/0114153 A1	6/2004	Andersen et al.
9,595,238 B2	3/2017	Won	2004/0141320 A1	7/2004	Bock et al.
9,621,947 B1	4/2017	Oztaskent	2004/0150815 A1	8/2004	Sones et al.
9,641,997 B2	5/2017	Vratskides	2004/0156557 A1	8/2004	Van Der Weij
9,697,548 B1	7/2017	Jaff et al.	2004/0156667 A1	8/2004	Van Der Weij et al.
9,704,142 B2	7/2017	Ahn	2004/0186744 A1	9/2004	Lux
9,818,160 B2	11/2017	Bowles et al.	2004/0189812 A1	9/2004	Gustavsson
9,881,284 B2	1/2018	Bowles et al.	2004/0200902 A1	10/2004	Ishioroshi
9,885,672 B2	2/2018	Forutanpour et al.	2004/0205015 A1	10/2004	DeLaCruz
9,904,911 B2	2/2018	Bowles et al.	2004/0235513 A1	11/2004	O'Connell
9,911,102 B2	3/2018	Bowles	2004/0242216 A1	12/2004	Boutsikakis
9,934,644 B2	4/2018	Chayun et al.	2004/0262521 A1	12/2004	Devitt et al.
10,032,140 B2 *	7/2018	Bowles G06Q 30/0601	2005/0027622 A1	2/2005	Walker et al.
10,043,339 B2	8/2018	Walker et al.	2005/0043897 A1	2/2005	Meyer
10,044,843 B2	8/2018	Sinha et al.	2005/0109841 A1	5/2005	Ryan et al.
10,055,798 B2	8/2018	Bowles et al.	2005/0128551 A1	6/2005	Yang
10,127,647 B2	11/2018	Forutanpour et al.	2005/0135917 A1	6/2005	Kaupilla et al.
10,157,379 B2	12/2018	Singh	2005/0137942 A1	6/2005	LaFleur
10,157,427 B2	12/2018	Bowles et al.	2005/0139661 A1	6/2005	Eglen et al.
10,269,110 B2	4/2019	Forutanpour et al.	2005/0143149 A1	6/2005	Becker et al.
10,275,813 B2	4/2019	Fu	2005/0167620 A1	8/2005	Cho et al.
10,339,509 B2	7/2019	Bordeleau et al.	2005/0187657 A1	8/2005	Hashimoto et al.
10,401,411 B2	9/2019	Snook et al.	2005/0216120 A1	9/2005	Rosenberg et al.
10,417,615 B2	9/2019	Bowles et al.	2005/0222690 A1	10/2005	Wang et al.
10,438,174 B2	10/2019	Bowles et al.	2005/0231595 A1	10/2005	Wang et al.
10,445,708 B2	10/2019	Hunt et al.	2005/0240958 A1	10/2005	Nguyen et al.
10,475,002 B2	11/2019	Silva et al.	2006/0167580 A1	1/2006	Whittier
10,496,963 B2	12/2019	Silva et al.	2006/0022827 A1	2/2006	Highham
10,572,946 B2	2/2020	Bowles et al.	2006/0038114 A9	2/2006	Cofer et al.
10,679,279 B2	6/2020	Ward	2006/0047573 A1	3/2006	Mitchell et al.
10,825,082 B2	11/2020	Librizzi et al.	2006/0074756 A1	4/2006	Boykin
10,846,672 B2	11/2020	Dion et al.	2006/0085158 A1	4/2006	Cakiner
10,853,873 B2	12/2020	Bowles et al.	2006/0184379 A1	8/2006	Tan et al.
10,860,990 B2	12/2020	Bowles et al.	2006/0195384 A1	8/2006	Bauer et al.
10,909,673 B2	2/2021	Forutanpour et al.	2006/0219776 A1	10/2006	Finn
10,977,700 B2	4/2021	Bordeleau et al.	2006/0229108 A1 *	10/2006	Cehelnik H04M 1/72403 455/569.1
11,010,841 B2	5/2021	Bowles et al.	2006/0235747 A1	10/2006	Hammond et al.
11,080,662 B2	8/2021	Bowles et al.	2006/0217152 A1	11/2006	Fok et al.
11,080,672 B2	8/2021	Bowles	2006/0258008 A1	11/2006	Holler et al.
11,107,046 B2	8/2021	Bowles	2006/0261931 A1	11/2006	Cheng et al.
11,126,973 B2	9/2021	Silva et al.	2006/0271431 A1	11/2006	Wehr et al.
11,232,412 B2	1/2022	Hunt et al.	2006/0279307 A1	12/2006	Wang et al.
11,315,093 B2	4/2022	Bowles	2006/0280356 A1	12/2006	Yamagashi
11,341,471 B2	5/2022	Dion et al.	2007/0012665 A1	1/2007	Nelson
11,436,570 B2	9/2022	Bowles et al.	2007/0013124 A1	1/2007	Graef et al.
11,443,289 B2	9/2022	Bowles et al.	2007/0032098 A1	2/2007	Bowles et al.
11,462,868 B2	10/2022	Forutanpour et al.	2007/0050083 A1	3/2007	Signorelli
11,482,067 B2	10/2022	Forutanpour et al.	2007/0057815 A1	3/2007	Foy et al.
11,526,932 B2	12/2022	Bowles et al.	2007/0129906 A1	6/2007	Stoecker et al.
2001/0025883 A1	10/2001	Ichihara et al.	2007/0133844 A1	6/2007	Wahner et al.
2001/0035425 A1	11/2001	Rocco et al.	2007/0150403 A1	6/2007	Mock et al.
2001/0039531 A1	11/2001	Aoki	2007/0140310 A1	7/2007	Rolton et al.
2002/0014577 A1	2/2002	Ulrich et al.	2007/0205751 A1	9/2007	Suzuki et al.
2002/0035515 A1	3/2002	Moreno	2007/0258085 A1	11/2007	Robbins
2002/0067184 A1	6/2002	Smith et al.	2007/0263099 A1	11/2007	Motta et al.
2002/0087413 A1	7/2002	Mahaffy et al.	2007/0269099 A1	11/2007	Nishino et al.
2002/0112177 A1	8/2002	Voltmer	2007/0276911 A1	11/2007	Bhumkar
2002/0129170 A1	9/2002	Moore et al.	2007/0281734 A1	12/2007	Mizrachi
2002/0157033 A1	10/2002	Cox	2007/0282999 A1	12/2007	Tu et al.
2002/0162966 A1	11/2002	Yoder	2008/0004828 A1	1/2008	Mizrachi
2002/0186878 A1	12/2002	Hoon et al.	2008/0027581 A1	1/2008	Saether et al.
2003/0006277 A1	1/2003	Maskatiya et al.	2008/0033596 A1	2/2008	Fausak et al.
2003/0018897 A1	1/2003	Bellis, Jr. et al.	2008/0109746 A1	5/2008	Mayer
2003/0025476 A1	2/2003	Treia	2008/0111989 A1	5/2008	Dufour et al.
2003/0036866 A1	2/2003	Nair et al.	2008/0133432 A1	6/2008	Ramseyer
2003/0061150 A1	3/2003	Kocher et al.	2008/0149720 A1	6/2008	Colville
2003/0100707 A1	5/2003	Hwang et al.	2008/0167578 A1	7/2008	Bryer et al.
2003/0146898 A1	8/2003	Kawasaki et al.	2008/0177598 A1	7/2008	Davie
2003/0170529 A1	9/2003	Sagawa	2008/0207198 A1	8/2008	Uric
			2008/0231113 A1	9/2008	Guccione et al.
			2008/0255901 A1	10/2008	Carroll et al.
			2008/0256008 A1	10/2008	Kwok

(56)

References Cited

U.S. PATENT DOCUMENTS

2008/0260235	A1	10/2008	Cai et al.	2012/0280934	A1	11/2012	Ha
2008/0277467	A1	11/2008	Carlson	2012/0301009	A1	11/2012	Dabic
2008/0281691	A1	11/2008	Pearson et al.	2012/0303431	A1	11/2012	Phillips et al.
2008/0296374	A1	12/2008	Gonen et al.	2013/0006713	A1	1/2013	Haake
2008/0303915	A1	12/2008	Omi	2013/0034305	A1	2/2013	Jahanshahi et al.
2008/0306701	A1	12/2008	Zhong et al.	2013/0041508	A1	2/2013	Hu et al.
2009/0051907	A1	2/2009	Li et al.	2013/0046611	A1	2/2013	Bowles et al.
2009/0079388	A1	2/2009	Reddy	2013/0046699	A1	2/2013	Bowles et al.
2009/0078775	A1	3/2009	Giebel et al.	2013/0112440	A1	5/2013	Alsaif et al.
2009/0095047	A1	4/2009	Patel et al.	2013/0124426	A1	5/2013	Bowles et al.
2009/0114716	A1*	5/2009	Ramachandran G07F 19/20 235/379	2013/0126741	A1	5/2013	Srivastava et al.
				2013/0137376	A1*	5/2013	Fitzgerald H04W 8/245 455/41.3
2009/0132813	A1*	5/2009	Schibuk G06Q 20/4014 726/9	2013/0144797	A1	6/2013	Bowles et al.
2009/0156199	A1	6/2009	Steenstra et al.	2013/0155061	A1	6/2013	Jahanshahi et al.
2009/0160668	A1	6/2009	Crowley et al.	2013/0157641	A1	6/2013	Brahami et al.
2009/0177319	A1	7/2009	Garibaldi et al.	2013/0159119	A1	6/2013	Henderson et al.
2009/0184865	A1	7/2009	Vaio et al.	2013/0173430	A1	7/2013	Benjamin
2009/0187491	A1	7/2009	Bull et al.	2013/0173434	A1	7/2013	Hartman
2009/0190142	A1	7/2009	Taylor et al.	2013/0181935	A1	7/2013	McKenzie et al.
2009/0207743	A1*	8/2009	Huq H04L 43/50 370/250	2013/0198089	A1	8/2013	Bowles
				2013/0198144	A1	8/2013	Bowles
2009/0244285	A1	10/2009	Chathukutty	2013/0246211	A1	9/2013	Sullivan
2009/0247133	A1	10/2009	Holmen et al.	2013/0246212	A1	9/2013	Sullivan
2009/0248883	A1*	10/2009	Suryanarayana G06F 9/451 709/229	2013/0246285	A1	9/2013	Chayun et al.
				2013/0253700	A1	9/2013	Carson et al.
2009/0251815	A1	10/2009	Wang et al.	2013/0275314	A1*	10/2013	Bowles G06Q 10/30 705/308
2009/0262341	A1	10/2009	Konopa et al.	2013/0284805	A1	10/2013	Kraft et al.
2009/0265035	A1	10/2009	Jenkinson et al.	2013/0290146	A1	10/2013	West et al.
2009/0299543	A1	12/2009	Cox et al.	2013/0297388	A1	11/2013	Kyle, Jr. et al.
2009/0312009	A1	12/2009	Fishel	2014/0006451	A1	1/2014	Mullis et al.
2009/0321511	A1	12/2009	Browne	2014/0012643	A1	1/2014	Behrisch
2009/0322706	A1	12/2009	Austin	2014/0038556	A1	2/2014	DeSousa
2010/0005004	A1	1/2010	Hudak et al.	2014/0046845	A1	2/2014	Dogin et al.
2010/0051695	A1	3/2010	Yepez et al.	2014/0052329	A1	2/2014	Amirpour
2010/0063894	A1	3/2010	Lundy	2014/0067710	A1	3/2014	Gventer et al.
2010/0110174	A1	5/2010	Leconte	2014/0080550	A1	3/2014	Ino et al.
2010/0115887	A1	5/2010	Schroeder et al.	2014/0143161	A1	5/2014	Ahn
2010/0147953	A1	6/2010	Barkan	2014/0150100	A1	5/2014	Gupta et al.
2010/0157280	A1	6/2010	Kusevic et al.	2014/0156883	A1	6/2014	Bowles
2010/0161397	A1	6/2010	Gauthier et al.	2014/0214505	A1	7/2014	Shuster-Arechiga
2010/0162359	A1	6/2010	Casey et al.	2014/0235258	A1*	8/2014	Chen H04W 4/60 455/452.1
2010/0185506	A1	7/2010	Wolff	2014/0244315	A1	8/2014	Cahill et al.
2010/0219234	A1	9/2010	Forbes	2014/0278244	A1	9/2014	Humphrey et al.
2010/0235198	A1	9/2010	Fini et al.	2014/0297368	A1	10/2014	Ferder
2010/0237854	A1	9/2010	Kumhyr et al.	2014/0347473	A1	11/2014	Wolff et al.
2010/0260271	A1	10/2010	Kapoor	2015/0006281	A1	1/2015	Takahashi
2010/0262481	A1	10/2010	Baker et al.	2015/0066677	A1	3/2015	Bowles et al.
2010/0312639	A1	12/2010	Mastronardi	2015/0088731	A1	3/2015	Ackerman
2011/0035322	A1	2/2011	Lively	2015/0120485	A1	4/2015	Nash
2011/0043628	A1	2/2011	Yun	2015/0170237	A1	6/2015	Powell
2011/0055322	A1	3/2011	Gregersen	2015/0193797	A1	7/2015	Gerrity
2011/0060641	A1	3/2011	Grossman et al.	2015/0206200	A1	7/2015	Edmondson et al.
2011/0066514	A1	3/2011	Maraz	2015/0278529	A1	10/2015	Cho et al.
2011/0067520	A1	3/2011	Ihrke et al.	2015/0293860	A9	10/2015	Bowles
2011/0113479	A1	5/2011	Ganem	2015/0309912	A1	10/2015	Nguyen et al.
2011/0296508	A1	12/2011	Os et al.	2015/0324761	A1	11/2015	Nguyen et al.
2011/0313840	A1	12/2011	Mason et al.	2015/0324870	A1	11/2015	Nguyen et al.
2012/0004761	A1	1/2012	Madruza	2015/0332206	A1	11/2015	Trew et al.
2012/0016518	A1	1/2012	Saario et al.	2015/0356637	A1	12/2015	Graffia et al.
2012/0022965	A1	1/2012	Seergy	2016/0019607	A1	1/2016	Burmester et al.
2012/0026582	A1	2/2012	Okabe et al.	2016/0019685	A1	1/2016	Nguyen et al.
2012/0029985	A1	2/2012	Wilson et al.	2016/0055392	A1	2/2016	Nakano
2012/0030097	A1	2/2012	Hagan et al.	2016/0078434	A1	3/2016	Huxham et al.
2012/0030399	A1	2/2012	Ben-Harosh	2016/0087381	A1	3/2016	Wong et al.
2012/0054113	A1	3/2012	Jayaraman et al.	2016/0092849	A1*	3/2016	Cirannek G07F 7/06 705/26.4
2012/0063501	A1	3/2012	Aguren	2016/0125612	A1	5/2016	Seki et al.
2012/0078413	A1	3/2012	Baker	2016/0171544	A1	6/2016	Heminger et al.
2012/0116928	A1	5/2012	Gventer	2016/0171575	A1	6/2016	Bowles et al.
2012/0116929	A1	5/2012	Gventer	2016/0184990	A1	6/2016	Song et al.
2012/0117001	A1	5/2012	Gventer et al.	2016/0210648	A1	7/2016	Cirannek et al.
2012/0127307	A1	5/2012	Hassenzahl	2016/0269401	A1	9/2016	Saito et al.
2012/0146956	A1	6/2012	Jenkinson	2016/0269895	A1	9/2016	Soini et al.
2012/0235812	A1	9/2012	De Mello et al.	2016/0275460	A1	9/2016	Ploetner et al.
2012/0254046	A1	10/2012	Librizzi et al.	2016/0275518	A1	9/2016	Bowles et al.
				2016/0301786	A1	10/2016	Koltsov et al.

(56)

References Cited

U.S. PATENT DOCUMENTS

2016/0328684 A1 11/2016 Bowles et al.
 2016/0364939 A1 12/2016 Chayun et al.
 2016/0379287 A1 12/2016 Dabiri
 2017/0083886 A1 3/2017 Silva et al.
 2017/0091823 A1 3/2017 Adinarayan et al.
 2017/0115235 A1 4/2017 Ohlsson et al.
 2017/0169401 A1 6/2017 Beane et al.
 2017/0278191 A1 9/2017 Tassone et al.
 2017/0301010 A1 10/2017 Bowles et al.
 2017/0323279 A1 11/2017 Dion et al.
 2019/0066439 A1 2/2019 Pinkus
 2019/0287141 A1 9/2019 Bordeleau
 2020/0090137 A1 3/2020 Bowles et al.
 2020/0202319 A1 6/2020 Forutanpour et al.
 2020/0265487 A1 8/2020 Forutanpour et al.
 2021/0012315 A1 1/2021 Priebatsch
 2021/0035206 A1 2/2021 Bowles et al.
 2021/0081914 A1 3/2021 Nelms et al.
 2021/0110366 A1 4/2021 Dion et al.
 2021/0174312 A1 6/2021 Bowles et al.
 2021/0192484 A1 6/2021 Forutanpour et al.
 2021/0224867 A1 7/2021 Bordeleau et al.
 2021/0295494 A1 9/2021 Forutanpour et al.
 2022/0027879 A1 1/2022 Bowles et al.
 2022/0051212 A1 2/2022 Forutanpour et al.
 2022/0051300 A1 2/2022 Forutanpour et al.
 2022/0051301 A1 2/2022 Forutanpour et al.
 2022/0051507 A1 2/2022 Forutanpour et al.
 2022/0067798 A1 3/2022 Forutanpour et al.
 2022/0068076 A1 3/2022 Forutanpour et al.
 2022/0114854 A1 4/2022 Forutanpour et al.
 2022/0172178 A1 6/2022 Forutanpour et al.
 2022/0198407 A1 6/2022 Beane et al.
 2022/0284406 A1 9/2022 Hunt et al.
 2022/0292464 A1 9/2022 Silva et al.
 2022/0318774 A1 10/2022 Bowles
 2023/0007937 A1 1/2023 Forutanpour et al.

FOREIGN PATENT DOCUMENTS

CA 2866147 9/2013
 CN 1365479 8/2002
 CN 1574437 2/2005
 CN 2708415 7/2005
 CN 1864088 11/2006
 CN 1957320 5/2007
 CN 2912132 6/2007
 CN 200965706 10/2007
 CN 101176124 5/2008
 CN 101379488 A 3/2009
 CN 202351953 7/2012
 CN 202394296 8/2012
 CN 102654927 9/2012
 CN 102682597 A 9/2012
 CN 102930642 2/2013
 CN 102976004 3/2013
 CN 103198562 7/2013
 CN 103226870 7/2013
 CN 203242065 10/2013
 CN 103440607 12/2013
 CN 103514641 1/2014
 CN 103544772 1/2014
 CN 203408902 1/2014
 CN 103662541 3/2014
 CN 103679147 A 3/2014
 CN 203520502 4/2014
 CN 103824387 A 5/2014
 CN 203588366 U 5/2014
 CN 103843040 6/2014
 CN 103954628 7/2014
 DE 10031532 10/2001
 EP 0116970 12/1991
 EP 0654003 5/1995
 EP 1168253 1/2002
 EP 1270905 1/2003

EP 1703436 9/2006
 EP 2428072 1/2018
 GB 2167553 5/1986
 HK 30014296 A 8/2020
 JP 7112801 5/1995
 JP H7334583 12/1995
 JP H11242005 9/1999
 JP 2000121564 4/2000
 JP 2000171409 A 6/2000
 JP 2000180371 6/2000
 JP 3123095 1/2001
 JP 2001312766 11/2001
 JP 2002019147 1/2002
 JP 2002183286 6/2002
 JP 2002259528 9/2002
 JP 2002302252 10/2002
 JP 2002324264 11/2002
 JP 2002358354 12/2002
 JP 2003139516 5/2003
 JP 2003230229 8/2003
 JP 2003242243 8/2003
 JP 2003264007 9/2003
 JP 2003267509 9/2003
 JP 2004021569 1/2004
 JP 2004191496 7/2004
 JP 2004239850 8/2004
 JP 2004288143 10/2004
 JP 2004303102 10/2004
 JP 2004341681 12/2004
 JP 2005063203 3/2005
 JP 2005122059 5/2005
 JP 2005308476 11/2005
 JP 2006127308 5/2006
 JP 2006195814 7/2006
 JP 2006203451 7/2006
 JP 2006227764 8/2006
 JP 2006260246 9/2006
 JP 2007141266 6/2007
 JP 2007155455 6/2007
 JP 2007179516 7/2007
 JP 2007265340 10/2007
 JP 2008045959 2/2008
 JP 2008293391 12/2008
 JP 2007086725 4/2009
 JP 2009175035 8/2009
 JP 2009245058 10/2009
 JP 2009250971 10/2009
 JP 2009290852 12/2009
 JP 2010177720 8/2010
 JP 2010276896 12/2010
 JP 2011518387 6/2011
 JP 2012504832 2/2012
 JP 2012058932 3/2012
 JP 2013033361 2/2013
 JP 2013037441 2/2013
 KR 20000064168 11/2000
 KR 20010074614 8/2001
 KR 20010097567 11/2001
 KR 100766860 10/2007
 KR 20130085255 7/2013
 KR 101329949 11/2013
 KR 20140037543 3/2014
 WO WO8503790 8/1985
 WO WO2001015096 3/2001
 WO WO2002005176 1/2002
 WO WO0221090 3/2002
 WO WO2002025613 3/2002
 WO WO2002039357 5/2002
 WO WO2003012717 2/2003
 WO WO2003014994 2/2003
 WO WO2004021114 3/2004
 WO WO2004114490 12/2004
 WO WO2005008566 1/2005
 WO WO2005101346 10/2005
 WO WO2006021825 3/2006
 WO WO2006058601 6/2006
 WO WO2006080851 8/2006
 WO WO2007066166 6/2007
 WO WO2009089607 7/2009

(56)

References Cited

FOREIGN PATENT DOCUMENTS

WO	WO2009128173	10/2009
WO	WO2009128176	10/2009
WO	WO2009129526	10/2009
WO	WO2010040116	4/2010
WO	WO2010128267	11/2010
WO	WO2010128315	11/2010
WO	WO2011131016	10/2011
WO	WO2012073126	6/2012
WO	WO2013002748	1/2013
WO	WO2013074819	5/2013
WO	WO2014075055	5/2014
WO	WO2014141180	9/2014
WO	WO2015022409	2/2015
WO	WO2015093676	6/2015
WO	WO201508864	7/2015
WO	WO2016181224	11/2016
WO	WO2015196175	12/2016
WO	WO2017034441	3/2017

OTHER PUBLICATIONS

3GPP Organizational Partners, “3rd Generation Partnership Project; Technical Specification Group Terminals; AT command set for GSM Mobile Equipment (ME),” Global System for Mobile Communications, 1998, 124 pages.

Aftermarket Cellular Accessories, “Cellular Phone Model Identification,” retrieved from <http://web.archive.org/web/20060328064957/http://aftermarketcellular.com/ic/identification.html> on Mar. 16, 2014, published Mar. 28, 2006, 3 pages.

Altec Lansing User’s Guide 2007, 8 pages.

Bhule et al., “Environmental and economic trade-offs In consumer electronic products recycling: a case study of cell phones and computers,” IEEE International Symposium on Electronics and the Environment, Conference Record, 2004.

Bournique, D.: “Mobile Karma Shuts Down as iCloud and Blacklists Challenge Used Phone Buyers”, Prepaid Phone News, Jul. 23, 2014 (Jul. 23, 2014), XP055229747, Retrieved from the Internet <URL:<http://www.prepaidphonenews.com/2014/07/mobile-karma-shuts-down-as-icloud-and.html>>; accessed Nov. 27, 2017; 2 pages. Business Wire, “The World’s First Office Photography Machine” at CES 2008 Launched by Ortery Technologies, Jan. 7, 2008, 3 pages. CNET, “Tackling LCD “burn ins“, and dead/stlck Pixels”, published Sep. 2, 2009, retrieved from <http://www.cnet.com/news/tackling-lcd-burn-ins-and-deadstuck-pixels/>.

Cybercom Group Europe AB, “OMSI Forum,” Downloads, 2005, 2 pages.

Cybercom Group Europe AB, “OMSi Provides Easy Service and Maintenance for Mobile Phones,” Press Release, 2005, 1 page.

Cybercom Group Europe AB, “The OMSI 2.0 Interface Supports,” OMSI 2.0 Description, available at least before Oct. 2008, 1 page.

Cybercom Group, “Leading Telecom Organisations Address Device Management Issues,” Press Release, 2007, 1 page.

Evgenii Masunov, Mar. 25, 2010, http://www.appleinsider.ru/news/ipone-obladaet-luchshim-tachskrinom-provereno_robotom.html, 4 pages.

Foster et al., “Automated Visual Inspection: A Tutorial” 1990 Computers Ind. Engng. vol. 18(4): 493-504.

Geekanoids, You Tube Video, “Apple iPhone 3GS Unboxing and Review”, uploaded on Jun. 19, 2009, retrieved from <http://www.youtube.com/watch?v=GCEi9QAeDqk> on Sep. 2, 2009.

Geyer et al. “The economics of cell phone reuse and recycling,” The International Journal of Advanced Manufacturing Technology, 47(5): 515-525, 2010.

Graffia et al., “Retail Station for E-Device Identification, Assessment, and Trade-in”, Jun. 6, 2014 (Drawings and Specification) (Year: 2014).

GSM Arena Glossary, “LCD (Liquid Crystal Display”, retrieved from <http://www.gsmarena.com/glossary.php3?term=lcd> on Apr. 28, 2016, 1 page.

International Numbering Plan, www.numberingplans.com, 2 pages. Investopedia: What’s the difference between weighted average accounting and FIFO/LIFO accounting methods? Aug. 19, 2010. Accessed via archive.org [<https://web.archive.org/web/20100819200402/http://www.investopedia.com/ask/answers/09/weighted-average-fifo-lifo-accounting.asp>].

Kanter, James Max, “Color Crack:Identifying Cracks in Glass,” dated Dec. 9, 2014; retrieved from the internet http://www.jmaxkanter.com/static/papers/color_crack.pdf on Sep. 22, 2017.

Lambert, Emily, “Use It Up, Wear It Out”, Forbes 175.5 (2005): 77-78. Business Source Complete. Web. Jan. 6, 2015, 3 pages.

Littleton Partners with Donations ink (Jan. 19, 2006) US Fed News Service, Including US State News. Web. Jan. 6, 2015, 1 page.

MobileGazette.com, “2006 in Review: The Good, The Bad and The Ugly”, published Dec. 2006, retrieved from <http://www.mobilegazette.com/2006-review-06x12x22.htm> on Nov. 11, 2015.

Oliveira, et al., “Automatic crack detection on road imagery using anisotropic diffusion and region linkage,” 18th European Signal Processing Conference (EUSIPCO—2010), Aug. 23, 2010, pp. 274-278.

PC World, “Wipe Your Cell Phone’s Memory Before Giving it Away”, published Jan. 2006, retrieved from <http://www.washingtonpost.com/wp-dyn/content/article/2006/01/30/AR2006013001144.html> on Nov. 10, 2015.

Perng et al., “A Novel Vision System for CRT Panel Auto-Inspection”, Journal of the Chinese Institute of Industrial Engineers, vol. 24, No. 5, pp. 341-350 (2007).

Perng et al., “A Novel Vision System for CRT Panel Auto-Inspection”, Proceedings of the 2005 IEEE International Conference on Mechatronics, Jul. 10-12, 2005, p. 4.

Phifer, “How io Use your 3G Phone as a Wireless Broad Band Modem,” Computer Weekly News, 2007, 6 pages.

Rawson, Chris, “TUAW: 25 Ways to Check the Hardware on Your iPhone 4”, published Aug. 12, 2010, retrieved at <http://www.tuaw.com/2010/08/13/hardware-test-your-iphone-4/> on Feb. 28, 2014.

Rehg et al. “Vision for a Smart Kiosk” IEEE, Computer Society Conference on Computer Vision and Pattern Recognition (1997).

RMS Communications Group, “RMS Communications Group Inc. opens cell phone kiosk at Ocean City Mall in Toms River, N.J.”, retrieved from <http://www.prweb.com/releases/2004/11/prweb177351.htm>, Nov. 12, 2004, 2 pages.

Rolf Steinhilper “Remanufacturing: The Ultimate Form of Recycling”, Fraunhofer IRBVerlag, 1998, parts 1-3, http://www.reman.org/Publications_main.htm.

Romano “Recycling a Phone at EcoATM is an Easy Route to Feeling Green,” Xconomy, Jan. 22, 2014, pp. 1-3.

Rosebrock, “How to Build a Kick-Ass Mobile Document Scanner in Just 5 Minutes” Pylmage Search, Sep. 2014, 19 pages.

Shotton et al., “Efficiently Combining Contour and Texture Cues for Object Recognition”, Proceedings of the British Machine Vision Conference 2008, (Sep. 1, 2008), pp. 7.1-7.10 * abstract *.

SimplySellular, “Get Cash for your Old Cell Phone”, published Apr. 2, 2010, retrieved from <http://simplysellular.com/conditions.php> on Jan. 6, 2015, 2 pages.

Sony Ericsson Mobile Communications AB, “P800/P802,” White Paper, 2003, 128 pages.

Sony Ericsson Mobile Communications AB, “T68i/T68ie,” White Paper, 2002, 71 pages.

Tecace Software: “Your phone appraisal—Movaluate—Android Apps on Google Play”, Android Apps on Google Play, Aug. 12, 2013 (Aug. 12, 2013), XP055230264, Retrieved from the Internet <URL:<https://play.google.com/store/apps/details?id=com.tecace.android.app.movaluate&hi=en>>; accessed Nov. 27, 2017; 2 pages. Trading devices for dollars, The Economist (US) 405.8813:8 (US), Economist Intelligence Unit N.A. Incorporated, Dec. 1, 2012.

Turner, “5 MP3 Players for Pumping Up Your Workouts,” Mashable.com, Nov. 4, 2010, available online at <https://mashable.com/2010/11/04/mp3-players-for-sports/> (Year: 2010).

Wagh, “Phone recycling machine lets you drop in old mobiles—and spits out cash instantly,” Daily Mail Online, Jan. 13, 2012, p. 1-2.

Wikipedia, “Machine Vision” Sep. 19, 2009, 6 pages.

Wiley Encyclopedia of Computer Science and Technology (2009).

(56)

References Cited

OTHER PUBLICATIONS

Wilson, Doug, "Liquid Crystal Display (LCD) Inspection System", National Instruments Case Study, available May 10, 2009, retrieved from <http://sine.ni.com/cs/app/cod/p/id/cs-345> on Jan. 5, 2015, 2 pages.

Yahoo Answers, "What is a Clean ESN?" published Jun. 23, 2009, retrieved from <http://web.archive.org/web/20090623215042/http://answers.yahoo.com/question/index?qid=20080318061012AANFRco> on Apr. 3, 2014.

Zhang, Yiyang, "The design of glass crack detection system based on image preprocessing technology," 2014 IEEE 7th Joint International Information Technology and Artificial Intelligence Conference, IEEE, Dec. 20, 2014: pp. 39-42.

Non-Final Office Action dated Aug. 24, 2017 in U.S. Appl. No. 15/630,539, 23 pages.

Non-Final Office Action dated Dec. 29, 2017 in U.S. Appl. No. 14/873,158, 14 pages.

Non-Final Office Action dated Oct. 16, 2020 in U.S. Appl. No. 16/575,003, 11 pages.

Non-Final Office Action dated Oct. 22, 2018 in U.S. Appl. No. 16/556,018, 7 pages.

Non-Final Office Action dated Sep. 15, 2021 in U.S. Appl. No. 16/556,018, 6 Pages.

Non-Final Office Action Response filed Dec. 10, 2021 in U.S. Appl. No. 16/556,018, 10 Pages.

Final Office Action dated Jan. 6, 2022 in U.S. Appl. No. 16/556,018, 8Pages.

Final Office Action dated Apr. 5, 2022 in U.S. Appl. No. 16/556,018, 13 Pages.

Non-Final Office Action dated Apr. 13, 2022 in U.S. Appl. No. 16/556,018, 5 Pages.

Non-Final Office Action Response filed Jul. 13, 2022 in U.S. Appl. No. 16/556,018, 10 Pages.

Non-Final Office Action dated Sep. 26, 2022 in U.S. Appl. No. 16/556,018, 6 Pages.

Non-Final Office Action dated Sep. 8, 2017 in U.S. Appl. No. 14/873,145, 13 pages.

Non-Final Office Action Response filed Apr. 22, 2019 in U.S. Appl. No. 14/873,145, 13 pages.

Non-Final Office Action response filed Mar. 16, 2021 in U.S. Appl. No. 16/575,003, 13 pages.

Non-Final Office Action Response filed Mar. 29, 2018 in U.S. Appl. No. 14/873,158, 18 pages.

Non-Final Office Action Response filed Nov. 2, 2017 in U.S. Appl. No. 15/630,539, 15 pages.

Non-Final Office Action Response Filed Sep. 8, 2017 in U.S. Appl. No. 15/630,508, 19 pages.

Notice of Allowance dated Jan. 17, 2018 in U.S. Appl. No. 15/630,539 of Bowles et al., filed Jun. 22, 2017.

Notice of Allowance dated Jun. 28, 2019 in U.S. Appl. No. 16/575,003, 9 pages.

Notice of Allowance dated Jun. 28, 2021 in U.S. Appl. No. 16/575,003, 15 pages.

Notice of Allowance dated May 6, 2019 in U.S. Appl. No. 14/873,158, 7 pages.

Notice of Allowance dated May 7, 2019 in U.S. Appl. No. 15/630,508 of Silva, J., et al., filed Jun. 22, 2017.

Notice of Allowance dated Sep. 5, 2019 in U.S. Appl. No. 15/630,508, 7 pages.

Notice of Allowance dated Sep. 9, 2019 in U.S. Appl. No. 15/630,508 of Silva, J., et al., filed Jun. 22, 2017.

Final Office Action dated Apr. 19, 2018 in U.S. Appl. No. 15/630,508, 15 Pages.

Final Office Action dated Jul. 23, 2018 in U.S. Appl. No. 14/873,158, 13 pages.

Final Office Action Response filed Apr. 3, 2019 in U.S. Appl. No. 14/873,158, 13 Pages.

Final Office Action Response filed Mar. 25, 2019 in U.S. Appl. No. 14/873,158, 14 pages.

Restriction Requirement dated Jul. 2, 2021 in U.S. Appl. No. 16/556,018, 6 Pages.

Restriction Requirement response filed Sep. 2, 2021 in U.S. Appl. No. 16/556,018, 6 Pages.

International Search Report and Written Opinion dated Dec. 20, 2021 in International Application No. PCT/US2021/071269, 14 pages.

International Search Report and Written Opinion dated Dec. 22, 2015 in International Application No. PCT/US2015/053591, 18 pages.

International Search Report and Written Opinion dated Jun. 10, 2015 in International Application No. PCT/US2015/014139. 9 pages.

Decision to Refuse Application dated Sep. 25, 2020, EP17180663.1, 7pgs.

Declaration in Support of Written Submissions Jul. 8, 2020, EP17180663.1, 3pgs.

Written Submissions Arguments and Claims Filed Apr. 23, 2020, EP17180663.1, 6pgs.

Preliminary Opinion in Response to Written Submissions, dated Jul. 6, 2020, U.S. Appl. No. 15/630,460, 5pgs.

Final Office Action dated Feb. 1, 2018 in U.S. Appl. No. 15/630,460, 47 pages.

Non-Final Office Action dated Sep. 1, 2017 in U.S. Appl. No. U.S. Appl. No. 15/630,460, 23 pages.

Non-Final Office Action Response filed Nov. 29, 2017 in U.S. Appl. No. 15/630,460, , 16 pages.

Final Office Action Response as Appeal Brief filed Jun. 19, 2018 in U.S. Appl. No. 15/630,460, 24pages.

Examiner's Answer to Appeal Briefs dated Sep. 28, 2018 in U.S. Appl. No. 15/630,460, 16 pages.

Supplemental Appeal Brief filed Apr. 9, 2020 in U.S. Appl. No. 15/630,460, 4 pages.

Notice of Allowance dated Jul. 6, 2020 in U.S. Appl. No. 15/630,460, 8 pages.

Final Office Action dated Mar. 3, 2023 in U.S. Appl. No. 16/556,018, 9 Pages.

Non-Final Office Action Response filed Jan. 26, 2023 in U.S. Appl. No. 16/556,018, 12 Pages.

* cited by examiner

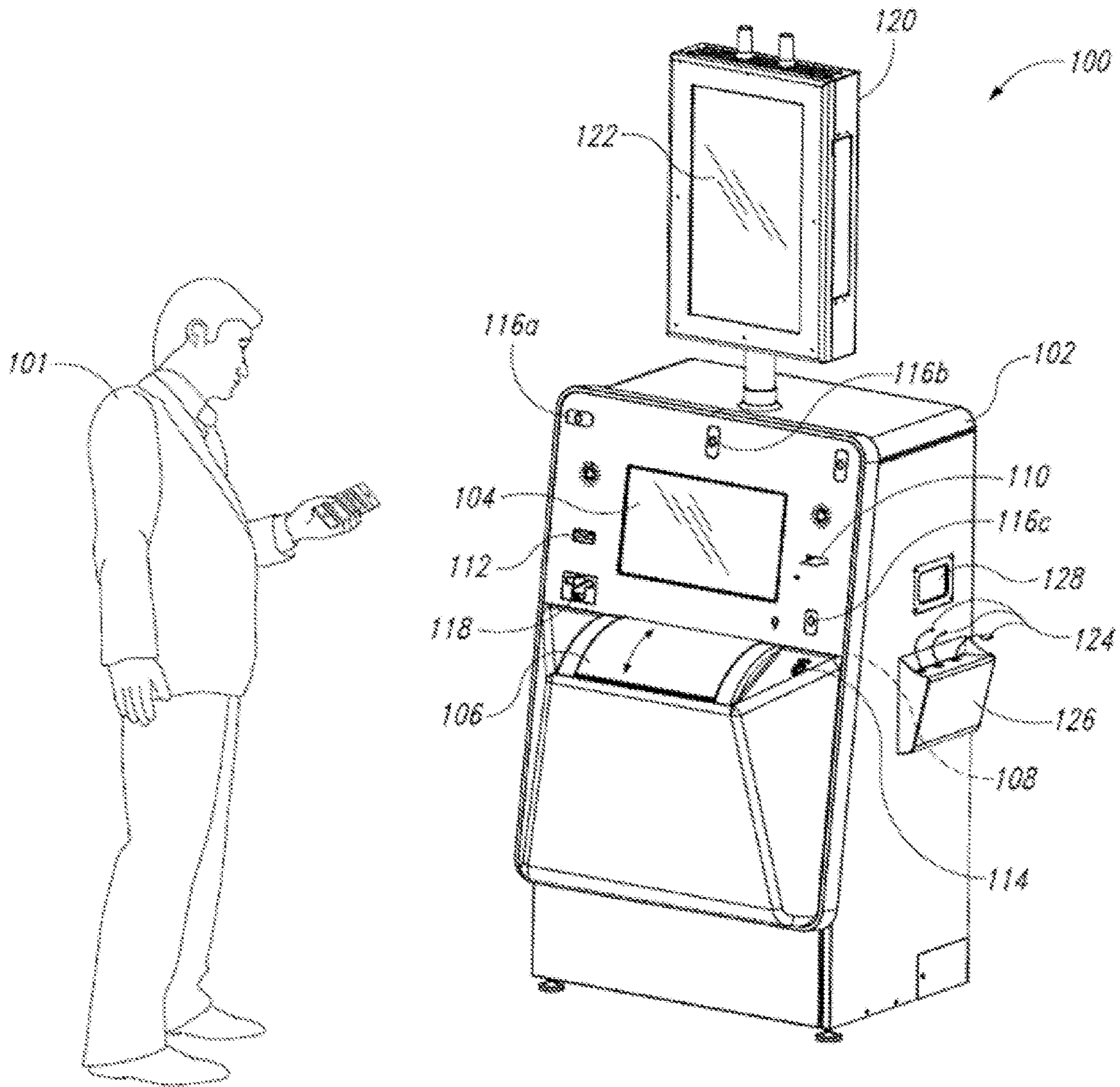

FIG. 1

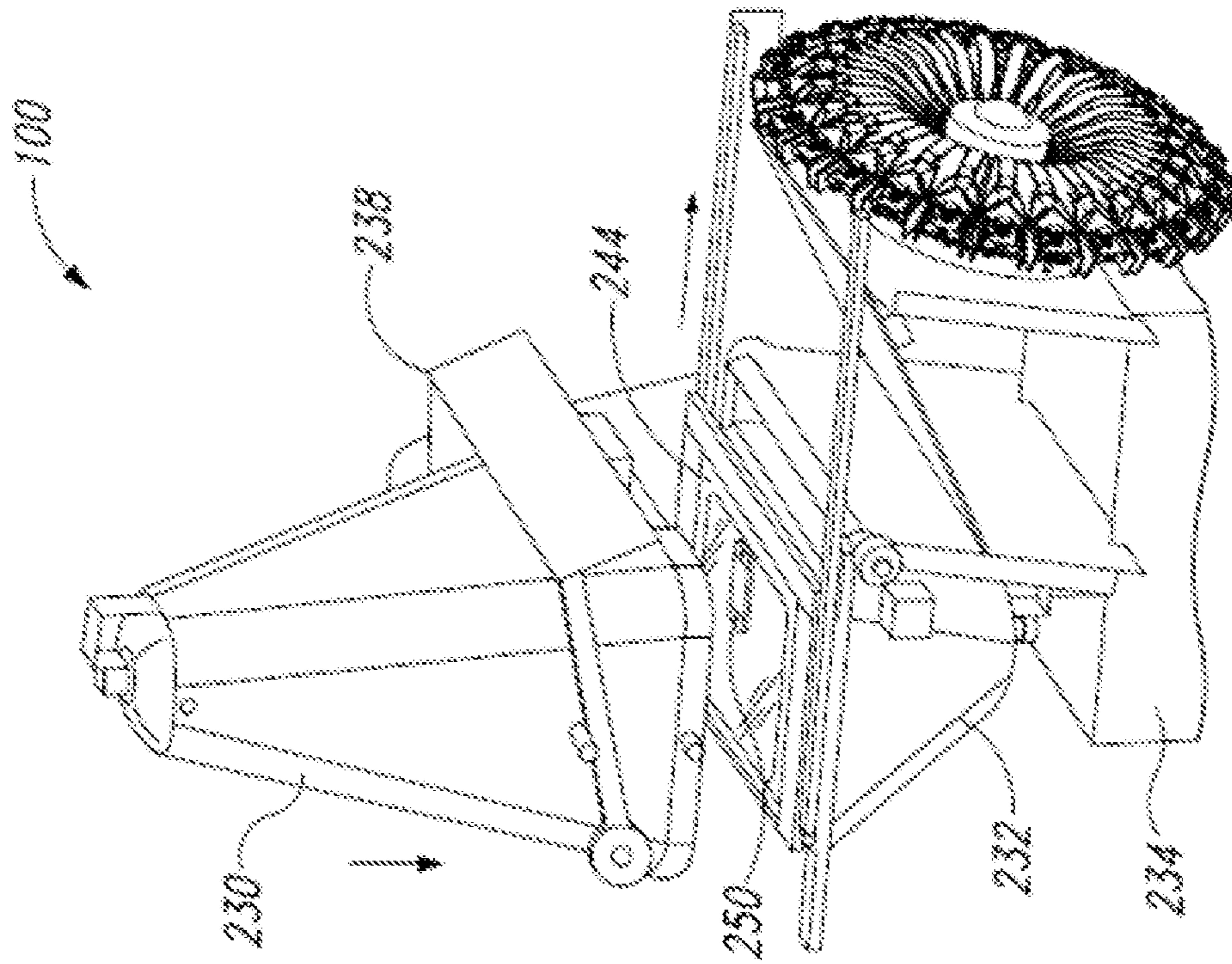

FIG. 2B

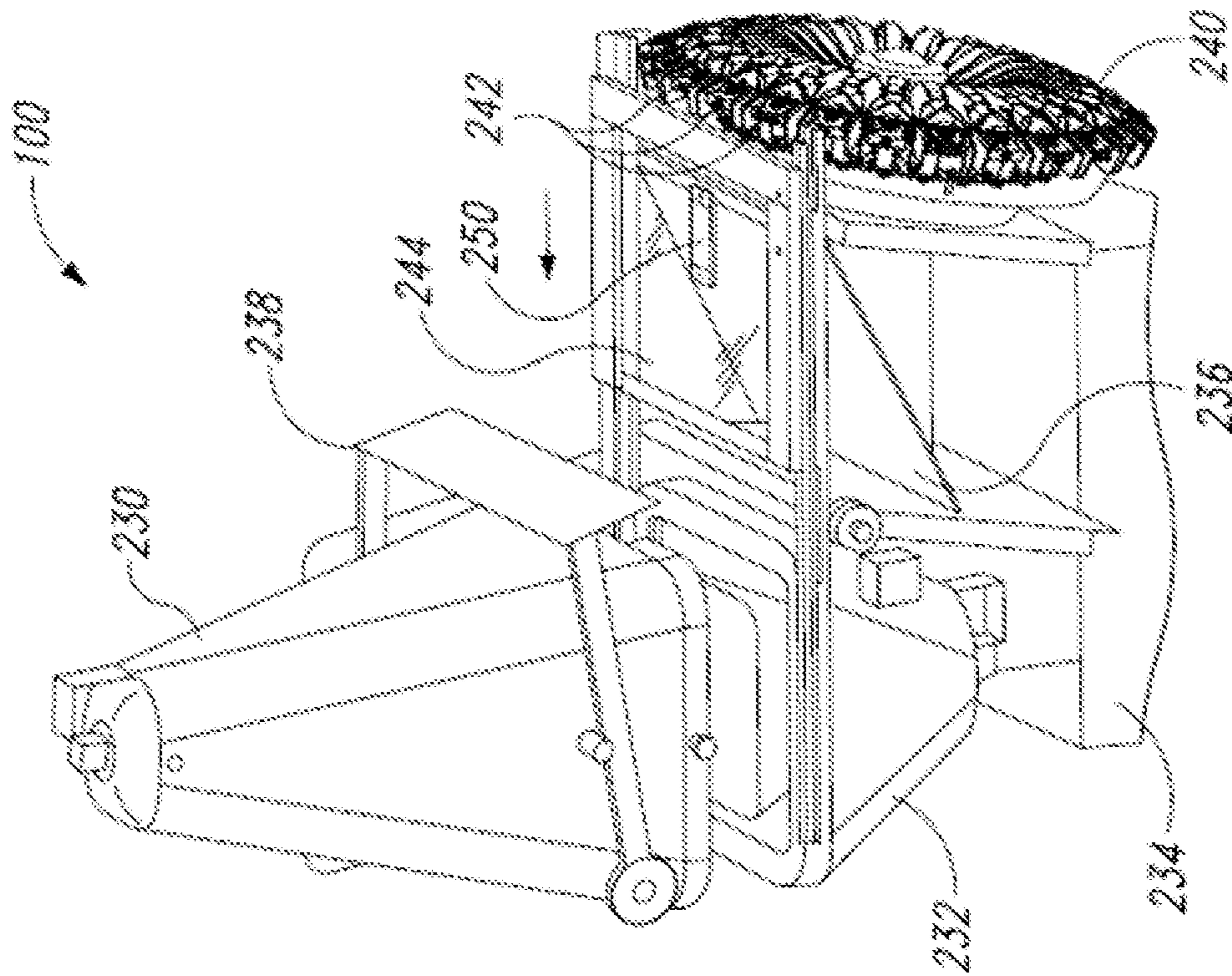

FIG. 2A

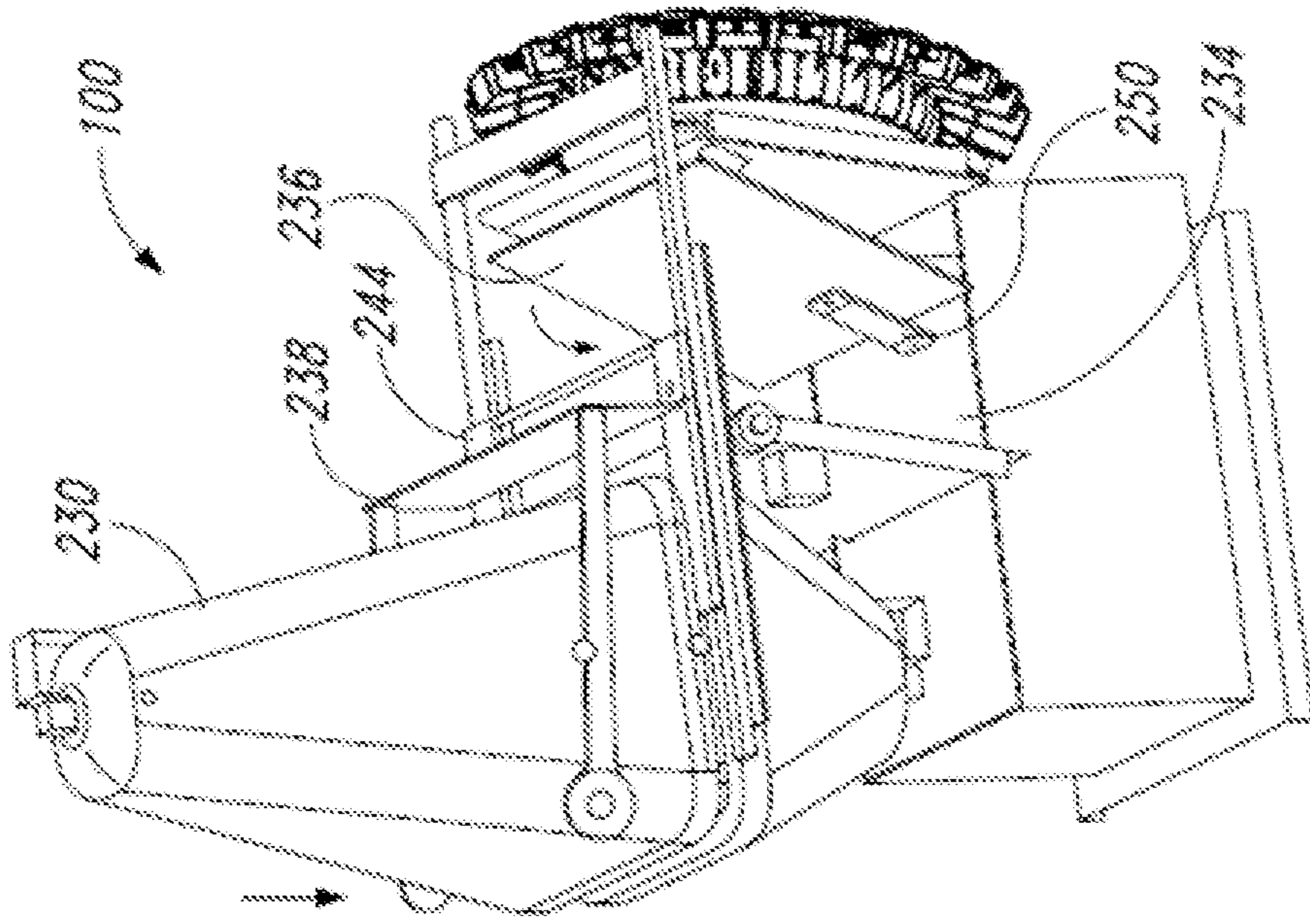

FIG. 2D

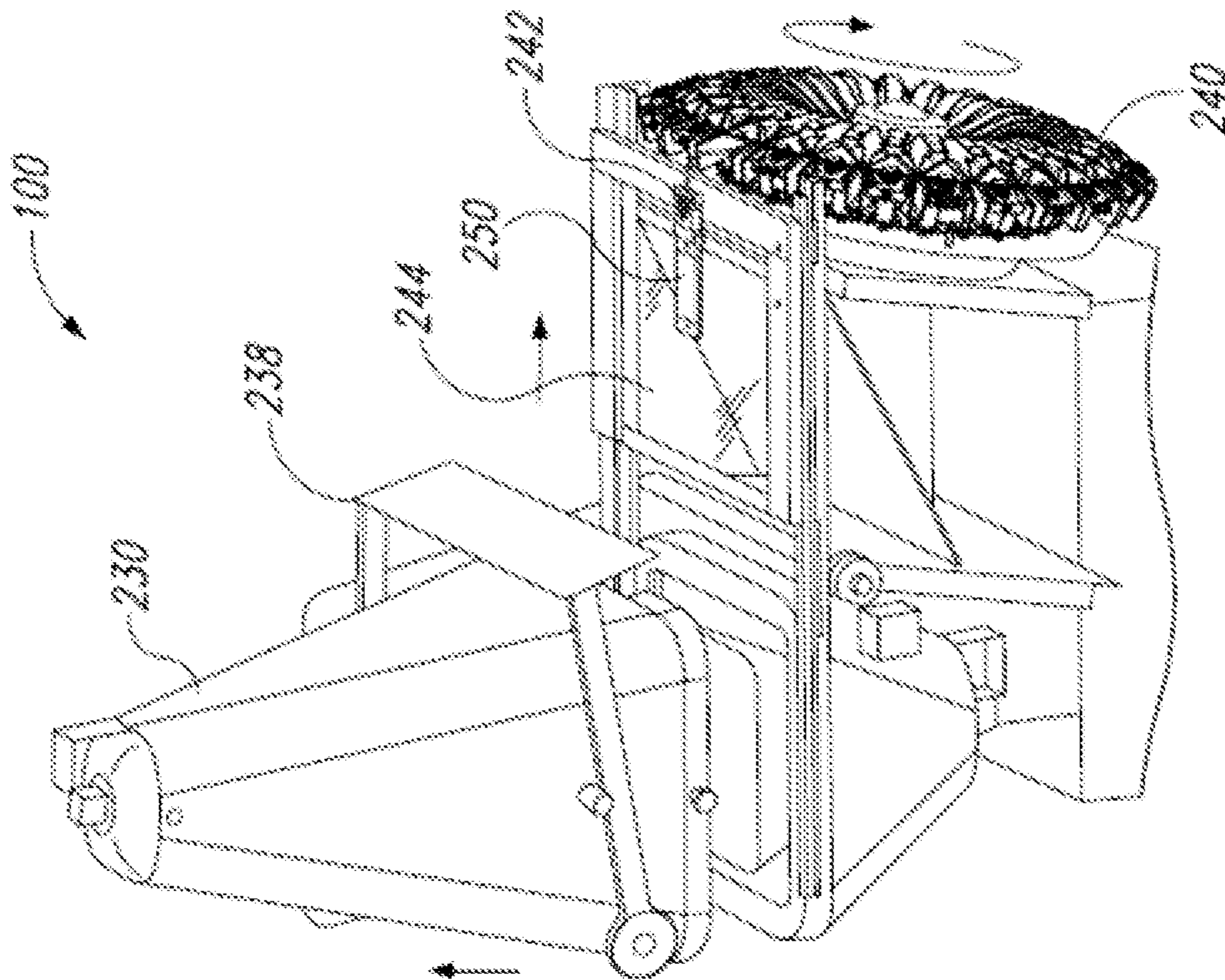

FIG. 2C

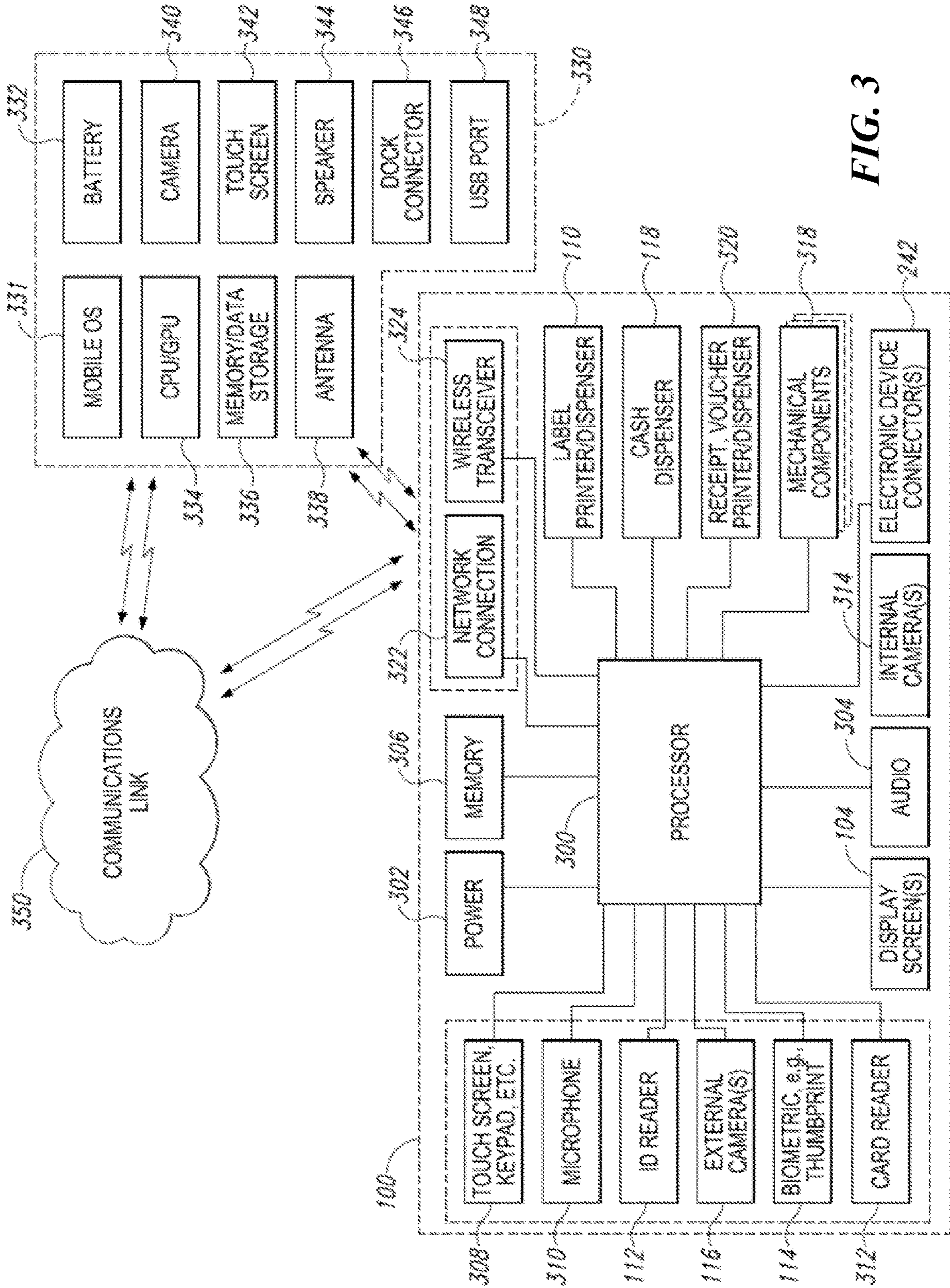

FIG. 3

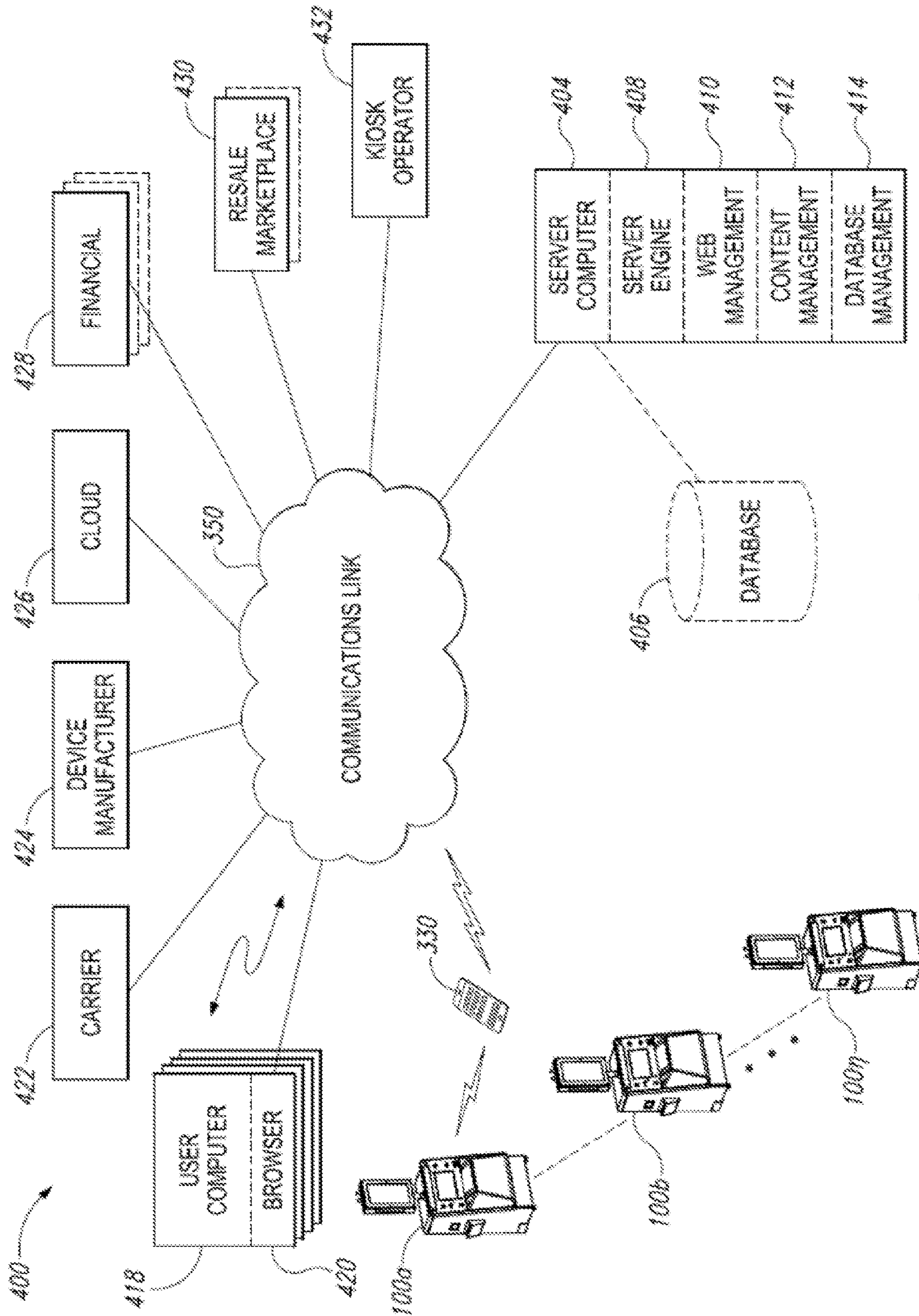

FIG. 4

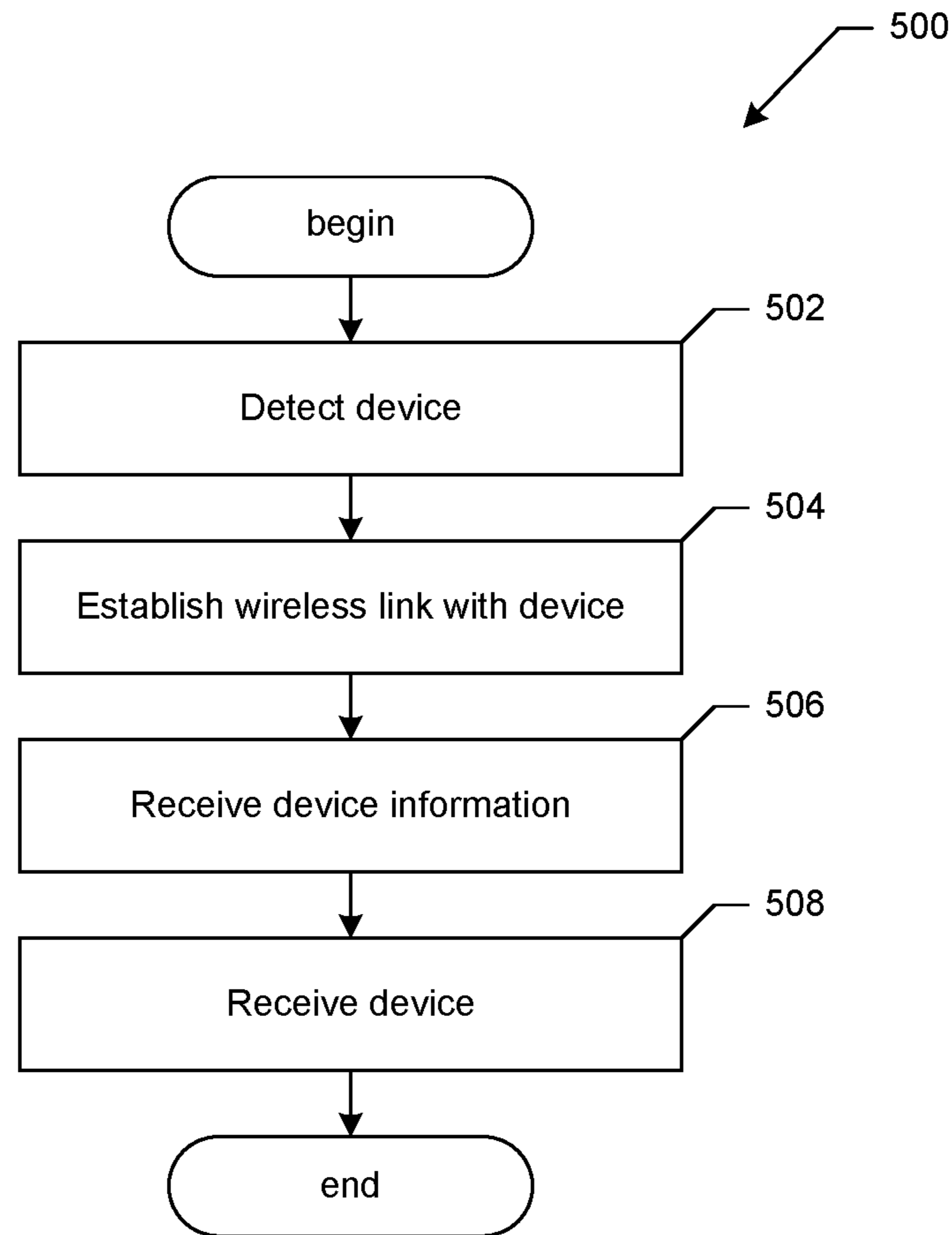

FIG. 5

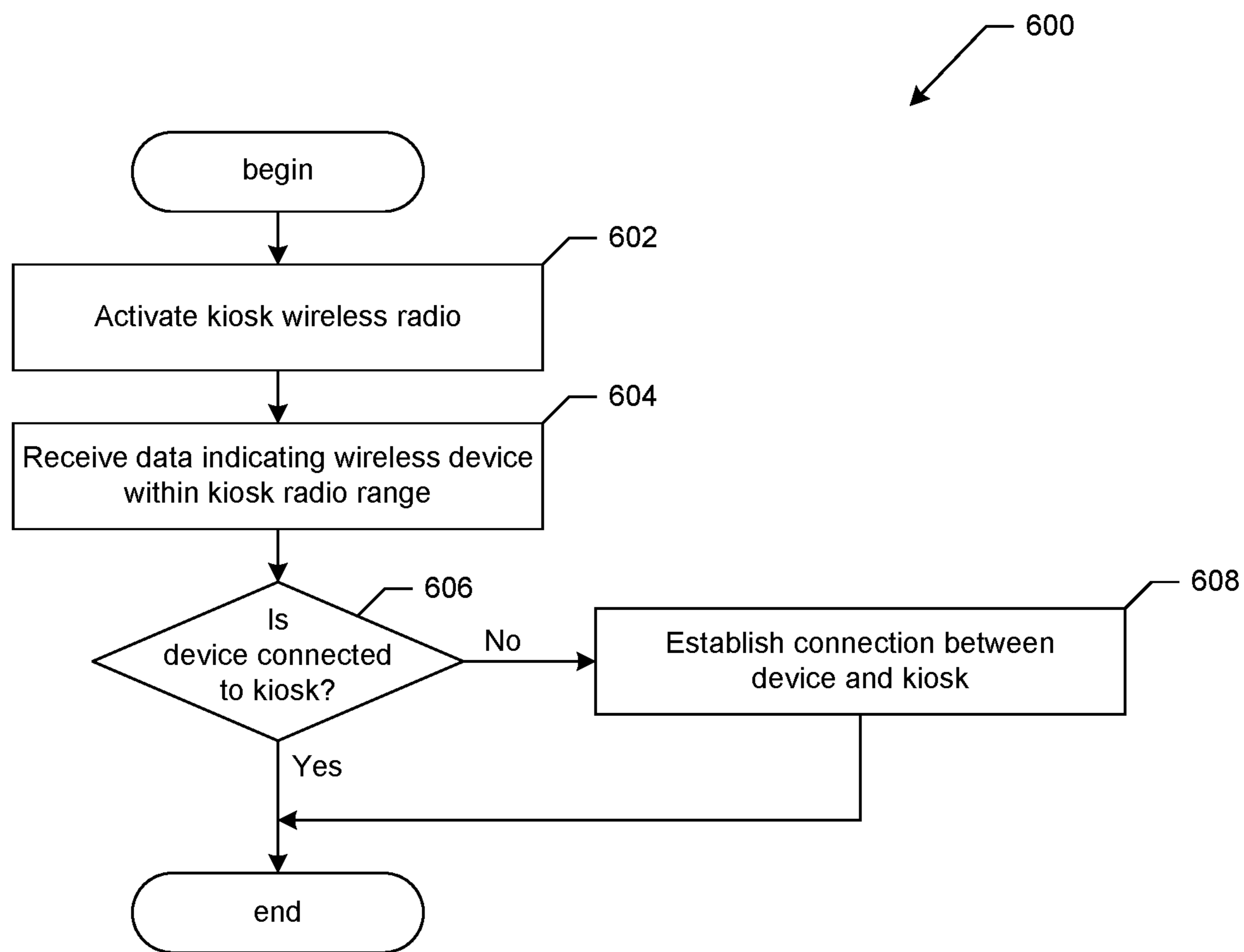

FIG. 6

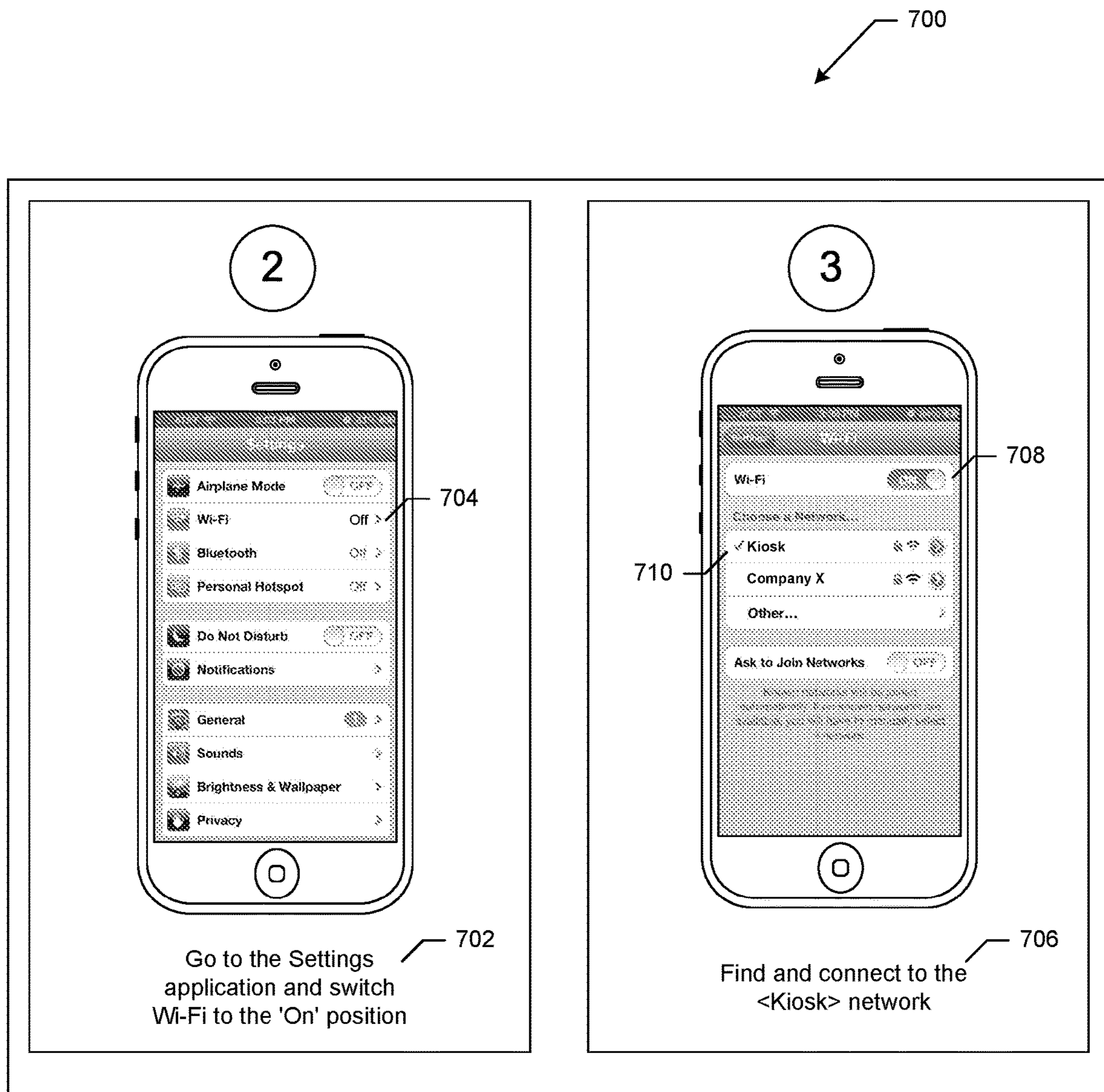

FIG. 7

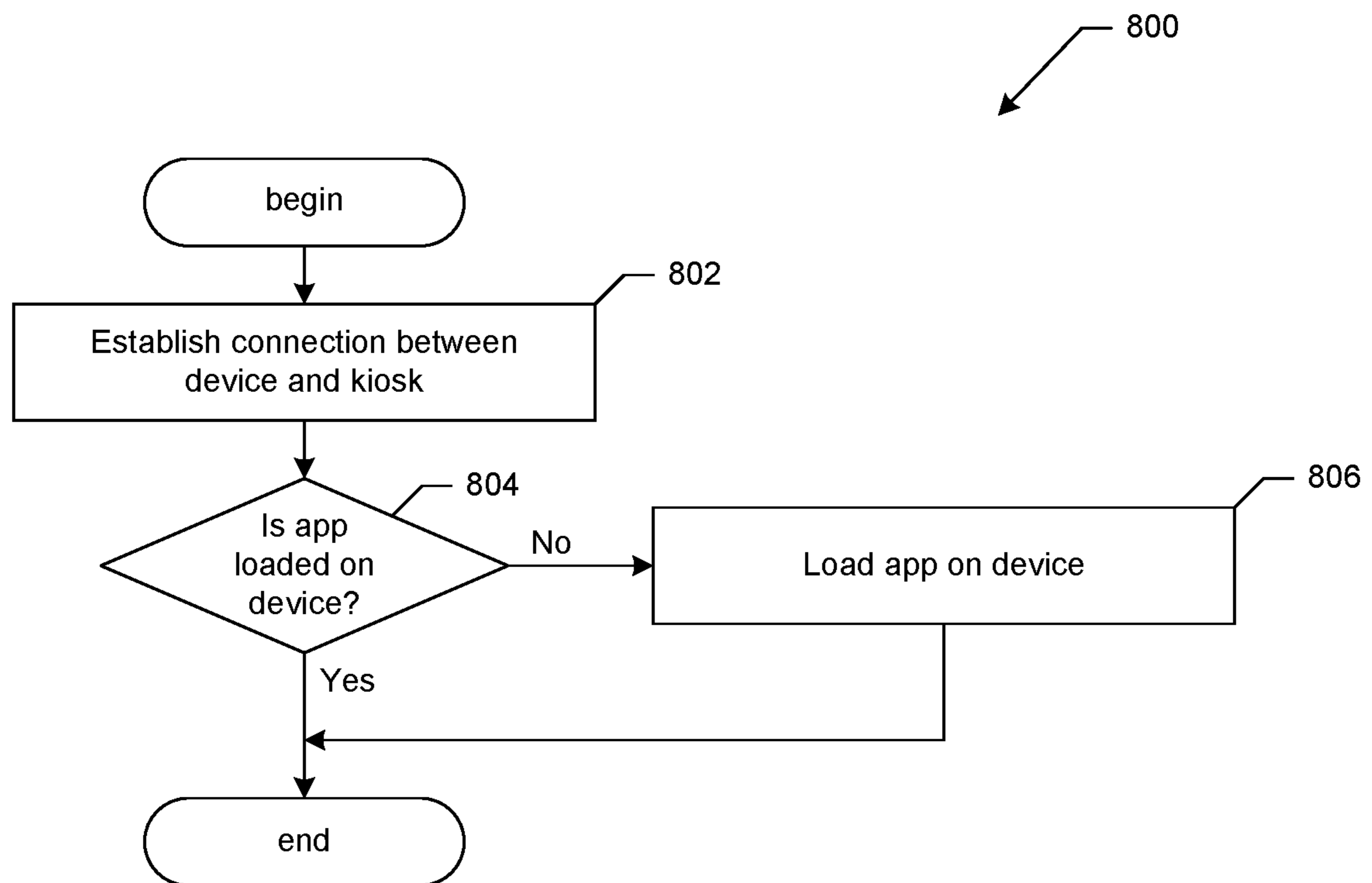

FIG. 8

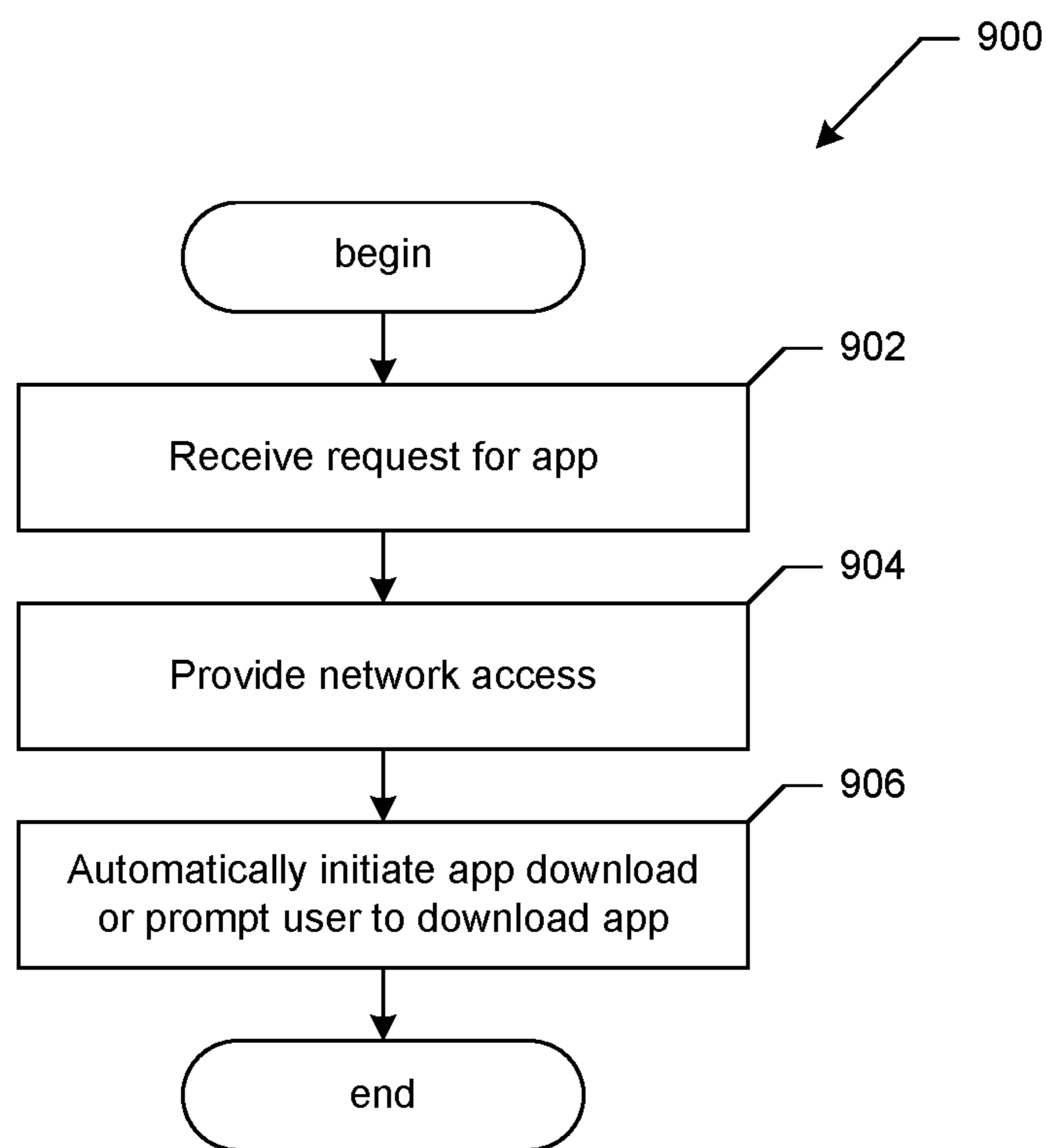

FIG. 9

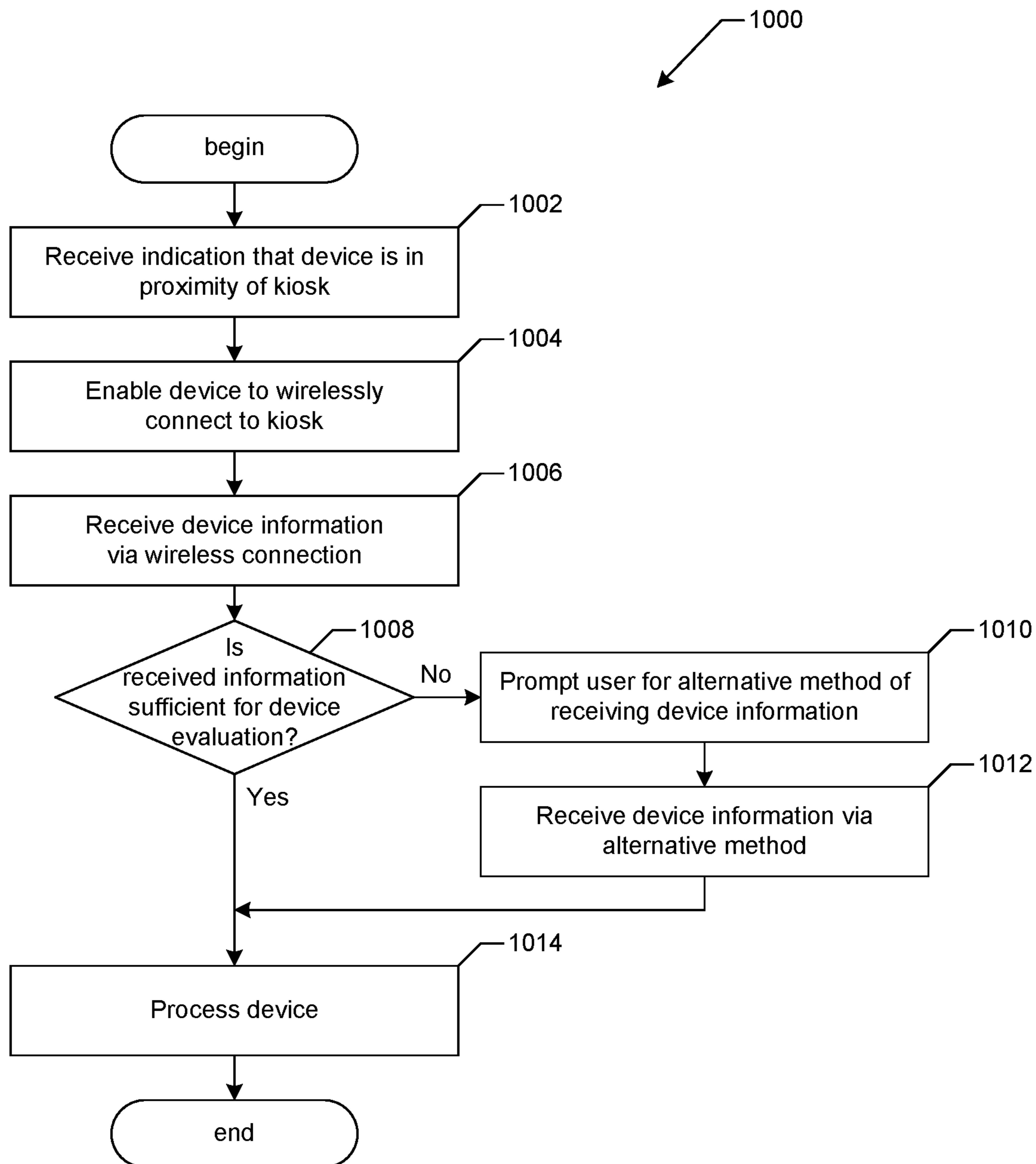

FIG. 10

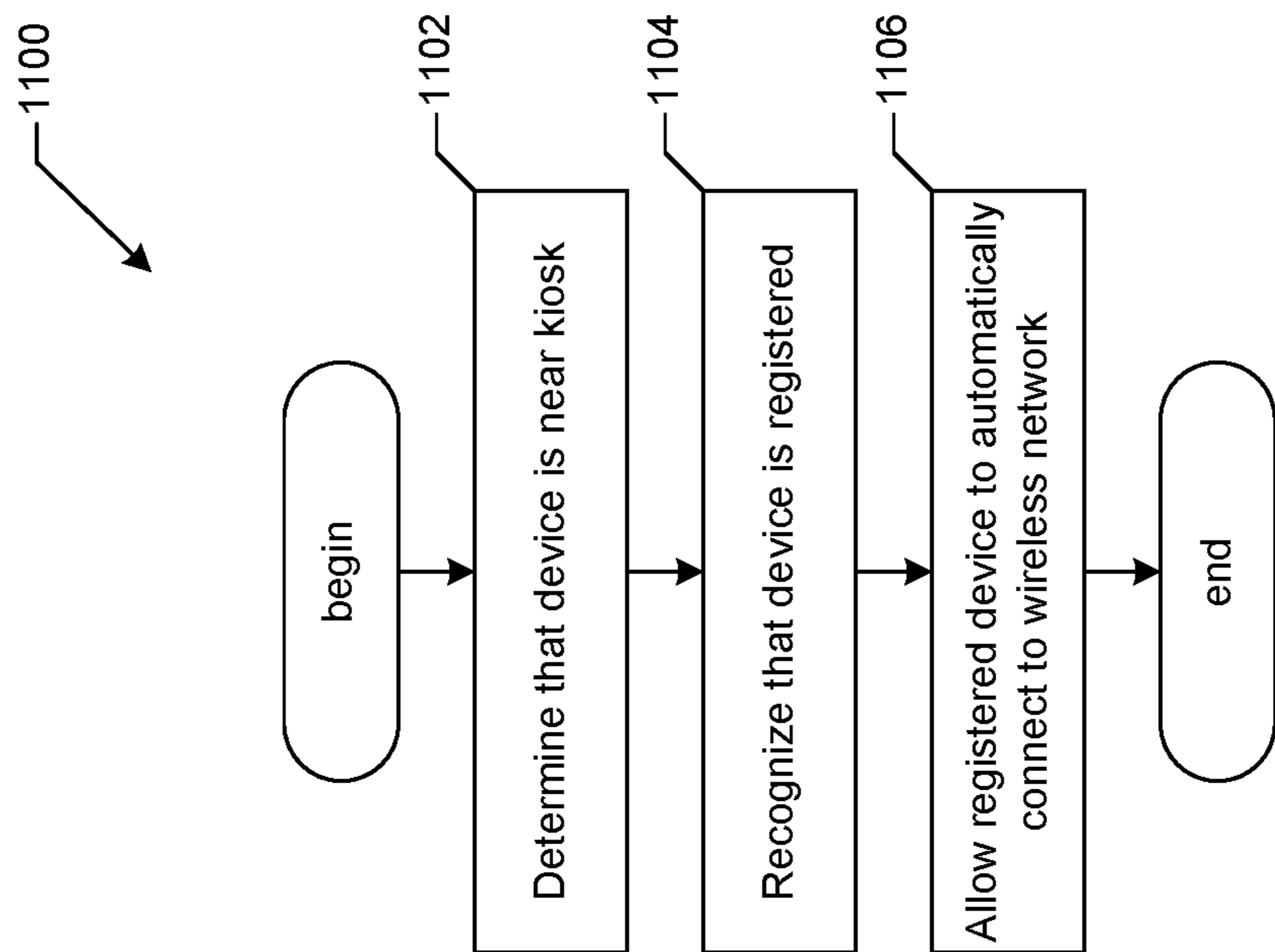
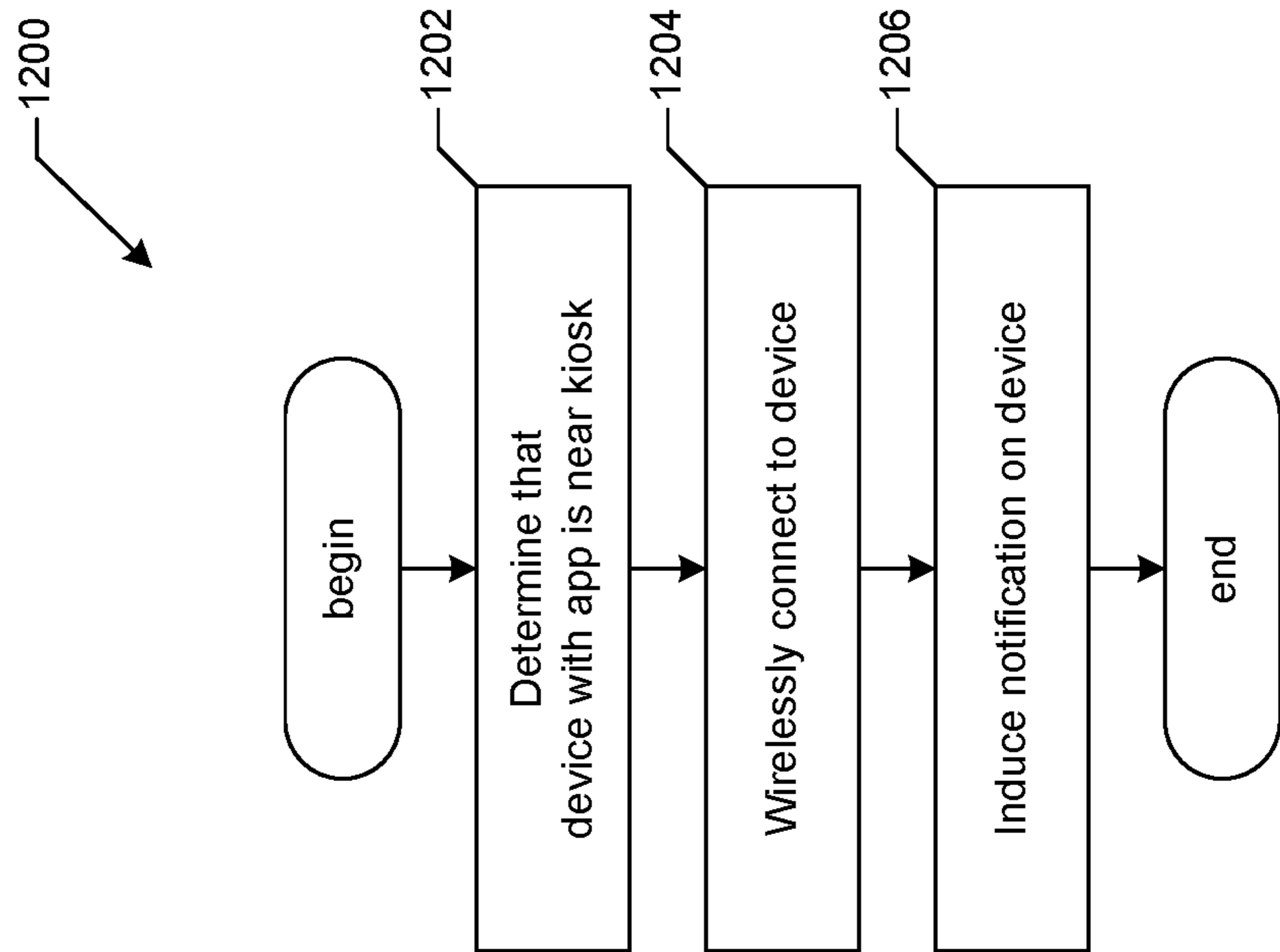

FIG. 12

FIG. 11

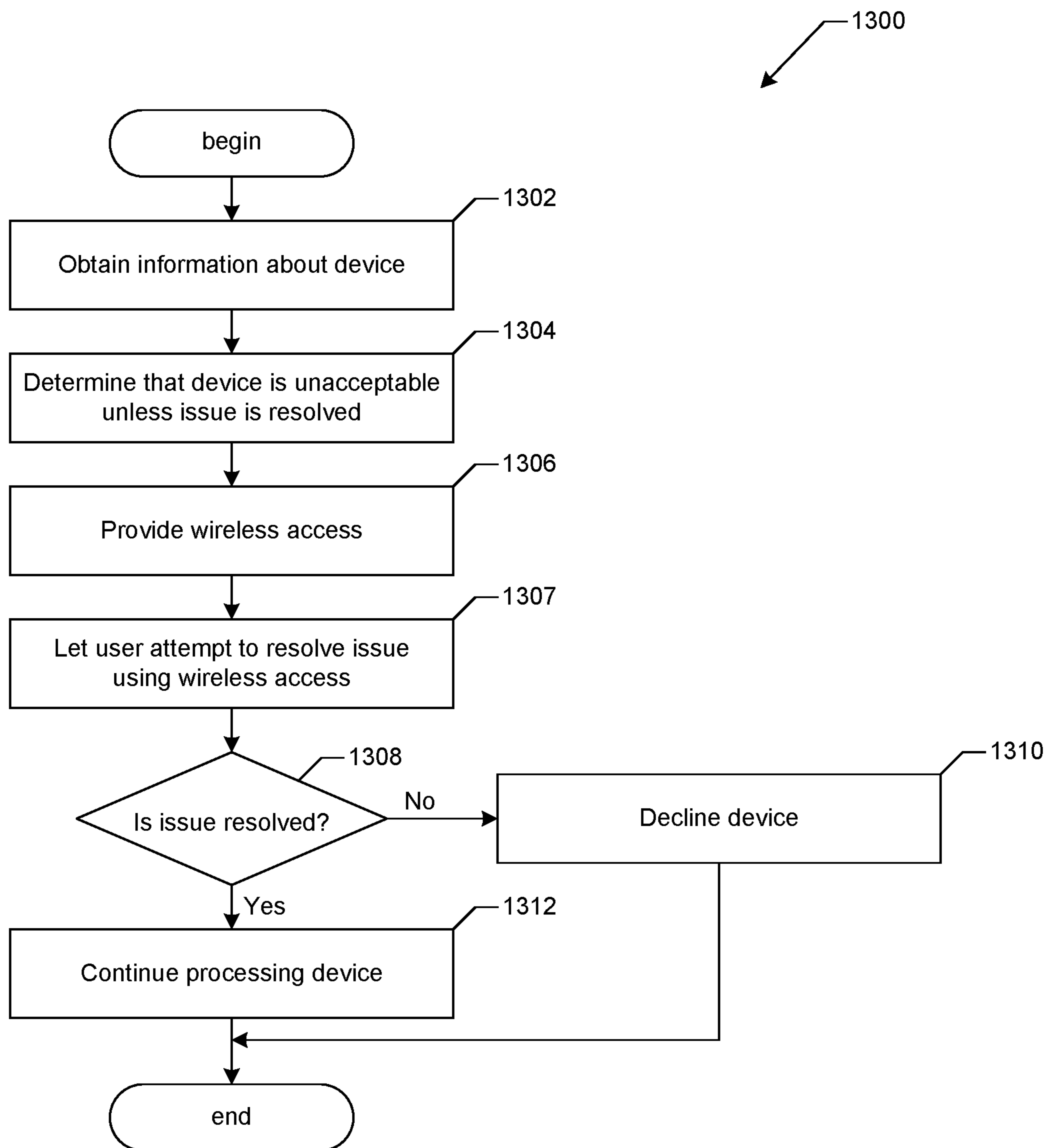

FIG. 13

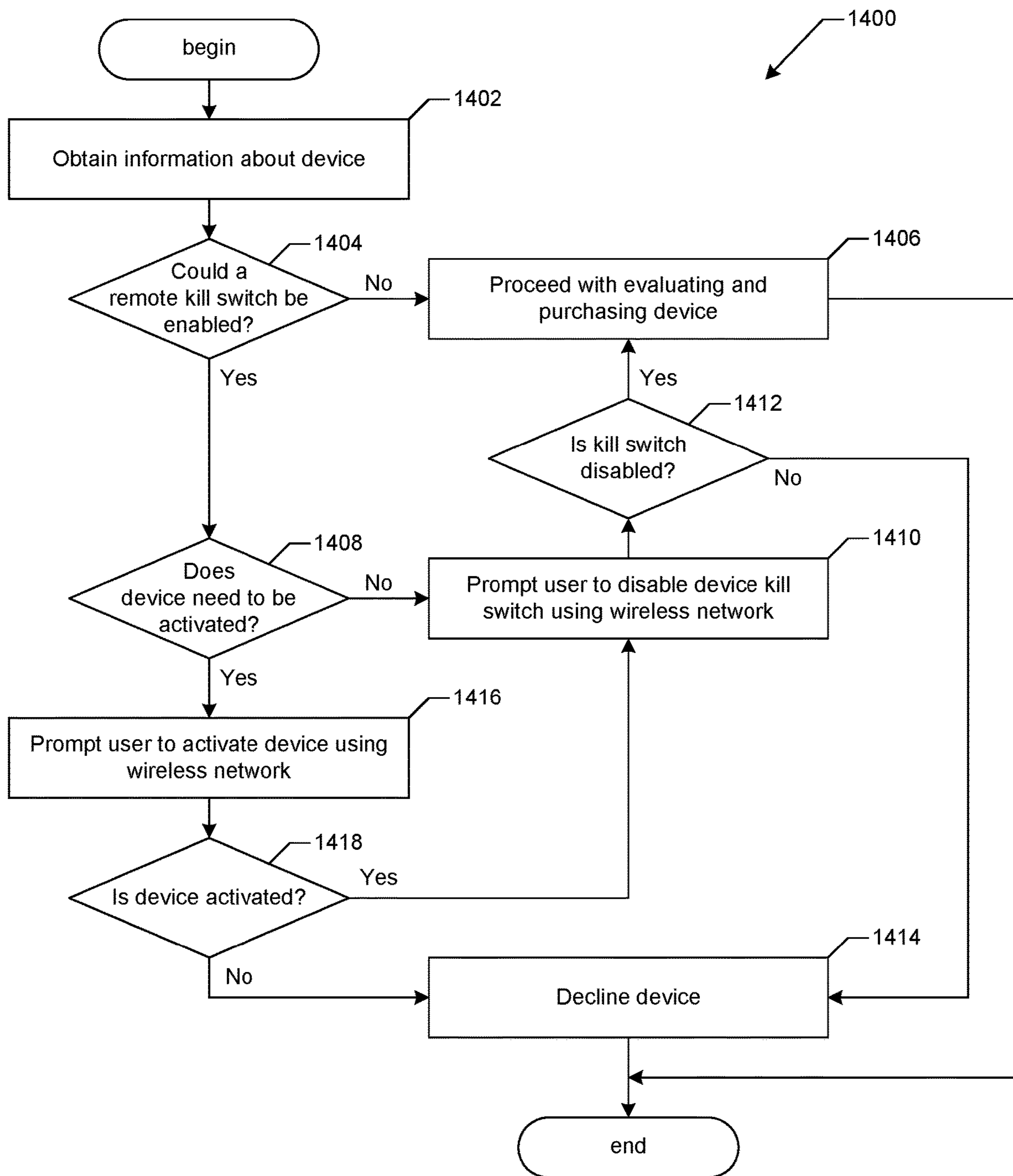

FIG. 14

1510

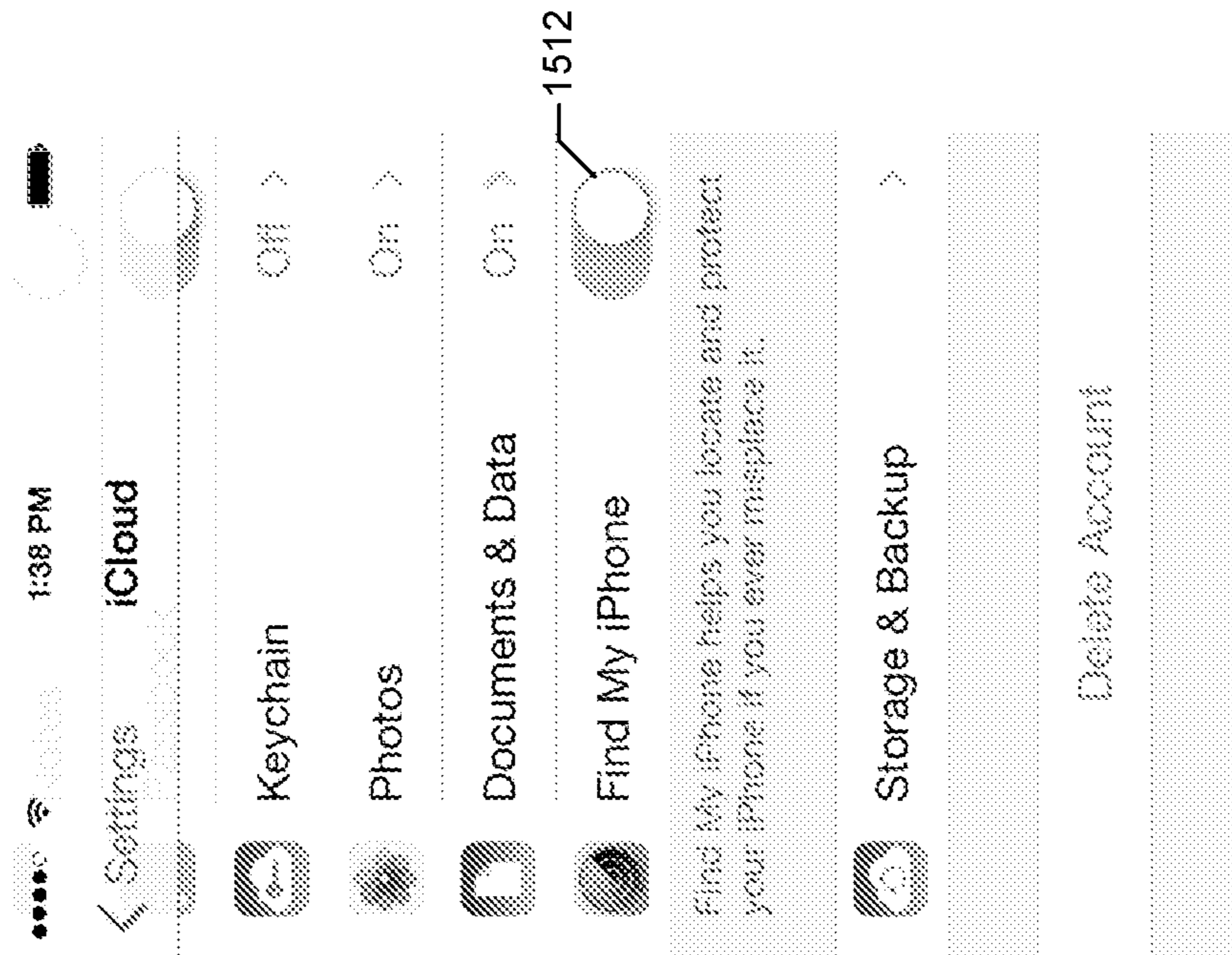

FIG. 15A

1520



FIG. 15B

1530

1532

The 'Find My iPhone' feature on your Apple device is turned on. You can't reset your Apple device until 'Find My iPhone' is turned off. Come back after you have it turned off and I'll be happy to give you my best price on the spot!

To Turn Off 'Find My iPhone'

1. Go to Settings > Apple ID > Find My iPhone > Turn Off Find My iPhone
2. Turn Off Find My iPhone
3. Turn Off Find My iPhone
4. Turn Off Find My iPhone

En español

Cancel

Continue

FIG. 15C

1540

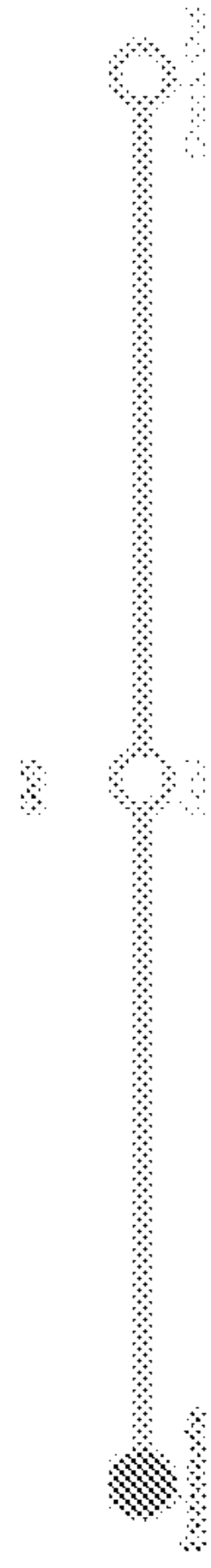

I'm sorry, but I seem to be having trouble confirming that the 'Find My iPhone' feature has been turned off on this device, so I won't be able to pay you for it.

Please try again later and I will be happy to give you my best price.

Find My iPhone must be disabled in order for your device to be resold to any buyer.

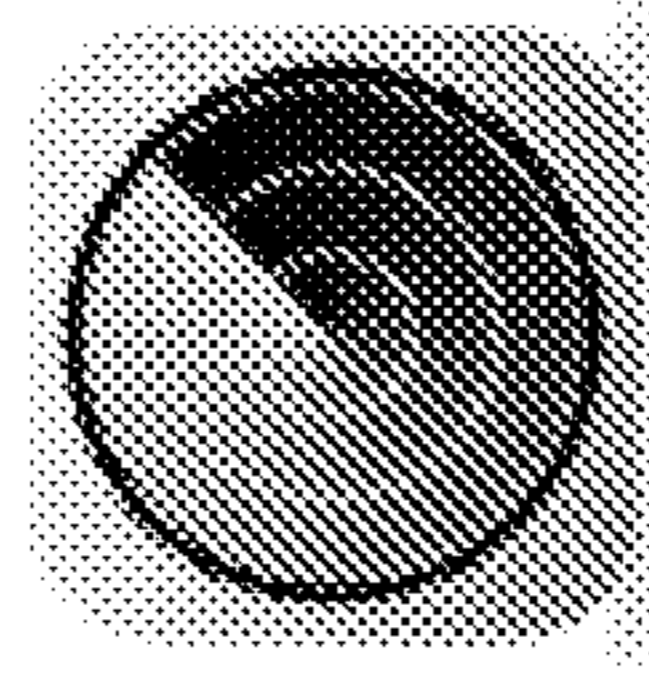

Find My iPhone

1542

OFF

En español

Cancel

Continue

FIG. 15D

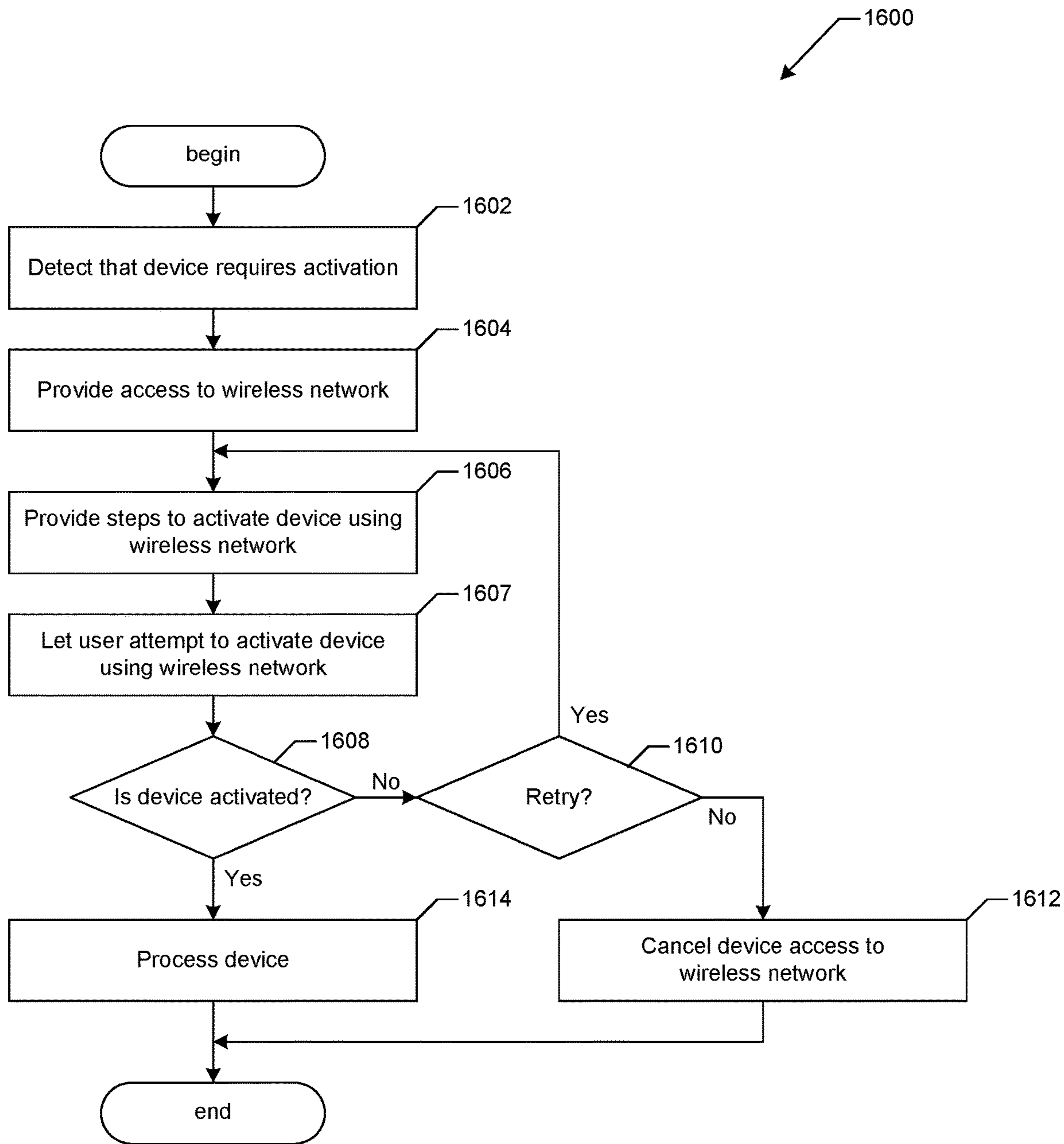

FIG. 16

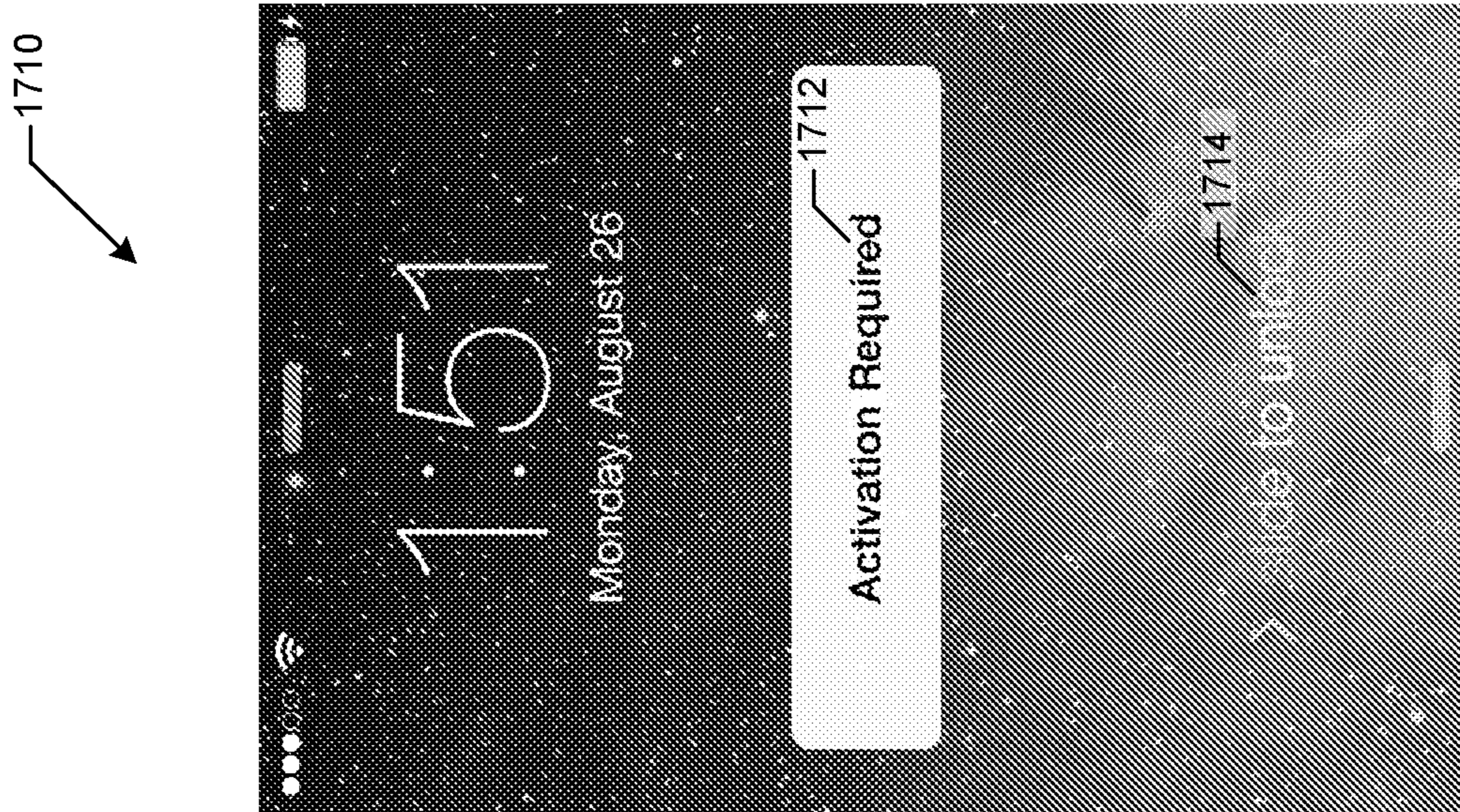

FIG. 171A

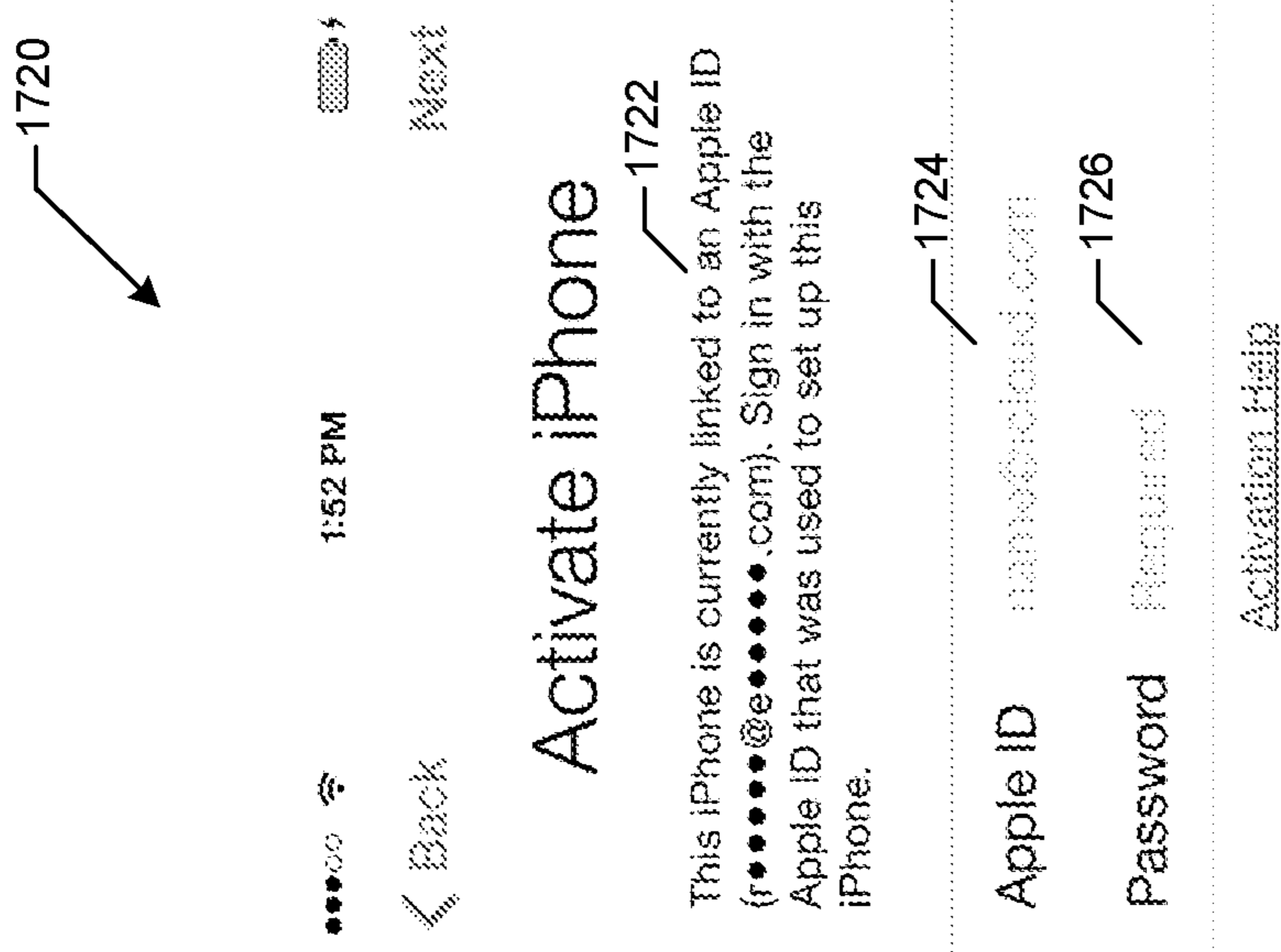

FIG. 172B

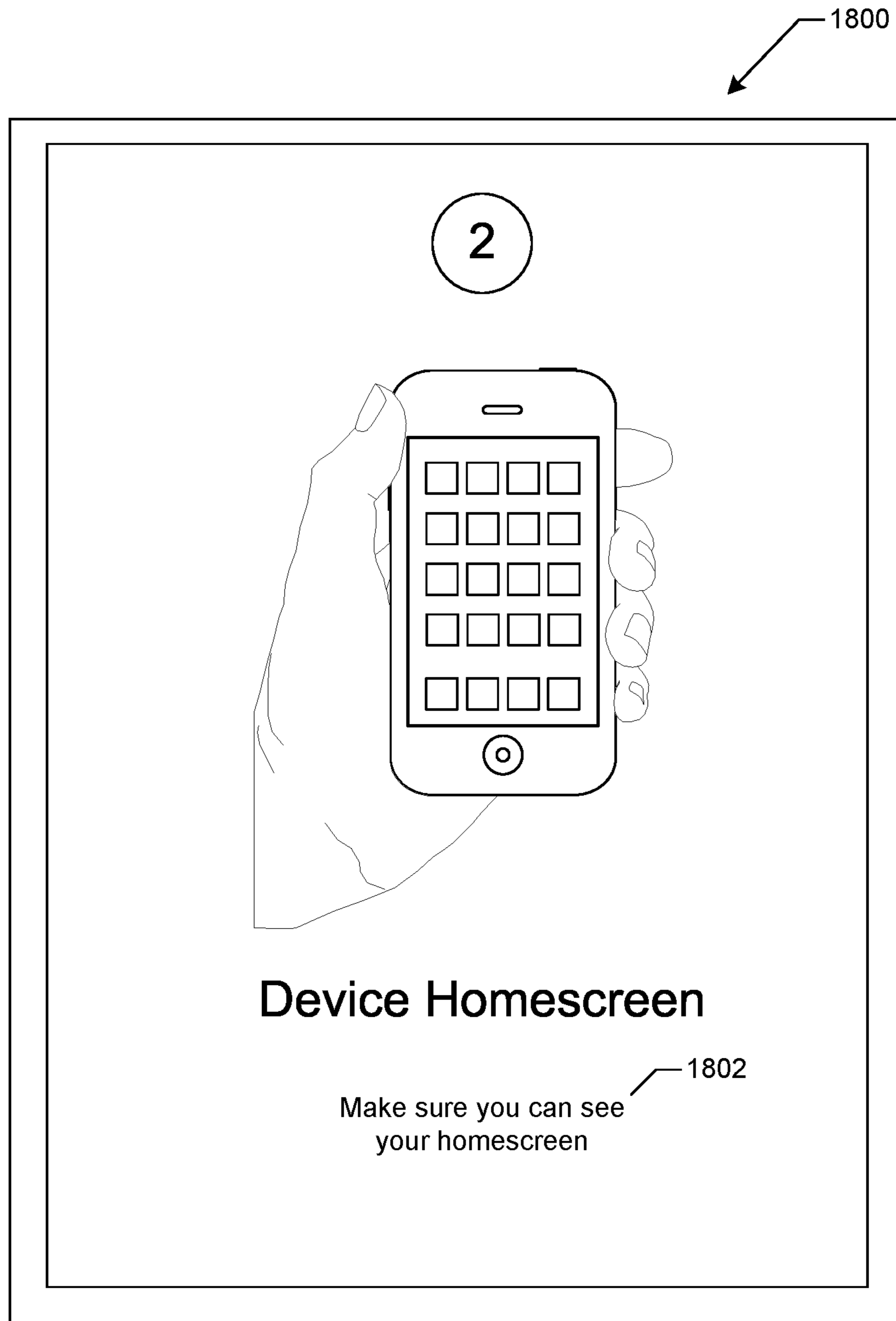

FIG. 18

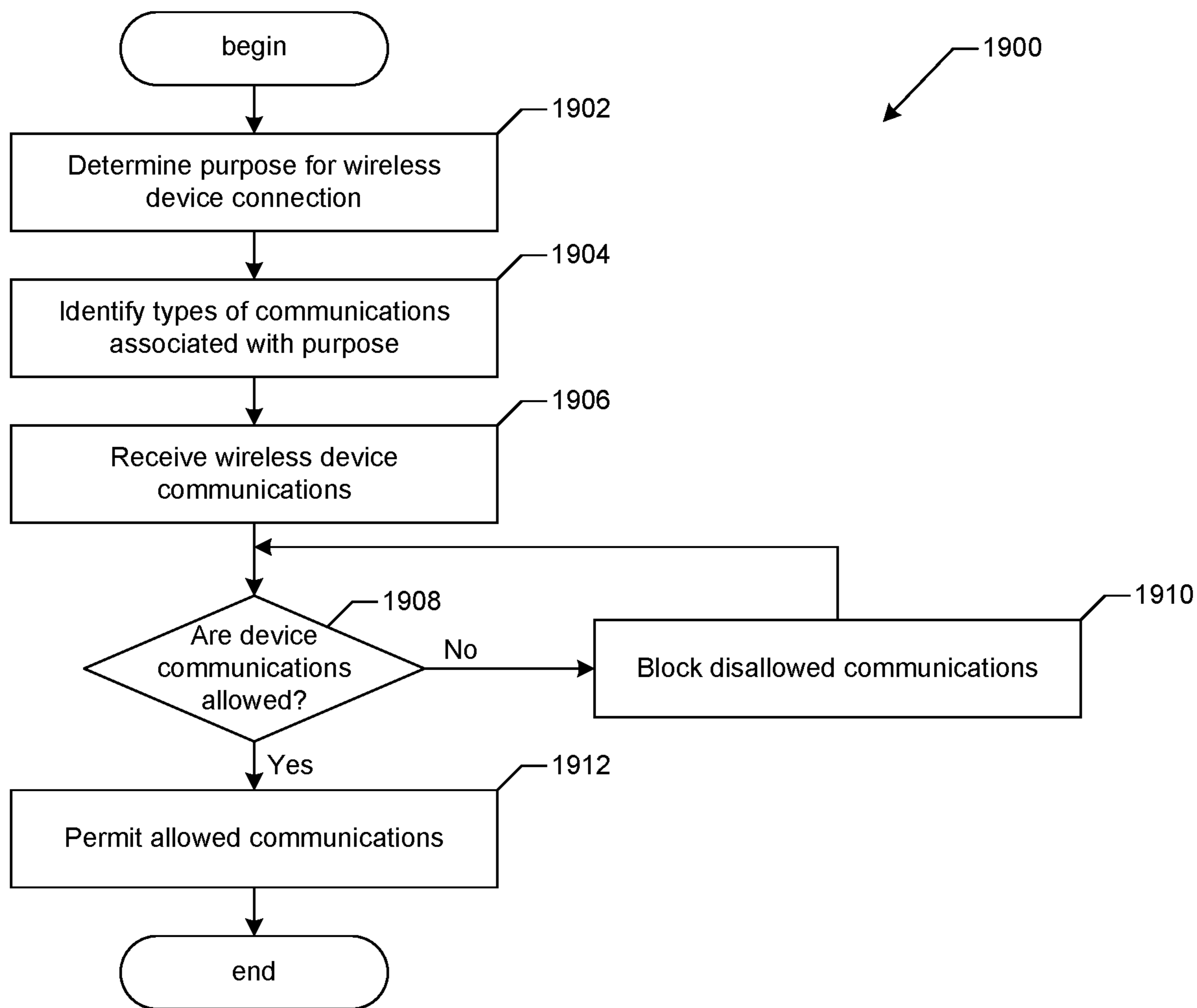

FIG. 19

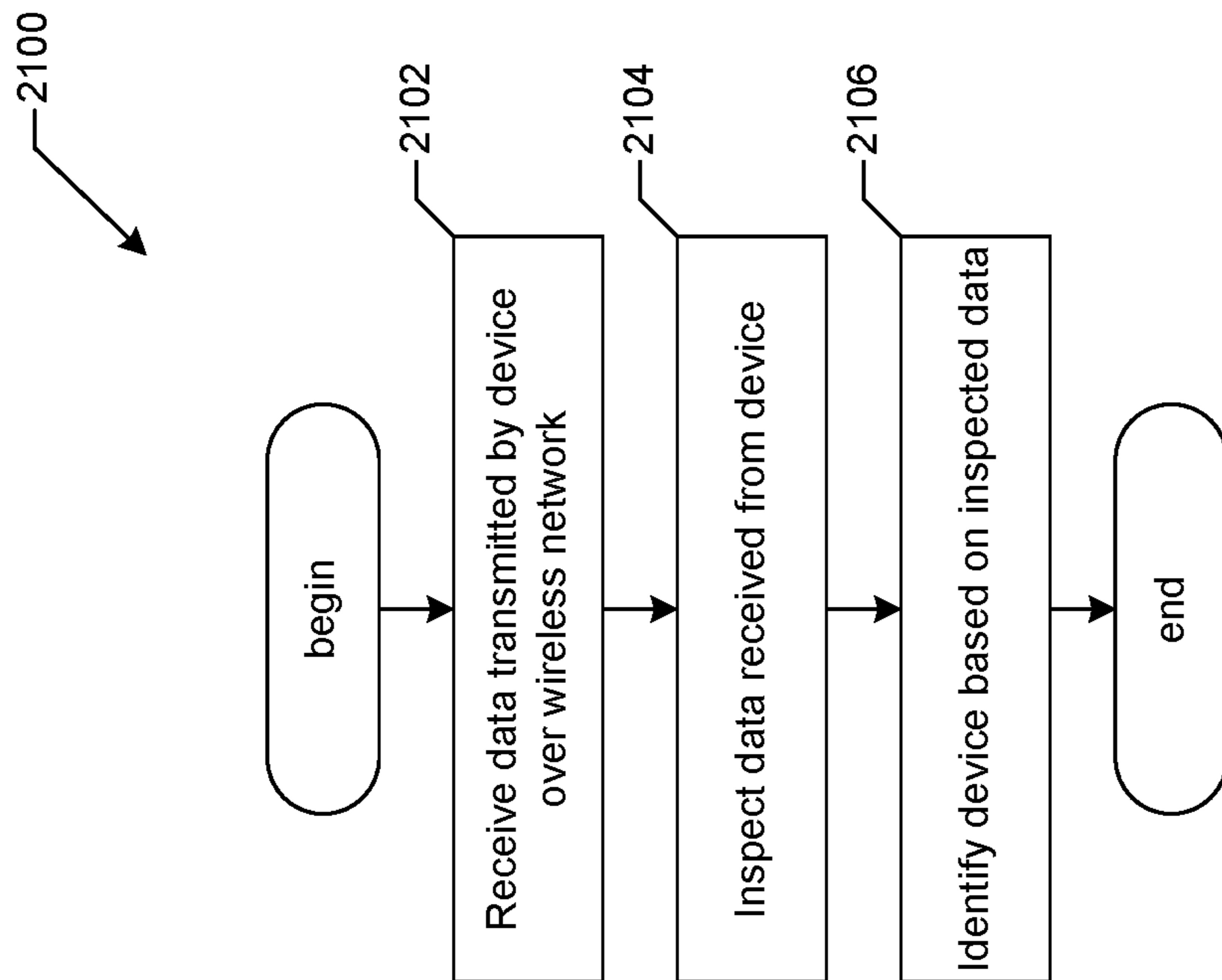

FIG. 21

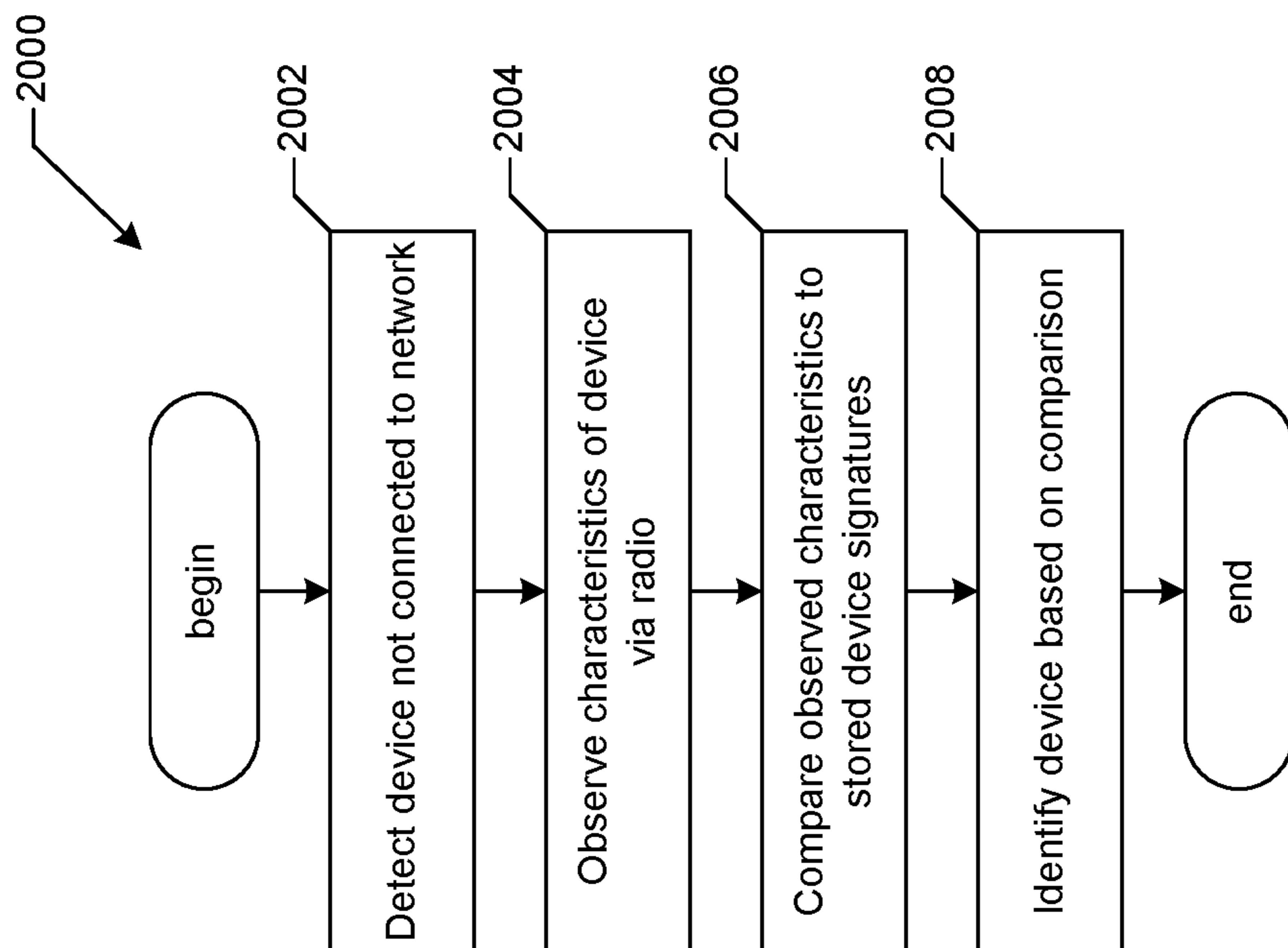

FIG. 20

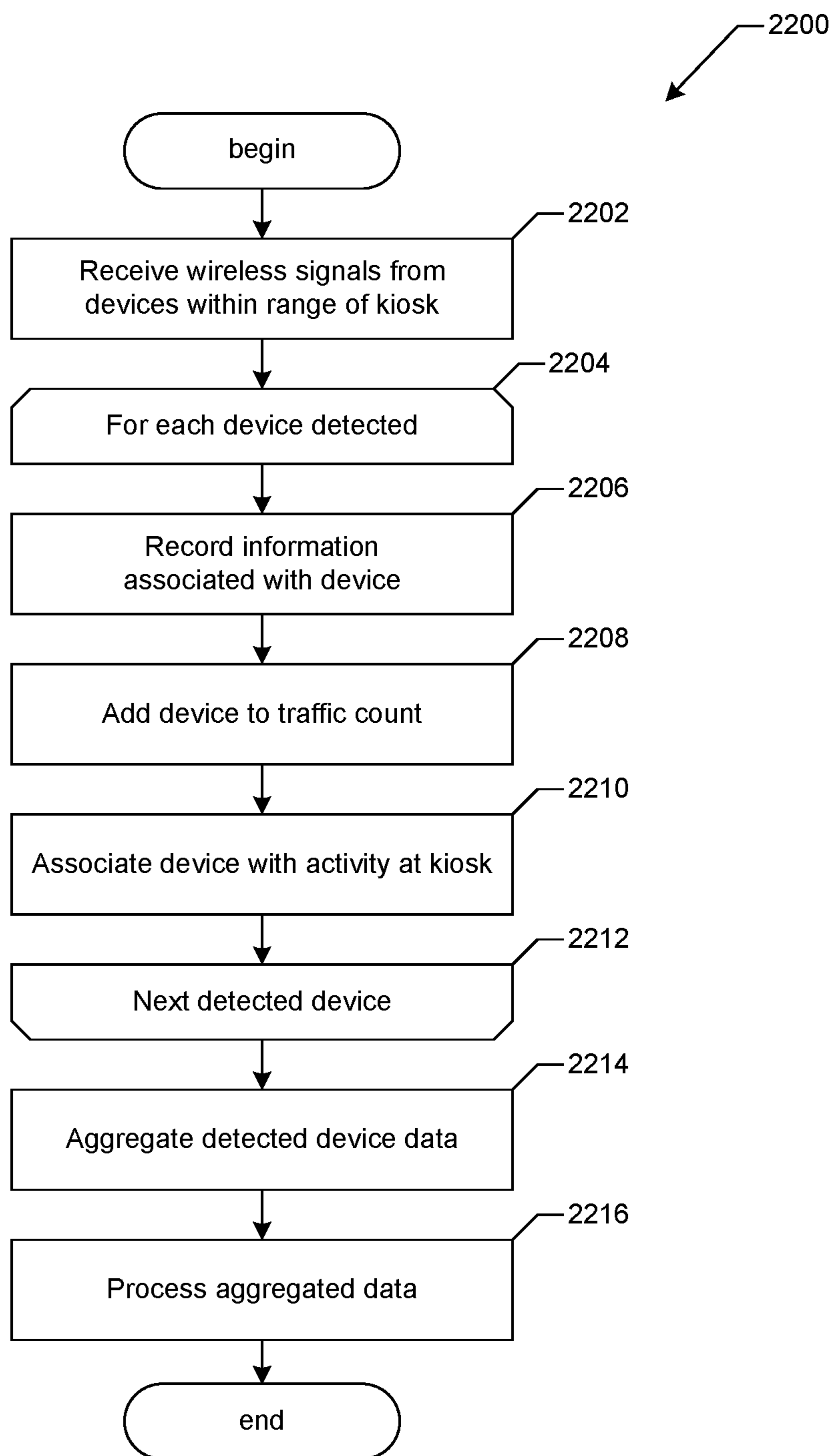

FIG. 22

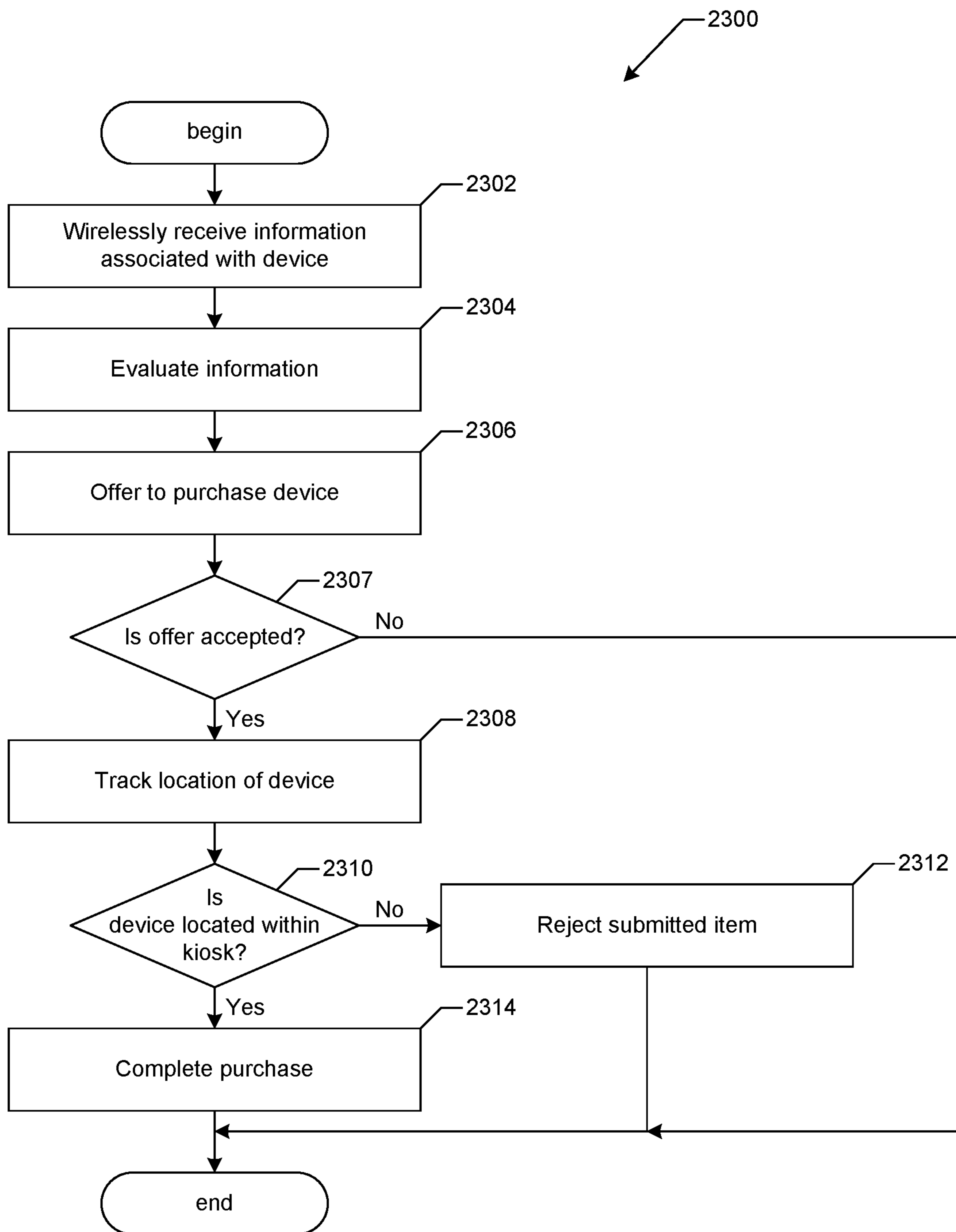

FIG. 23

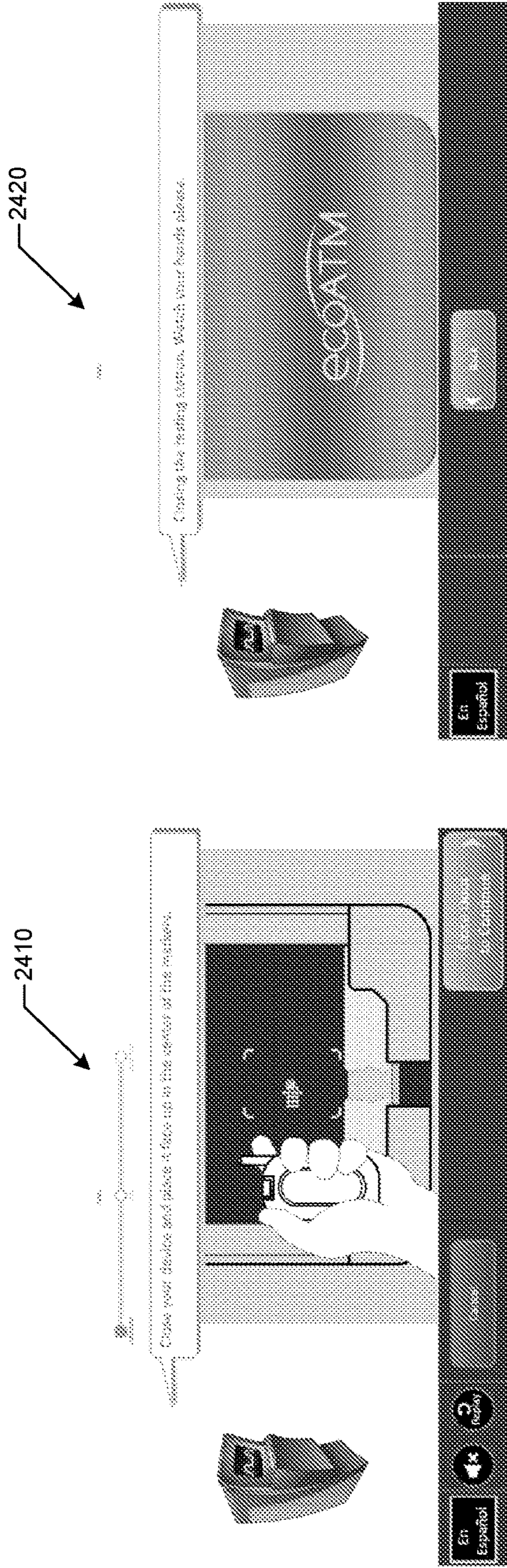

FIG. 24A

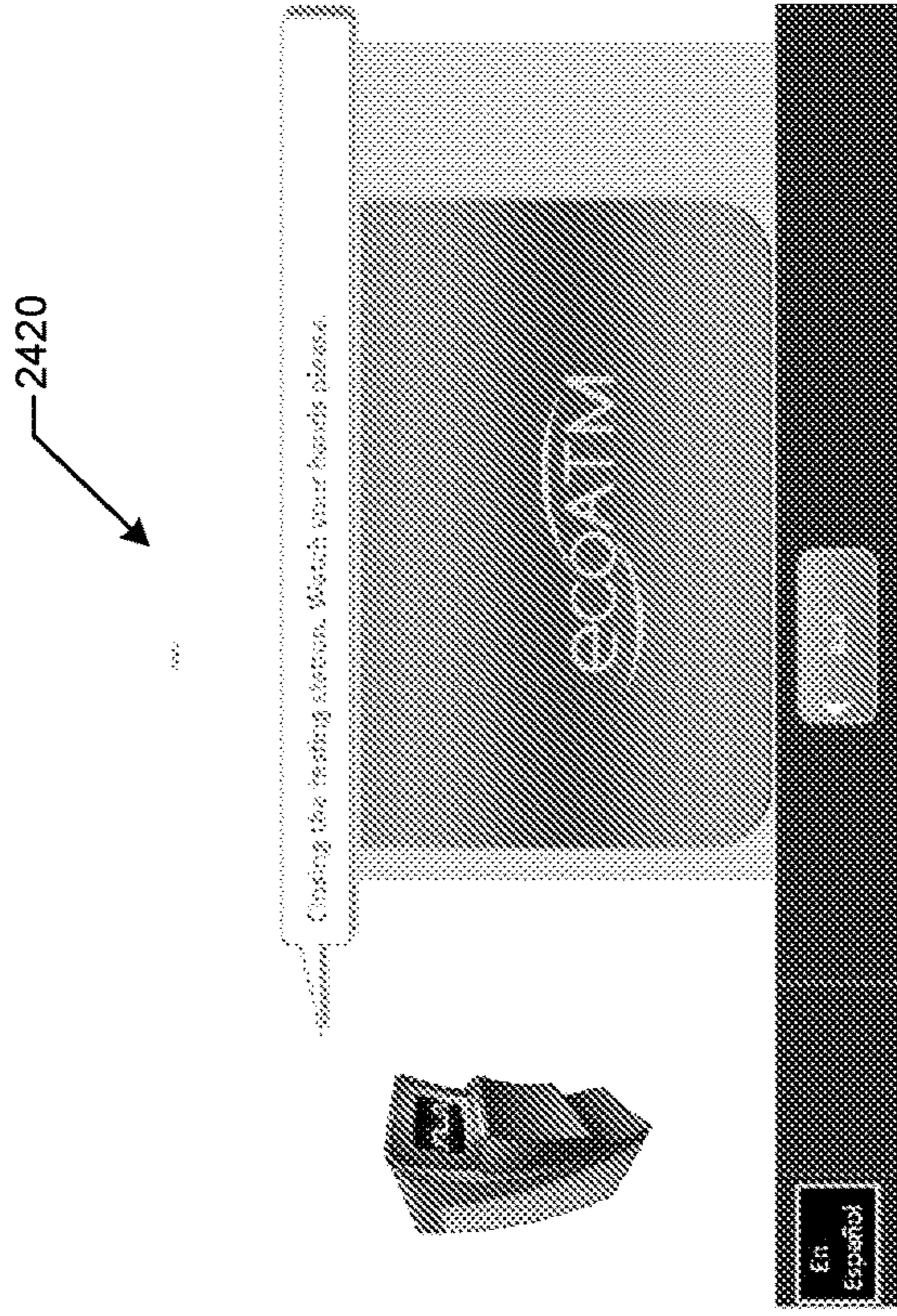

FIG. 24B

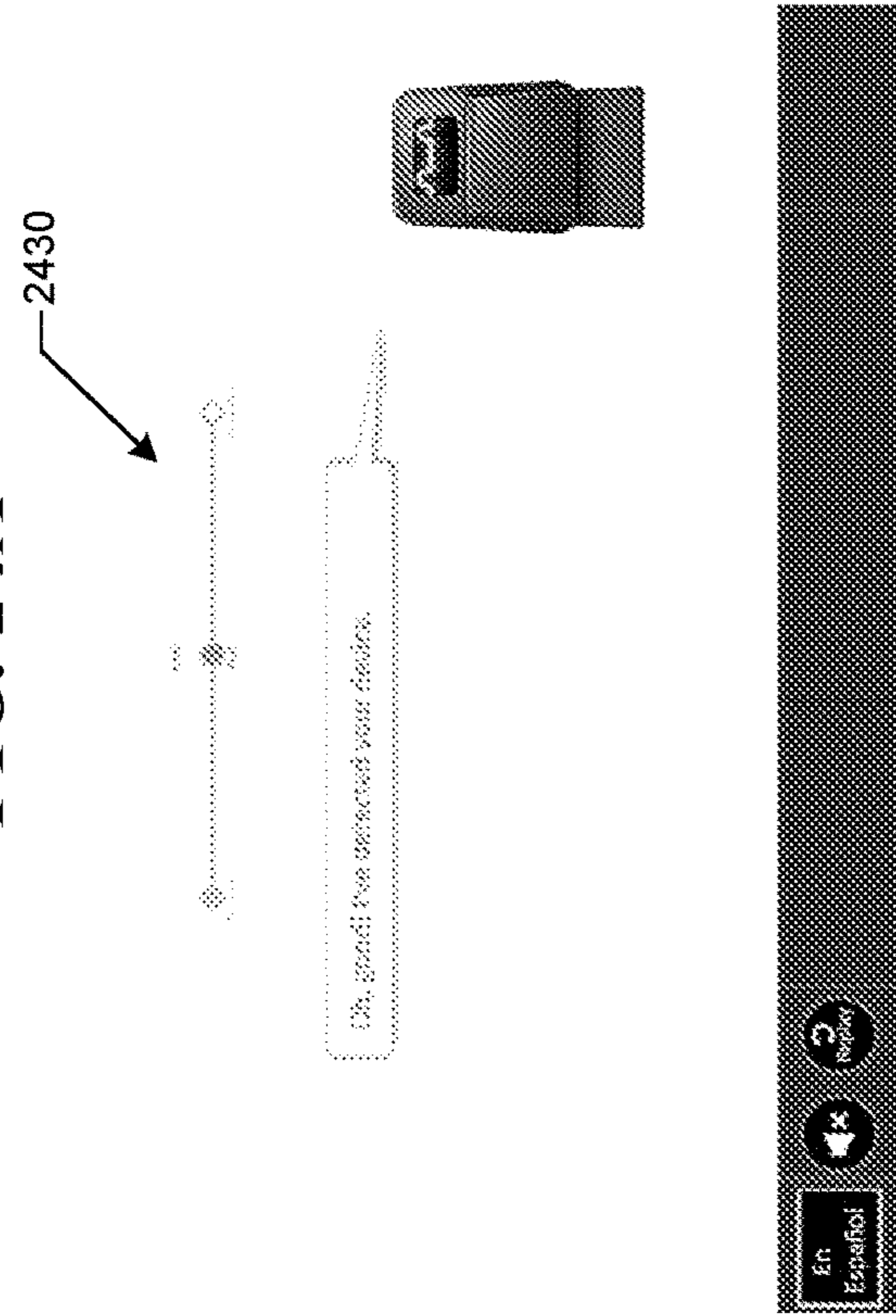

FIG. 24C

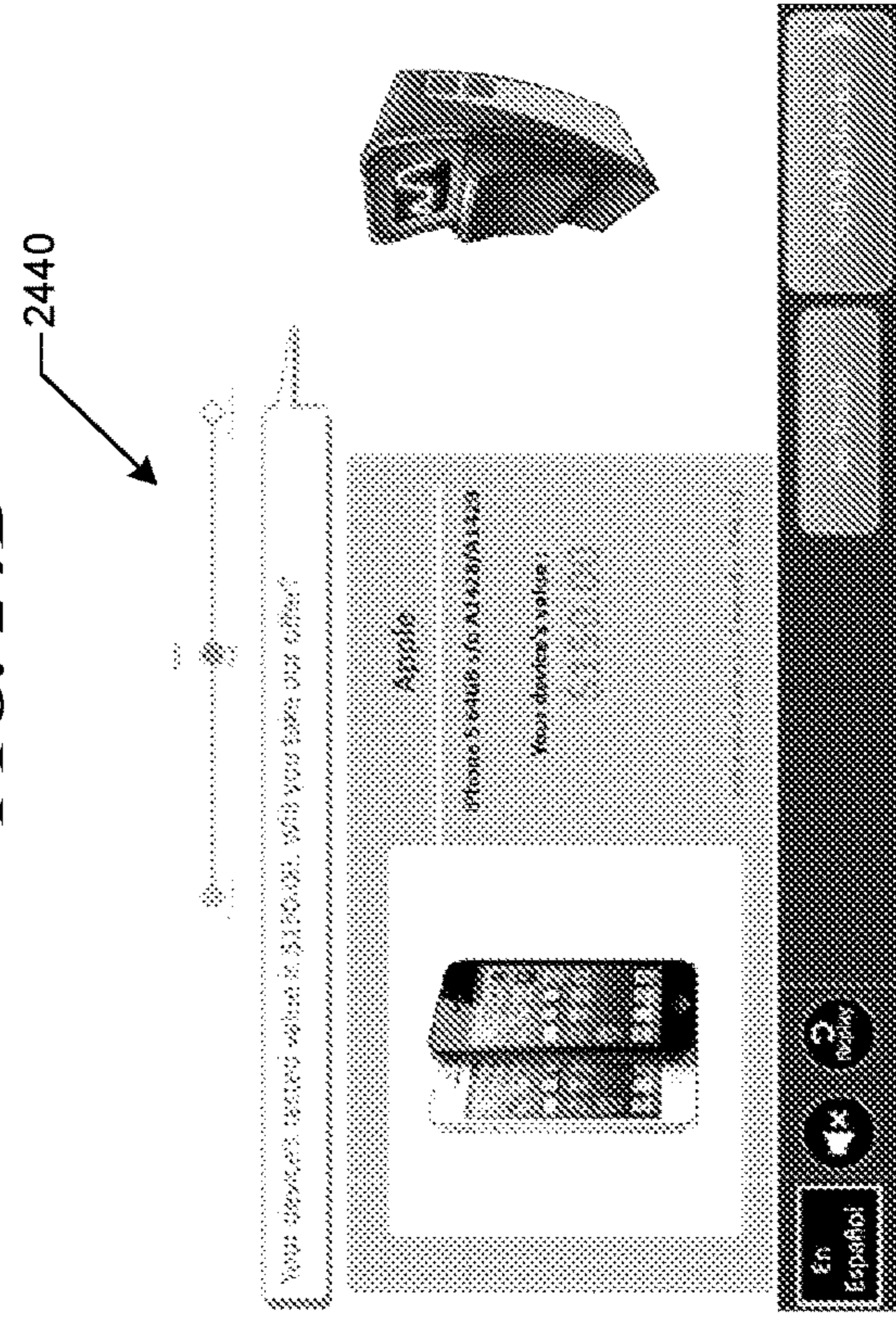

FIG. 24D

WIRELESS-ENABLED KIOSK FOR RECYCLING CONSUMER DEVICES

CROSS-REFERENCE TO RELATED APPLICATIONS

This application is a continuation of U.S. patent application Ser. No. 16/575,003, filed Sep. 18, 2019, now pending, which is a divisional of U.S. patent application Ser. No. 14/873,158, titled "WIRELESS-ENABLED KIOSK FOR RECYCLING CONSUMER DEVICES," filed by the applicant on Oct. 1, 2015, now U.S. Pat. No. 10,475,002, which claims the benefit of U.S. provisional application No. 62/059,129, titled "WIRELESS-ENABLED KIOSK FOR RECYCLING CONSUMER DEVICES," filed by the applicant on Oct. 2, 2014. The entire disclosures of the above-reference applications are incorporated herein by reference in their entirety and made part of the present disclosure.

TECHNICAL FIELD

The present disclosure is directed generally to methods and systems for analyzing and recycling mobile phones and other consumer devices and, more particularly, to wireless methods and systems for facilitating identification, evaluation, and other processes associated with recycling consumer devices.

BACKGROUND

Consumer electronic devices, such as mobile phones, laptop computers, notebooks, tablets, MP3 players, etc., are ubiquitous. Currently there are over 6 billion mobile devices in use in the world; and the number of these devices is growing rapidly with more than 1.8 billion mobile phones being sold in 2013 alone. By 2017 it is expected that there will be more mobile devices in use than there are people on the planet. In addition to mobile phones, over 300 million desk-based and notebook computers shipped in 2013, and for the first time the number of tablet computers shipped exceeded laptops. Part of the reason for the rapid growth in the number of mobile phones and other electronic devices is the rapid pace at which these devices evolve, and the increased usage of such devices in third world countries.

As a result of the rapid pace of development, a relatively high percentage of electronic devices are replaced every year as consumers continually upgrade their mobile phones and other electronic devices to obtain the latest features or a better operating plan. According to the U.S. Environmental Protection Agency, the U.S. alone disposes of over 370 million mobile phones, PDAs, tablets, and other electronic devices every year. Millions of other outdated or broken mobile phones and other electronic devices are simply tossed into junk drawers or otherwise kept until a suitable disposal solution arises.

Although many electronic device retailers and cell carrier stores now offer mobile phone trade-in or buyback programs, many old mobile phones still end up in landfills or are improperly disassembled and disposed of in developing countries. Unfortunately, however, mobile phones and similar devices typically contain substances that can be harmful to the environment, such as arsenic, lithium, cadmium, copper, lead, mercury and zinc. If not properly disposed of, these toxic substances can seep into groundwater from decomposing landfills and contaminate the soil with potential harmful consequences for humans and the environment.

As an alternative to retailer trade-in or buyback programs, consumers can now recycle and/or sell their used mobile phones using self-service kiosks located in malls, retail stores, or other publically accessible areas. Such kiosks are operated by ecoATM, Inc., the assignee of the present application, and are disclosed in, for example, U.S. Pat. Nos. 8,463,646, 8,423,404, 8,239,262, 8,200,533, 8,195,511, and 7,881,965, which are commonly owned by ecoATM, Inc. and are incorporated herein by reference in their entireties.

There continues to be a need for improving the means available to consumers for recycling or reselling their mobile phones and other electronic devices. Simplifying the recycling/reselling process, enhancing the consumer experience, and discouraging fraud can incentivize consumers to dispose of their old electronic devices in an efficient and environmentally conscientious way.

BRIEF DESCRIPTION OF THE DRAWINGS

FIG. 1 is an isometric view of a machine configured in accordance with an embodiment of the present technology for recycling electronic devices.

FIGS. 2A-2D are a series of isometric views of the machine of FIG. 1 with a number of exterior panels removed to illustrate operation of the machine in accordance with an embodiment of the present technology.

FIG. 3 is a schematic diagram illustrating various components associated with the machine of FIG. 1.

FIG. 4 is a schematic diagram of a suitable distributed computing environment for implementing various aspects of the present technology.

FIG. 5 is a flow diagram of a routine for wirelessly receiving information from an electronic device (e.g., a mobile phone) in accordance with embodiments of the present technology.

FIG. 6 is a flow diagram of a routine for wirelessly connecting a kiosk to a device in accordance with embodiments of the present technology.

FIG. 7 is a display diagram illustrating a screen display or graphical user interface (GUI) that graphically and textually provides instructions for wirelessly connecting a device to a kiosk in accordance with embodiments of the present technology.

FIG. 8 is a flow diagram of a routine for loading software on a device such as a mobile phone in accordance with embodiments of the present technology.

FIG. 9 is a flow diagram of a routine for initiating a software download in accordance with embodiments of the present technology.

FIG. 10 is a flow diagram of a routine for wirelessly receiving information from the device in accordance with embodiments of the present technology.

FIG. 11 illustrates a flow diagram of a routine for enabling a known electronic device to automatically connect to a kiosk-provided wireless network in accordance with embodiments of the present technology.

FIG. 12 is a flow diagram of a routine for inducing a notification on the device in accordance with embodiments of the present technology.

FIG. 13 is a flow diagram of a routine for providing wireless network access to resolve a device issue in accordance with embodiments of the present technology.

FIG. 14 is a flow diagram of a routine for disassociating a device from a remote user account in accordance with embodiments of the present technology.

FIGS. 15A-15B are display diagrams illustrating device screens associated with disabling a remote account associated with the device in accordance with embodiments of the present technology.

FIGS. 15C-15D are display diagrams illustrating instructions for disassociating a device from a remote user account in accordance with embodiments of the present technology.

FIG. 16 is a flow diagram of a routine for wirelessly activating a device in accordance with embodiments of the present technology.

FIGS. 17A-17B are display diagrams illustrating screens associated with activating a mobile device in accordance with embodiments of the present technology.

FIG. 18 is a display diagram illustrating an instruction for activating a device in accordance with embodiments of the present technology.

FIG. 19 is a flow diagram of a routine for filtering wireless communications in accordance with embodiments of the present technology.

FIG. 20 is a flow diagram of a routine for identifying a wireless device in accordance with embodiments of the present technology.

FIG. 21 is a flow diagram of a routine for identifying a connected wireless device in accordance with embodiments of the present technology.

FIG. 22 is a flow diagram of a routine for recording wireless device activity in accordance with embodiments of the present technology.

FIG. 23 is a flow diagram of a routine for locating a device in accordance with embodiments of the present technology.

FIGS. 24A-24D are a series of display diagrams illustrating instructions for submitting a device in accordance with embodiments of the present technology.

DETAILED DESCRIPTION

The following disclosure describes various embodiments of systems and methods for providing a wireless connection to electronic devices to facilitate identification, evaluation, and other processes associated with purchasing and recycling consumer electronic devices. In various embodiments, for example, a consumer-operated kiosk provides a wireless network connection, allowing a consumer to connect a device to the kiosk without a physical connector. The kiosk can then receive information about the connected device to help the consumer successfully interact with the kiosk. For example, in some embodiments, the kiosk uses the wireless connection to identify and evaluate the user's device to determine a price to offer for the device. Providing a wireless connection between a device and the kiosk can thus allow the consumer to sell and recycle the device at the kiosk more quickly and easily. In some embodiments, the wireless connection helps the consumer prepare a device for possible sale at the kiosk 100, e.g., by allowing the consumer to install a software application (an "app") on the device or resolve issues that could be reducing the device's resale value. For example, if the consumer has protected the device with a remote kill switch feature that allows a lost or stolen device to be remotely reset or made unusable, the feature must typically be disabled before the device can be sold to a new user. The kiosk can provide a wireless Internet connection for the user to disable such a remote kill switch feature before completing the purchase transaction.

In various embodiments, a wireless-enabled kiosk can identify nearby wireless devices, automatically allow recognized devices to connect to the kiosk's wireless network, interact with software on a wireless device (e.g., causing an

app associated with the kiosk to trigger a notification on the device), and/or obtain information transmitted via the provided wireless network. In some embodiments, the kiosk can observe and record the presence of wireless devices in its vicinity, e.g., assessing traffic patterns and volume or associating the presence of a wireless device with activity at the kiosk—for example, identifying a nearby wireless device as a known device of a repeat, high-value customer or as potentially belonging to an individual who has attempted a fraudulent sale. In some embodiments, the kiosk can use the wireless connection to reduce fraud by verifying that a purchased device has been properly submitted to the kiosk and not exchanged for a fake device.

Certain details are set forth in the following description and in FIGS. 1-24D to provide a thorough understanding of various embodiments of the present technology. In other instances, well-known structures, materials, operations and/or systems often associated with smartphones and other handheld devices, consumer electronic devices, computer hardware, software, and network systems, etc. are not shown or described in detail in the following disclosure to avoid unnecessarily obscuring the description of the various embodiments of the present technology. Those of ordinary skill in the art will recognize, however, that the present technology can be practiced without one or more of the details set forth herein, or with other structures, methods, components, and so forth.

The terminology used below is to be interpreted in its broadest reasonable manner, even though it is being used in conjunction with a detailed description of certain examples of embodiments of the present technology. Indeed, certain terms may even be emphasized below; however, any terminology intended to be interpreted in any restricted manner will be specifically defined as such in this Detailed Description section.

The accompanying Figures depict embodiments of the present technology and are not intended to be limiting of its scope. The sizes of various depicted elements are not necessarily drawn to scale, and these various elements may be arbitrarily enlarged to improve legibility. Component details may be abstracted in the Figures to exclude details such as position of components and certain precise connections between such components when such details are unnecessary for a complete understanding of how to make and use the invention.

In the Figures, identical reference numbers identify identical, or at least generally similar, elements. To facilitate the discussion of any particular element, the most significant digit or digits of any reference number refers to the Figure in which that element is first introduced. For example, element 110 is first introduced and discussed with reference to FIG. 1.

FIG. 1 is an isometric view of a kiosk 100 for recycling and/or other processing of mobile phones and other consumer electronic devices in accordance with the present technology. The term "processing" is used herein for ease of reference to generally refer to all manner of services and operations that may be performed or facilitated by the kiosk 100 on, with, or otherwise in relation to an electronic device. Such services and operations can include, for example, selling, reselling, recycling, donating, exchanging, identifying, evaluating, pricing, auctioning, decommissioning, transferring data from or to, reconfiguring, refurbishing, etc. mobile phones and other electronic devices. Although many embodiments of the present technology are described herein in the context of mobile phones, aspects of the present technology are not limited to mobile phones and generally

apply to other consumer electronic devices. Such devices include, as non-limiting examples, all manner of mobile phones, smartphones, handheld devices, PDAs, MP3 players, tablet, notebook and laptop computers, e-readers, cameras, etc. In some embodiments, it is contemplated that the kiosk **100** can facilitate selling and/or otherwise processing larger consumer electronic devices, such as desktop computers, TVs, game consoles, etc., as well smaller electronic devices such as Google Glass™, smartwatches, etc. The kiosk **100** and various features thereof can be at least generally similar in structure and function to the kiosks and corresponding features described in U.S. Pat. Nos. 8,463,646, 8,423,404, 8,239,262, 8,200,533, 8,195,511, and 7,881,965; and in U.S. patent application Ser. Nos. 12/573,089, 12/727,624, 13/113,497, 12/785,465, 13/017,560, 13/438,924, 13/753,539, 13/658,825, 13/733,984, 13/705,252, 13/487,299, 13/492,835, 13/562,292, 13/658,828, 13/693,032, 13/792,030, 13/794,814, 13/794,816, 13/862,395 and 13/913,408. The disclosed technology also includes the disclosures of U.S. patent application Ser. No. 14/498,763, titled "METHODS AND SYSTEMS FOR PRICING AND PERFORMING OTHER PROCESSES ASSOCIATED WITH RECYCLING MOBILE PHONES AND OTHER ELECTRONIC DEVICES," filed by the applicant on Sep. 26, 2014; U.S. patent application Ser. No. 14/500,739, titled "MAINTAINING SETS OF CABLE COMPONENTS USED FOR WIRED ANALYSIS, CHARGING, OR OTHER INTERACTION WITH PORTABLE ELECTRONIC DEVICES," filed by the applicant on Sep. 29, 2014; U.S. provisional application No. 62/059,132, titled "APPLICATION FOR DEVICE EVALUATION AND OTHER PROCESSES ASSOCIATED WITH DEVICE RECYCLING," filed by the applicant on Oct. 2, 2014; U.S. patent application Ser. No. 14/506,449, titled "SYSTEM FOR ELECTRICALLY TESTING MOBILE DEVICES AT A CONSUMER-OPERATED KIOSK, AND ASSOCIATED DEVICES AND METHODS," filed by the applicant on Oct. 3, 2014; U.S. provisional application No. 62/073,840, titled "SYSTEMS AND METHODS FOR RECYCLING CONSUMER ELECTRONIC DEVICES," filed by the applicant on Oct. 31, 2014; U.S. provisional application No. 62/073,847, titled "METHODS AND SYSTEMS FOR FACILITATING PROCESSES ASSOCIATED WITH INSURANCE SERVICES AND/OR OTHER SERVICES FOR ELECTRONIC DEVICES," filed by the applicant on Oct. 31, 2014; U.S. provisional application No. 62/076,437, titled "METHODS AND SYSTEMS FOR EVALUATING AND RECYCLING ELECTRONIC DEVICES," filed by the applicant on Nov. 6, 2014; U.S. provisional application No. 62/090,855, titled "METHODS AND SYSTEMS FOR PROVIDING INFORMATION REGARDING COUPONS/PROMOTIONS AT KIOSKS FOR RECYCLING MOBILE PHONES AND OTHER ELECTRONIC DEVICES," filed by the applicant on Dec. 11, 2014; U.S. patent application Ser. No. 14/568,051, titled "METHODS AND SYSTEMS FOR IDENTIFYING MOBILE PHONES AND OTHER ELECTRONIC DEVICES," filed by the applicant on Dec. 11, 2014; U.S. provisional application No. 62/091,426, titled "SYSTEMS AND METHODS FOR RECYCLING CONSUMER ELECTRONIC DEVICES," filed by the applicant on Dec. 12, 2014; U.S. patent application Ser. No. 14/598,469, titled "METHODS AND SYSTEMS FOR DYNAMIC PRICING AND PERFORMING OTHER PROCESSES ASSOCIATED WITH RECYCLING MOBILE PHONES AND OTHER ELECTRONIC DEVICES," filed by the applicant on Jan. 16, 2015; U.S. patent application Ser. No. 14/660,768, titled "SYSTEMS AND METHODS FOR

INSPECTING MOBILE DEVICES AND OTHER CONSUMER ELECTRONIC DEVICES WITH A LASER," filed by the applicant on Mar. 17, 2015; U.S. patent application Ser. No. 14/663,331, titled "DEVICE RECYCLING SYSTEMS WITH FACIAL RECOGNITION," filed by the applicant on Mar. 19, 2015; U.S. provisional application No. 62/169,072, titled "METHODS AND SYSTEMS FOR VISUALLY EVALUATING ELECTRONIC DEVICES," filed by the applicant on Jun. 1, 2015; U.S. provisional application No. 62/202,330, titled "METHODS AND SYSTEMS FOR INSPECTING MOBILE DEVICES AND OTHER CONSUMER ELECTRONIC DEVICES WITH ROBOTIC ACTUATION," filed by the applicant on Aug. 7, 2015; and U.S. provisional application No. 62/221,510, titled "METHODS AND SYSTEMS FOR INTERACTIONS WITH A SYSTEM FOR PURCHASING MOBILE PHONES AND OTHER ELECTRONIC DEVICES," filed by the applicant on Sep. 21, 2015. All of the patents and patent applications listed in the preceding sentences are commonly owned by the applicant of the present application, and they along with any other patents or patent applications identified herein are incorporated herein by reference in their entireties.

In the illustrated embodiment, the kiosk **100** is a floor-standing self-service kiosk configured for use by a user **101** (e.g., a consumer, customer, etc.) to recycle, sell, and/or perform other operations with a mobile phone or other consumer electronic device. In other embodiments, the kiosk **100** can be configured for use on a countertop or a similar raised surface. Although the kiosk **100** is configured for use by consumers, in various embodiments the kiosk **100** and/or various portions thereof can also be used by other operators, such as a retail clerk or kiosk assistant to facilitate the selling or other processing of mobile phones and other electronic devices.

In the illustrated embodiment, the kiosk **100** includes a housing **102** that is approximately the size of a conventional vending machine. The housing **102** can be of conventional manufacture from, for example, sheet metal, plastic panels, etc. A plurality of user interface devices are provided on a front portion of the housing **102** for providing instructions and other information to users, and/or for receiving user inputs and other information from users. For example, the kiosk **100** can include a display screen **104** (e.g., a liquid crystal display (LCD) or light emitting diode (LED) display screen, a projected display (such as a heads-up display or a head-mounted device), and so on) for providing information, prompts, etc. to users. The display screen **104** can include a touch screen for receiving user input and responses to displayed prompts. In addition or alternatively, the kiosk **100** can include a separate keyboard or keypad for this purpose. The kiosk **100** can also include an ID reader or scanner **112** (e.g., a driver's license scanner), a fingerprint reader **114**, and one or more cameras **116** (e.g., digital still and/or video cameras, identified individually as cameras **116a-c**). The kiosk **100** can additionally include output devices such as a label printer having an outlet **110**, and a cash dispenser having an outlet **118**. Although not identified in FIG. 1, the kiosk **100** can further include a speaker and/or a headphone jack for audibly communicating information to users, one or more lights for visually communicating signals or other information to users, a handset or microphone for receiving verbal input from the user, a card reader (e.g., a credit/debit card reader, loyalty card reader, etc.), a receipt or voucher printer and dispenser, as well as other user input and output devices. The input devices may include a touchpad, a pointing device such as a mouse, a joystick, pen, game pad,

motion sensor, scanner, eye direction monitoring system, etc. Additionally the kiosk **100** can also include a bar code reader, QR code reader, bag/package dispenser, a digital signature pad, etc. In the illustrated embodiment, the kiosk **100** additionally includes a header **120** having a display screen **122** for displaying marketing advertisements and/or other video or graphical information to attract users to the kiosk. In addition to the user interface devices described above, the front portion of the housing **102** also includes an access panel or door **106** located directly beneath the display screen **104**. As described in greater detail below, the access door is configured to automatically retract so that the user **101** can place an electronic device (e.g., a mobile phone) in an inspection area **108** for automatic inspection by the kiosk **100**.

A sidewall portion of the housing **102** can include a number of conveniences to help users recycle or otherwise process their mobile phones. For example, in the illustrated embodiment the kiosk **100** includes an accessory bin **128** that is configured to receive mobile device accessories that the user wishes to recycle or otherwise dispose of. Additionally, the kiosk **100** can provide a free charging station **126** with a plurality of electrical connectors **124** for charging a wide variety of mobile phones and other consumer electronic devices.

FIGS. 2A-2D are a series of isometric views of the kiosk **100** with the housing **102** removed to illustrate selected internal components configured in accordance with an embodiment of the present technology. Referring first to FIG. 2A, in the illustrated embodiment the kiosk **100** includes a connector carrier **240** and an inspection plate **244** operably disposed behind the access door **106** (FIG. 1). In the illustrated embodiment, the connector carrier **240** is a rotatable carousel that is configured to rotate about a generally horizontal axis and carries a plurality of electrical connectors **242** (e.g., approximately 25 connectors) distributed around an outer periphery thereof. In other embodiments, other types of connector carrying devices (including both fixed and movable arrangements) can be used. In some embodiments, the connectors **242** can include a plurality of interchangeable USB connectors configured to provide power and/or exchange data with a variety of different mobile phones and/or other electronic devices. In operation, the carousel **240** is configured to automatically rotate about its axis to position an appropriate one of the connectors **242** adjacent to an electronic device, such as a mobile phone **250**, that has been placed on the inspection plate **244** for recycling. The connector **242** can then be manually and/or automatically withdrawn from the carousel **240** and connected to a port on the mobile phone **250** for electrical analysis. Such analysis can include, e.g., an evaluation of make, model, configuration, condition, etc. using one or more of the methods and/or systems described in detail in the commonly owned patents and patent applications identified herein and incorporated by reference in their entireties.

In the illustrated embodiment, the inspection plate **244** is configured to translate back and forth (on, e.g., parallel mounting tracks) to move an electronic device, such as the mobile phone **250**, between a first position directly behind the access door **106** and a second position between an upper chamber **230** and an opposing lower chamber **232**. Moreover, in this embodiment the inspection plate **244** is transparent, or at least partially transparent (e.g., formed of glass, Plexiglas, etc.) to enable the mobile phone **250** to be photographed and/or otherwise optically evaluated from all, or at least most viewing angles (e.g., top, bottom, sides, etc.) using, e.g., one or more cameras, mirrors, etc. mounted to or

otherwise associated with the upper and lower chambers **230** and **232**. When the mobile phone **250** is in the second position, the upper chamber **230** can translate downwardly to generally enclose the mobile phone **250** between the upper chamber **230** and the lower chamber **232**. The upper chamber **230** is operably coupled to a gate **238** that moves up and down in unison with the upper chamber **230**. As noted above, in the illustrated embodiment the upper chamber **230** and/or the lower chamber **232** can include one or more cameras, magnification tools, scanners (e.g., bar code scanners, infrared scanners, etc.) or other imaging components (not shown) and an arrangement of mirrors (also not shown) to view, photograph and/or otherwise visually evaluate the mobile phone **250** from multiple perspectives. In some embodiments, one or more of the cameras and/or other imaging components discussed above can be movable to facilitate device evaluation. The inspection area **108** can also include weight scales, heat detectors, UV readers/detectors, and the like for further evaluation of electronic devices placed therein. The kiosk **100** can further include an angled binning plate **236** for directing electronic devices from the transparent plate **244** into a collection bin **234** positioned in a lower portion of the kiosk **100**.

The kiosk **100** can be used in a number of different ways to efficiently facilitate the recycling, selling and/or other processing of mobile phones and other consumer electronic devices. Referring to FIGS. 1-2D together, in some embodiments a user wishing to sell a used mobile phone, such as the mobile phone **250**, approaches the kiosk **100** and identifies the type of device the user wishes to sell in response to prompts on the display screen **104**. Next, the user may be prompted to remove any cases, stickers, or other accessories from the device so that it can be accurately evaluated. Additionally, the kiosk **100** may print and dispense a unique identification label (e.g., a small adhesive-backed sticker with a QR code, barcode, etc.) from the label outlet **110** for the user to adhere to the back of the mobile phone **250**. After this is done, the door **106** retracts allowing the user to place the mobile phone **250** onto the transparent plate **244** in the inspection area **108** (FIG. 2A). The door **106** then closes and the transparent plate **244** moves the mobile phone **250** under the upper chamber **230** as shown in FIG. 2B. The upper chamber **230** then moves downwardly to generally enclose the mobile phone **250** between the upper and lower chambers **230** and **232**, and the cameras and/or other imaging components in the upper and lower chambers **230** and **232** perform a visual inspection of the mobile phone **250**. In some embodiments, the visual inspection can include a 3D visual analysis to confirm the identification of the mobile phone **250** (e.g. make and model) and/or to evaluate or assess the condition and/or function of the mobile phone **250** and/or its various components and systems. For example, the visual analysis can include an inspection of a display screen on the mobile phone **250** for cracks or other damage. In some embodiments, the visual inspection can include performing optical character recognition (OCR) to identify printed or displayed patterns, codes, and/or text, and comparing characteristics of the patterns, codes, and/or text (e.g., layout, size, font, color, etc.) to templates to determine the presence of device identifiers such as a model number, serial number, etc. In some embodiments, the kiosk **100** can perform the visual analysis using one or more of the methods and/or systems described in detail in the commonly owned patents and patent applications identified herein and incorporated by reference in their entireties.

Referring next to FIG. 2C, after the visual analysis is performed and the device has been identified, the upper

chamber **230** returns to its upper position and the transparent plate **244** returns the mobile phone **250** to its initial position next to the door **106**. The display screen **104** can also provide an estimated price or an estimated range of prices that the kiosk **100** may offer the user for the mobile phone **250** based on the visual analysis and/or based on user input (e.g., input regarding the type, condition, etc. of the mobile phone **250**). If the user indicates (via, e.g., input via the touch screen) that he or she wishes to proceed with the transaction, the carousel **240** automatically rotates an appropriate one of the connectors **242** into position adjacent the transparent plate **244**, and door **106** is again opened. The user can then be instructed (via, e.g., the display screen **104**) to withdraw the connector **242** (and its associated wire) from the carousel **240**, plug the connector **242** into the corresponding port (e.g., a USB port) on the mobile phone **250**, and reposition the mobile phone **250** in the inspection area on the transparent plate **244**. After doing so, the door **106** once again closes and the kiosk **100** performs an electrical inspection of the device to further evaluate the condition of the phone as well as specific component and operating parameters such as memory, carrier, etc. In some embodiments, the kiosk **100** can perform the electrical analysis using one or more of the methods and/or systems described in detail in the commonly owned patents and patent applications identified herein and incorporated by reference in their entireties.

In some embodiments, the user can attach the electrical connector to the mobile phone **250** and/or perform an electrical analysis of the device before the kiosk **100** performs a visual analysis of the phone. For example, in such an embodiment the user can approach the kiosk **100** and identify the type of device (e.g., the make and model) he or she wishes to recycle, and/or the appropriate electrical connector for connecting to the device. The kiosk **100** can then use this information to stage the appropriate electrical connector at the inspection area. Alternatively, the kiosk **100** can present the user with a selection of standard electrical connectors from which the user can determine an appropriate electrical connector for connecting to the device. Either way, the door **106** retracts and the user is instructed to withdraw the selected connector **242** from the carrier **240**, plug it into the corresponding port (e.g., a USB port) on the mobile phone **250**, and position the mobile phone **250** on the transparent plate **244** in the inspection area. The user may also be prompted to remove any cases, stickers, or other accessories from the mobile phone **250**, and adhere a unique identification label to the back of the mobile phone **250** as described above. The door **106** then closes and the kiosk **100** can perform an electrical inspection of the mobile phone **250** as described above, and after the electrical inspection, a visual inspection as described above. The electrical inspection can include gathering device identification information and/or other information, which the kiosk **100** can then use to customize further interaction with the user, such as to add or omit user inquiries depending on the type of device the user connects. Thus, in some embodiments, electrical inspection of the mobile phone **250** can occur before the user provides information about the mobile phone **250** to the kiosk **100**.

After the visual and electronic analysis of the mobile phone **250**, the user may be presented with a phone purchase price via the display screen **104**. If the user declines the price (via, e.g., the touch screen), a retraction mechanism (not shown) automatically disconnects the connector **242** from the mobile phone **250**, the door **106** opens, and the user can reach in and retrieve the mobile phone **250**. If the user

accepts the price, the door **106** remains closed and the purchase transaction proceeds. For example, the user may be prompted to place his or her identification (e.g., a driver's license) in the ID scanner **112** and provide a thumbprint via the fingerprint reader **114**. As a fraud prevention measure, the kiosk **100** can be configured to transmit an image of the driver's license to a remote computer screen, and an operator at the remote computer can visually compare the picture (and/or other information) on the driver's license to the person standing in front of the kiosk **100** as viewed by one or more of the cameras **116a-c** (FIG. 1) to confirm that the person attempting to sell the mobile phone **250** is in fact the person identified by the driver's license. In some embodiments, one or more of the cameras **116a-c** can be movable to facilitate viewing of kiosk users, as well as other individuals in the proximity of the kiosk **100**. Additionally, the person's fingerprint can be checked against records of known fraud perpetrators. If either of these checks indicate that the person selling the phone presents a fraud risk, the transaction can be declined and the mobile phone **250** returned. After the user's identity has been verified, the transparent plate **244** moves back toward the upper and lower chambers **230** and **232**. As shown in FIG. 2D, however, when the upper chamber **230** is in the lower position the gate **238** permits the transparent plate **244** to slide underneath but not electronic devices carried thereon. As a result, the gate **238** knocks the phone **150** off of the transparent plate **244**, onto the binning plate **236** and into the bin **234**. The kiosk can then provide payment of the purchase price to the user. In some embodiments, payment can be made in the form of cash dispensed from the cash outlet **118**. In other embodiments, the user can receive remuneration for the mobile phone **150** in various other useful ways. For example, the user can be paid via a redeemable cash voucher, a coupon, an e-certificate, a prepaid card, a wired or wireless monetary deposit to an electronic account (e.g., a bank account, credit account, loyalty account, online commerce account, mobile wallet, etc.), Bitcoin, etc.

As those of ordinary skill in the art will appreciate, the foregoing routines are but some examples of ways in which the kiosk **100** can be used to recycle or otherwise process consumer electronic devices such as mobile phones. Although the foregoing examples are described in the context of mobile phones, it should be understood that kiosk **100** and various embodiments thereof can also be used in a similar manner for recycling virtually any consumer electronic device, such as MP3 players, tablet computers, PDAs, and other portable devices, as well as other relatively non-portable electronic devices such as desktop computers, printers, devices for playing games, entertainment or other digital media on CDs, DVDs, Blu-ray, etc. Moreover, although the foregoing examples are described in the context of use by a consumer, the kiosk **100** in various embodiments thereof can similarly be used by others, such as store clerk, to assist consumers in recycling, selling, exchanging, etc. their electronic devices.

FIG. 3 provides a schematic representation of an architecture of the kiosk **100** in accordance with an embodiment of the present technology. In the illustrated embodiment, the kiosk **100** includes a suitable processor or central processing unit (CPU) **300** that controls operation of the kiosk **100** in accordance with computer-readable instructions stored on system memory **306**. The CPU **300** may be any logic processing unit, such as one or more CPUs, digital signal processors (DSPs), application-specific integrated circuits (ASICs), etc. The CPU **300** may be a single processing unit or multiple processing units in a device or distributed across

multiple devices. The CPU **300** is connected to the memory **306** and may be coupled to other hardware devices, for example, with the use of a bus (e.g., a PCI Express or Serial ATA bus). The CPU **300** can include, by way of example, a standard personal computer (PC) (e.g., a DELL OPTIPLEX 7010 PC) or other type of embedded computer running any suitable operating system, such as Windows, Linux, Android, iOS, or an embedded real-time operating system. In some embodiments, the CPU **300** can be a small form factor PC with integrated hard disk drive (HDD) or solid-state drive (SSD) and universal serial bus (USB) or other ports to communicate with the other components of the kiosk **100**. In other embodiments, the CPU **300** can include a microprocessor with a standalone motherboard that interfaces with a separate HDD. The memory **306** can include read-only memory (ROM) and random access memory (RAM) or other storage devices, such as disk drives or SSDs, that store the executable applications, test software, databases and other software required to, for example, control kiosk components, process electronic device information and data (to, e.g., evaluate device make, model, condition, pricing, etc.), communicate and exchange data and information with remote computers and other devices, etc.

The CPU **300** can provide information and instructions to kiosk users via the display screen **104** and/or an audio system (e.g., a speaker) **304**. The CPU **300** can also receive user inputs via, e.g., a touch screen **308** associated with the display screen **104**, a keypad with physical keys, and/or a microphone **310**. Additionally, the CPU **300** can receive personal identification and/or biometric information associated with users via the ID reader **112**, one or more of the external cameras **116**, and/or the fingerprint reader **114**. In some embodiments, the CPU **300** can also receive information (such as user identification and/or account information) via a card reader **312** (e.g., a debit, credit, or loyalty card reader having, e.g., a suitable magnetic stripe reader, optical reader, etc.). The CPU **300** can also control operation of the label dispenser **110** and systems for providing remuneration to users, such as the cash dispenser **118** and/or a receipt or voucher printer and an associated dispenser **320**.

As noted above, the kiosk **100** additionally includes a number of electronic, optical and electromechanical devices for electrically, visually and/or physically analyzing electronic devices placed therein for recycling. Such systems can include one more internal cameras **314** for visually inspecting electronic devices for, e.g., determining external dimensions and condition, and one or more of the electrical connectors **242** (e.g., USB connectors) for, e.g., powering up electronic devices and performing electronic analyses. As noted above, the cameras **314** can be operably coupled to the upper and lower chambers **230** and **232**, and the connectors **242** can be movably and interchangeably carried by the carousel **240** (FIGS. 2A-2D). The kiosk **100** further includes a plurality of mechanical components that are electronically actuated for carrying out the various functions of the kiosk **100** during operation. The mechanical components **318** can include, for example, the inspection area access door **106** and one or more of the movable components (e.g. the inspection plate **244**, the upper and lower chambers **230** and **232**, etc.) operably disposed within the inspection area **108** (FIG. 1). The kiosk **100** further includes power **302**, which can include battery power and/or facility power for operation of the various electrical components associated with kiosk operation.

In the illustrated embodiment, the kiosk **100** further includes a network connection **322** (e.g., a wired connection,

such as an Ethernet port, cable modem, FireWire cable, Lightning connector, USB port, etc.) suitable for communication with, e.g., all manner of remote processing devices via a communication link **350**, and a wireless transceiver **324** (e.g., including a Wi-Fi access point, Bluetooth transceiver, near-field communication (NFC) device, and/or a wireless modem or cellular radio utilizing GSM, CDMA, 3G, and/or 4G technologies, each of which may include an associated antenna or antennas) for data communications suitable for communication with, e.g., all manner of remote processing devices via the communication link **350** and/or directly via, e.g., a wireless peer-to-peer connection. For example, the wireless transceiver **324** can facilitate wireless communication with handheld devices, such as a mobile device **330** (e.g., a smartphone) either in the proximity of the kiosk **100** or remote therefrom. By way of example only, in the illustrated embodiment the mobile device **330** can include one or more features, applications and/or other elements commonly found in smartphones and other known mobile devices. For example, the mobile device **330** can include a CPU and/or a graphics processing unit (GPU) **334** for executing computer readable instructions stored on memory **336**. In addition, the mobile device **330** can include an internal power source or battery **332**, a dock connector **346**, a USB port **348**, a camera **340**, and/or well-known input devices, including, for example, a touch screen **342**, a keypad, etc. In many embodiments, the mobile device **330** can also include a speaker **344** for two-way communication and audio playback. In addition to the foregoing features, the mobile device **330** can include a mobile operating system (OS) **331** and/or a device wireless transceiver that may include one or more antennas **338** for wirelessly communicating with, for example, other mobile devices, websites, and the kiosk **100**. Such communication can be performed via, e.g., the communication link **350** (which can include the Internet, a public or private intranet, a local or extended Wi-Fi network, cell towers, the plain old telephone system (POTS), etc.), direct wireless communication, etc.

Unless described otherwise, the construction and operation of the various components shown in FIG. 3 are of conventional design. As a result, such components need not be described in further detail herein, as they will be readily understood by those skilled in the relevant art. In other embodiments, the kiosk **100** and/or the mobile device **330** can include other features that may be different from those described above. In still further embodiments, the kiosk **100** and/or the mobile device **330** can include more or fewer features similar to those described above.

FIG. 4 is a schematic diagram of a suitable network environment for implementing various aspects of an electronic device recycling system **400** configured in accordance with embodiments of the present technology. In the illustrated embodiment, a plurality of the kiosks **100** (identified individually as kiosks **100a-100n**) can exchange information with one or more remote computers (e.g., one or more server computers **404**) via the communication link **350**. Although the communication link **350** can include a publically available network (e.g., the Internet with a web interface), a private communication link, such as an intranet or other network can also be used. Moreover, in various embodiments the individual kiosk **100** can be connected to a host computer (not shown) that facilitates the exchange of information between the kiosks **100** and remote computers, other kiosks, mobile devices, etc.

The server computer **404** can perform many or all of the functions for receiving, routing and storing of electronic messages, such as webpages, audio signals and electronic

images necessary to implement the various electronic transactions described herein. For example, the server computer **404** can retrieve and exchange web pages and other content with an associated database or databases **406**. In some embodiments, the database **406** can include information related to mobile phones and/or other consumer electronic devices. Such information can include, for example, make, model, serial number, International Mobile Equipment Identity (IMEI) number, carrier plan information, pricing information, owner information, etc. In various embodiments the server computer **404** can also include a server engine **408**, a web page management component **410**, a content management component **412**, and a database management component **414**. The server engine **408** can perform the basic processing and operating system level tasks associated with the various technologies described herein. The webpage management component **410** can handle creation and/or display and/or routing of web or other display pages. The content management component **412** can handle many of the functions associated with the routines described herein. The database management component **414** can perform various storage, retrieval and query tasks associated with the database **406**, and can store various information and data such as animation, graphics, visual and audio signals, etc.

In the illustrated embodiment, the kiosks **100** can also be operably connected to a plurality of other remote devices and systems via the communication link **350**. For example, the kiosks **100** can be operably connected to a plurality of user devices **418** (e.g., personal computers, laptops, handheld devices, etc.) having associated browsers **420**. Similarly, as described above the kiosks **100** can each include wireless communication facilities for exchanging digital information with mobile devices, such as the mobile device **330**. The kiosks **100** and/or the server computer **404** are also operably connectable to a series of remote computers for obtaining data and/or exchanging information with necessary service providers, financial institutions, device manufacturers, authorities, government agencies, etc. For example, the kiosks **100** and the server computer **404** can be operably connected to one or more cell carriers **422**, one or more device manufacturers **424** (e.g., mobile phone manufacturers), one or more electronic payment or financial institutions **428**, one or more databases (e.g., the GSMA IMEI Database, etc.), and one or more computers and/or other remotely located or shared resources associated with cloud computing **426**. The financial institutions **428** can include all manner of entity associated with conducting financial transactions, including banks, credit/debit card facilities, online commerce facilities, online payment systems, virtual cash systems, money transfer systems, etc.

In addition to the foregoing, the kiosks **100** and the server computer **404** can also be operably connected to a resale marketplace **430** and a kiosk operator **432**. The resale marketplace **430** represents a system of remote computers and/or services providers associated with the reselling of consumer electronic devices through both electronic and brick and mortar channels. Such entities and facilities can be associated with, for example, online auctions for reselling used electronic devices as well as for establishing market prices for such devices. The kiosk operator **432** can be a central computer or system of computers for controlling all manner of operation of the network of kiosks **100**. Such operations can include, for example, remote monitoring and facilitating of kiosk maintenance (e.g., remote testing of kiosk functionality, downloading operational software and updates, etc.), servicing (e.g., periodic replenishing of cash and other consumables), performance, etc. In addition, the

kiosk operator **432** can further include one or more display screens operably connected to cameras located at each of the kiosks **100** (e.g., one or more of the cameras **116** described above with reference to FIG. **1**). This remote viewing capability enables operator personnel to verify user identification and/or make other visual observations at the kiosks **100** in real-time during transactions, as described above with reference to FIG. **1**.

The foregoing description of the electronic device recycling system **400** illustrates but one possible network system suitable for implementing the various technologies described herein. Accordingly, those of ordinary skill in the art with appreciate that other systems consistent with the present technology can omit one or more of the facilities described in reference to FIG. **4**, or can include one or more additional facilities not described in detail in FIG. **4**.

The kiosks **100**, mobile devices **330**, server computers **404**, user computers or devices **418**, etc. can include one or more central processing units or other logic-processing circuitry, memory, input devices (e.g., keyboards and pointing devices), output devices (e.g., display devices and printers), and storage devices (e.g., magnetic, solid state, fixed and floppy disk drives, optical disk drives, etc.). Such computers can include other program modules such as an operating system, one or more application programs (e.g., word processing or spreadsheet applications), and the like. The computers can include wireless computers, such as mobile phones, personal digital assistants (PDA's), palm-top computers, etc., which communicate with the Internet via a wireless link. The computers may be general-purpose devices that can be programmed to run various types of applications, or they may be single-purpose devices optimized or limited to a particular function or class of functions. Aspects of the invention may be practiced in a variety of other computing environments.

While the Internet is shown, a private network, such as an intranet can likewise be used herein. The network can have a client-server architecture, in which a computer is dedicated to serving other client computers, or it can have other architectures such as peer-to-peer, in which one or more computers serve simultaneously as servers and clients. A database or databases, coupled to the server computer(s), stores much of the web pages and content exchanged between the user computers. The server computer(s), including the database(s), can employ security measures to inhibit malicious attacks on the system, and to preserve integrity of the messages and data stored therein (e.g., firewall systems, message encryption and/or authentication (e.g., using transport layer security (TLS) or secure sockets layer (SSL)), password protection schemes, encryption of stored data (e.g., using trusted computing hardware), and the like).

One skilled in the relevant art will appreciate that the concepts of the invention can be used in various environments other than location based or the Internet. In general, a display description can be in HTML, XML or WAP format, email format or any other format suitable for displaying information (including character/code-based formats, algorithm-based formats (e.g., vector generated), and bitmapped formats). Also, various communication channels, such as local area networks, wide area networks, or point-to-point dial-up connections, can be used instead of the Internet. The system can be conducted within a single computer environment, rather than a client/server environment. Also, the user computers can comprise any combination of hardware or software that interacts with the server computer, such as television-based systems and various other consumer products through which commercial or noncommercial transac-

tions can be conducted. The various aspects of the invention described herein can be implemented in or for any e-mail environment.

Although not required, aspects of the invention are described in the general context of computer-executable instructions, such as routines executed by a general-purpose data processing device, e.g., a server computer, wireless device or personal computer. Those skilled in the relevant art will appreciate that aspects of the invention can be practiced with other communications, data processing, or computer system configurations, including: Internet appliances, handheld devices (including personal digital assistants (PDAs)), wearable computers, all manner of cellular or mobile phones (including Voice over IP (VoIP) phones), dumb terminals, media players, gaming devices, multi-processor systems, microprocessor-based or programmable consumer electronics, set-top boxes, network PCs, mini-computers, mainframe computers, and the like. Indeed, the terms “computer,” “server,” “host,” “host system,” and the like are generally used interchangeably herein, and refer to any of the above devices and systems, as well as any data processor.

Aspects of the invention can be embodied in a special purpose computer or data processor that is specifically programmed, configured, or constructed to perform one or more of the computer-executable instructions explained in detail herein. While aspects of the invention, such as certain functions, are described as being performed exclusively on a single device, the invention can also be practiced in distributed environments where functions or modules are shared among disparate processing devices, which are linked through a communications network, such as a Local Area Network (LAN), Wide Area Network (WAN), or the Internet. In a distributed computing environment, program modules can be located in both local and remote memory storage devices.

Aspects of the invention can be stored or distributed on tangible computer-readable media, including magnetically or optically readable computer discs, hard-wired or preprogrammed chips (e.g., EEPROM semiconductor chips), nanotechnology memory, biological memory, or other data storage media. The data storage devices can include any type of computer-readable media that can store data accessible by a computer, such as magnetic hard and floppy disk drives, optical disk drives, magnetic cassettes, tape drives, flash memory cards, DVDs, Bernoulli cartridges, RAM, ROMs, smart cards, etc. Indeed, any medium for storing or transmitting computer-readable instructions and data may be employed, including a connection port to a network such as a LAN, WAN, or the Internet. Alternatively, computer implemented instructions, data structures, screen displays, and other data under aspects of the invention can be distributed over the Internet or over other networks (including wireless networks), on a propagated signal on a propagation medium (e.g., an electromagnetic wave(s), a sound wave, etc.) over a period of time, or they can be provided on any analog or digital network (packet switched, circuit switched, or other scheme). The terms “memory” and “computer-readable storage medium” include any combination of temporary, persistent, and/or permanent storage, e.g., ROM, writable memory such as RAM, writable non-volatile memory such as flash memory, hard drives, solid state drives, removable media, and so forth, but do not include a propagating signal per se.

FIG. 5 is a flow diagram of a routine 500 for wirelessly receiving information from an electronic device (e.g., a mobile phone) in accordance with embodiments of the present technology. FIG. 5 and the flow diagrams that follow

are representative and may not show all functions or exchanges of data, but instead they provide an understanding of commands and data exchanged under the system. Those skilled in the relevant art will recognize that some functions or exchange of commands and data may be repeated, varied, omitted, or supplemented, and other (less important) aspects not shown may be readily implemented. Those skilled in the art will appreciate that the blocks shown in FIG. 5 and in each of the flow diagrams discussed below may be altered in a variety of ways. For example, while processes or blocks are presented in a given order, alternative implementations may perform routines in a different order, and some processes or blocks may be rearranged, deleted, moved, added, subdivided, combined, and/or modified to provide alternative or sub-combinations. Each of these processes or blocks may be implemented in a variety of different ways. Also, although processes or blocks are at times shown as being performed in series, these processes or blocks may instead be performed or implemented in parallel, or may be performed at different times. Some of the blocks depicted in FIG. 5 and the other flow diagrams are of a type well known in the art, and can themselves include a sequence of operations that need not be described herein. Those of ordinary skill in the art can create source code, microcode, program logic arrays or otherwise implement the invention based on the flow diagrams and the detailed description provided herein.

Those of ordinary skill in the art will appreciate that the routine 500 and other functions and methods described herein can be implemented as an application specific integrated circuit (ASIC), by a digital signal processing (DSP) integrated circuit, through conventional programmed logic arrays and/or circuit elements. While many of the embodiments are shown and described as being implemented in hardware (e.g., one or more integrated circuits designed specifically for a task), such embodiments could equally be implemented in software and be performed by one or more processors. Such software can be stored on any suitable computer-readable medium, such as microcode stored in a semiconductor chip, on a computer-readable disk, or downloaded from a server and stored locally at a client.

In various embodiments, all or a portion of the routine 500 and the routines in the other flow diagrams herein can be implemented by means of a consumer operating one or more of the devices and systems described above. For example, the kiosk 100 can perform the processes or blocks of the routine 500 and other routines disclosed herein. In some embodiments of the present technology, portions (e.g., blocks) of a routine can be performed by a plurality of the kiosks 100a-100n of FIG. 4, and/or by one or more remote computers. For example, such remote computers can include one or more of the server computers 404 of FIG. 4 and/or computing resources associated with the cloud 426, the resale marketplace 430, and/or the kiosk operator 432 operating separately or in combination. The kiosk 100 and/or the remote computers can perform the routines described herein using one or more local and/or remote databases (e.g., the database 406 of FIG. 4, such as the GSMA IMEI Database). Accordingly, the description of the routine 500 and the other routines disclosed herein may refer interchangeably to the routine performing an operation and/or the kiosk performing the operation, with the understanding that any of the above devices, systems, and resources can perform all or part of the operation.

In block 502, the routine 500 begins when a consumer-operated kiosk (e.g., the kiosk 100 of FIG. 1) detects a device (e.g., the device 330 of FIG. 3, such as a mobile

phone) that the user 101 has brought to the kiosk 100. In some embodiments, detecting the device 330 can include detecting wireless signals emitted by the device 330 in the vicinity of the kiosk 100, as discussed in greater detail below with reference to FIGS. 20 and 22. In other embodiments, detecting the device 330 can include receiving user input indicating the presence of the device 330 at the kiosk 100. Examples of such user input include, for example, a gesture or finger press on the kiosk's touchscreen 308 indicating that the user has brought the wireless device 330 to the kiosk 100, a button press, or a user's verbal indication received by the kiosk microphone 310. In other embodiments, detecting the device 330 can include using other sensors (e.g., a camera such as the external cameras 116 or the internal cameras 314, a scale such as the weight scale in the inspection area 108, etc.) to detect or identify the device 330.

In block 504, the kiosk 100 establishes a wireless link with the device 330. For example, the kiosk 100 can provide a wireless network or peer-to-peer connection for communication with the device 330. In various embodiments, the wireless link includes a radio link (e.g., Wi-Fi, Bluetooth, or NFC), an optical link (e.g., IrDA, laser, or screen-based), and/or an audio link (e.g., high-frequency or ultrasound) for data transfer. In some embodiments, establishing the wireless link can include providing instructions to the user via, for example, textual and/or graphical instructions or video guidance shown on the display screen 104 of the kiosk 100 or on the screen 342 of the device 330, steps listed on a sign affixed to the kiosk housing 102, and/or audio instructions played through the kiosk speaker 304 or the device speaker 344. The instructions can include, for example, a code or other identifier to facilitate linking of the device 330 with the kiosk 100. Establishing the wireless link can also include receiving user input or confirmation at the kiosk 100 or at the device 330. For example, to pair a Bluetooth-enabled device 330 with a kiosk Bluetooth connection, the kiosk 100 can direct the user to perform one or more steps such as activating the device's Bluetooth radio, making the device discoverable, selecting the kiosk 100 (with the user interface of the device 330) or selecting the device 330 (with the user interface of the kiosk 100), initiating a pairing process, entering a confirmation passcode on the device 330 and/or at the kiosk 100, and/or confirming that the connection should be allowed. As another example, the kiosk 100 can provide a Wi-Fi network. Allowing the device 330 to join the Wi-Fi network can include directing the user to activate a Wi-Fi radio on the device 330, select a designated network, input a particular password, agree to presented login terms, etc. Establishing the wireless link can also include requiring other user actions, such as swiping an NFC-enabled device against or in close proximity to a kiosk NFC sensor (e.g., within a few inches), or aligning the device's optical transceiver with an optical transceiver of the kiosk 100 (e.g., by pointing a laser or an infrared LED or sensor at a designated optical window or device on the kiosk 100, or aiming or placing the device's screen 342 against a window or in front of a camera such as the camera 116 on the kiosk 100).

In block 506, the routine 500 receives information from the device 330 via the wireless link, such as information necessary to identify and/or evaluate the device 330. Such information can include, for example, a unique IMEI number (or MEID or equivalent number) of a mobile phone; a manufacturer name or ID code; a model number; a serial number; a unique hardware address or any other identifying code or information. Identifying the device 330 based on the information can include determining the make, model, sub-model, storage capacity, color, carrier, and/or radio bands of

the device 330, and so on. In various embodiments, the kiosk 100 processes the information to determine whether the device 330 is acceptable for processing (e.g., for purchase and/or recycling). If so, the kiosk 100 can offer the user a price for the device 330; if the user accepts the offer and completes the transaction, then the routine 500 receives the device 330 in block 508 (e.g., in the collection bin 234 of FIGS. 2A-2D). After receiving the device 330, the routine 500 ends.

FIG. 6 is a flow diagram of a routine 600 for wirelessly connecting the kiosk 100 to the device 330 in accordance with embodiments of the present technology. In the illustrated routine 600, the kiosk 100 provides a radio link, although other types of wireless connections are contemplated as described above with reference to block 504 of FIG. 5. In block 602, the kiosk 100 activates a wireless radio transceiver such as the transceiver 324 of FIG. 3. For example, in some embodiments, the kiosk 100 turns on a Wi-Fi infrastructure mode access point or ad hoc network node. In some embodiments, activating a wireless radio can include making the transceiver's connection available or visible to devices 330 within range of the kiosk's wireless signal, whether or not the transceiver 324 was already powered (e.g., making the kiosk's Bluetooth device discoverable, or broadcasting the kiosk Wi-Fi base station's service set identifier (SSID) to make it more easily detectable by other devices).

In some embodiments, the range of the activated wireless radio can be configured by adjusting the power provided to the kiosk transceiver 324, the type, location, directionality, and/or gain of the antenna or antennas used, the wireless radio frequency band, the type of wireless connection provided, and/or the kiosk's location (taking into account environmental influences such as interference from other wireless devices, obstacles around the kiosk 100, and/or whether the kiosk 100 is located indoors or outdoors), among other factors. For example, an IEEE 802.11 a/b/g/n/ac Wi-Fi transmitter using a 5 or 9 dBi gain omnidirectional or directional antenna or antenna array (e.g., multiple-input and multiple-output ("MIMO") antennas), broadcasting with 500 mW or 750 mW transmit power in a low-interference channel in the 2.4 or 5 GHz band, may achieve an outdoor range of up to 100-250 meters. On the other hand, a class 2 IEEE 802.15.1 Bluetooth transmitter with a 2.5 mW (or 4 dBm) maximum output power in the 2.4 GHz band may have a maximum range of 10 meters. The effective range of the kiosk's wireless connection may depend on the transmitting power and/or the receiving sensitivity of the kiosk wireless transceiver 324, as well as on the transmitting power and/or receiving sensitivity of each device wireless transceiver.

In block 604, the kiosk 100 receives data indicating that a wireless device such as the wireless device 330 is within communication range of the kiosk's radio. For example, the kiosk wireless transceiver 324 can detect the wireless device's radio signals, such as signals corresponding to a request to wirelessly connect to the kiosk 100. In some embodiments, the signals include an indication provided by a user that the wireless device 330 is present. In some embodiments, the kiosk detects signals indicating that the wireless device 330 is in the vicinity of the kiosk 100, as described below with reference to FIG. 20. In decision block 606, the routine 600 checks whether the device 330 is connected to the kiosk 100. If the wireless device 330 is not connected to the kiosk 100, then in block 608, the kiosk 100 establishes a connection with the device 330. In some embodiments, establishing the connection can include pro-

viding instructions and/or authentication information for the user to enter on the device **330** and/or on the kiosk **100**. For example, the routine **600** can direct the user to make the user's Bluetooth device **330** discoverable, and/or can provide a Bluetooth pairing code that the user can type on the keyboard or screen **342** of the device **330** or on the touch-screen **308** of the kiosk **100**. As another example, the routine **600** can provide a Wi-Fi network name and/or password that when selected and/or entered on the user's device **330** enables the user to wirelessly connect the user's device **330** to the indicated Wi-Fi network. In other embodiments, establishing the connection can include providing a visual code or image (e.g., a QR code) for the user to scan using the device **330**, such that scanning the code or image prompts the device **330** to connect to the kiosk's wireless network (e.g., upon user confirmation). In some embodiments, establishing the connection can include allowing a particular wireless device to join or use the wireless network or make a wireless connection. For example, when the kiosk **100** detects the device **330** and determines that the device **330** is registered for access to the kiosk **100** or otherwise recognized, the kiosk **100** connects to the device **330** without requiring further user authentication. After the device **330** and the kiosk **100** are connected, the routine **600** ends.

FIG. 7 is a display diagram **700** illustrating a screen display or graphical user interface (GUI) that graphically and textually provides instructions for wirelessly connecting the device **330** to the kiosk **100** in accordance with embodiments of the present technology. In some embodiments, the kiosk **100** displays the illustrated textual instructions and accompanying graphical diagrams on the display screen **104**. The kiosk **100** can display instructions including animated graphics or text, photographs, and/or video guidance. In some embodiments, the kiosk **100** updates the instructions as the user follows the instructions, for example, when the kiosk **100** detects that an instruction has been followed. For example, after the kiosk **100** displays an instruction directing the user to activate a wireless radio feature of the user's device **330** (e.g., a Wi-Fi or Bluetooth radio), the kiosk **100** may detect the presence of the activated radio as described below with reference to FIG. 20. After detecting that the user has activated the device **330** as instructed, the kiosk **100** can display a next instruction until the user has completed each of the instructions in a set of instructions. The illustrated example instructions **702** guide the user to activate the device's Wi-Fi transceiver, such as by accessing a device settings control panel or application and turning the Wi-Fi feature to an ON position. For example, the illustrated graphical diagram above the instructions **702** highlights a control **704** (e.g., a button or a slider switch), showing the control **704** in an OFF state that the user can match to the screen **342** of his or her own device **330**, or animating the control **704** to show the user how to turn on the device's Wi-Fi (e.g., by pressing a button or swiping a slider switch). The following instructions **706** guide the user to connect to a specified network (e.g., a network named "Kiosk"). For example, the instructions can include an illustration of a control **708** in an ON position showing an activated Wi-Fi feature, and an indication **710** of what the user will see on the device's screen **342** once the device **330** has successfully connected to the "Kiosk" network. In the illustrated embodiment, the instructions correspond to options shown on an Apple® iOS® device. In some embodiments, the kiosk **100** is configured to detect or receive information specifying a device type (e.g., the manufacturer, model, and/or operating system **331** of the device **330**) and to display instructions corresponding to options available on that device type.

The display diagrams in the present disclosure, including display diagram **700**, illustrate representative computer display screens or web pages that can be implemented in various ways, such as in C++ or as web pages in XML (Extensible Markup Language), HTML (HyperText Markup Language), the Wireless Access Protocol (WAP), LaTeX or PDF documents, or any other scripts or methods of creating displayable data, such as text, images, animations, video and audio, etc. The screens or web pages provide facilities to present information and receive input data, such as a form or page with fields to be filled in, pull-down menus or entries allowing one or more of several options to be selected, buttons, sliders, hypertext links or other known user interface tools for receiving user input. While certain ways of displaying information to users are shown and described with respect to certain Figures, those skilled in the relevant art will recognize that various other alternatives may be employed. The terms "screen," "web page" and "page" are generally used interchangeably herein.

When implemented as web pages, for example, the screens are stored as display descriptions, graphical user interfaces, or other methods of depicting information on a computer screen (e.g., commands, links, fonts, colors, layout, sizes and relative positions, and the like), where the layout and information or content to be displayed on the page is stored in a database typically connected to a server. In general, a "link" refers to any resource locator identifying a resource on a network, such as a display description provided by an organization having a site or node on the network. A "display description," as generally used herein, refers to any method of automatically displaying information on a computer screen in any of the above-noted formats, as well as other formats, such as email or character/code-based formats, algorithm-based formats (e.g., vector generated), matrix or bit-mapped formats, animated or video formats, etc. While aspects of the invention are described herein using a networked environment, some or all features can be implemented within a single-computer environment.

FIG. 8 is a flow diagram of a routine **800** for loading software on a device, such as a mobile phone, in accordance with embodiments of the present technology. In various embodiments, the present technology operates in conjunction with software associated with a device (e.g., the device **330**). For example, the user can download an app from the kiosk **100** or the kiosk operator **432** to the device **330** (e.g., a mobile phone, tablet, or other computing device) to obtain a valuation of the device **330** and/or to obtain remuneration and/or other benefits offered for bringing the device **330** to the kiosk **100** with the app installed. Once installed, the app can, for example, obtain information about the device **330**, transmit the information about the device to a server computer **404** or database **406**, and use the information to make the user an offer to purchase the device **330** at a kiosk **100**. In addition, the app can interact with the kiosk **100** to help the kiosk **100** identify, recognize, and/or evaluate the device **330** more quickly. For example, the app can obtain information from or about the device and transmit that information to the kiosk **100**, and/or identify a known or already evaluated device to the kiosk **100** (including an evaluation performed by the app and/or an evaluation performed by a kiosk **100**). In block **802**, the routine **800** establishes a connection between the device **330** and the kiosk **100**. In some embodiments, for example, the connection can be established as described above with reference to block **608** of FIG. 6. In decision block **804**, the routine **800** checks whether a designated software app is loaded on the device. For example, the kiosk **100** can ask the user whether the app

is installed, direct the user to activate the app if it is installed, and/or request user confirmation of activation of the app. The kiosk **100** can instruct the user to scan a code (e.g., a QR code, a barcode, etc.) displayed by the display screen **104** that causes the device **330** to invoke the app if present on the device. In some embodiments, an app can include software or other logic not directly installed on the device, such as scripts, services, permissions, and/or interfaces that allow interaction between the device owner, the device, a kiosk **100**, and/or one or more remote computing facilities (e.g., the server computer **404**). In some embodiments, checking whether an app is loaded on the device can include querying the device (for example, obtaining a list of apps on the device, or sending a notification or other data to be handled by a targeted app if present), and/or querying a local or remote database (e.g., database **406**) that includes a list of devices upon which the app has been installed. If a specified app is not loaded on the device, then in block **806**, the routine **800** loads the app on the device, as described below with reference to FIG. **9**. Conversely, if the app is loaded on the device, the routine **800** ends.

FIG. **9** is a flow diagram of a routine **900** for initiating a software download in accordance with embodiments of the present technology. In block **902**, the routine **900** receives a request for a specified app to be loaded to a device, for example, a device for recycling such as the device **330**. For example, the kiosk display screen **104** can display an option to initiate an app download and enable the user to select the option by, for example, touching a virtual button on the touch screen **308** or a physical button on the kiosk cabinet **102**. In block **904**, the routine **900** provides network access for the device **330**, enabling the device **330** to download the desired app. In some embodiments, the kiosk **100** provides network access in direct response to a request received by the kiosk **100** through user interaction with the kiosk's touchscreen **308** or a verbal request detected by the kiosk **100** through the microphone **310**. In block **906**, the routine **900** automatically initiates an app download to the device **330** or prompts the user to download the app to the device **330** using the provided network access. In some embodiments, the routine **900** directs the device **330** to a download page for the app, for example, presenting a Wi-Fi login page with a direct link to the app. In some embodiments, the routine **900** provides a link to initiate a download, such as by displaying on the display screen **104** a QR code or other code that the device **330** can scan. When the device **330** scans the code, the device **330** decodes the link, either automatically following the link or enabling the user to follow the link. The link can direct the device's browser (e.g., a user computer browser **420**) to a web page from which the app can be downloaded, can invoke an app management program that enables the user to agree to the app install, or can prompt the device **330** to load an installer application or the desired software directly to the device **330**. After the routine **900** assists the user to obtain the app, the routine **900** ends.

FIG. **10** is a flow diagram of a routine **1000** for wirelessly receiving information from the device **330** in accordance with embodiments of the present technology. In block **1002**, the kiosk **100** receives an indication that the device **330** is in proximity to the kiosk **100** (e.g., within wireless range of one of the kiosks **100a-100n** of FIG. **4**). In some embodiments, the routine **1000** receives an indication that the device **330** has an app installed. For example, receiving the indication can include receiving a known wireless identifier of the device **330** at the kiosk **100** after the app has identified and transmitted or saved one or more wireless identifiers for the

device **330**, such as a Wi-Fi interface media access control address (MAC address). In some embodiments, receiving the indication can include receiving user input at the kiosk **100** (e.g., via the touch screen **308** or other input devices of the kiosk **100** described above with reference to FIG. **1**), such as user confirmation that the app is installed on the device **330**, or user entry of a code associated with the user and/or one or more of the user's device(s) **330**. In some embodiments, receiving the indication can include receiving a report from the app (e.g., while the app is running on the device **330**) that the location of the device **330** is in the range of a wireless radio of the kiosk **100**, as described above with reference to FIG. **6**. In some embodiments, receiving the indication can include receiving a transmission at the kiosk **100** from the device **330** upon which the app is installed and active.

In block **1004**, the routine **1000** enables the device **330** to wirelessly connect to the kiosk **100**, for example, by the methods described above with reference to FIGS. **5** and **6**. In block **1006**, the kiosk **100** receives information from and/or about the device **330** via the wireless connection. The information can include, for example, the device's MAC address, IMEI number, electronic serial number (ESN), Integrated Circuit Card Identifier (ICCID), make and model, storage capacity, radio bands (e.g., frequency ranges and encoding such as CDMA, GSM, LTE, etc.), charge state, etc. In some embodiments, the kiosk **100** receives information including a code for recognizing the device **330** and/or the device's owner (e.g., the user **101**). For example, as discussed below with reference to FIG. **11**, the user may have downloaded the app on the device **330** and used the app to transmit the information about the device **330** to the kiosk **100** and/or the server computers **404** (FIG. **4**) or other aspects of the present technology before arriving at the kiosk **100**. Then by receiving a code from the device **330**, the kiosk **100** can associate the device **330** with the previously received information that the user submitted via the app.

In decision block **1008**, the routine **1000** determines whether the information is sufficient for evaluating the device **330**. The determination can include, for example, whether the information is sufficient to determine a price to offer for the device **330** or sufficient to identify the presence or confirm the absence of issues affecting the device's operation, value, or ability to be resold. If the routine **1000** determines that the information is not sufficient, then in block **1010** the routine **1000** prompts the user for an alternative method of receiving the necessary information from the device **330**. In some embodiments, alternative methods include physically connecting the device **330** to the kiosk **100** via a wired electrical connection, such as one of the electrical connectors **242** of FIG. **2**. In block **1012**, the kiosk **100** receives the necessary information from the device **330** via such an alternative method. Conversely, if the routine **1000** at block **1008** determines that the wirelessly received information is sufficient, then in block **1014** the routine **1000** continues to process the device **330**, for example, proceeding to evaluate the physical and/or electrical condition of the device **330** and/or offering to purchase the device **330**.

FIG. **11** illustrates a flow diagram of a routine **1100** for enabling a known electronic device (e.g., a mobile phone, such as the device **330**) to automatically connect to a kiosk-provided wireless network in accordance with embodiments of the present technology, so that when the user brings the device **330** to the kiosk **100** the device **330** can exchange data with the kiosk **100**, access servers of the device's manufacturer **424**, download data from a website (e.g., a website associated with the kiosk operator **432**), etc.

The user can register the device **330** (e.g., through a software app) so that the kiosk **100** can recognize the device **330**, and the kiosk **100** automatically provides registered devices **330** a wireless connection to the kiosk **100** and/or to various remote resources associated with selling and/or recycling the device **330**. By automatically offering a wireless network connection to a known device **330**, the kiosk **100** enables the user to prepare the device **330** for sale and/or complete a partially completed sale at the kiosk **100**, minimizing potential roadblocks and speeding the sale process. For example, by automatically providing wireless access to remote servers (e.g., to the server computers **404**, the manufacturer servers **424**, the carrier servers **422**, etc.) the kiosk **100** can facilitate the resolution of issues that might otherwise prevent sale of the device **330**, as described below with reference to FIGS. **13-19**.

In block **1102**, the routine **1100** determines that the device **330** is within a certain distance of the kiosk **100** (e.g., corresponding to a wireless connection range of the kiosk **100**). For example, the routine **1100** can determine the presence of the device **330** by: detecting the device's radio as described below with reference to FIG. **20**; receiving a connection request from the device **330** such as an attempt to join the kiosk's Wi-Fi network; or receiving user input, for example, via the touchscreen **308** of the kiosk **100**, indicating that the user has brought the device **330** to the kiosk **100**. In block **1104**, the kiosk **100** recognizes that the device **330** near the kiosk **100** is a registered device. A registered device is a device **330** that the system recognizes, for example, from the user previously submitting device **330** data through the app or performing an evaluation of the device **330** at the kiosk **100**. For example, when the user installs the app on the device **330**, the app can record and transmit one or more identifiers for the device **330** to a remote server **404** and/or database **406**. The identifiers can include, for example, a unique wireless identifier of the device **330** such as a Wi-Fi interface media access control address (MAC address). The routine **1100** registers the device **330** by, for example, saving one or more of the identifiers (or, e.g., a derived code such as a unique hash based on the identifiers) in a registry. The routine **1100** can store some or all of the registry in one or more local or remote databases (e.g., the database **406**). For example, the registration process **1100** can include providing the identifiers to the kiosk **100** (e.g., to one or more of the kiosks in a network of connected kiosks such as kiosks **100a-100n**). In some embodiments, the routine **1100** sends only a portion of the registry to a particular kiosk **100a**, such as information about registered devices **330** in the same geographic area as the kiosk **100a** (e.g., within the same city or state), reducing the volume of data transmitted to the kiosk **100a**.

Once a device is registered, the kiosk **100** can recognize the device **330** (e.g., whether or not the app remains installed). Recognizing that the device **330** at the kiosk **100** is a registered device can include, for example, receiving one or more of the identifiers from the device **330**, and querying the registry (e.g., a local or remote database that includes all or a portion of a list of unique identifiers or derived codes) to check whether the device **330** is in the list of registered devices. In block **1106**, the routine **1100** permits the registered device to automatically connect to the wireless network provided by the kiosk **100** as a recognized, paired, or otherwise accepted or known device **330**. For example, a registered Bluetooth device **330** can automatically pair with a Bluetooth-enabled kiosk **100**, and a registered Wi-Fi device **330** can automatically join a Wi-Fi network of the kiosk **100** without requiring the user to enter

login credentials. In some embodiments, the kiosk **100** limits the ability of a device **330** to use the wireless network as described below with reference to FIG. **19**, and/or cancels an automatic network connection, for example, if the user does not initiate a transaction at the kiosk **100** (e.g., if the user is a phone hawker attempting to compete with the kiosk).

In some embodiments, the automatic network connection directly provides for a quick and easy device purchase process. For example, after the user downloads the app on the device **330**, the system registers the device **330** for future recognition, as described above with reference to block **1104**. The user may download and run the app on the device **330** using a communication link other than the wireless connection provided by the kiosk **100** and without needing to be near the kiosk **100** when downloading and running the app. For example, the device **330** can use a wired or wireless Internet connection at a remote location to obtain the app from a website (e.g., a website associated with the kiosk operator **432**), from a software repository run by the device manufacturer **424** or a third party (e.g., the Apple® App StoresSM, Google Play™ Store, Amazon® Appstore™, and so on), etc. The device **330** can use such available communication links to remotely obtain the app and for the app to remotely communicate with the kiosk **100** and/or other aspects of the present technology. The user can thus use the app to submit information about the device **330** (e.g., registering the device **330**) and obtain an estimated price quote for the device **330** through the app. In some embodiments of the present technology, the estimated price includes a range of prices that the kiosk **100** may offer for the device **330**, and/or is contingent on an evaluation of the device **330** at the kiosk **100** to confirm the device's electrical and/or physical condition. The user can then bring the device **330** to the kiosk **100**, which recognizes the device **330** and allows the device **330** to automatically wirelessly connect to the kiosk **100**. The kiosk **100** receives information about the device **330** via the wireless connection to evaluate the device **330** as described above with reference to FIG. **10**. The kiosk **100** also retrieves the information submitted via the app and the estimated price of the device **330** that was provided to the user through the app. The kiosk **100** compares the wirelessly received information with the app-submitted information to confirm the identity of the device **330** and/or to verify that the condition of the device **330** has not changed. The kiosk **100** can then process the device **330**, such as by receiving the device **330**, performing a visual inspection as described above with respect to FIG. **2B**, determining and offering a price for the device, and concluding the wireless purchase transaction.

FIG. **12** is a flow diagram of a routine **1200** for inducing a notification on the device **330** in accordance with embodiments of the present technology. It may be useful in some embodiments to wirelessly send a notification to the user of a known device **330**; for example, to notify the user that the value of the user's device **330** has changed or is expected to change, to alert the user that the kiosk **100** is nearby and available, and/or to offer a coupon or special deal to the user, etc. In block **1202**, the routine **1200** determines that the device **330** (e.g., a registered device or a device with an app installed) is near the kiosk **100**. Examples of such determining are described above with reference to block **1002** of FIG. **10** and blocks **1102** and **1104** of FIG. **11**. In block **1204**, the routine **1200** wirelessly connects to the device **330**. For example, if the device **330** is a registered device, the kiosk **100** can automatically wirelessly connect to the device **330** as described above with reference to block **1106** of FIG. **11**. In block **1206**, the routine **1200** induces a notification on the

device 330, for example, sending a message to the device 330 or triggering the app to cause the device 330 to display a message on the display 342 that can inform the user that, for example, the user can sell the device at a predetermined price if he or she brings the device to the kiosk 100. The notification can inform the user where the kiosk 100 is located and/or provide directions from the user's location to the kiosk 100. As an example, if the user has checked the price of the device 330 (e.g., within a preset period of time before the device 330 is detected near the kiosk 100), the routine 1200 can notify the user that the user can complete the contemplated sale of the device 330 for the price at the nearby kiosk 100. By using the kiosk's wireless connection to induce a notification, the system ensures that the user is within the vicinity of the kiosk 100, enabling the user to complete the sale of his or her device 330 without needing to travel far. In addition, the localized notification enables the system to provide location-specific incentives, such as discounts redeemable at merchants located close to the kiosk 100.

In some embodiments, the user may wish to sell the device 330 at the kiosk 100, but the kiosk 100 or the user may discover an issue that prevents the sale. For example, it is becoming increasingly common for electronic devices such as computers, tablets, and mobile phones to be associated with remote user accounts. Examples of such remote user accounts include cloud-based services provided by a device manufacturer or other third party. When a device is associated with such a remote user account, it may be password protected or otherwise locked to that user's identity so that the device cannot be reset and used by another individual (e.g., a subsequent purchaser). In addition, a remote user account may allow the account owner to remotely lock or disable the associated device to prevent anyone else from using it (a device "kill switch"). Therefore, a device may not be marketable while the device is associated with such a remote user account. To sell such a device 330 at the kiosk 100, the user must first disassociate the device 330 from the remote user account. By providing a wireless network at the kiosk 100, the kiosk 100 allows the user to resolve such issues to allow a transaction to proceed.

FIG. 13, for example, is a flow diagram of a routine 1300 for providing wireless network access to resolve a device issue in accordance with embodiments of the present technology. In block 1302, the routine 1300 obtains information about a device, such as the device 330 brought to the kiosk 100 by a user who wishes to sell the device 330 for recycling. Obtaining information about the device 330 can include, for example, receiving user input describing the device 330, performing visual evaluation of the device 330 after it has been placed in the kiosk 100, performing optical character recognition (OCR) of information printed on the device 330 (e.g., the back of the device) or displayed on the device's screen 342, performing electrical evaluation of the device 330 via a physical connector as described above with respect to FIGS. 2A-2D, and/or querying remote servers (e.g., a stolen phone database). In block 1304, the routine 1300 determines based on the information that the device 330 is unacceptable unless an issue is resolved. For example, the routine 1300 may obtain information indicating that the device 330 is or may be associated with a remote user account that includes a device kill switch, as described below with respect to block 1402 of FIG. 14. The routine 1300 may treat a device's association with a remote user account as an issue that must be resolved before the device is acceptable for processing (e.g., purchasing and recycling) at the kiosk 100. Thus, if the information indicates that the

device 330 is subject to a kill switch, the routine 1300 determines that the device is unacceptable while that issue exists.

In block 1306, the routine 1300 provides wireless access to allow the issue to be resolved. For example, in some embodiments, the kiosk 100 allows the device 330 to contact a carrier 422 or device manufacturer 424 (FIG. 4) via the Internet to let the device owner sign in and turn off a kill switch feature that could otherwise be used to deactivate the device 330 after resale. In block 1307, the routine 1300 lets the user attempt to resolve the issue using the wireless access. In decision block 1308, the routine 1300 checks whether the issue is resolved. In some embodiments, checking for issue resolution can include querying one or more remote servers (e.g., the device manufacturer servers 424) to determine whether the determined issue has been resolved. In some embodiments, the checking can include interrogating the device 330 to determine whether the issue is still present. For example, a device 330 that has been locked by a remote user account may reveal that locked-out state in response to queries via an electronic interface of the device 330, and/or may display an indication of its state on the device's screen 342 (e.g., a message stating that the device is lost and should be returned to its owner). The routine 1300 may query the device's electronic interface and/or photograph the device's screen 342 to determine whether such an issue is present. If the issue is still present after giving the user an opportunity to resolve the issue, then in block 1310, the routine 1300 declines to further process the device 330. On the other hand, if the issue has been resolved, then in block 1312, the routine 1300 continues to process the device 330. This can include, for example, visual and/or electrical inspection of the device 330 to determine or confirm the device's value, making an offer to purchase the device 330, and if the user accepts the offer, completing the purchase by collecting the device 330 for resale or recycling and providing the offered value to the user in exchange for the device 330. After blocks 1310 or 1312, the routine 1300 ends.

FIG. 14 is a flow diagram of a routine 1400 for disassociating a device from a remote user account in accordance with embodiments of the present technology. For example, if the remote user account includes a kill switch that is enabled for the device 330, the user must disable it; and if the device 330 is in a factory reset state, the routine 1400 can require the user to activate the device 330 to ensure that a kill switch is not enabled for the device 330. In block 1402, the routine 1400 obtains information about the device 330, such as information from the device 330 or from a remote server having information that pertains to the device 330. For example, an app can use an operating system 331 API on the device 330 to determine whether the device 330 is associated with a remote user account. As another example, to determine whether an Apple® device 330 is associated with an iCloud® remote user account, the kiosk 100 can query the Apple® device manufacturer servers 424 (e.g., the Global Service Exchange (GSX) servers at gsx.apple.com). In some embodiments, obtaining the information can include receiving user answers to questions at the kiosk 100; obtaining information from an app associated with the device 330; connecting a physical connector to the device 330; and/or directing the user to connect the device 330 to a wireless network provided by the kiosk 100, or to perform an action that requires the device 330 to be unlocked and activated (e.g., displaying the device's home screen). In decision block 1404, the routine 1400 checks whether the device 330 is or might be subject to a remote kill switch. For example,

if the information indicates that the device **330** is not associated with a remote user account, or if the device **330** is associated only with a remote user account that does not include a remote kill switch feature (e.g., a webmail account that is removed from the device **330** by a factory reset of the device **330**), then the routine **1400** determines that the device **330** is not subject to a remote user account kill switch. If no such kill switch is in effect, then in block **1406** the routine **1400** proceeds with evaluating, purchasing, and recycling (e.g., refurbishing and/or reselling) the device **330**.

In decision block **1408**, the routine **1400** determines whether the device **330** must be activated before confirming and/or deactivating the kill switch. For example, if the device **330** appears to have been reset, it may not be evident whether it is unassociated with any remote user account, whether a still-associated user remotely reset the device **330** (so that it cannot be reactivated except by that user), or whether a remote user permanently disabled the device **330** (so that it cannot be reactivated by anyone). If the device **330** does not require activation (for example, if the device **330** is in an active, usable state rather than in a reset or other locked-out state), then in block **1410** the routine **1400** prompts the user to disable any device kill switch via a wireless network; for example, using a provided wireless Internet connection as described above with reference to FIG. **13**. In decision block **1412**, the routine **1400** determines whether the remote kill switch has been disabled. If not (i.e., if the user cannot remove the kill switch feature or is otherwise unable or unwilling to provide the device **330** in a freely resalable state), then the device **330** may have little or no resale value, and/or the device **330** may be stolen property, so in block **1414** the routine **1400** declines to purchase the device **330** by displaying an appropriate message to the user, e.g., via the display screen **104**. Otherwise, if the user successfully unlinks the remote user account and its remote kill switch from the device **330**, the routine **1400** continues in block **1406**.

Returning to decision block **1408**, if the device **330** does require activation (e.g., if it is in a user-wiped or remotely locked state), then in block **1416**, the routine **1400** prompts the user to activate the device **330** via a wireless network, for example, using a provided wireless Internet connection as described below with reference to FIG. **16**. For example, the routine **1400** can prompt the user with steps to connect to the wireless network and/or instructions with steps to activate the device **330**. In decision block **1418**, if the user has not activated the device **330** (for example, if the user cannot provide a password required to activate the device **330** or is otherwise unable or unwilling to activate it), then in block **1414** the routine **1400** declines the device **330**. Otherwise, if the user successfully activates the device **330**, the routine **1400** continues in block **1410** so that any kill switch can be deactivated.

FIGS. **15A-15B** are display diagrams illustrating device screens associated with disabling a remote account associated with the device **330** in accordance with embodiments of the present technology. “Find My iPhone” is an example of a remote kill switch feature for Apple® iOS® devices that is described herein for illustrative purposes. Referring first to FIG. **15A**, the display page **1510** illustrates device settings for an Apple® iOS® device **330** including a button or control **1512** for the “Find My iPhone” feature. The control **1512** is illustrated in an ON state, indicating that the feature is active. As long as the feature is active, the owner can attempt to locate and/or remotely disable this device **330** if the device **330** were to be lost or stolen. For example, the user can log into his or her remote user account on icloud-

.com, select the device **330**, and press a button to play a sound on the device **330**, lock the device **330** and track its movement, or erase the device **330**. To prevent the device **330** sold at the kiosk **100** from being subject to such actions by the user after the sale, the kiosk **100** requires the user to deactivate the “Find My iPhone” feature. FIG. **15B** shows an Apple® iOS® device display page **1520** that requires user authentication on the device **330** before the “Find My iPhone” feature can be deactivated. After turning the control **1512** to the OFF state, such as by sliding the button or control **1512** to the left, the device **330** requires the user to enter the device owner’s account password **1522**. Only after the user enters the correct credentials can the feature be turned off **1524**.

FIGS. **15C-15D** are display diagrams illustrating instructions for disassociating a device **330** from a remote user account in accordance with embodiments of the present technology. In some embodiments, the kiosk **100** displays the illustrated textual instructions and accompanying graphical diagrams on the display screen **104**. In FIG. **15C**, the illustrated display page **1530** informs the user in explanatory text **1532** that the user cannot sell his or her device **330** while its “Find My iPhone” feature (described herein for illustrative purposes) is turned on. In addition, the display screen **1530** displays a series of steps **1534** for the device’s owner to disable the remote kill switch feature. Those steps **1534** include a first step of connecting to a Wi-Fi network. In some embodiments, the kiosk **100** presents instructions that direct the user to connect to the wireless network provided by the kiosk **100**, as described above with reference to block **608** of FIG. **6** and FIG. **7**. In other embodiments, the kiosk **100** automatically wirelessly connects to the registered device **330** as described above with reference to FIG. **11**, and presents instructions based on the device **330** being connected. In some embodiments, the kiosk **100** provides instructions that are customized to the user’s device **330** (e.g., with illustrations and/or directions specific to the device’s operating system **331**, manufacturer, screen shape, installed software, type of remote user account, etc.) to better help the device’s owner to disable the remote kill switch feature. In FIG. **15D**, the display page **1540** illustrates a deactivated “Find My iPhone” control **1542** showing how the corresponding control **1512** appears in the successfully disabled OFF state. In some embodiments, the kiosk **100** presents the display page **1540** to the user when the kiosk **100** declines to purchase the device **330** as described above with reference to block **1414** of FIG. **14** after the user fails to disassociate the device **330** from a remote user account.

FIG. **16** is a flow diagram of a routine **1600** for wirelessly activating a device in accordance with embodiments of the present technology. In block **1602**, the routine **1600** detects that the device **330** requires activation, as described above with reference to blocks **1408** and **1416** of FIG. **14**. For example, if the user wants to be sure that all of his or her personal information has been removed from a device before selling it, he or she may have erased the device **330** and thereby reset it to a state similar to a factory-new device. On the other hand, a device that appears simply to have been erased may instead have been remotely wiped and locked after the owner believed it to be stolen or lost—in which case activation by a new user may be impossible, or may require the owner’s password. To distinguish those possibilities and to ensure that the kiosk **100** accepts only an active working device from the owner (as well as, for example, to install a software app on the device **330**), in block **1604** the kiosk **100** provides and allows the device **330** to connect to a wireless network. Through the wireless

network, the kiosk 100 provides the device 330 Wi-Fi access to remote activation servers such as the device manufacturer servers 424 and/or the wireless carrier servers 422 as described above with reference to block 1306 of FIG. 13. For example, if the user cancels cell network service for the device 330 and then brings the device 330 to the kiosk 100, the user may not be able to contact the activation servers 422 and/or 424 except through the kiosk's wireless network. In block 1606, the routine 1600 provides steps to activate the device 330 using the wireless network. For example, the kiosk 100 can display, on the display screen 104, instructions illustrating device screens (e.g., as described below with reference to FIGS. 17A-17B) and a resultant successfully activated state (e.g., as described below with reference to FIG. 18). In block 1607, the routine 1600 lets the user attempt to activate the device using the wireless network. In decision block 1608, the routine 1600 checks whether the device 330 has been successfully activated. If not, then the routine 1600 proceeds to decision block 1610. The kiosk 100 can set a threshold number of activation attempts (e.g., 3) to prevent the user from monopolizing the kiosk 100 with unsuccessful attempts. If the kiosk 100 allows the user to retry activation, the routine 1600 returns to block 1606. If the user has tried the threshold number of times without success, then in block 1612 the routine 1600 cancels the device's access to the wireless network and the routine 1600 ends. Otherwise, if the device 330 has been activated following decision block 1608, then in block 1614 the kiosk 100 continues to process the device 330 (for example, to evaluate the device 330, make an offer to the user, and purchase the device 330), and the routine 1600 ends.

FIGS. 17A-17B are display diagrams illustrating screens associated with activating a mobile device such as a mobile phone (e.g., the device 330) in accordance with embodiments of the present technology. The illustrated Apple® iPhone® activation screens 1710 and 1720 are described herein for illustrative purposes. In FIG. 17A, the display page 1710 includes an "Activation Required" message 1712 indicating that the device 330 is in a deactivated state. It also includes a control 1714 for unlocking the device 330 or initiating the activation process. The screen 1710 does not indicate whether or not the device 330 is associated with a remote user account. In FIG. 17B, however, the display page 1720 shows a message 1722 that the device 330 was reset in connection with an owner's remote user account (e.g., by a remote kill switch feature) and indicates that the device 330 cannot be activated without entering the owner's account credentials (username 1724 and password 1726). In some embodiments, the kiosk 100 determines that the device 330 displaying a screen substantially similar to the display page 1720 cannot be accepted for purchase. The kiosk 100 determines that the device 330 is unacceptable by, for example, optically scanning the screen 342 (e.g., using the external cameras 116 or the internal cameras 314) or by requesting and receiving user confirmation of the content displayed on the screen 342. In some embodiments, the kiosk 100 can utilize OCR techniques to convert portions of the display page 1720 to text. The kiosk 100 can also utilize OCR to read information, such as an identifier (e.g., a serial number or IMEI number), printed on the device 330 (e.g., on the back of the device) or displayed on the screen 342. The kiosk 100 can compare the information from the device 330 against information in a local and/or remote database (e.g., the database 406 of FIG. 4) and/or query a remote server such as a device manufacturer server 424 to determine whether the device 330 is in an unacceptable state (e.g., associated with a remote user account or unactivated), as

described above with reference to block 1402 of FIG. 14. After such a determination that the device 330 requires activation, the kiosk 100 prompts the user to activate the device 330 by entering the required credentials, as described above with reference to block 1416 of FIG. 14. The kiosk 100 can display a series of instructions for device activation to ensure that the device 330 is not associated with a remote user account. FIG. 18, for example, is a display diagram illustrating an instruction 1800 for activating the device 330 in accordance with embodiments of the present technology. The instructional text 1802 indicates that if the device's home screen is visible, then the device 330 has been successfully activated.

In various embodiments, it may be useful to limit the use of a wireless network to allowed purposes rather than providing, for example, unlimited Wi-Fi network access to some or all devices 330 that connect to the kiosk's wireless network. FIG. 19, for example, is a flow diagram of a routine 1900 for filtering wireless communications in accordance with embodiments of the present technology. In block 1902, the routine 1900 determines a purpose for a wireless device connection. For example, as described above, the kiosk's wireless network can be provided for allowing an app download, activating a reset device 330, and/or turning off a remote kill switch feature, among other purposes. In block 1904, the routine 1900 identifies types of communications associated with the purpose for the wireless device connection. For example, communications can be identified by domain (e.g., apple.com), by individual server address (e.g., gsx.apple.com), by message type (email, secure HTML GET/POST request and reply, etc.), by specific message formatting, and so on. In block 1906, the routine 1900 receives wireless device communications from and/or to the device 330. In decision block 1908, the routine 1900 determines whether the device communications are allowed, such as by comparing various features of those communications to the identified types of communications associated with the purpose for allowing network access. In block 1910, disallowed communications are blocked; in some embodiments, the disallowed communications are dropped. In other embodiments, the disallowed communications produce an error code or message to the user that the kiosk 100 can display on the display screen 104 and/or play through the kiosk speaker 304, or that the device 330 can present to the user via the device screen 342 and/or the device speaker 344. In some embodiments, a user's attempts to use the wireless network for unpermitted purposes result in the kiosk 100 disallowing the device 330 from the wireless network or turning the wireless network off. In block 1912, allowed communications are permitted. After allowed communications have concluded, the routine 1900 ends.

In various embodiments, the present technology can include identifying wireless devices 330. FIG. 20, for example, is a flow diagram of a routine 2000 for identifying a wireless device such as a mobile phone, tablet computer, laptop computer, or music player (e.g., the device 330) in accordance with embodiments of the present technology. In block 2002, the routine 2000 detects a wireless device 330 that is not connected to the kiosk's wireless network. For example, a Wi-Fi or Bluetooth device can broadcast information according to various low-level protocols for identifying available networks and devices (for example, IP packets in Ethernet frames, which can include probe request and probe response frames). Wi-Fi client stations (e.g., a device 330) can transmit, on various channels, packets searching for access points (e.g., an access point that the client station had previously connected to), and those trans-

missions typically reveal the device's Wi-Fi MAC address. The kiosk 100 can detect a wireless device 330 unassociated with the kiosk's wireless network by passive scanning (such as observing wireless data traffic) and/or active scanning (such as sending wireless data to prompt devices to reply and reveal their presence to the kiosk 100). In block 2004, when the kiosk 100 has detected the device 330, the routine 2000 observes characteristics of the device 330. Such characteristics can include, for example, MAC address information, signal strength, protocol response patterns, channels, etc. For example, a MAC address may include numbers that encode or otherwise indicate a device's manufacturer or other information about the device 330. In block 2006, the routine 2000 compares the observed characteristics with stored device signatures, such as information in the database 406. In block 2008, the routine 2000 identifies the device 330 based on the comparison. In some embodiments, the routine 2000 can identify the device 330 probabilistically or as one of a category of devices (e.g., a Samsung phone, or one of a group of devices); in some embodiments, the routine 2000 identifies the device 330 as a particular device.

FIG. 21 is a flow diagram of a routine 2100 for identifying a connected wireless device 330 in accordance with embodiments of the present technology. In block 2102, the device 330 is connected to the kiosk's wireless network and the routine 2100 wirelessly receives data transmitted by the device 330 over the network. The device 330 can send packets of data addressed to the kiosk 100, for example, including data directed to the kiosk 100 and data sent through the kiosk 100 to a remote server (e.g., to the device manufacturer's activation server 424). As a result of the device sending and receiving data using the kiosk's wireless network, the kiosk 100 is able to capture and/or inspect the device's data transmissions. In block 2104, the routine 2100 inspects the data. The contents of the wireless data transmissions can include, for example, a MAC address that indicates the device's manufacturer, packet header information identifying the type of the device 330, and/or packet payload information that reveals the identity of the device 330 (for example, a web page request that includes data telling the web server what kind of device is making the web page request, so that a properly displayable page is returned to the device 330). In block 2106, the routine 2100 identifies the device 330 based on the data.

FIG. 22 is a flow diagram of a routine 2200 for recording wireless device activity in accordance with embodiments of the present technology. In block 2202, the routine 2200 receives wireless signals from mobile devices 330 (e.g., mobile phones; PDAs; wearable computing devices such as smartwatches and wireless headsets; tablet, netbook, and laptop computers; e-readers; music playing devices; etc.) within range of the kiosk 100, as described above with reference to FIGS. 20 and 21. In some embodiments, the kiosk 100 receives wireless signals over networks having varied ranges, such as the ranges described above with reference to block 602 of FIG. 6. For example, devices 330 detected via a sensitive Wi-Fi antenna may be at a greater distance from the kiosk 100 than devices 330 detected via a Bluetooth, ZigBee, or NFC antenna configured for short range communication. In blocks 2204-2212, the routine 2200 iterates for each detected device 330. In block 2206, the routine 2200 records information associated with the detected device 330. The information can include, for example, the device's MAC address, the time and duration of time when the device 330 was present, and signal strength while the device 330 is detected. In block 2208, the routine 2200 adds the device 330 to a count of device traffic, and in

block 2210, the routine 2200 associates the device 330 with activity at the kiosk 100 at the time when the device 330 was detected. In block 2212, the routine 2200 proceeds to the next device 330 detected. In block 2214, the routine 2200 aggregates detected device data, and in block 2216, the routine 2200 processes the aggregated data. For example, in some embodiments, processing data can include evaluating kiosk 100 location quality and/or promotion opportunities by, for example, comparing high-traffic periods to kiosk 100 high-usage times; comparing traffic at different locations; and/or analyzing the signal strength of traffic to determine whether potential customers are close to or far from the kiosk 100. In some embodiments, processing data can include identifying devices 330 that are near the kiosk 100 at the time of (and thus possibly associated with) attempted fraudulent transactions, and adding the presence of such devices 330 to potential do-not-buy indicators, to potential hawker lists, etc. As another example, processing data can include identifying devices 330 that remain near the kiosk 100 without being sold at the kiosk 100, which may indicate the presence of a hawker trying to compete with the kiosk 100. In some embodiments, processing data can include reselling data, packaging data, etc.

FIG. 23 is a flow diagram of a routine 2300 for locating a wireless enabled electronic device such as the device 330 in accordance with embodiments of the present technology. In block 2302, the routine 2300 wirelessly receives information associated with the device 330, for example, information used to evaluate the device 330 for possible purchase as described above with reference to block 1006 of FIG. 10. The information can include, for example, a unique identifier such as the device's IMEI number, and/or information describing the device's manufacturer, model, characteristics, capabilities, and/or condition. In block 2304, the routine 2300 evaluates the information, and in block 2306, the routine 2300 makes an offer to purchase the device 330 based on the evaluated information. In decision block 2307, if the user does not accept the offer, then the routine ends. If, on the other hand, the user accepts the offer and agrees to submit the device 330 at the kiosk 100, then in block 2308, the routine 2300 tracks the location of the device 330. In some embodiments, the routine 2300 uses GPS location information or other location data (e.g., indoor positioning system or real-time locating system data) available on the device 330, e.g., through the app installed on the device 330. In some embodiments, the routine 2300 tracks the device's location over a short distance using multiple kiosk antennas. For example, the routine 2300 can use angularly arrayed directional antennas to measure the strength of signals from the device 330 in multiple directions to estimate the location of the device 330 without the use of triangulation. As another example, the routine 2300 may use well-known multilateration techniques to locate the source of the device's wireless signal based on the timing of signals received from the device 330 at multiple antennas and/or triangulation techniques to locate the source of the device's wireless signal based on directional information received at two or more antennas. In some embodiments, the routine 2300 adjusts the power of a wireless signal to determine whether the device 330 is within the reduced range of the low-power signal, or uses a short-range wireless receiver (e.g., NFC) to track the device 330 to within the receiver's range. In some embodiments, the routine 2300 determines information about the device's location by detecting the device's signal strength and/or continuity, including changes in the device's signal strength. In some embodiments, signal strength detection can include implementation of a Faraday

cage into which the device 330 should pass. For example, if the kiosk inspection area 108 behind the access panel or door 106 of FIG. 1 is configured to, for example, reflect wireless signals within the inspection area and/or attenuate wireless signals from outside the inspection area, then the kiosk 100 can detect whether the device 330 is within the inspection area by observing whether wireless signals from the device 330 are reflected or attenuated when the access panel or door 106 is closed. In decision block 2310, the routine 2300 checks whether the device 330 is located within the kiosk 100. If the tracked location of the device 330 is not within the kiosk 100, then in block 2312 the routine 2300 rejects the submitted item that is apparently not the correct device 330. If, however, the tracked location of the device 330 is within the kiosk 100, then in block 2314 the routine 2300 can accept the device 330 with confidence that the kiosk has received the correct device 330. The routine 2300 can then complete the purchase according to the offer that the user accepted, after which the routine 2300 ends.

The present technology allows wireless enabled devices of various types such as mobile phones (smartphones and feature phones, for example), wearable computers, game devices, media players, desktop computers, etc. (e.g., the device 330) to be evaluated and purchased by an automated kiosk 100 with improved ease and speed. The present technology enables the user to submit the device 330 in a reduced number of steps and to take advantage of a wireless connection between the device 330 and the kiosk 100 so that the user does not have to connect wires from the kiosk 100 to the device 330. For example, the user may want to obtain an estimated price for his or her device 330 while maintaining possession of the device 330; for example, the user may not wish to place his or her device 330 into the inspection area 108 of the kiosk 100. In some embodiments, the present technology provides a “quick quote” or initial price estimate that the kiosk 100 can offer the user based on performing an analysis of the device 330 without requiring the user to give up control of his or her device 330. The kiosk can perform a visual analysis of the device 330 using one or more of the kiosk’s external cameras 116a—c. For example, to initiate obtaining such a price estimate, the user can swipe an NFC-enabled device 330 against or in close proximity to (e.g., within a few inches of) an NFC sensor on the kiosk 100, or use the device 330 to scan a code such as a QR code displayed on the display screen 104. The user’s action to initiate the “quick quote” process can, for example, launch the app on the user’s device 330 and/or transfer information about the user’s device 330 from the device 330 to the kiosk 100. The kiosk 100 and/or the app may instruct the user to position the device 330 so that one or more of the cameras 116a—c can image the device 330 to perform an initial visual analysis of the device. For example, they may instruct the user to hold his or her device at various angles or distances from the camera 116 (e.g., to show components of the device 330 and/or information printed on the device 330), or direct the user to display particular content on the screen 342 of the device 330 (e.g., a device information “about” screen or a screen displayed by the app) for evaluation by the kiosk through the camera 116. If the information and/or initial visual analysis are sufficient for the kiosk 100 to provide an initial quote, the kiosk 100 can provide the user a price or estimated range of prices for the device 330, e.g., via the display screen 104.

FIGS. 24A-24D, for example, are a series of display diagrams illustrating instructions for submitting the device 330 in accordance with embodiments of the present technology. In some embodiments, the kiosk 100 displays the

illustrated textual instructions and accompanying graphical diagrams on the display screen 104 in response to, e.g., a user initiating a transaction to recycle a wireless device 330 at the kiosk 100. The kiosk 100 can display instructions that include, for example, animated graphics or text, photographs, and/or video guidance to the user. In FIG. 24A, the illustrated display page 2410 instructs the user to place his or her wireless device 330 within the kiosk inspection area 108. The device 330 can be connected to the kiosk’s wireless network, for example, so that the kiosk 100 has wirelessly obtained information sufficient for an electrical evaluation of the device 330 as described above with respect to FIG. 10. In FIG. 24B, the illustrated display page 2420 indicates that the kiosk 100 is receiving the wireless device 330, with the access panel or door 106 closing over the inspection area 108. After the user places the device 330 in the kiosk 100 as instructed, the kiosk 100 performs a visual evaluation of the device 330 as described above with respect to FIG. 2B. In FIG. 24C, the kiosk 100 informs the user via a display page 2430 illustrating a message that the device 330 has been detected, indicating successful evaluation of the device 330 without a wired connection. In FIG. 24D, the illustrated display page 2440 presents an offer to purchase the customer’s device 330 based on the wireless evaluation.

The present technology includes various other types and embodiments of recycling machines. For example, the present technology includes embodiments such as a countertop recycling station and/or a retail store-based interface operated by or with the assistance of a retail employee. As another example, the present technology includes embodiments such as a recycling machine configured to accept all kinds of devices, including larger items (e.g., desktop and laptop computers, televisions, gaming consoles, DVRs, etc.).

The above Detailed Description of examples and embodiments of the invention is not intended to be exhaustive or to limit the invention to the precise form disclosed above. Although specific examples for the invention are described above for illustrative purposes, various equivalent modifications are possible within the scope of the invention, as those skilled in the relevant art will recognize.

References throughout the foregoing description to features, advantages, or similar language do not imply that all of the features and advantages that may be realized with the present technology should be or are in any single embodiment of the invention. Rather, language referring to the features and advantages is understood to mean that a specific feature, advantage, or characteristic described in connection with an embodiment is included in at least one embodiment of the present technology. Thus, discussion of the features and advantages, and similar language, throughout this specification may, but do not necessarily, refer to the same embodiment.

Furthermore, the described features, advantages, and characteristics of the present technology may be combined in any suitable manner in one or more embodiments. One skilled in the relevant art will recognize that the present technology can be practiced without one or more of the specific features or advantages of a particular embodiment. In other instances, additional features and advantages may be recognized in certain embodiments that may not be present in all embodiments of the present technology.

Any patents and applications and other references noted above, including any that may be listed in accompanying filing papers, are incorporated herein by reference. Aspects of the invention can be modified, if necessary, to employ the

systems, functions, and concepts of the various references described above to provide yet further implementations of the invention.

Unless the context clearly requires otherwise, throughout the description and the claims, the words “comprise,” “comprising,” and the like are to be construed in an inclusive sense, as opposed to an exclusive or exhaustive sense; that is to say, in the sense of “including, but not limited to.” As used herein, the terms “connected,” “coupled,” or any variant thereof means any connection or coupling, either direct or indirect, between two or more elements; the coupling or connection between the elements can be physical, logical, or a combination thereof. Additionally, the words “herein,” “above,” “below,” and words of similar import, when used in this application, refer to this application as a whole and not to any particular portions of this application. Where the context permits, words in the above Detailed Description using the singular or plural number may also include the plural or singular number respectively. The word “or,” in reference to a list of two or more items, covers all of the following interpretations of the word: any of the items in the list, all of the items in the list, and any combination of the items in the list.

The teachings of the invention provided herein can be applied to other systems, not necessarily the system described above. The elements and acts of the various examples described above can be combined to provide further implementations of the invention. Some alternative implementations of the invention may include not only additional elements to those implementations noted above, but also may include fewer elements. Further any specific numbers noted herein are only examples: alternative implementations may employ differing values or ranges.

Although the above description describes various embodiments of the invention and the best mode contemplated, regardless how detailed the above text, the invention can be practiced in many ways. Details of the system may vary considerably in its specific implementation, while still being encompassed by the present technology. As noted above, particular terminology used when describing certain features or aspects of the invention should not be taken to imply that the terminology is being redefined herein to be restricted to any specific characteristics, features, or aspects of the invention with which that terminology is associated. In general, the terms used in the following claims should not be construed to limit the invention to the specific examples disclosed in the specification, unless the above Detailed Description section explicitly defines such terms. Accordingly, the actual scope of the invention encompasses not only the disclosed examples, but also all equivalent ways of practicing or implementing the invention under the claims.

From the foregoing, it will be appreciated that specific embodiments of the invention have been described herein for purposes of illustration, but that various modifications may be made without deviating from the spirit and scope of the various embodiments of the invention. Further, while various advantages associated with certain embodiments of the invention have been described above in the context of those embodiments, other embodiments may also exhibit such advantages, and not all embodiments need necessarily exhibit such advantages to fall within the scope of the invention. Accordingly, the invention is not limited, except as by the appended claims.

Although certain aspects of the invention are presented below in certain claim forms, the applicant contemplates the various aspects of the invention in any number of claim forms. Accordingly, the applicant reserves the right to pur-

sue additional claims after filing this application to pursue such additional claim forms, in either this application or in a continuing application.

We claim:

1. A method for evaluating and purchasing an electronic device, the method comprising:

via a first processor of an electronic device:

receiving an identifier associated with first information of the electronic device, wherein the identifier is received remote from a recycling kiosk, and transmitting the identifier and the first information to a remote server; and

via a second processor of the recycling kiosk:

receiving the identifier from the electronic device, receiving the first information from the remote server, performing an inspection of the electronic device to determine second information associated with the electronic device,

comparing the first information and the second information, and

offering to purchase the electronic device for a price, wherein the price is based at least partially on the first information.

2. The method of claim 1 wherein the first information includes at least one of a make, a model, a serial number, an IMEI number, and/or a cosmetic condition of a display screen of the electronic device.

3. The method of claim 1 wherein the second information includes at least one of a make, a model, a serial number, an IMEI number, and/or a cosmetic condition of a display screen of the electronic device.

4. The method of claim 1 wherein performing the inspection to determine the second information includes:

prompting a user to position the electronic device within an inspection area of the recycling kiosk while the electronic device displays the second information on a display screen of the electronic device; and

using a camera positioned within the inspection area to perform optical character recognition to read the second information from the display screen.

5. The method of claim 1 wherein the inspection includes a visual inspection, and wherein performing the visual inspection includes obtaining, via a camera of the recycling kiosk, one or more images of the electronic device.

6. The method of claim 1 wherein the identifier includes at least one of a barcode and/or a QR code associated with the electronic device and/or the first information.

7. The method of claim 1 wherein receiving the identifier includes scanning the identifier via an externally-facing scanner of the recycling kiosk.

8. The method of claim 1 wherein the electronic device is a mobile phone.

9. A method for evaluating and purchasing an electronic device at a recycling kiosk, the method comprising:

receiving, via a software application executed on the electronic device, information about the electronic device;

instructing a user to scan a machine-readable code at the recycling kiosk, the machine-readable code associated with using the recycling kiosk to purchase the electronic device;

receiving the electronic device from the user in an inspection area of the recycling kiosk;

visually inspecting the electronic device using one or more cameras positioned within the inspection area; and

37

determining a purchase price for the electronic device based at least partially on the information and the visual inspection.

10. The method of claim 9 wherein visually inspecting the electronic device includes visually inspecting a cosmetic condition of a display screen of the electronic device.

11. The method of claim 9 wherein receiving the electronic device from the user includes prompting the user to cause a display screen of the electronic device to display a unique identifier associated with the electronic device, and wherein visually inspecting the electronic device includes using optical character recognition to read the unique identifier from the display screen.

12. The method of claim 11 wherein the unique identifier includes at least one of a make, a model, a serial number, and/or an IMEI number for the electronic device.

13. The method of claim 9, further comprising:
determining an initial purchase price for the electronic device based at least partially on the received information; and
displaying the initial purchase price to the user via a display screen of the electronic device.

14. The method of claim 9 wherein instructing the user to scan the machine-readable code includes instructing the user to scan, with the electronic device, a QR code displayed by a display screen of the recycling kiosk.

15. The method of claim 9 wherein the electronic device is a mobile phone.

16. A kiosk for evaluating and purchasing electronic devices, the kiosk comprising:

a housing;
an inspection area within the housing and configured to receive an electronic device from a user;
a first camera coupled to the housing and operable to image the electronic device;
a second camera having a viewing angle including the inspection area;
a processor; and

a non-transitory computer-readable medium having instructions that, when executed by the processor, cause the kiosk to—

image at least part of the electronic device with the first camera;

receive, via a wireless communication component of the kiosk, information about the electronic device;
prompt the user to position the electronic device within the inspection area;

visually inspect the electronic device via the second camera when the electronic device is positioned within the inspection area; and

determine a price for the electronic device based at least partially on the received information and the visual inspection.

17. The kiosk of claim 16, further comprising a transparent plate within the inspection area, wherein the transparent plate is configured to support the electronic device within the inspection area.

38

18. The kiosk of claim 17 wherein the second camera is positioned above the transparent plate.

19. The kiosk of claim 17 wherein the second camera is positioned above the transparent plate, the kiosk further comprising a third camera having a viewing angle including the inspection area and positioned below the transparent plate.

20. The kiosk of claim 16, further comprising:

a storage receptacle within the housing and configured to receive the electronic device from the inspection area; and

a binning mechanism configured to move the electronic device from the inspection area toward the storage receptacle.

21. The kiosk of claim 16 wherein imaging at least part of the electronic device with the first camera comprises imaging a display screen of the electronic device.

22. The kiosk of claim 16 wherein the electronic device is a mobile phone.

23. The method of claim 1 wherein receiving the identifier from the electronic device via the second processor of the recycling kiosk includes receiving the identifier, by the second processor, from the remote server.

24. The method of claim 9 wherein receiving, via the software application executed on the electronic device, the information about the electronic device includes receiving the information about the electronic device at a remote server.

25. The method of claim 9 wherein receiving, via the software application executed on the electronic device, the information about the electronic device includes receiving, by the kiosk, at least a portion of the information about the electronic device from a remote server.

26. The method of claim 9 wherein determining the purchase price for the electronic device includes determining the purchase price by a remote server.

27. The method of claim 9 wherein using the recycling kiosk to purchase the electronic device includes facilitating payment of at least a portion of the purchase price to the user at a location other than the recycling kiosk.

28. The method of claim 9 wherein using the recycling kiosk to purchase the electronic device includes facilitating electronic payment of at least a portion of the purchase price to the user.

29. The kiosk of claim 16 wherein causing the kiosk to receive, via the wireless communication component, information about the electronic device includes causing the kiosk to receive at least a portion of the information about the electronic device from a remote server.

30. The kiosk of claim 16 wherein causing the kiosk to determine a price for the electronic device includes causing the kiosk to receive the price from a remote server.

* * * * *