



US011698721B2

(12) **United States Patent**
Wong et al.

(10) **Patent No.:** **US 11,698,721 B2**
(45) **Date of Patent:** **Jul. 11, 2023**

(54) **MANAGING AN IMMERSIVE INTERFACE
IN A MULTI-APPLICATION IMMERSIVE
ENVIRONMENT**

(71) Applicant: **Microsoft Technology Licensing, LLC**,
Redmond, WA (US)

(72) Inventors: **Tsz Yan Wong**, Seattle, WA (US); **Jesse
Clay Satterfield**, Seattle, WA (US);
Nils A. Sundelin, Duvall, WA (US);
Bret P. Anderson, Kirkland, WA (US);
Patrice L. Miner, Kirkland, WA (US);
Chaitanya Dev Sareen, Seattle, WA
(US); **Robert J. Jarrett**, Snohomish,
WA (US); **Jennifer Nan**, Seattle, WA
(US)

(73) Assignee: **Microsoft Technology Licensing, LLC**,
Redmond, WA (US)

(*) Notice: Subject to any disclaimer, the term of this
patent is extended or adjusted under 35
U.S.C. 154(b) by 196 days.

(21) Appl. No.: **15/341,840**

(22) Filed: **Nov. 2, 2016**

(65) **Prior Publication Data**

US 2017/0068428 A1 Mar. 9, 2017

Related U.S. Application Data

(63) Continuation of application No. 13/657,621, filed on
Oct. 22, 2012, now Pat. No. 9,535,597, which is a
(Continued)

(51) **Int. Cl.**

G06F 3/04886 (2022.01)
G06F 3/04845 (2022.01)
G06F 3/0481 (2022.01)

G06F 3/04883 (2022.01)
G06F 3/0488 (2022.01)

(52) **U.S. Cl.**
CPC **G06F 3/04845** (2013.01); **G06F 3/0481**
(2013.01); **G06F 3/0488** (2013.01); **G06F**
3/04883 (2013.01); **G06F 3/04886** (2013.01)

(58) **Field of Classification Search**
CPC .. **G06F 3/04845**; **G06F 3/0481**; **G06F 3/0488**;
G06F 3/04883; **G06F 3/04886**
See application file for complete search history.

(56) **References Cited**

U.S. PATENT DOCUMENTS

4,686,332 A 8/1987 Greanias et al.
4,823,283 A 4/1989 Diehm et al.
(Continued)

FOREIGN PATENT DOCUMENTS

CN 1129889 8/1996
CN 1326564 12/2001
(Continued)

OTHER PUBLICATIONS

“Corrected Notice of Allowance”, U.S. Appl. No. 14/918,358, filed
Oct. 4, 2017, 2 pages.

(Continued)

Primary Examiner — Dino Kujundzic

(57) **ABSTRACT**

This document describes techniques and apparatuses for
managing an immersive interface in a multi-application
immersive environment. In some embodiments, these tech-
niques and apparatuses enable a user to alter sizes and/or a
layout of multiple immersive interfaces with as little as one
selection.

20 Claims, 25 Drawing Sheets

1900 →

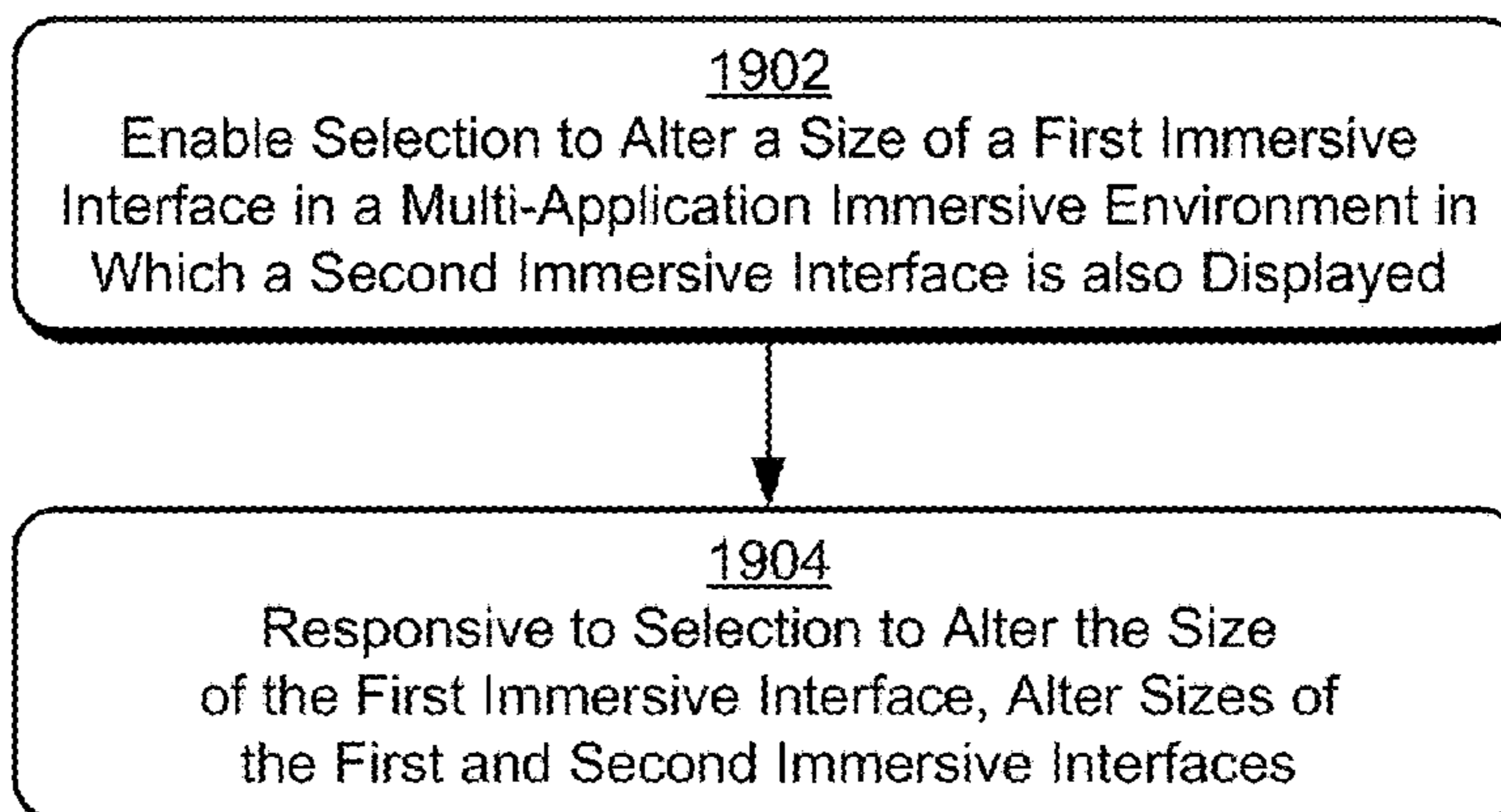

Related U.S. Application Data

continuation of application No. 13/118,333, filed on May 27, 2011, now Pat. No. 9,158,445, which is a continuation of application No. 13/118,321, filed on May 27, 2011, now abandoned.

(56)

References Cited

U.S. PATENT DOCUMENTS

4,843,538 A	6/1989	Lane et al.	5,969,720 A	10/1999	Lisle et al.
5,045,997 A	9/1991	Watanabe	6,008,809 A	12/1999	Brooks
5,046,001 A	9/1991	Barker et al.	6,008,816 A	12/1999	Eisler
5,189,732 A	2/1993	Kondo	6,009,519 A	12/1999	Jones et al.
5,231,578 A	7/1993	Levin et al.	6,011,542 A	1/2000	Durrani et al.
5,237,647 A	8/1993	Roberts et al.	6,016,145 A	1/2000	Horvitz et al.
5,258,748 A	11/1993	Jones	6,028,600 A	2/2000	Rosin et al.
5,297,032 A	3/1994	Trojan et al.	6,037,937 A	3/2000	Beaton et al.
5,305,435 A	4/1994	Bronson	6,057,839 A	5/2000	Advani et al.
5,321,750 A	6/1994	Nadan	6,061,061 A	5/2000	Conrad et al.
5,339,392 A	8/1994	Risberg et al.	6,064,383 A	5/2000	Skelly
5,351,995 A	10/1994	Booker et al.	6,072,476 A	6/2000	Harada et al.
5,406,307 A	4/1995	Hirayama et al.	6,097,392 A	8/2000	Leyerle
5,432,932 A	7/1995	Chen et al.	6,104,418 A	8/2000	Tanaka et al.
5,463,725 A	10/1995	Henckel et al.	6,108,003 A	8/2000	Hall, Jr. et al.
5,485,197 A	1/1996	Hoarty	6,111,585 A	8/2000	Choi
5,487,143 A	1/1996	Southgate	6,115,040 A	9/2000	Bladow et al.
5,490,241 A	2/1996	Mallgren et al.	6,115,724 A	9/2000	Booker et al.
5,491,783 A	2/1996	Douglas et al.	6,163,317 A	12/2000	de Judicibus
5,495,566 A	2/1996	Kwatinetz	6,163,749 A	12/2000	McDonough et al.
5,497,776 A	3/1996	Yamazaki et al.	6,166,736 A	12/2000	Hugh
5,506,951 A	4/1996	Ishikawa	6,167,439 A	12/2000	Levine et al.
5,510,808 A	4/1996	Cina, Jr. et al.	6,188,405 B1	2/2001	Czerwinski et al.
5,511,148 A	4/1996	Wellner	6,211,921 B1	4/2001	Cherian et al.
5,515,495 A	5/1996	Ikemoto	6,212,564 B1	4/2001	Harter et al.
5,555,369 A	9/1996	Menendez et al.	6,216,141 B1	4/2001	Straub et al.
5,568,604 A	10/1996	Hansen	6,219,032 B1	4/2001	Rosenberg et al.
5,574,836 A	11/1996	Broemmelsiek	6,239,798 B1	5/2001	Ludolph et al.
5,586,244 A	12/1996	Berry et al.	6,266,098 B1	7/2001	Cove et al.
5,596,697 A	1/1997	Foster et al.	6,278,448 B1	8/2001	Brown et al.
5,598,523 A	1/1997	Fujita	6,281,940 B1	8/2001	Sciammarella
5,603,053 A	2/1997	Gough et al.	6,292,179 B1	9/2001	Lee
5,611,060 A	3/1997	Belfiore et al.	6,310,610 B1	10/2001	Beaton et al.
5,623,613 A	4/1997	Rowe et al.	6,311,058 B1	10/2001	Wecker et al.
5,640,176 A	6/1997	Mundt et al.	6,313,854 B1	11/2001	Gibson
5,650,827 A	7/1997	Tsumori et al.	6,340,979 B1	1/2002	Beaton et al.
5,657,049 A	8/1997	Ludolph et al.	6,346,935 B1	2/2002	Nakajima et al.
5,659,693 A	8/1997	Hansen	6,369,837 B1	4/2002	Schirmer
5,661,773 A	8/1997	Swerdloff et al.	6,385,630 B1	5/2002	Ejerhed
5,664,128 A	9/1997	Bauer	6,389,386 B1	5/2002	Hetherington et al.
5,675,329 A	10/1997	Barker	6,396,963 B2	5/2002	Shaffer
5,680,562 A	10/1997	Conrad et al.	6,411,307 B1	6/2002	Rosin et al.
5,687,331 A	11/1997	Volk et al.	6,414,698 B1	7/2002	Lovell et al.
5,694,150 A	12/1997	Sigona et al.	6,424,338 B1	7/2002	Andersone
5,712,995 A	1/1998	Cohn	6,426,753 B1	7/2002	Migdal
5,731,813 A	3/1998	O'Rourke et al.	6,433,789 B1	8/2002	Rosman
5,740,389 A	4/1998	Li et al.	6,448,987 B1	9/2002	Easty et al.
5,761,485 A	6/1998	Munyan	6,449,638 B1	9/2002	Wecker et al.
5,771,042 A	6/1998	Santos-Gomez	6,456,334 B1	9/2002	Duhault
5,793,415 A	8/1998	Gregory et al.	6,489,977 B2	12/2002	Sone
5,817,019 A	10/1998	Kawashima	6,493,002 B1	12/2002	Christensen
5,819,284 A	10/1998	Farber et al.	6,505,243 B1	1/2003	Lortz
5,821,930 A	10/1998	Hansen	6,507,352 B1	1/2003	Cohen et al.
5,838,889 A	11/1998	Booker et al.	6,507,643 B1	1/2003	Groner
5,844,547 A	12/1998	Minakuchi et al.	6,510,144 B1	1/2003	Dommety et al.
5,847,706 A	12/1998	Kingsley	6,510,466 B1	1/2003	Cox et al.
5,859,636 A	1/1999	Pandit	6,510,553 B1	1/2003	Hazra
5,860,073 A	1/1999	Ferrel et al.	6,525,749 B1	2/2003	Moran et al.
5,867,799 A	2/1999	Lang et al.	6,538,635 B1	3/2003	Ringot
5,880,725 A	3/1999	Southgate	6,542,868 B1	4/2003	Badt
5,889,517 A	3/1999	Ueda et al.	6,545,669 B1	4/2003	Kinawi et al.
5,898,434 A	4/1999	Small et al.	6,570,597 B1	5/2003	Seki et al.
5,905,492 A	5/1999	Straub et al.	6,577,323 B1	6/2003	Jamieson et al.
5,914,720 A	6/1999	Maples et al.	6,577,350 B1	6/2003	Proehl et al.
5,940,076 A	8/1999	Sommers et al.	6,591,244 B2	7/2003	Jim et al.
5,959,621 A	9/1999	Nawaz et al.	6,597,374 B1	7/2003	Baker et al.
5,963,204 A	10/1999	Ikeda et al.	6,628,309 B1	9/2003	Dodson et al.
			6,636,246 B1	10/2003	Gallo et al.
			6,658,147 B2	12/2003	Gorbatov et al.
			6,661,436 B2	12/2003	Barksdale et al.
			6,662,023 B1	12/2003	Helle
			6,675,387 B1	1/2004	Boucher et al.
			6,690,387 B2	2/2004	Zimmerman et al.
			6,697,825 B1	2/2004	Underwood et al.
			6,707,449 B2	3/2004	Hinckley et al.
			6,710,771 B1	3/2004	Yamaguchi et al.
			6,721,958 B1	4/2004	Dureau
			6,724,403 B1	4/2004	Santoro et al.
			6,727,892 B1	4/2004	Murphy

(56)

References Cited

U.S. PATENT DOCUMENTS

6,738,084 B1	5/2004	Kelley et al.	7,310,100 B2	12/2007	Hussain
6,750,872 B1	6/2004	Hong et al.	7,333,092 B2	2/2008	Zadesky et al.
6,784,925 B1	8/2004	Tomat et al.	7,333,120 B2	2/2008	Venolia
6,798,421 B2	9/2004	Baldwin	7,336,263 B2	2/2008	Valikangas
6,801,203 B1	10/2004	Hussain	7,348,965 B2	3/2008	Itoh
6,807,558 B1	10/2004	Hassett et al.	7,369,647 B2	5/2008	Gao et al.
6,832,355 B1	12/2004	Duperrouzel et al.	7,376,907 B2	5/2008	Santoro et al.
6,839,763 B1	1/2005	Kamvysselis et al.	7,386,807 B2	6/2008	Cummins et al.
6,857,104 B1	2/2005	Cahn	7,388,578 B2	6/2008	Tao
6,859,909 B1	2/2005	Lerner et al.	7,403,191 B2	7/2008	Sinclair
6,865,297 B2	3/2005	Loui	7,404,147 B2	7/2008	Bell et al.
6,873,329 B2	3/2005	Cohen et al.	7,408,538 B2	8/2008	Hinckley et al.
6,876,312 B2	4/2005	Yu	7,409,646 B2	8/2008	Vedbrat et al.
6,885,974 B2	4/2005	Holle	7,412,663 B2	8/2008	Lindsay et al.
6,904,597 B2	6/2005	Jin	7,424,686 B2	9/2008	Beam et al.
6,920,445 B2	7/2005	Bae	7,433,920 B2	10/2008	Blagsvedt et al.
6,920,619 B1	7/2005	Milekic	7,437,678 B2	10/2008	Awada et al.
6,938,101 B2	8/2005	Hayes et al.	7,447,520 B2	11/2008	Scott
6,961,731 B2	11/2005	Holbrook	7,454,717 B2	11/2008	Hinckley et al.
6,971,067 B1	11/2005	Karson et al.	7,461,151 B2	12/2008	Colson et al.
6,972,776 B2	12/2005	Davis et al.	7,469,380 B2	12/2008	Wessling et al.
6,975,306 B2	12/2005	Hinckley	7,469,381 B2	12/2008	Ording
6,976,210 B1	12/2005	Silva et al.	7,478,326 B2	1/2009	Holeccek et al.
6,978,303 B1	12/2005	McCreech et al.	7,479,949 B2	1/2009	Jobs et al.
6,983,310 B2	1/2006	Rouse	7,480,870 B2	1/2009	Anzures
6,987,991 B2	1/2006	Nelson	7,483,418 B2	1/2009	Maurer
7,013,041 B2	3/2006	Miyamoto	7,484,182 B1	1/2009	Smith
7,017,119 B1	3/2006	Johnston et al.	7,487,467 B1	2/2009	Kawahara et al.
7,019,757 B2	3/2006	Brown et al.	7,496,830 B2	2/2009	Rubin
7,028,264 B2	4/2006	Santoro et al.	7,500,175 B2	3/2009	Colle et al.
7,032,187 B2	4/2006	Keely, Jr. et al.	7,506,269 B2	3/2009	Lang
7,036,090 B1	4/2006	Nguyen	7,512,966 B2	3/2009	Lyons, Jr. et al.
7,036,091 B1	4/2006	Nguyen	7,532,196 B2	5/2009	Hinckley
7,042,460 B2	5/2006	Hussain et al.	7,549,131 B2	6/2009	Lengeling et al.
7,051,276 B1 *	5/2006	Mogilevsky G06F 40/106 715/209	7,577,918 B2	8/2009	Lindsay
7,051,291 B2	5/2006	Sciammarella et al.	7,581,034 B2	8/2009	Polivy et al.
7,058,955 B2	6/2006	Porkka	7,593,995 B1	9/2009	He et al.
7,061,545 B1 *	6/2006	Kweon H04N 5/44543 348/569	7,595,810 B2	9/2009	Louch
7,065,385 B2	6/2006	Jarrad et al.	7,599,790 B2	10/2009	Rasmussen et al.
7,065,386 B1	6/2006	Smethers	7,600,189 B2	10/2009	Fujisawa
7,075,535 B2	7/2006	Aguera y Arcas	7,600,234 B2	10/2009	Dobrowski et al.
7,089,507 B2	8/2006	Lection et al.	7,606,714 B2	10/2009	Williams et al.
7,091,998 B2	8/2006	Miller-Smith	7,607,106 B2	10/2009	Ernst et al.
7,093,201 B2	8/2006	Duarte	7,610,563 B2	10/2009	Nelson et al.
7,106,349 B2	9/2006	Baar et al.	7,619,615 B1	11/2009	Donoghue
7,111,044 B2	9/2006	Lee	7,636,071 B2	12/2009	O'Gorman
7,133,707 B1	11/2006	Rak	7,640,518 B2	12/2009	Forlines et al.
7,133,859 B1	11/2006	Wong	7,653,883 B2	1/2010	Hotelling et al.
7,139,800 B2	11/2006	Bellotti et al.	7,656,393 B2	2/2010	King et al.
7,146,573 B2	12/2006	Brown et al.	7,657,849 B2	2/2010	Chaudhri et al.
7,155,729 B1	12/2006	Andrew et al.	7,663,607 B2	2/2010	Hotelling et al.
7,158,123 B2	1/2007	Myers et al.	7,664,067 B2	2/2010	Pointer
7,158,135 B2	1/2007	Santodomingo et al.	7,669,140 B2	2/2010	Matthews et al.
7,178,111 B2	2/2007	Glein et al.	7,671,756 B2	3/2010	Herz et al.
7,180,527 B2	2/2007	Sakai et al.	7,676,767 B2	3/2010	Hofmeister et al.
7,181,699 B2	2/2007	Morrow et al.	7,689,916 B1	3/2010	Goel et al.
7,194,506 B1	3/2007	White et al.	7,694,221 B2	4/2010	Fortes
7,210,099 B2	4/2007	Rohrbaugh et al.	7,702,683 B1	4/2010	Kirshenbaum
7,216,588 B2	5/2007	Suess	7,755,674 B2	7/2010	Kaminaga
7,249,326 B2	7/2007	Stoakley et al.	7,760,187 B2	7/2010	Kennedy
7,250,955 B1	7/2007	Beeman et al.	7,774,366 B2	8/2010	Fisher et al.
7,251,782 B1	7/2007	Albers	7,792,925 B1	9/2010	Werner et al.
7,257,200 B2	8/2007	Valeriano	7,821,780 B2	10/2010	Choy
7,262,775 B2	8/2007	Calkins et al.	7,834,861 B2	11/2010	Lee
7,263,668 B1	8/2007	Lentz	7,844,915 B2	11/2010	Platzer et al.
7,277,924 B1	10/2007	Wichmann et al.	D631,043 S	1/2011	Kell
7,280,097 B2	10/2007	Chen	7,877,707 B2	1/2011	Westerman et al.
7,283,620 B2	10/2007	Adamczyk	7,880,728 B2	2/2011	De Los Reyes et al.
7,289,806 B2	10/2007	Morris et al.	7,889,180 B2	2/2011	Byun et al.
7,293,244 B2	11/2007	Randall	7,890,882 B1	2/2011	Nelson
7,296,184 B2	11/2007	Derks et al.	7,895,309 B2	2/2011	Belali et al.
7,296,242 B2	11/2007	Agata et al.	7,898,529 B2	3/2011	Fitzmaurice et al.
7,304,638 B2	12/2007	Murphy	7,903,115 B2	3/2011	Platzer et al.
			7,904,832 B2	3/2011	Ubillos
			7,924,271 B2	4/2011	Christie et al.
			7,933,632 B2	4/2011	Flynt et al.
			7,949,954 B1 *	5/2011	Jezeq, Jr. G06F 3/048 715/800
			7,956,847 B2	6/2011	Christie

(56)

References Cited

U.S. PATENT DOCUMENTS

7,962,281 B2	6/2011	Rasmussen et al.	8,994,697 B2	3/2015	Lin et al.
7,983,718 B1	7/2011	Roka	9,015,606 B2	4/2015	Zaman et al.
7,987,431 B2	7/2011	Santoro et al.	9,052,820 B2	6/2015	Jarrett et al.
7,996,045 B1	8/2011	Bauer et al.	9,092,132 B2	7/2015	Migos et al.
8,006,276 B2	8/2011	Nakagawa et al.	9,098,186 B1	8/2015	Worley et al.
8,028,239 B1	9/2011	Al-Hilali et al.	9,104,307 B2	8/2015	Jarrett et al.
8,065,629 B1	11/2011	Ragan	9,104,440 B2	8/2015	Jarrett et al.
8,086,275 B2	12/2011	Wykes	9,141,262 B2	9/2015	Nan et al.
8,102,858 B1	1/2012	Rahim et al.	9,146,670 B2	9/2015	Zaman et al.
8,108,781 B2	1/2012	Laansoo et al.	9,158,445 B2	10/2015	Wong et al.
8,126,865 B1	2/2012	Bharat et al.	9,213,468 B2	12/2015	Zaman et al.
8,131,808 B2	3/2012	Aoki et al.	9,229,918 B2	1/2016	Zaman et al.
8,134,727 B1	3/2012	Shmunis et al.	9,244,802 B2	1/2016	Yalovsky et al.
8,150,924 B2	4/2012	Buchheit et al.	9,329,774 B2	5/2016	Sareen et al.
8,171,431 B2	5/2012	Grossman et al.	9,383,917 B2	7/2016	Mouton et al.
8,175,653 B2	5/2012	Smuga	9,418,464 B2	8/2016	Fong et al.
8,176,436 B2	5/2012	Arend et al.	9,423,951 B2	8/2016	Deutsch et al.
8,176,438 B2	5/2012	Zaman et al.	9,430,130 B2	8/2016	Mathews et al.
8,209,623 B2	6/2012	Barletta et al.	9,535,597 B2	1/2017	Wong et al.
8,212,788 B2	7/2012	Lam	9,557,909 B2	1/2017	Elliott et al.
8,225,193 B1	7/2012	Kleinschnitz et al.	9,658,766 B2	5/2017	Nan et al.
8,238,876 B2	8/2012	Teng	9,665,384 B2	5/2017	Zielinski et al.
8,239,785 B2	8/2012	Hinckley	9,696,888 B2	7/2017	Deutsch et al.
8,245,152 B2	8/2012	Brunner et al.	9,760,242 B2	9/2017	Nan et al.
8,245,156 B2	8/2012	Mouilleseaux et al.	9,766,790 B2	9/2017	Zaman et al.
8,250,494 B2	8/2012	Butcher	9,864,494 B2	1/2018	Zaman et al.
8,255,473 B2	8/2012	Eren et al.	9,870,132 B2	1/2018	Zaman et al.
8,255,812 B1	8/2012	Parparita et al.	9,996,250 B2 *	6/2018	Hata G06F 3/0488
8,261,213 B2	9/2012	Hinckley	2001/0012000 A1	8/2001	Eberhard
8,266,550 B1	9/2012	Cleron et al.	2001/0022621 A1	9/2001	Squibbs
8,269,736 B2	9/2012	Wilairat	2001/0033296 A1 *	10/2001	Fullerton G06F 17/30017 715/730
8,279,241 B2	10/2012	Fong	2001/0047263 A1	11/2001	Smith et al.
8,290,926 B2	10/2012	Ozzie et al.	2002/0000963 A1	1/2002	Yoshida et al.
8,294,669 B2	10/2012	Partridge et al.	2002/0018051 A1	2/2002	Singh
8,307,279 B1	11/2012	Fioravanti et al.	2002/0026524 A1	2/2002	Dharap
8,327,295 B2	12/2012	Ikeda et al.	2002/0035607 A1	3/2002	Checkoway
8,334,871 B2	12/2012	Hamilton et al.	2002/0054117 A1	5/2002	van Dantzich et al.
8,384,726 B1	2/2013	Grabowski et al.	2002/0060701 A1	5/2002	Naughton et al.
8,429,565 B2	4/2013	Agarawala et al.	2002/0070961 A1	6/2002	Xu et al.
8,434,019 B2	4/2013	Nelson	2002/0077156 A1	6/2002	Smethers
8,448,083 B1	5/2013	Migos et al.	2002/0083025 A1	6/2002	Robarts et al.
8,473,870 B2	6/2013	Hinckley et al.	2002/0091755 A1	7/2002	Narin
8,473,871 B1	6/2013	Sandler et al.	2002/0097229 A1	7/2002	Rose et al.
8,493,510 B2	7/2013	Bryan et al.	2002/0097264 A1	7/2002	Dutta et al.
8,519,860 B2	8/2013	Johnson et al.	2002/0101457 A1	8/2002	Lang
8,525,808 B1	9/2013	Buening	2002/0105531 A1	8/2002	Niemi
8,539,384 B2	9/2013	Hinckley et al.	2002/0105553 A1	8/2002	Segre
8,548,431 B2	10/2013	Teng et al.	2002/0115476 A1	8/2002	Padawer et al.
8,549,432 B2	10/2013	Warner	2002/0116421 A1	8/2002	Fox et al.
8,560,959 B2	10/2013	Zaman et al.	2002/0128036 A1	9/2002	Yach et al.
8,589,815 B2	11/2013	Fong et al.	2002/0129061 A1	9/2002	Swart et al.
8,595,642 B1	11/2013	Lagassey	2002/0138248 A1	9/2002	Corston-Oliver et al.
8,612,874 B2	12/2013	Zaman et al.	2002/0142762 A1	10/2002	Chmaytelli et al.
8,627,227 B2	1/2014	Mathews et al.	2002/0145631 A1	10/2002	Arbab et al.
8,627,228 B2	1/2014	Yosef et al.	2002/0149622 A1	10/2002	Uesaki et al.
8,665,272 B2	3/2014	Fitzmaurice et al.	2002/0152305 A1	10/2002	Jackson et al.
8,669,950 B2	3/2014	Forstall et al.	2002/0154176 A1	10/2002	Barksdale et al.
8,687,023 B2	4/2014	Markiewicz et al.	2002/0158838 A1	10/2002	Smith et al.
8,689,123 B2	4/2014	Zaman et al.	2002/0159632 A1	10/2002	Chui et al.
8,698,845 B2	4/2014	Lemay	2002/0161634 A1	10/2002	Kaars
8,706,515 B2	4/2014	Cobbs et al.	2002/0165923 A1	11/2002	Prince
8,713,463 B2	4/2014	Kim et al.	2002/0186251 A1	12/2002	Himmel et al.
8,726,190 B2	5/2014	Clark et al.	2002/0191028 A1	12/2002	Senecalle et al.
8,769,427 B2	7/2014	Raman et al.	2002/0194385 A1	12/2002	Linder et al.
8,769,431 B1	7/2014	Prasad	2003/0003899 A1	1/2003	Tashiro et al.
8,826,181 B2	9/2014	Mouilleseaux et al.	2003/0008686 A1	1/2003	Park et al.
8,830,270 B2	9/2014	Zaman et al.	2003/0011643 A1	1/2003	Nishihata
8,836,648 B2	9/2014	Wilairat	2003/0020671 A1	1/2003	Santoro et al.
8,893,033 B2	11/2014	Donahue et al.	2003/0040300 A1	2/2003	Bodie
8,910,081 B2	12/2014	Fennel	2003/0046396 A1	3/2003	Richter et al.
8,922,575 B2	12/2014	Garside et al.	2003/0052900 A1	3/2003	Card et al.
8,924,885 B2	12/2014	LeVee et al.	2003/0073414 A1	4/2003	Capps
8,933,952 B2	1/2015	Zaman et al.	2003/0096604 A1	5/2003	Vollandt
8,935,631 B2	1/2015	Leonard et al.	2003/0098858 A1	5/2003	Perski et al.
8,990,733 B2	3/2015	Deutsch et al.	2003/0105827 A1	6/2003	Tan et al.
			2003/0107604 A1 *	6/2003	Ording G06F 3/0486 715/788
			2003/0135582 A1	7/2003	Allen et al.

(56)

References Cited

U.S. PATENT DOCUMENTS

2003/0179541	A1	9/2003	Sullivan	2005/0250547	A1	11/2005	Salman et al.
2003/0187996	A1	10/2003	Cardina et al.	2005/0268237	A1	12/2005	Crane et al.
2003/0222907	A1	12/2003	Heikes et al.	2005/0273614	A1	12/2005	Ahuja
2003/0225846	A1	12/2003	Heikes et al.	2005/0280719	A1	12/2005	Kim
2003/0231219	A1	12/2003	Leung	2006/0001650	A1	1/2006	Robbins et al.
2003/0231327	A1	12/2003	Ashey et al.	2006/0004685	A1	1/2006	Pyhalammi et al.
2004/0066414	A1	4/2004	Czerwinski et al.	2006/0010371	A1	1/2006	Shur et al.
2004/0066418	A1	4/2004	Tosey	2006/0010394	A1	1/2006	Chaudhri et al.
2004/0068543	A1	4/2004	Seifert	2006/0012580	A1	1/2006	Perski et al.
2004/0078299	A1	4/2004	Down-Logan	2006/0015562	A1	1/2006	Kilian-Kehr et al.
2004/0095395	A1	5/2004	Kurtenbach	2006/0015736	A1	1/2006	Callas et al.
2004/0111673	A1	6/2004	Bowman et al.	2006/0015812	A1	1/2006	Cunningham
2004/0128359	A1	7/2004	Horvitz et al.	2006/0015820	A1	1/2006	Wood
2004/0155908	A1	8/2004	Wagner	2006/0022955	A1	2/2006	Kennedy
2004/0174396	A1	9/2004	Jobs et al.	2006/0026013	A1	2/2006	Kraft
2004/0185883	A1	9/2004	Rukman	2006/0026521	A1	2/2006	Hotelling et al.
2004/0189707	A1	9/2004	Moore et al.	2006/0026535	A1	2/2006	Hotelling et al.
2004/0212586	A1	10/2004	Denny	2006/0026536	A1	2/2006	Hotelling et al.
2004/0212605	A1	10/2004	Fitzmaurice et al.	2006/0031786	A1	2/2006	Hillis et al.
2004/0212617	A1	10/2004	Fitzmaurice et al.	2006/0036425	A1	2/2006	Le Cocq et al.
2004/0217954	A1	11/2004	O’Gorman et al.	2006/0048073	A1	3/2006	Jarrett et al.
2004/0217980	A1	11/2004	Radburn et al.	2006/0048101	A1	3/2006	Krassovsky et al.
2004/0236774	A1	11/2004	Baird et al.	2006/0055670	A1	3/2006	Castrucci
2004/0237048	A1	11/2004	Tojo et al.	2006/0059430	A1	3/2006	Bells
2004/0250217	A1	12/2004	Tojo et al.	2006/0061597	A1	3/2006	Hui
2004/0255254	A1	12/2004	Weingart et al.	2006/0070005	A1	3/2006	Gilbert et al.
2004/0266491	A1	12/2004	Howard et al.	2006/0074735	A1	4/2006	Shukla et al.
2005/0005241	A1	1/2005	Hunleth et al.	2006/0074771	A1	4/2006	Kim
2005/0012723	A1	1/2005	Pallakoff	2006/0075360	A1	4/2006	Bixler
2005/0028208	A1	2/2005	Ellis	2006/0092177	A1	5/2006	Blasko
2005/0044058	A1	2/2005	Matthews et al.	2006/0093219	A1	5/2006	Gounares et al.
2005/0050462	A1	3/2005	Whittle et al.	2006/0101354	A1	5/2006	Hashimoto et al.
2005/0054384	A1	3/2005	Pasquale et al.	2006/0103623	A1	5/2006	Davis
2005/0058353	A1	3/2005	Matsubara	2006/0107231	A1	5/2006	Matthews et al.
2005/0060647	A1	3/2005	Doan et al.	2006/0112335	A1	5/2006	Hofmeister et al.
2005/0060658	A1	3/2005	Tsukiori	2006/0112354	A1	5/2006	Park et al.
2005/0060663	A1	3/2005	Arkeketa et al.	2006/0114239	A1	6/2006	Nakajima
2005/0060665	A1	3/2005	Rekimoto	2006/0129543	A1	6/2006	Bates et al.
2005/0079896	A1	4/2005	Kokko et al.	2006/0135220	A1	6/2006	Kim et al.
2005/0081155	A1	4/2005	Martin et al.	2006/0136773	A1	6/2006	Kespohl et al.
2005/0085215	A1	4/2005	Kokko	2006/0152803	A1	7/2006	Provitola
2005/0085272	A1	4/2005	Anderson et al.	2006/0155728	A1	7/2006	Bosarge
2005/0091612	A1	4/2005	Stabb et al.	2006/0156228	A1	7/2006	Gallo et al.
2005/0093868	A1	5/2005	Hinckley	2006/0156247	A1	7/2006	McCormack et al.
2005/0101864	A1	5/2005	Zheng et al.	2006/0161863	A1	7/2006	Gallo
2005/0108655	A1	5/2005	Andrea et al.	2006/0161870	A1	7/2006	Hotelling et al.
2005/0114778	A1	5/2005	Branson et al.	2006/0172724	A1	8/2006	Linkert et al.
2005/0114788	A1	5/2005	Fabritius	2006/0173911	A1	8/2006	Levin et al.
2005/0120306	A1	6/2005	Klassen et al.	2006/0176403	A1	8/2006	Gritton et al.
2005/0125736	A1	6/2005	Ferri et al.	2006/0184901	A1	8/2006	Dietz
2005/0125739	A1	6/2005	Thompson et al.	2006/0184966	A1	8/2006	Hunleth et al.
2005/0129314	A1	6/2005	Chen	2006/0190833	A1	8/2006	SanGiovanni et al.
2005/0136953	A1	6/2005	Jo	2006/0197750	A1	9/2006	Kerr et al.
2005/0143138	A1	6/2005	Lee et al.	2006/0199598	A1	9/2006	Lee et al.
2005/0149879	A1	7/2005	Jobs et al.	2006/0209016	A1	9/2006	Fox et al.
2005/0156947	A1	7/2005	Sakai et al.	2006/0212806	A1	9/2006	Griffin et al.
2005/0182798	A1	8/2005	Todd et al.	2006/0218234	A1	9/2006	Deng et al.
2005/0183021	A1	8/2005	Allen et al.	2006/0218500	A1	9/2006	Sauve et al.
2005/0183030	A1*	8/2005	Bertram G06F 3/0483 715/800	2006/0218501	A1	9/2006	Wilson et al.
2005/0184973	A1	8/2005	Lum et al.	2006/0224993	A1	10/2006	Wong et al.
2005/0184999	A1	8/2005	Daioku	2006/0227153	A1*	10/2006	Anwar G06T 3/0012 345/660
2005/0188406	A1	8/2005	Gielow et al.	2006/0232551	A1	10/2006	Matta
2005/0198159	A1	9/2005	Kirsch	2006/0236264	A1	10/2006	Cain et al.
2005/0198584	A1	9/2005	Matthews et al.	2006/0238517	A1	10/2006	King et al.
2005/0198586	A1	9/2005	Sekiguchi et al.	2006/0238520	A1	10/2006	Westerman et al.
2005/0198592	A1	9/2005	Keely, Jr. et al.	2006/0246955	A1	11/2006	Nirhamo
2005/0200762	A1	9/2005	Barletta et al.	2006/0248471	A1	11/2006	Lindsay et al.
2005/0207734	A1	9/2005	Howell et al.	2006/0253685	A1	11/2006	Wong et al.
2005/0216300	A1	9/2005	Appelman et al.	2006/0253801	A1	11/2006	Okaro et al.
2005/0223057	A1	10/2005	Buchheit et al.	2006/0259870	A1	11/2006	Hewitt et al.
2005/0223069	A1	10/2005	Cooperman et al.	2006/0259873	A1	11/2006	Mister
2005/0232166	A1	10/2005	Nierhaus	2006/0262134	A1	11/2006	Hamiter et al.
2005/0235220	A1*	10/2005	Duperrouzel G06F 17/30899 715/788	2006/0262188	A1	11/2006	Elyada et al.
				2006/0268013	A1	11/2006	Miles
				2006/0268100	A1	11/2006	Karukka et al.
				2006/0271520	A1	11/2006	Ragan
				2006/0281448	A1	12/2006	Plestid et al.
				2006/0284852	A1	12/2006	Hofmeister et al.

(56)

References Cited

U.S. PATENT DOCUMENTS

2006/0288280	A1*	12/2006	Makela	G06F 16/955 715/205	2007/0233654	A1	10/2007	Karlson
2006/0293088	A1	12/2006	Kokubo		2007/0236468	A1	10/2007	Tuli
2006/0294063	A1	12/2006	Ali et al.		2007/0238487	A1	10/2007	Kuhl et al.
2006/0294396	A1	12/2006	Witman		2007/0238488	A1	10/2007	Scott
2007/0005716	A1	1/2007	LaVasseur et al.		2007/0242056	A1	10/2007	Engelhardt et al.
2007/0006094	A1	1/2007	Canfield et al.		2007/0247435	A1	10/2007	Benko et al.
2007/0011610	A1	1/2007	Sethi et al.		2007/0250583	A1	10/2007	Hardy
2007/0015532	A1	1/2007	Deelman		2007/0250787	A1	10/2007	Kawahara et al.
2007/0016609	A1	1/2007	Kim et al.		2007/0253758	A1	11/2007	Suess
2007/0024646	A1	2/2007	Saarinen		2007/0256029	A1	11/2007	Maxwell
2007/0028267	A1	2/2007	Ostojic et al.		2007/0257891	A1	11/2007	Esenther et al.
2007/0035513	A1	2/2007	Sherrard et al.		2007/0257933	A1	11/2007	Klassen
2007/0038567	A1	2/2007	Allaire et al.		2007/0260674	A1	11/2007	Shenfield
2007/0044039	A1	2/2007	Amadio et al.		2007/0262964	A1	11/2007	Zotov et al.
2007/0050724	A1	3/2007	Lee et al.		2007/0263843	A1	11/2007	Foxenland
2007/0054679	A1	3/2007	Cho et al.		2007/0266342	A1	11/2007	Chang et al.
2007/0055770	A1	3/2007	Karmakar et al.		2007/0273663	A1	11/2007	Park et al.
2007/0061488	A1	3/2007	Alagappan et al.		2007/0273668	A1	11/2007	Park et al.
2007/0061511	A1	3/2007	Faber		2007/0280457	A1	12/2007	Aberethy
2007/0061714	A1	3/2007	Stuple et al.		2007/0281747	A1	12/2007	Pletikosa
2007/0063995	A1	3/2007	Bailey et al.		2007/0288860	A1	12/2007	Ording et al.
2007/0067272	A1	3/2007	Flynt		2007/0291007	A1	12/2007	Forlines et al.
2007/0067737	A1	3/2007	Zielinski et al.		2008/0001924	A1	1/2008	de los Reyes et al.
2007/0067738	A1	3/2007	Flynt et al.		2008/0005668	A1	1/2008	Mavinkurve
2007/0067798	A1	3/2007	Wroblewski		2008/0005703	A1	1/2008	Radivojevic et al.
2007/0073718	A1	3/2007	Ramer		2008/0028294	A1	1/2008	Sell et al.
2007/0075976	A1	4/2007	Kun et al.		2008/0032681	A1	2/2008	West
2007/0076013	A1	4/2007	Campbell		2008/0034318	A1	2/2008	Louch et al.
2007/0080954	A1	4/2007	Griffin		2008/0036743	A1	2/2008	Westerman et al.
2007/0082707	A1	4/2007	Flynt et al.		2008/0040692	A1	2/2008	Sunday et al.
2007/0082708	A1	4/2007	Griffin		2008/0042978	A1	2/2008	Perez-Noguera
2007/0083501	A1	4/2007	Pedersen et al.		2008/0048986	A1	2/2008	Khoo
2007/0083746	A1	4/2007	Fallon et al.		2008/0052370	A1	2/2008	Snyder
2007/0083821	A1	4/2007	Garbow et al.		2008/0052637	A1	2/2008	Ben-Yoseph et al.
2007/0094045	A1	4/2007	Cobbs et al.		2008/0052945	A1	3/2008	Matas et al.
2007/0097096	A1	5/2007	Rosenberg		2008/0057910	A1	3/2008	Thoresson et al.
2007/0103452	A1	5/2007	Wakai et al.		2008/0057926	A1	3/2008	Forstall et al.
2007/0106635	A1	5/2007	Frieden et al.		2008/0062141	A1	3/2008	Chandhri
2007/0106939	A1	5/2007	Qassoudi		2008/0065607	A1	3/2008	Weber
2007/0120762	A1	5/2007	O'Gorman		2008/0065720	A1	3/2008	Brodersen et al.
2007/0120835	A1	5/2007	Sato		2008/0072173	A1	3/2008	Brunner et al.
2007/0127638	A1	6/2007	Doulton		2008/0076472	A1	3/2008	Hyatt
2007/0136677	A1	6/2007	Agarwal		2008/0082903	A1	4/2008	McCurdy et al.
2007/0140566	A1	6/2007	Lin et al.		2008/0082911	A1	4/2008	Sorotokin et al.
2007/0143705	A1	6/2007	Peters		2008/0082934	A1	4/2008	Kocienda et al.
2007/0152961	A1	7/2007	Dunton et al.		2008/0084400	A1	4/2008	Rosenberg
2007/0157089	A1	7/2007	Van Os et al.		2008/0085700	A1	4/2008	Arora
2007/0157105	A1	7/2007	Owens et al.		2008/0092054	A1	4/2008	Bhumkar et al.
2007/0168890	A1	7/2007	Zhao et al.		2008/0094368	A1	4/2008	Ording et al.
2007/0171192	A1	7/2007	Seo et al.		2008/0095100	A1	4/2008	Cleveland et al.
2007/0180381	A1	8/2007	Rice		2008/0098093	A1	4/2008	Simon et al.
2007/0180401	A1	8/2007	Singh et al.		2008/0102863	A1	5/2008	Hardy
2007/0180448	A1	8/2007	Low et al.		2008/0104544	A1	5/2008	Collins et al.
2007/0182595	A1	8/2007	Ghasabian		2008/0107057	A1	5/2008	Kannan et al.
2007/0182999	A1	8/2007	Anthony et al.		2008/0109753	A1	5/2008	Karstens
2007/0185847	A1	8/2007	Budzik et al.		2008/0113656	A1	5/2008	Lee et al.
2007/0192707	A1	8/2007	Maeda et al.		2008/0114535	A1	5/2008	Nesbitt
2007/0192726	A1	8/2007	Kim et al.		2008/0122796	A1	5/2008	Jobs
2007/0192730	A1	8/2007	Simila et al.		2008/0126441	A1	5/2008	Giampaolo et al.
2007/0192733	A1	8/2007	Horiuchi		2008/0132252	A1	6/2008	Altman et al.
2007/0192739	A1	8/2007	Hunleth et al.		2008/0138030	A1	6/2008	Bryan et al.
2007/0197196	A1	8/2007	Shenfield et al.		2008/0141153	A1	6/2008	Samson et al.
2007/0198420	A1	8/2007	Goldstein		2008/0153551	A1	6/2008	Baek et al.
2007/0208840	A1	9/2007	Mcconville et al.		2008/0155425	A1	6/2008	Murthy et al.
2007/0211034	A1	9/2007	Griffin et al.		2008/0158189	A1	7/2008	Kim
2007/0214429	A1	9/2007	Lyudovyk et al.		2008/0162651	A1	7/2008	Madnani
2007/0214431	A1*	9/2007	Amadio	G06F 9/451 715/788	2008/0163104	A1	7/2008	Haug
2007/0214454	A1	9/2007	Edwards et al.		2008/0164982	A1	7/2008	Andrews et al.
2007/0216651	A1	9/2007	Patel		2008/0165132	A1	7/2008	Weiss
2007/0216661	A1	9/2007	Chen et al.		2008/0165136	A1	7/2008	Christie et al.
2007/0220444	A1	9/2007	Sunday et al.		2008/0165141	A1	7/2008	Christie
2007/0222769	A1	9/2007	Otsuka et al.		2008/0165163	A1	7/2008	Bathiche
2007/0225022	A1	9/2007	Satake		2008/0165210	A1	7/2008	Platzer et al.
					2008/0165255	A1	7/2008	Christie et al.
					2008/0167058	A1	7/2008	Lee et al.
					2008/0168349	A1	7/2008	Lamiriaux et al.
					2008/0168379	A1	7/2008	Forstall et al.
					2008/0168382	A1	7/2008	Louch et al.
					2008/0168396	A1	7/2008	Matas et al.

(56)

References Cited

- U.S. PATENT DOCUMENTS
- 2008/0168402 A1 7/2008 Blumenberg
 2008/0168403 A1 7/2008 Westerman et al.
 2008/0172609 A1 7/2008 Rytivaara
 2008/0174570 A1 7/2008 Jobs et al.
 2008/0178125 A1 7/2008 Elsbree
 2008/0180399 A1 7/2008 Cheng
 2008/0182628 A1 7/2008 Lee et al.
 2008/0184112 A1 7/2008 Chiang et al.
 2008/0189653 A1 8/2008 Taylor et al.
 2008/0189658 A1 8/2008 Jeong et al.
 2008/0192056 A1 8/2008 Robertson et al.
 2008/0198141 A1 8/2008 Lee et al.
 2008/0200142 A1 8/2008 Abdel-Kader et al.
 2008/0208973 A1 8/2008 Hayashi
 2008/0211766 A1 9/2008 Westerman et al.
 2008/0211778 A1 9/2008 Ording et al.
 2008/0215475 A1 9/2008 Ramer et al.
 2008/0222273 A1 9/2008 Lakshmanan
 2008/0222545 A1 9/2008 Lemay et al.
 2008/0222547 A1 9/2008 Wong et al.
 2008/0222560 A1 9/2008 Harrison
 2008/0222569 A1 9/2008 Champion
 2008/0225014 A1 9/2008 Kim
 2008/0229192 A1 9/2008 Gear et al.
 2008/0229217 A1 9/2008 Kembel et al.
 2008/0238941 A1 10/2008 Kinnan
 2008/0242277 A1 10/2008 Chen et al.
 2008/0242362 A1 10/2008 Duarte
 2008/0249682 A1 10/2008 Wisniewski et al.
 2008/0250354 A1 10/2008 Park
 2008/0256471 A1 10/2008 Okamoto
 2008/0259042 A1 10/2008 Thorn
 2008/0261513 A1 10/2008 Shin et al.
 2008/0261660 A1 10/2008 Huh et al.
 2008/0263457 A1 10/2008 Kim et al.
 2008/0270558 A1 10/2008 Ma
 2008/0275956 A1 11/2008 Saxena
 2008/0278455 A1 11/2008 Atkins et al.
 2008/0284798 A1 11/2008 Weybrew et al.
 2008/0288606 A1 11/2008 Kasai et al.
 2008/0297475 A1 12/2008 Woolf et al.
 2008/0299999 A1 12/2008 Lockhart et al.
 2008/0301046 A1 12/2008 Martinez
 2008/0301575 A1 12/2008 Fermon
 2008/0303798 A1 12/2008 Matsudate et al.
 2008/0307351 A1 12/2008 Louch et al.
 2008/0309626 A1 12/2008 Westerman et al.
 2008/0313538 A1 12/2008 Hudson
 2008/0313540 A1 12/2008 Dirks et al.
 2008/0316177 A1 12/2008 Tseng
 2008/0317240 A1 12/2008 Chang et al.
 2008/0320413 A1 12/2008 Oshiro
 2009/0007004 A1 1/2009 Holecek et al.
 2009/0007009 A1 1/2009 Luneau et al.
 2009/0007017 A1 1/2009 Anzures et al.
 2009/0012952 A1 1/2009 Fredriksson
 2009/0029736 A1 1/2009 Kim et al.
 2009/0031243 A1 1/2009 Kano et al.
 2009/0031247 A1 1/2009 Walter et al.
 2009/0033632 A1 2/2009 Szolyga et al.
 2009/0037469 A1 2/2009 Kirsch
 2009/0037846 A1 2/2009 Spalink et al.
 2009/0051671 A1 2/2009 Konstas
 2009/0054107 A1 2/2009 Feland, III et al.
 2009/0055749 A1 2/2009 Chatterjee et al.
 2009/0058821 A1 3/2009 Chaudhri
 2009/0058830 A1 3/2009 Herz
 2009/0059730 A1 3/2009 Lyons et al.
 2009/0061837 A1 3/2009 Chaudhri et al.
 2009/0061948 A1 3/2009 Lee et al.
 2009/0064055 A1 3/2009 Chaudhri
 2009/0070673 A1 3/2009 Barkan et al.
 2009/0077501 A1 3/2009 Partridge et al.
 2009/0077649 A1 3/2009 Lockhart
 2009/0079699 A1 3/2009 Sun
 2009/0079740 A1 3/2009 Fitzmaurice et al.
 2009/0083656 A1 3/2009 Dokhon
 2009/0085851 A1 4/2009 Lim
 2009/0085878 A1 4/2009 Heubel et al.
 2009/0085886 A1 4/2009 Huang et al.
 2009/0089215 A1 4/2009 Newton
 2009/0089459 A1 4/2009 Jeyaseelan et al.
 2009/0089704 A1 4/2009 Makela
 2009/0094562 A1 4/2009 Jeong et al.
 2009/0096758 A1 4/2009 Hotelling et al.
 2009/0103515 A1 4/2009 Pointer
 2009/0106696 A1 4/2009 Duarte
 2009/0109243 A1 4/2009 Kraft
 2009/0117942 A1 5/2009 Boningue et al.
 2009/0117943 A1 5/2009 Lee et al.
 2009/0119578 A1 5/2009 Relyea et al.
 2009/0125844 A1 5/2009 Weir et al.
 2009/0128505 A1 5/2009 Partridge et al.
 2009/0132942 A1 5/2009 Santoro et al.
 2009/0138830 A1 5/2009 Borgaonkar et al.
 2009/0140061 A1 6/2009 Schultz et al.
 2009/0140986 A1 6/2009 Karkkainen et al.
 2009/0143141 A1 6/2009 Wells et al.
 2009/0144376 A1 6/2009 Moscatelli et al.
 2009/0144642 A1 6/2009 Crystal
 2009/0144652 A1 6/2009 Wiley
 2009/0144653 A1 6/2009 Ubillos
 2009/0144753 A1 6/2009 Morris
 2009/0146962 A1 6/2009 Ahonen et al.
 2009/0150618 A1 6/2009 Allen, Jr. et al.
 2009/0153438 A1 6/2009 Miller et al.
 2009/0153492 A1 6/2009 Popp
 2009/0158144 A1 6/2009 Griffin
 2009/0160809 A1 6/2009 Yang
 2009/0163182 A1 6/2009 Gatti et al.
 2009/0164888 A1 6/2009 Phan
 2009/0164928 A1 6/2009 Brown et al.
 2009/0164936 A1 6/2009 Kawaguchi
 2009/0167696 A1 7/2009 Griffin
 2009/0171920 A1 7/2009 Wade et al.
 2009/0172103 A1 7/2009 Tuli
 2009/0174679 A1 7/2009 Westerman
 2009/0178007 A1 7/2009 Matas et al.
 2009/0182788 A1 7/2009 Chung et al.
 2009/0183077 A1 7/2009 Hakim et al.
 2009/0183107 A1 7/2009 Matthews et al.
 2009/0184939 A1 7/2009 Wohlstadter et al.
 2009/0187842 A1 7/2009 Collins et al.
 2009/0187860 A1 7/2009 Fleck et al.
 2009/0189868 A1 7/2009 Joo et al.
 2009/0192942 A1 7/2009 Cottrille et al.
 2009/0193358 A1 7/2009 Mernyk et al.
 2009/0193364 A1 7/2009 Jarrett et al.
 2009/0193366 A1 7/2009 Davidson
 2009/0199122 A1 8/2009 Deutsch et al.
 2009/0199128 A1 8/2009 Matthews et al.
 2009/0199130 A1 8/2009 Tsern et al.
 2009/0205041 A1 8/2009 Michalske
 2009/0215504 A1 8/2009 Lando
 2009/0225038 A1 9/2009 Bolsinga et al.
 2009/0228825 A1 9/2009 Van Os et al.
 2009/0228841 A1 9/2009 Hildreth
 2009/0235200 A1 9/2009 Deutsch et al.
 2009/0235203 A1 9/2009 Iizuka
 2009/0248421 A1 10/2009 Michaelis et al.
 2009/0249236 A1 10/2009 Westerman et al.
 2009/0249247 A1 10/2009 Tseng et al.
 2009/0249257 A1 10/2009 Bove et al.
 2009/0251432 A1 10/2009 Wang et al.
 2009/0254846 A1 10/2009 Vaidyanathan et al.
 2009/0265662 A1 10/2009 Bamford
 2009/0271735 A1 10/2009 Anderson et al.
 2009/0271778 A1 10/2009 Mandyam et al.
 2009/0276701 A1 11/2009 Nurmi
 2009/0278812 A1 11/2009 Yasutake
 2009/0282332 A1 11/2009 Porat
 2009/0284478 A1 11/2009 De la Torre Baltierra et al.
 2009/0284482 A1 11/2009 Chin
 2009/0284657 A1 11/2009 Roberts et al.

(56)

References Cited

U.S. PATENT DOCUMENTS

2009/0288044	A1	11/2009	Matthews et al.	2010/0106915	A1	4/2010	Krishnaprasad et al.
2009/0289902	A1	11/2009	Carlvik et al.	2010/0107067	A1	4/2010	Vaisanen
2009/0292989	A1	11/2009	Matthews et al.	2010/0107068	A1	4/2010	Butcher
2009/0293007	A1	11/2009	Duarte et al.	2010/0107100	A1	4/2010	Schneekloth
2009/0293013	A1	11/2009	O'Shaugnessy et al.	2010/0115455	A1	5/2010	Kim
2009/0295753	A1	12/2009	King et al.	2010/0121705	A1	5/2010	Ramer et al.
2009/0298547	A1	12/2009	Kim et al.	2010/0122110	A1	5/2010	Ordogh
2009/0303231	A1	12/2009	Robinet et al.	2010/0122208	A1	5/2010	Herr et al.
2009/0305732	A1	12/2009	Marcellino et al.	2010/0123737	A1	5/2010	Williamson et al.
2009/0307105	A1	12/2009	Lemay et al.	2010/0134415	A1	6/2010	Iwase et al.
2009/0307589	A1	12/2009	Inose et al.	2010/0137027	A1	6/2010	Kim
2009/0307623	A1	12/2009	Agarawala et al.	2010/0138767	A1	6/2010	Wang et al.
2009/0307682	A1	12/2009	Gharabally et al.	2010/0145675	A1	6/2010	Lloyd et al.
2009/0309846	A1	12/2009	Trachtenberg et al.	2010/0146384	A1	6/2010	Peev et al.
2009/0313584	A1	12/2009	Kerr et al.	2010/0146431	A1	6/2010	Raji et al.
2009/0315839	A1	12/2009	Wilson et al.	2010/0146437	A1	6/2010	Woodcock et al.
2009/0315847	A1	12/2009	Fujii	2010/0157157	A1	6/2010	Yi
2009/0320070	A1	12/2009	Inoguchi	2010/0159966	A1	6/2010	Friedman
2009/0322760	A1	12/2009	Kwiatkowski et al.	2010/0159994	A1	6/2010	Stallings et al.
2009/0327953	A1	12/2009	Honkala et al.	2010/0159995	A1	6/2010	Stallings et al.
2009/0327969	A1	12/2009	Estrada	2010/0162180	A1	6/2010	Dunnam et al.
2009/0327975	A1	12/2009	Stedman	2010/0164878	A1	7/2010	Bestle et al.
2010/0008490	A1	1/2010	Gharachorloo et al.	2010/0164959	A1	7/2010	Brown et al.
2010/0010934	A1	1/2010	Barry et al.	2010/0167699	A1	7/2010	Sigmund et al.
2010/0013768	A1	1/2010	Leung	2010/0169766	A1	7/2010	Duarte et al.
2010/0013782	A1	1/2010	Liu et al.	2010/0169772	A1	7/2010	Stallings et al.
2010/0016049	A1	1/2010	Shirakawa et al.	2010/0169819	A1	7/2010	Bestle et al.
2010/0020025	A1	1/2010	Lemort et al.	2010/0175018	A1	7/2010	Petschnigg et al.
2010/0020091	A1	1/2010	Rasmussen et al.	2010/0175029	A1	7/2010	Williams
2010/0030578	A1	2/2010	Siddique et al.	2010/0180233	A1	7/2010	Kruzeniski
2010/0031186	A1	2/2010	Tseng	2010/0185932	A1	7/2010	Coffman et al.
2010/0042911	A1	2/2010	Wormaid et al.	2010/0185989	A1	7/2010	Shiplacoff et al.
2010/0045705	A1	2/2010	Vertegaal et al.	2010/0188328	A1	7/2010	Dodge et al.
2010/0050076	A1	2/2010	Roth	2010/0188371	A1	7/2010	Lowles et al.
2010/0053861	A1	3/2010	Kim et al.	2010/0192102	A1	7/2010	Chmielewski et al.
2010/0057566	A1	3/2010	Itzhak	2010/0201634	A1	8/2010	Coddington
2010/0058226	A1	3/2010	Flake et al.	2010/0213040	A1	8/2010	Yeh et al.
2010/0058248	A1	3/2010	Park	2010/0216491	A1	8/2010	Winkler et al.
2010/0062811	A1	3/2010	Park et al.	2010/0217428	A1	8/2010	Strong et al.
2010/0064261	A1	3/2010	Andrews et al.	2010/0223569	A1	9/2010	Vuong et al.
2010/0066667	A1	3/2010	MacDougall et al.	2010/0223627	A1	9/2010	Sharma
2010/0066698	A1*	3/2010	Seo G06F 3/04883 345/173	2010/0235736	A1	9/2010	Fleisher et al.
2010/0070931	A1	3/2010	Nichols	2010/0241973	A1	9/2010	Whiddett
2010/0073160	A1	3/2010	Gilmour et al.	2010/0245263	A1	9/2010	Parada, Jr. et al.
2010/0073380	A1	3/2010	Kaplan et al.	2010/0248688	A1	9/2010	Teng
2010/0075628	A1	3/2010	Ye	2010/0248689	A1	9/2010	Teng
2010/0077058	A1	3/2010	Messer	2010/0248741	A1	9/2010	Setlur et al.
2010/0077310	A1	3/2010	Karachale et al.	2010/0248787	A1	9/2010	Smuga et al.
2010/0077330	A1	3/2010	Kaplan et al.	2010/0248788	A1	9/2010	Yook et al.
2010/0079392	A1	4/2010	Chiang et al.	2010/0251153	A1	9/2010	SanGiovanni et al.
2010/0079413	A1	4/2010	Kawashima et al.	2010/0251167	A1	9/2010	DeLuca et al.
2010/0081475	A1	4/2010	Chiang et al.	2010/0251189	A1	9/2010	Jaeger
2010/0083190	A1	4/2010	Roberts et al.	2010/0259493	A1	10/2010	Chang et al.
2010/0086022	A1	4/2010	Hunleth et al.	2010/0262928	A1	10/2010	Abbott
2010/0087169	A1	4/2010	Lin	2010/0265196	A1	10/2010	Lee et al.
2010/0087173	A1	4/2010	Lin	2010/0281402	A1	11/2010	Staikos et al.
2010/0088634	A1	4/2010	Tsuruta et al.	2010/0281409	A1	11/2010	Rainisto et al.
2010/0088635	A1	4/2010	Louch	2010/0281481	A1	11/2010	Rainisto et al.
2010/0088641	A1	4/2010	Choi	2010/0283743	A1	11/2010	Coddington et al.
2010/0090971	A1	4/2010	Choi et al.	2010/0283748	A1	11/2010	Hsieh et al.
2010/0095240	A1	4/2010	Shiplacoff et al.	2010/0289806	A1	11/2010	Lao et al.
2010/0097338	A1	4/2010	Miyashita et al.	2010/0293056	A1	11/2010	Flynt et al.
2010/0100839	A1	4/2010	Tseng et al.	2010/0293501	A1	11/2010	Russ et al.
2010/0102998	A1	4/2010	Fux	2010/0295789	A1	11/2010	Shin et al.
2010/0103118	A1	4/2010	Townsend et al.	2010/0295795	A1	11/2010	Wilairat
2010/0103124	A1	4/2010	Kruzeniski	2010/0298034	A1	11/2010	Shin et al.
2010/0105370	A1	4/2010	Kruzeniski	2010/0302172	A1	12/2010	Wilairat
2010/0105424	A1	4/2010	Smuga	2010/0302176	A1	12/2010	Nikula et al.
2010/0105438	A1	4/2010	Wykes	2010/0302278	A1	12/2010	Shaffer et al.
2010/0105439	A1	4/2010	Friedman et al.	2010/0302712	A1	12/2010	Zednicek et al.
2010/0105440	A1	4/2010	Kruzeniski	2010/0306702	A1	12/2010	Warner
2010/0105441	A1	4/2010	Voss	2010/0309148	A1	12/2010	Fleizach et al.
2010/0105443	A1	4/2010	Vaisanen	2010/0311470	A1	12/2010	Seo et al.
2010/0106607	A1	4/2010	Riddiford et al.	2010/0313124	A1	12/2010	Privault et al.
				2010/0313165	A1	12/2010	Louch et al.
				2010/0318745	A1	12/2010	Wheeler et al.
				2010/0321403	A1	12/2010	Inadome
				2010/0328431	A1	12/2010	Kim et al.
				2010/0329642	A1	12/2010	Kam et al.

(56)

References Cited

U.S. PATENT DOCUMENTS

2010/0333008 A1	12/2010	Taylor	2011/0205163 A1	8/2011	Hinckley
2011/0004839 A1	1/2011	Cha et al.	2011/0209039 A1	8/2011	Hinckley et al.
2011/0004845 A1	1/2011	Ciabarra	2011/0209057 A1	8/2011	Hinckley
2011/0018806 A1	1/2011	Yano	2011/0209058 A1	8/2011	Hinckley
2011/0018821 A1	1/2011	Kii	2011/0209088 A1	8/2011	Hinckley
2011/0029598 A1	2/2011	Arnold et al.	2011/0209089 A1	8/2011	Hinckley et al.
2011/0029904 A1	2/2011	Smith et al.	2011/0209093 A1	8/2011	Hinckley
2011/0029927 A1	2/2011	Lietzke et al.	2011/0209097 A1	8/2011	Hinckley
2011/0029934 A1	2/2011	Locker et al.	2011/0209098 A1	8/2011	Hinckley et al.
2011/0032365 A1	2/2011	Yett	2011/0209099 A1	8/2011	Hinckley
2011/0035702 A1	2/2011	Williams et al.	2011/0209100 A1	8/2011	Hinckley et al.
2011/0041096 A1	2/2011	Larco et al.	2011/0209101 A1	8/2011	Hinckley et al.
2011/0043527 A1	2/2011	Ording et al.	2011/0209102 A1	8/2011	Hinckley et al.
2011/0050594 A1	3/2011	Kim et al.	2011/0209103 A1	8/2011	Hinckley et al.
2011/0055729 A1	3/2011	Mason et al.	2011/0209104 A1	8/2011	Hinckley et al.
2011/0055753 A1	3/2011	Horodezky et al.	2011/0210850 A1	9/2011	Tran
2011/0055773 A1	3/2011	Agarawala et al.	2011/0225547 A1	9/2011	Fong et al.
2011/0055775 A1	3/2011	Saito et al.	2011/0231796 A1	9/2011	Vigil
2011/0074699 A1	3/2011	Marr et al.	2011/0234522 A1	9/2011	Lin et al.
2011/0074710 A1	3/2011	Weeldreyer et al.	2011/0252346 A1	10/2011	Chaudhri
2011/0074719 A1	3/2011	Yeh et al.	2011/0252380 A1	10/2011	Chaudhri
2011/0078624 A1	3/2011	Missig et al.	2011/0252381 A1	10/2011	Chaudhri
2011/0087739 A1	4/2011	Lin	2011/0258563 A1	10/2011	Lincke
2011/0087988 A1	4/2011	Ray et al.	2011/0271182 A1	11/2011	Tsai et al.
2011/0093778 A1	4/2011	Kim et al.	2011/0273379 A1	11/2011	Chen et al.
2011/0093815 A1	4/2011	Gobeil	2011/0276864 A1	11/2011	Oules
2011/0093816 A1	4/2011	Chang et al.	2011/0279461 A1	11/2011	Hamilton et al.
2011/0093821 A1	4/2011	Wigdor et al.	2011/0280312 A1	11/2011	Gaur et al.
2011/0099512 A1 *	4/2011	Jeong G06F 3/0481 715/790	2011/0283188 A1	11/2011	Farrenkopf et al.
2011/0102464 A1	5/2011	Godavari	2011/0291964 A1	12/2011	Chambers et al.
2011/0105187 A1 *	5/2011	Dobroth G06F 3/0481 455/566	2011/0296057 A1	12/2011	Shah et al.
2011/0107220 A1	5/2011	Perlman	2011/0316884 A1	12/2011	Giambalvo et al.
2011/0107272 A1	5/2011	Aguilar	2011/0320863 A1	12/2011	Amroladze et al.
2011/0113337 A1	5/2011	Liu et al.	2011/0320978 A1	12/2011	Horodezky et al.
2011/0113486 A1	5/2011	Hunt et al.	2012/0005584 A1	1/2012	Seago et al.
2011/0115735 A1	5/2011	Lev et al.	2012/0009903 A1	1/2012	Schultz et al.
2011/0119586 A1	5/2011	Blinnikka et al.	2012/0017162 A1	1/2012	Khokhlov
2011/0119597 A1	5/2011	Yellamraju et al.	2012/0028687 A1	2/2012	Wykes
2011/0124376 A1	5/2011	Kim et al.	2012/0030616 A1	2/2012	Howes et al.
2011/0126094 A1	5/2011	Horodezky et al.	2012/0050185 A1	3/2012	Davydov et al.
2011/0126156 A1	5/2011	Krishnaraj et al.	2012/0050332 A1	3/2012	Nikara et al.
2011/0138313 A1	6/2011	Decker et al.	2012/0062604 A1	3/2012	Lobo
2011/0143769 A1	6/2011	Jones et al.	2012/0079414 A1	3/2012	Eischeid et al.
2011/0154223 A1	6/2011	Whitnah et al.	2012/0081310 A1	4/2012	Schrock et al.
2011/0154235 A1	6/2011	Min et al.	2012/0084705 A1	4/2012	Lee et al.
2011/0157027 A1	6/2011	Rissa	2012/0084710 A1	4/2012	Sirpal et al.
2011/0161845 A1	6/2011	Stallings et al.	2012/0089950 A1	4/2012	Tseng
2011/0163968 A1	7/2011	Hogan	2012/0096411 A1	4/2012	Nash
2011/0167336 A1	7/2011	Aitken et al.	2012/0102433 A1	4/2012	Falkenburg
2011/0167341 A1	7/2011	Cranfill et al.	2012/0218192 A1	4/2012	Lazaridis et al.
2011/0167342 A1	7/2011	De La Pena et al.	2012/0124469 A1	5/2012	Nakajima et al.
2011/0167403 A1	7/2011	French et al.	2012/0144331 A1 *	6/2012	Tolonen G06F 3/0484 715/769
2011/0173556 A1	7/2011	Czerwinski et al.	2012/0151397 A1	6/2012	Oberstein et al.
2011/0173568 A1	7/2011	Royal, Jr. et al.	2012/0159383 A1	6/2012	Matthews et al.
2011/0173569 A1	7/2011	Howes et al.	2012/0159395 A1	6/2012	Deutsch et al.
2011/0175821 A1	7/2011	King	2012/0159402 A1	6/2012	Nurmi et al.
2011/0175930 A1	7/2011	Hwang et al.	2012/0161791 A1	6/2012	Shaw
2011/0179020 A1	7/2011	Ozzie et al.	2012/0162266 A1	6/2012	Douglas et al.
2011/0179386 A1	7/2011	Shaffer et al.	2012/0166980 A1	6/2012	Yosef et al.
2011/0179387 A1	7/2011	Shaffer et al.	2012/0166997 A1	6/2012	Cho et al.
2011/0181524 A1	7/2011	Hinckley	2012/0167005 A1	6/2012	Matthews et al.
2011/0181617 A1	7/2011	Tsuda et al.	2012/0167008 A1	6/2012	Zaman
2011/0185299 A1	7/2011	Hinckley	2012/0167011 A1	6/2012	Zaman
2011/0185300 A1	7/2011	Hinckley et al.	2012/0169593 A1	7/2012	Mak et al.
2011/0185318 A1	7/2011	Hinckley et al.	2012/0174005 A1	7/2012	Deutsch et al.
2011/0185320 A1	7/2011	Hinckley	2012/0174029 A1	7/2012	Bastide et al.
2011/0191675 A1	8/2011	Kauranen	2012/0176322 A1	7/2012	Karmi et al.
2011/0191704 A1	8/2011	Hinckley	2012/0176401 A1	7/2012	Hayward et al.
2011/0191718 A1	8/2011	Hinckley	2012/0179992 A1	7/2012	Smuga
2011/0191719 A1	8/2011	Hinckley	2012/0180001 A1	7/2012	Griffin et al.
2011/0199386 A1	8/2011	Dharwada et al.	2012/0208593 A1 *	8/2012	Yang G06F 3/0481 455/556.1
2011/0202837 A1	8/2011	Fong	2012/0209907 A1	8/2012	Andrews et al.
2011/0202866 A1	8/2011	Huang et al.	2012/0210265 A1	8/2012	Delia et al.
			2012/0212495 A1	8/2012	Butcher
			2012/0216139 A1	8/2012	Ording et al.
			2012/0226971 A1	9/2012	Tocchini et al.
			2012/0233571 A1	9/2012	Wever et al.

(56)

References Cited

U.S. PATENT DOCUMENTS

2012/0236026 A1 9/2012 Hinckley
 2012/0236035 A1 9/2012 Kimura
 2012/0244841 A1 9/2012 Teng
 2012/0254780 A1 10/2012 Mouton et al.
 2012/0254808 A1 10/2012 Gildfind
 2012/0265644 A1 10/2012 Roa et al.
 2012/0272181 A1 10/2012 Rogers et al.
 2012/0284673 A1 11/2012 Lamb et al.
 2012/0290962 A1 11/2012 Zielinski et al.
 2012/0299968 A1 11/2012 Wong et al.
 2012/0304068 A1 11/2012 Zaman et al.
 2012/0304092 A1 11/2012 Jarrett et al.
 2012/0304107 A1 11/2012 Nan et al.
 2012/0304108 A1 11/2012 Jarrett et al.
 2012/0304113 A1 11/2012 Patten et al.
 2012/0304114 A1 11/2012 Wong et al.
 2012/0304116 A1 11/2012 Donahue et al.
 2012/0304117 A1 11/2012 Donahue et al.
 2012/0304118 A1 11/2012 Donahue et al.
 2012/0304131 A1 11/2012 Nan et al.
 2012/0304132 A1 11/2012 Sareen et al.
 2012/0304133 A1 11/2012 Nan et al.
 2012/0311436 A1 12/2012 Steele et al.
 2012/0311485 A1 12/2012 Caliendo, Jr. et al.
 2012/0323992 A1 12/2012 Brobst et al.
 2013/0007665 A1 1/2013 Chaudhri et al.
 2013/0031508 A1 1/2013 Kodosky et al.
 2013/0033525 A1 2/2013 Markiewicz
 2013/0038541 A1 2/2013 Bakker
 2013/0042203 A1 2/2013 Wong et al.
 2013/0042206 A1 2/2013 Zaman et al.
 2013/0044136 A1 2/2013 Matthews
 2013/0044141 A1 2/2013 Markiewicz
 2013/0047079 A1 2/2013 Kroeger et al.
 2013/0047105 A1 2/2013 Jarrett
 2013/0047117 A1 2/2013 Deutsch
 2013/0047126 A1 2/2013 Sareen
 2013/0057587 A1 3/2013 Leonard et al.
 2013/0057588 A1 3/2013 Leonard
 2013/0063442 A1 3/2013 Zaman
 2013/0063443 A1 3/2013 Garside
 2013/0063465 A1 3/2013 Zaman
 2013/0063490 A1 3/2013 Zaman et al.
 2013/0067381 A1 3/2013 Yalovsky
 2013/0067390 A1 3/2013 Kwiatkowski
 2013/0067391 A1 3/2013 Pittappilly
 2013/0067398 A1 3/2013 Pittappilly
 2013/0067399 A1 3/2013 Elliott
 2013/0067412 A1 3/2013 Leonard et al.
 2013/0067420 A1 3/2013 Pittappilly
 2013/0093757 A1 4/2013 Cornell
 2013/0117715 A1 5/2013 Williams et al.
 2013/0167078 A1* 6/2013 Monnig G06F 3/0484
 715/800
 2013/0169649 A1 7/2013 Bates
 2013/0176316 A1 7/2013 Bates
 2013/0179781 A1 7/2013 Nan et al.
 2013/0219332 A1 8/2013 Woley
 2013/0300684 A1 11/2013 Kim et al.
 2013/0304822 A1 11/2013 Tetreault
 2013/0305184 A1 11/2013 Kim et al.
 2014/0013271 A1 1/2014 Moore et al.
 2014/0033099 A1 1/2014 Treitman et al.
 2014/0067833 A1 3/2014 Nandi
 2014/0082552 A1 3/2014 Zaman
 2014/0089833 A1 3/2014 Hwang et al.
 2014/0089856 A1 3/2014 Matthews
 2014/0098108 A1 4/2014 Fong et al.
 2014/0109008 A1 4/2014 Zaman
 2014/0143708 A1 5/2014 Yang et al.
 2014/0164990 A1 6/2014 Kim et al.
 2014/0223381 A1 8/2014 Huang et al.
 2014/0310646 A1 10/2014 Vranjes et al.
 2015/0046829 A1 2/2015 Donahue et al.
 2015/0058763 A1 2/2015 Leonard et al.

2015/0095768 A1* 4/2015 Rimmer G06F 40/103
 715/238
 2015/0113476 A1 4/2015 Deutsch et al.
 2015/0185980 A1* 7/2015 An G06F 3/04817
 715/803
 2015/0186024 A1* 7/2015 Hong G06F 3/04886
 715/800
 2015/0186376 A1 7/2015 Garside et al.
 2015/0193403 A1 7/2015 Zaman et al.
 2015/0199075 A1 7/2015 Kuscher et al.
 2015/0317026 A1 11/2015 Choi et al.
 2015/0317062 A1 11/2015 Jarrett et al.
 2015/0325211 A1 11/2015 Lee et al.
 2015/0378554 A1 12/2015 Jan et al.
 2015/0378594 A1 12/2015 Zaman et al.
 2016/0041710 A1 2/2016 Zaman et al.
 2016/0041711 A1 2/2016 Zaman et al.
 2016/0041730 A1 2/2016 Zaman et al.
 2016/0070357 A1 3/2016 Nguyen
 2016/0110090 A1 4/2016 Patten et al.
 2017/0315705 A1 11/2017 Zaman et al.
 2017/0371517 A1 12/2017 Nan et al.

FOREIGN PATENT DOCUMENTS

CN 1591305 3/2005
 CN 1591398 3/2005
 CN 1734440 2/2006
 CN 1766824 5/2006
 CN 1845054 10/2006
 CN 1902575 1/2007
 CN 1904823 1/2007
 CN 1930568 3/2007
 CN 101006425 7/2007
 CN 101036104 9/2007
 CN 101114303 1/2008
 CN 101233477 7/2008
 CN 101233504 7/2008
 CN 101346688 1/2009
 CN 101432677 5/2009
 CN 201298220 8/2009
 CN 101566865 10/2009
 CN 101576789 11/2009
 CN 101578577 11/2009
 CN 101627361 1/2010
 CN 101636711 1/2010
 CN 101809531 8/2010
 CN 101981522 2/2011
 CN 102004603 4/2011
 CN 102033710 4/2011
 CN 102144213 8/2011
 CN 102197702 9/2011
 CN 102460370 5/2012
 CN 102591571 7/2012
 CN 103543904 1/2014
 EP 0583060 2/1994
 EP 1176520 1/2002
 EP 1337093 8/2003
 EP 1353505 10/2003
 EP 1434411 6/2004
 EP 1752868 2/2007
 EP 1939718 7/2008
 EP 1942401 7/2008
 EP 1962480 8/2008
 EP 2045700 4/2009
 EP 2172836 4/2009
 EP 2076000 7/2009
 EP 2148268 1/2010
 EP 2262193 12/2010
 EP 2659347 11/2013
 GB 2350991 12/2000
 JP 6282368 10/1994
 JP H0744351 2/1995
 JP 7281810 10/1995
 JP 2000293280 10/2000
 JP 2000347645 12/2000
 JP 2001265523 9/2001
 JP 2001290585 10/2001
 JP 2002055753 2/2002

(56)

References Cited

FOREIGN PATENT DOCUMENTS			TW		
JP	2003513350	4/2003	TW	200947297	11/2009
JP	2003195998	7/2003	TW	201023026	6/2010
JP	2004227393	8/2004	TW	201037592	10/2010
JP	2004357257	12/2004	TW	I333157	11/2010
JP	2005527888	9/2005	WO	WO-9928812	1/1999
JP	2006268849	10/2006	WO	WO-9926127	5/1999
JP	2006293989	10/2006	WO	WO-0129976	4/2001
JP	2006323672	11/2006	WO	WO-03075547	9/2003
JP	2007058740	3/2007	WO	WO-2005026931	3/2005
JP	2007148783	6/2007	WO	WO-2005027506	3/2005
JP	2007516496	6/2007	WO	WO-2006019639	2/2006
JP	2007195186	8/2007	WO	WO-2006074267	7/2006
JP	2008508600	3/2008	WO	WO-2007019599	2/2007
JP	2008527540	7/2008	WO	WO-2007065019	6/2007
JP	2008234042	10/2008	WO	WO-2007121557	11/2007
JP	2008276584	11/2008	WO	WO-2007134623	11/2007
JP	2008305087	12/2008	WO	WO-2008030608	3/2008
JP	2009097724	4/2009	WO	WO-2008031871	3/2008
JP	2009265929	11/2009	WO	WO-2008035831	3/2008
JP	2009266192	11/2009	WO	WO-2008041318	4/2008
JP	2010039761	2/2010	WO	WO-2008084211	7/2008
JP	2010049684	3/2010	WO	WO-2009000043	12/2008
JP	2010073099	4/2010	WO	WO-2009012398	1/2009
JP	20100090931	4/2010	WO	WO-2009049331	4/2009
JP	2010108273	5/2010	WO	WO-2009054809	4/2009
JP	2010250465	11/2010	WO	WO-2009081593	7/2009
JP	2010538394	12/2010	WO	WO-2009086628	7/2009
JP	2011048835	3/2011	WO	WO-2009142880	11/2009
JP	2011070525	4/2011	WO	WO-2009158310	12/2009
JP	2011515780	5/2011	WO	WO-2010013609	2/2010
JP	2011516936	5/2011	WO	WO-2010024969	3/2010
JP	2011128029	6/2011	WO	WO-2010036660	4/2010
JP	2011170523	9/2011	WO	WO-2010041826	4/2010
JP	2011221821	11/2011	WO	WO-2010048229	4/2010
JP	2012514811	6/2012	WO	WO-2010048448	4/2010
JP	2012155416	8/2012	WO	WO-2010048519	4/2010
JP	2012527684	11/2012	WO	WO-2010080258	7/2010
JP	2012256147	12/2012	WO	WO-2010089980	8/2010
JP	201365294	10/2014	WO	WO-2010092993	8/2010
KR	200303655	2/2003	WO	WO-2010110613	9/2010
KR	20060019198	3/2006	WO	WO-2010117643	10/2010
KR	20070039613	4/2007	WO	WO-2010119356	10/2010
KR	1020070036114	4/2007	WO	WO-2010125451	11/2010
KR	20070093084	9/2007	WO	WO-2010134718	11/2010
KR	20070093585	9/2007	WO	WO-2010135155	11/2010
KR	1020070098337	10/2007	WO	WO-2011041885	4/2011
KR	20070120368	12/2007	WO	WO-201106467	9/2011
KR	1020080025951	3/2008	WO	WO-201106468	9/2011
KR	1020080041809	5/2008	WO	WO-2011126501	10/2011
KR	1020080076390	8/2008	WO	WO-2012087847	6/2012
KR	100854333	9/2008	WO	WO-2012088485	6/2012
KR	1020080084156	9/2008	WO	WO-2012091289	7/2012
KR	1020080113913	12/2008	WO	WO-2012166188	12/2012
KR	20090002951	1/2009	WO	WO-2014051920	4/2014
KR	20090013927	2/2009	WO	WO-2014085502	6/2014
KR	1020090041635	4/2009			
KR	20090053143	5/2009			
KR	1020090088501	8/2009			
KR	20090106755	10/2009			
KR	1020090123545	12/2009			
KR	20100010072	2/2010			
KR	20100023637	3/2010			
KR	20100048375	5/2010			
KR	20100051119	5/2010			
KR	20100056369	5/2010			
KR	1020100056369	5/2010			
KR	1020100107377	10/2010			
KR	20100124427	11/2010			
KR	1020100131724	12/2010			
KR	20110038632	4/2011			
RU	2409833	4/2009			
RU	2363033	7/2009			
RU	2412463	1/2010			
RU	2405214	11/2010			
RU	2413970	3/2011			

OTHER PUBLICATIONS

“Corrected Notice of Allowance”, U.S. Appl. No. 14/918,359, filed Oct. 4, 2017, 2 pages.

“Foreign Office Action”, CA Application No. 2,836,263, dated Aug. 28, 2017, 4 pages.

“Foreign Office Action”, CA Application No. 2,846,505, dated Aug. 17, 2017, 5 pages.

“Foreign Office Action”, CA Application No. 2,847,180, dated Aug. 17, 2017, 5 pages.

“Foreign Office Action”, KR Application No. 10-2014-7005296, dated Sep. 15, 2017, 12 pages.

“Foreign Office Action”, MY Application No. PI2013702227, dated Jul. 31, 2017, 3 pages.

“Non-Final Office Action”, U.S. Appl. No. 13/118,292, filed Oct. 5, 2017, 50 pages.

Duino, “Google Testing Complete Redesign of ‘My Apps’ Section of Google Play, Includes Sort Option”, Retrieved from <<<https://9to5google.com/2017/02/03/google-testing-redesign-my-apps-section-google-play-sort-option/>>>, Feb. 3, 2017, 5 pages.

(56)

References Cited

OTHER PUBLICATIONS

Vincent, "A First Look at the Google Play Store Redesign", Retrieved from <<<https://www.theverge.com/2015/10/16/9549121/google-play-redesign>>>, Oct. 16, 2015, 2 pages.

Welch, "Android Just Got Incredibly Good at Helping You Manage Your Apps", Retrieved from <<<https://www.theverge.com/2017/4/19/15360278/android-my-apps-google-play-store-redesign-update-sort>>>, Apr. 19, 2017, 5 pages.

Whitwam, "[Update #2: 4.8.22] Latest Google Play Store 4.8.22 With PayPal Support, Simplified App Permissions, Bigger Buttons, And More [APK Download]", Retrieved from <<<http://www.androidpolice.com/2014/07/15/google-rolling-out-play-store-v4-8-19-with-paypal-support-simplified-app-permissions-bigger-buttons-and-more-apk-download/>>>, Jul. 15, 2014, 8 page.

"Extended European Search Report", EP Application No. 11850624, 5, dated Dec. 21, 2016, 9 pages.

"Final Office Action", U.S. Appl. No. 13/228,945, filed Jan. 12, 2017, 23 pages.

"Final Office Action", U.S. Appl. No. 14/850,347, filed Dec. 23, 2016, 6 pages.

"Foreign Office Action", Application No. MX/a/2014/002781, dated Oct. 25, 2016, 5 pages.

"Foreign Office Action", AU Application No. 2011369362, dated Nov. 15, 2016, 3 pages.

"Foreign Office Action", AU Application No. 2011369370, dated Oct. 10, 2016, 3 pages.

"Foreign Office Action", AU Application No. 2011369370, dated Dec. 5, 2016, 4 pages.

"Foreign Office Action", PH Application No. 1-2013-502364, dated Dec. 23, 2016, 2 pages.

"How To Run iPhone Apps Full Screen On iPad Full Force—Quick Tip #8—iOS Vlog 35", Retrieved from <<<https://www.youtube.com/watch?v=cscf80QZ8>>>, Jul. 31, 2010, 1 page.

"Microsoft Windows XP—File and Folder Permissions", Retrieved from <<https://web.archive.org/web/20110211034655/http://www.microsoft.com/resources/documentation/windows/xp/all/proddocs/en-us/acl_folder_permissions.mspx?mfr=true>>, Feb. 11, 2011, 1 page.

"Notice of Allowance", U.S. Appl. No. 13/118,314, filed Jan. 11, 2017, 10 pages.

"Restriction Requirement", U.S. Appl. No. 14/558,666, filed Jan. 13, 2017, 6 pages.

"Corrected Notice of Allowance", U.S. Appl. No. 14/919,607, filed Aug. 21, 2017, 2 pages.

"Foreign Notice of Allowance", CN Application No. 201110454251.3, dated Aug. 7, 2017, 6 pages.

"Foreign Office Action", Application No. MX/a/2014/002781, dated Jun. 23, 2017, 8 pages.

"Foreign Office Action", CA Application No. 2835931, dated Jun. 28, 2017, 5 pages.

"Foreign Office Action", EP Application No. 11866579.3, dated Jul. 10, 2017, 4 pages.

"Foreign Office Action", KR Application No. 10-2013-7031481, dated Jun. 21, 2017, 6 pages.

"Non-Final Office Action", U.S. Appl. No. 14/529,341, filed Aug. 10, 2017, 27 pages.

"Non-Final Office Action", U.S. Appl. No. 14/800,391, filed Aug. 16, 2017, 14 pages.

"Notice of Allowance", U.S. Appl. No. 14/918,358, filed Sep. 1, 2017, 5 pages.

"Notice of Allowance", U.S. Appl. No. 14/918,359, filed Sep. 7, 2017, 5 pages.

"Supplemental Notice of Allowance", U.S. Appl. No. 14/918,358, filed Sep. 15, 2017, 2 pages.

"Corrected Notice of Allowance", U.S. Appl. No. 14/919,607, filed May 30, 2017, 2 pages.

"Foreign Notice of Allowance", AU Application No. 2011376310, dated Apr. 28, 2017, 3 pages.

"Foreign Notice of Allowance", CN Application No. 201210085754.2, dated May 31, 2017, 4 pages.

"Foreign Office Action", IL Application No. 229140, dated Apr. 26, 2017, 6 pages.

"Foreign Office Action", KR Application No. 10-2013-7031472, dated Jun. 22, 2017, 5 pages.

"Non-Final Office Action", U.S. Appl. No. 12/977,235, filed Jun. 21, 2017, 28 pages.

"Non-Final Office Action", U.S. Appl. No. 13/228,876, filed Jun. 15, 2017, 27 pages.

"Non-Final Office Action", U.S. Appl. No. 13/228,945, filed Jun. 30, 2017, 16 pages.

"Non-Final Office Action", U.S. Appl. No. 14/977,462, filed Dec. 7, 2017, 15 pages.

"Final Office Action", U.S. Appl. No. 14/800,391, filed Dec. 21, 2017, 15 pages.

"Corrected Notice of Allowance", U.S. Appl. No. 14/918,358, filed Nov. 13, 2017, 2 pages.

"Corrected Notice of Allowance", U.S. Appl. No. 14/918,359, filed Nov. 14, 2017, 2 pages.

"Foreign Office Action", KR Application No. 10-2017-7026885, dated Dec. 19, 2017, 5 pages.

"Corrected Notice of Allowance", U.S. Appl. No. 13/118,314, filed Mar. 9, 2017, 3 pages.

"Foreign Notice of Allowance", AU Application No. 2011369365, dated Jan. 25, 2017, 3 pages.

"Foreign Notice of Allowance", AU Application No. 2011375741, dated Feb. 1, 2017, 3 pages.

"Foreign Notice of Allowance", TW Application No. 105106514, dated Feb. 15, 2017, 4 pages.

"Foreign Office Action", CN Application No. 201110454251.3, dated Feb. 4, 2017, 7 pages.

"Foreign Office Action", CN Application No. 201180071193.4, dated Mar. 3, 2017, 10 pages.

"Foreign Office Action", EP Application No. 11866553.8, dated Feb. 8, 2017, 6 pages.

"Foreign Office Action", EP Application No. 11867033.0, dated Feb. 8, 2017, 7 pages.

"Foreign Office Action", IL Application No. 229621, dated Feb. 20, 2017, 6 pages.

"Notice of Allowance", U.S. Appl. No. 14/586,364, filed Apr. 21, 2017, 9 pages.

"Notice of Allowance", U.S. Appl. No. 14/919,607, filed Apr. 14, 2017, 7 pages.

"Adobe Acrobat 8 Standard User Guide", Adobe Systems Incorporated, 2007, pp. 34 & 36.

"Adobe Audition / Customizing Workspaces", Retrieved From: <http://help.adobe.com/en_US/audition/cs/using/WS9FA7B8D7-5991-4e05-B13C-4C85DAF1F051.html> Jul. 5, 2014, May 18, 2011, 6 Pages.

"Advisory Action", U.S. Appl. No. 12/414,382, filed Jan. 20, 2012, 3 pages.

"Advisory Action", U.S. Appl. No. 12/433,605, filed Apr. 5, 2012, 3 pages.

"Advisory Action", U.S. Appl. No. 12/709,376, filed Dec. 19, 2013, 2 pages.

"Advisory Action", U.S. Appl. No. 13/598,422, filed Aug. 31, 2015, 3 pages.

"Alltel Adds Dedicated Search Key to Phones", Retrieved from: <<http://www.phonescoop.com/news/item.php?n=2159>> on Nov. 26, 2008., Apr. 12, 2007, 2 Pages.

"Android 2.3 User's Guide", AUG-2.3-103, Android mobile technology platform 2.3, Dec. 13, 2010, 380 pages.

"Apple Human Interface Guidelines: Windows", retrieved from <<http://developer.apple.com/library/mac/#documentation/UserExperience/Conceptuai/AppleHIGuidelines/XHIGWindows/XHIGWindows.html>> on Sep. 28, 2010, Aug. 20, 2009, 59 pages.

"Apple iPhone—8GB AT&T", Retrieved from: <http://nytimes.com/smartphones/apple-iphone-8gb-at/4515-6452_7-32309245.html> on Nov. 20, 2008, Jun. 29, 2007, 11 pages.

"Apple Unibody MacBook Pro #MB991LL/A 2.53 GHz Intel Core 2 Duo", Retrieved from: <http://www.themacstore.com/parts/show/c-nmb3-mb991ll_a> on Nov. 10, 2009, 2009, 12 pages.

(56)

References Cited

OTHER PUBLICATIONS

“Application User Model IDs”, Retrieved from: <[http://msdn.microsoft.com/en-us/library/dd378459\(VS.85\).aspx](http://msdn.microsoft.com/en-us/library/dd378459(VS.85).aspx)> on Sep. 28, 2010, 2010, 6 pages.

“Ask Web Hosting”, Retrieved from: <http://www.askwebhosting.com/story/18501/HTC_FUZE_From_ATandampT_Fuses_Fun_and_Function_With_the_One-Touch_Power_of_TouchFLO_3D.html> on May 5, 2009., Nov. 11, 2008, 3 pages.

“Authoritative Dictionary of IEEE Standards Terms, 7th ed.”, Definitions—processor, memory, and storage, 2000, 3 pages.

“Basics of Your Device: Get Familiar with the Home Screen”, Nokia USA—How to—retrieved from <<http://www.nokia.ca/get-support-and-software/product-support/c6-01/how-to#>> on May 11, 2011, 3 pages.

“Blackberry office tools: Qwerty Convert”, Retrieved from: <http://blackberrysoftwarelist.net/blackberry/download-software/blackberry-office/qwerty_convert.aspx> on Nov. 20, 2008, Nov. 20, 2008, 1 page.

“Borderless Window Option”, retrieved from <<http://forums.lotro.com/showthread.php?89700-Borderless-window-option>> on Sep. 28, 2010, Sep. 9, 2007, 9 pages.

“Calc4M”, Retrieved from: <<http://www.hellebo.com/Calc4M.html>> on Dec. 11, 2008, Sep. 10, 2008, 4 Pages.

“Class ScrollView”, Retrieved from: <<http://www.blackberry.com/developers/docs/6.0.0api/net/rim/device/api/ui/ScrollView.html>> on Sep. 28, 2010, 13 pages.

“Content-Centric E-Mail Message Analysis in Litigation Document Reviews”, Retrieved from: <<http://www.busmanagement.com/article/Issue-14/Data-Management/Content-Centric-E-Mail-Message-Analysis-in-Litigation-Document-Reviews/>> on May 6, 2009, 2009, 5 Pages.

“Corrected Notice of Allowance”, U.S. Appl. No. 13/118,333, filed Jun. 1, 2015, 4 pages.

“Corrected Notice of Allowance”, U.S. Appl. No. 13/118,333, filed Aug. 4, 2015, 4 pages.

“Corrected Notice of Allowance”, U.S. Appl. No. 13/118,333, filed Sep. 14, 2015, 4 pages.

“Corrected Notice of Allowance”, U.S. Appl. No. 13/228,931, filed Oct. 31, 2016, 2 pages.

“Corrected Notice of Allowance”, U.S. Appl. No. 13/656,574, filed Jan. 13, 2015, 4 pages.

“Corrected Notice of Allowance”, U.S. Appl. No. 13/656,574, filed Dec. 12, 2014, 4 pages.

“Corrected Notice of Allowance”, U.S. Appl. No. 13/656,639, filed Dec. 11, 2013, 3 pages.

“Corrected Notice of Allowance”, U.S. Appl. No. 13/657,621, filed Oct. 31, 2016, 2 pages.

“Corrected Notice of Allowance”, U.S. Appl. No. 14/089,149, filed Feb. 20, 2015, 2 pages.

“Corrected Notice of Allowance”, U.S. Appl. No. 14/109,779, filed Jul. 21, 2015, 2 pages.

“Corrected Notice of Allowance”, U.S. Appl. No. 14/109,779, filed Oct. 19, 2015, 2 pages.

“Corrected Notice of Allowance”, U.S. Appl. No. 14/659,442, filed Nov. 10, 2015, 2 pages.

“Corrected Notice of Allowance”, U.S. Appl. No. 14/659,442, filed Nov. 27, 2015, 2 pages.

“Dell and Windows 7—The Wait Is Over”, Retrieved from: <<http://content.dell.com/us/en/corp/d/press-releases/2009-10-22-Dell-and-Windows-7.aspx>> on Nov. 10, 2009, Oct. 22, 2009, 2 pages.

“Dial a number”, Retrieved from: <<http://www.phonespell.org/ialhelp.html>> on Nov. 20, 2008, Nov. 20, 2008, 1 page.

“Display Control”, Retrieved From: <<http://www.portrait.com/technology/display-control.html>> Jul. 4, 2014, Jun. 24, 2013, 5 Pages.

“DuoSense™ Multi-Touch Gestures”, Retrieved from: <http://www.n-trig.com/Data/Uploads/Misc/DuoSenseMTG_final.pdf>, Jul. 2008, 4 pages.

“Elecont Quick Desktop 1.0.43”, Retrieved from: <<http://handheld.softpedia.com/get/System-Utilities/Launcher-Applications/Elecont-Quick-Desktop-72131.shtml>> on May 5, 2009., Mar. 13, 2009, 2 pages.

“Email Notification for Microsoft Outlook and Outlook Express”, Retrieved from: <<http://www.contextmagic.com/express-notification/>> on Sep. 29, 2010, Jul. 21, 2004, 3 pages.

“Enhanced IBM Power Systems Software and PowerVM Restructuring”, IBM United States Announcement 208-082, dated Apr. 8, 2008, available at <http://www.ibm.com/common/ssi/rep_ca/2/897/ENUS208-082/ENUS208082.PDF>, Apr. 8, 2008, pp. 1-19.

“Ex Parte Mewherter, PTAB precedential decision”, U.S. Appl. No. 10/685,192, filed May 8, 2013, 22 pages.

“Examiner’s Answer to Appeal Brief”, U.S. Appl. No. 13/224,258, filed Sep. 23, 2016, 12 pages.

“Exclusive: Windows Mobile 7 to Focus on Touch and Motion Gestures”, Retrieved from: <<http://anti-linux.blogspot.com/2008/08/exclusive-windows-mobile-7-to-focus-on.html>> on May 6, 2009, Aug. 1, 2008, 14 pages.

“Extended European Search Report”, EP Application No. 09818253.8, dated Apr. 10, 2012, 7 pages.

“Extended European Search Report”, EP Application No. 11851985.9, dated Oct. 7, 2014, 6 pages.

“Extended European Search Report”, EP Application No. 11866553.8, dated Dec. 9, 2014, 7 pages.

“Extended European Search Report”, EP Application No. 11866579.3, dated Oct. 9, 2014, 7 pages.

“Extended European Search Report”, EP Application No. 11866699.9, dated Jan. 15, 2015, 6 pages.

“Extended European Search Report”, EP Application No. 11866745.0, dated Jan. 21, 2015, 10 pages.

“Extended European Search Report”, EP Application No. 11866772.4, dated Jan. 15, 2015, 6 pages.

“Extended European Search Report”, EP Application No. 11866939.9, dated Jan. 15, 2015, 8 pages.

“Extended European Search Report”, EP Application No. 11867033.0, dated Nov. 27, 2014, 8 pages.

“Extended European Search Report”, EP Application No. 11867076.9, dated Jan. 15, 2015, 8 pages.

“Extended European Search Report”, EP Application No. 11871739.6, dated Oct. 5, 2015, 13 pages.

“Extended European Search Report”, EP Application No. 11871863.4, dated May 11, 2015, 8 pages.

“Extended European Search Report”, EP Application No. 11871917.8, dated May 11, 2015, 9 pages.

“Extended European Search Report”, EP Application No. 11872072.1, dated Jul. 28, 2015, 7 pages.

“Extended European Search Report”, EP Application No. 11872137.2, dated Apr. 9, 2015, 12 pages.

“Extended European Search Report”, EP Application No. 11872164.6, dated Sep. 18, 2015, 8 pages.

“eXtreme Energy Conservation: Advanced Power-Saving Software for Wireless Devices”, White Paper, Freescale Semiconductor, Inc., Document No. XTMENRGYCNSVWP, Rev #0, available at <http://www.freescale.com/files/32bit/doc/white_paper/XTMENRGYCNSVWP.pdf>, Feb. 2006, 15 pages.

“Final Office Action”, U.S. Appl. No. 11/305,789, filed Apr. 1, 2009, 10 pages.

“Final Office Action”, U.S. Appl. No. 11/502,264, filed Feb. 4, 2010, 15 pages.

“Final Office Action”, U.S. Appl. No. 11/502,264, filed Mar. 29, 2013, 16 pages.

“Final Office Action”, U.S. Appl. No. 11/502,264, filed Apr. 3, 2009, 9 pages.

“Final Office Action”, U.S. Appl. No. 12/244,545, filed Dec. 7, 2011, 16 pages.

“Final Office Action”, U.S. Appl. No. 12/244,545, filed Sep. 7, 2012, 23 pages.

“Final Office Action”, U.S. Appl. No. 12/413,977, filed Nov. 17, 2011, 16 pages.

“Final Office Action”, U.S. Appl. No. 12/414,382, filed Dec. 23, 2011, 7 pages.

(56)

References Cited

OTHER PUBLICATIONS

- “Final Office Action”, U.S. Appl. No. 12/414,476, filed Dec. 1, 2011, 20 pages.
- “Final Office Action”, U.S. Appl. No. 12/433,605, filed Feb. 3, 2012, 11 pages.
- “Final Office Action”, U.S. Appl. No. 12/433,667, filed Sep. 13, 2011, 17 pages.
- “Final Office Action”, U.S. Appl. No. 12/469,458, filed Nov. 17, 2011, 15 pages.
- “Final Office Action”, U.S. Appl. No. 12/469,480, filed Feb. 9, 2012, 17 pages.
- “Final Office Action”, U.S. Appl. No. 12/472,699, filed Jul. 29, 2013, 12 pages.
- “Final Office Action”, U.S. Appl. No. 12/472,699, filed Feb. 15, 2012, 12 pages.
- “Final Office Action”, U.S. Appl. No. 12/484,799, filed Apr. 30, 2012, 13 pages.
- “Final Office Action”, U.S. Appl. No. 12/560,081, filed Mar. 14, 2012, 16 pages.
- “Final Office Action”, U.S. Appl. No. 12/577,400, filed Jan. 30, 2014, 36 pages.
- “Final Office Action”, U.S. Appl. No. 12/577,400, filed Aug. 16, 2013, 25 pages.
- “Final Office Action”, U.S. Appl. No. 12/577,400, filed Sep. 14, 2012, 26 pages.
- “Final Office Action”, U.S. Appl. No. 12/695,842, filed Dec. 2, 2013, 17 pages.
- “Final Office Action”, U.S. Appl. No. 12/695,937, filed Jul. 26, 2012, 13 pages.
- “Final Office Action”, U.S. Appl. No. 12/695,976, filed Nov. 21, 2012, 10 pages.
- “Final Office Action”, U.S. Appl. No. 12/700,357, filed Oct. 24, 2012, 13 pages.
- “Final Office Action”, U.S. Appl. No. 12/700,460, filed Aug. 28, 2012, 26 pages.
- “Final Office Action”, U.S. Appl. No. 12/700,510, filed Oct. 10, 2012, 23 pages.
- “Final Office Action”, U.S. Appl. No. 12/709,204, filed Sep. 12, 2013, 24 pages.
- “Final Office Action”, U.S. Appl. No. 12/709,204, filed Oct. 3, 2012, 24 pages.
- “Final Office Action”, U.S. Appl. No. 12/709,245, filed Mar. 15, 2013, 16 pages.
- “Final Office Action”, U.S. Appl. No. 12/709,245, filed Jan. 6, 2012, 13 pages.
- “Final Office Action”, U.S. Appl. No. 12/709,282, filed Dec. 24, 2012, 11 pages.
- “Final Office Action”, U.S. Appl. No. 12/709,282, filed Jul. 16, 2013, 11 pages.
- “Final Office Action”, U.S. Appl. No. 12/709,301, filed Jan. 7, 2013, 14 pages.
- “Final Office Action”, U.S. Appl. No. 12/709,301, filed Sep. 3, 2013, 12 pages.
- “Final Office Action”, U.S. Appl. No. 12/709,301, filed Mar. 1, 2012, 11 pages.
- “Final Office Action”, U.S. Appl. No. 12/709,348, filed Jan. 7, 2013, 15 pages.
- “Final Office Action”, U.S. Appl. No. 12/709,348, filed Sep. 12, 2013, 12 pages.
- “Final Office Action”, U.S. Appl. No. 12/709,348, filed Feb. 17, 2012, 13 pages.
- “Final Office Action”, U.S. Appl. No. 12/709,376, filed Sep. 10, 2013, 12 pages.
- “Final Office Action”, U.S. Appl. No. 12/709,376, filed Nov. 8, 2012, 20 pages.
- “Final Office Action”, U.S. Appl. No. 12/709,376, filed Mar. 30, 2012, 16 pages.
- “Final Office Action”, U.S. Appl. No. 12/713,053, filed Aug. 17, 2012, 10 pages.
- “Final Office Action”, U.S. Appl. No. 12/713,081, filed May 9, 2012, 19 pages.
- “Final Office Action”, U.S. Appl. No. 12/713,096, filed Feb. 15, 2013, 7 pages.
- “Final Office Action”, U.S. Appl. No. 12/713,110, filed Jan. 17, 2013, 10 pages.
- “Final Office Action”, U.S. Appl. No. 12/713,113, filed Oct. 8, 2013, 21 pages.
- “Final Office Action”, U.S. Appl. No. 12/713,113, filed Jun. 4, 2012, 18 pages.
- “Final Office Action”, U.S. Appl. No. 12/713,118, filed Oct. 26, 2012, 10 pages.
- “Final Office Action”, U.S. Appl. No. 12/713,127, filed Jun. 6, 2012, 18 pages.
- “Final Office Action”, U.S. Appl. No. 12/713,130, filed Jun. 29, 2012, 8 pages.
- “Final Office Action”, U.S. Appl. No. 12/713,133, filed May 20, 2013, 10 pages.
- “Final Office Action”, U.S. Appl. No. 12/713,133, filed Jul. 2, 2012, 8 pages.
- “Final Office Action”, U.S. Appl. No. 12/721,422, filed Mar. 7, 2013, 10 pages.
- “Final Office Action”, U.S. Appl. No. 12/972,967, filed Oct. 11, 2013, 21 pages.
- “Final Office Action”, U.S. Appl. No. 12/977,235, filed Apr. 22, 2015, 19 pages.
- “Final Office Action”, U.S. Appl. No. 12/977,235, filed Nov. 3, 2016, 27 pages.
- “Final Office Action”, U.S. Appl. No. 12/983,106, filed Jul. 16, 2015, 23 pages.
- “Final Office Action”, U.S. Appl. No. 12/983,106, filed Oct. 7, 2013, 19 pages.
- “Final Office Action”, U.S. Appl. No. 13/073,300, filed Apr. 1, 2014, 14 pages.
- “Final Office Action”, U.S. Appl. No. 13/073,300, filed Sep. 4, 2015, 17 pages.
- “Final Office Action”, U.S. Appl. No. 13/118,181, filed Jun. 16, 2016, 18 pages.
- “Final Office Action”, U.S. Appl. No. 13/118,181, filed Dec. 20, 2013, 18 pages.
- “Final Office Action”, U.S. Appl. No. 13/118,204, filed Nov. 21, 2013, 24 pages.
- “Final Office Action”, U.S. Appl. No. 13/118,221, filed Mar. 17, 2014, 21 pages.
- “Final Office Action”, U.S. Appl. No. 13/118,265, filed Nov. 6, 2014, 19 pages.
- “Final Office Action”, U.S. Appl. No. 13/118,288, filed Nov. 7, 2014, 14 pages.
- “Final Office Action”, U.S. Appl. No. 13/118,292, filed Aug. 26, 2016, 38 pages.
- “Final Office Action”, U.S. Appl. No. 13/118,292, filed Dec. 5, 2014, 30 pages.
- “Final Office Action”, U.S. Appl. No. 13/118,302, filed Mar. 25, 2016, 22 pages.
- “Final Office Action”, U.S. Appl. No. 13/118,302, filed Aug. 15, 2014, 17 pages.
- “Final Office Action”, U.S. Appl. No. 13/118,314, filed Jan. 13, 2016, 16 pages.
- “Final Office Action”, U.S. Appl. No. 13/118,314, filed Sep. 11, 2014, 18 pages.
- “Final Office Action”, U.S. Appl. No. 13/118,321, filed Apr. 2, 2015, 30 pages.
- “Final Office Action”, U.S. Appl. No. 13/118,321, filed Dec. 19, 2013, 30 pages.
- “Final Office Action”, U.S. Appl. No. 13/118,333, filed Apr. 23, 2014, 22 pages.
- “Final Office Action”, U.S. Appl. No. 13/118,339, filed Aug. 22, 2013, 21 pages.
- “Final Office Action”, U.S. Appl. No. 13/118,347, filed Aug. 15, 2013, 25 pages.
- “Final Office Action”, U.S. Appl. No. 13/224,258, filed Jul. 18, 2014, 39 pages.

(56)

References Cited

OTHER PUBLICATIONS

“Final Office Action”, U.S. Appl. No. 13/224,258, filed Aug. 13, 2015, 39 pages.

“Final Office Action”, U.S. Appl. No. 13/224,258, filed Sep. 11, 2013, 37 pages.

“Final Office Action”, U.S. Appl. No. 13/228,707, filed May 21, 2014, 16 pages.

“Final Office Action”, U.S. Appl. No. 13/228,707, filed Jun. 1, 2015, 20 pages.

“Final Office Action”, U.S. Appl. No. 13/228,707, filed Aug. 23, 2016, 33 pages.

“Final Office Action”, U.S. Appl. No. 13/228,876, filed Jun. 19, 2015, 20 pages.

“Final Office Action”, U.S. Appl. No. 13/228,876, filed Jul. 18, 2014, 15 pages.

“Final Office Action”, U.S. Appl. No. 13/228,876, filed Sep. 13, 2016, 21 pages.

“Final Office Action”, U.S. Appl. No. 13/228,888, filed Oct. 24, 2014, 29 pages.

“Final Office Action”, U.S. Appl. No. 13/228,931, filed Dec. 19, 2014, 27 pages.

“Final Office Action”, U.S. Appl. No. 13/228,945, filed Oct. 23, 2014, 24 pages.

“Final Office Action”, U.S. Appl. No. 13/229,155, filed Jun. 4, 2015, 16 pages.

“Final Office Action”, U.S. Appl. No. 13/229,155, filed Jun. 12, 2014, 15 pages.

“Final Office Action”, U.S. Appl. No. 13/229,693, filed Jan. 6, 2015, 24 pages.

“Final Office Action”, U.S. Appl. No. 13/229,693, filed Sep. 4, 2013, 23 pages.

“Final Office Action”, U.S. Appl. No. 13/229,702, filed Jan. 15, 2015, 24 pages.

“Final Office Action”, U.S. Appl. No. 13/345,383, filed Jul. 25, 2014, 26 pages.

“Final Office Action”, U.S. Appl. No. 13/345,383, filed Jul. 30, 2013, 27 pages.

“Final Office Action”, U.S. Appl. No. 13/484,075, filed May 21, 2013, 10 pages.

“Final Office Action”, U.S. Appl. No. 13/550,432, filed Sep. 14, 2015, 18 pages.

“Final Office Action”, U.S. Appl. No. 13/598,422, filed Jun. 23, 2015, 19 pages.

“Final Office Action”, U.S. Appl. No. 13/598,422, filed Aug. 6, 2014, 33 pages.

“Final Office Action”, U.S. Appl. No. 13/655,386, filed Jun. 6, 2013, 34 pages.

“Final Office Action”, U.S. Appl. No. 13/656,354, filed Jun. 17, 2013, 14 pages.

“Final Office Action”, U.S. Appl. No. 13/656,574, filed Aug. 23, 2013, 20 pages.

“Final Office Action”, U.S. Appl. No. 13/657,621, filed Jan. 15, 2015, 22 pages.

“Final Office Action”, U.S. Appl. No. 13/657,621, filed Jan. 21, 2016, 21 pages.

“Final Office Action”, U.S. Appl. No. 13/657,621, filed Sep. 10, 2013, 18 pages.

“Final Office Action”, U.S. Appl. No. 13/657,646, filed May 6, 2013, 12 pages.

“Final Office Action”, U.S. Appl. No. 13/657,789, filed Jun. 21, 2013, 35 pages.

“Final Office Action”, U.S. Appl. No. 13/658,694, filed Mar. 30, 2015, 30 pages.

“Final Office Action”, U.S. Appl. No. 13/658,694, filed Oct. 30, 2013, 17 pages.

“Final Office Action”, U.S. Appl. No. 14/059,163, filed Dec. 3, 2015, 6 pages.

“First Examination Report”, NZ Application No. 618254, dated May 20, 2014, 3 Pages.

“First Examination Report”, NZ Application No. 618264, dated May 20, 2014, 2 pages.

“First Examination Report”, NZ Application No. 618269, dated May 20, 2014, 2 pages.

“First Examination Report”, NZ Application No. 618284, dated May 20, 2014, 2 pages.

“Foreign Notice of Acceptance”, NZ Application No. 618254, dated Jan. 20, 2015, 1 Page.

“Foreign Notice of Acceptance”, NZ Application No. 618264, dated Jun. 27, 2015, 1 Page.

“Foreign Notice of Acceptance”, NZ Application No. 618269, dated Oct. 31, 2014, 1 Page.

“Foreign Notice of Allowance”, CN Application No. 201110429183.5, dated Mar. 9, 2015, 4 Pages.

“Foreign Notice of Allowance”, CN Application No. 201110437542.1, dated Aug. 3, 2015, 4 Pages.

“Foreign Notice of Allowance”, CN Application No. 201110437572.2, dated Mar. 3, 2015, 3 Pages.

“Foreign Notice of Allowance”, CN Application No. 201180071183.0, dated Sep. 27, 2016, 6 pages.

“Foreign Notice of Allowance”, CN Application No. 201210317470.1, dated Feb. 23, 2016, 4 pages.

“Foreign Notice of Allowance”, CN Application No. 201210331158.8, dated Sep. 8, 2015, 3 Pages.

“Foreign Notice of Allowance”, CN Application No. 201210331584.1, dated Feb. 14, 2016, 4 pages.

“Foreign Notice of Allowance”, CN Application No. 201210331670.2, dated Apr. 26, 2016, 4 pages.

“Foreign Notice of Allowance”, JP Application No. 2014-512819, dated Jan. 26, 2016, 4 pages.

“Foreign Notice of Allowance”, JP Application No. 2014-512821, dated Jun. 28, 2016, 4 pages.

“Foreign Notice of Allowance”, JP Application No. 2014-528371, dated Oct. 4, 2016, 4 pages.

“Foreign Notice of Allowance”, JP Application No. 2014-529687, dated May 31, 2016, 4 pages.

“Foreign Notice of Allowance”, RU Application No. 2013152634, dated Jul. 22, 2016, 19 pages.

“Foreign Notice of Allowance”, RU Application No. 2013152636, dated Feb. 19, 2016, 18 pages.

“Foreign Notice of Allowance”, RU Application No. 2014107906, dated Apr. 25, 2016, 18 pages.

“Foreign Notice of Allowance”, RU Application No. 2014108997, dated May 26, 2016, 17 pages.

“Foreign Notice of Allowance”, TW Application No. 100136568, dated May 31, 2016, 4 pages.

“Foreign Office Action”, Application No. MX/a/2013/013923, dated Sep. 13, 2016, 10 pages.

“Foreign Office Action”, Application No. MX/a/2014/002507, dated Aug. 9, 2016, 7 pages.

“Foreign Office Action”, AU Application No. 2011369360, dated Jul. 23, 2016, 3 pages.

“Foreign Office Action”, AU Application No. 2011369365, dated Oct. 7, 2016, 3 pages.

“Foreign Office Action”, AU Application No. 2011369370, dated Aug. 4, 2016, 3 pages.

“Foreign Office Action”, AU Application No. 2011375741, dated Sep. 14, 2016, 4 pages.

“Foreign Office Action”, AU Application No. 2011376310, dated Sep. 10, 2016, 3 pages.

“Foreign Office Action”, AU Application No. 2011376311, dated Sep. 10, 2016, 3 pages.

“Foreign Office Action”, CL Application No. 3368-2013, dated May 7, 2015, 7 pages.

“Foreign Office Action”, CL Application No. 3369-13, dated Oct. 29, 2015, 6 pages.

“Foreign Office Action”, CL Application No. 3369-2013, dated May 7, 2015, 6 pages.

“Foreign Office Action”, CL Application No. 3370-2013, dated May 7, 2015, 6 pages.

“Foreign Office Action”, CL Application No. 3370-2013, dated Oct. 29, 2015, 6 pages.

(56)

References Cited

OTHER PUBLICATIONS

- “Foreign Office Action”, CN Application No. 201110454251.3, dated May 27, 2016, 6 Pages.
- “Foreign Office Action”, CN Application No. 201080045865.X, dated Dec. 4, 2012, 10 pages.
- “Foreign Office Action”, CN Application No. 201080045865.X, dated Jun. 4, 2013, 10 pages.
- “Foreign Office Action”, CN Application No. 201110044285.5, dated Apr. 24, 2013, 8 pages.
- “Foreign Office Action”, CN Application No. 201110044285.5, dated Jun. 20, 2012, 12 pages.
- “Foreign Office Action”, CN Application No. 201110044285.5, dated Jan. 4, 2013, 13 pages.
- “Foreign Office Action”, CN Application No. 201110046510.9, dated May 31, 2013, 11 pages.
- “Foreign Office Action”, CN Application No. 201110046519.X, dated Mar. 19, 2013, 12 pages.
- “Foreign Office Action”, CN Application No. 201110046519.X, dated Aug. 2, 2012, 13 pages.
- “Foreign Office Action”, CN Application No. 201110046529.3, dated Feb. 4, 2013, 9 pages.
- “Foreign Office Action”, CN Application No. 201110046529.3, dated Aug. 16, 2012, 14 pages.
- “Foreign Office Action”, CN Application No. 201110050499.3, dated Nov. 27, 2012, 8 pages.
- “Foreign Office Action”, CN Application No. 201110050499.3, dated Aug. 3, 2012, 8 pages.
- “Foreign Office Action”, CN Application No. 201110050506.X, dated Apr. 2, 2013, 11 pages.
- “Foreign Office Action”, CN Application No. 201110050508.9, dated Mar. 7, 2013, 8 pages.
- “Foreign Office Action”, CN Application No. 201110050508.9, dated Aug. 3, 2012, 8 pages.
- “Foreign Office Action”, CN Application No. 201110050852.8, dated Mar. 26, 2013, 11 pages.
- “Foreign Office Action”, CN Application No. 201110429183.5, dated Jan. 6, 2014, 10 Pages.
- “Foreign Office Action”, CN Application No. 201110429183.5, dated Aug. 21, 2014, 13 Pages.
- “Foreign Office Action”, CN Application No. 201110437542.1, dated Jan. 6, 2014, 10 Pages.
- “Foreign Office Action”, CN Application No. 201110437542.1, dated Jan. 28, 2015, 7 pages.
- “Foreign Office Action”, CN Application No. 201110437542.1, dated Aug. 20, 2014, 8 pages.
- “Foreign Office Action”, CN Application No. 201110437551.0, dated Mar. 25, 2015, 9 pages.
- “Foreign Office Action”, CN Application No. 201110437572.2, dated Dec. 3, 2013, 7 pages.
- “Foreign Office Action”, CN Application No. 201110454251.3, dated Feb. 28, 2015, 9 Pages.
- “Foreign Office Action”, CN Application No. 201110454251.3, dated Sep. 30, 2015, 10 Pages.
- “Foreign Office Action”, CN Application No. 201110454251.3, dated Oct. 21, 2014, 13 Pages.
- “Foreign Office Action”, CN Application No. 201110454251.3, dated Dec. 27, 2013, 12 Pages.
- “Foreign Office Action”, CN Application No. 201180071183.0, dated Jan. 28, 2016, 18 pages.
- “Foreign Office Action”, CN Application No. 201180071186.4, dated Jan. 20, 2015, 8 pages.
- “Foreign Office Action”, CN Application No. 201180071186.4, dated Jun. 2, 2015, 7 pages.
- “Foreign Office Action”, CN Application No. 201180071186.4, dated Jun. 13, 2014, 12 pages.
- “Foreign Office Action”, CN Application No. 201180071190.0, dated Jan. 26, 2016, 16 pages.
- “Foreign Office Action”, CN Application No. 201180071190.0, dated May 17, 2016, 7 pages.
- “Foreign Office Action”, CN Application No. 201180071194.9, dated Nov. 27, 2015, 17 pages.
- “Foreign Office Action”, CN Application No. 201180071195.3, dated Mar. 18, 2015, 8 pages.
- “Foreign Office Action”, CN Application No. 201180071195.3, dated Aug. 25, 2014, 15 pages.
- “Foreign Office Action”, CN Application No. 201180071196.8, dated Sep. 11, 2014, 13 pages.
- “Foreign Office Action”, CN Application No. 201180071200.0, dated Feb. 17, 2015, 12 pages.
- “Foreign Office Action”, CN Application No. 201180071200.0, dated Aug. 19, 2014, 15 pages.
- “Foreign Office Action”, CN Application No. 201210085754.2, dated Apr. 5, 2016, 16 pages.
- “Foreign Office Action”, CN Application No. 201210317470.1, dated Feb. 11, 2015, 9 pages.
- “Foreign Office Action”, CN Application No. 201210317470.1, dated Jun. 5, 2014, 12 pages.
- “Foreign Office Action”, CN Application No. 201210317470.1, dated Aug. 24, 2015, 9 pages.
- “Foreign Office Action”, CN Application No. 201210331158.8, dated May 11, 2015, 7 pages.
- “Foreign Office Action”, CN Application No. 201210331158.8, dated Sep. 3, 2014, 16 Pages.
- “Foreign Office Action”, CN Application No. 201210331188.9, dated Oct. 10, 2014, 12 pages.
- “Foreign Office Action”, CN Application No. 201210331564.4, dated Sep. 2, 2015, 14 pages.
- “Foreign Office Action”, CN Application No. 201210331564.4, dated Dec. 3, 2014, 12 pages.
- “Foreign Office Action”, CN Application No. 201210331584.1, dated Aug. 19, 2015, 7 pages.
- “Foreign Office Action”, CN Application No. 201210331584.1, dated Nov. 3, 2014, 14 pages.
- “Foreign Office Action”, CN Application No. 201210331670.2, dated Mar. 25, 2015, 14 pages.
- “Foreign Office Action”, CN Application No. 201210331670.2, dated Dec. 1, 2015, 14 pages.
- “Foreign Office Action”, CN Application No. 201210331686.3, dated Mar. 3, 2015, 14 pages.
- “Foreign Office Action”, CN Application No. 201210331686.3, dated Jun. 13, 2014, 13 pages.
- “Foreign Office Action”, CN Application No. 201210331686.3, dated Sep. 1, 2015, 11 pages.
- “Foreign Office Action”, CO Application No. 13-298.756, dated Sep. 18, 2014, 13 Pages.
- “Foreign Office Action”, CO Application No. 13-298.756, dated Oct. 11, 2015, 11 pages.
- “Foreign Office Action”, CO Application No. 13300256, dated Apr. 11, 2015, 8 Pages.
- “Foreign Office Action”, CO Application No. 13300256, dated Sep. 24, 2014, 8 Pages.
- “Foreign Office Action”, CO Application No. 13300259, dated Sep. 24, 2014, 15 Pages.
- “Foreign Office Action”, CO Application No. 13300265, dated Apr. 21, 2015, 11 Pages.
- “Foreign Office Action”, CO Application No. 13300265, dated Sep. 24, 2014, 10 Pages.
- “Foreign Office Action”, EP Application No. 10823883.3, dated Aug. 10, 2012, 5 pages.
- “Foreign Office Action”, EP Application No. 11747907.1, dated Jan. 28, 2013, 5 pages.
- “Foreign Office Action”, EP Application No. 11748026.9, dated Jan. 16, 2013, 5 pages.
- “Foreign Office Action”, EP Application No. 11748027.7, dated Jan. 18, 2013, 5 pages.
- “Foreign Office Action”, EP Application No. 11748028.5, dated Jan. 28, 2013, 5 pages.
- “Foreign Office Action”, EP Application No. 11748029.3, dated Jan. 16, 2013, 5 pages.
- “Foreign Office Action”, EP Application No. 11866579.3, dated Apr. 5, 2016, 4 pages.

(56)

References Cited

OTHER PUBLICATIONS

- “Foreign Office Action”, EP Application No. 11866579.3, dated Sep. 3, 2015, 4 pages.
- “Foreign Office Action”, EP Application No. 11866699.9, dated Feb. 3, 2016, 4 pages.
- “Foreign Office Action”, EP Application No. 11866699.9, dated Sep. 20, 2016, 4 pages.
- “Foreign Office Action”, EP Application No. 11866772.4, dated Feb. 2, 2016, 5 pages.
- “Foreign Office Action”, EP Application No. 1866699.9, dated Feb. 3, 2016, 4 pages.
- “Foreign Office Action”, IL Application No. 229140, dated May 8, 2016, 6 pages.
- “Foreign Office Action”, IL Application No. 229622, dated Feb. 15, 2016, 6 pages.
- “Foreign Office Action”, JP Application No. 2012-534255, dated Aug. 15, 2014, 6 Pages.
- “Foreign Office Action”, JP Application No. 2014-512819, dated Sep. 29, 2015, 4 pages.
- “Foreign Office Action”, JP Application No. 2014-512820, dated Mar. 22, 2016, 5 pages.
- “Foreign Office Action”, JP Application No. 2014-512820, dated Sep. 29, 2015, 10 pages.
- “Foreign Office Action”, JP Application No. 2014-512821, dated Oct. 20, 2015, 5 pages.
- “Foreign Office Action”, JP Application No. 2014-512824, dated Jun. 7, 2016, 6 pages.
- “Foreign Office Action”, JP Application No. 2014-512824, dated Nov. 6, 2015, 5 pages.
- “Foreign Office Action”, JP Application No. 2014-528371, dated Jun. 7, 2016, 5 pages.
- “Foreign Office Action”, JP Application No. 2014-528371, dated Sep. 29, 2015, 16 pages.
- “Foreign Office Action”, JP Application No. 2014-529671, dated Sep. 29, 2015, 16 pages.
- “Foreign Office Action”, JP Application No. 2014-529672, dated Oct. 6, 2015, 7 pages.
- “Foreign Office Action”, JP Application No. 2014-529684, dated Nov. 4, 2015, 10 pages.
- “Foreign Office Action”, JP Application No. 2014-529685, dated Apr. 5, 2016, 6 pages.
- “Foreign Office Action”, JP Application No. 2014-529685, dated Nov. 4, 2015, 5 pages.
- “Foreign Office Action”, JP Application No. 2014-529687, dated Oct. 20, 2015, 8 pages.
- “Foreign Office Action”, PH Application No. 12013502355, dated Jan. 19, 2016, 5 pages.
- “Foreign Office Action”, PH Application No. 1-2013-502364, dated Jan. 19, 2016, 4 pages.
- “Foreign Office Action”, PH Application No. 1-2013-502367, dated Jun. 15, 2016, 2 pages.
- “Foreign Office Action”, PH Application No. PH/1/2013/502367, dated Apr. 24, 2015, 3 pages.
- “Foreign Office Action”, RU Application No. 2013152630, dated Oct. 26, 2015, 5 pages.
- “Foreign Office Action”, RU Application No. 2013152634, dated Oct. 22, 2015, 7 pages.
- “Foreign Office Action”, RU Application No. 2013152635, dated Oct. 28, 2015, 7 pages.
- “Foreign Office Action”, RU Application No. 2013152636, dated Oct. 16, 2015, 11 pages.
- “Foreign Office Action”, RU Application No. 2014107906, dated Oct. 6, 2015, 6 pages.
- “Foreign Office Action”, RU Application No. 2014108844, dated Jun. 23, 2016, 6 pages.
- “Foreign Office Action”, RU Application No. 2014108844, dated Oct. 27, 2015, 6 pages.
- “Foreign Office Action”, RU Application No. 2014108874, dated Oct. 6, 2015, 6 pages.
- “Foreign Office Action”, RU Application No. 2014108997, dated Oct. 14, 2015, 6 pages.
- “Freeware.mobi”, Retrieved from: <<http://www.palmtree.com/download-palette.html>> on Nov. 6, 2008, Oct. 9, 2001, 2 pages.
- “Further Examination Report”, NZ Application No. 618264, dated Dec. 3, 2014, 3 Pages.
- “Further Examination Report”, NZ Application No. 618284, dated Jul. 13, 2015, 2 pages.
- “Gestures Programming”, Retrieved from <<http://doc.qt.digia.com/4.6/gestures-overview.html>> on May 28, 2014, 2010, 3 pages.
- “GnomeCanvas”, Retrieved from: <<http://library.gnome.org/devel/libgnomecanvas/unstable/GnomeCanvas.html>> on Sep. 28, 2010, 11 pages.
- “How Do I Cancel a “Drag” Motion on an Android Seekbar?”, retrieved from <<http://stackoverflow.com/questions/2917969/how-do-i-cancel-a-drag-motion-on-an-android-seekbar>> on Jun. 20, 2011, May 28, 2010, 1 page.
- “How do I use Categories with my Weblog?”, Retrieved from: <http://tpsupport.mtcs.sixapart.com/tp/us-tp1/how_do_i_use_categories_with_my_weblog.html> on Sep. 28, 2010, Sep. 16, 2009, 3 pages.
- “How do you dial 1-800-FLOWERS”, Retrieved from: <<http://blogs.msdn.com/windowsmobile/archive/2007/02/06/how-do-you-dial-1-800-flowers.aspx>> on Nov. 20, 2008, Feb. 6, 2007, 24 pages.
- “HTC Shows HTC Snap with Snappy Email Feature”, Retrieved from: <<http://www.wirelessandmobilenews.com/smartphones/> on May 5, 2009>, May 4, 2009, 10 Pages.
- “Image Gestures Example”, Retrieved from <<http://doc.qt.digia.com/4.6/gestures-imagegestures.html>> on May 28, 2014, 2010, 3 pages.
- “IntelliScreen-New iPhone App Shows Today Screen Type Info in Lock Screen”, Retrieved from: <<http://justanotheriphoneblog.com/wordpress//2008/05/13/intelliscreen-new-iphone-app-shows-today-screen-type-info-on-lock-screen/>> on Nov. 12, 2008, May 13, 2008, 11 pages.
- “International Preliminary Report on Patentability”, Application No. PCT/US2015/042226, dated Nov. 2, 2016, 7 pages.
- “International Preliminary Report on Patentability”, Application No. PCT/US2015/042218, dated Nov. 3, 2016, 7 pages.
- “International Preliminary Report on Patentability”, Application No. PCT/US2015/042205, dated Nov. 8, 2016, 7 pages.
- “International Preliminary Report on Patentability”, Application No. PCT/US2015/042259, dated Sep. 16, 2016, 8 pages.
- “International Preliminary Report on Patentability”, Application No. PCT/US2015/042371, dated Oct. 20, 2016, 8 pages.
- “International Preliminary Report on Patentability”, Application No. PCT/US2015/041930, dated Oct. 26, 2016, 9 pages.
- “International Search Report and Written Opinion”, Application No. PCT/US2010/028555, dated Oct. 12, 2010, 10 pages.
- “International Search Report and Written Opinion”, Application No. PCT/US2011/025132, dated Oct. 26, 2011, 10 pages.
- “International Search Report and Written Opinion”, Application No. PCT/US2011/025131, dated Oct. 31, 2011, 10 pages.
- “International Search Report and Written Opinion”, Application No. PCT/US2010/028699, dated Oct. 4, 2010, 10 pages.
- “International Search Report and Written Opinion”, Application No. PCT/US2013/060247, dated Dec. 10, 2013, 10 pages.
- “International Search Report and Written Opinion”, Application No. PCT/US2011/067075, dated Dec. 12, 2012, 10 pages.
- “International Search Report and Written Opinion”, Application No. PCT/US2009/061864, dated May 14, 2010, 10 pages.
- “International Search Report and Written Opinion”, Application No. PCT/US2009/061382, dated May 26, 2010, 10 pages.
- “International Search Report and Written Opinion”, Application No. PCT/US2011/067074, dated Aug. 27, 2012, 10 pages.
- “International Search Report and Written Opinion”, Application No. PCT/US2011/055725, dated Sep. 27, 2012, 10 pages.
- “International Search Report and Written Opinion”, Application No. PCT/US2009/061735, dated Jun. 7, 2010, 11 pages.
- “International Search Report and Written Opinion”, Application No. PCT/US2013/055507, dated Oct. 8, 2013, 12 pages.
- “International Search Report and Written Opinion”, Application No. PCT/US2015/048751, dated Nov. 27, 2015, 12 pages.

(56)

References Cited

OTHER PUBLICATIONS

- “International Search Report and Written Opinion”, Application No. PCT/US2010/034772, dated Dec. 29, 2010, 12 pages.
- “International Search Report and Written Opinion”, Application No. PCT/US2011/025973, dated Oct. 27, 2011, 13 pages.
- “International Search Report and Written Opinion”, Application No. PCT/US/2011025972, dated Sep. 30, 2011, 14 pages.
- “International Search Report and Written Opinion”, Application No. PCT/US2011/025575, dated Sep. 30, 2011, 14 pages.
- “International Search Report and Written Opinion”, Application No. PCT/US2011/025971, dated Oct. 31, 2011, 15 pages.
- “International Search Report and Written Opinion”, Application No. PCT/US2012/047091, dated Dec. 27, 2012, 15 pages.
- “International Search Report and Written Opinion”, Application No. PCT/US2010/038730, dated Jan. 19, 2011, 8 pages.
- “International Search Report and Written Opinion”, Application No. PCT/US2011/020417, dated Oct. 20, 2011, 8 pages.
- “International Search Report and Written Opinion”, Application No. PCT/US2011/025974, dated Oct. 26, 2011, 8 pages.
- “International Search Report and Written Opinion”, Application No. PCT/US2011/055513, dated Mar. 27, 2012, 8 pages.
- “International Search Report and Written Opinion”, Application No. PCT/US2010/052119, dated May 2, 2011, 8 pages.
- “International Search Report and Written Opinion”, Application No. PCT/US2011/055514, dated May 22, 2012, 8 pages.
- “International Search Report and Written Opinion”, Application No. PCT/US2011/055512, dated May 24, 2012, 8 pages.
- “International Search Report and Written Opinion”, Application No. PCT/US2011/055520, dated May 9, 2012, 8 pages.
- “International Search Report and Written Opinion”, Application No. PCT/US2011/055524, dated Jun. 1, 2012, 8 pages.
- “International Search Report and Written Opinion”, Application No. PCT/US2011/065702, dated Aug. 29, 2012, 8 pages.
- “International Search Report and Written Opinion”, Application No. PCT/US2011/055736, dated Sep. 17, 2012, 8 pages.
- “International Search Report and Written Opinion”, Application No. PCT/US2011/067073, dated Sep. 17, 2012, 8 pages.
- “International Search Report and Written Opinion”, Application No. PCT/US2011/055511, dated Apr. 24, 2012, 9 pages.
- “International Search Report and Written Opinion”, Application No. PCT/US2011/055523, dated May 10, 2012, 9 pages.
- “International Search Report and Written Opinion”, Application No. PCT/US2011/055521, dated May 15, 2012, 9 pages.
- “International Search Report and Written Opinion”, Application No. PCT/US2011/055522, dated May 15, 2012, 9 pages.
- “International Search Report and Written Opinion”, Application No. PCT/US2011/020412, dated Aug. 31, 2011, 9 pages.
- “International Search Report and Written Opinion”, Application No. PCT/US2011/055496, dated Sep. 12, 2012, 9 pages.
- “International Search Report and Written Opinion”, Application No. PCT/US2011/055712, dated Sep. 21, 2012, 9 pages.
- “International Search Report and Written Opinion”, Application No. PCT/US2011/055493, dated 9/26/212, 9 pages.
- “International Search Report and Written Opinion”, Application No. PCT/US2011/020410, dated Sep. 27, 2011, 9 pages.
- “International Search Report and Written Opinion”, Application No. PCT/US2011/055478, dated Sep. 27, 2012, 9 pages.
- “International Search Report and Written Opinion”, Application No. PCT/US2011/055746, dated Sep. 27, 2012, 9 pages.
- “International Search Report and Written Opinion”, Application No. PCT/US2010/028553, Application Filing Date: Mar. 24, 2010, dated Nov. 9, 2010, 9 pages.
- “Internet Explorer Window Restrictions”, Retrieved from: [http://technet.microsoft.com/en-us/library/cc759517\(WS.10\).aspx](http://technet.microsoft.com/en-us/library/cc759517(WS.10).aspx) on Jun. 28, 2011, Microsoft TechNet, 5 pages.
- “Introduction to Windows 7”, <https://www.google.com/url?q=http://www.wright.edu/sites/default/files/page/attachements/windows7.pdf>, Jul. 1, 2010, 13 pages.
- “Introduction to Windows Touch”, Retrieved from: http://download.microsoft.com/download/a/d/f/adf1347d-08dc-41a4-9084-623b1194d4b2/Win7_touch.docx, Dec. 18, 2008, pp. 1-7.
- “iOS Human Interface Guidelines”, Apple Inc, Retrieved at <https://itunes.apple.com/in/book/ios-human-interface-guidelines/id877942287?mt=11>, Mar. 23, 2011, 2 pages.
- “iPad User Guide”, retrieved from http://cyndidannerkuhn.info/CDK/iPads_Resources_files/iPad_User_Guide.pdf on Jun. 17, 2011, 154 pages.
- “iPod touch User Guide for iPhone OS 3.0 Software”, Apple Inc., 2009, 153 pages.
- “jQuery & Css Example—Dropdown Menu”, DesignReviver, Retrieved from: <http://designreviver.com/tutorials/jquery-css-example-dropdown-menu/> on Nov. 22, 2011, Oct. 7, 2008, 30 pages.
- “KDE 4.0 Visual Guide: Desktop”, Retrieved From: <http://kde.org/announcements/4.0/desktop/php>, Nov. 23, 2011, 8 Pages.
- “Keyboard (5)”, Retrieved from: <http://landru.uwaterloo.ca/cgi-bin/man.cgi?section=5&topic=keyboard> on Dec. 11, 2008., Aug. 11, 1997, 8 Pages.
- “Keyboard Shortcuts”, Retrieved from: <http://www.pctoday.com/editorial/article.asp?article=articles%2F2005%2F0311%2F26t11%2F26t11.asp> on Aug. 3, 2009., Nov. 2005, 5 pages.
- “Kiosk Browser Chrome Customization Firefox 2.x”, Retrieved from: <http://stlouis-shopper.com/cgi-bin/mozdev-wiki/,pl?ChromeCustomization> on Oct. 22, 2008 Making a new chrome for the kiosk browser, Kiosk Project Kiosk Browser Chrome Customization Firefox-2.x, Aug. 16, 2007, 2 pages.
- “Live Photo Gallery—Getting Started—from Camera to Panorama”, Retrieved from: <http://webdotwiz.spaces.live.com/blog/cns!2782760752B93233!729.entry> on May 5, 2009., Sep. 2008, 7 Pages.
- “Magic mouse”, Retrieved from: <http://www.apple.com/magicmouse/> on May 10, 2011, 3 pages.
- “Manage Multiple Windows”, Retrieved From: <http://windows.microsoft.com/en-hk/windows/manage-multiple-windows#1TC=windows-7> Jul. 8, 2014, 4 Pages.
- “MIDTB Tip Sheet: Book Courier”, Retrieved from: <http://www.midtb.org/tipsbookcourier.htm> on Dec. 11, 2008., Sep. 26, 2005, 6 Pages.
- “Mobile/UI/Designs/TouchScreen/workingUI”, Retrieved from: <https://wiki.mozilla.org/Mobile/UI/Designs/TouchScreen/workingUI> on Oct. 26, 2009, 2009, 30 pages.
- “moGo beta v.0.4”, Retrieved from: <http://forum.xda-developers.com/showthread.php?t=375196> on Sep. 27, 2010, Mar. 7, 2008, 10 pages.
- “Multi-touch”, Retrieved from http://en.wikipedia.org/wiki/Multi-touch#Microsoft_Surface on Apr. 24, 2009, Apr. 17, 2009, 8 pages.
- “My Favorite Gadgets, System Monitor II”, Retrieved from <http://www.myfavoritegadgets.info/monitors/SystemMonitorII/systemmonitorII.html> on Mar. 12, 2013, Jun. 8, 2010, 5 pages.
- “New Features in WhatsUp Gold v12.0”, retrieved from <http://www.netbright.co.th/?name=product&file=readproduct&id=12> on Jun. 10, 2011, 4 pages.
- “New MS Courier Leak Details Multi-Touch Interface”, Retrieved from: <http://www.electronista.com/articles/09/11/04/courier.gestures.ui.explained/> on Nov. 10, 2009, Nov. 4, 2009, 9 pages.
- “Nokia E61 Tips and Tricks for Keyboard Shortcuts”, Retrieved from: <http://www.mobiletopsoft.com/board/1810/nokia-e61-tips-and-tricks-for-keyboard-shortcuts.html> on Dec. 17, 2008., Jan. 27, 2006, 2 Pages.
- “Non-Final Office Action”, U.S. Appl. No. 13/228,707, filed Oct. 25, 2013, 12 pages.
- “Non-Final Office Action”, U.S. Appl. No. 13/228,888, filed Feb. 10, 2014, 21 pages.
- “Non-Final Office Action”, U.S. Appl. No. 11/215,052, filed Jun. 23, 2011, 17 pages.
- “Non-Final Office Action”, U.S. Appl. No. 11/305,789, filed Sep. 21, 2009, 5 pages.
- “Non-Final Office Action”, U.S. Appl. No. 11/502,264, filed Sep. 30, 2009, 15 pages.
- “Non-Final Office Action”, U.S. Appl. No. 11/502,264, filed Sep. 14, 2012, 14 pages.

(56)

References Cited

OTHER PUBLICATIONS

- “Non-Final Office Action”, U.S. Appl. No. 12/244,545, filed Mar. 27, 2012, 18 pages.
- “Non-Final Office Action”, U.S. Appl. No. 12/244,545, filed Aug. 17, 2011, 15 pages.
- “Non-Final Office Action”, U.S. Appl. No. 12/413,977, filed Jul. 19, 2011, 17 pages.
- “Non-Final Office Action”, U.S. Appl. No. 12/413,977, filed Jul. 20, 2012, 18 pages.
- “Non-Final Office Action”, U.S. Appl. No. 12/414,382, filed Jul. 26, 2011, 9 pages.
- “Non-Final Office Action”, U.S. Appl. No. 12/414,434, filed Jan. 17, 2012, 7 pages.
- “Non-Final Office Action”, U.S. Appl. No. 12/414,434, filed May 31, 2012, 7 pages.
- “Non-Final Office Action”, U.S. Appl. No. 12/414,434, filed Aug. 2, 2011, 6 pages.
- “Non-Final Office Action”, U.S. Appl. No. 12/414,455, filed Aug. 29, 2011, 8 pages.
- “Non-Final Office Action”, U.S. Appl. No. 12/414,458, filed Jul. 6, 2011, 8 pages.
- “Non-Final Office Action”, U.S. Appl. No. 12/414,476, filed Nov. 9, 2012, 22 pages.
- “Non-Final Office Action”, U.S. Appl. No. 12/414,476, filed Aug. 3, 2011, 21 pages.
- “Non-Final Office Action”, U.S. Appl. No. 12/433,605, filed Jun. 24, 2011, 10 pages.
- “Non-Final Office Action”, U.S. Appl. No. 12/433,667, filed Jun. 7, 2011, 15 pages.
- “Non-Final Office Action”, U.S. Appl. No. 12/433,667, filed Feb. 3, 2012, 16 pages.
- “Non-Final Office Action”, U.S. Appl. No. 12/469,419, filed Nov. 9, 2011, 15 pages.
- “Non-Final Office Action”, U.S. Appl. No. 12/469,419, filed May 23, 2012, 13 pages.
- “Non-Final Office Action”, U.S. Appl. No. 12/469,458, filed Jul. 1, 2011, 15 pages.
- “Non-Final Office Action”, U.S. Appl. No. 12/469,458, filed Sep. 21, 2012, 14 pages.
- “Non-Final Office Action”, U.S. Appl. No. 12/469,480, filed Oct. 17, 2012, 16 pages.
- “Non-Final Office Action”, U.S. Appl. No. 12/469,480, filed Sep. 22, 2011, 14 pages.
- “Non-Final Office Action”, U.S. Appl. No. 12/470,558, filed Nov. 22, 2011, 9 pages.
- “Non-Final Office Action”, U.S. Appl. No. 12/472,699, filed Mar. 28, 2013, 10 pages.
- “Non-Final Office Action”, U.S. Appl. No. 12/472,699, filed Oct. 23, 2013, 14 pages.
- “Non-Final Office Action”, U.S. Appl. No. 12/472,699, filed Sep. 12, 2011, 12 pages.
- “Non-Final Office Action”, U.S. Appl. No. 12/480,969, filed Aug. 7, 2012, 15 pages.
- “Non-Final Office Action”, U.S. Appl. No. 12/484,799, filed Aug. 11, 2011, 12 pages.
- “Non-Final Office Action”, U.S. Appl. No. 12/484,799, filed Aug. 7, 2012, 13 pages.
- “Non-Final Office Action”, U.S. Appl. No. 12/484,845, filed Dec. 7, 2011, 16 pages.
- “Non-Final Office Action”, U.S. Appl. No. 12/560,081, filed Dec. 7, 2011, 16 pages.
- “Non-Final Office Action”, U.S. Appl. No. 12/577,400, filed Apr. 15, 2013, 25 pages.
- “Non-Final Office Action”, U.S. Appl. No. 12/577,400, filed Oct. 8, 2013, 24 pages.
- “Non-Final Office Action”, U.S. Appl. No. 12/577,400, filed Apr. 11, 2012, 22 pages.
- “Non-Final Office Action”, U.S. Appl. No. 12/695,842, filed May 22, 2013, 16 pages.
- “Non-Final Office Action”, U.S. Appl. No. 12/695,842, filed Oct. 3, 2012, 16 pages.
- “Non-Final Office Action”, U.S. Appl. No. 12/695,937, filed Apr. 25, 2012, 14 pages.
- “Non-Final Office Action”, U.S. Appl. No. 12/695,976, filed Sep. 11, 2012, 8 pages.
- “Non-Final Office Action”, U.S. Appl. No. 12/700,357, filed Jul. 2, 2012, 10 pages.
- “Non-Final Office Action”, U.S. Appl. No. 12/700,460, filed Jan. 13, 2012, 21 pages.
- “Non-Final Office Action”, U.S. Appl. No. 12/700,510, filed Feb. 7, 2012, 20 pages.
- “Non-Final Office Action”, U.S. Appl. No. 12/709,204, filed Jun. 6, 2013, 27 pages.
- “Non-Final Office Action”, U.S. Appl. No. 12/709,204, filed Nov. 20, 2013, 31 pages.
- “Non-Final Office Action”, U.S. Appl. No. 12/709,204, filed May 10, 2012, 20 pages.
- “Non-Final Office Action”, U.S. Appl. No. 12/709,245, filed May 30, 2013, 15 pages.
- “Non-Final Office Action”, U.S. Appl. No. 12/709,245, filed Nov. 30, 2011, 11 pages.
- “Non-Final Office Action”, U.S. Appl. No. 12/709,245, filed Mar. 21, 2012, 14 pages.
- “Non-Final Office Action”, U.S. Appl. No. 12/709,282, filed Feb. 28, 2013, 11 pages.
- “Non-Final Office Action”, U.S. Appl. No. 12/709,282, filed Oct. 10, 2013, 12 pages.
- “Non-Final Office Action”, U.S. Appl. No. 12/709,282, filed Apr. 12, 2012, 9 pages.
- “Non-Final Office Action”, U.S. Appl. No. 12/709,301, filed May 14, 2013, 14 pages.
- “Non-Final Office Action”, U.S. Appl. No. 12/709,301, filed Oct. 24, 2013, 11 pages.
- “Non-Final Office Action”, U.S. Appl. No. 12/709,301, filed Nov. 28, 2011, 9 pages.
- “Non-Final Office Action”, U.S. Appl. No. 12/709,301, filed Sep. 13, 2012, 13 pages.
- “Non-Final Office Action”, U.S. Appl. No. 12/709,348, filed Apr. 25, 2013, 15 pages.
- “Non-Final Office Action”, U.S. Appl. No. 12/709,348, filed Dec. 20, 2013, 9 pages.
- “Non-Final Office Action”, U.S. Appl. No. 12/709,348, filed Dec. 7, 2011, 12 pages.
- “Non-Final Office Action”, U.S. Appl. No. 12/709,348, filed Aug. 2, 2012, 14 pages.
- “Non-Final Office Action”, U.S. Appl. No. 12/709,376, filed May 23, 2013, 17 pages.
- “Non-Final Office Action”, U.S. Appl. No. 12/709,376, filed Jan. 23, 2012, 14 pages.
- “Non-Final Office Action”, U.S. Appl. No. 12/709,376, filed Aug. 17, 2012, 17 pages.
- “Non-Final Office Action”, U.S. Appl. No. 12/713,053, filed Nov. 23, 2012, 13 pages.
- “Non-Final Office Action”, U.S. Appl. No. 12/713,053, filed Feb. 3, 2012, 8 pages.
- “Non-Final Office Action”, U.S. Appl. No. 12/713,081, filed Nov. 29, 2012, 9 pages.
- “Non-Final Office Action”, U.S. Appl. No. 12/713,081, filed Dec. 23, 2011, 18 pages.
- “Non-Final Office Action”, U.S. Appl. No. 12/713,096, filed Jan. 30, 2014, 23 pages.
- “Non-Final Office Action”, U.S. Appl. No. 12/713,096, filed Jun. 26, 2013, 8 pages.
- “Non-Final Office Action”, U.S. Appl. No. 12/713,096, filed Jun. 6, 2012, 9 pages.
- “Non-Final Office Action”, U.S. Appl. No. 12/713,110, filed May 3, 2013, 10 pages.
- “Non-Final Office Action”, U.S. Appl. No. 12/713,110, filed Jun. 21, 2012, 21 pages.
- “Non-Final Office Action”, U.S. Appl. No. 12/713,113, filed Apr. 23, 2013, 18 pages.

(56)

References Cited

OTHER PUBLICATIONS

- “Non-Final Office Action”, U.S. Appl. No. 12/713,113, filed Dec. 22, 2011, 20 pages.
- “Non-Final Office Action”, U.S. Appl. No. 12/713,118, filed Jun. 8, 2012, 7 pages.
- “Non-Final Office Action”, U.S. Appl. No. 12/713,127, filed Jan. 31, 2014, 21 pages.
- “Non-Final Office Action”, U.S. Appl. No. 12/713,127, filed Dec. 27, 2011, 22 pages.
- “Non-Final Office Action”, U.S. Appl. No. 12/713,130, filed Jan. 16, 2013, 5 pages.
- “Non-Final Office Action”, U.S. Appl. No. 12/713,130, filed Jan. 23, 2012, 7 pages.
- “Non-Final Office Action”, U.S. Appl. No. 12/713,133, filed Jan. 14, 2013, 8 pages.
- “Non-Final Office Action”, U.S. Appl. No. 12/713,133, filed Jan. 31, 2012, 7 pages.
- “Non-Final Office Action”, U.S. Appl. No. 12/713,133, filed Dec. 10, 2013, 8 pages.
- “Non-Final Office Action”, U.S. Appl. No. 12/721,422, filed Oct. 1, 2012, 7 pages.
- “Non-Final Office Action”, U.S. Appl. No. 12/972,967, filed Jan. 30, 2013, 19 pages.
- “Non-Final Office Action”, U.S. Appl. No. 12/972,967, filed Nov. 6, 2014, 17 pages.
- “Non-Final Office Action”, U.S. Appl. No. 12/977,235, filed Feb. 4, 2016, 19 pages.
- “Non-Final Office Action”, U.S. Appl. No. 12/977,235, filed Jun. 24, 2014, 15 pages.
- “Non-Final Office Action”, U.S. Appl. No. 12/977,584, filed Dec. 7, 2012, 8 pages.
- “Non-Final Office Action”, U.S. Appl. No. 12/978,184, filed Jan. 23, 2013, 7 pages.
- “Non-Final Office Action”, U.S. Appl. No. 12/983,106, filed Sep. 10, 2014, 19 pages.
- “Non-Final Office Action”, U.S. Appl. No. 12/983,106, filed Nov. 9, 2012, 17 pages.
- “Non-Final Office Action”, U.S. Appl. No. 13/073,300, filed Apr. 30, 2015, 15 pages.
- “Non-Final Office Action”, U.S. Appl. No. 13/073,300, filed Jul. 25, 2013, 13 pages.
- “Non-Final Office Action”, U.S. Appl. No. 13/118,181, filed Mar. 4, 2013, 22 pages.
- “Non-Final Office Action”, U.S. Appl. No. 13/118,181, filed Oct. 23, 2015, 15 pages.
- “Non-Final Office Action”, U.S. Appl. No. 13/118,204, filed Feb. 28, 2013, 13 pages.
- “Non-Final Office Action”, U.S. Appl. No. 13/118,221, filed Mar. 1, 2013, 22 pages.
- “Non-Final Office Action”, U.S. Appl. No. 13/118,221, filed May 19, 2016, 14 pages.
- “Non-Final Office Action”, U.S. Appl. No. 13/118,221, filed Oct. 7, 2015, 8 pages.
- “Non-Final Office Action”, U.S. Appl. No. 13/118,257, filed Mar. 5, 2013, 19 pages.
- “Non-Final Office Action”, U.S. Appl. No. 13/118,265, filed Jun. 10, 2014, 13 pages.
- “Non-Final Office Action”, U.S. Appl. No. 13/118,265, filed Aug. 20, 2015, 18 pages.
- “Non-Final Office Action”, U.S. Appl. No. 13/118,288, filed Jul. 2, 2014, 17 pages.
- “Non-Final Office Action”, U.S. Appl. No. 13/118,288, filed Aug. 24, 2015, 19 pages.
- “Non-Final Office Action”, U.S. Appl. No. 13/118,292, filed Jun. 6, 2014, 25 pages.
- “Non-Final Office Action”, U.S. Appl. No. 13/118,292, filed Dec. 7, 2015, 32 pages.
- “Non-Final Office Action”, U.S. Appl. No. 13/118,302, filed Mar. 4, 2014, 10 pages.
- “Non-Final Office Action”, U.S. Appl. No. 13/118,302, filed Aug. 12, 2016, 34 pages.
- “Non-Final Office Action”, U.S. Appl. No. 13/118,302, filed Nov. 6, 2015, 21 pages.
- “Non-Final Office Action”, U.S. Appl. No. 13/118,314, filed Feb. 27, 2014, 13 pages.
- “Non-Final Office Action”, U.S. Appl. No. 13/118,314, filed Jun. 19, 2015, 23 pages.
- “Non-Final Office Action”, U.S. Appl. No. 13/118,314, filed Jun. 30, 2016, 16 pages.
- “Non-Final Office Action”, U.S. Appl. No. 13/118,321, filed Jun. 10, 2013, 32 pages.
- “Non-Final Office Action”, U.S. Appl. No. 13/118,321, filed Sep. 8, 2015, 34 pages.
- “Non-Final Office Action”, U.S. Appl. No. 13/118,321, filed Nov. 12, 2014, 33 pages.
- “Non-Final Office Action”, U.S. Appl. No. 13/118,333, filed Jul. 5, 2013, 18 pages.
- “Non-Final Office Action”, U.S. Appl. No. 13/118,339, filed Feb. 11, 2013, 15 pages.
- “Non-Final Office Action”, U.S. Appl. No. 13/118,339, filed Dec. 10, 2014, 16 pages.
- “Non-Final Office Action”, U.S. Appl. No. 13/118,347, filed Feb. 12, 2013, 14 pages.
- “Non-Final Office Action”, U.S. Appl. No. 13/118,347, filed Dec. 3, 2014, 28 pages.
- “Non-Final Office Action”, U.S. Appl. No. 13/196,272, filed Feb. 6, 2013, 10 pages.
- “Non-Final Office Action”, U.S. Appl. No. 13/196,272, filed Sep. 3, 2013, 5 pages.
- “Non-Final Office Action”, U.S. Appl. No. 13/224,258, filed Jan. 8, 2013, 35 pages.
- “Non-Final Office Action”, U.S. Appl. No. 13/228,707, filed Apr. 19, 2016, 26 pages.
- “Non-Final Office Action”, U.S. Appl. No. 13/228,707, filed Nov. 13, 2014, 20 pages.
- “Non-Final Office Action”, U.S. Appl. No. 13/228,876, filed Jan. 29, 2015, 18 pages.
- “Non-Final Office Action”, U.S. Appl. No. 13/228,876, filed May 12, 2016, 20 pages.
- “Non-Final Office Action”, U.S. Appl. No. 13/228,876, filed Nov. 22, 2013, 14 pages.
- “Non-Final Office Action”, U.S. Appl. No. 13/228,931, filed Mar. 24, 2016, 22 pages.
- “Non-Final Office Action”, U.S. Appl. No. 13/228,931, filed Apr. 7, 2014, 21 pages.
- “Non-Final Office Action”, U.S. Appl. No. 13/228,945, filed Jul. 21, 2016, 20 pages.
- “Non-Final Office Action”, U.S. Appl. No. 13/228,945, filed Apr. 14, 2014, 22 pages.
- “Non-Final Office Action”, U.S. Appl. No. 13/229,155, filed Jan. 7, 2015, 14 pages.
- “Non-Final Office Action”, U.S. Appl. No. 13/229,155, filed Nov. 18, 2013, 14 pages.
- “Non-Final Office Action”, U.S. Appl. No. 13/229,556, filed Mar. 28, 2014, 12 pages.
- “Non-Final Office Action”, U.S. Appl. No. 13/229,693, filed Mar. 12, 2013, 21 pages.
- “Non-Final Office Action”, U.S. Appl. No. 13/229,693, filed Apr. 23, 2015, 28 pages.
- “Non-Final Office Action”, U.S. Appl. No. 13/229,693, filed Jun. 20, 2014, 25 pages.
- “Non-Final Office Action”, U.S. Appl. No. 13/229,702, filed Jul. 3, 2014, 28 pages.
- “Non-Final Office Action”, U.S. Appl. No. 13/229,709, filed Apr. 7, 2014, 12 pages.
- “Non-Final Office Action”, U.S. Appl. No. 13/345,263, filed Oct. 24, 2013, 19 Pages.
- “Non-Final Office Action”, U.S. Appl. No. 13/345,383, filed Feb. 14, 2014, 26 pages.
- “Non-Final Office Action”, U.S. Appl. No. 13/345,383, filed Jan. 29, 2015, 5 pages.

(56)

References Cited

OTHER PUBLICATIONS

- “Non-Final Office Action”, U.S. Appl. No. 13/345,383, filed Feb. 28, 2013, 25 pages.
- “Non-Final Office Action”, U.S. Appl. No. 13/484,075, filed Jan. 15, 2013, 9 pages.
- “Non-Final Office Action”, U.S. Appl. No. 13/492,495, filed Dec. 19, 2012, 6 pages.
- “Non-Final Office Action”, U.S. Appl. No. 13/492,495, filed Sep. 17, 2012, 8 pages.
- “Non-Final Office Action”, U.S. Appl. No. 13/550,432, filed Apr. 27, 2015, 15 pages.
- “Non-Final Office Action”, U.S. Appl. No. 13/550,432, filed Jun. 16, 2016, 18 pages.
- “Non-Final Office Action”, U.S. Appl. No. 13/598,422, filed Feb. 21, 2014, 31 pages.
- “Non-Final Office Action”, U.S. Appl. No. 13/598,422, filed Mar. 5, 2015, 17 pages.
- “Non-Final Office Action”, U.S. Appl. No. 13/655,386, filed Dec. 26, 2012, 23 pages.
- “Non-Final Office Action”, U.S. Appl. No. 13/655,390, filed Dec. 17, 2012, 12 pages.
- “Non-Final Office Action”, U.S. Appl. No. 13/656,354, filed Feb. 6, 2013, 10 pages.
- “Non-Final Office Action”, U.S. Appl. No. 13/656,574, filed Jan. 31, 2013, 21 pages.
- “Non-Final Office Action”, U.S. Appl. No. 13/656,639, filed Feb. 7, 2013, 29 pages.
- “Non-Final Office Action”, U.S. Appl. No. 13/657,621, filed Feb. 7, 2013, 19 pages.
- “Non-Final Office Action”, U.S. Appl. No. 13/657,621, filed Jul. 18, 2014, 22 pages.
- “Non-Final Office Action”, U.S. Appl. No. 13/657,646, filed Aug. 12, 2014, 14 pages.
- “Non-Final Office Action”, U.S. Appl. No. 13/657,646, filed Jan. 3, 2013, 13 pages.
- “Non-Final Office Action”, U.S. Appl. No. 13/657,789, filed Jan. 9, 2013, 38 pages.
- “Non-Final Office Action”, U.S. Appl. No. 13/658,694, filed Feb. 13, 2014, 19 pages.
- “Non-Final Office Action”, U.S. Appl. No. 13/658,694, filed Apr. 26, 2013, 13 pages.
- “Non-Final Office Action”, U.S. Appl. No. 13/658,694, filed Aug. 14, 2014, 26 pages.
- “Non-Final Office Action”, U.S. Appl. No. 14/059,163, filed Aug. 10, 2015, 5 pages.
- “Non-Final Office Action”, U.S. Appl. No. 14/089,149, filed Nov. 3, 2014, 8 pages.
- “Non-Final Office Action”, U.S. Appl. No. 14/109,779, filed Nov. 21, 2014, 9 pages.
- “Non-Final Office Action”, U.S. Appl. No. 14/448,911, filed Oct. 31, 2016, 22 pages.
- “Non-Final Office Action”, U.S. Appl. No. 14/448,946, filed Oct. 27, 2016, 17 pages.
- “Non-Final Office Action”, U.S. Appl. No. 14/522,420, filed Apr. 22, 2016, 21 pages.
- “Non-Final Office Action”, U.S. Appl. No. 14/522,420, filed Aug. 15, 2016, 20 pages.
- “Non-Final Office Action”, U.S. Appl. No. 14/659,442, filed Jul. 7, 2015, 7 pages.
- “Non-Final Office Action”, U.S. Appl. No. 14/850,347, filed Jun. 16, 2016, 26 pages.
- “Non-Final Office Action”, U.S. Appl. No. 14/918,358, filed Oct. 13, 2016, 9 pages.
- “Non-Final Office Action”, U.S. Appl. No. 14/918,359, filed Nov. 22, 2016, 9 pages.
- “Non-Final Office Action”, U.S. Appl. No. 14/919,607, dated Sep. 23, 2016, 11 pages.
- “Normalizing Text: A Java Tutorial by Oracle”, Retrieved from: <<http://docs.oracle.com/javase/tutorial/i18n/text/normalizerapi.html>> on Apr. 8, 2014, Nov. 11, 2006, 3 pages.
- “Notice of Allowance”, U.S. Appl. No. 11/215,052, filed Mar. 14, 2012, 5 pages.
- “Notice of Allowance”, U.S. Appl. No. 11/305,789, filed Nov. 23, 2009, 8 pages.
- “Notice of Allowance”, U.S. Appl. No. 12/414,382, filed Apr. 4, 2012, 4 pages.
- “Notice of Allowance”, U.S. Appl. No. 12/414,434, filed Aug. 17, 2012, 4 pages.
- “Notice of Allowance”, U.S. Appl. No. 12/414,455, filed Jan. 4, 2012, 4 pages.
- “Notice of Allowance”, U.S. Appl. No. 12/414,458, filed Oct. 31, 2011, 2 pages.
- “Notice of Allowance”, U.S. Appl. No. 12/414,458, filed Nov. 29, 2011, 2 pages.
- “Notice of Allowance”, U.S. Appl. No. 12/414,458, filed Aug. 10, 2011, 6 pages.
- “Notice of Allowance”, U.S. Appl. No. 12/470,558, filed Apr. 2, 2012, 7 pages.
- “Notice of Allowance”, U.S. Appl. No. 12/470,558, filed Aug. 23, 2012, 2 pages.
- “Notice of Allowance”, U.S. Appl. No. 12/472,699, filed May 2, 2014, 6 pages.
- “Notice of Allowance”, U.S. Appl. No. 12/484,799, filed Oct. 22, 2012, 10 pages.
- “Notice of Allowance”, U.S. Appl. No. 12/484,845, filed Mar. 16, 2012, 5 pages.
- “Notice of Allowance”, U.S. Appl. No. 12/695,064, filed Mar. 28, 2012, 12 pages.
- “Notice of Allowance”, U.S. Appl. No. 12/695,959, filed Apr. 17, 2012, 13 pages.
- “Notice of Allowance”, U.S. Appl. No. 12/713,053, filed Jun. 7, 2013, 7 pages.
- “Notice of Allowance”, U.S. Appl. No. 12/713,110, dated Dec. 4, 2013, 13 pages.
- “Notice of Allowance”, U.S. Appl. No. 12/713,130, dated Feb. 19, 2013, 5 pages.
- “Notice of Allowance”, U.S. Appl. No. 12/713,133, dated Jan. 17, 2014, 4 pages.
- “Notice of Allowance”, U.S. Appl. No. 12/721,422, dated Jul. 11, 2013, 9 pages.
- “Notice of Allowance”, U.S. Appl. No. 12/977,584, dated Jun. 19, 2013, 5 pages.
- “Notice of Allowance”, U.S. Appl. No. 12/978,184, dated Nov. 6, 2013, 5 pages.
- “Notice of Allowance”, U.S. Appl. No. 12/978,184, dated Aug. 2, 2013, 5 pages.
- “Notice of Allowance”, U.S. Appl. No. 12/983,106, dated Jun. 6, 2016, 17 pages.
- “Notice of Allowance”, U.S. Appl. No. 13/073,300, dated Feb. 12, 2016, 9 pages.
- “Notice of Allowance”, U.S. Appl. No. 13/118,204, dated Jul. 8, 2014, 8 pages.
- “Notice of Allowance”, U.S. Appl. No. 13/118,333, dated May 4, 2015, 16 pages.
- “Notice of Allowance”, U.S. Appl. No. 13/118,339, dated Mar. 31, 2015, 7 pages.
- “Notice of Allowance”, U.S. Appl. No. 13/118,347, dated Apr. 1, 2015, 7 pages.
- “Notice of Allowance”, U.S. Appl. No. 13/196,272, dated Nov. 8, 2013, 8 pages.
- “Notice of Allowance”, U.S. Appl. No. 13/228,931, dated Sep. 23, 2016, 10 pages.
- “Notice of Allowance”, U.S. Appl. No. 13/229,556, dated Sep. 2, 2014, 12 pages.
- “Notice of Allowance”, U.S. Appl. No. 13/229,693, dated Sep. 14, 2015, 13 pages.
- “Notice of Allowance”, U.S. Appl. No. 13/229,702, dated Apr. 29, 2015, 7 pages.
- “Notice of Allowance”, U.S. Appl. No. 13/229,709, dated Sep. 2, 2014, 4 pages.
- “Notice of Allowance”, U.S. Appl. No. 13/345,383, dated May 18, 2015, 5 pages.

(56)

References Cited

OTHER PUBLICATIONS

- “Notice of Allowance”, U.S. Appl. No. 13/492,495, dated Apr. 26, 2013, 5 pages.
- “Notice of Allowance”, U.S. Appl. No. 13/655,386, dated Apr. 25, 2014, 6 pages.
- “Notice of Allowance”, U.S. Appl. No. 13/655,390, dated May 24, 2013, 5 pages.
- “Notice of Allowance”, U.S. Appl. No. 13/656,574, dated Sep. 23, 2014, 7 pages.
- “Notice of Allowance”, U.S. Appl. No. 13/656,639, dated Aug. 19, 2013, 14 pages.
- “Notice of Allowance”, U.S. Appl. No. 13/657,621, dated Aug. 26, 2016, 9 pages.
- “Notice of Allowance”, U.S. Appl. No. 13/657,646, dated Feb. 6, 2015, 15 pages.
- “Notice of Allowance”, U.S. Appl. No. 13/657,789, dated Aug. 4, 2014, 16 pages.
- “Notice of Allowance”, U.S. Appl. No. 13/658,694, dated Jan. 7, 2016, 20 pages.
- “Notice of Allowance”, U.S. Appl. No. 14/059,163, dated Apr. 25, 2016, 7 pages.
- “Notice of Allowance”, U.S. Appl. No. 14/089,149, dated Dec. 5, 2014, 4 pages.
- “Notice of Allowance”, U.S. Appl. No. 14/109,779, dated Jun. 17, 2015, 4 pages.
- “Notice of Allowance”, U.S. Appl. No. 14/659,442, dated Aug. 19, 2015, 4 pages.
- “Notifications”, retrieved from <<http://msdn.microsoft.com/en-us/library/aa511497.aspx>> on May 10, 2011, 16 pages.
- “OmneMon™ System Resource Metrics”, retrieved from <http://www.omnesys.com/documents/OmneMonSRM_Brochure.pdf> on Jun. 10, 2011, 3 pages.
- “ONYX Graphics Announces New ONYX Prepedge Job Preparation Software”, retrieved from <<http://www.largeformatreview.com/rip-software/433-onyx-graphics-announces-new-onyx->> on May 10, 2011, 2 pages.
- “Oracle Mobile Sales Assistant User Guide for BlackBerry”, Retrieved from <http://download.oracle.com/docs/cd/E12547_01/books/PDF/MobileSalesAsstBB.pdf>, Nov. 2008, 20 pages.
- “Oracle8i Application Developer’s Guide—Advanced Queuing Release 2 (8.1.6)”, Retrieved from: <http://www.cs.otago.ac.nz/oradocs/appdev.817/a76938/adq01in5.htm> on May 6, 2009., Dec. 1999, 8 pages.
- “Oracle8i Application Developer’s Guide—Advanced Queuing”, Retrieved from: http://www.cs.umbc.edu/help/oracle8/server.815/a68005/03_adqli.htm on May 6, 2009., Feb. 1999, 29 Pages.
- “Oracle8i Concepts Release 8.1.5”, Retrieved from: <http://www.cs.umbc.edu/help/oracle8/server.815/a67781/c16queue.htm> on May 6, 2009., Feb. 1999, 10 Pages.
- “Organize Your Desktop Workspace for More Comfort with WindowSpace”, Retrieved From: <<http://www.ntwind.com/software/windowspace.html>> Jul. 4, 2014, Sep. 19, 2008, 5 Pages.
- “Palette Extender 1.0.2”, Retrieved from: <<http://palette-extender.en.softonic.com/symbian>> on Nov. 6, 2008, Jan. 21, 2003, 2 pages.
- “Parallax Scrolling”, Retrieved from: <http://en.wikipedia.org/wiki/Parallax_scrolling> on May 5, 2009., May 4, 2009, 3 Pages.
- “Push Notifications Overview for Windows Phone”, Retrieved from: <<http://msdn.microsoft.com/en-us/library/ff402558%28VS.92%29.aspx>> on Sep. 30, 2010, Sep. 3, 2010, 1 page.
- “QPinchGesture Class Reference”, Retrieved from <<http://doc.qt.digia.com/4.6/qpinchgesture.html>> on May 28, 2014, 2010, 6 pages.
- “Remapping the Keyboard”, Retrieved from: <<http://publib.boulder.ibm.com/infocenter/hodhelp/v9r0/index.jsp?topic=/com.ibm.hod9.doc/help/assignkey.html>> on Dec. 11, 2008., Jul. 15, 2005, 5 Pages.
- “Rename a file”, Retrieved from <<http://windows.microsoft.com/en-us/windows7/rename-a-file>> on Apr. 27, 2015, Aug. 24, 2009, 1 page.
- “Restriction Requirement”, U.S. Appl. No. 13/118,265, dated Feb. 27, 2014, 7 pages.
- “Restriction Requirement”, U.S. Appl. No. 13/118,288, dated Mar. 4, 2014, 7 pages.
- “Restriction Requirement”, U.S. Appl. No. 13/658,694, dated Feb. 6, 2013, 6 pages.
- “Samsung Galaxy 2 TouchWiz 4.0 Tour (Homescreen, Settings, etc)”, <https://www.youtube.com/watch?v=oXBbiy0Adiw>, May 9, 2011, 3 pages.
- “Search Report”, CN Application No. 201110437551.0, dated Dec. 23, 2013, 2 pages.
- “Search Report”, TW Application No. 100136568, dated Sep. 14, 2015, 2 pages.
- “Second Written Opinion”, Application No. PCT/US2015/048751, dated Jul. 12, 2016, 5 pages.
- “SecureMe-Anti-Theft Security Application for S60 3rd”, Retrieved from: <<http://www.killermobile.com/newsite/mobile-software/s60-applications/secureme-%11-anti%11theft-security-application-for-s60-3rd.htm>> on Jun. 28, 2011, Dec. 15, 2008, 3 pages.
- “Shottrack for Windows VoD Software Analysis”, Retrieved From: http://www.matrixconsult.com.au/MATRIX_Web_Files/ShotTrack_Software_Manual.pdf, Nov. 23, 2011, 47 Pages.
- “SizeUp The Missing Window Manager”, Retrieved From: <<https://www.irradiatedsoftware.com/sizeup/>> Jul. 4, 2014, Jan. 17, 2013, 4 Pages.
- “Snap”, Windows 7 Features—retrieved from <<http://windows.microsoft.com/en-US/windows7/products/features/snap>> on Sep. 23, 2011, 2 pages.
- “Split the Windows® Desktop: How to Divide a Single Large Desktop into Multiple Smaller Ones”, retrieved from <<http://www.actualtools.com/multiplemonitors/split-windows-desktop-how-to-divide-single-large-desktop-into-smaller-ones.shtml>> on Jul. 7, 2014, Apr. 10, 2014, 3 pages.
- “Supplemental Notice of Allowance”, U.S. Appl. No. 12/713,133, dated Feb. 3, 2014, 2 pages.
- “Supplemental Notice of Allowance”, U.S. Appl. No. 12/977,584, dated Sep. 16, 2013, 2 pages.
- “Supplemental Notice of Allowance”, U.S. Appl. No. 12/977,584, dated Oct. 11, 2013, 2 pages.
- “Supplemental Notice of Allowance”, U.S. Appl. No. 12/978,184, dated Feb. 25, 2014, 2 pages.
- “Supplemental Notice of Allowance”, U.S. Appl. No. 13/118,204, dated Sep. 10, 2014, 2 pages.
- “Supplemental Notice of Allowance”, U.S. Appl. No. 13/118,204, dated Oct. 2, 2014, 2 pages.
- “Supplemental Notice of Allowance”, U.S. Appl. No. 13/118,204, dated Oct. 23, 2014, 3 pages.
- “Supplemental Notice of Allowance”, U.S. Appl. No. 13/655,390, dated Sep. 19, 2013, 2 pages.
- “Supplemental Notice of Allowance”, U.S. Appl. No. 13/655,390, dated Jul. 25, 2013, 2 pages.
- “Supplemental Notice of Allowance”, U.S. Appl. No. 13/656,574, dated Feb. 25, 2015, 4 pages.
- “Supplemental Notice of Allowance”, U.S. Appl. No. 14/089,149, dated Mar. 20, 2015, 2 pages.
- “Supplementary European Search Report”, EP Application No. 11747907.1, dated Nov. 7, 2012, 3 pages.
- “Supplementary European Search Report”, EP Application No. 11748027.7, dated Nov. 29, 2012, 3 pages.
- “Supplementary European Search Report”, EP Application No. 11748028.5, dated Nov. 7, 2012, 3 pages.
- “Supplementary European Search Report”, European Patent Application No. 10823883.3, dated Jul. 31, 2012, 3 pages.
- “Symbian Applications”, Retrieved from: <http://symbianfullversion.blogspot.com/2008_12_01_archive.html> on May 5, 2009., Jan. 2009, 51 Pages.
- “The Map Screen”, retrieved from <<http://www.symbianos.org/whereamiusersguide>> on Jun. 17, 2011, 3 pages.
- “The Start Menu (overview)”, retrieved from <<http://web.archive.org/web/20101219151141/http://www.windows.microsoft.com/en-US/windows-vista/The-Start-menu-overview>> on Feb. 12, 2013, Dec. 19, 2010, 5 pages.
- “ThumbJot”, Retrieved form <http://thumbjot.com/wp/?page_id=8>, 2008, 2 pages.
- “Top 3 Task Switchers for Android”, TechCredo—retrieved from <<http://www.techcredo.com/android/top-3-task-switchers-for-android>> on May 11, 2011, Mar. 9, 2011, 5 pages.

(56)

References Cited

OTHER PUBLICATIONS

“Top Android App: Swipepad”, Best Android Apps Review—retrieved from <<http://www.bestandroidappsreview.com/2011/01/top-android-app-swipepad-launcher.html>> on May 11, 2011, 4 pages.

“Touch Shell Free”, Retrieved from: <<http://www.pocketpcfreeware.mobi/download-touch-shell-free.html>> on May 5, 2009., Feb. 23, 2009, 2 Pages.

“UI Guidelines Version 2.1”, Retrieved from: http://na.blackberry.com/eng/deliverables/6622/BlackBerry_Smartphones-US.pdf, 76 Pages.

“User Guide”, retrieved from <<http://wireframesketcher.com/help/help.html>> on Jun. 17, 2011, 19 pages.

“Vista—User Experiences: Site-Centric Browsing on Windows”, retrieved from <<http://www.vistax64.com/vista-news/283040-user-experiences-site-centric-browsing-windows.html>> on Sep. 28, 2010, 6 pages.

“What You Should Expect from the Windows 7 Beta”, Retrieved From: <http://www.howtogeek.com/howto/the-geek-blog/what-you-should-expect-from-the-windows-7-beta/>, Nov. 23, 2011, 17 Pages.

“Window Desktop”, Retrieved From: <http://pjohnicholson.com/windowsdesktop.htm>, Nov. 23, 2011, 4 Pages.

“Window Frames”, MSDN, retrieved from <<http://msdn.microsoft.com/en-us/library/aa974173.aspx>> on Sep. 28, 2010, 7 pages.

“Window Magnet”, Retrieved From: <<http://magnet.crowdcafe.com/>> Jul. 4, 2014, Jun. 23, 2011, 2 Pages.

“Windows 8 Is Gorgeous, But Is It More Than Just A Shell? (Video)”, retrieved from <<http://techcrunch.com/2011/06/02/windows-8-gorgeous-shell-video/>> on Jun. 20, 2011, Jun. 2, 2011, 6 pages.

“Windows Phone 7 (Push Notification)”, retrieved from <<http://unknownerror.net/2011-06/windows-phone-7-push-notification-36520>> on Jul. 6, 2011, 4 pages.

“Windows Phone 7 Live Tiles”, Retrieved from: <http://www.knowyourmobile.com/microsoft/windowsphone7/startscreen/640737/windows_phone_7_live_tiles.html> on May 11, 2011, Oct. 20, 2010, 3 pages.

“Winterface Review”, Retrieved from: <<http://www.mytodayscreen.com/winterface-review/>> on Nov. 12, 2008, Jul. 9, 2008, 42 pages.

“Womma”, Retrieved from: <<http://www.womma.org/blog/links/wom-trends/>> on May 5, 2009., 2007, 70 Pages.

“Working with Multiple Windows”, MSOFFICE tutorial!—retrieved from <<http://www.msoffice-tutorial.com/working-with-multiple-windows.php>> on Sep. 23, 2011, 3 pages.

“Working with Windows”, Retrieved From: http://h30097.www3hp.com/docs/base_doc/documentation/F40F_html/AQ917BTE/docu_004.htm, Nov. 23, 2011, 14 pages.

“Working with Windows”, Retrieved From: <<http://windows.microsoft.com/en-us/windows/working-with-windows#1TC=windows-7>> Jul. 4, 2014, 10 Pages.

“You’ve Got Mail 1.4 Build”, retrieved from <[http://www.fileshome.com/Shows_Animation_Plays_Sound_Automatic_N...>](http://www.fileshome.com/Shows_Animation_Plays_Sound_Automatic_N...) on Jan. 6, 2010, Jun. 18, 2007, 2 pages.

“YUI 3: ScrollView [beta]”, Retrieved from: <<http://developer.yahoo.com/yui/3/scrollview/>> on Sep. 28, 2010, 5 pages.

Alexander, “MeeGo Basics”, retrieved from <<http://meego.com/developers/ui-design-guidelines/handset/meego-basics>> on Sep. 28, 2010, Jun. 29, 2010, 8 pages.

Anson, “Pining for Windows Phone 7 controls? We got ya covered! [Announcing the first release of the Silverlight for Windows Phone Toolkit!]”, Retrieved from <<http://blogs.msdn.com/b/delay/archive/2010/09/16/pining-for-windows-phone-7-controls-we-got-ya-covered-announcing-the-first-release-of-the-silverlight-for-windows-phone-toolkit.aspx>> on May 30, 2014, Sep. 16, 2010, 17 pages.

Appleinsider, “Special Report: Apple’s Touch-Sensitive iPod Ambitions Disclosed in Filing”, Retrieved from: <http://www.appleinsider.com/articles/06/10/26/special_report_apples_touch_sensitive_ipod_ambitions_disclosed_in_filing.html> on Nov. 11, 2009, Oct. 26, 2006, 10 pages.

Ashraf, “Winsplit Revolution: Tile, Resize, and Position Windows for Efficient Use of Your Screen”, Retrieved From: <<http://dottech.org/11240/winsplit-revolution-tile-resize-and-position-windows-for-efficient-use-of-your-screen/>> Jul. 8, 2014, Dec. 18, 2011, 4 Pages.

Banerjee, “Using Facebook, Twitter and Google Plus from a Single Browser Tab—A Complete Guide”, Retrieved from: <<http://www.ampercent.com/post-to-google-plus-facebook-twitter-one-location/9597/>> on Feb. 15, 2012, Aug. 3, 2011, 11 pages.

Bates, “A Framework to Support Large-Scale Active Applications”, University of Cambridge Computer Laboratory—Available at <<http://citeseerx.ist.psu.edu/viewdoc/download?doi=10.1.1.48.1690&rep=rep1&type=pdf>>, 1996, 8 pages.

Bederson, “Implementing a Zooming User Interface: Experience Building Pad++”, Software Practice & Experience, Wiley & Sons, Aug. 1998, 34 pages.

Bederson, “Jazz: An Extensible Zoomable User Interface Graphics Toolkit in Java”, Proceedings of the 2000 ACM SIGCPR Conference, Apr. 2000, 11 pages.

Beiber, “Screen Coverage: A Pen-Interaction Problem for PDA’s and Touch Screen Computers”, In Proceedings of ICWMC 2007, Mar. 2007, 6 pages.

Bjork, “Redefining the Focus and Context of Focus+Context Visualizations”, In Proceedings of INFOVIS 2000—Available at <<http://www.johan.redstrom.se/papers/redefining.pdf>>, Oct. 2000, 9 pages.

Bowes, “Transparency for Item Highlighting”, Faculty of Computing Science, Dalhousie University—Available at <<http://torch.cs.dal.ca/~dearman/pubs/GI2003-bowes,dearman.perkins-paper.pdf>>, 2003, 2 pages.

Brandl, “Combining and Measuring the Benefits of Bimanual Pen and Direct-Touch Interaction on Horizontal Interfaces”, Retrieved from: <<http://www.merl.com/papers/docs/TR2008-054.pdf>> on Nov. 5, 2009, Mitsubishi Electric Research Laboratories, May 2008, 10 pages.

Bruzzese, “Using Windows 7, Managing and Monitoring Windows 7—Chapter 11”, Que Publishing, May 5, 2010, 33 pages.

Budiu, “Usability of iPad Apps and Websites”, Retrieved at <<https://tdougher.expressions.syr.edu/wrt307fall12/files/2012/08/ipad-usability_report_1st-edition-1.pdf>>, Dec. 31, 2010, 98 pages.

Buring, “User Interaction with Scatterplots on Small Screens—A Comparative Evaluation of Geometric-Semantic Zoom and Fisheye Distortion”, IEEE Transactions on Visualization and Computer Graphics, vol. 12, Issue 5, Available at <<http://citeseerx.ist.psu.edu/viewdoc/download?doi=10.1.1.134.4568&rep=rep1&type=pdf>>, Sep. 2006, pp. 829-836.

Camick, “Wrap Layout”, Java Tips Weblog, retrieved from <<https://tips4java.wordpress.com/2008/11/06/wrap-layout/>> on Jan. 11, 2015, Nov. 6, 2008, 28 pages.

Carrera, “Conserving Disk Energy in Network Servers”, available at <<http://citeseerx.ist.psu.edu/viewdoc/download?doi=10.1.1.6.8301&rep=rep1&type=ps>>, Nov. 2002, 15 pages.

Cawley, “How to Customize Your Windows Phone 7”, Retrieved from: <<http://www.brighthub.com/mobile/windows-mobile-platform/articles/95213.aspx>> on May 10, 2011, Nov. 12, 2010, 3 pages.

Cawley, “Windows Phone 7 Customization Tips and Tricks”, retrieved from <<http://www.brighthub.com/mobile/windows-mobile-platform/articles/95213.aspx>> on Jun. 20, 2011, May 16, 2011, 2 pages.

Cohen, “Automatic Strategies in the Siemens RTL Tiled Window Manager”, In Proceedings: The 2nd IEEE Conference on Computer Workstations, Mar. 7, 1988, pp. 111-119.

Cohen, “Wang Tiles for Image and Texture Generation”, In Proceedings of SIGGRAPH 2003—Available <<http://research.microsoft.com/en-us/um/people/cohen/WangFinal.pdf>>, 2003, 8 pages.

D, “Android Apps in Depth—02—Go Launcher EX”, https://www.youtube.com/watch?v=u5LISE8BU_E, Mar. 6, 2011, 3 pages.

D, “Android HTC EVO 4G Tutorials 01—Getting Started, Home Screens”, <https://www.youtube.com/watch?v=fwvt-rsCMA8>, Feb. 3, 2011, 3 pages.

Damien, “7 Ways to Supercharge Multitasking in Android”, retrieved from <<http://maketecheasier.com/7-ways-to-supercharge-multitasking-in-android/2011/01/22/>> on May 11, 2011, Jan. 22, 2011, 5 pages.

Daniels, “Brave New World”, Retrieved from: <http://bookseller-association.blogspot.com/2009_03_01_archive.html> on Nov. 10, 2009, Mar. 2009, 54 pages.

Danish, “Win7sé Brings Mac-Like Screen Corners to Windows 7 & Windows 8”, retrieved from <<http://technomondo.com/2011/11/13/win7se-brings-mac-like-screen-corners-to-windows-7-windows8/>> on Nov. 23, 2011, Nov. 13, 2011, 4 pages.

(56)

References Cited

OTHER PUBLICATIONS

Davis, "A WPF Custom Control for Zooming and Panning", Retrieved from: <<http://www.codeproject.com/KB/WPF/zoomandpancontrol.aspx>> on Sep. 28, 2010, Jun. 29, 2010, 21 pages.

Delimarsky, "Sending Tile Push Notifications on Windows Phone 7", retrieved from <<http://mobile.dzone.com/articles/sending-tile-push>> on May 10, 2011, Aug. 25, 2010, 2 pages.

Demers, "In Depth: GO Launcher EX—Droid Life", <http://www.droid-life.com/2011/01/26/in-depth-go-launcher-ex/>, Jan. 26, 2011, 8 pages.

Denoue, "WebNC: Efficient Sharing of Web Applications", In Proceedings of WWW 2009—Available at <<http://www.fxpal.com/publications/FXPAL-PR-09-495.pdf>>, 2009, 2 pages.

Dixon, "Living in the Online Cloud: The T-Mobile G1 / Google Android Smartphone", Retrieved from <http://www.manifest-tech.com/media_pda/t-mobile_g1_android.htm>, Dec. 2008, 3 pages.

Dolcourt, "Webware", Retrieved from: <<http://news.cnet.com/webware/?categoryid=2010>> on May 5, 2009., May 5, 2009, 13 Pages.

Dunsmuir, "Selective Semantic Zoom of a Document Collection", Available at <<http://www.cs.ubc.ca/~tmm/courses/533/projects/dustin/proposal.pdf>>, Oct. 30, 2009, pp. 1-9.

Elliott, "First Dell, Then HP: What's Next for N-trig's Multitouch Screen Technology", Retrieved from: <http://news.cnet.com/8301-17938_105-10107886-1.html> on Nov. 11, 2009, Nov. 25, 2008, 5 pages.

Emigh, "Lenovo Launches Windows 7 ThinkPads with Multitouch and Outdoor Screens", Retrieved from: <<http://www.betanews.com/article/Lenovo-launches-Windows-7-ThinkPads-with-multitouch-and-outdoor-screens/1253017166>> on Nov. 11, 2009, Sep. 15, 2009, 3 pages.

Farrugia, "Cell Phone Mini Challenge: Node-Link Animation Award Animating Multivariate Dynamic Social Networks", IEEE Symposium on Visual Analytics Science and Technology, Columbus, OH, USA, Oct. 21-23, 2008, Oct. 21, 2008, 2 pages.

Fisher, "Cool Discussion of Push Notifications—Toast and Tile—on Windows Phone", Retrieved from: <<http://www.windowsphoneexpert.com/Connection/forums/p/4153/18399.aspx>> on Sep. 29, 2010, May 3, 2010, 3 pages.

Gade, "Samsung Alias u740", Retrieved from: <<http://www.mobiletechreview.com/phones/Samsung-U740.htm>> on Nov. 20, 2008, Mar. 14, 2007, 6 pages.

Gao, "A General Logging Service for Symbian based Mobile Phones", Retrieved from: <http://www.nada.kth.se/utbildning/grukth/exjobb/rapportlister/2007/rapporter07/gao_rui_0_7132.pdf> on Jul. 17, 2008, Feb. 2007, pp. 1-42.

Gladisch, "MultiStates: Monitoring Databases With Acoustic and Intuitive Perspective Wall Interaction", In Proceedings of 2nd International Workshop on Design & Evaluation of e-Government Applications and Services, Aug. 24, 2009, 7 pages.

Gralla, "Windows XP Hacks, Chapter 13—Hardware Hacks", O'Reilly Publishing, Feb. 23, 2005, 25 pages.

Gross, "Stretch-A-Sketch: A Dynamic Diagrammer", IEEE Symposium on Visual Languages, Available at <<http://depts.washington.edu/dmachine/PAPER/VL94/v1.html>>, Oct. 1994, 11 pages.

Ha, "SIMKEYS: An Efficient Keypad Configuration for Mobile Communications", Retrieved from: <<http://ieeexplore.ieee.org/stamp/stamp.jsp?arnumber=01362557>> on Dec. 17, 2008, Nov. 2004, 7 Pages.

Harrison, "Symbian OS C++ for Mobile Phones vol. 3", Retrieved from: <<http://www.amazon.co.uk/Symbian-OS-Mobile-Phones-Press/dp/productdescription/0470066415>> on Oct. 23, 2008, Symbian Press, Jun. 16, 2003, 4 pages.

Hickey, "Google Android has Landed; T-Mobile, HTC Unveil G1", Retrieved from: <<http://www.crn.com/retail/210603348>> on Nov. 26, 2008., Sep. 23, 2008, 4 pages.

Hinckley, "Codex: A Dual Screen Tablet Computer", Conference on Human Factors in Computing Systems, Apr. 9, 2009, 10 pages.

Hinckley, "Stitching: Pen Gestures that Span Multiple Displays", CHI 2004, Available at <<http://www.cs.cornell.edu/~francois/Papers/2004-Hinckley-AVI04-Stitching.>>, 2004, pp. 1-8.

Hollister, "Windows 8 Primer: How to Navigate Microsoft's New Operating System", retrieved from <<http://www.theverge.com/2012/10/28/3562172/windows-8-gestures-keyboard-shortcuts-tips-tricks-how-to-guide>> on Aug. 7, 2014, Oct. 28, 2012, 30 pages.

Horowitz, "Installing and Tweaking Process Explorer part 2", Retrieved from <http://web.archive.org/web/20110510093838/http://blogs.computerworld.com/16165/installing_and_tweaking_process_explorer_part_2> on Mar. 12, 2013, May 23, 2010, 7 pages.

Janecek, "An Evaluation of Semantic Fisheye Views for Opportunistic Search in an Annotated Image Collection", Available at <<http://citeseerx.ist.psu.edu/viewdoc/download?doi=10.1.1.67.3084&rep=rep1&type=pdf>>, Feb. 15, 2005, pp. 1-15.

Jetter, "Materializing the Query with Facet-Streams—A Hybrid Surface for Collaborative Search on Tabletops", May 7, 2011, 10 pages.

Johnson, "Create an Awesome Zooming Web Page With jQuery", Retrieved from <<http://designshack.net/articles/javascript/create-an-awesome-zooming-web-page-with-jquery/>> on Aug. 20, 2015, May 25, 2011, 11 pages.

Johnson, "Samsung Galaxy Tab Pro 10.1 Review", Retrieved From: <<http://hothardware.com/Reviews/Samsung-Galaxy-Tab-Pro-101-Review/?page=3#!baG2DY>> Jul. 9, 2014, Mar. 21, 2014, 10 Pages.

Kandogan, "Elastic Windows: Improved Spatial Layout and Rapid Multiple Window Operations", In Proceedings of the Workshop on Advanced Visual Interfaces, May 27, 1996, 10 Pages.

Kcholi, "Windows CE .NET Interprocess Communication", Retrieved from <http://msdn.microsoft.com/en-us/library/ms836784.aspx> on Jul. 17, 2008., Jan. 2004, 15 Pages.

Keranen, "OpenGL-based User Interface Toolkit for Symbian Mobile Devices", Master of Science Thesis, Tamere University of Technology, Department of Information Technology, Apr. 6, 2005, 88 pages.

Kishore, "Split or Divide Your Desktop Screen into Multiple Parts", retrieved from <<http://www.online-tech-tips.com/free-software-downloads/split-or-divide-your-desktop-screen-into-multiple-parts/>> on Jul. 7, 2014, Oct. 18, 2008, 7 pages.

Krazit, "Has Apple Found the Magic Touch?", Retrieved from: <http://news.cnet.com/8301-13579_3-9879471-37.html> on Nov. 10, 2009, Feb. 26, 2008, 2 pages.

Kurdi, "Acer GridVista: snap your windows to pre-defined sections on your screen(s)", Retrieved from <<http://www.freewaregenius.com/acer-gridvista-snap-your-windows-to-pre-defined-sections-of-your-screens/>> on Jun. 30, 2013, Jan. 19, 2010, 6 pages.

Kurdi, "WinSplit Revolution", Retrieved from <<http://www.freewaregenius.com/winsplit-revolution/>> on Jun. 30, 2013, Aug. 22, 2007, 4 Pages.

La, "Parallax Gallery", Available at <<http://webdesignerwall.com/tutorials/parallax-gallery/comment-page-1>>, Apr. 25, 2008, 16 pages.

Livingston, "Windows 95 Secrets", 1995, I DG Books Worldwide, 3rd Edition, 1995, pp. 121-127.

Long, "Gmail Manager 0.6", Retrieved from: <<https://addons.mozilla.org/en-US/firefox/addon/1320/>> on Sep. 29, 2010, Jan. 27, 2010, 4 pages.

Mann, "Spectrum Analysis of Motion Parallax in a 3D Cluttered Scene and Application to Egomotion", Journal of the Optical Society of America A, vol. 22, No. 9—Available at <<http://www.cs.uwaterloo.ca/~mannr/snow/josa-mann-langer.pdf>>, Sep. 2005, pp. 1717-1731.

Mantia, "Multitasking: What Does It Mean?", retrieved from <<http://mantia.me/blog/multitasking/>> on Sep. 23, 2011, 3 pages.

Mao, "Comments of Verizon Wireless Messaging Services, LLC", Retrieved from: <http://www.ntia.doc.gov/osmhome/warnings/comments/verizon.htm> on May 6, 2009., Aug. 18, 2000, 5 Pages.

Marie, "MacBook Trackpad Four Fingers Swipe Left/Right to Switch Applications", MacBook Junkie—retrieved from <<http://www.macbookjunkie.com/macbook-trackpad-four-fingers-swipe-left-right-to-switch-applications/>> on May 11, 2011, Nov. 13, 2010, 4 pages.

(56)

References Cited

OTHER PUBLICATIONS

Mei, "Probabilistic Multimodality Fusion for Event Based Home Photo Clustering", Retrieved from: <<http://ieeexplore.ieee.org/stamp/stamp.jsp?tp=&arnumber=04036960>>, Dec. 26, 2006, pp. 1757-1760.

Minsky, "Manipulating Simulated Objects with Real-world Gestures using a Force and Position Sensitive Screen", Computer Graphics, vol. 18, No. 3, Available at <<http://delivery.acm.org/10.1145/810000/808598/p195-minsky.pdf?key1=808598&key2=2244955521&coll=GUIDE&dl=GUIDE&CFID=57828830&CFTOKEN=43421964>>, Jul. 1984, pp. 195-203.

Mullender, "Digital Dashboards: Web Parts Integrate with Internet Explorer and Outlook to Build Personal Portals", Retrieved from: <<http://technet.microsoft.com/en-us/query/bb985692>> on, Jan. 2001, 5 pages.

Muller, "MultiSplitPane: Splitting without Nesting", Java.net, retrieved from <<http://today.java.net/pub/a/today/2006/03/23/multi-split-pane.html>> on Mar. 23, 2006, Mar. 23, 2006, 6 pages.

Nordgren, "Development of a Touch Screen Interface for Scania Interactor", Master's Thesis in C—Available at <<http://www.es.umu.se/education/examina/Rapporter/PederNordgren.pdf>> omputing Science, UMEA University, Apr. 10, 2007, pp. 1-59.

Oliver, "Potential iPhone Usability and Interface Improvements", Retrieved from: <http://www.appleinsider.com/articles/08/09/18/potential_iphone_usability_and_interface_improvements.html> on Nov. 12, 2008, AppleInsider, Sep. 18, 2008, 4 pages.

Olwal, "Rubbing and Tapping for Precise and Rapid Selection on Touch-Screen Displays", Conference on Human Factors in Computing Systems, Available at <http://www.csc.kth.se/~alx/projects/research/rubbing/olwal_rubbing_tapping_chi_2008.pdf>, Apr. 2008, 10 pages.

O'Reilly, "How to Use the Microsoft Surface Touch Screen and Keyboard", Retrieved From: <<http://www.cnet.com/how-to/how-to-use-the-microsoft-surface-touch-screen-and-keyboard/>> Jul. 5, 2014, Nov. 6, 2012, 5 Pages.

Oryl, "Review: Asus P527 Smartphone for North America", Retrieved from: <<http://www.mobileburn.com/review.jsp?ld=4257>> on Dec. 17, 2008., Mar. 5, 2008, 1 Page.

Padilla, "Palm Treo 750 Cell Phone Review—Hardware", Retrieved from: <<http://www.wirelessinfo.com/content/palm-Treo-750-Cell-Phone-Review/Hardware.htm>> on Dec. 11, 2008., Mar. 17, 2007, 4 Pages.

Paul, "Hands-on: KDE 4.5 Launches with Tiling, New Notifications", Retrieved from: <<http://arstechnica.com/open-source/reviews/2010/08/hands-on-kde-45-launches-with-tiling-new-notifications.ars>> on Sep. 29, 10, Aug. 2010, 3 pages.

Paul, "Three Windows Multitasking Features That Help Maximize Your Screen Space", Retrieved From: <<http://www.pcworld.com/article/2094124/three-windows-multitasking-features-that-help-maximize-your-screen-space.html>> Jul. 4, 2014, Feb. 4, 2014, 4 Pages.

Perry, "Teach Yourself Windows 95 in 24 Hours", 1997, Sams Publishing, 2nd Edition, 1997, pp. 193-198.

Pierce, "Toolspaces and Glances: Storing, Accessing, and Retrieving Objects in 3D Desktop Applications", 1999 Symposium on Interactive 3D Graphics, Available at <<http://delivery.acm.org/10.1145/310000/300545/p163-pierce.pdf?key1=300545&key2=8792497521&coll=GUIDE&dl=GUIDE&CFID=61004073&CFTOKEN=28819248>>, Apr. 1999, pp. 163-168.

Raghaven, "Model Based Estimation and Verification of Mobile Device Performance", Available at http://alumni.cs.ucsb.edu/~raimisl/emsoft04_12.pdf., Sep. 27-29, 2004, 10 Pages.

Ray, "Microsoft Re-Tiles Mobile Platform for Windows 7 Era", retrieved from <http://www.theregister.co.uk/2010/02/15/windows_phone_7_series/> on May 11, 2011, Feb. 15, 2010, 2 pages.

Reed, "Microsoft Demos Windows Mobile 6.1 at CTIA", Retrieved from: <<http://www.networkworld.com/news/2008/040208-ctia-microsoft-windows-mobile.html>> on Jul. 18, 2008, Apr. 2, 2008, 1 page.

Remond, "Mobile Marketing Solutions", Retrieved from: <http://www.mobilemarketingmagazine.co.uk/mobile_social_networking/> on May 5, 2009., Apr. 28, 2009, 16 Pages.

Rice, "A System for Searching Sound Palettes", Proceedings of the Eleventh Biennial Symposium on Arts and Technology., Available at <<http://www.comparisonics.com/FindSoundsPalettePaper.pdf>>, Feb. 2008, 6 pages.

Ritchie, "iOS 4 features: iPod touch Wi-Fi stays connected when asleep—iPhone too?", Retrieved from: <<http://www.goip.com/2010/06/ios-4-features-ipod-touch-wi-fi-stays-connected-when-asleep-%E2%80%94-iphone-too/>> on Sep. 30, 2010, Jun. 14, 2010, 2 pages.

Ritscher, "Using Surface APIs in your WPF application—Part 1", Retrieved from: <<http://blog.wpfwonderland.com/2009/06/30/using-surface-apis-in-your-wpf-application/>> on Sep. 28, 2010, Jun. 30, 2009, 7 pages.

Roberts, "Touching and Gesturing on the iPhone", Available at <<http://www.sitepen.com/blog/2008/07/10/touching-and-gesturing-on-the-iphone/comments-pare-1>>, Jul. 10, 2008, 16 pages.

Roth, "Bezel Swipe: Conflict-Free Scrolling and Multiple Selection on Mobile Touch Screen Devices", CHI 2009, Available at <<http://www.volkerroth.com/download/Roth2009a.pdf>>, Apr. 2009, 4 pages.

Sakumi, "Browse/Creation Tool for Hierarchy Contents with Concept Pad System: Zoomable User Interface", In Lecture Note/Software Science 23 Interactive System and Software VIII, Dec. 20, 1999, 8 pages.

Sandoval, "A development platform and execution environment for mobile applications", Universidad Autónoma de Baja California, School of Chemical Sciences and Engineering, Available at <<http://citeseerx.ist.psu.edu/viewdoc/download?doi=10.1.1.86.7989&rep=rep1&type=pdf>>, 2004, 18 pages.

Saugat, "Access Multiple Cloud Files from Single Application", Retrieved from: <<http://freshtutorial.com/access-multiple-cloud-files-single-application/>> on Feb. 15, 2012, Sep. 26, 2011, 7 pages.

Singh, "CINEMA: Columbia InterNet Extensible Multimedia Architecture", Available at <<http://www1.cs.columbia.edu/~library/TR-repository/reports/reports-2002/cucs-011-02.pdf>>, Sep. 3, 2002, 83 Pages.

Smith, "GroupBar: The TaskBar Evolved", Proceedings of OZCHI 2003—Available at <<http://research.microsoft.com/pubs/64316/ozchi2003-groupbar.pdf>>, Nov. 2003, pp. 1-10.

Stebih, "Windows 8 Mouse and Keyboard Commands", retrieved from <<http://www.helpdesktv.ca/windows/windows-8-mouse-and-keyboard-commands.html>> on Nov. 23, 2011, Sep. 21, 2011, 5 pages.

Stein, "Growing Beautiful Code in BioPerl", In Beautiful Code—Leading Programmers Explain How They Think, Oreilly, 2007, 32 pages.

Steinicke, "Multi-Touching 3D Data: Towards Direct Interaction in Stereoscopic Display Environments coupled with Mobile Devices", Advanced Visual Interfaces (AVI) Workshop on Designing Multi-Touch Interaction Techniques for Coupled Public, Available at <<http://viscg.uni-muenster.de/publications/2008/SHSK08/ppd-workshop-.pdf>>, Jun. 15, 2008, 4 Pages.

Suror, "PocketShield-New Screenlock App for the HTC Diamond and Pro", Retrieved from: <<http://wmpoweruser.com/?tag=htc-touch-diamond>> on Jun. 28, 2011, Oct. 23, 2008, 2 pages.

Takahiro, "Let's Manage the Installed Applications", In Easy to Use Mini, Exhaustion Utilization of iPhone, vol. 1, p. 25 Memo, Mar. 10, 2011, 6 pages.

Terpstra, "Beta Beat: Grape, a New Way to Manage Your Desktop Clutter", Retrieved from: <http://www.tuaw.com/2009/04/14/beta-beat-grape-a-new-way-to-manage-your-desktop-clutter/>, Apr. 14, 2009, 4 pages.

Toshiyuki, "User Interaction Technique for Mobile Terminal (First Part)- Display Interaction Technique—Information Processing", In Information Processing Society of Japan, vol. 48, No. 6, Jun. 15, 2007, 12 pages.

Vallerio, "Energy-Efficient Graphical User Interface Design", Retrieved from: <http://www.cc.gatech.edu/classes/AY2007/cs7470_fall/zhong-energy-efficient-user-interface.pdf>, Jun. 10, 2004, pp. 1-13.

Vermeulen, "BlackBerry PlayBook Hands-on", retrieved from <<http://mybroadband.co.za/news/gadgets/20104-BlackBerry-PlayBook-hands-.html>> on May 11, 2011, May 8, 2011, 4 pages.

(56)

References Cited

OTHER PUBLICATIONS

Vigil, "Methods for Controlling a Floating Cursor on a Multi-touch Mobile Phone or Tablet in Conjunction with Selection Gestures and Content Gestures", U.S. Appl. No. 61/304,972, filed Feb. 16, 2010, 54 pages.

Vitucci, "Growl 1.3 To Be Released on Mac App Store, Introduce Lion Support and Drop GrowlMail Support", Retrieved from: <<http://www.macstories.net/stories/growl-1-3-to-be-released-on-mac-app-store-introduce-lion-support-and-drop-growlmail-support/>> on Jul. 22, 2011, Jul. 6, 2011, 6 pages.

Vornberger, "Bluetile", Retrieved from: <<http://www.bluetile.org>> on Sep. 29, 2010, 5 pages.

Webmonkey "HTML Cheatsheet", Retrieved From: <http://www.webmonkey.com/2010/02/html_cheatsheet> on Nov. 7, 2014, Feb. 15, 2010, 5 pages.

Webster, "VsNotepad: An Improved Way To Jot Down On Windows Mobile", Retrieved from <http://pocketnow.com/index.php/index.php?a=portal_detail&t=news&id=7424>, May 19, 2009, 2 pages.

Wilson, "How the iPhone Works", Retrieved from: <<http://electronics.howstuffworks.com/iphone2.htm>> on Apr. 24, 2009, Jan. 2007, 9 pages.

Wilson, "Robust Computer Vision-Based Detection of Pinching for One and Two-Handed Gesture Input", In Proceedings of UIST 2006—Available at <<http://research.microsoft.com/en-us/um/people/awilson/publications/wilsonuist2006/uist%202006%20taffi.pdf>>, Oct. 2006, 4 pages.

Wobbrock, "User-Defined Gestures for Surface Computing", CHI 2009, Apr. 4-9, 2009, Boston, MA—available at <<http://faculty.washington.edu/wobbrock/pubs/chi-09.2.pdf>>, Apr. 4, 2009, 10 pages.

Wu, "Achieving a Superior Ownership Experience in Manageability and Quality for Siebel CRM", available at <<http://www.oracle.com/us/products/enterprise-manager/superior-exp-for-siebel-crm-068962.pdf>>, Aug. 2008, 25 pages.

Wyatt, "Flash/the art of parallax scrolling", .net Magazine, Aug. 1, 2007, pp. 74-76.

Yang, "Dual-Surface Input: Augmenting One-Handed Interaction with Coordinated Front and Behind-the-Screen Input", Proceedings: MobileHCI '09, Sep. 15-18, 2009, Bonn, Germany—retrieved from <<http://www.cs.ualberta.ca/~wfb/publications/C-2009-MobileHCI-Yang.pdf>>, Sep. 18, 2009, 10 pages.

Yang, "Semantic Photo Album Based on MPEG-4 Compatible Application Format", Retrieved from: <<http://ieeexplore.ieee.org/stamp/stamp.jsp?arnumber=04146254>>, 2007, 2 Pages.

Yee, "Two-Handed Interaction on a Tablet Display", Retrieved from: <<http://zesty.ca/tht/yee-tht-chi2004-short.pdf>>, Conference on Human Factors in Computing Systems, Apr. 2004, 4 pages.

"Corrected Notice of Allowance", U.S. Appl. No. 13/228,931, dated Nov. 30, 2016, 2 pages.

"Corrected Notice of Allowance", U.S. Appl. No. 13/228,931, dated Dec. 29, 2016, 2 pages.

"Corrected Notice of Allowance", U.S. Appl. No. 13/657,621, dated Dec. 1, 2016, 3 pages.

"Foreign Notice of Allowance", CN Application No. 201180071190.0, dated Sep. 8, 2016, 6 pages.

"Foreign Notice of Allowance", JP Application No. 2014-529685, dated Oct. 19, 2016, 4 pages.

"Foreign Office Action", AU Application No. 2011376310, dated Nov. 7, 2016, 3 pages.

"Foreign Office Action", EP Application No. 11866772.4, dated Nov. 21, 2016, 6 pages.

"Non-Final Office Action", U.S. Appl. No. 14/586,364, dated Dec. 28, 2016, 7 pages.

"Notice of Allowance", U.S. Appl. No. 13/550,432, dated Jan. 3, 2017, 5 pages.

"Corrected Notice of Allowance", U.S. Appl. No. 13/118,314, dated Apr. 27, 2017, 2 pages.

"Corrected Notice of Allowance", U.S. Appl. No. 14/919,607, dated May 8, 2017, 2 pages.

"Final Office Action", U.S. Appl. No. 13/118,302, dated May 4, 2017, 43 pages.

"Final Office Action", U.S. Appl. No. 14/918,358, dated Apr. 27, 2017, 8 pages.

"Final Office Action", U.S. Appl. No. 14/918,359, dated May 17, 2017, 7 pages.

"Non-Final Office Action", U.S. Appl. No. 14/522,420, dated Apr. 28, 2017, 31 pages.

"Non-Final Office Action", U.S. Appl. No. 14/558,666, dated May 4, 2017, 13 pages.

"Notice of Allowance", U.S. Appl. No. 14/850,347, dated May 5, 2017, 5 pages.

* cited by examiner

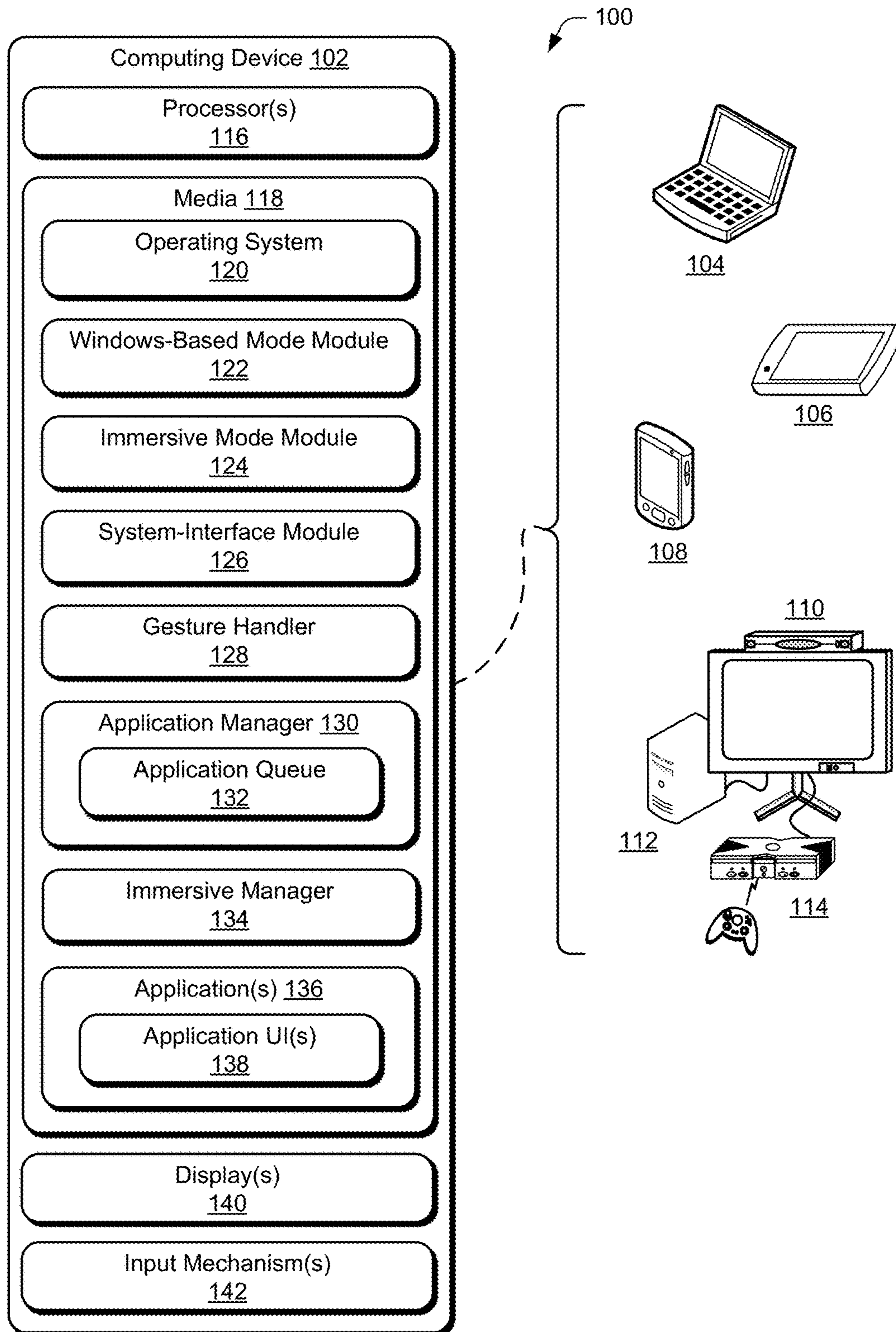

Fig. 1

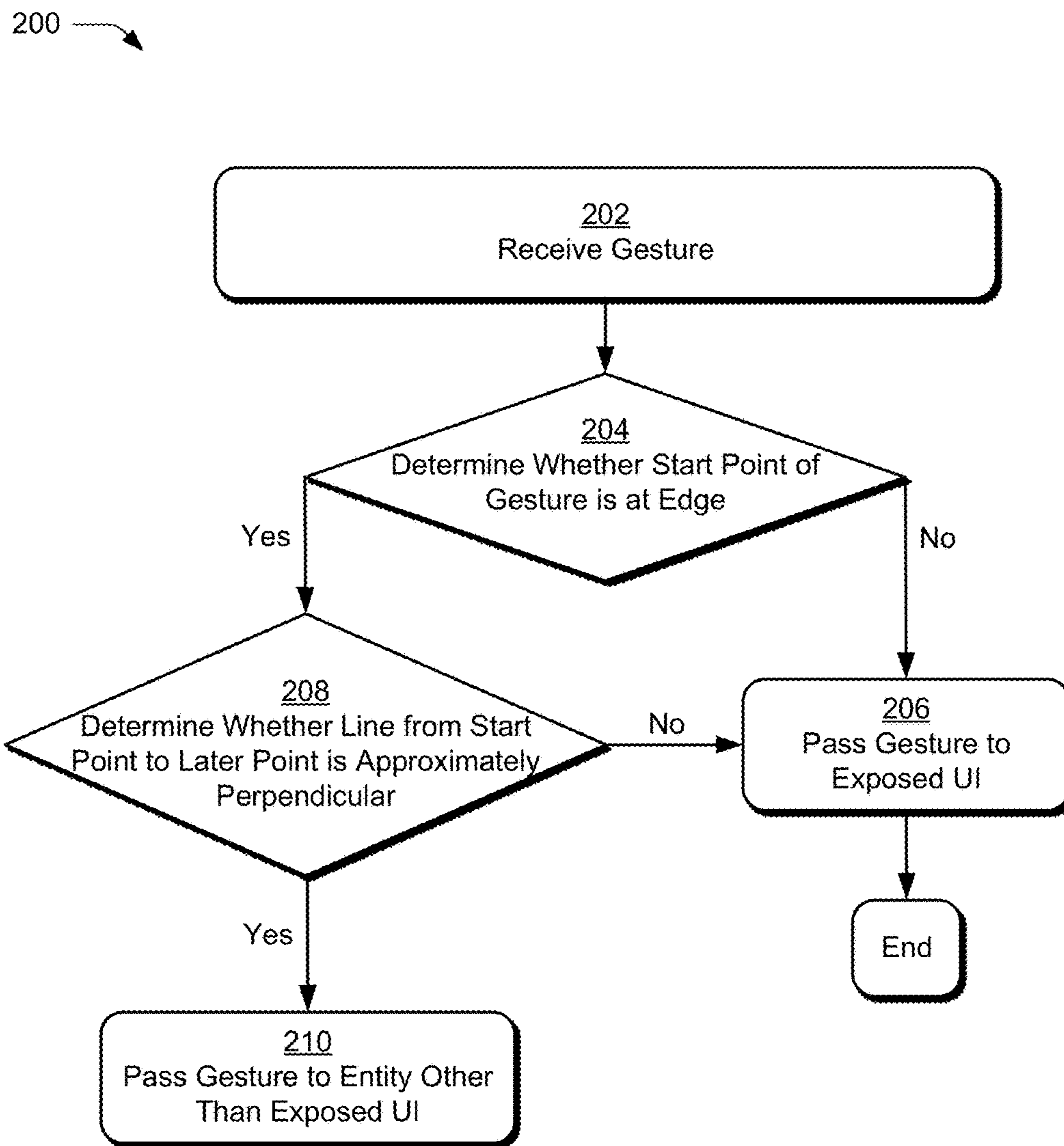

Fig. 2

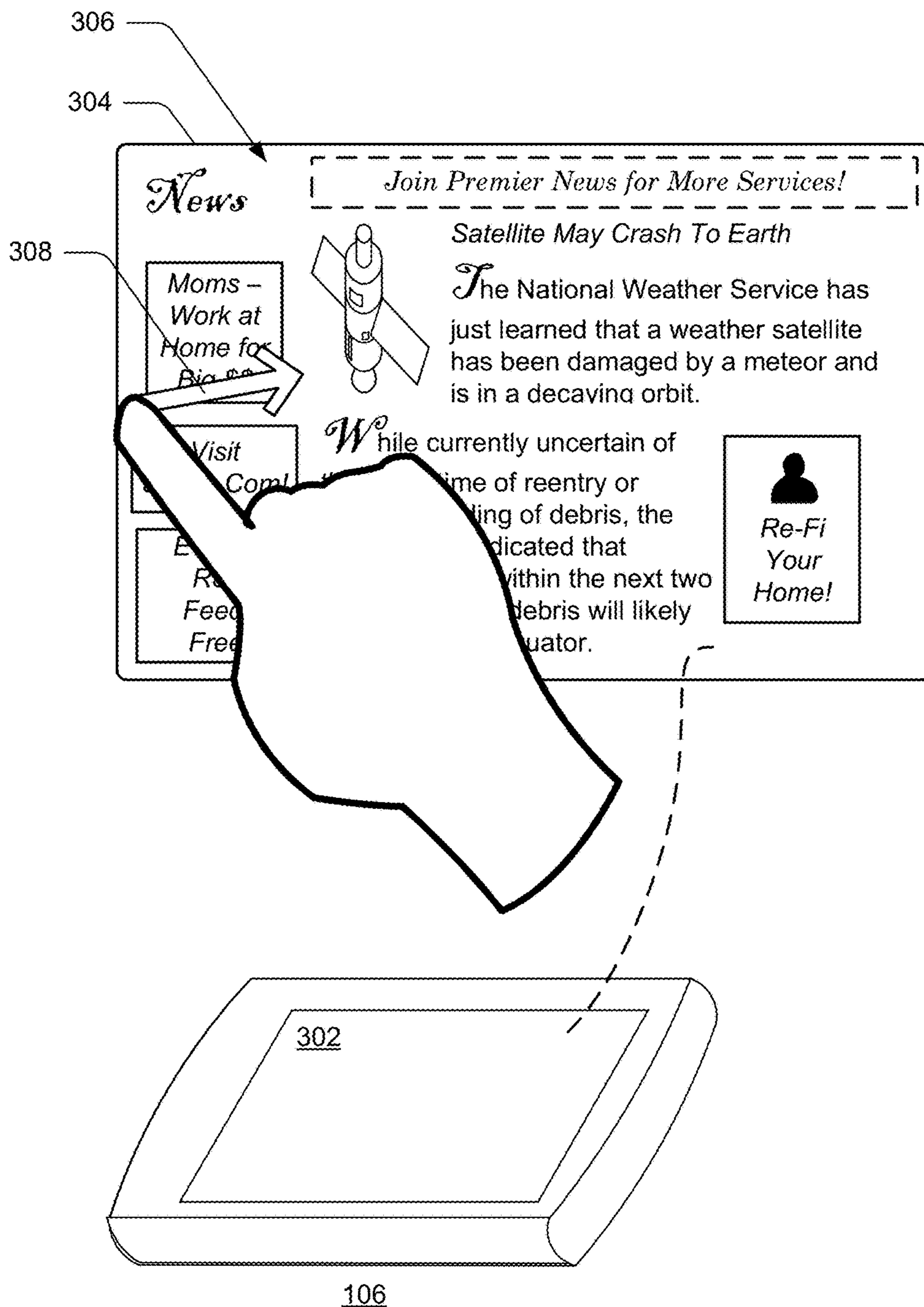

Fig. 3

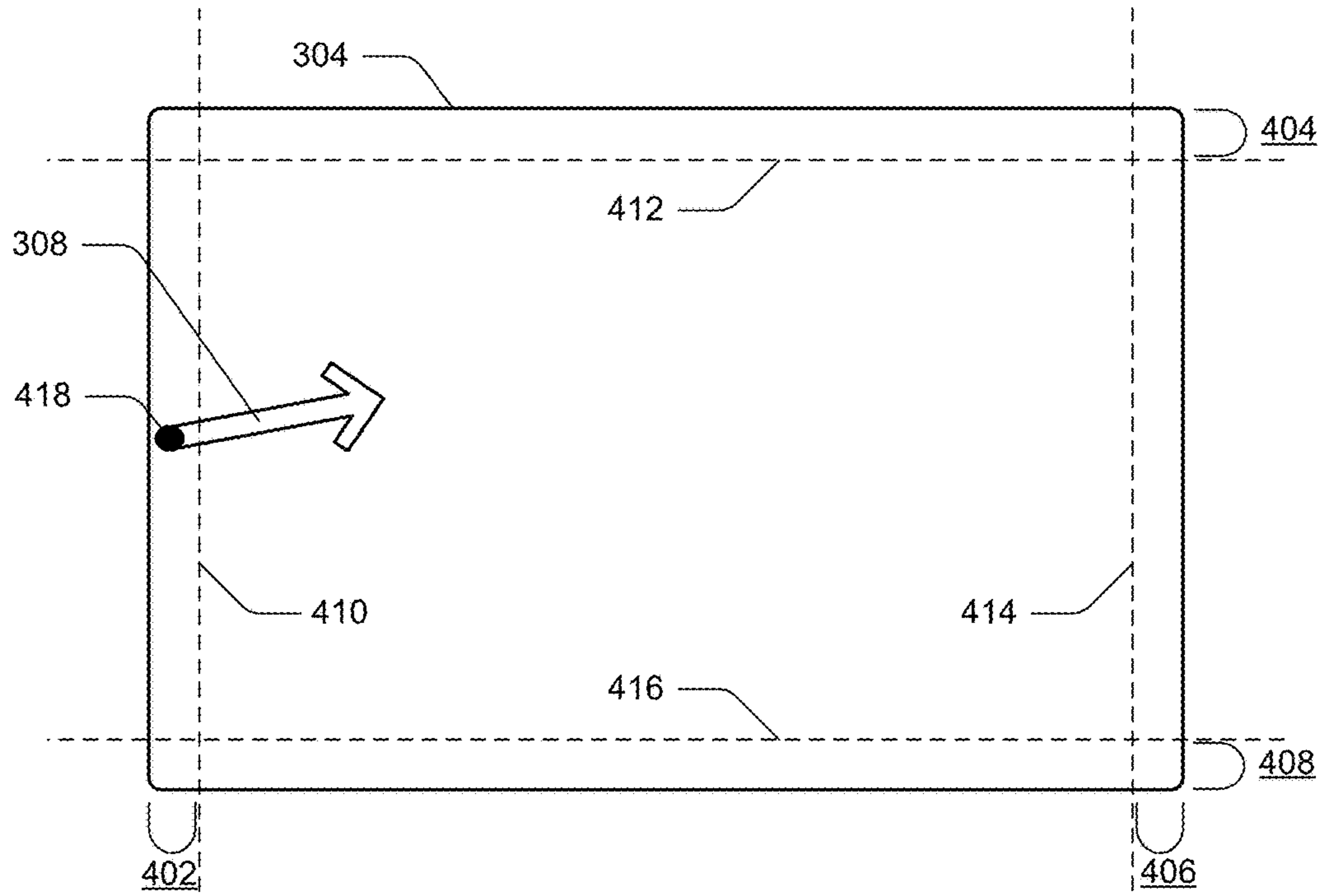

Fig. 4

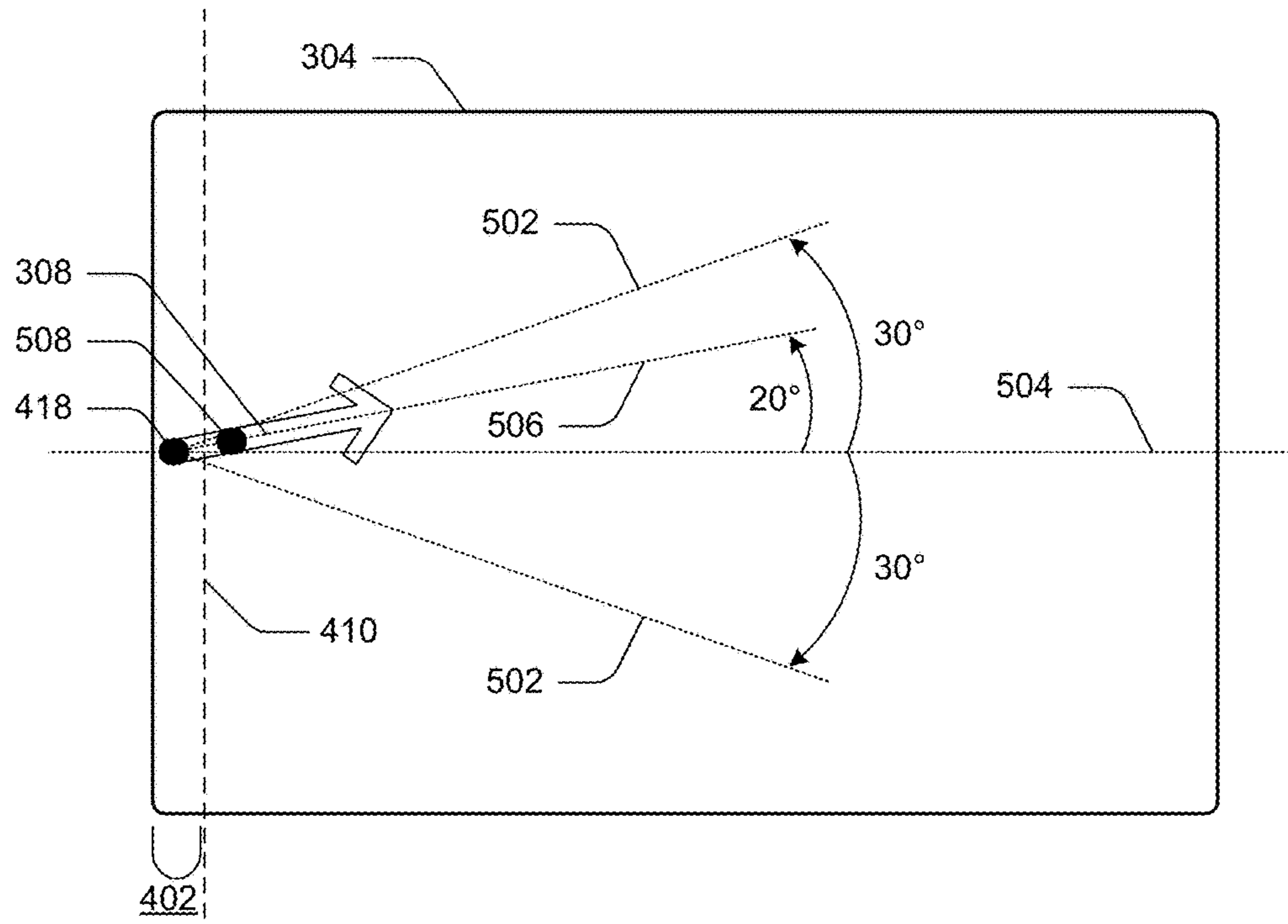

Fig. 5

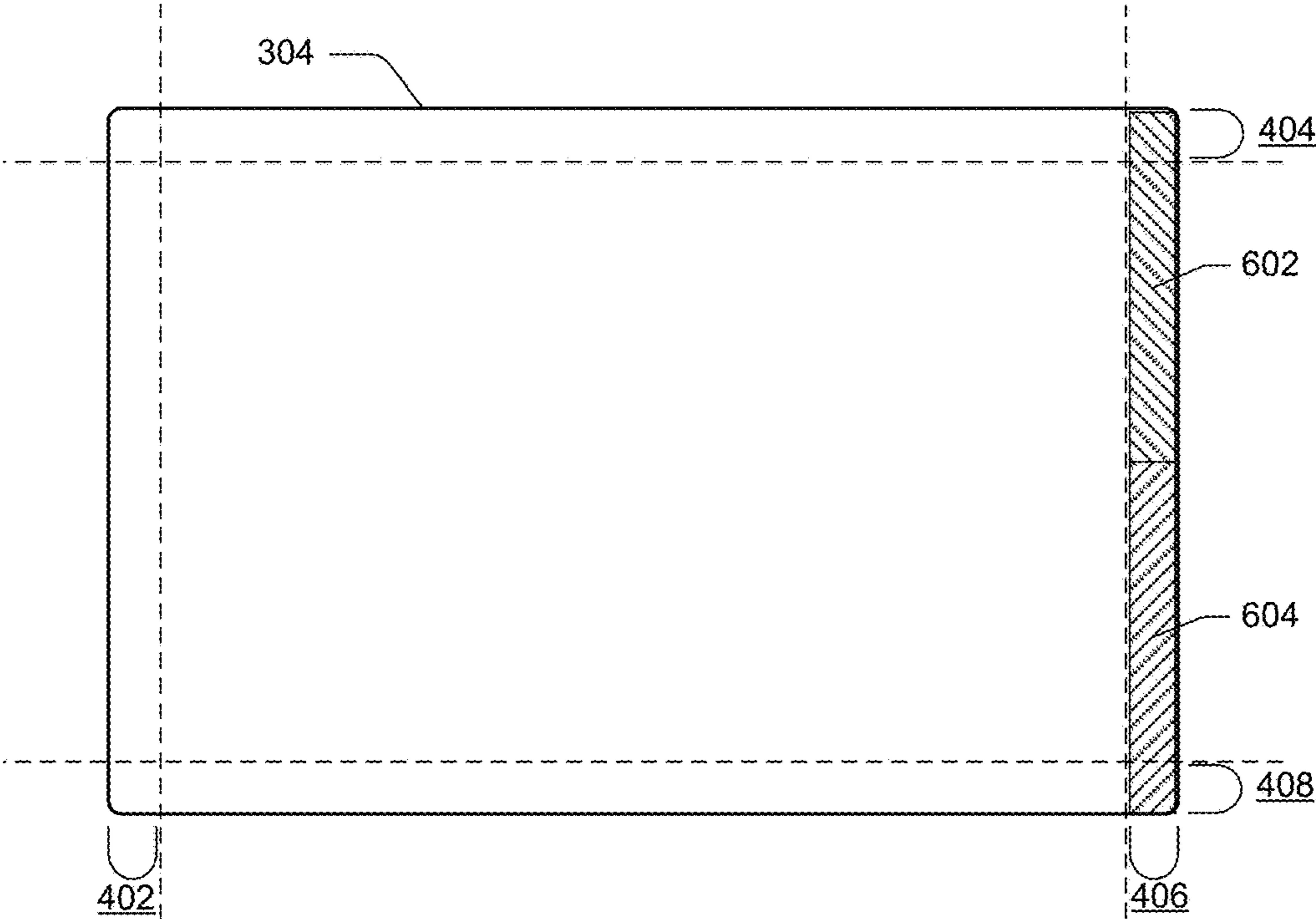

Fig. 6

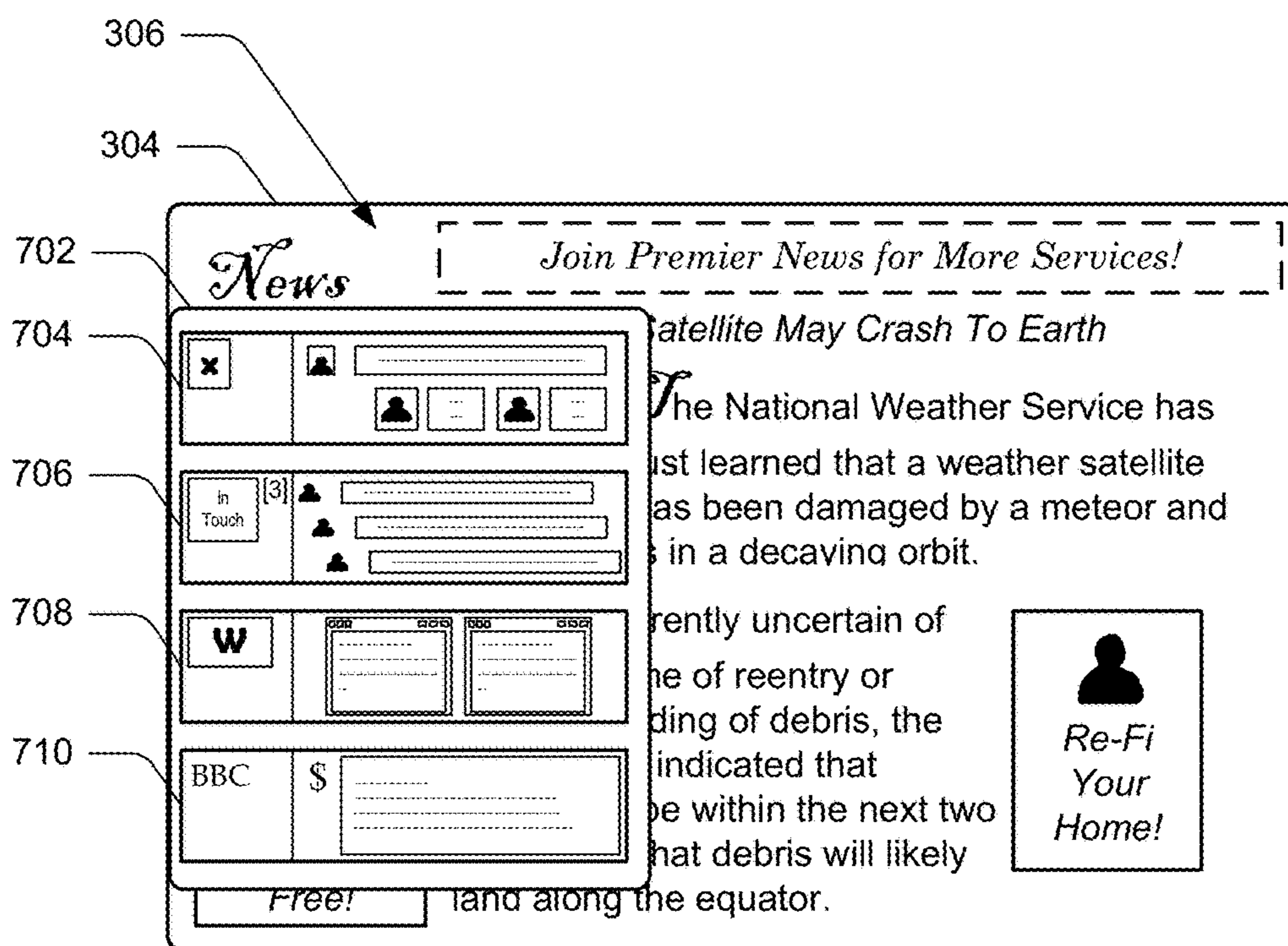

Fig. 7

800 →

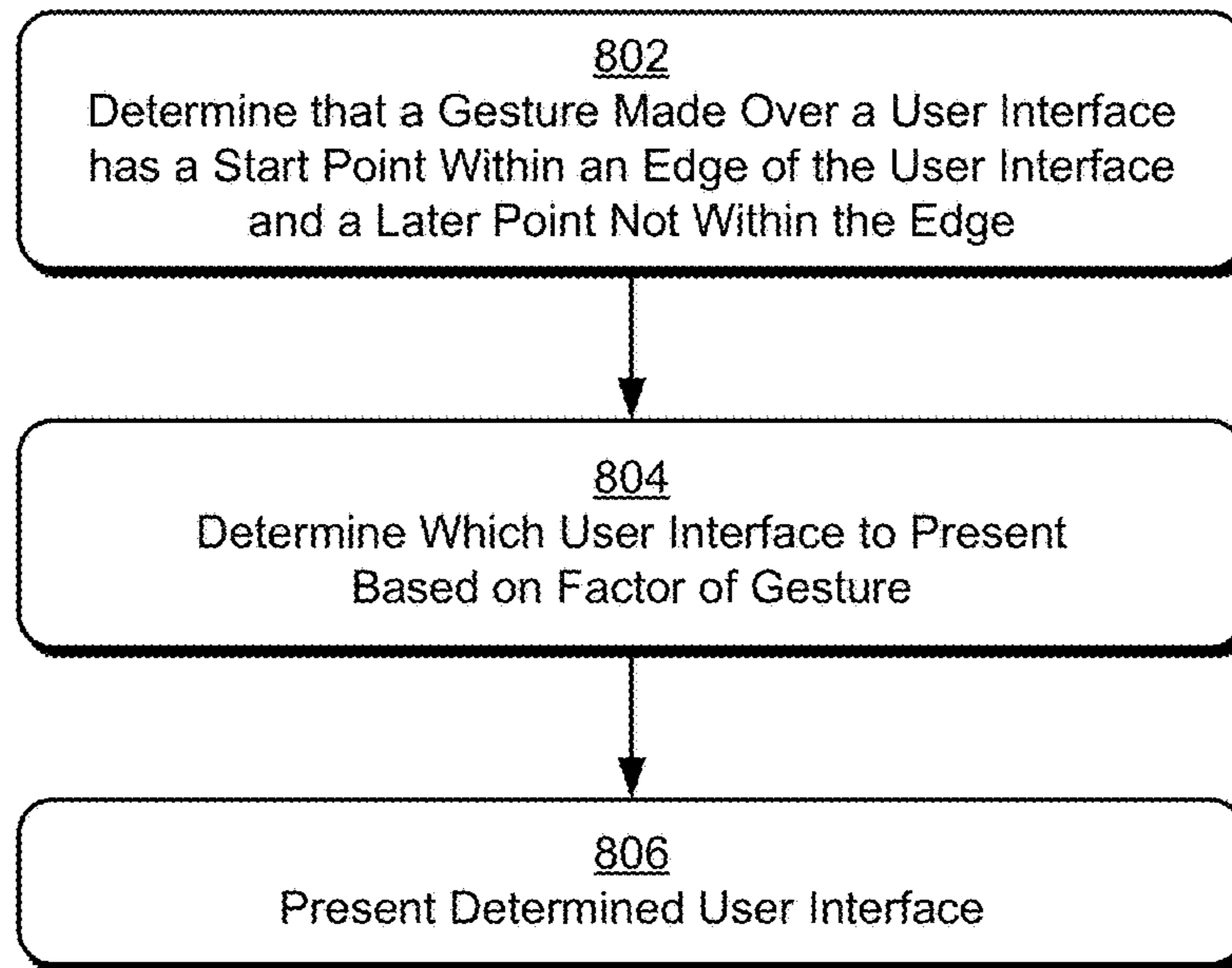

Fig. 8

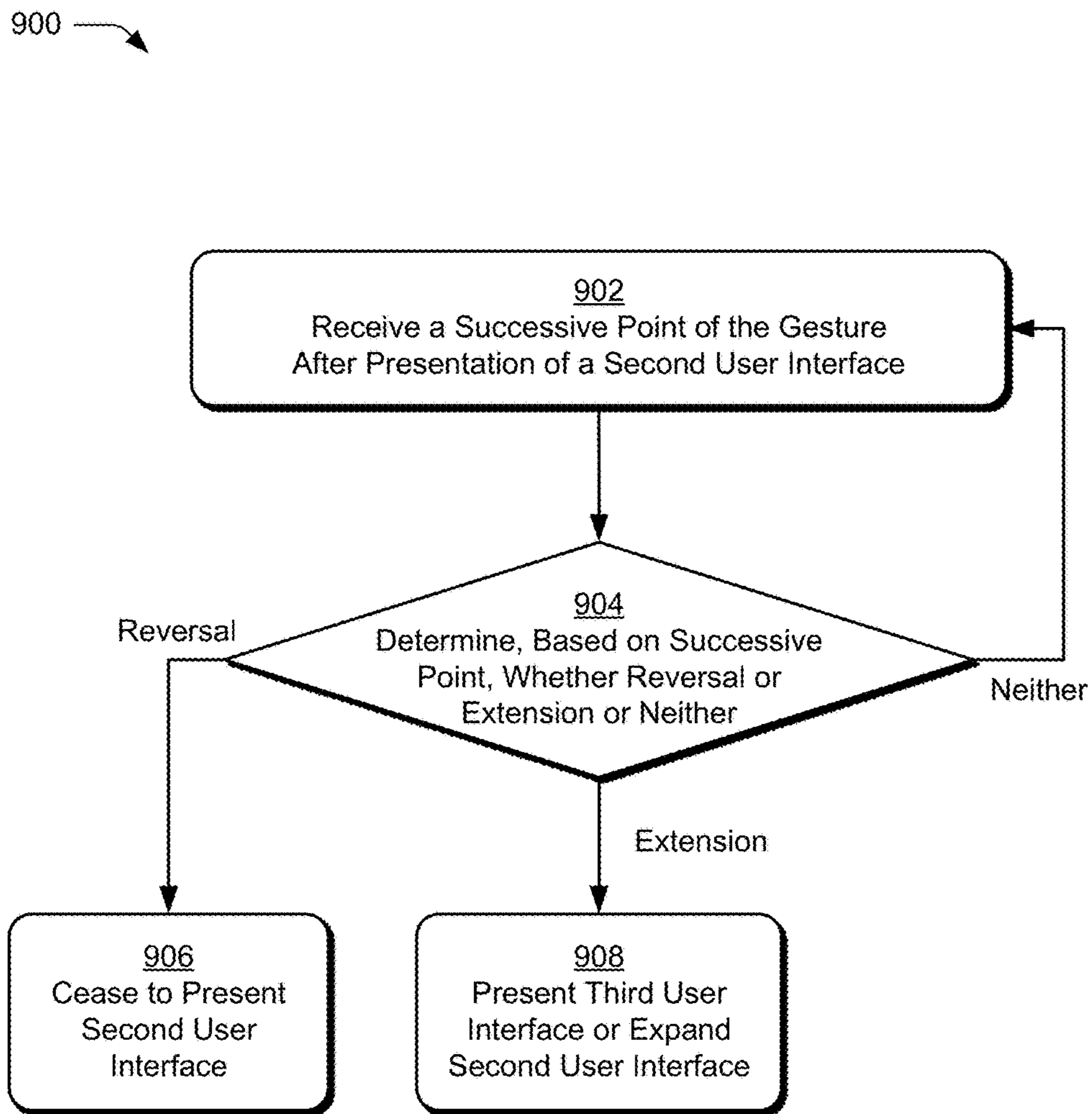

Fig. 9

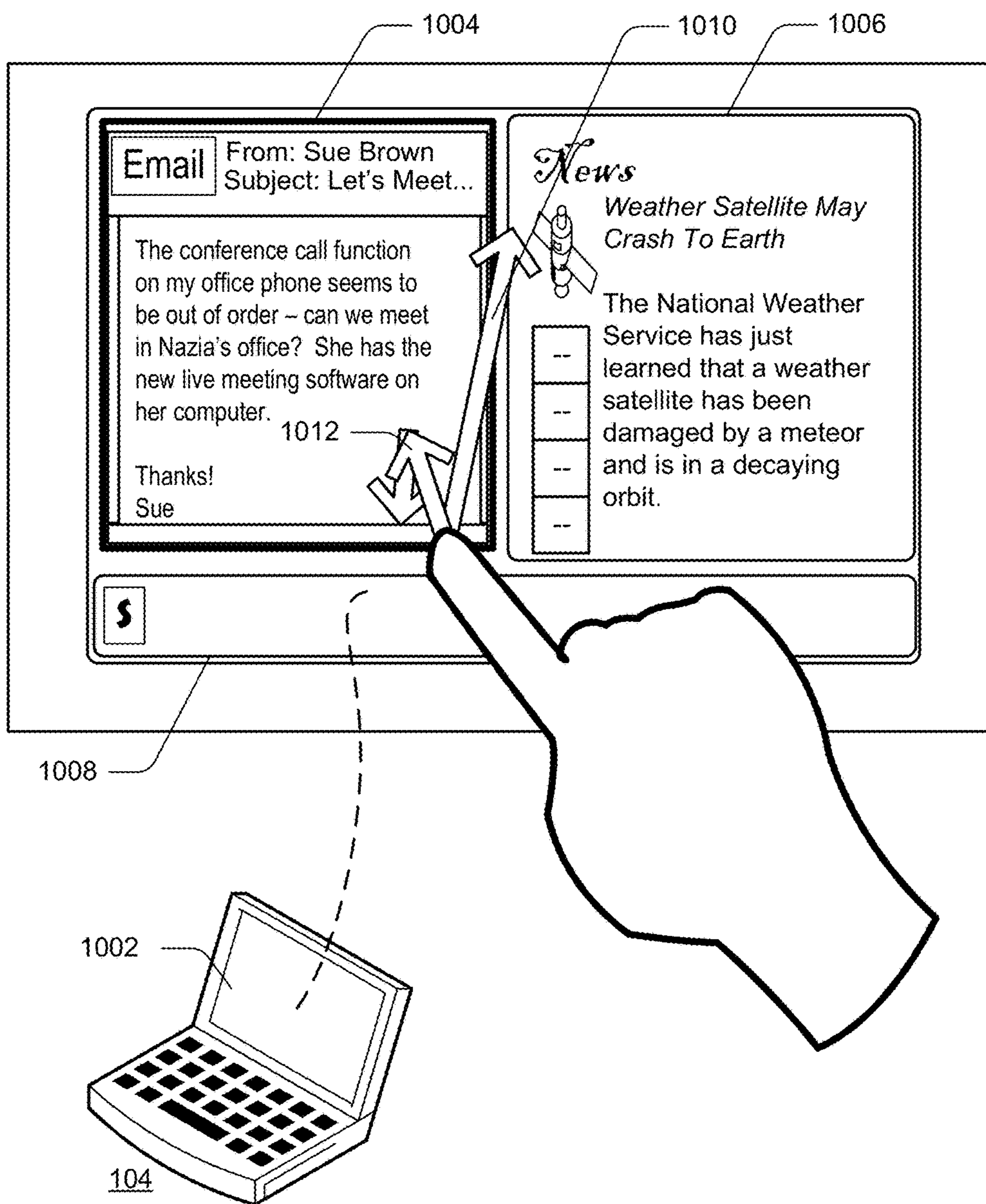

Fig. 10

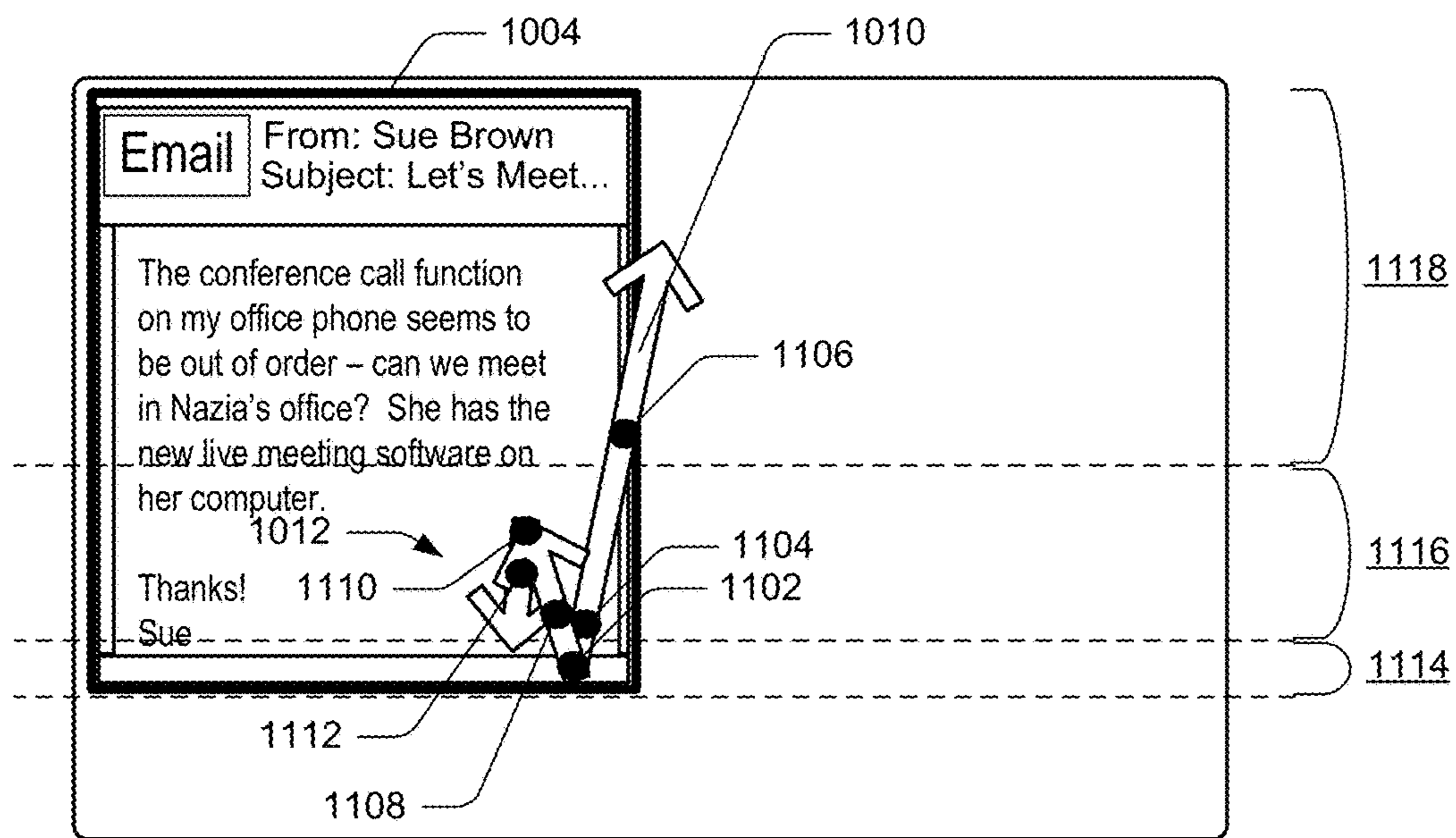

Fig. 11

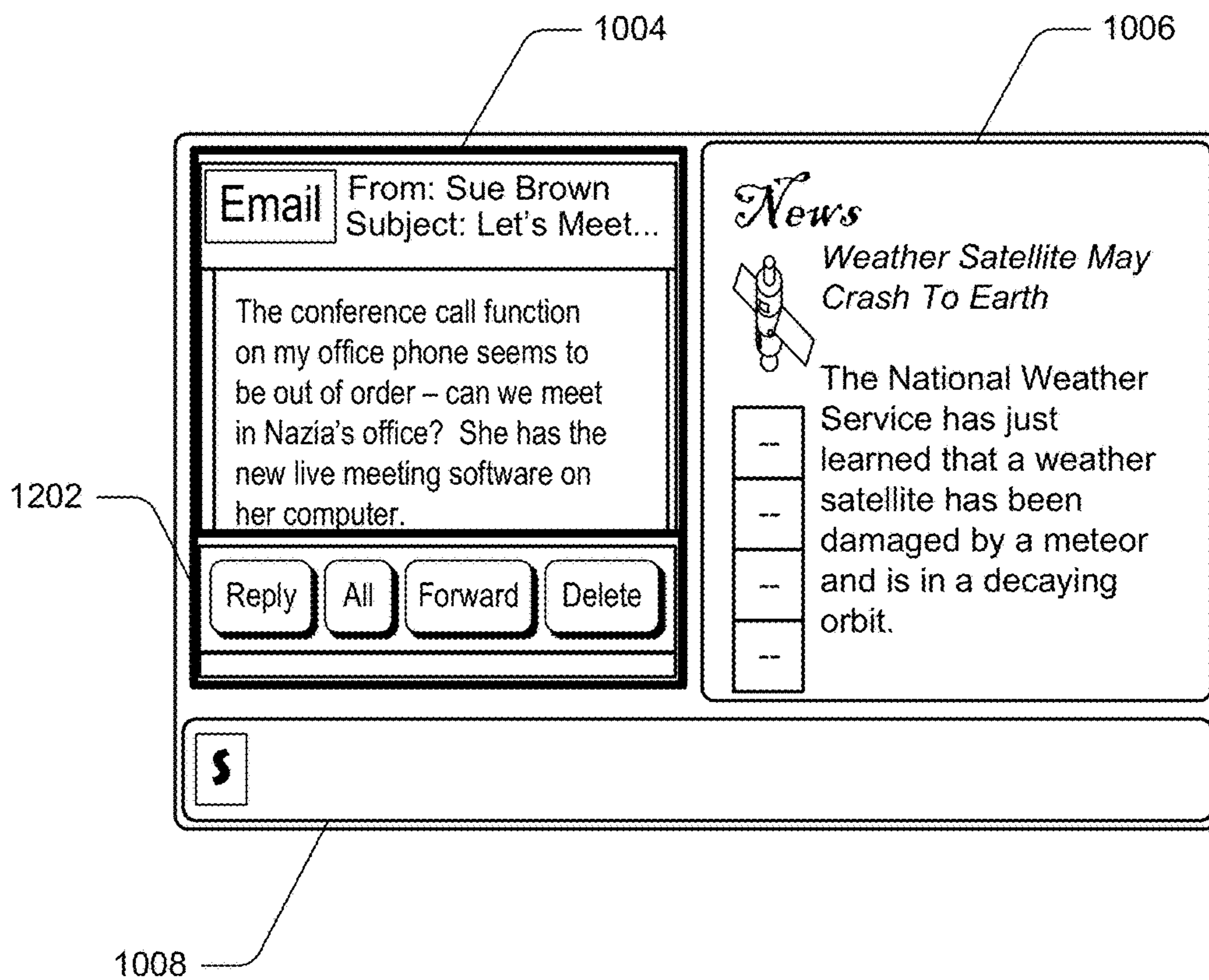

Fig. 12

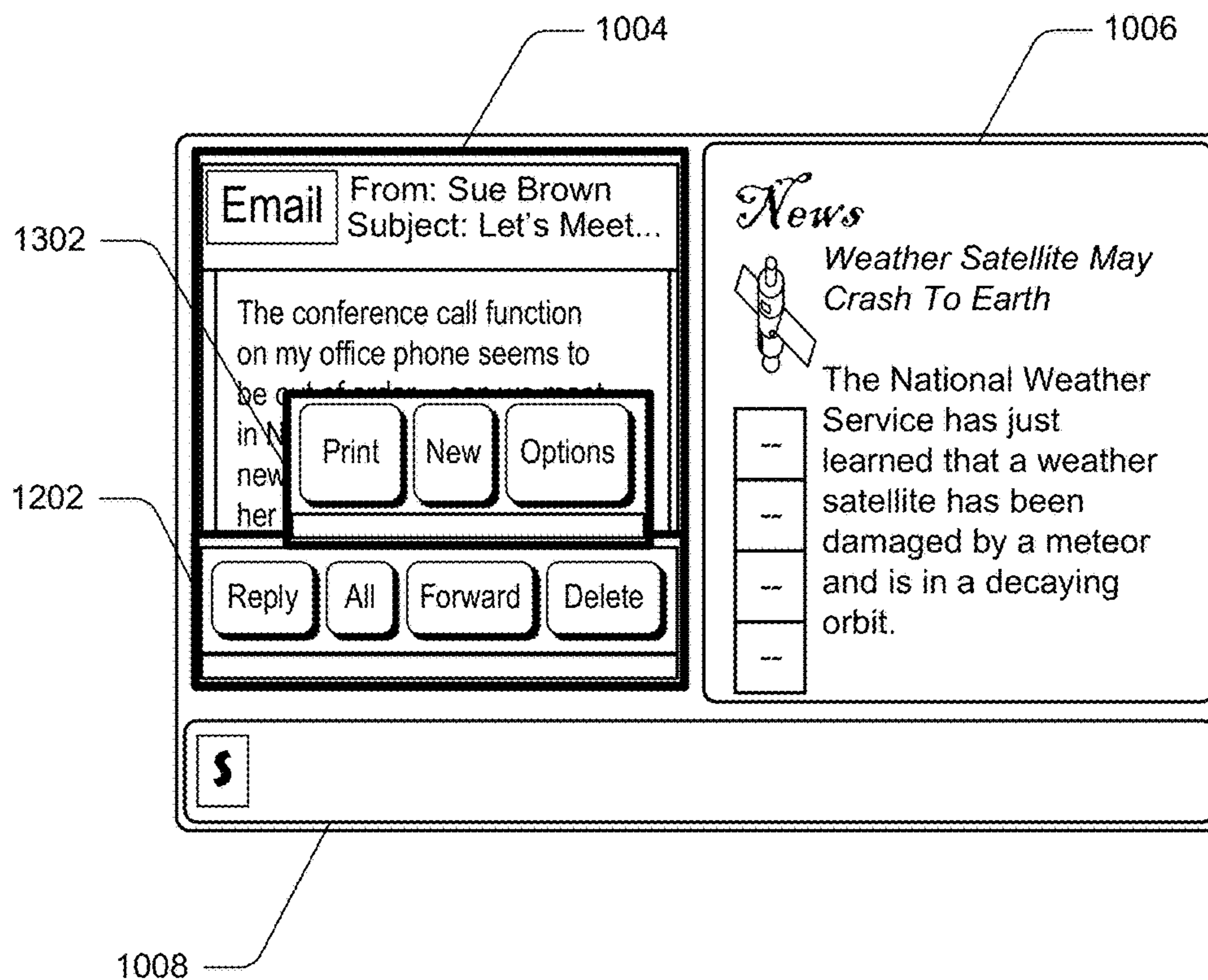

Fig. 13

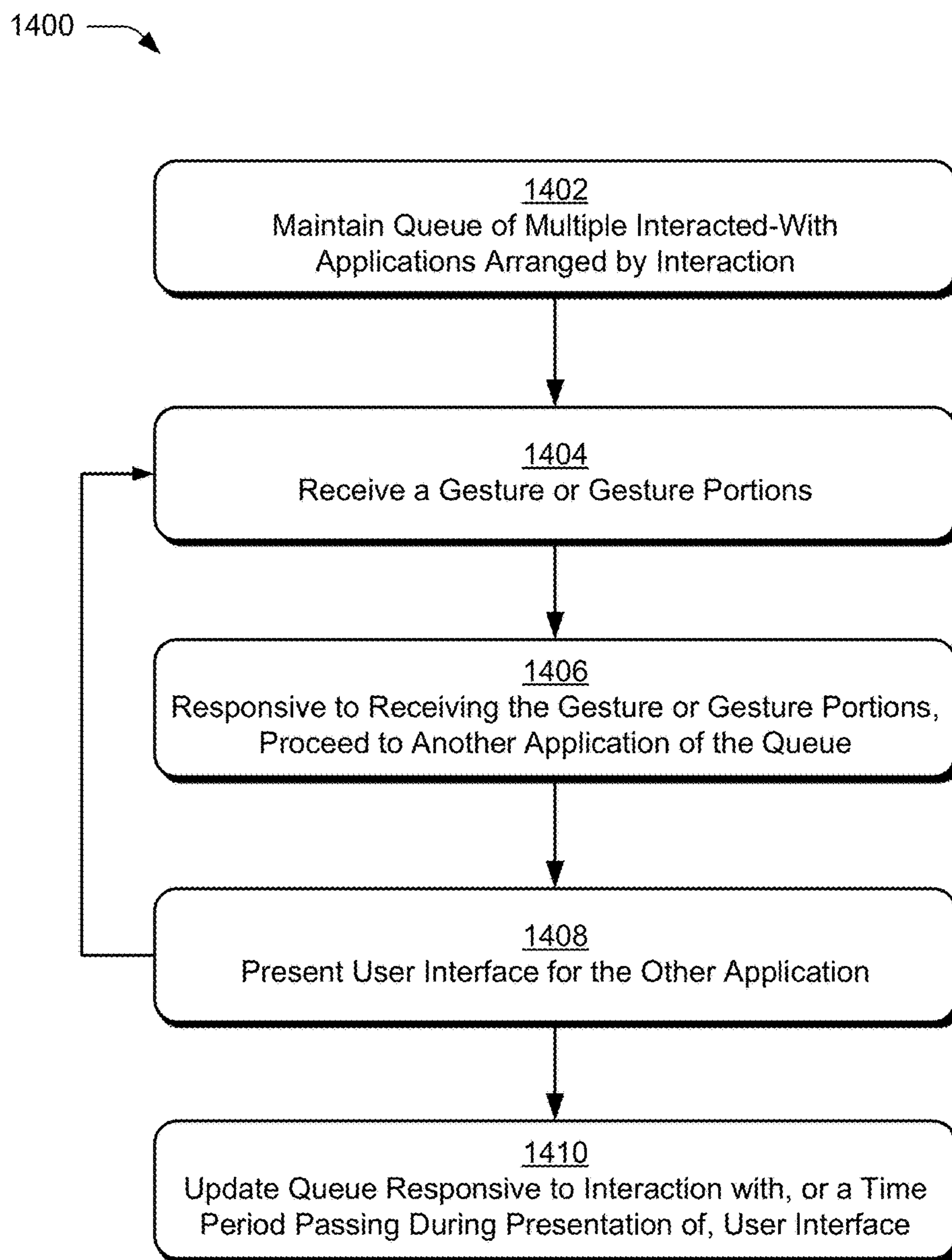

Fig. 14

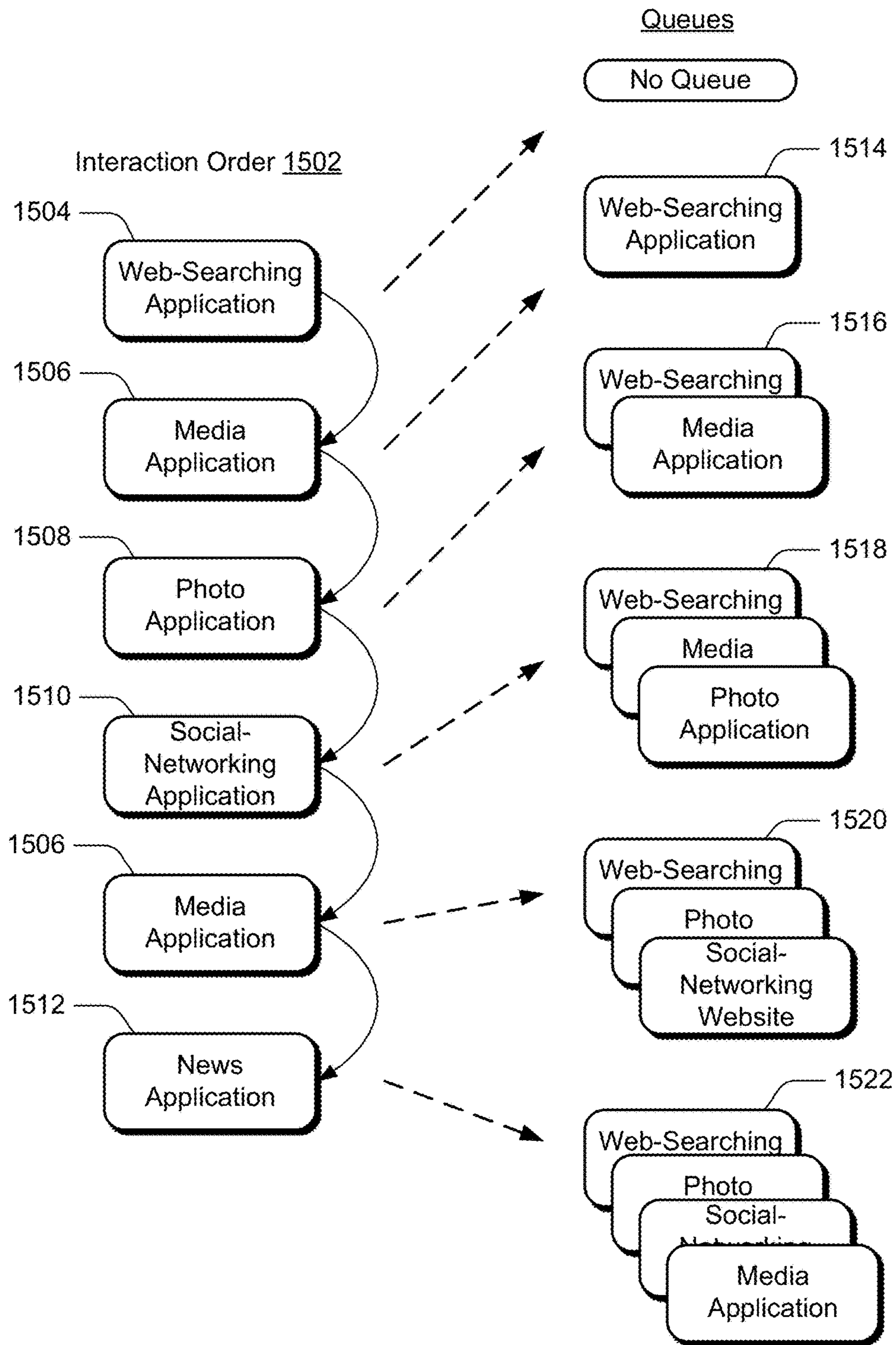

Fig. 15

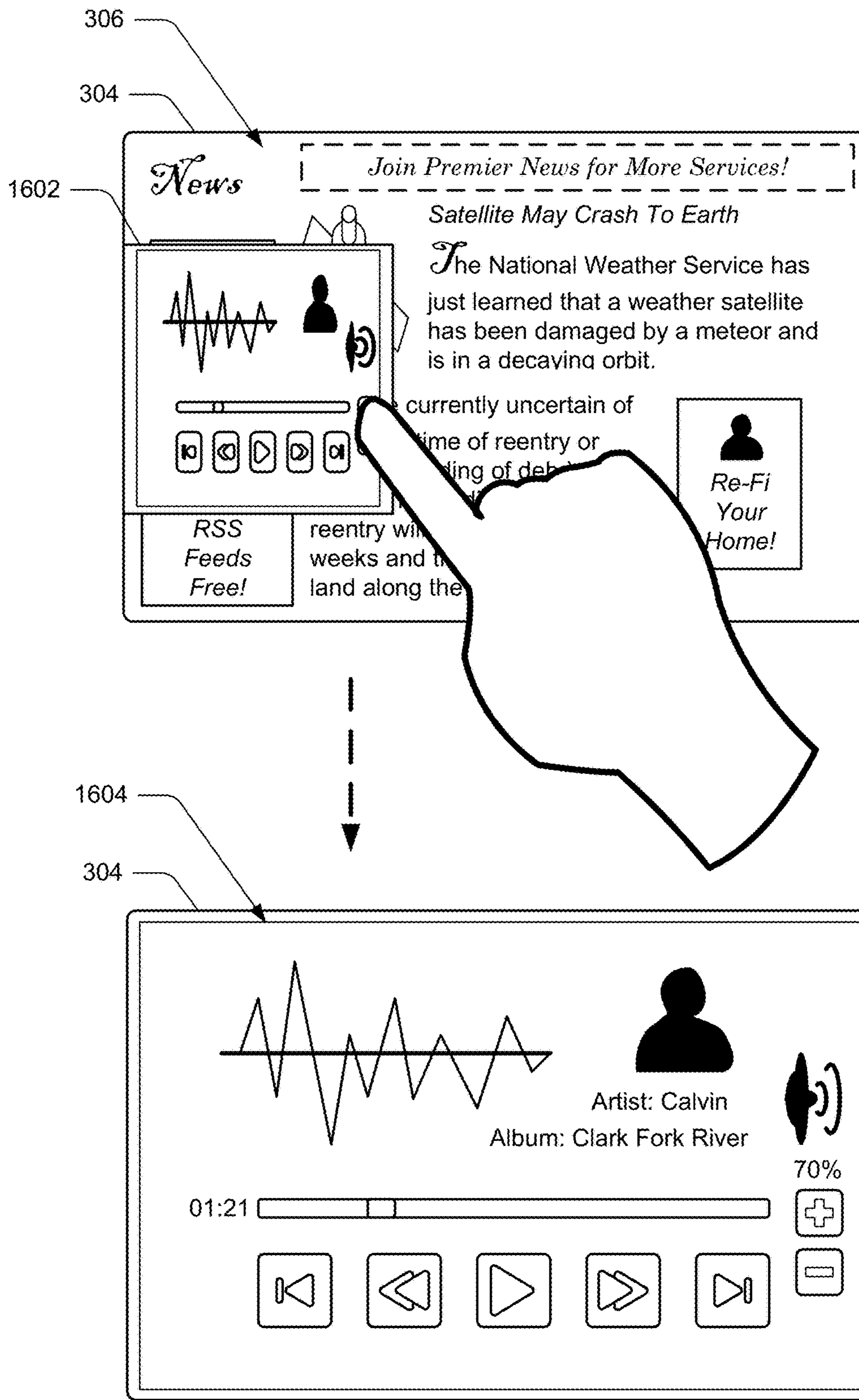

Fig. 16

1700 →

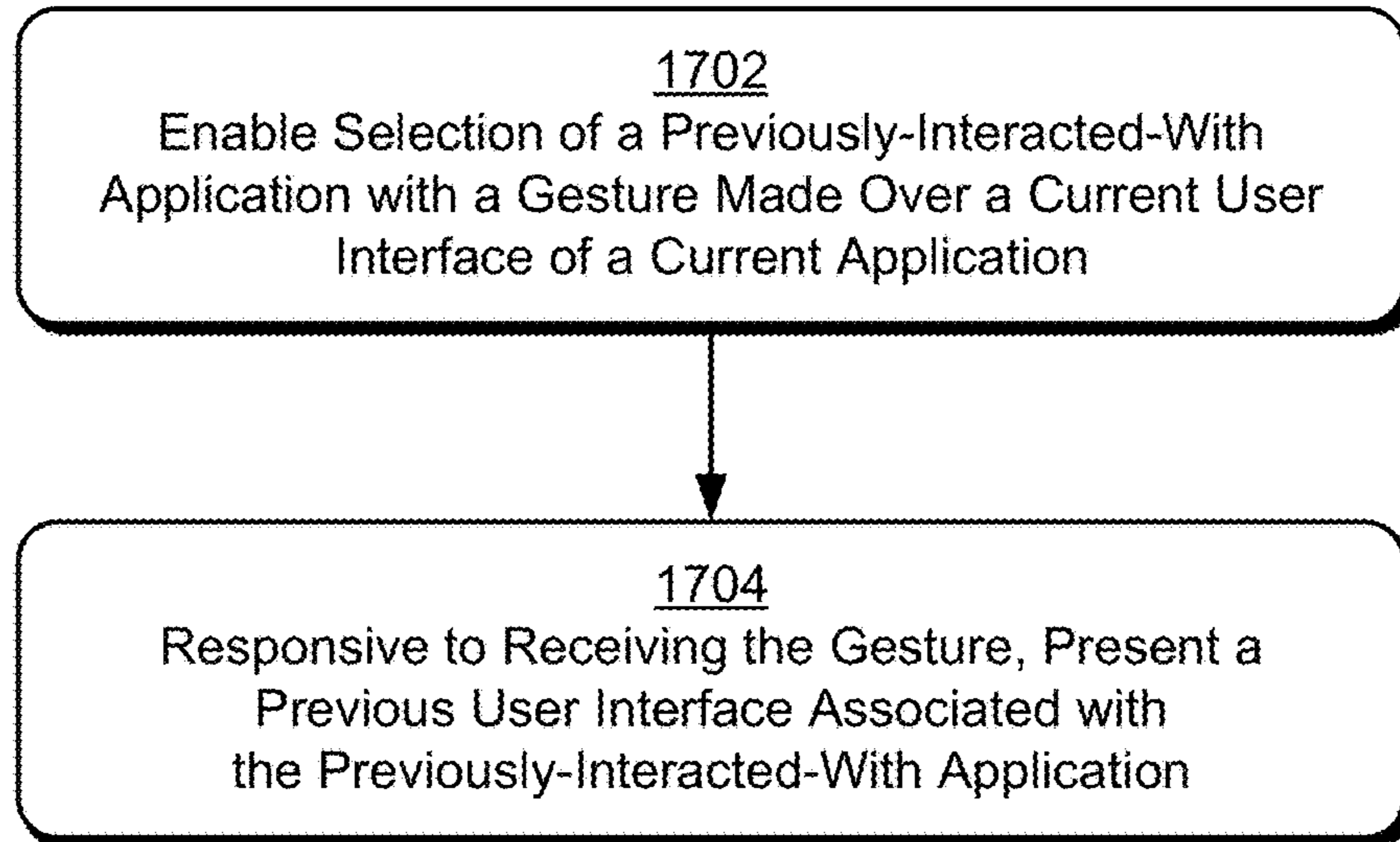

Fig. 17

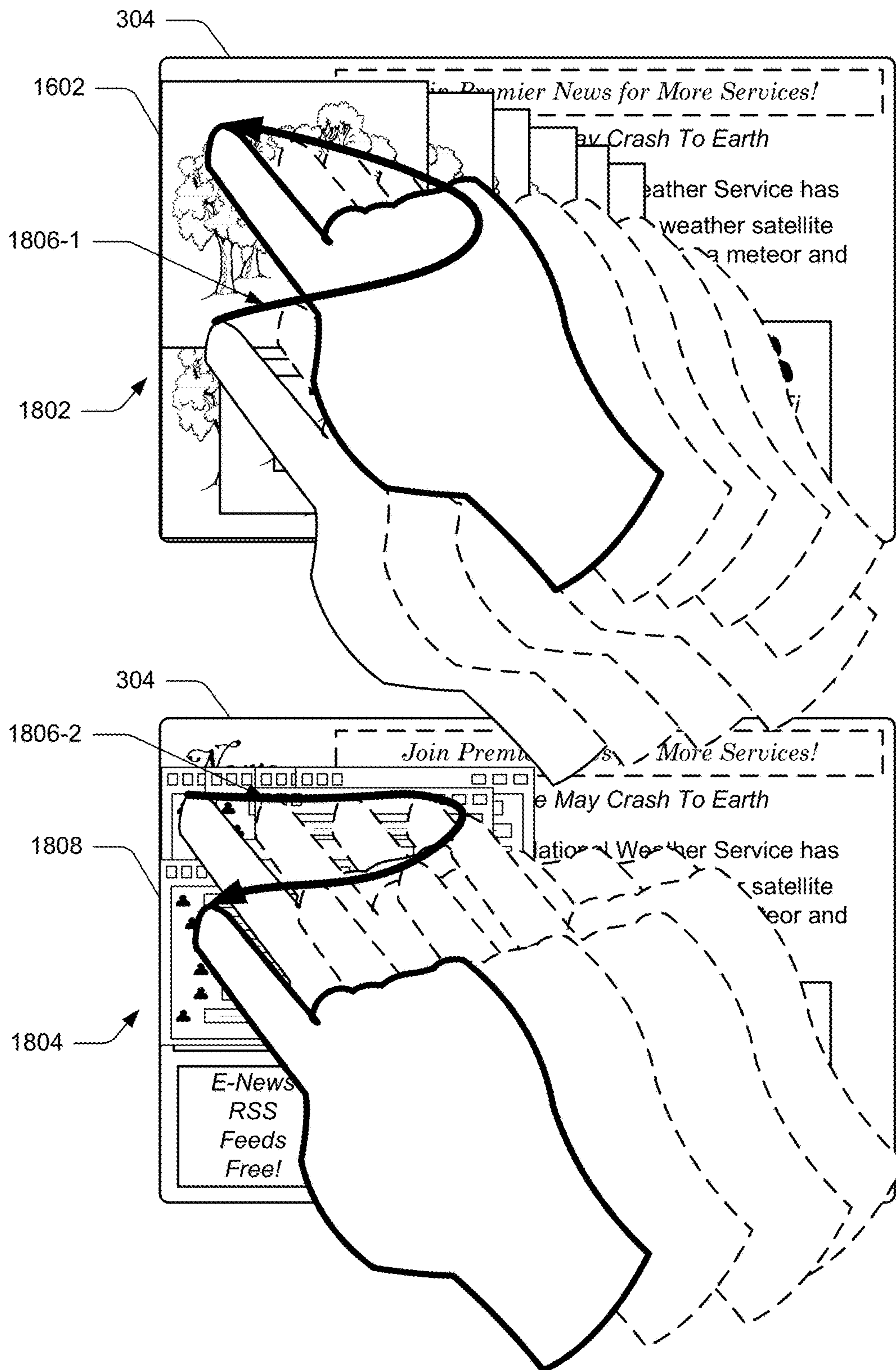

Fig. 18

1900 →

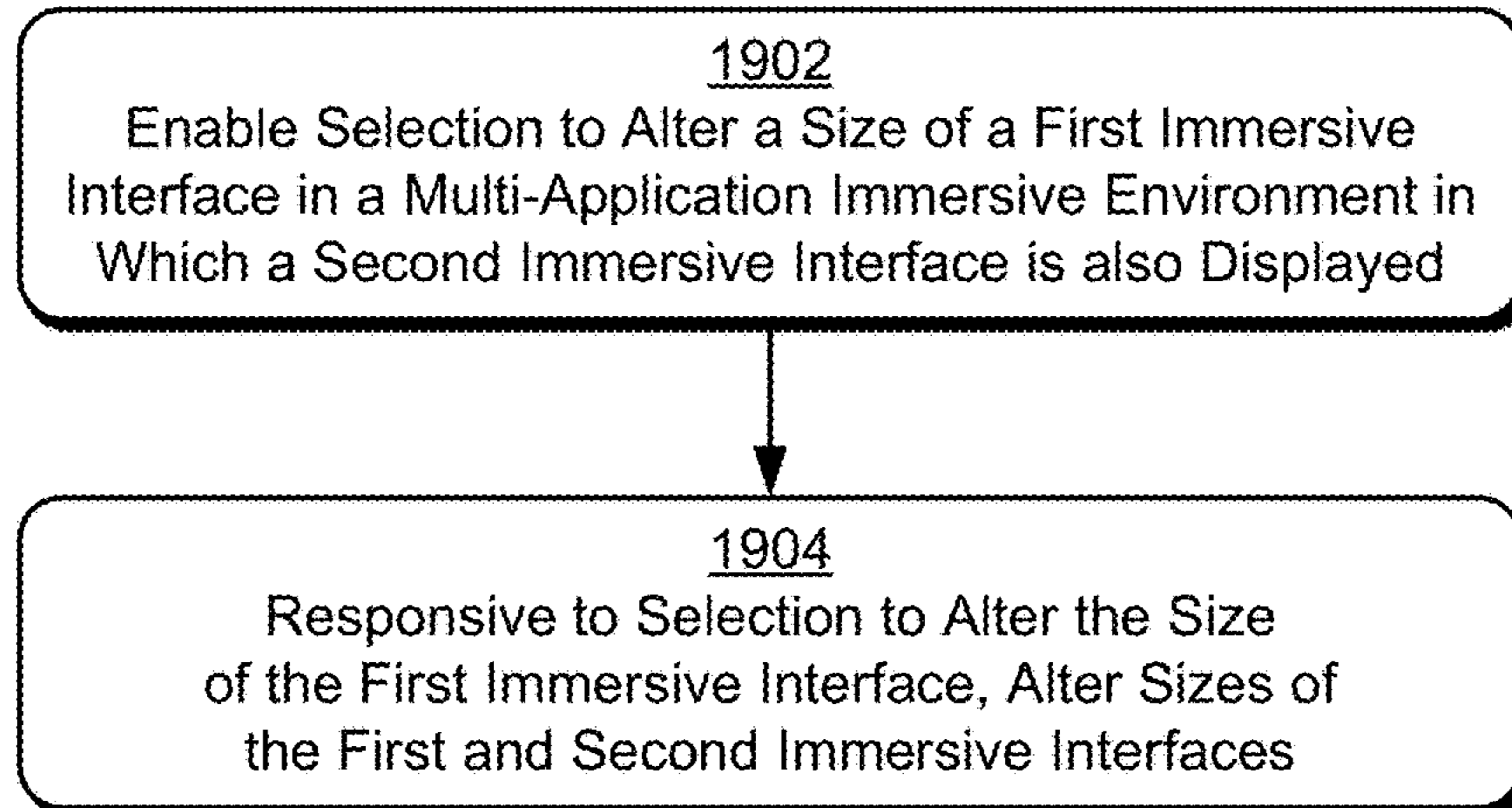

Fig. 19

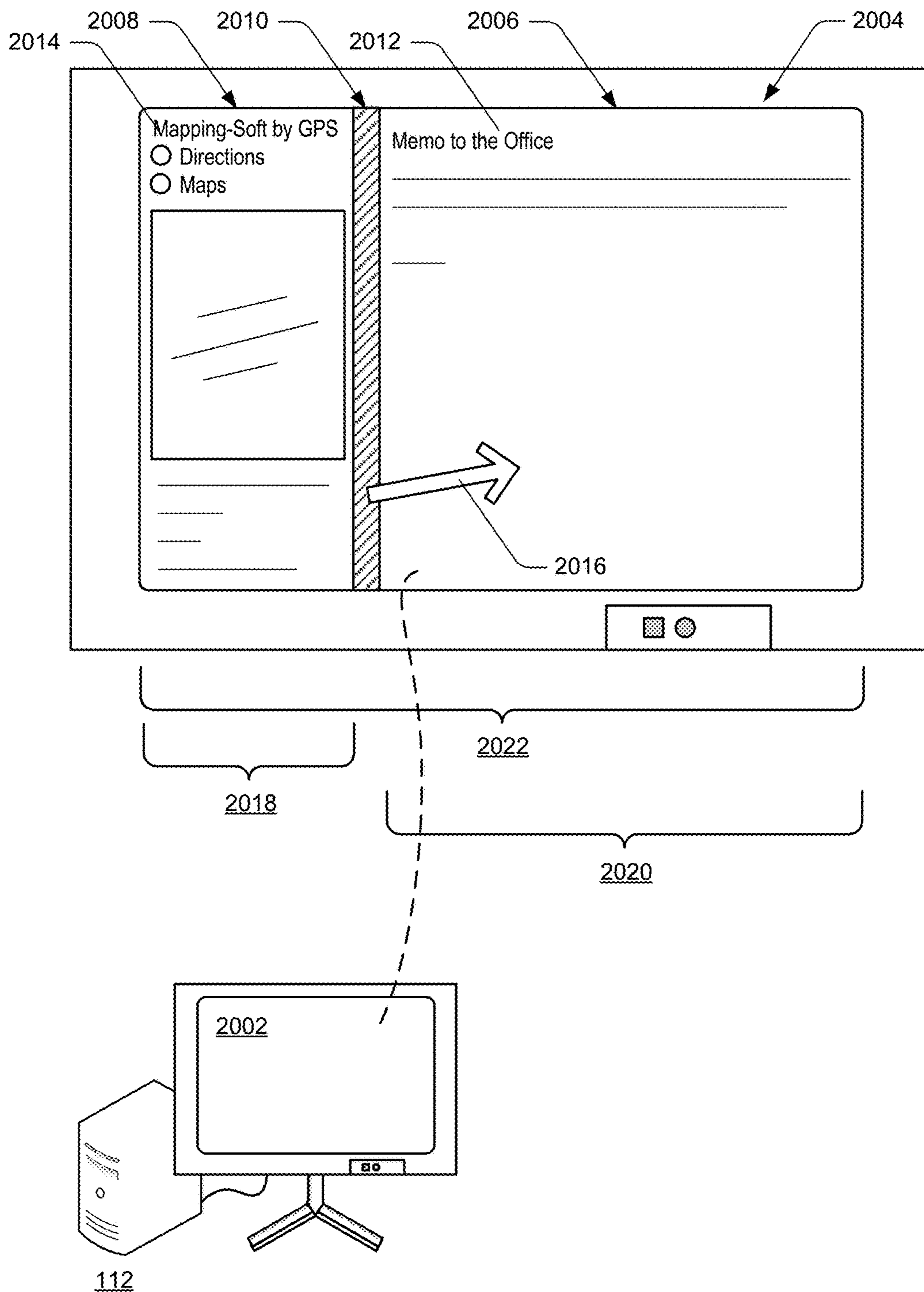

Fig. 20

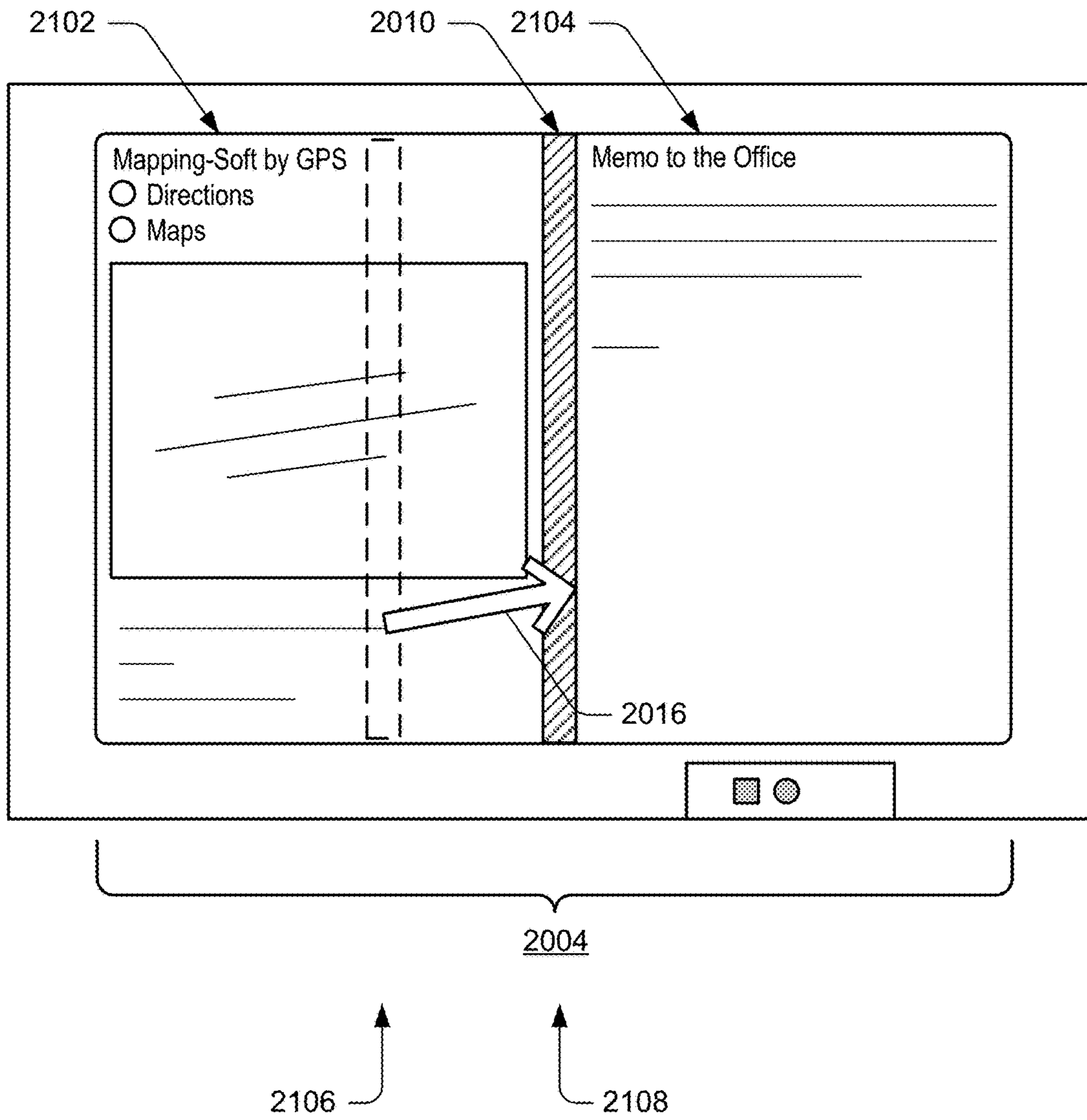

Fig. 21

2200 →

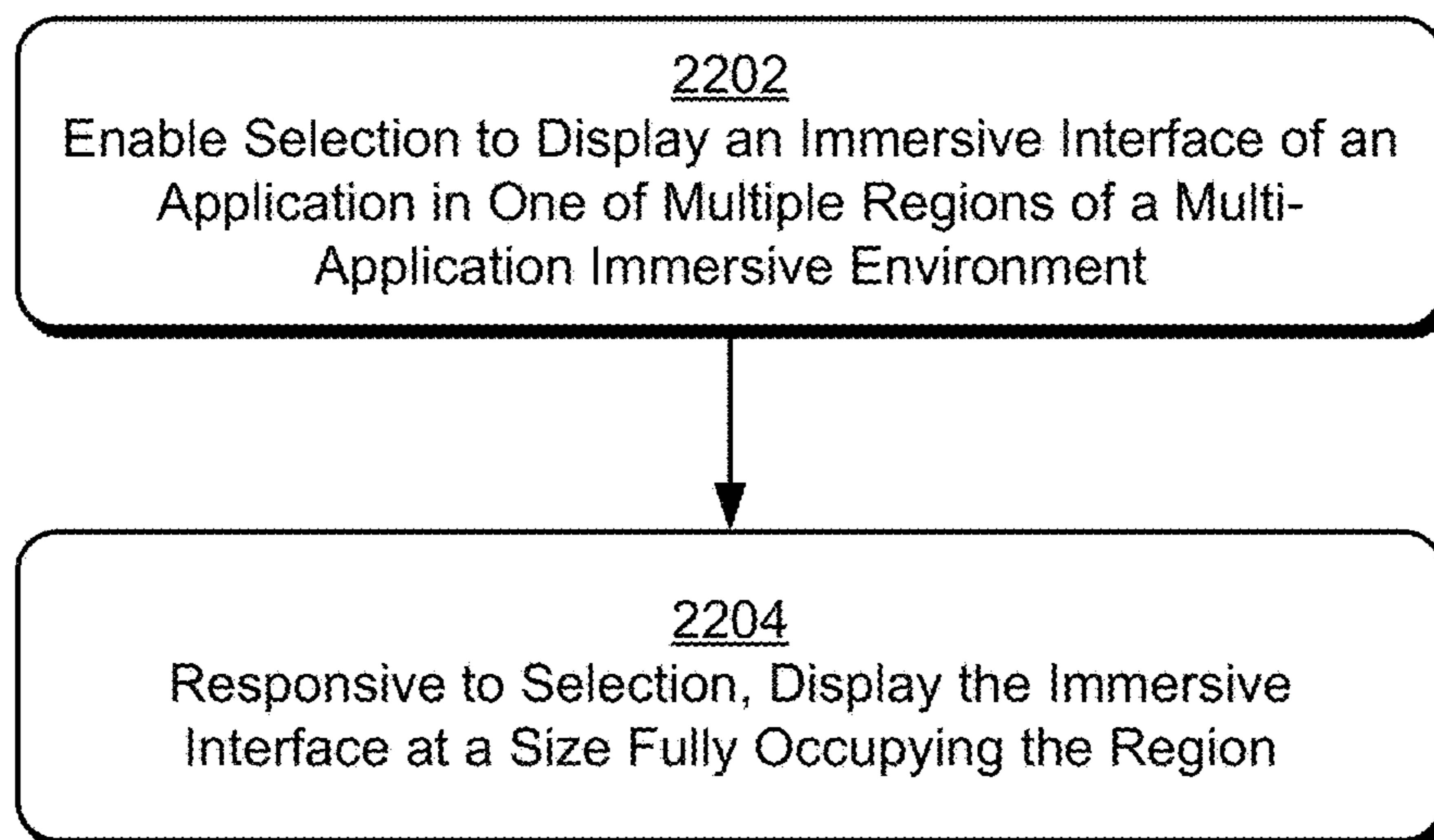

Fig. 22

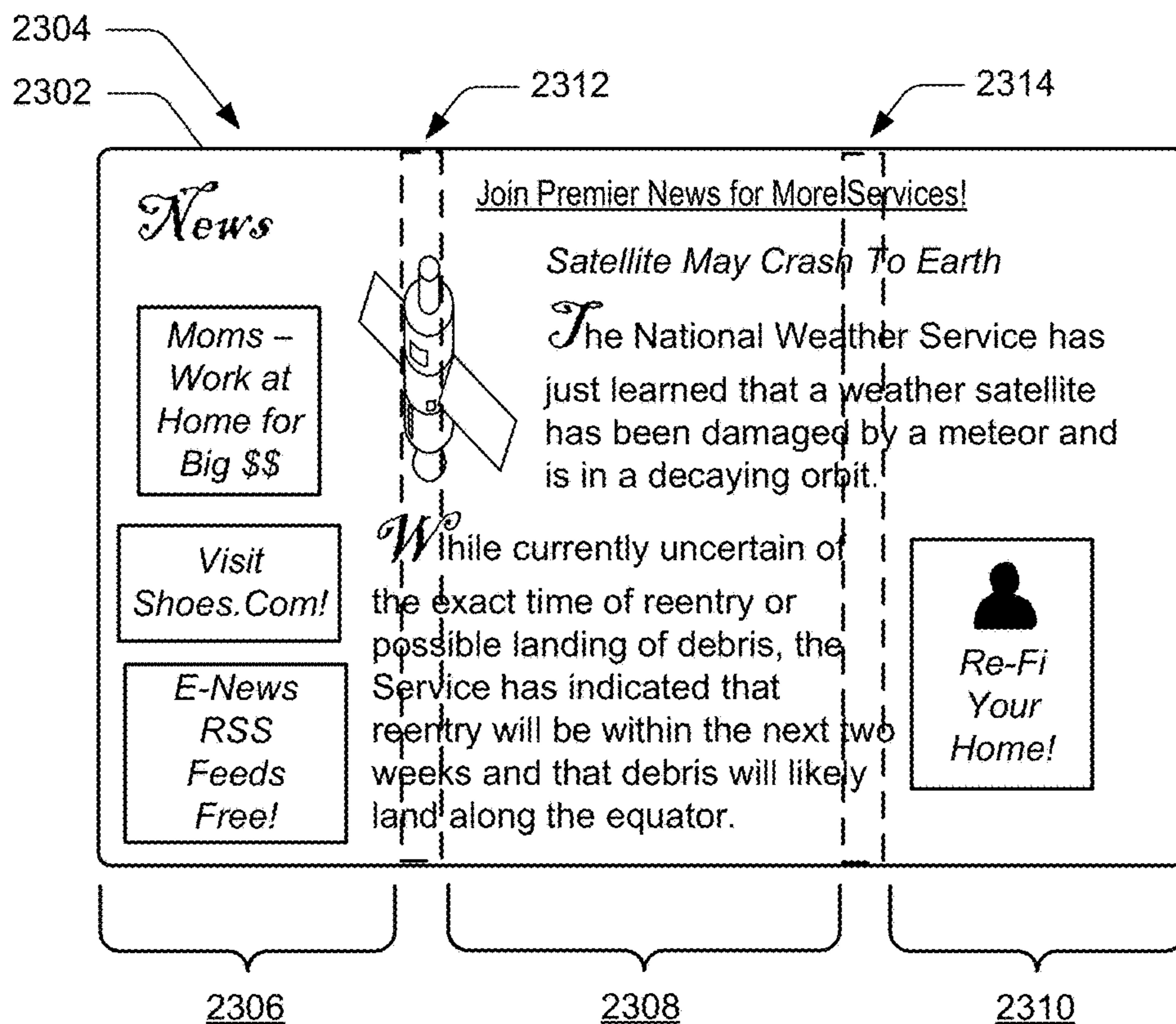

Fig. 23

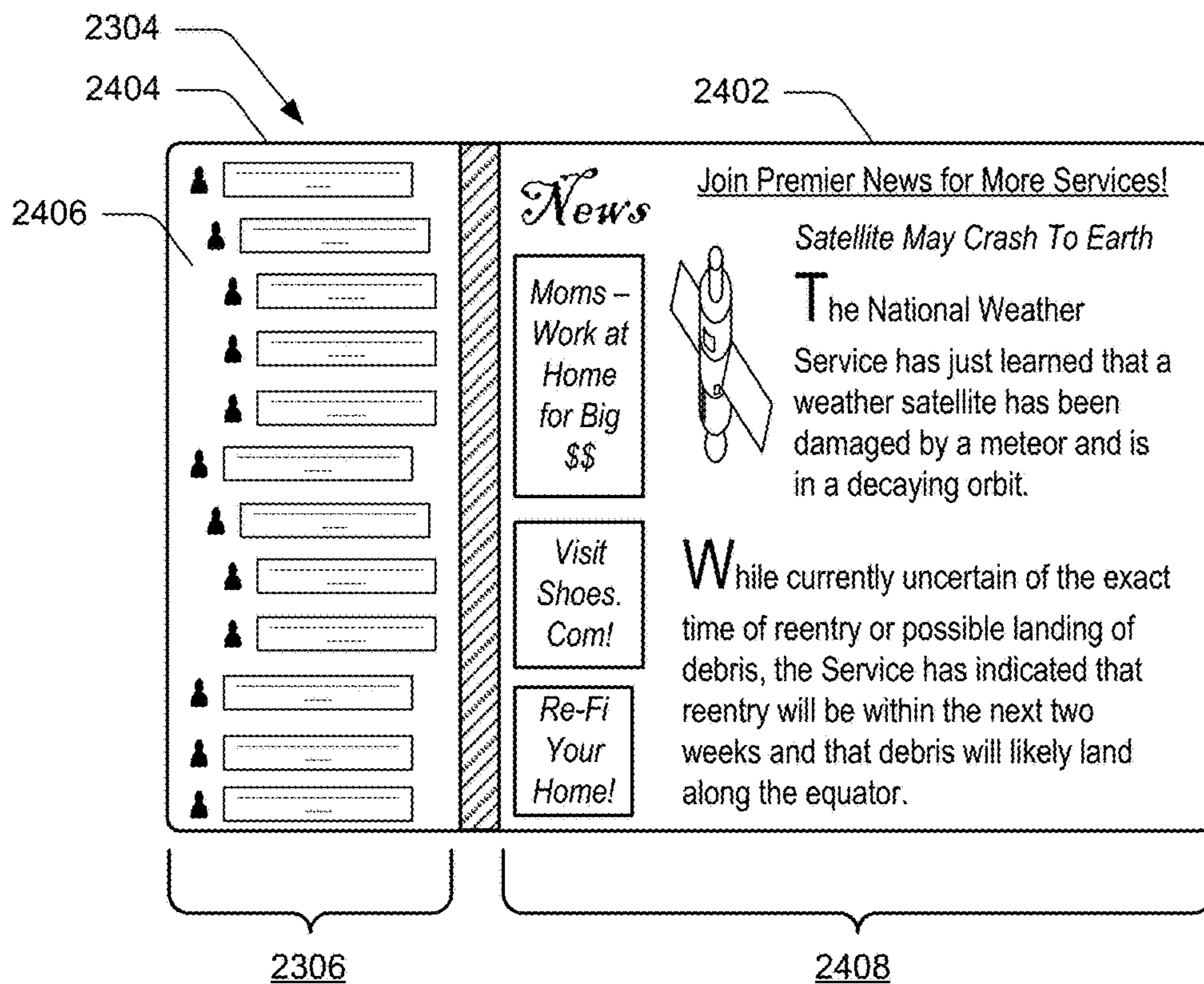

Fig. 24

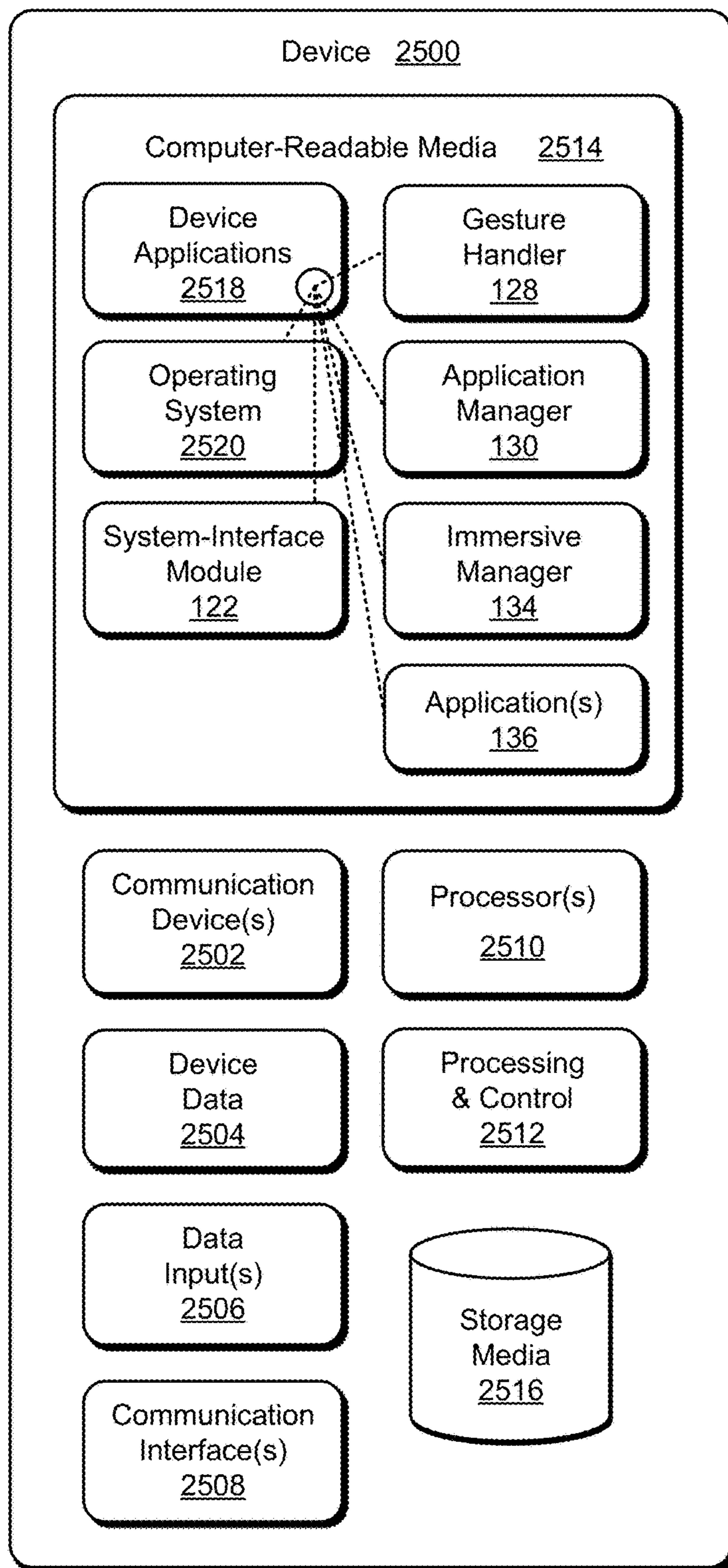

Fig. 25

1

MANAGING AN IMMERSIVE INTERFACE IN A MULTI-APPLICATION IMMERSIVE ENVIRONMENT

RELATED APPLICATIONS

This application is a continuation of and claims priority under 35 U.S.C. § 120 to U.S. patent application Ser. No. 13/657,621 filed Oct. 22, 2012, entitled “Managing An Immersive Interface in a Multi-Application Immersive Environment”, the disclosure of which is incorporated by reference herein in its entirety. U.S. patent application Ser. No. 13/657,621 is a continuation of and claims priority under 35 U.S.C. § 120 to U.S. patent application Ser. No. 13/118,333 filed May 27, 2011, entitled “Managing An Immersive Interface in a Multi-Application Immersive Environment”, now U.S. Pat. No. 9,158,445, and additionally, is a continuation of and claims priority under 35 U.S.C. § 120 to U.S. patent application Ser. No. 13/118,321 filed May 27, 2011, entitled “Managing An Immersive Interface in a Multi-Application Immersive Environment” the disclosure of each of which are incorporated by reference herein in their entirety.

BACKGROUND

Conventional techniques permit users to view multiple computing applications through multiple windows. Each of these windows generally includes a frame having controls for moving, sizing, or otherwise managing the layout of the window. Moving, sizing, or otherwise managing windows through these controls, however, can be time consuming or result in a poor user experience.

SUMMARY

This document describes techniques and apparatuses for managing an immersive interface in a multi-application immersive environment. In some embodiments, these techniques and apparatuses enable a user to alter sizes and/or a layout of multiple immersive interfaces with as little as one selection.

This summary is provided to introduce simplified concepts for managing an immersive interface in a multi-application immersive environment that are further described below in the Detailed Description. This summary is not intended to identify essential features of the claimed subject matter, nor is it intended for use in determining the scope of the claimed subject matter. Techniques and/or apparatuses for managing an immersive interface in a multi-application immersive environment are also referred to herein separately or in conjunction as the “techniques” as permitted by the context, though techniques may include or instead represent other aspects described herein.

BRIEF DESCRIPTION OF THE DRAWINGS

Embodiments for managing an immersive interface in a multi-application immersive environment are described with reference to the following drawings. The same numbers are used throughout the drawings to reference like features and components:

FIG. 1 illustrates an example system in which techniques for managing an immersive interface in a multi-application immersive environment can be implemented.

FIG. 2 illustrates an example method for enabling edge gestures that can be used to select to switch back to a

2

previously-interacted-with application, the edge gestures being approximately perpendicular to an edge in which the gesture begins.

FIG. 3 illustrates an example tablet computing device having a touch-sensitive display presenting an immersive interface.

FIG. 4 illustrates the example immersive interface of FIG. 3 along with example edges.

FIG. 5 illustrates the example immersive interface of FIGS. 3 and 4 along with angular variance lines from a perpendicular line and a line from a start point to a later point of a gesture.

FIG. 6 illustrates the edges of the immersive interface shown in FIG. 4 along with two regions in the right edge.

FIG. 7 illustrates an application-selection interface presented by a system-interface module in response to an edge gesture made over the immersive interface and webpage of FIG. 3.

FIG. 8 illustrates an example method for enabling edge gestures including determining an interface to present based on some factor of the gesture.

FIG. 9 illustrates an example method enabling expansion of, or ceasing presentation of, a user interface presented in response to an edge gesture or presentation of another user interface.

FIG. 10 illustrates a laptop computer having a touch-sensitive display having a windows-based email interface and two immersive interfaces.

FIG. 11 illustrates the interfaces of FIG. 10 along with two gestures having a start point, later points, and one or more successive points.

FIG. 12 illustrates the windows-based email interface of FIGS. 10 and 11 along with an email handling interface presented in response to an edge gesture.

FIG. 13 illustrates the interfaces of FIG. 12 along with an additional-email-options interface presented in response to a gesture determined to have a successive point a preset distance from the edge.

FIG. 14 illustrates a method for switching back to a previously-interacted-with application using a queue.

FIG. 15 illustrates an example interaction order in which a user interacts with various applications.

FIG. 16 illustrates the immersive interface of FIG. 3 along with a thumbnail image of a user interface of a prior application.

FIG. 17 illustrates a method for switching back to a previously-interacted-with application, which may or may not use a queue.

FIG. 18 illustrates the immersive interface of FIGS. 3 and 16, two progressive presentations, and two gesture portions.

FIG. 19 illustrates a method for managing an immersive interface in a multi-application immersive environment, including altering sizes of multiple immersive interfaces responsive to a single selection.

FIG. 20 illustrates the desktop computing device of FIG. 1 having a touch-sensitive display shown displaying a multi-application immersive environment with two immersive interfaces divided by an interface divider region.

FIG. 21 illustrates the multi-application immersive environment of FIG. 20 with sizes of the two immersive interfaces altered and the interface divider region moved.

FIG. 22 illustrates a method for displaying an immersive interface of an application in a region responsive to as little as one selection and at a size fully occupying the region.

FIG. 23 illustrates a current immersive interface fully occupying a multi-application immersive environment having three regions.

FIG. 24 illustrates the multi-application immersive environment of FIG. 23 with a reduced-size immersive interface instead of the current immersive interface of FIG. 23 and a second immersive interface.

FIG. 25 illustrates an example device in which techniques for managing an immersive interface in a multi-application immersive environment can be implemented.

DETAILED DESCRIPTION

Overview

This document describes techniques and apparatuses for managing an immersive interface in a multi-application immersive environment. These techniques, in some embodiments, enable a user to quickly and easily size, select, and layout one or multiple immersive interfaces.

Consider first a conventional case where a user wishes to view two applications using as much of her display as possible when working in a windows-based environment. To view her two applications using as much display as possible, she will likely need to find a sizing control on one of the windows, carefully drag out the sizing control to expand the window, and then move the window to the desired area of the display. After doing so, she may then select the other window to make it primary and thus interact with it, then move the window, then find and select the sizing control on the window, and then drag the sizing control to expand the window. Even after doing so, there can be parts of the display not occupied by one of the windows or some overlap of the windows, thereby occluding a window. Further, some of her display will be taken up with frames of the windows that might otherwise have been used to view content of the applications. Furthermore, in some cases an application can be unaware of the size at which an interface is displayed, thereby further causing content to be laid out in a less-than-optimal fashion.

Assume again that the user wishes to view two applications using as much of her display as possible. In contrast to the conventional case, however, she is working in a multi-application immersive environment managed by the described techniques. In this example, her display is occupied by a single immersive user interface occupying all or nearly all of her display as part of the multi-application immersive environment. To view the two applications, the techniques enable the user to simply select the other application in response to which an immersive interface for the other application will automatically be sized to fit a region of the multi-application immersive environment and the currently displayed immersive interface resized to fit another region of the environment.

The techniques also enable the user to resize interfaces for applications that are already presented. Assume in this second case that both of the two applications are part of the multi-application immersive environment and that the user wishes to change their sizes. The techniques permit her to resize both of them simultaneously with as little as one simple selection. She may slide an immersive interface divider between the two immersive interfaces, for example, with a simple select-and-move gesture. In response, the techniques resize both immersive interfaces.

These are but two examples of many ways in which the techniques enabling managing an immersive interface in a multi-application immersive environment, others of which are described below.

Example System

FIG. 1 illustrates an example system 100 in which techniques for managing an immersive interface in a multi-

application immersive environment can be embodied. System 100 includes a computing device 102, which is illustrated with six examples: a laptop computer 104, a tablet computer 106, a smart phone 108, a set-top box 110, a desktop computer 112, and a gaming device 114, though other computing devices and systems, such as servers and netbooks, may also be used.

Computing device 102 includes computer processor(s) 116 and computer-readable storage media 118 (media 118). Media 118 includes an operating system 120, windows-based mode module 122, immersive mode module 124, system-interface module 126, gesture handler 128, application manager 130, which includes or has access to application queue 132, immersive manager 134, and one or more applications 136, each having one or more application user interfaces 138.

Computing device 102 also includes or has access to one or more displays 140 and input mechanisms 142. Four example displays are illustrated in FIG. 1. Input mechanisms 142 may include gesture-sensitive sensors and devices, such as touch-based sensors and movement-tracking sensors (e.g., camera-based), as well as mice (free-standing or integral with a keyboard), track pads, and microphones with accompanying voice recognition software, to name a few. Input mechanisms 142 may be separate or integral with displays 140; integral examples include gesture-sensitive displays with integrated touch-sensitive or motion-sensitive sensors.

Windows-based mode module 122 presents application user interfaces 138 through windows having frames. These frames may provide controls through which to interact with an application and/or controls enabling a user to move and resize the window.

Immersive mode module 124 provides an environment by which a user may view and interact with one or more of applications 136 through application user interfaces 138. In some embodiments, this environment presents content of, and enables interaction with, applications with little or no window frame and/or without a need for a user to manage a window frame's layout or primacy relative to other windows (e.g., which window is active or up front) or manually size or position application user interfaces 138.

This environment can be, but is not required to be, hosted and/or surfaced without use of a windows-based desktop environment. Thus, in some cases immersive mode module 124 presents an immersive environment that is not a window (even one without a substantial frame) and precludes usage of desktop-like displays (e.g., a taskbar). Further still, in some embodiments this immersive environment is similar to an operating system in that it is not closeable or capable of being un-installed. While not required, in some cases this immersive environment enables use of all or nearly all of the pixels of a display by applications. Examples of immersive environments are provided below as part of describing the techniques, though they are not exhaustive or intended to limit the techniques described herein.

System-interface module 126 provides one or more interfaces through which interaction with operating system 120 is enabled, such as an application-launching interface, a start menu, or a system tools or options menu, to name just a few.

Operating system 120, modules 122, 124, and 126, as well as gesture handler 128, application manager 130, and immersive manager 134 can be separate from each other or combined or integrated in any suitable form.

Example Methods

Example methods 200, 800, and 900 address edge gestures, example methods 1400 and 1700 address switching

back to a previously-interacted-with application, and example methods **1900** and **2200** address managing an immersive interface in a multi-application immersive environment. The methods may be used separately or in combination with each other, in whole or in part. For example, an edge gesture may be used to select and size applications in a multi-application immersive environment. Or an application queue may be used to select a previously-interacted-with application which is then sized to fit a region of the multi-application immersive environment. Use of an edge gesture or an application queue, however, is not required by methods **1900** and/or **2200**.

FIG. **2** depicts a method **200** for enabling edge gestures based on the edge gesture being approximately perpendicular to an edge in which the gesture begins. In portions of the following discussion reference may be made to system **100** of FIG. **1**, reference to which is made for example only.

Block **202** receives a gesture. This gesture may be received at various parts of a display, such as over a windows-based interface, an immersive interface, or no interface. Further, this gesture may be made and received in various manners, such as a pointer tracking a movement received through a touch pad, mouse, or roller ball or a physical movement made with arm(s), finger(s), or a stylus received through a motion-sensitive or touch-sensitive mechanism.

By way of example consider FIG. **3**, which illustrates a tablet computing device **106**. Tablet **106** includes a touch-sensitive display **302** shown displaying an immersive interface **304** that includes a webpage **306**. As part of an ongoing example, at block **202** gesture handler **128** receives gesture **308** as shown in FIG. **3**.

Block **204** determines whether a start point of the gesture is at an edge. As noted above, the edge in question can be an edge of a user interface, whether immersive or windows-based, and/or of a display. In some cases, of course, an edge of a user interface is also an edge of a display. The size of the edge can vary based on various factors about the display or interface. A small display or interface may have a smaller size in absolute or pixel terms than a large display or interface. A highly sensitive input mechanism permits a smaller edge as well. Example edges are rectangular and vary between one and twenty pixels in one dimension and an interface limit of the interface or display in the other dimension, though other sizes and shapes, including convex and concave edges may instead be used.

Continuing the ongoing example, consider FIG. **4**, which illustrates immersive interface **304** and gesture **308** of FIG. **3** as well as left edge **402**, top edge **404**, right edge **406**, and bottom edge **408**. For visual clarity webpage **306** is not shown. In this example the dimensions of the interface and display are of a moderate size, between that of smart phones and that of many laptop and desktop displays. Edges **402**, **404**, **406**, and **408** have a small dimension of twenty pixels, an area of each shown bounded by dashed lines at twenty pixels from the display or interface limit at edge limit **410**, **412**, **414**, and **416**, respectively.

Gesture handler **128** determines that gesture **308** has a start point **418** and that this start point **418** is within left edge **402**. Gesture handler **128** determines the start point in this case by receiving data indicating [X,Y] coordinates in pixels at which gesture **308** begins and comparing the first of these coordinates to those pixels contained within each edge **402-408**. Gesture handler **128** often can determine the start point and whether it is in an edge faster than a sample rate, thereby causing little or no performance downgrade from

techniques that simply pass gestures directly to an exposed interface over which a gesture is made.

Returning to method **200** generally, if block **204** determines that the start point of the gesture is not at an edge, method **200** proceeds along a “No” path to block **206**. Block **206** passes the gestures to an exposed user interface, such as an underlying interface over which the gesture was received. Altering the ongoing example, assume that gesture **308** was determined not to have a start point within an edge. In such a case gesture handler **128** passes buffered data for gesture **308** to immersive user interface **304**. After passing the gesture, method **200** ends.

If block **204** determines that the start point of the gesture is in an edge, method **200** proceeds along a “Yes” path to block **208**. Block **208** responds to the positive determination of block **204** by determining whether a line from the start point to a later point of the gesture is approximately perpendicular from the edge.

Block **208**, in some embodiments, determines the later point used. Gesture handler **128**, for example, can determine the later point of the gesture based on the later point being received a preset distance from the edge or the start point, such as past edge limit **410** for edge **402** or twenty pixels from start point **418**, all of FIG. **4**. In some other embodiments, gesture handler **128** determines the later point based on it being received a preset time after receipt of the start point, such an amount of time slightly greater than used generally by computing device **102** to determine that a gesture is a tap-and-hold or hover gesture.

For the ongoing embodiment, gesture handler **128** uses a later-received point of gesture **308** received outside of edge **402** so long as that later-received point is received within a preset time. If no point is received outside of the edge within that preset time, gesture handler **128** proceeds to block **206** and passes gesture **308** to immersive interface **304**.

Using the start point, block **208** determines whether a line from the start point to the later point of the gesture is approximately perpendicular to the edge. Various angles of variance can be used in this determination by block **208**, such as five, ten, twenty, or thirty degrees.

By way of example, consider an angle of variance of thirty degrees from perpendicular. FIG. **5** illustrates this example variance, showing immersive interface **304**, gesture **308**, left edge **402**, left edge limit **410**, and start point **418** of FIGS. **3** and **4** along with a thirty-degree variance lines **502** from perpendicular line **504**. Thus, gesture handler **128** determines that line **506** from start point **418** to later point **508** (which is at about twenty degrees from perpendicular) is approximately perpendicular based on being within the example thirty-degree variance line **502**.

Generally, if block **208** determines that the line is not approximately perpendicular to the edge, method **200** proceeds along a “No” path to block **206**. As noted in part above, block **208** may also determine that a later point or other aspect of a gesture disqualifies the gesture. Examples include when a later point is within the edge, such as due to a hover, tap, press-and-hold, or up-and-down gesture (e.g., to scroll content in the user interface), or when the gesture is set to be a single-input gesture and a second input is received (e.g., a first finger starts at an edge but a second finger then lands anywhere).

If block **208** determines that the line is approximately perpendicular based a later point outside the edge, method **200** proceeds along a “Yes” path to block **210**.

Block **210** responds to the positive determination of block **208** by passing the gesture to an entity other than the exposed user interface. This entity is not a user interface

over which the gesture was received, assuming it was received over a user interface at all. Block **210** may determine to which entity to pass the gesture as well, such as based on an edge or region of an edge in which the start point of the gesture is received. Consider FIG. 6, for example, which illustrates immersive interface **304** and edges **402**, **404**, **406**, and **408** of FIG. 4 but adds top region **602** and bottom region **604** to right edge **406**. A start point in top region **602** can result in a different entity (or even a same entity but a different user interface provided in response) than a start point received to bottom region **604**. Likewise, a start point in top edge **404** can result in a different entity or interface than left edge **402** or bottom edge **408**.

In some cases, this entity is an application associated with the user interface. In such a case, passing the gesture to the entity can be effective to cause the application to present a second user interface enabling interaction with the application. In the movie example above, the entity can be the media player playing the movie but not the immersive interface displaying the movie. The media player can then present a second user interface enabling selection of subtitles or a director's commentary rather than selections enabled by the interface displaying the movie, such as "pause," "play," and "stop." This capability is permitted in FIG. 1, where one of applications **136** can include or be capable of presenting more than one application user interface **138**. Thus, block **210** can pass the gesture to system-interface module **126**, the one of applications **136** currently presenting the user interface, or another of applications **136**, to name just three possibilities.

Concluding the ongoing embodiment, at block **210** gesture handler **128** passes gesture **308** to system-interface module **126**. System-interface module **126** receives the buffered portion of gesture **308** and continues to receive the rest of gesture **308** as it is made by the user. FIG. 7 illustrates a possible response upon receiving gesture **308**, showing an application-selection interface **702** presented by system-interface module **126** and over immersive interface **304** and webpage **306** from FIG. 3. Application-selection interface **702** enables selection of various other applications and their respective interfaces at selectable application tiles **704**, **706**, **708**, and **710**.

The example application-selection interface **702** is an immersive user interface presented using immersive mode module **124**, though this is not required. Presented interfaces may instead be windows-based and presented using windows-based module **122**. Both of these modules are illustrated in FIG. 1.

Block **210** may also or instead determine to pass the gesture to different entities and/or interfaces based on other factors about the gesture received. Example factors are described in greater detail in method **800** below.

Note that method **200** and other methods described hereafter can be performed in real-time, such as while a gesture is being made and received. This permits, among other things, a user interface presented in response to a gesture to be presented prior to completion of the gesture. Further, the user interface can be presented progressively as the gesture is received. This permits a user experience of dragging out the user interface from the edge as the gesture is performed with the user interface appearing to "stick" to the gesture (e.g., to a mouse point or person's finger making the gesture).

FIG. 8 depicts a method **800** for enabling edge gestures including determining an interface to present based on some factor of the gesture. In portions of the following discussion reference may be made to system **100** of FIG. 1, reference

to which is made for example only. Method **800** may act wholly or partly separate from or in conjunction with other methods described herein.

Block **802** determines that a gesture made over a user interface has a start point at an edge of the user interface and a later point not within the edge. Block **802** may operate similarly to or use aspects of method **200**, such as determining a later point on which to base block **802**'s determination. Block **802** may act differently as well.

In one case, for example, block **802** determines that a gesture is a single-finger swipe gesture starting at an edge of an exposed immersive user interface and having a later point not at the edge but not based on an angle of the gesture. Based on this determination, block **802** proceeds to block **804** rather than pass the gesture to the exposed immersive user interface.

Block **804** determines which interface to present based on one or more factors of the gesture. Block **804** may do so based on a final or intermediate length of the gesture, whether the gesture is single or multi-point (e.g., a single-finger or multi-finger gesture), or a speed of the gesture. Thus, block **804** may determine to present a start menu in response to a multi-finger gesture, an application-selection interface in response to a relatively short single-finger gesture, or a system-control interface permitting selection to shut down computing device **102** in response to relatively long single-finger gesture, for example. To do so, gesture handler **128** may determine the length of the gesture or a number of inputs (e.g., fingers). In response, block **806** presents the determined user interface.

Assume, by way of example, that gesture handler **128** determines, based on a factor of the gesture, to present a user interface enabling interaction with operating system **120**. In response system-interface module **126** presents this user interface. Presentation of the user interface can be similar to manners described in other methods, such as with a progressive display of application-selection user interface **702** of FIG. 7.

Following method **200** and/or method **800** in whole or in part, the techniques may proceed to perform method **900** of FIG. 9. Method **900** enables expansion of a user interface, presentation of another interface, or ceasing presentation of the user interface presented in response to an edge gesture.

Block **902** receives a successive point of the gesture and after presentation of at least some portion of the second user interface. As noted in part above, methods **200** and/or **800** are able to present or cause to be presented a second user interface, such as a second user interface for the same application associated with a current user interface, a different application, or a system user interface.

By way of example, consider FIG. 10, which illustrates a laptop computer **104** having a touch-sensitive display **1002** displaying a windows-based email interface **1004** and two immersive interfaces **1006** and **1008**. Windows-based email interface **1004** is associated with an application that manages email, which can be remote or local to laptop computer **104**. FIG. 10 also illustrates two gestures, **1010** and **1012**. Gesture **1010** proceeds in a straight line while gesture **1012** reverses back (shown with two arrows to show two directions).

FIG. 11 illustrates gesture **1010** having a start point **1102**, a later point **1104**, and a successive point **1106**, and gesture **1012** having a same start point **1102**, a later point **1108**, and a first successive point **1110**, and a second successive point **1112**. FIG. 11 also shows a bottom edge **1114**, a later-point area **1116**, and an interface-addition area **1118**.

Block **904** determines, based on the successive point, whether the gesture includes a reversal, an extension, or neither. Block **904** may determine a reversal by determining that a successive point is at the edge or is closer to the edge than a prior point of the gesture. Block **904** may determine that the gesture extends based on the successive point being a preset distance from the edge or the later point. If neither of these is determined to be true, method **900** may repeat blocks **902** and **904** to receive and analyze additional successive points until the gesture ends. If block **904** determines that there is a reversal, method **900** proceeds along “Reversal” path to block **906**. If block **904** determines that the gesture is extended, method **900** proceeds along an “Extension” path to block **908**.

In the context of the present example, assume that gesture handler **128** receives first successive point **1110** of gesture **1012**. Gesture handler **128** then determines that first successive point **1110** is not at edge **1114**, is not closer than a prior point of the gesture to edge **1114** (e.g., is not closer than later point **1108**), and is not a preset distance from the edge or later point by not being within interface-addition region **1118**. In such a case method **900** returns to block **902**.

On a second iteration of block **902**, assume that gesture handler **128** receives second successive point **1112**. In such a case, gesture handler **128** determines that second successive point **1112** is closer to edge **1114** than first successive point **1110** and thus gesture **1012** includes a reversal. Gesture handler **128** then proceeds to block **906** to cease to present the second user interface previously presented in response to the gesture. By way of example, consider FIG. **12**, which illustrates an email handling interface **1202**. In this example case of block **906**, gesture handler **128** causes the email application to cease to present interface **1202** in response to a reversal of gesture **1012** (not shown removed).

Block **908**, however, presents or causes presentation of a third user interface or expansion of the second user interface. Continuing the ongoing example, consider FIG. **13**, which illustrates additional-email-options interface **1302** in response to gesture **1010** determined to have successive point **1106** a preset distance from edge **1104**, in this case being within interface-addition region **1118** of FIG. **11**. This region and preset distance can be set based on a size of the user interface previously presented in response to the gesture. Thus, a user wishing to add additional controls may simply extend the gesture past the user interface presented in response to an earlier portion of the gesture.

Method **900** can be repeated to add additional user interfaces or expand a presented user interface. Returning to the example interface **702** of FIG. **7**, for example, gesture handler **128** can continue to add interfaces or controls to interface **702** as gesture **308** extends past interface **702**, such as by presenting an additional set of selectable application tiles. If gesture **308** extends past the additional tiles, gesture handler **128** may cause system-interface module **124** to present another interface adjacent the tiles to enable the user to select controls, such as to suspend, hibernate, switch modes (immersive to windows-based and the reverse), or shut down computing device **102**.

While the above example user interfaces presented in response to an edge gesture are opaque, they may also be partially transparent. This can be useful by not obscuring content. In the movie example described above, a user interface presented can be partially transparent thereby permitting the movie to be only partially obscured during use of the user interface. Similarly, in the example of FIGS. **12** and **13**, interfaces **1202** and **1302** may be partially

transparent, thereby enabling a user to see the text of the email while also selecting a control in one of the interfaces.

As noted above, example methods **200**, **800**, and **900** address edge gestures and are described prior to methods **1400** and **1700**, which address switching back to a previously-interacted-with application. Any one or more of the method may be used separately or in combination with, in whole or in part, others of the methods.

FIG. **14** depicts a method **1400** for switching back to a previously-interacted-with application using a queue. In portions of the following discussion reference may be made to system **100** of FIG. **1**, methods **200**, **800**, and/or **900**, and example embodiments described above, reference to which is made for example only.

Block **1402** maintains a queue of multiple interacted-with applications, the queue arranged by most-recently-interacted-with to least-recently-interacted-with applications other than a current application. Consider, for example, FIG. **15**, which illustrates an interaction order **1502** in which a user interacts with various applications. First, the user interacts with a web-searching application **1504** through its interface. Second, the user interacts with a web-enabled media application **1506** through a web browser. Third, the user interacts with a local (non-web) photo application **1508** through its interface. Fourth, the user interacts with a social-networking application **1510** through the web browser. Fifth, the user returns to interacting with the web-enabled media application **1506**. Sixth, the user interacts with a web-enabled news application **1512** again through the web browser.

For the first interaction no queue is maintained as no other applications have been interacted with prior to this first interaction. For the second through sixth interactions of interaction order **1502**, consider queues **1514**, **1516**, **1518**, **1520**, and **1522**, which correspond to each interaction in interaction order **1502** after the first interaction, respectively. Queues **1514** to **1522** are example iterations of application queue **132** maintained by application manager **130**, both of FIG. **1**.

As shown in FIG. **15**, application manager **130** keeps application queue **132** up-to-date based on a user’s interactions. Queue **1522**, for example, includes media application **1506** as the most-recently-interacted application, followed by social-networking application **1510**, photo application **1508**, and ending with web-searching application **1504**. As the user interacts with media application **1506** twice (at the second and fifth interaction) application manager **130** removes it from application queue **130** at the fifth interaction and reorders the other applications to reflect an up-to-date order of interactions but excluding currently-interacted-with applications.

Block **1404** receives a gesture or gesture portions. This gesture or gesture portions can include one or more of the various gestures or portions described elsewhere herein, such as a pointer tracking a movement received through a touch pad, mouse, or roller ball or a physical movement made with arm(s), finger(s), or a stylus received through a motion-sensitive or touch-sensitive mechanism. In some embodiments, gesture portions are received, each portion being part of one gesture and each resulting in presentation of an application in the queue. Each of these portions may have, but are not required to have, a start point at an edge of a display, a later point not at the edge of the display, and a successive point at the edge of the display. A gesture having multiple portions in this case would look something like a multi-loop spiral, multiple circles, or a back-and-forth (e.g., zigzag) where each loop, circle, or back-and-forth starts,

11

leaves, and returns to an edge of a user interface or display. Optionally, block 1404 may receive a number of gestures or gesture portions. These gestures or gesture portions can include one or more of the various gestures or gestures portions described elsewhere herein.

Continuing the ongoing embodiment, consider again FIG. 3, which illustrates tablet computing device 106 having touch-sensitive display 302 shown displaying immersive interface 304 including webpage 306. For this example, assume that immersive interface 304 is associated with news application 1512 and that webpage 306 is content from news application 1512.

As part of this example, at block 1404, gesture handler 128 receives gesture 308 as shown in FIG. 3, which gesture handler 128 passes to application manager 130. For the ongoing example, assume that gesture 308 is determined to be associated with switching back to a previously-interacted-with application rather than some other function or application.

Block 1406, responsive to receiving the gesture or gesture portions, proceeds through the queue to another application of the multiple interacted-with applications. Thus, on receiving the gesture or gesture portion(s), application manager 130 may proceed to the first, and thus the most-recently-interacted-with of the applications of application queue 132. In some embodiments, on receiving two gestures or portions, application manager 130 may proceed to the second most-recently-interacted-with application of application queue 132, though method 1400 may do so by repeating blocks 1404, 1406 and/or 1408, and so forth as described below.

Continuing the ongoing embodiment, assume that gesture 308 is received after the sixth interaction at which time the currently-interacted-with application is news application 1512 and that application queue 132 is up-to-date and represented by queue 1522 of FIG. 15. In such a case, application manager 130 proceeds to media application 1506 on receiving the gesture or gesture portion.

Block 1408 presents a user interface associated with the other application. This user interface, in some embodiments, is the same user interface through which interaction with the application was previously made. In some embodiments, the user interface is presented as a thumbnail or transparent overlay above the currently presented user interface. Application manager 130 presents this user interface alone or in combination with the associated application, such as by causing the associated application to present the user interface with which the user last interacted.

For this example, application manager 130 presents a thumbnail image of the user interface for the application progressively as gesture 308 is received and then expands the thumbnail to encompass the available real estate of the display when the gesture ends. Application manager 130 thereby replaces webpage 306 in immersive interface 304 or replaces immersive interface 304 with another interface, which can be immersive or windows-based.

This is illustrated in FIG. 16 with thumbnail image 1602 of a user interface of media application 1506 presented over immersive interface 304 and webpage 306 of news application 1510. After gesture 308 ends, thumbnail image 1602 expands into full image 1604, replacing webpage 306 in immersive interface 304. Note that application manager 130 may keep the thumbnail image of the user interface “live.” In effect, the thumbnail image may simply be a smaller version of the user interface; a video clip playing on the user

12

interface may still be playing on the thumbnail image of the user interface, and even during movement of that thumbnail image.

This is but one example manner for presenting the user interface for the selected application, others manners for responding progressively or otherwise are described elsewhere herein.

In some embodiments, block 1408 shrinks the current user interface to a second thumbnail image and passes the second thumbnail image toward a region of a display from which the first-mentioned thumbnail image is progressively presented. Thus, block 1408 expands thumbnail image 1602 into full image 1604 while shrinking webpage 306 to a thumbnail image and passing that thumbnail to the edge from which thumbnail image 1602 was selected.

During the presentation of the user interface at block 1408, another gesture or gesture portion may be received, returning to block 1404. In some cases, the other gesture or gesture portion is received within an amount of time while the user interface is presented by block 1408. Following the return to block 1404, block 1406 may then proceed to yet another or subsequent application of the multiple interacted-with applications. Continuing this progression, block 1408 then presents a user interface associated with the subsequent application of the multiple interacted-with applications.

Thus, by repeating blocks 1404, 1406, and 1408 user interfaces associated with previously interacted-with applications can be successively presented. In some cases, a user interface associated with a previously-interacted with application can be presented responsive to each gesture received. In the context of the present example, when another gesture is received while presenting the user interface of media application 1506, a user interface associated with social-networking application 1510 (the second most-recently interacted with application of queue 1522) is presented. Receiving yet another gesture or gesture portion during the presentation of the user interface associated with social-networking application 1510 results in a presentation of a user interface associated with photo application 1508 (the third most-recently interacted with application of queue 1522) and so forth.

Following this switch from presenting a current application to a presenting another selected, prior application, block 1410 updates the queue responsive to interaction with, or a time period passing during presentation of, the user interface associated with the other application. In some cases a prior application may be selected and then another quickly selected after it, effectively a scanning through of the applications in the queue. In such cases, block 1410 may forgo updating the queue, as a quick viewing may not be considered an interaction.

Example interactions with which application manager 130 updates application queue 132 include an explicit selection to interact with the newly presented interface, such as to control playback or edit information relating to currently playing media using controls shown in the user interface of media player 1604 of FIG. 16. In other cases an interaction is determined based on a time period passing. Assume, for example, that the news application’s webpage is presented on selection rather than being the current application. After some period, such as one, two, or three seconds, for example, application manager 130 determines that the delay is effectively an interaction based on a likelihood that the user is reading the news article in the webpage. Similarly, presentation of a user interface for a media application at block 1408 that is playing media and remains on the display

13

without another selection of applications in application queue 132 can also be considered an interaction.

As noted in part above, application queue 132 can be circular. In so doing, selection of applications is not stopped but rather rolls if a user reaches a least-recently-interacted with application of application queue 132. For example, on selecting to switch back to a prior application from social-networking application 1510 and thus using queue 1518, switching back once results in selecting photo application 1508, twice results in media application 1506, and three times to web-searching application 1504. A fourth selection to switch back returns, in a circular fashion, to again result in presenting photo application 1508.

Method 1400 describes various ways in which the techniques can enable selection of previously-interacted-with applications and determine which to present based on a queue. Method 1700 may operate in conjunction with method 1400 and other methods described herein, though using a queue is not required. Therefore, method 1400 is not intended to limit the techniques as described in example method 1700.

FIG. 17 depicts a method 1700 for switching back to a previously-interacted-with application, which may or may not use a queue. In portions of the following discussion reference may be made to system 100 of FIG. 1, methods 200, 800, 900, 1400, and example embodiments described above, reference to which is made for example only.

Block 1702 enables selection of a previously-interacted-with application through a gesture made over a current user interface associated with a current application. Block 1702 may do so in various manners described above, such as with an edge gesture or portion thereof, as but one example.

Block 1704, responsive to receiving the gesture and without further selection, presents a previous user interface associated with the previously-interacted-with application.

Assume, for example, that a portion of a gesture is received associated with selection of a prior application, such as an edge gesture starting at an edge of the current user interface and proceeding approximately perpendicularly away from the edge. In response, block 1704 presents the user interface for the previously-interacted-with application or a thumbnail image of the interface, or some indicator that selection has successfully been made along with an indicator of the application or the interface selected.

Example thumbnail images or indicators include any of selectable application tiles 704, 706, 708, and 710 of FIG. 7 some of which include a thumbnail image of an interface while others indicate the application selected. Another example is thumbnail image 1602 of FIG. 16.

Block 1704 presents the user interface of the selected, previously-interacted-with application, as shown in FIG. 16 at full image 1604. In so doing, block 1704 may enable interaction with photo application 1508 through immersive interface 304 without further selection. Thus, a user after selecting, with as little as one gesture, a prior application may interact without needing to make another selection. The user need not select to exit an application-selection mode, for example, or make the presented interface “live” or primary or on top of the stack. Simply put, the techniques enable selection of a prior application and further interaction with that prior application with a single input.

In this example of FIG. 16, immediately after full image 1604 is presented and replaces webpage 306, a next input to immersive interface 304 is passed immediately to photo application 1508. Thus, a tap, hot key, or other input is

14

passed directly to photo application 1508, thereby enabling an immediate response by photo application 1508 to the input.

In some embodiments, the gesture made over the current user interface includes portions, each of which indicates a selection of a prior application. In such a case, block 1704 presents the previous user interface in response to the first portion and then, responsive to block 1702 receiving the second portion of the gesture, presents a further-previous user interface associated with a further previously-interacted-with application, and so forth.

This is illustrated in FIG. 18, which presents immersive interface 304 of FIG. 16 (shown twice for visual clarity), and ways in which block 1704 can respond to multiple gestures or portions of a single gesture. FIG. 18 illustrates two progressive presentations, 1802 and 1804, and gesture 1806 having two gesture portions 1806-1 and 1806-2, respectively. First progressive presentation 1802 illustrates a drag from a left edge of immersive interface 304 of thumbnail image 1602, and thus selection of the previously-interacted with photo application 1508. Note that thumbnail image 1602 “sticks” to gesture portion 1806-1. Note also that gesture 1806, unlike gesture 308 of FIGS. 3 and 16, returns to the left edge. In response, rather than gesture 308 ending and full image 1604 replacing webpage 306, gesture portion 1806-1 of gesture 1806 returns to the edge at which it began. In this case thumbnail image 1602 is progressively displayed with gesture portion 1806-1 but then disappears when gesture portion 1806-1 returns to the edge.

Gesture 1806 continues with second portion 1806-2. In response, block 1704 presents second progressive presentation 1804, illustrating a second drag from the left edge of immersive interface 304. Here a social network thumbnail image 1808 of a further prior application, social-networking application 1510, is progressively presented. Gesture 1806 returns to the left edge as part of second portion 1806-2. In response, block 1704 drops off thumbnail image 1808 when gesture portion 1806-2 returns to the edge. This is but one example of ways in which the techniques enable users to select and view prior applications, even all of the previously-interacted-with applications, with only a single gesture. At any point in this example, gesture 1806 may end or indicate selection to present the full user interface for the selected application, at which time block 1704 presents the user interface (e.g., full image 1604 of FIG. 16 or a full user interface for the social-networking application).

As noted above, example methods 200, 800, and 900 address edge gestures and are described prior to methods 1400 and 1700, which address switching back to a previously-interacted-with application, which are in turn described prior to methods 1900 and 2200. Any one or more of the method may be used separately or in combination with, in whole or in part, others of the methods.

FIG. 19 depicts a method 1900 for managing an immersive interface in a multi-application immersive environment, including altering sizes of multiple immersive interfaces responsive to a single selection. In portions of the following discussion reference may be made to system 100 of FIG. 1, methods 200, 800, 900, 1400, and 1700, and example embodiments described above, reference to which is made for example only.

Block 1902 enables selection to alter a first size of a first immersive interface of a first application displayed in a multi-application immersive environment in which a second immersive interface of a second application is displayed at a second size.

Block **1902** can enable this selection in various manners set forth above, such as with a gesture, whether made through a gesture-sensitive display or a track pad or mouse, or with a hardware button or hot keys, to name just a few.

Consider, by way of example, a case where block **1902** enables a select-and-move gesture selection through a gesture-sensitive display, the select-and-move gesture of an interface divider region between immersive interfaces of a multi-application immersive environment. This example is illustrated in FIG. **20**, which illustrates a desktop computing device **112** having a touch-sensitive display **2002** shown displaying a multi-application immersive environment **2004**. Multi-application immersive environment **2004** includes a larger immersive interface **2006** and a smaller immersive interface **2008** separated by an immersive interface divider **2010**. Larger immersive interface **2006** is associated with a word-processing application and presents document content **2012**. Smaller immersive interface **2008** is associated with a software mapping application and presents mapping content **2014**. As part of an ongoing example, at block **1902** immersive manager **134** receives gesture **2016** as shown in FIG. **20**, shown with an arrow but omitting an input actor (e.g., a finger or stylus).

Block **1904**, responsive to selection to alter the first size of the first immersive interface, alters the first size of the first immersive interface and the second size of the second immersive interface. Block **1904**, therefore, may alter sizes of multiple immersive interfaces responsive to as few as one selection. Further, block **1904** may do so concurrently and without occluding either of the interfaces. Further, in some embodiments, block **1904** notifies the application associated with the immersive interface about the change in size, thereby enabling the application to reflow the content.

By way of example, consider the ongoing example of FIG. **20**. Responsive to select-and-move gesture **2016** of interface divider region **2010**, immersive manager **134** reduces one interface and increases the other concurrently, here increasing smaller immersive interface **2008** and decreasing, at the same time, larger immersive interface **2006**. The result of this alteration is illustrated in FIG. **21** at altered smaller immersive interface **2102** and altered larger immersive interface **2104**. The prior position of interface divider region **2010** is shown at prior position **2106**. Note also that select-and-move gesture **2016** starts at prior position **2106** of interface divider region **2010** and ends at final position **2108** of interface divider region **2010**. While not illustrated, a user may select to move the interface divider region to an edge of the multi-application immersive environment. In response, block **1904** removes the interface being reduced from the environment.

Note that in this example, multi-application immersive environment **2004** is fully occupied with the immersive interfaces, both prior to and after altering sizes of the immersive interfaces, without unused real estate or real estate occluded with controls for managing the immersive interfaces.

This particular example illustrates one way in which the techniques permit a user to select sizes of immersive interfaces, here to increase a map presented by the mapping application.

The techniques also permit users to “snap” immersive interfaces to automatically fill a predetermined region of multi-application immersive environment **2004**. By so doing, gestures and other selections can be used that are fast and easy for users. Further, these regions can have a predetermined size across multiple devices, thereby permitting application developers to prepare for the region sizes. This

is especially useful for smaller region sizes, as smaller sizes are often more challenging to present in a user-friendly manner. Consider again FIG. **20**, for example, which illustrates a predetermined small-region width **2018** having a width of 320 pixels (though other widths may instead be used). In this example, three widths in which to present content are shown, width **2018**, remainder width **2020**, and a full width **2022** of multi-application immersive environment **2004**. Note that remainder width **2020** can vary across displays, as can full width **2022**.

Block **1902** may also enable selection through a drag-and-drop gesture of one of the immersive interfaces from one region to another region. In such a case block **1904** may switch the interfaces between the regions or automatically move a divider (e.g., immersive interface divider **2010** of FIG. **20**) such that resulting sizes are switched. By so doing, immersive manager **134** automatically reduces larger immersive interface **2006** to fully occupy a region previously occupied by smaller immersive interface **2008** and vice-versa.

In some cases selection to alter a size of an interface is enabled through an edge gesture. Consider, for example, an edge gesture starting at an edge of larger immersive interface **2006** and having a later point not at the edge of larger immersive interface **2006**. Immersive manager **134**, alone or in conjunction with gesture handler **128** and/or application manager **130**, shrinks larger immersive interface **2006** to a reduced size. Selection to resize interface **2006**, then, can be performed by dropping the reduced-size image over smaller immersive interface **2008**. In response, immersive manager **134** resizes both interfaces.

Method **1900** describes various ways for managing an immersive interface in a multi-application immersive environment, including altering sizes of multiple immersive interfaces responsive to a single selection. Method **2200** may operate in conjunction with method **1900** and other methods described herein, though using a queue is not required. Therefore, method **1900** is not intended to limit the techniques as described in example method **2200**.

FIG. **22** depicts a method **2200** for displaying an immersive interface of an application in a region, including responsive to as little as one selection and at a size fully occupying the region. In portions of the following discussion reference may be made to system **100** of FIG. **1**, methods **200**, **800**, **900**, **1400**, **1700**, and **1900**, and example embodiments described above, reference to which is made for example only.

Block **2202** enables selection to display an immersive interface of an application in one of multiple regions of a multi-application immersive environment displaying one or more current immersive interfaces of one or more current applications. Block **2202** may do so in various manners described above, such as with an edge gesture or portion thereof, as but one example. Further, the application selected can be a previously-interacted with application determined in various manners, such as by application manager **130** using application queue **132**, both of FIG. **1**.

The multi-application immersive interface can, at block **2202**, present one, two, or even three current immersive interfaces. Thus, block **2202** permits selection of an application to place in regions currently occupied or that exist but are occupied by a larger immersive interface, such as in cases where one immersive interface fully occupies a multi-application immersive environment.

By way of example, consider FIG. **23**, which illustrates a current immersive interface **2302** fully occupying multi-application immersive environment **2304**. Note here that

there are three regions, **2306**, **2308**, and **2310**. These regions may be indicated or not. In cases where an application has been selected and is hovered or moved over one of the regions, the region can be indicated. In one example this indication is made with partially transparent immersive interface dividers **2312** and **2314**.

By way of example, assume that immersive manager **134** receives a previously-interacted-with application selected according to method **1700** and following the example illustrated in FIG. **18**. In such as case, assume that thumbnail image **1808** for social-networking application **1510** is selected and hovered over region **2306** (not shown but similar to FIG. **18**). In response, immersive manager **134** indicates that region **2306** is or is about to be selected and the size of region **2306** by displaying partially transparent immersive interface divider **2312**. Alternatively, immersive manager **134** may indicate that region **2306** is or is about to be selected by showing region **2306** as empty, which may include reducing another interface to make room for region **2306**.

By way of another example, assume that immersive manager **134** receives selection of a currently displayed immersive interface, such as with an edge gesture starting at a top edge of the currently displayed immersive interface. In response, method **2200** may reduce the size of the displayed immersive interface (e.g., to a thumbnail as noted above), which method **2200** may then permit the user to move progressively with the gesture. On completion of the gesture or a portion thereof, method **2200** may then move the displayed immersive interface and expand it to fully occupy the selected region.

Returning to method **2200**, block **2204**, responsive to the selection to display the immersive interface in the region, displays the immersive interface at a size fully occupying the region. Note that the user, with a little as the one selection of the application, can select and have presented an immersive interface at a size fully occupying a selected region.

Continuing the example, consider FIG. **24**, which illustrates multi-application immersive environment **2304** but now with a reduced-size immersive interface **2402** instead of current immersive interface **2302** of FIG. **23**, and with a second immersive interface **2404** showing a social-networking webpage **2406** for social-networking application **1510** of FIG. **15**. Second immersive interface **2404** fully occupies region **2306** and without user selection other than selection of the region.

Note that the arrangement of content in reduced-size immersive interface **2402** and social-networking webpage **2406** are both changed. Size changes can be made more quickly or allow for better content arrangements applications and/or developers of those applications having these region sizes in advance, which are provided by the techniques as predetermined region widths. Here the predetermined region width provided is region **2306**, though a fill-width region **2408** may also be provided.

Following block **2204**, method **2200** may repeat blocks **2202** and **2204**, thereby enabling selection of additional immersive interfaces. For example, immersive manager **134** can enable selection of a third immersive interface for presentation in region **2310** or **2308** of FIG. **23**. In response to such a selection, immersive manager **134** reduces the size of, or replaces, reduced-size immersive interface **2402**. Thus, immersive manager **134** may present two interfaces by replacing one of the two interfaces with a third, selected interface or shrink one or both of the two interfaces to present the third interface.

Note that any of these methods may be combined in whole or in part. Thus, a gesture portion, for example, may be used to select an immersive interface and another portion of the same gesture select to place and/or size the immersive interface. In response to this single gesture, the techniques can resize multiple interfaces currently presented in a multi-application immersive environment.

The preceding discussion describes some methods in which the techniques manage immersive interfaces in a multi-application immersive environment, some other methods that enable switching back to a previously-interacted-with application, and still other methods that describe ways in which the techniques enable and/or use edge gestures. These methods are shown as sets of blocks that specify operations performed but are not necessarily limited to the order shown for performing the operations by the respective blocks.

Aspects of these methods may be implemented in hardware (e.g., fixed logic circuitry), firmware, a System-on-Chip (SoC), software, manual processing, or any combination thereof. A software implementation represents program code that performs specified tasks when executed by a computer processor, such as software, applications, routines, programs, objects, components, data structures, procedures, modules, functions, and the like. The program code can be stored in one or more computer-readable memory devices, both local and/or remote to a computer processor. The methods may also be practiced in a distributed computing environment by multiple computing devices.

Example Device

FIG. **25** illustrates various components of example device **2500** that can be implemented as any type of client, server, and/or computing device as described with reference to the previous FIGS. **1-24** to implement techniques enabling and using edge gestures, switching back to a previously-interacted with application, and/or managing an immersive interface in a multi-application immersive environment. In embodiments, device **2500** can be implemented as one or a combination of a wired and/or wireless device, as a form of television client device (e.g., television set-top box, digital video recorder (DVR), etc.), consumer device, computer device, server device, portable computer device, user device, communication device, video processing and/or rendering device, appliance device, gaming device, electronic device, and/or as another type of device. Device **2500** may also be associated with a user (e.g., a person) and/or an entity that operates the device such that a device describes logical devices that include users, software, firmware, and/or a combination of devices.

Device **2500** includes communication devices **2502** that enable wired and/or wireless communication of device data **2504** (e.g., received data, data that is being received, data scheduled for broadcast, data packets of the data, etc.). The device data **2504** or other device content can include configuration settings of the device, media content stored on the device, and/or information associated with a user of the device. Media content stored on device **2500** can include any type of audio, video, and/or image data. Device **2500** includes one or more data inputs **2506** via which any type of data, media content, and/or inputs can be received, such as user-selectable inputs, messages, music, television media content, recorded video content, and any other type of audio, video, and/or image data received from any content and/or data source.

Device **2500** also includes communication interfaces **2508**, which can be implemented as any one or more of a serial and/or parallel interface, a wireless interface, any type

of network interface, a modem, and as any other type of communication interface. The communication interfaces **2508** provide a connection and/or communication links between device **2500** and a communication network by which other electronic, computing, and communication devices communicate data with device **2500**.

Device **2500** includes one or more processors **2510** (e.g., any of microprocessors, controllers, and the like), which process various computer-executable instructions to control the operation of device **2500** and to enable techniques for managing an immersive interface in a multi-application immersive environment. Alternatively or in addition, device **2500** can be implemented with any one or combination of hardware, firmware, or fixed logic circuitry that is implemented in connection with processing and control circuits which are generally identified at **2512**. Although not shown, device **2500** can include a system bus or data transfer system that couples the various components within the device. A system bus can include any one or combination of different bus structures, such as a memory bus or memory controller, a peripheral bus, a universal serial bus, and/or a processor or local bus that utilizes any of a variety of bus architectures.

Device **2500** also includes computer-readable storage media **2514**, such as one or more memory devices that enable persistent and/or non-transitory data storage (i.e., in contrast to mere signal transmission), examples of which include random access memory (RAM), non-volatile memory (e.g., any one or more of a read-only memory (ROM), flash memory, EPROM, EEPROM, etc.), and a disk storage device. A disk storage device may be implemented as any type of magnetic or optical storage device, such as a hard disk drive, a recordable and/or rewriteable compact disc (CD), any type of a digital versatile disc (DVD), and the like. Device **2500** can also include a mass storage media device **2516**.

Computer-readable storage media **2514** provides data storage mechanisms to store the device data **2504**, as well as various device applications **2518** and any other types of information and/or data related to operational aspects of device **2500**. For example, an operating system **2520** can be maintained as a computer application with the computer-readable storage media **2514** and executed on processors **2510**. The device applications **2518** may include a device manager, such as any form of a control application, software application, signal-processing and control module, code that is native to a particular device, a hardware abstraction layer for a particular device, and so on.

The device applications **2518** also include any system components or modules to implement the techniques, such as device applications **2518** including system-interface module **122**, gesture handler **128**, application manager **130**, immersive manager **134**, and application(s) **136**.

CONCLUSION

Although embodiments of techniques and apparatuses for managing an immersive interface in a multi-application immersive environment have been described in language specific to features and/or methods, it is to be understood that the subject of the appended claims is not necessarily limited to the specific features or methods described. Rather, the specific features and methods are disclosed as example implementations for managing an immersive interface in a multi-application immersive environment.

What is claimed is:

1. A computer-implemented method for a display environment implemented as a multi-application immersive environment, the method comprising:

presenting a first immersive interface for executing a first application in a first interface region of the display environment, the first immersive interface presenting content in an arrangement corresponding to a size of the first interface region;

receiving a selection of a second application for executing within a second immersive interface in a second interface region of the display environment, the second interface region having a size different than the size of the first interface region;

presenting the second immersive interface in the second interface region of the display environment concurrently with the first immersive interface in the first interface region;

receiving a drag-and-drop gesture to drag the first immersive interface into the second interface region; and based on receiving the drag-and-drop gesture:

altering the size of the first interface region and the second interface region by adjusting a divider of the first interface region, based on the size of the second interface region;

displaying the first immersive interface in the altered first interface region; and

displaying the second immersive interface in the altered second interface region.

2. The computer-implemented method as described in claim **1**, wherein the first immersive interface and the second immersive interface are concurrently displayed without occluding either of the first or the second immersive interfaces.

3. The computer-implemented method as described in claim **2**,

wherein the first interface region and the second interface region fill an entirety of the display environment.

4. The computer-implemented method as described in claim **1**, wherein the application within the second immersive interface refills content based on the resizing.

5. The computer-implemented method as described in claim **1**, further comprising:

presenting a third immersive interface in a third interface region concurrently with the first immersive interface and the second immersive interface; and

wherein said altering the size of both the first immersive interface and the second immersive interface does not alter a size of the third immersive interface.

6. The computer-implemented method as described in claim **1**, wherein altering the size of the first interface region reduces the size of the first interface region.

7. A computing device implementing a display environment as a multi-application immersive environment, the computing device comprising:

a display device configured to present a first immersive interface for executing a first application in a first interface region of the display environment, the first immersive interface including content in an arrangement corresponding to a size of the first interface region;

an immersive mode module configured to:

receive a selection of a second application for executing within a second immersive interface in a second interface region of the display environment, the second interface region having a size different than the size of the first interface region;

21

- present the second immersive interface in the second interface region of the display environment concurrently with the first immersive interface in the first interface region;
- receive a drag-and-drop gesture to drag the first immersive interface into the second interface region; and
 based on receiving the drag-and-drop gesture:
- alter the size of the first interface region by adjusting a divider between the first interface region and the second interface region, based on the size of the second interface region;
 - display the first immersive interface in the altered first interface region;
 - alter a size of the second interface region by adjusting the divider, based on the size of the first interface region; and
 - display the second immersive interface in the altered second interface region.
8. The computing device as described in claim 7, wherein the immersive mode module is configured to alter the size of both the first immersive interface and the second immersive interface concurrently and without occluding either of the first or the second immersive interfaces.
9. The computing device as described in claim 7, wherein the first interface region and the second interface region fill an entirety of the display environment.
10. The computing device as described in claim 7, wherein the first interface region has a predetermined region width that specifies a predetermined pixel width, and the first interface region has a variable length.
11. The computing device as described in claim 7, wherein the first interface region and the second interface region fully occupy a dimension of the display device on which the multi-application immersive environment is presented.
12. The computing device as described in claim 7, wherein:
- the display device is configured to present a third immersive interface in a third interface region concurrently with the first immersive interface and the second immersive interface; and
 - the immersive mode module is configured to alter the size of both the first immersive interface and the second immersive interface without altering a size of the third immersive interface.
13. The computing device as described in claim 7, wherein altering the size of the first interface region increases the size of the first interface region.
14. A computer readable storage medium storing instructions that when executed by a processor cause the processor

22

- to perform a method for a display environment implemented as a multi-application immersive environment, the method comprising:
- presenting a first immersive interface for executing a first application in a first interface region of the display environment, the first immersive interface presenting content in an arrangement corresponding to a size of the first interface region;
 - receiving a selection of a second application for executing within a second immersive interface in a second interface region of the display environment, the second interface region having a size different than the size of the first interface region and a divider between the first interface region and the second interface region;
 - presenting the second immersive interface in the second interface region of the display environment concurrently with the first immersive interface in the first interface region;
 - receiving a drag-and-drop gesture to drag the first immersive interface into the second interface region; and
 based on receiving the drag-and-drop gesture:
 - based on the sizes of the first interface region and the second interface region, altering the size of the first interface region and the second interface region by adjusting the divider;
 - displaying the first immersive interface in the altered first interface region; and
 - displaying the second immersive interface in the altered second interface region.
15. The computer-readable storage medium of claim 14, wherein altering the size of the first interface region reduces the size of the first interface region.
16. The computer-readable storage medium of claim 14, wherein altering the size of the first interface region increases the size of the first interface region.
17. The computer-readable storage medium of claim 14, wherein the first interface region and the second interface region fully occupy a dimension of the display environment.
18. The computer-readable storage medium of claim 14, wherein the first immersive interface and the second immersive interface are concurrently displayed without occluding either of the first or the second immersive interfaces.
19. The computer-readable storage medium of claim 14, wherein the application within the second immersive interface reflows content based on the resizing.
20. The computer-readable storage medium of claim 14, wherein the first interface region has a predetermined region width that specifies a predetermined pixel width, and the first interface region has a variable length.

* * * * *