

US011392912B1

(12) **United States Patent**
Pollack et al.

(10) **Patent No.:** **US 11,392,912 B1**
(45) **Date of Patent:** ***Jul. 19, 2022**

(54) **IMAGE PROCESSING**

(71) Applicant: **United Services Automobile Association (USAA)**, San Antonio, TX (US)

(72) Inventors: **Jeff Pollack**, San Antonio, TX (US); **Michael Frank Morris**, San Antonio, TX (US); **Bharat Prasad**, San Antonio, TX (US); **Frank Kyle Major**, San Antonio, TX (US); **John Weatherman Brady**, Boerne, TX (US); **Ralph Paige Mawyer, Jr.**, San Antonio, TX (US); **Clint James Reynolds**, San Antonio, TX (US); **Kairav Mahesh Shah**, Katy, TX (US)

(73) Assignee: **UNITED SERVICES AUTOMOBILE ASSOCIATION (USAA)**, San Antonio, TX (US)

(*) Notice: Subject to any disclaimer, the term of this patent is extended or adjusted under 35 U.S.C. 154(b) by 0 days.

This patent is subject to a terminal disclaimer.

(21) Appl. No.: **17/012,815**

(22) Filed: **Sep. 4, 2020**

Related U.S. Application Data

(60) Continuation of application No. 16/502,489, filed on Jul. 3, 2019, now Pat. No. 10,810,561, which is a (Continued)

(51) **Int. Cl.**
G06Q 20/02 (2012.01)
G06Q 20/10 (2012.01)
(Continued)

(52) **U.S. Cl.**
CPC **G06Q 20/1085** (2013.01); **G06Q 20/042** (2013.01); **G06Q 20/0425** (2013.01); **G06Q 40/02** (2013.01)

(58) **Field of Classification Search**

CPC .. G06Q 20/1085; G06Q 20/042; G06Q 40/02; G06Q 20/0425

See application file for complete search history.

(56) **References Cited**

U.S. PATENT DOCUMENTS

1,748,489 A 2/1930 McCarthy et al.
2,292,825 A 8/1942 Dilks et al.

(Continued)

FOREIGN PATENT DOCUMENTS

CA 2619884 3/2007
CN 1897644 A 1/2007

(Continued)

OTHER PUBLICATIONS

Higgins, Ray et al., "Working With Image Cash Letters (ISLs) X9.37, 180 or 187 files", *All My Papers*, 2009, 36 pgs.

(Continued)

Primary Examiner — Keith D Bloomquist

(74) *Attorney, Agent, or Firm* — Crowell & Moring LLP

(57) **ABSTRACT**

An image of a check may be presented for payment in a banking system in place of the physical paper check. The check to be deposited can be collected from a depositor using a scanner. A web site, accessed through a depositor's web browser, can be used to drive the process of collecting the check, but in some contexts (e.g., in less popular computing environments, such as those that do not run the most popular operating systems), it is economically infeasible to obtain the certificates that would be used to allow a program executing in the web browser to control the scanner. Thus, a depositor can be instructed to capture and upload images of the check in the form of files, where the image files are then presented for payment through a banking system.

26 Claims, 7 Drawing Sheets

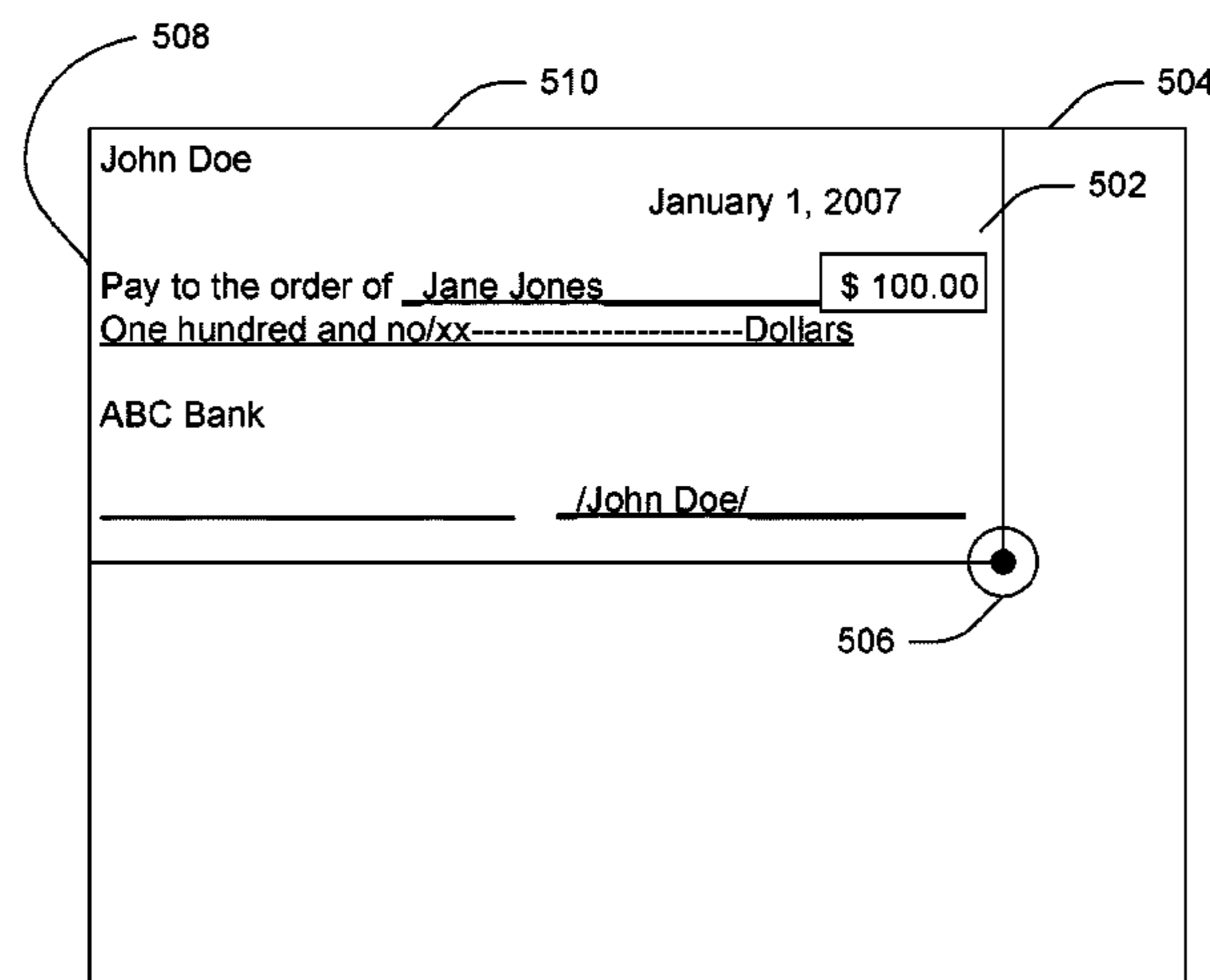

Related U.S. Application Data

continuation of application No. 14/879,868, filed on Oct. 9, 2015, now Pat. No. 10,373,136, which is a continuation of application No. 13/327,478, filed on Dec. 15, 2011, now Pat. No. 9,159,101, which is a continuation of application No. 13/301,433, filed on Nov. 21, 2011, now abandoned, and a division of application No. 11/877,307, filed on Oct. 23, 2007, now abandoned.

(51) **Int. Cl.**

G06Q 20/04 (2012.01)
G06Q 40/02 (2012.01)

(56)

References Cited

U.S. PATENT DOCUMENTS

3,005,282	A	10/1961	Christiansen	5,229,589	A	7/1993	Schneider
3,341,820	A	9/1967	Grillmeier	5,233,547	A	8/1993	Kapp et al.
3,576,972	A	5/1971	Wood	5,237,158	A	8/1993	Kern et al.
3,593,913	A	7/1971	Bremer	5,237,159	A	8/1993	Stephens
3,620,553	A	11/1971	Donovan	5,237,620	A	8/1993	Deaton et al.
3,648,242	A	3/1972	Grosbard	5,257,320	A	10/1993	Etherington et al.
3,800,124	A	3/1974	Walsh	5,265,008	A	11/1993	Benton
3,816,943	A	6/1974	Henry	5,268,968	A	12/1993	Yoshida
4,002,356	A	1/1977	Weidmann	5,283,829	A	2/1994	Anderson
4,027,142	A	5/1977	Paup et al.	5,321,816	A	6/1994	Rogan
4,060,711	A	11/1977	Buros	5,345,090	A	9/1994	Hludzinski
4,070,649	A	1/1978	Wright, Jr. et al.	5,347,302	A	9/1994	Simonoff
4,128,202	A	12/1978	Buros	5,350,906	A	9/1994	Brody
4,136,471	A	1/1979	Austin	5,373,550	A	12/1994	Campbell
4,205,780	A	6/1980	Burns	5,383,113	A	1/1995	Kight et al.
4,264,808	A	4/1981	Owens	5,419,588	A	5/1995	Wood
4,305,216	A	12/1981	Skelton	5,422,467	A	6/1995	Graef
4,321,672	A	3/1982	Braun	5,444,616	A	8/1995	Nair et al.
4,346,442	A	8/1982	Musmanno	5,444,794	A	8/1995	Uhland, Sr.
4,417,136	A	11/1983	Rushby et al.	5,455,875	A	10/1995	Chevion et al.
4,433,436	A	2/1984	Carnes	5,475,403	A	12/1995	Havlovick et al.
4,454,610	A	6/1984	Sziklai	5,504,538	A	4/1996	Tsujihara
RE31,692	E	10/1984	Tyburski et al.	5,504,677	A	4/1996	Pollin
4,523,330	A	6/1985	Grosbard	5,528,387	A	6/1996	Kelly et al.
4,636,099	A	1/1987	Goldston	5,530,773	A	6/1996	Thompson
4,640,413	A	2/1987	Kaplan	5,577,179	A	11/1996	Blank
4,644,144	A	2/1987	Chandek	5,583,759	A	12/1996	Geer
4,722,444	A	2/1988	Murphy	5,590,196	A	12/1996	Moreau
4,722,544	A	2/1988	Weber	5,594,225	A	1/1997	Botvin
4,727,435	A	2/1988	Donovon	5,598,969	A	2/1997	Ong
4,737,911	A	4/1988	Freeman	5,602,936	A	2/1997	Green
4,739,411	A	4/1988	Bolton	5,610,726	A	3/1997	Nonoshita
4,774,574	A	9/1988	Daly et al.	5,611,028	A	3/1997	Shibasaki
4,774,663	A	9/1988	Musmanno	5,630,073	A	5/1997	Nolan
4,790,475	A	12/1988	Griffin	5,631,984	A	5/1997	Graf et al.
4,806,780	A	2/1989	Yamamoto	5,668,897	A	9/1997	Stolfo
4,837,693	A	6/1989	Schotz	5,673,320	A	9/1997	Ray
4,890,228	A	12/1989	Longfield	5,677,955	A	10/1997	Doggett
4,927,071	A	5/1990	Wood	5,678,046	A	10/1997	Cahill et al.
4,934,587	A	6/1990	McNabb	5,679,938	A	10/1997	Templeton
4,960,981	A	10/1990	Benton	5,680,611	A	10/1997	Rail
4,975,735	A	12/1990	Bright	5,691,524	A	11/1997	Josephson
5,022,683	A	6/1991	Barbour	5,699,452	A	12/1997	Vaidyanathan
5,053,607	A	10/1991	Carlson	5,734,747	A	3/1998	Vaidyanathan
5,077,805	A	12/1991	Tan	5,737,440	A	4/1998	Kunkler
5,091,968	A	2/1992	Higgins et al.	5,748,780	A	5/1998	Stolfo
5,122,950	A	6/1992	Benton et al.	5,751,842	A	5/1998	Riach
5,134,564	A	7/1992	Dunn et al.	5,761,686	A	6/1998	Bloomberg
5,146,606	A	9/1992	Grondalski	5,784,503	A	7/1998	Bleecker, III et al.
5,157,620	A	10/1992	Shaar	5,830,609	A	11/1998	Warner
5,159,548	A	10/1992	Caslavka	5,832,463	A	11/1998	Funk
5,164,833	A	11/1992	Aoki	5,838,814	A	11/1998	Moore
5,175,682	A	12/1992	Higashiyama et al.	5,848,185	A	12/1998	Koga et al.
5,187,750	A	2/1993	Behera	5,859,935	A	1/1999	Johnson et al.
5,191,525	A	3/1993	LeBrun	5,863,075	A	1/1999	Rich
5,193,121	A	3/1993	Elischer et al.	5,870,456	A	2/1999	Rogers
5,220,501	A	6/1993	Lawlor	5,870,724	A	2/1999	Lawlor
5,227,863	A	7/1993	Bilbrey et al.	5,870,725	A	2/1999	Bellinger et al.
				5,878,337	A	3/1999	Joao
				5,889,884	A	3/1999	Hashimoto et al.
				5,893,101	A	4/1999	Balogh et al.
				5,897,625	A	4/1999	Gustin
				5,898,157	A	4/1999	Mangili et al.
				5,901,253	A	5/1999	Tretter
				5,903,878	A	5/1999	Talati
				5,903,881	A	5/1999	Schrader
				5,903,904	A	5/1999	Peairs
				5,910,988	A	6/1999	Ballard
				5,917,931	A	6/1999	Kunkier
				5,924,737	A	7/1999	Schrupp
				5,926,548	A	7/1999	Okamoto
				5,930,501	A	7/1999	Neil
				5,930,778	A	7/1999	Geer
				5,937,396	A	8/1999	Konya
				5,940,844	A	8/1999	Cahill
				5,982,918	A	11/1999	Mennie
				5,987,439	A	11/1999	Gustin et al.
				6,005,623	A	12/1999	Takahashi
				6,012,048	A	1/2000	Gustin

(56)

References Cited

U.S. PATENT DOCUMENTS

6,014,454	A	1/2000	Kunkler	6,450,403	B1	9/2002	Martens
6,021,202	A	2/2000	Anderson	6,463,220	B1	10/2002	Dance et al.
6,021,397	A	2/2000	Jones	6,464,134	B1	10/2002	Page
6,023,705	A	2/2000	Bellinger et al.	6,469,745	B1	10/2002	Yamada et al.
6,029,887	A	2/2000	Furuhashi	6,470,325	B1	10/2002	Leemhuis
6,030,000	A	2/2000	Diamond	6,473,519	B1	10/2002	Pidhirny et al.
6,032,137	A	2/2000	Ballard	6,502,747	B1	1/2003	Stoutenburg et al.
6,038,553	A	3/2000	Hyde	6,505,178	B1	1/2003	Flenley
6,044,773	A	4/2000	Bauer	6,546,119	B2	4/2003	Ciolti et al.
6,053,405	A	4/2000	Irwin, Jr. et al.	6,574,377	B1	6/2003	Cahill et al.
6,059,185	A	5/2000	Funk et al.	6,574,609	B1	6/2003	Downs
6,064,762	A	5/2000	Haenel	6,578,760	B1	6/2003	Otto
6,072,941	A	6/2000	Suzuki et al.	6,587,837	B1	7/2003	Spagna
6,073,119	A	6/2000	Borenmisza-wahr	6,606,117	B1	8/2003	Windle
6,073,121	A	6/2000	Ramzy	6,609,200	B2	8/2003	Anderson
6,085,168	A	7/2000	Mori	6,611,598	B1	8/2003	Hayosh
6,086,708	A	7/2000	Colgate	6,614,930	B1	9/2003	Agnihotri et al.
6,089,450	A	7/2000	Koeple	6,643,416	B1	11/2003	Daniels
6,089,610	A	7/2000	Greene	6,647,136	B2	11/2003	Jones et al.
6,092,047	A	7/2000	Hyman et al.	6,654,487	B1	11/2003	Downs, Jr.
6,097,834	A	8/2000	Krouse	6,661,910	B2	12/2003	Jones et al.
6,097,845	A	8/2000	Ng et al.	6,668,372	B1	12/2003	Wu
6,097,885	A	8/2000	Rayner	6,669,086	B2	12/2003	Abdi et al.
6,105,865	A	8/2000	Hardesty	6,672,452	B1	1/2004	Alves
6,128,603	A	10/2000	Dent et al.	6,682,452	B2	1/2004	Quintus
6,141,339	A	10/2000	Kaplan et al.	6,695,204	B1	2/2004	Stinson
6,145,738	A	11/2000	Stinson et al.	6,697,091	B1	2/2004	Rzepakowski et al.
6,148,102	A	11/2000	Stolin	6,711,474	B1	3/2004	Treyz et al.
6,149,056	A	11/2000	Stinson et al.	6,726,097	B2	4/2004	Graef
6,151,409	A	11/2000	Chen et al.	6,728,397	B2	4/2004	Mcneal
6,151,423	A	11/2000	Melen	6,738,496	B1	5/2004	Van Hall
6,151,426	A	11/2000	Lee	6,742,128	B1	5/2004	Joiner
6,159,585	A	12/2000	Rittenhouse	6,745,186	B1	6/2004	Testa et al.
6,170,744	B1	1/2001	Lee	6,754,640	B2	6/2004	Bozeman
6,178,270	B1	1/2001	Taylor et al.	6,755,340	B1	6/2004	Voss
6,178,409	B1	1/2001	Weber et al.	6,760,414	B1	7/2004	Schurko et al.
6,181,837	B1	1/2001	Cahill et al.	6,760,470	B1	7/2004	Bogosian et al.
6,188,506	B1	2/2001	Kaiserman	6,763,226	B1	7/2004	McZeal
6,189,785	B1	2/2001	Lowery	6,781,962	B1	8/2004	Williams
6,192,165	B1	2/2001	Irons	6,786,398	B1	9/2004	Stinson
6,195,452	B1	2/2001	Royer	6,789,054	B1	9/2004	Makhlouf
6,195,694	B1	2/2001	Chen et al.	6,796,489	B2	9/2004	Slater et al.
6,199,055	B1	3/2001	Kara	6,796,491	B2	9/2004	Nakajima
6,236,009	B1	5/2001	Emigh et al.	6,806,903	B1	10/2004	Okisu et al.
6,243,689	B1	6/2001	Norton	6,807,294	B2	10/2004	Yamazaki
6,278,983	B1	8/2001	Ball	6,813,733	B1	11/2004	Li
6,282,523	B1	8/2001	Tedesco et al.	6,829,704	B2	12/2004	Zhang
6,282,826	B1	9/2001	Richards	6,844,885	B2	1/2005	Anderson
6,293,469	B1	9/2001	Masson et al.	6,856,965	B1	2/2005	Stinson
6,304,860	B1	10/2001	Martin	6,863,214	B2	3/2005	Garner et al.
6,310,647	B1	10/2001	Parulski et al.	6,870,947	B2	3/2005	Kelland
6,314,452	B1	11/2001	Dekel	6,873,728	B2	3/2005	Bernstein et al.
6,315,195	B1	11/2001	Ramachandrun	6,883,140	B1	4/2005	Acker
6,317,727	B1	11/2001	May	6,898,314	B2	5/2005	Kung et al.
6,328,207	B1	12/2001	Gregoire et al.	6,902,105	B2	6/2005	Koakutsu
6,330,546	B1	12/2001	Gopinathan et al.	6,910,023	B1	6/2005	Schibi
6,339,658	B1	1/2002	Moccagatta	6,913,188	B2	7/2005	Wong
6,339,766	B1	1/2002	Gephart	6,922,487	B2	7/2005	Dance et al.
6,351,553	B1	2/2002	Hayosh	6,931,255	B2	8/2005	Mekuria
6,351,735	B1	2/2002	Deaton et al.	6,931,591	B1	8/2005	Brown
6,354,490	B1	3/2002	Weiss et al.	6,934,719	B2	8/2005	Nally
6,363,162	B1	3/2002	Moed et al.	6,947,610	B2	9/2005	Sun
6,363,164	B1	3/2002	Jones et al.	6,957,770	B1	10/2005	Robinson
6,390,362	B1	5/2002	Martin	6,961,689	B1	11/2005	Greenberg
6,397,196	B1	5/2002	Kravetz	6,970,843	B1	11/2005	Forte
6,408,084	B1	6/2002	Foley	6,973,589	B2	12/2005	Wright
6,411,725	B1	6/2002	Rhoads	6,983,886	B2	1/2006	Natsukari et al.
6,411,737	B2	6/2002	Wesolkowski et al.	6,993,507	B2	1/2006	Meyer
6,411,938	B1	6/2002	Gates et al.	6,996,263	B2	2/2006	Jones et al.
6,413,305	B1	7/2002	Mehta	6,999,943	B1	2/2006	Johnson
6,417,869	B1	7/2002	Do	7,003,040	B2	2/2006	Yi
6,425,017	B1	7/2002	Dievendorff	7,004,382	B2	2/2006	Sandru
6,429,952	B1	8/2002	Olbricht	7,010,155	B2	3/2006	Koakutsu et al.
6,439,454	B1	8/2002	Masson et al.	7,010,507	B1	3/2006	Anderson
6,449,397	B1	9/2002	Che-Chu	7,016,704	B2	3/2006	Pallakoff
				7,027,171	B1	4/2006	Watanabe
				7,028,886	B1	4/2006	Maloney
				7,039,048	B1	5/2006	Monta
				7,046,991	B2	5/2006	Little

(56)

References Cited

U.S. PATENT DOCUMENTS

2009/0094148 A1 4/2009 Gilder et al.
 2009/0108080 A1 4/2009 Meyer
 2009/0110281 A1 4/2009 Hirabayashi
 2009/0114716 A1 5/2009 Ramachandran
 2009/0141962 A1 6/2009 Borgia
 2009/0164350 A1 6/2009 Sorbe et al.
 2009/0164370 A1 6/2009 Sorbe et al.
 2009/0166406 A1 7/2009 Pigg et al.
 2009/0167870 A1 7/2009 Caleca et al.
 2009/0171795 A1 7/2009 Clouthier et al.
 2009/0171819 A1 7/2009 Von
 2009/0171825 A1 7/2009 Roman
 2009/0173781 A1 7/2009 Ramachandran
 2009/0185241 A1 7/2009 Nepomniachtchi
 2009/0185737 A1 7/2009 Nepomniachtchi
 2009/0185738 A1 7/2009 Nepomniachtchi
 2009/0190823 A1 7/2009 Walters
 2009/0192938 A1 7/2009 Amos
 2009/0212929 A1 8/2009 Drory et al.
 2009/0236413 A1 9/2009 Mueller et al.
 2009/0240620 A1 9/2009 Kendrick et al.
 2009/0252437 A1 10/2009 Li
 2009/0254447 A1 10/2009 Blades
 2009/0257641 A1 10/2009 Liu et al.
 2009/0263019 A1 10/2009 Tzadok et al.
 2009/0271287 A1 10/2009 Halpern
 2009/0281904 A1 11/2009 Pharris
 2009/0284637 A1 11/2009 Parulski et al.
 2009/0290751 A1 11/2009 Ferman et al.
 2009/0292628 A1 11/2009 Dryer et al.
 2009/0313167 A1 12/2009 Dujari
 2009/0319425 A1 12/2009 Tumminaro et al.
 2009/0327129 A1 12/2009 Collas et al.
 2010/0007899 A1 1/2010 Lay
 2010/0008579 A1 1/2010 Smimov
 2010/0016016 A1 1/2010 Brundage et al.
 2010/0027679 A1 2/2010 Sunahara et al.
 2010/0030687 A1 2/2010 Panthaki et al.
 2010/0047000 A1 2/2010 Park et al.
 2010/0057578 A1 3/2010 Blair et al.
 2010/0061446 A1 3/2010 Hands et al.
 2010/0078471 A1 4/2010 Lin et al.
 2010/0078472 A1 4/2010 Lin et al.
 2010/0082468 A1 4/2010 Low et al.
 2010/0082470 A1 4/2010 Walach
 2010/0128131 A1 5/2010 Tenchio et al.
 2010/0165015 A1 7/2010 Barkley et al.
 2010/0198733 A1 8/2010 Gantman et al.
 2010/0225773 A1 9/2010 Lee
 2010/0226559 A1 9/2010 Najari et al.
 2010/0260408 A1 10/2010 Prakash et al.
 2010/0262522 A1 10/2010 Anderson et al.
 2010/0274693 A1 10/2010 Bause et al.
 2010/0312705 A1 12/2010 Caruso et al.
 2011/0016084 A1 1/2011 Mundy et al.
 2011/0069180 A1 3/2011 Nijemcevic et al.
 2011/0106675 A1 5/2011 Perlman
 2011/0112967 A1 5/2011 Anderson et al.
 2011/0170740 A1 7/2011 Coleman
 2011/0191161 A1 8/2011 Dai
 2011/0251956 A1 10/2011 Cantley et al.
 2011/0280450 A1 11/2011 Nepomniachtchi et al.
 2011/0285874 A1 11/2011 Showering et al.
 2011/0310442 A1 12/2011 Popadic et al.
 2012/0045112 A1 2/2012 Lundblad et al.
 2012/0047070 A1 2/2012 Pharris
 2012/0062732 A1 3/2012 Marman et al.
 2012/0089514 A1 4/2012 Kraemling et al.
 2012/0099792 A1 4/2012 Chevion et al.
 2012/0185383 A1 7/2012 Atsmon
 2012/0185388 A1 7/2012 Pranger
 2012/0229872 A1 9/2012 Dolev
 2013/0021651 A9 1/2013 Popadic et al.
 2013/0120595 A1 5/2013 Roach et al.
 2013/0155474 A1 6/2013 Roach et al.

2013/0198071 A1 8/2013 Jurss
 2013/0201534 A1 8/2013 Carlen
 2013/0223721 A1 8/2013 Nepomniachtchi et al.
 2013/0297353 A1 11/2013 Strange
 2014/0032406 A1 1/2014 Roach et al.
 2014/0067661 A1 3/2014 Elischer
 2014/0197922 A1 7/2014 Stanwood et al.
 2014/0236820 A1 8/2014 Carlton et al.
 2014/0279453 A1 9/2014 Belchee et al.
 2015/0039528 A1 2/2015 Minogue et al.
 2015/0090782 A1 4/2015 Dent
 2016/0034590 A1 2/2016 Endras et al.
 2016/0142625 A1 5/2016 Weksler et al.
 2016/0335816 A1 11/2016 Thoppae et al.
 2017/0146602 A1 5/2017 Samp et al.
 2017/0033761 A1 11/2017 Beguesse

FOREIGN PATENT DOCUMENTS

EP 0 984 410 3/2000
 EP 0 984 410 A1 3/2000
 EP 0984410 3/2000
 EP 1 855 459 A2 5/2007
 JP 2004-23158 1/2004
 JP 3708807 10/2005
 JP 2006-174105 A 6/2006
 KR 20040076131 A 8/2004
 WO WO 96/14707 A1 5/1996
 WO WO 98/37655 A1 8/1998
 WO WO 01/61436 8/2001
 WO WO 01/61436 A2 8/2001
 WO 2004-23158 A 1/2004
 WO WO 2005/043857 5/2005
 WO WO 2005/124657 A1 12/2005
 WO WO 2006/075967 A1 7/2006
 WO WO 2006/086768 A2 8/2006
 WO WO 2006/136958 A2 12/2006
 WO WO 2007/024889 3/2007

OTHER PUBLICATIONS

X9.100-180, "The New ICL Standard is Published", *All My Papers*, 2006, 3 pgs.
 X9.37 Specifications | X9Ware LLC, dated 2018, 3 pgs.
 "Getting Started with ICLs aka X9.37 Files", *All My Papers*, May 2, 2006, 39 pgs.
 Federal Reserve Banks Plan Black-and-White Image Standard and Quality Checks, May 2004, 2 pgs.
 Caplan, J. et al., Most Influential Gadgets and Gizmos 2002: Sanyo SCP-5300, 2002, 1 pg.
 Hill, S., "From J-Phone to Lumina 1020: A complete history of the camera phone", *Digital Trends*, 2020, 9 pgs.
 Hoffman, J., "Before there Were Smartphones, There was I-Mode", 1999, 5 pgs.
 "Vodafone calls on mobiles to go live!", 2002, 8 pgs.
 "Sprint PCS Vision Guide", 2005, 86 pgs.
 FDIC—Remote Capture: A Primer, 2009, 3 pgs.
 Callahan, J., "The first camera phone was sold 20 years ago, and it's not what you expect", *Android Authority*, 2019, 5 pgs.
 Fujisawa, H. et al., "Information Capturing Camera and Developmental Issues", *IEEE Xplore*, downloaded on Aug. 18, 2020, 4 pgs.
 Rohs, M. et al., "A Conceptual Framework for Camera Phone-based Interaction Techniques", in *Pervasive Computing*, Berlin Heidelberg, 2005, pp. 171-189.
 Koga, M. et al., Camera-based Kanji OCR for Mobile-phones: Practical Issues, *IEEE*, 2005, 5 pgs.
 Parikh, T., "Using Mobile Phones for Secure, Distributed Document Processing in the Developing World", *IEE Persuasive Computing*, vol. 4, No. 2, 2005, 9 pgs.
 Parikh, T., "Mobile Phones and Paper Documents: Evaluating a New Approach for Capturing Microfinance Data in Rural India", *CHI 2006 Proceedings*, 2006, 10 pgs.
 Magid, L., "A baby girl and the camera phone were born 20 years ago", *Mercury News*, 2017, 3 pgs.

(56)

References Cited

OTHER PUBLICATIONS

- Liang, J. et al., "Camera-based analysis of text and documents: a survey", *IJDAR*, vol. 7, 2005, pp. 84-104, 21, pgs.
- Gutierrez, L., "Innovation: From Campus to Startup", *Business Watch*, 2008, 2 pgs.
- Doermann, D. et al., "The function of documents", *Image and Vision Computing*, vol. 16, 1998, pp. 799-814.
- Mirmehdi, M. et al., "Towards Optimal Zoom for Automatic Target Recognition", in Proceedings of the Scandinavian Conference on Image Analysis, 1:447-454, 1997, 7 pgs.
- Mirmehdi, M. et al., "Extracting Low Resolution Text with an Active Camera for OCR", in Proceedings of the IX Spanish Symposium on Pattern Recognition and Image Processing (pp. 43-48), 2001, 6 pgs.
- Zandifar, A. et al., "A Video Based Interface To Textual Information For The Visually Impaired", *IEEE 17th International Symposium on Personal, Indoor and Mobile Radio Communications*, 1-5, 2002, 6 pgs.
- Laine, M. et al., "A Standalone OCR System For Mobile Cameraphones", *IEEE*, 2006, 5 pgs.
- Federal Reserve Banks to Adopt DSTU X9.37-2003 Format for Check 21 Image Services, 2004, 2 pgs.
- Dhandra, B.V. et al., "Skew Detection in Binary Image Documents Based on Image Dilation and Region Labeling Approach", *IEEE, The 18th International Conference on Pattern Recognition (ICPR'06)*, 2006, 4 pgs.
- PNC Bank to Offer Ease of Online Deposit Service Integrated with QuickBooks to Small Business, RemoteDepositCapture.com, Jul. 24, 2006, 2 pgs.
- 12 CRF § 229.51 and Appendix D to Part 229 (Jan. 1, 2005 edition), 3 pgs.
- 149 Cong. Rec. H9289, Oct. 8, 2003, 6 pgs.
- Apple Announces the New iPhone 3GS—The Fastest, Most Powerful iPhone Yet, Jun. 8, 2009, located on the Internet at: <http://www.apple.com/newsroom/2009/06/08Apple-Announces-the-New-iPhone-3GS-The-Fastest-Most-Powerful-iPhone-Yet>, 4 pgs.
- Apple Reinvents the Phone with iPhone, Jan. 2007, located on the Internet at: <https://www.apple.com/newsroom/2007/01/09Apple-Reinvents-the-Phone-with-iPhone/>, 4 pgs.
- Askey, *Canon EOS 40D Review* (pts.1,4,10), Digital Photography Review, located on the Internet at: <https://www.dpreview.com/reviews/canoneos40d>, 24 pgs.
- Askey, *Leica Digilux 2 Review* (pts. 1,3,7), Digital Photography Review, May 20, 2004, located on the Internet at: <https://www.dpreview.com/reviews/leicadigilux2>, 20 pgs.
- Askey, *Nikon D300 In-depth Review* (pts. 1,3,9), Digital Photography Review, Mar. 12, 2008, located on the Internet at: <https://www.preview.com/reviews/nikond300>, 24 pgs.
- Askey, *Panasonic Lumix Dmc-L1 Review* (pts. 1,3,7), Digital Photography Review, Apr. 11, 2007, located on the Internet at: <https://www.dpreview.com/reviews/panasonicdmc11>, 24 pgs.
- Askey, *Sony Cyber-shot DSC-R1 Review* (pts. 1,3,7), Digital Photography Review, Dec. 6, 2005, located on the Internet at: <http://www.dpreview.com/reviews/sonydscr1>, 24 pgs.
- "Adjusting Brightness and Contrast", www.eaglesoftware.com/adjustin.htm, retrieved on May 4, 2009 (4 pgs).
- Berman, *How Hitchcock Turned a Small Budget Into a Great Triumph*, Time.com, Apr. 29, 2015, located on the Internet at: <http://time.com/3823112/alfred-hitchcock-shadow-of-a-doubt/>, 1 pg.
- "Best practices for producing quality digital image files," Digital Images Guidelines, http://deepblue.lib.umich.edu/bitstream/2027.42/40247/1/Images-Best_Practice.pdf, downloaded 2007 (2 pgs).
- Chen, Brian et al., *iPhone 3GS Trounces Predecessors, Rivals in Web Browser Speed Test*, Wired, Jun. 24, 2009, located on the Internet at: www.wired.com/2009.3gs-speed/, 10 pgs.
- "Clearing House Electronic Check Clearing System (CHECCS) Operating Rules," An IP.com Prior Art Database Technical Disclosure, Jul. 29, 2015 (35 pgs).
- Declaration of Peter Alexander, Ph.D., CBM2019-0004, Nov. 8, 2018, 180 pgs.
- "Deposit Now: Quick Start User Guide," BankServ, 2007, 29 pages.
- Excerpts from American National Standard for Financial Services, ANS, X9.100-140-2004-Specifications for an Image Replacement Document—IRD, Oct. 1, 2004, 16 pgs.
- "First Wireless Handheld Check and Credit Card Processing Solution Launched by Commericant®, MobileScape® 5000 Eliminates Bounced Checks, Enables Payments Everywhere," Business Wire, Mar. 13, 2016, 3 pages.
- Gates, *A History of Wireless Standards, Wi-Fi Back to Basics*, Areohive Blog, Jul. 2015, located on the Internet at: <http://blog.aerohive.com/a-history-of-wireless-standards>, 5 pgs.
- Guides for Evaluation of Radio Transmission Technologies for IMT-2000*, dated 1997, ITU-R-M.1225, located on the Internet at: <https://www.itu.int/dmspubrec/itu-r/rec/m/R-REC-M,1225-0-199702-I!!PDF-E.pdf>, 60 pgs.
- "How to Digitally Deposit a Check Image", Smart Money Daily, Copyright 2008 (5 pgs).
- "ImageNet Mobile Deposit Provides Convenient Check Deposit and Bill Pay to Mobile Consumers," MitekSystems, 2008 (2 pgs).
- iPhone Store Downloads Top 10 Million in First Weekend*, Jul. 14, 2008, located on the Internet at: <https://www.apple.com/newsroom/2008/07/14iPhone-App-Store-Downloads-Top-10-Million-in-First-Weekend/>.
- Joinson et al., *Olympus E-30 Review* (pts. 1,4,8), Digital Photography Review, Mar. 24, 2009, located on the Internet at: www.dpreview.com/reviews/olympus30, 6 pgs.
- Knerr et al., *The A2iA Intercheque System: Courtesy Amount and Legal Amount Recognition for French Checks in Automated Bankcheck Processing 43-86*, Impedove et al. eds., 1997, 50 pgs.
- "Machine Accepts Bank Deposits", *New York Times*, Apr. 12, 1961, 1 pg.
- MacKenzie, E., *Photography Made Easy*, copyright 1845, 80 pgs.
- "Mitek Systems Announces Mobile Deposit Application for Apple iPhone," <http://prnewswire.com/cgi-bin/stories.pl?ACCT=104&STORY=/www/story/10-01-...>, Nov. 25, 2008 (2 pgs).
- "NOVA Enhances Electronic Check Service to Benefit Multi-Lane Retailers," Business Wire, Nov. 28, 2006, 2 pages.
- Quinn and Roberds, *The Evolution of the Check as a Means of Payment: A Historical Survey*, Federal Reserve Bank of Atlanta, Economic Review, 2008, 30 pgs.
- Petition filed by Wells Fargo Bank, N.A. for Covered Business Method Review of Claims 1-20 of U.S. Pat. No. 9,818,090, dated Nov. 8, 2018, 90 pgs.
- Petition filed by Wells Fargo Bank, N.A. for Covered Business Method Review of Claims 1-20 of U.S. Pat. No. 9,336,517, dated Nov. 8, 2018, 98 pgs.
- Petition filed by Wells Fargo Bank, N.A. for Covered Business Method Review of Claims 1-20 of U.S. Pat. No. 8,977,571, dated Nov. 8, 2018, 95 pgs.
- Petition filed by Wells Fargo Bank, N.A. for Covered Business Method Review of Claims 1-23 of U.S. Pat. No. 8,699,779, dated Nov. 8, 2018, 101 pgs.
- "Remote check deposit is the answer to a company's banking problem," Daily Breeze, Torrance, CA, Nov. 17, 2006, 2 pgs.
- Rockwell, *The Megapixel Myth*, KenRickwell.com, 2008, located on the Internet at: <http://kewrockwell.com.tech/mpmyth.htm>, 6 pgs.
- Shah, *Moore's Law, Continuous Everywhere But Differentiable Nowhere*, Feb. 12, 2009, located on the Internet at: <http://samjshah.com/2009/02/24/morres-law/>, 5 pgs.
- "SNB Check Capture: SmartClient User's Guide," Nov. 2006, 21 pgs.
- Sumits, *Major Mobile Milestones—The Last 15 Years, and the Next Five*, Cisco Blogs, Feb. 3, 2016, located on the Internet at: <https://blogs.cisco.com/sp/mobile-vni-major-mobile-milesrones-the-last15-years-and-the-next-five>, 12 pgs.
- "WallStreetGrapevine.com" Stocks on the Rise: JADG, BKYI, MITK; Mar. 3, 2008 (4 pgs).
- Wausau Financial Systems, *Understanding Image Quality & Usability Within a New Environment*, 2006, 22 pgs.
- "Exchangeable image file format for digital still cameras: Exif Version 2.2," Standard of Electronics and Information Technology Industries Associate, JEITA CP-3451, Technical Standardization

(56)

References Cited

OTHER PUBLICATIONS

Committee on AV & IT Storage Systems and Equipments, Japan Electronics and Information Technology Industries Association, Apr. 2002 (154 pgs). (retrieved from: <http://www.exif.org/Exif2-2.PDF>).

Albrecht, W. Steve, "Check Kiting: Detection, Prosecution and Prevention," *The FBI Law Enforcement Bulletin*, Nov. 1, 1993 (6 pgs).

Amber Avalona-Butler / Paraglide, "At Your Service: Best iPhone Apps for Military Lifestyle," Jul. 9, 2010 (2 pgs).

Aradhye, Hrishikesh B., "A Generic Method for Determining Up/Down Orientation of Text in Roman and Non-Roman Scripts," *Pattern Recognition Society*, Dec. 13, 2014, 18 pages.

Automated Merchant Systems, Inc., "Electronic Check Conversion," http://www.automatedmerchant.com/electronic_check_conversion.cfm, 2006, downloaded Oct. 18, 2006 (3 pgs).

Bills, Steve, "Automated Amount Scanning Is Trend in Remote-Deposit," *American Banker*, New York, NY, Aug. 30, 2005, (3 pgs).

BLM Technologies, "Case Study: Addressing Check 21 and RDC Error and Fraud Threats," *Remote Deposit Capture News Articles* from Jun. 11, 2007, Retrieved from http://www.remotedepositcapture.com/News/june_11_2007.htm on Feb. 19, 2008 (5 pgs).

Blue Mountain Consulting, from Url: www.bluemountainconsulting.com, Cited in U.S. Pat. No. 7,900,822, as dated Apr. 26, 2006 (3 pgs).

Braun, Tim, "Camdesk—Towards Portable and Easy Document Capture," *Image Understanding and Pattern Recognition Research Group, Department of Computer Science, University of Kaiserslautern, Technical Report*, Mar. 29, 2005 (64 pgs). (Retrieved from: <https://pdfs.semanticscholar.org/93b2/ea0d12f24c91f3c46falcd58a76bb132bd2.pdf>).

Bruene, Jim; "Check Free to Enable In-Home Remote Check Deposit for Consumers and Small Business", *NetBanker. Com, Financial Insite, Inc.*, http://www.netbanker.com/2008/02/checkfree_to_enableinhome_rem.html, Feb. 5, 2008 (3 pgs).

Bruene, Jim; "Digital Federal Credit Union and Four Others Offer Consumer Remote Deposit Capture Through EasCorp", *NetBanker—Tracking Online Finance*, www.netbanker.com/2008/04/digital_federal_credit_union_a.html, Apr. 13, 2008 (3 pgs).

Bruno, M., "Instant Messaging," *Bank Technology News*, Dec. 2002 (3 pgs).

Carrubba, P. et al., "Remote Deposit Capture: A White Paper Addressing Regulatory, Operational and Risk Issues," *NetDeposit Inc.*, 2006 (11 pgs).

Century Remote Deposit High-Speed Scanner User's Manual Release 2006, (Century Manual), Century Bank, 2006, (32 pgs).

CNN.com/technology, "Scan, deposit checks from home", www.cnn.com/2008/ITECH/biztech/02/07/check.scanning.ap/index.html, Feb. 7, 2008 (3 pgs).

Creativepaymentsolutions.com, "Creative Payment Solutions—Websolution," www.creativepaymentsolution.com/cps/financialservices/websolution/default.html, Copyright 2008, Creative Payment Solutions, Inc. (1 pg).

Credit Union Journal, "The Ramifications of Remote Deposit Capture Success", www.cuiournal.com/orinthis.html?id=20080411EODZT57G, Apr. 14, 2008 (1 pg).

Credit Union Management, "When You wish Upon an Imaging System . . . the Right Selection Process can be the Shining Star," *Credit Union Management*, Aug. 1993, printed from the internet at [http://search.proquest.com/docview/227756409/14138420743684F7722/15?accountid=14...>](http://search.proquest.com/docview/227756409/14138420743684F7722/15?accountid=14...), on Oct. 19, 2013 (11 pgs).

DCU Member's Monthly—Jan. 2008, "Pc Deposit—Deposit Checks from Home!", <http://www.mycreditunionnewsletter.com/dcu/0108/page1.html>, Copyright 2008 Digital Federal Credit Union (2 pgs).

De Jesus, A. et al., "Distributed Check Processing in a Check 21 Environment: An educational overview of the opportunities and challenges associated with implementing distributed check imaging and processing solutions," *Panini*, 2004, pp. 1-22.

DeBello, James et al., "RDM and Mitek Systems to Provide Mobile Check Deposit," *Mitek Systems, Inc., San Diego, California and Waterloo, Ontario*, (Feb. 24, 2009), 2 pgs.

Doermann, David et al., "Progress in Camera-Based Document Image Analysis," *Proceedings of the Seventh International Conference on Document Analysis and Recognition (ICDAR 2003)* 0-7695-1960-1/03, 2003, IEEE Computer Society, 11 pages.

Duvall, Mel, "Remote Deposit Capture," *Baseline*, vol. 1, Issue 70, Mar. 2007, 2 pgs.

ECU Technologies, "Upост Remote Deposit Solution," Retrieved from the internet <https://www.eutechnologies.com/products/upost.html>, downloaded 2009 (1 pg).

EFT Network Unveils FAXTellerPlus, *EFT Network, Inc.*, www.eltnetwork.com, Jan. 13, 2009 (2 pgs).

ElectronicPaymentProviders, Inc., "FAQs: ACH/ARC, CheckVerification/Conversion/Guarantee, RCK Check Re-Presentation," <http://www.useapp.com/faq.htm>, downloaded Oct. 18, 2006 (3 pgs).

Federal Reserve System, "12 CFR, Part 229 [Regulation CC]: Availability of Funds and Collection of Checks," *Federal Registrar*, Apr. 28, 1997, pp. 1-50.

Federal Reserve System, "Part IV, 12 CFR Part 229 [Regulation CC]: Availability of Funds and Collection of Checks; Final Rule," *Federal Registrar*, vol. 69, No. 149, Aug. 4, 2004, pp. 47290-47328.

Fidelity Information Services, "Strategic Vision Embraces Major Changes in Financial Services Solutions: Fidelity's long-term product strategy ushers in new era of application design and processing," *Insight*, 2004, pp. 1-14.

Fisher, Dan M., "Home Banking in the 21st Century: Remote Capture Has Gone Retail", May 2008 (4 pgs).

Garry, M., "Checking Options: Retailers face an evolving landscape for electronic check processing that will require them to choose among several scenarios," *Supermarket News*, vol. 53, No. 49, 2005 (3 pgs).

Gupta, Maya R et al., "OCR binarization and image pre-processing for searching historical documents," *Pattern Recognition*, vol. 40, No. 2, Feb. 2007, pp. 389-397.

Hale, J., "Picture this: Check 21 uses digital technology to speed check processing and shorten lag time," *Columbus Business First*, <http://columbus.bizjournals.com/columbus/stories/2005/03/14focus1.html>, downloaded 2007 (3 pgs).

Herley, Cormac, "Efficient Inscribing of Noisy Rectangular Objects in Scanned Images," *2004 International Conference on Image Processing*, 4 pages.

Hildebrand, C et al., "Electronic Money," *Oracle*, <http://www.oracle.com/oramag/profit/05-feb/p15financial.html>, 2005, downloaded Oct. 18, 2006 (5 pgs).

Hillebrand, G., "Questions and Answers About the Check Clearing for the 21st Century Act, 'Check 21,'" *ConsumersUnion.org*, <http://www.consumersunion.org/finance/ckclear1002.htm>, Jul. 27, 2004, downloaded Oct. 18, 2006 (6 pgs).

Iida, Jeanne, "The Back Office: Systems—Image Processing Rolls on as Banks Reap Benefits," *American Banker*, Jul. 19, 1993, printed from the internet at <http://search.proquest.com/docview/292903245/14138420743684F7722/14?accountid=14...>>, on Oct. 19, 2013 (3 pgs).

Investment Systems Company, "Portfolio Accounting System," 2000, pp. 1-32.

JBC, "What is a MICR Line?," *eHow.com*, retrieved from http://www.ehow.com/about_4684793_what-micr-line.html on May 4, 2009 (2 pgs).

Kendrick, Kevin B., "Check Kiting, Float for Purposes of Profit," *Bank Security & Fraud Prevention*, vol. 1, No. 2, 1994 (3 pgs).

Knestout, Brian P. et al., "Banking Made Easy" *Kiplinger's Personal Finance Washington*, Jul. 2003, vol. 57, Iss 7 (5 pgs).

Lampert, Christoph et al., "Oblivious Document Capture and Real-Time Retrieval," *International Workshop on Camera Based Document Analysis and Recognition (CBDAR)*, 2005 (8 pgs). (Retrieved from: <http://www-cs.cny.cuny.edu/~wolberg/capstone/bookwarp/LampertCBDAR05.pdf>).

Levitin, Adam J., *Remote Deposit Capture: A Legal and Transactional Overview*, *Banking Law Journal*, p. 115, 2009 (RDC).

(56)

References Cited

OTHER PUBLICATIONS

Liang, Jian et al., Camera-Based Analysis of Text and Documents: A Survey, *International Journal on Document Analysis and Recognition*, Jun. 21, 2005, 21 pages.

Luo, Xi-Peng et al., "Design and Implementation of a Card Reader Based on Build-In Camera," *Proceedings of the 17th International Conference on Pattern Recognition*, 2004, 4 pages.

Matthews, Deborah, "Advanced Technology Makes Remote Deposit Capture Less Risky," *Indiana Bankers Association*, Apr. 2008 (2 pgs).

Metro 1 Credit Union, "Remote Banking Services," <http://www.metro1cu.org/metro1cu/remote.html>, downloaded Apr. 17, 2007 (4 pgs).

Mitek systems, "Imagenet Mobile Deposit", San Diego, CA, downloaded 2009 (2 pgs).

Mitek Systems: Mitek Systems Launches First Mobile Check Deposit and Bill Pay Application, San Diego, CA, Jan. 22, 2008 (3 pgs).

Moreau, T., "Payment by Authenticated Facsimile Transmission: a Check Replacement Technology for Small and Medium Enterprises," *CONNOTECH Experts-conseils, Inc.*, Apr. 1995 (31 pgs).

Nelson, B. et al., "Remote deposit capture changes the retail landscape," *Northwestern Financial Review*, http://findarticles.com/p/articles/mi_qa3799/is200607/ai_n16537250, 2006 (3 pgs).

Netbank, Inc., "Branch Out: Annual Report 2004," 2004 (150 pgs).

Netbank, Inc., "Quick Post: Deposit and Payment Forwarding Service," 2005 (1 pg).

NetDeposit Awarded Two Patents for Electronic Check Process, *NetDeposit*, Jun. 18, 2007, (1 pg).

Nixon, Julie et al., "Fiserv Research Finds Banks are Interested in Offering Mobile Deposit Capture as an," *Fiserv, Inc. Brookfield, Wis.*, (Business Wire), (Feb. 20, 2009), 2 pgs.

Online Deposit: Frequently Asked Questions, <http://www.depositnow.com/faq.html>, Copyright 2008 (1 pg).

RemoteDepositCapture.com, "PNC Bank to Offer Ease of Online Deposit Service Integrated with QuickBooks to Small Businesses", *Remote Deposit Capture News Articles* from Jul. 24, 2006, (2 pgs).

Richey, J. C. et al., "EE 4530 Check Imaging," Nov. 18, 2008 (10 pgs).

SoyBank Anywhere, "Consumer Internet Banking Service Agreement," Dec. 6, 2004 (6 pgs).

Teixeira, D., "Comment: Time to Overhaul Deposit Processing Systems," *American Banker*, Dec. 10, 1998, vol. 163, No. 235, p. 15 (3 pgs).

Thailandguru.com: How and where to Pay Bills @ www.thailandguru.com/paying-bills.html, © 1999-2007 (2 pgs).

The Green Sheet 2.0: Newswire, "CO-OP adds home deposit capabilities to suite of check imaging products", www.greensheet.com/newswire.php?newswire_id=8799, Mar. 5, 2008 (2 pgs).

Valentine, Lisa, "Remote Deposit Capture Hot Just Got Hotter," *ABA Banking Journal*, Mar. 2006, p. 1-9.

Vaream, Craig, "Image Deposit Solutions: Emerging Solutions for More Efficient Check Processing," *JP Morgan Chase*, Nov. 2005 (16 pgs).

Wade, Will, "Early Debate on Remote-Capture Risk," *American Banker*, New York, NY, May 26, 2004 (3 pgs).

Wells Fargo Commercial, "Remote Deposit", www.wellsfargo.com/com/treasury_mgmt/receivables/electronic/remote_deposit, Copyright 2008 (1 pg).

Whitney et al., "Reserve Banks to Adopt DSTU X9.37-2003 Format for Check 21 Image Services", *American Bankers Association*, May 18, 2004, http://www.aba.com/NR/rdonlyres/CBDC1_A5C-43E3-43CC-B733-BE417C638618/35930/DSTUFormat.pdf (2 pages).

Wikipedia®, "Remote Deposit," http://en.wikipedia.org/wiki/Remote_deposit, 2007 (3 pgs).

Windowsfordevices.com, "Software lets camera phone users deposit checks, pay bills", www.windowsfordevices.com/news/NS3934956670.html, Jan. 29, 2008 (3 pgs).

Wolfe, Daniel, "Check Image Group Outlines Agenda," *American Banker*, New York, N.Y.: Feb. 13, 2009, vol. 174, Iss. 30, p. 12. (2 pgs).

Woody Baird Associated Press, "Pastor's Wife got Scammed—She Apparently Fell for Overseas Money Scheme," *The Commercial Appeal*, Jul. 1, 2006, p. A. 1.

Zandifar, A., "A Video-Based Framework for the Analysis of Presentations/Posters," *International Journal on Document Analysis and Recognition*, Feb. 2, 2005, 10 pages.

Zions Bancorporation, "Moneytech, the technology of money in our world: Remote Deposit," http://www.bankjunior.com/pground/moneytech/remote_deposit.jsp, 2007 (2 pgs).

"Quicken Bill Pay", Retrieved from the Internet on Nov. 27, 2007 at: <URL:<http://quickenintuit.com/quicken-bill-pay-jhtml>>, 2 pgs.

"Start to Simplify with Check Imaging a Smarter Way to Bank", Retrieved from the Internet on Nov. 27, 2007, at: <URL: http://www.midnatbank.com/Internet%20Banking/internet_Banking.html>, 3 pgs.

Motomanual, MOTOROKR-E6-GSM-English for wireless phone, copyright 2006, 144 pgs.

White, J.M. et al., "Image Thresholding for Optical Character Recognition and Other Applications Requiring Character Image Extraction", *IBM J. Res. Development*, Jul. 1983, vol. 27, No. 4 (12 pgs).

Ritzer, J.R. "Hinky Dinky helped spearhead POS, remote banking movement", *Bank Systems and Equipment*, vol. 21, No. 12, Dec. 1984 (1 pg).

Dinan, R.F. et al., "Image Plus High Performance Transaction System", *IBM Systems Journal*, 1990 vol. 29, No. 3 (14 pgs).

Gupta, Amar et al., "An Integrated Architecture for Recognition of Totally Unconstrained Handwritten Numerals", WP#3765, Jan. 1993, *Productivity from Information Technology "Profit" Research Initiative Sloan School of Management* (20 pgs).

Masonson, L., "Check Truncation and ACH Trends—Automated Clearing Houses", *healthcare financial management associate*, http://www.findarticles.com/p/articles/mLm3276/is_n7_v47/ai_14466034/print, 1993 (2 Pgs).

Zhang, C.Y., "Robust Estimation and Image Combining" *Astronomical Data Analysis Software and Systems IV, ASP Conference Series*, 1995 (5 pgs).

Kornai Andras et al., "Recognition of Cursive Writing on Personal Checks", *Proceedings of International Workshop on the Frontiers in Handwriting Recognition*, Cited in U.S. Pat. No. 7,900,822, as dated Sep. 1996, (6 pgs).

De Queiroz, Ricardo et al., "Mixed Raster Content (MRC) Model for Compound Image Compression", 1998 (14 pgs).

Rivlin, Alice M. et al., Chair, Vice Chair—Board of Governors, Committee on the Federal Reserve in the Payments Mechanism—Federal Reserve System, "The Federal Reserve in the Payments Mechanism", Jan. 1998 (41 pgs).

Tygar, J.D., Atomicity in Electronic Commerce, *In ACM Networker*, 2:2, Apr./May 1998 (12 pgs).

Anderson, Milton M. "FSML and Echeck", *Financial Services Technology Consortium*, 1999 (17 pgs).

"Full Service Direct Deposit", www.nonprofitstaffing.com/images/upload/dirdepform.pdf. Cited in U.S. Pat. No. 7,900,822, as dated 2001, (2 pgs).

Craig, Ben, "Resisting Electronic Payment Systems: Burning Down the House?", *Federal Reserve Bank of Cleveland*, Jul. 1999 (4 pgs).

Rose, Sarah et al., "Best of the We: The Top 50 Financial Websites", *Money*, New York, Dec. 1999, vol. 28, Iss. 12 (8 pgs).

Furst, Karen et al., "Internet Banking: Developments and Prospects", *Economic and Policy Analysis Working Paper* Sep. 2000, Sep. 2000 (60 pgs).

"Middleware", David E. Bakken, *Encyclopedia of Distributed Computing*, Kluwer Academic Press, 2001 (6 pgs).

Palacios, Rafael et al., "Automatic Processing of Brazilian Bank Checks". Cited in U.S. Pat. No. 7,900,822, as dated 2002 (28 pgs).

Wallison, Peter J., "Wal-Mart Case Exposes Flaws in Banking-Commerce Split", *American Banker*, vol. 167, No. 8, Jan. 11, 2002 (3 pgs).

Heckenberg, D. "Using Mac OS X for Real-Time Image Processing" Oct. 8, 2003 (15 pgs).

(56)

References Cited

OTHER PUBLICATIONS

- Burnett, J. "Depository Bank Endorsement Requirements," BankersOnline.com, <http://www.bankersonline.com/cgi-bin/printview/printview.pl>, Jan. 6, 2003 (3 pgs).
- Blafore, Bonnie "Lower Commissions, Fewer Amenities", Better Investing, Madison Heights: Feb. 2003, vol. 52, Iss 6, (4 pgs).
- "Direct Deposit Authorization Form", www.umass.edu/humres/library/DDForm.pdf, May 2003 (3 pgs).
- "Electronic Billing Problem: The E-check is in the mail" American Banker—vol. 168, No. 95, May 19, 2003 (4 pgs).
- Oxley, Michael G., from committee on Financial Services; "Check Clearing For The 21st Century Act", 108th Congress, 1st Session House of Representatives report 108-132, Jun. 2003 (20 pgs).
- Shelby, Hon. Richard C. (Committee on Banking, Housing and Urban Affairs); "Check Truncation Act of 2003", calendar No. 168, 108th Congress, 1st Session Senate report 108-79, Jun. 2003 (27 pgs).
- Oxley, Michael G., from the committee of conference; "Check Clearing For the 21st Century Act" 108th Congress, 1st Session Senate report 108-291, Oct. 1, 2003 (27 pgs).
- Public Law 108-100, 108 Congress; "An Act Check Clearing For the 21st Century Act", Oct. 28, 2003, 117 STAT. 1177 (18 pgs).
- Johnson, Jennifer J., Secretary of the Board; Federal Reserve System, 12 CFR Part 229, Regulation CC; "Availability of Funds and Collection of Checks". Cited in U.S. Pat. No. 7,900,822, as dated 2009, (89 pgs).
- Mohl, Bruce, "Banks Reimbursing ATM Fee to Compete With Larger Rivals", Boston Globe, Boston, MA, Sep. 19, 2004 (3 pgs).
- The Automated Clearinghouse, "Retail Payment Systems; Payment Instruments Clearing and Settlement: The Automated Clearinghouse (ACH)", www.ffiec.gov/ffiecinfobase/booklets/retailretail_02d.html, Cited in U.S. Pat. No. 7,900,822, as dated Dec. 2005 (3 pgs).
- "Two Words Every Business Should Know: Remote Deposit," Canon, http://www.rpsolutions.com/rpweb/pdfs/canon_rdc.pdf, 2005 (7 pgs).
- Wells Fargo 2005 News Releases, "The New Wells Fargo Electronic Deposit Services Break Through Banking Boundaries In The Age of Check 21", San Francisco Mar. 28, 2005, www.wellsfargo.com/press/3282005_check21Year=2005 (1 pg).
- Constanzo, Chris, "Remote Check Deposit: Wells Captures A New Checking Twist", Bank Technology News Article—May 2005, www.americanbanker.com/btn_article.html?id=20050502YQ50FSYG (2 pgs).
- German Shegalov, Diplom-Informatiker, "Integrated Data, Message, and Process Recovery for Failure Masking in Web Services", Dissertation Jul. 2005 (146 pgs).
- Credit Union Journal, "AFCU Averaging 80 DepositHome Transactions Per Day", Credit Union Journal, Aug. 15, 2005 (1 pg).
- Federal Check 21 Act, "New Check 21 Act effective Oct. 28, 2004: Bank No Longer Will Return Original Cancelled Checks," Consumer Union's FAQ's and Congressional Testimony on Check 21, www.consumerlaw.org/initiatives/content/check21_content.html, Cited in U.S. Pat. No. 7,873,200, as dated Dec. 2005 (20 pgs).
- Bankserv, "DepositNow: What's the difference?" Cited in U.S. Pat. No. 7,970,677, as dated 2006, (4 pgs).
- Bankserv, Product Overview, <http://www.bankserv.com/products/remotedeposit.htm>, Cited in U.S. Pat. No. 7,970,677, as dated 2006, (3 pgs).
- Remotedepositcapture, URL:www.remotedepositcapture.com, Cited in U.S. Pat. No. 7,900,822, as dated 2006 (5 pgs).
- Onlinecheck.com/Merchant Advisors, "Real-Time Check Debit", Merchant Advisors: Retail Check Processing Check Conversion, <http://www.onlinecheck/wach/rcareal.htm>, Cited in U.S. Pat. No. 7,900,822, as dated 2006 (3 pgs).
- "Compliance with Regulation CC", <http://www.federalreserve.gov/Pubs/regcc/regcc.htm>, Jan. 24, 2006 (6 pgs).
- Chiang, Chuck, The Bulletin, "Remote banking offered", <http://bendbulletin.com/apps/pbcs.dll/article?AID=/20060201/BIZ0102/602010327&templ> . . . Feb. 1, 2006 (2 pgs).
- Federal Reserve Board, "Check Clearing for the 21st Century Act", FRB, <http://www.federalreserve.gov/paymentsystems/truncation/>, Mar. 1, 2006 (1 pg).
- Fest, Glen., "Patently Unaware" Bank Technology News, Apr. 2006, Retrieved from the internet at URL:<http://banktechnews.com/article.html?id=2006403T7612618> (5 pgs).
- Bank Systems & Technology, Untitled Article, May 1, 2006, <http://www.banktech.com/showarticle.jhtml?articleID=187003126>, "Are you Winning in The Payment World?" (4 pgs).
- Digital Transactions News, "An ACH-Image Proposal For Check Roils Banks and Networks" May 26, 2006 (3 pgs).
- RemoteDepositCapture.com, Remote Deposit Capture News Articles from Jul. 6, 2006, "BankServ Announces New Remote Deposit Product Integrated with QuickBooks" (3 pgs).
- Dias, Danilo et al., "A Model for the Electronic Representation of Bank Checks", Brasilia Univ. Oct. 2006 (5 pgs).
- "Check Fraud: A Guide to Avoiding Losses", All Net, <http://all.net/books/audit/checkfraud/security.htm>, Cited in U.S. Pat. No. 7,900,822, as dated 2007 (1 pg).
- "What is check Fraud", National Check Fraud Center, <http://www.ckfraud.org/ckfraud.html>, Cited in U.S. Pat. No. 7,900,822, as dated 2007 (12 pgs).
- "Remote Deposit" National City, <http://www.nationalcity.com/smallbusiness/cashmanagement/remotedeposit/default.asp>; Cited in U.S. Pat. No. 7,900,822, as dated 2007 (1 pg).
- "Remote Deposit Capture", Plante & Moran, <http://plantemor.com/industries/fincial/institutions/bank/resources/community+bank+advisor/2007+summer+issue/remotedeposit+capture.htm>. Cited in U.S. Pat. No. 7,900,822, as dated 2007 (3 pgs).
- "Virtual Bank Checks", Morebusiness.com, http://www.morebusiness.com/running_yourBusiness/businessbits/d908484987.brc, Cited in U.S. Pat. No. 7,900,822, as dated 2007 (3 pgs).
- Canon, ImageFormula CR-25/CR-55, "Improve Your Bottom Line with Front-Line Efficiencies", 0117W117, 1207-55/25-1 OM-BSP, Cited in U.S. Pat. No. 7,949,587 as dated 2007. (4 pgs).
- "It's the easiest way to Switch banks", LNB, <http://www.inbky.com/pdf/LNBswitch-kit10-07.pdf> Cited in U.S. Pat. No. 7,996,316, as dated 2007 (7 pgs).
- "Lesson 38—More Bank Transactions", Turtle Soft, <http://www.turtlesoft.com/goldenseal-software-manual.lesson38.htm>, Cited in U.S. Pat. No. 7,900,822, as dated 2007 (8 pgs).
- "Personal Finance", PNC, <http://www.pnc.com/webapp/unsec/productsandservice.do?sitearea=/PNC/home/personal/account+services/quick+switch/quick+switch+faqs>. Cited in U.S. Pat. No. 7,900,822, as dated 2007 (12 pgs).
- "Switching Made Easy," Bank of North Georgia, <http://www.banknorthgeorgia.com/cmsmaster/documents/286/documents616.pdf>, 2007 (7 pgs).
- "Chapter 7 Payroll Programs," Uniform Staff Payroll System, http://www2.oecn.k12.oh.us/www/ssdt/usps/usps_user_guide_005.html, Cited in U.S. Pat. No. 7,900,822, as dated 2007 (9 pgs).
- "Check 21 Solutions," Columbia Financial International, Inc. <http://www.columbiafinancial.us/check21/solutions.htm>, Cited in U.S. Pat. No. 7,900,822, as dated 2007 (8 pgs).
- "Direct Deposit," University of Washington, <http://www.washington.edu/admin/payroll/directdeposit.html>. Cited in U.S. Pat. No. 7,900,822, as dated 2007 (3 pgs).
- "Accept "Customer Not Present" Checks," Accept Check Online, <http://checksoftware.com>. Cited in U.S. Pat. No. 7,900,822, as dated 2007 (1 pg).
- "Customer Personalized Bank Checks and Address Labels" Checks Your Way Inc., http://www.checksyourway.com/htm/web_pages/faq.htm, Cited in U.S. Pat. No. 7,900,822, as dated 2007 (6 pgs).
- "Direct Deposit Application for Payroll", Purdue University, Business Office Form 0003, <http://purdue.edu/payroll/pdf/directdepositapplication.pdf>, Jul. 2007 (2 pgs).
- "Frequently Asked Questions" Bank of America, http://www.bankofamerica.com/deposits/checksave/index.cfm?template=lc_fag_bymail, Cited in U.S. Pat. No. 7,900,822, as dated 2007 (2 pgs).
- "Refractive index" Wikipedia, the free encyclopedia; <http://en.wikipedia.org/wiki/refractiveindex.com> Oct. 16, 2007 (4 pgs).
- Patterson, Scott "USAA Deposit@Home—Another WOW moment for Net Banking", NextCU.com, Jan. 26, 2007 (5 pgs).

(56)

References Cited

OTHER PUBLICATIONS

Remotedepositcapture.com, LLC, "Remote Deposit Capture Overview," ROC Overview, http://remotedepositcapture.com/overview/RDC_overview.htm, Cited in U.S. Pat. No. 7,900,822, as dated Mar. 12, 2007 (4 pgs).

Board of Governors of the federal reserve system, "Report to the Congress on the Check Clearing for the 21st Century Act of 2003" Apr. 2007, Submitted to Congress pursuant to section 16 of the Check Clearing for the 21st Century Act of 2003, (59 pgs).

Image Master, "Photo Restoration: We specialize in digital photo restoration and photograph repair of family pictures", <http://www.imphotorepair.com>, Cited in U.S. Pat. No. 7,900,822, as downloaded Apr. 2007 (1 pg).

"Save on ATM Fees", RedEye Edition, Chicago Tribune, Chicago, IL Jun. 30, 2007 (2 pgs).

Associate of German Banks, SEPA 2008: Uniform Payment Instruments for Europe, Berlin, Cited in U.S. Pat. No. 7,900,822, as dated Jul. 2007, Bundesverband deutscher banker ev (42 pgs).

Affinity Federal Credit Union, "Affinity Announces Online Deposit," Aug. 4, 2005 (1 pg).

"Check 21—The check is not in the post", RedTitan Technology 2004 <http://www.redtitan.com/check21/htm> (3 pgs).

Hartly, Thomas, "Banks Check Out New Image", Business First, Buffalo: Jul. 19, 2004, vol. 20, Issue 43, (3 pgs).

Wade, Will, "Early Notes: Updating Consumers on Check 21" American Banker Aug. 10, 2004 (3 pgs).

Rao, Bharat; "The Internet and The Revolution in Distribution: A Cross-Industry Examination"; Technology in Society; 1999; pp. 287-306; vol. 21, No. 3 (20 pgs).

Alves, Vander and Borba, Paulo; "Distributed Adapters Pattern: A Design for Object-Oriented Distributed Applications"; First Latin American Conference on Pattern Languages of Programming; Oct. 2001; pp. 132-142; Rio de Janeiro, Brazil (11 pgs).

Kiser, Elizabeth K.; "Modeling the Whole Firm: The Effect of Multiple Inputs and Financial Intermediation on Bank Deposit Rates;" FEDS Working Paper No. 2004-07; Jun. 3, 2003; pp. 1-46 (46 pgs).

DeYoung, Robert; "The Financial Performance of Pure Play Internet Banks"; Federal Reserve Bank of Chicago Economic Perspectives; 2001; pp. 60-75; vol. 25, No. 1 (16pgs).

Archive Index Systems; Panini My Vision X-30 or VX30 or X30 © 1994-2008 Archive Systems, Inc. P/O. Box 40135 Bellevue, WA USA 98015 (2 pgs).

Office Action from corresponding U.S. Appl. No. 11/877,307 dated Sep. 26, 2008 (13 pgs).

Office Action from corresponding U.S. Appl. No. 11/877,307 dated Jun. 10, 2009 (20 pgs).

Office Action from corresponding U.S. Appl. No. 11/877,307 dated Dec. 8, 2009 (29 pgs).

Office Action from corresponding U.S. Appl. No. 11/877,307 dated May 13, 2010 (31 pgs).

Office Action from corresponding U.S. Appl. No. 11/877,307 dated Apr. 25, 2011 (39 pgs).

Office Action from corresponding U.S. Appl. No. 11/877,335 dated Sep. 30, 2008 (12 pgs).

Office Action from corresponding U.S. Appl. No. 11/877,335 dated Jun. 24, 2009 (21 pgs).

Office Action from corresponding U.S. Appl. No. 11/877,335 dated May 14, 2010 (22 pgs).

Office Action from corresponding U.S. Appl. No. 11/877,335 dated Sep. 14, 2010 (28 pgs).

Office Action from corresponding U.S. Appl. No. 11/877,335 dated Apr. 25, 2011 (30 pgs).

Office Action from corresponding U.S. Appl. No. 11/877,335 dated Nov. 9, 2011 (10 pgs).

Office Action from corresponding U.S. Appl. No. 11/877,367 dated Oct. 2, 2008 (14 pgs).

Office Action from corresponding U.S. Appl. No. 11/877,367 dated Jun. 23, 2009 (24 pgs).

Office Action from corresponding U.S. Appl. No. 11/877,367 dated Dec. 7, 2009 (47 pgs).

Office Action from corresponding U.S. Appl. No. 11/877,367 dated May 13, 2010 (48 pgs).

Office Action from corresponding U.S. Appl. No. 11/877,367 dated Apr. 29, 2011 (75 pgs).

Office Action from corresponding U.S. Appl. No. 11/877,367 dated Nov. 9, 2011 (9 pgs).

Office Action from corresponding U.S. Appl. No. 11/877,382 dated Sep. 30, 2008 (14 pgs).

Office Action from corresponding U.S. Appl. No. 11/877,382 dated Jun. 25, 2009 (25 pgs).

Office Action from corresponding U.S. Appl. No. 11/877,382 dated May 14, 2010 (30 pgs).

Office Action from corresponding U.S. Appl. No. 11/877,382 dated Sep. 13, 2010 (33 pgs).

Office Action from corresponding U.S. Appl. No. 11/877,382 dated Apr. 26, 2011 (39 pgs).

Office Action from corresponding U.S. Appl. No. 11/877,382 dated Nov. 9, 2011 (9 pgs).

Office Action from corresponding U.S. Appl. No. 11/877,404 dated Oct. 1, 2008 (11 pgs).

Office Action from corresponding U.S. Appl. No. 11/877,404 dated May 28, 2009 (16pgs).

Office Action from corresponding U.S. Appl. No. 11/877,404 dated May 14, 2010 (23pgs).

Office Action from corresponding U.S. Appl. No. 11/877,404 dated Sep. 10, 2010 (27pgs).

Office Action from corresponding U.S. Appl. No. 11/877,404 dated Apr. 27, 2011 (14 pgs).

Patent Disclaimer for U.S. Pat. No. 8,699,779, filed on Mar. 4, 2019, 2 pgs.

Patent Disclaimer for U.S. Pat. No. 8,977,571, filed on Feb. 20, 2019, 2 pgs.

Patent Disclaimer for U.S. Pat. No. 9,336,517, filed on Mar. 4, 2019, 2 pgs.

Patent Disclaimer for U.S. Pat. No. 9,818,090, filed on Feb. 20, 2019, 2 pgs.

CBM2019-00002 U.S. Pat. No. 9,818,090, United Services Automobile Association (USAA)'s Patent Owner Preliminary Response, dated Feb. 20, 2019, 75 pgs.

CBM2019-00002 U.S. Pat. No. 9,818,090, Declaration of Tim Crews in Support of Patent Owner Preliminary Response, dated Feb. 20, 2019, 8 pgs.

CBM2019-00002 U.S. Pat. No. 9,818,090, Declaration of Matthew Calman in Support of Patent Owner Preliminary Response, dated Feb. 20, 2019, 14 pgs.

CBM2019-00002 U.S. Pat. No. 9,818,090, Katie Knight Videotape Deposition Transcript, dated Feb. 8, 2019, 27 pgs.

CBM2019-00002 U.S. Pat. No. 9,818,090, Peter Alexander, Ph.D., Oral and Videotaped Deposition, dated Jan. 23, 2019, 27 pgs.

CBM2019-00002 U.S. Pat. No. 9,818,090, United Services Automobile Association (USAA)'s Updated Exhibit List, dated Mar. 19, 2019, 8pgs.

CBM2019-00003 U.S. Pat. No. 9,336,517, United Services Automobile Association (USAA)'s Patent Owner Preliminary Response, dated Mar. 4, 2019, 91 pgs.

CBM2019-00003 U.S. Pat. No. 8,699,779, Declaration of Matthew Calman in Support of Patent Owner Preliminary Response, dated Mar. 4, 2019, 15 pgs.

CBM2019-00003 U.S. Pat. No. 9,336,517, Katie Knight Videotape Deposition Transcript, dated February 8, 2019, 27 pgs.

CBM2019-00003 U.S. Pat. No. 9,336,517, Peter Alexander, Ph.D., Oral and Videotaped Deposition, dated Jan. 23, 2019, 27 pgs.

CBM2019-00003 U.S. Pat. No. 9,336,517, United Services Automobile Association (USAA)'s Updated Exhibit List Pursuant to 37 CFR 42.63(e), dated Mar. 19, 2019, 8 pgs.

CBM2019-00003 U.S. Pat. No. 9,336,517, Petitioner's Reply Brief to Patent Owner Preliminary Response Pursuant to Authorization Provided in Paper No. 14, dated Apr. 10, 2019, 10 pgs.

CBM2019-00004 U.S. Pat. No. 8,977,571, Declaration of Tim Crews In Support of Patent Owner Preliminary Response, dated Feb. 20, 2019, 8 pgs.

(56)

References Cited

OTHER PUBLICATIONS

CBM2019-00004 U.S. Pat. No. 8,977,571, United Services Automobile Association (USAA)'s Patent Owner Preliminary Response, dated Feb. 20, 2019, 99 pgs.

CBM2019-00004 U.S. Pat. No. 8,977,571, Declaration of Matthew Calman in Support of Patent Owner Preliminary Response, dated Feb. 20, 2019, 14 pgs.

CBM2019-00004 U.S. Pat. No. 8,977,571, United Services Automobile Association (USAA)'s Updated Exhibit List Pursuant to 37 CFR 43.63(e), dated Mar. 19, 2019, 8 pgs.

CBM2019-00005 U.S. Pat. No. 8,699,779, United Services Automobile Association's (USAA)'s Patent Owner Preliminary Response, dated Mar. 4, 2019, 103 pgs.

CBM2019-00005 U.S. Pat. No. 8,699,779, Katie Knight Videotape Deposition Transcript, dated Feb. 8, 2019, 27 pgs.

CBM2019-00005 U.S. Pat. No. 8,699,779 Matthew A. Calman Declaration, dated Mar. 4, 2019, 15 pgs.

CBM2019-00005 U.S. Pat. No. 8,699,779 Peter Alexander, Ph.D., Oral and Videotaped Deposition, dated Jan. 23, 2019, 27 pgs.

CBM2019-00027 U.S. Pat. No. 9,224,138 Declaration of Peter Alexander, Ph.D., dated Mar. 26, 2019, 147 pgs.

CBM2019-00027 U.S. Pat. No. 9,224,136 Petition For Covered Business Method Review of Claims 1-3, 5-9, 11-16 and 18 of U.S. Pat. No. 9,224,136, dated Mar. 28, 2019, 93 pgs.

CBM2019-00027 U.S. Pat. No. 9,224,136 Notice of Filing Date Accorded to Petition and Time for Filing Patent Owner Preliminary Response, dated Apr. 8, 2019, 3 pgs.

CBM2019-00028 U.S. Pat. No. 10,013,681, Plaintiff United Services Automobile Association (USAA) Preliminary Claim Constructions And Extrinsic Evidence, dated Mar. 15, 2019, 74 pgs.

CBM2019-00028 U.S. Pat. No. 10,013,681, Declaration of Peter Alexander, Ph.D., dated Mar. 28, 2019, 94 pgs.

CBM2019-00028 U.S. Pat. No. 10,013,681, Petition For Covered Business Method Review of Claims 1-30 of U.S. Pat. No. 10,013,681, dated Mar. 28, 2019, 99 pgs.

CBM2019-00028 U.S. Pat. No. 10,013,681, Petitioner's Updated Exhibit List (as of Apr. 1, 2019) for U.S. Pat. No. 10,013,681, dated Apr. 1, 2019, 5 pgs.

CBM2019-00028 U.S. Pat. No. 10,013,681, Notice of Filing Date Accorded To Petition and Time For Filing Patent owner Preliminary Response for U.S. Pat. No. 10,013,681, dated Apr. 8, 2019, 3 pgs.

CBM2019-00029 U.S. Pat. No. 10,013,605, Declaration of Peter Alexander, Ph.D., dated Mar. 28, 2019, 76 pgs.

CBM2019-00029 U.S. Pat. No. 10,013,605, Petition For Covered Business Method Review of Claims 1-3, 5-14, 16-29 of U.S. Pat. No. 10,013,605, dated Mar. 28, 2019, 88 pgs.

CBM2019-00029 U.S. Pat. No. 10,013,605, Plaintiff United Services Automobile Association (USAA) Preliminary Claim Constructions And Extrinsic Evidence, dated Mar. 15, 2019, 74 pgs.

IPR2019-00815 U.S. Pat. No. 9,818,090, Petition For Inter Parties Review of Claims 109 of U.S. Pat. No. 9,818,090, dated Mar. 20, 2019, 56 pgs.

IPR2019-00815 U.S. Pat. No. 9,818,090, Declaration of Peter Alexander, Ph.D. as filed in the IPR on Mar. 20, 2019, 99 pgs.

IPR2019-00815 U.S. Pat. No. 9,818,090, Notice of Filing Date Accorded to Petition and Time for Filing Patent Owner Preliminary Response, dated Mar. 27, 2019, 5 pgs.

IPR2019-00815 U.S. Pat. No. 9,818,090, Exhibit B Proposed Claim Constructions for the '571, '090, '779 and '517 Patents, filed on Feb. 28, 2019, 10 pgs.

ABA Routing System Transit Number, Wikipedia, dated Sep. 27, 2006, 3 pgs.

Accredited Standards Committee Technical Report TR 33-2006, dated Aug. 28, 2006, 75 pgs.

Ans X9.100-140-2004, "Specification for an Image Replacement document—IRD", American Standard for Financial Services, Oct. 1, 2004, 15 pgs.

ANSI News, Check 21 Goes Into Effect Oct. 28, 2004, dated Oct. 25, 2004, 1 pg.

ANSI, "Return Reasons for Check Image Exchange of IRDS", dated May 6, 2016, 23 pgs.

ANSI, "Specifications For Electronic Exchange of Check and Image Data", dated Jul. 11, 2006, 230 pgs.

ANSI X9.7-1999(R2007), Bank Check Background and Convenience Amount Field Specification, dated Jul. 11, 2007, 86 pgs.

ASCX9, "Specification for Electronic Exchange of Check and Image Data", date Mar. 31, 2003. 156 pgs.

Bankers' Hotline, "Training Page: Learning the Bank Numbering System", Copyright 2004, 2 pgs.

BrainJar Validation Algorithms, archived on Mar. 16, 2016 from BrainJar.com, 2 pgs.

Canon White Paper, "Two Words Every Business Should Know—Remote Deposit", dated 2005, 7 pgs.

CBR online, "Diebold launches ATM depository technology", Oct. 4, 2007, 5 pgs.

Cheq information Technology White Paper, "Teller Scanner Performance and Scanner Design: Camera Position Relative to the Feeder", dated 2005, 7 pgs.

De Jesus, Angie et al., "Distributed Check Processing In a Check 21 Environment", dated Nov. 2004, 22 pgs.

Federal Reserve Adoption of DSTU X9.37-2003, Image Cash Letter Customer Documentation Version 1.8, dated Oct. 1, 2008, 48 pgs.

Fielding, R. et al, "RFC-2616—Hypertext Transfer Protocol", Network Working Group, The Internet Society copyright 1999, 177 pgs.

Hill, Simon, "From J-Phone to Lumina 1020: A Complete History of the Camera Phone", dated Aug. 11, 2013, 19 pgs.

Instrument—Definition from the Merriam-Webster Online Dictionary, dated Mar. 2, 2019, 1 pg.

Instrument—Definition of instrument from the Oxford Dictionaries (British & World English), dated Jul. 2, 2017, 44 pgs.

iPhone Application Programming Guide Device Support, dated Apr. 26, 2009, 7 pgs.

iPhone Announces the New iPhone 3gs—The Fastest, Most Powerful iPhone Yet, Press Release dated Jun. 8, 2009, 4 pgs.

Klein, Robert, Financial Services Technology, "Image Quality and Usability Assurance Phase 1 Project", dated Jul. 23, 2004, 67 pgs.

Lange, Bill, "Combining Remote Capture and IRD Printing, A Check 21 Strategy For Community and Regional Banks", dated 2005, 25 pgs.

Lee, Jeanne, "Mobile Check Deposits: Pro Tips to Ensure They Go Smoothly", dated Feb. 19, 2016, 6 pgs.

Meara, Bob, "State of Remote Deposit Capture 2015: Mobile Is the New Scanner", Dated May 26, 2015, obtained from the Internet at <https://www.celent.com/insights/57842967>, 3 pgs.

Meara, Bob, "State of Remote Deposit Capture 2015 Mobile is the New Scanner", dated May 2015, 56 pgs.

Meara, Bob, "USAA's Mobile Remote Deposit Capture Initiative", Dated Jun. 26, 2009, 2 pgs.

Mitek's Mobile Deposit Processes More Than Two Billion Checks, \$1.5 Trillion in Cumulative Check Value, dated Mar. 18, 2018, 2 pgs.

Mitek, "Video Release—Mitek MiSnap™ Mobile Auto Capture Improves Mobile Deposit® User Experience at Ten Financial Institutions", dated Jul. 15, 2014, 2 pgs.

NCR, Mobile Remote Deposit Capture (RDC), copyright 2011, 8 pgs.

Nokia N90 Review Digital Trends, dated Feb. 11, 2019, obtained from the Internet at: <https://www.digitaltrends.com/cell-phone-reviews/nokia-n90-review/>, 11 pgs.

Nokia N95 8GB User Guide, copyright 2009, (from the Wells Fargo Bank, N.A. IPR2019-00815, filed on Mar. 20, 2019), Part 1 of 3, 67 pgs.

Nokia N95 8GB User Guide, copyright 2009, (from the Wells Fargo Bank, N.A. IPR2019-00815, filed on Mar. 20, 2019), Part 2 of 3, 60 pgs.

Nokia N95 8GB User Guide, copyright 2009, (from the Wells Fargo Bank, N.A. IPR2019-00815, filed on Mar. 20, 2019), Part 3 of 3, 53 pgs.

Patel, Kunur, Ad Age, "How Mobile Technology Is Changing Banking's Future", dated Sep. 21, 2009, 3 pgs.

Remote Deposit Capture Basic Requirements, dated Aug. 22, 2009, 1 pg.

(56)

References Cited

OTHER PUBLICATIONS

Remote Deposit Capture.com Scanner Matrix, dated Oct. 21, 2011, 3 pgs.

Rowles, Tony, *USAA-v. Wells Fargo* No. 2:16-cv-245-JRGL e-mail correspondence dated Jan. 24, 2019, 2 pgs.

Sechrest, Stuart et al., "Windows XP Performance", Microsoft, dated Jun. 1, 2001, 20 pgs.

Spenser, Harvey, "White Paper Check 21 Controlling Image Quality At The Point of Capture", dated 2004, 7 pgs.

Timothy R. Crews list of Patents, printed from the United States Patent and Trademark Office on Feb. 13, 2019, 7 pgs.

Van Dyke, Jim, "2017 Mitek Mobile Deposit Benchmark Report", copyright 2017, 50 pgs.

Wausau, "Understanding Image Quality & Usability Within a New Environment", copyright 2019, 1 pg.

Whitney, Steve et al., "A Framework For Exchanging Image Returns", dated Jul. 2001, 129 pgs.

CBM2019-00005 U.S. Pat. No. 8,699,779, Patent Owner's Sur-Reply Brief to Petitioner's Reply Brief to Patent Owner Preliminary Response Pursuant to Authorization Provided in Paper No. 15, dated May 1, 2019, 7 pgs.

CBM2019-00004 U.S. Pat. No. 8,977,571, Defendant's Claim Construction Brief and supporting exhibits, *United Services Automobile Association v. Wells Fargo Bank, N.A.*, Civil Action No. 2:18-cv-245, dated Apr. 25, 2019, 186 pgs.

USAA's Opening Claim Construction Brief, *United Services Automobile Association v. Wells Fargo Bank, N.A.*, Civil Action No. 2:18-cv-245, dated Apr. 11, 2019, 32 pgs.

CBM2019-00004 U.S. Pat. No. 8,977,571, Patent Owner's Sur-Reply Brief to Petitioner's Reply Brief to Patent Owner Preliminary Response Pursuant to Authorization Provided in Paper 14, dated Apr. 30, 2019, 7 pgs.

USAA's Reply to Claim Construction Brief, *United Services Automobile Association v. Wells Fargo Bank, N.A.*, Civil Action No. 2:18-cv-245, dated May 2, 2019, 15 pgs.

CBM2019-00005 U.S. Pat. No. 8,699,779, Patent Owner's Sur-Reply Brief Pursuant to Petitioner's Reply Brief to Patent Owner Preliminary Response Pursuant to Authorization Provided in Paper 15, dated May 1, 2019, 7 pgs.

P.R. 4-3 Joint Claim Construction and Pre-Hearing Statement, *United Services Automobile Association v. Wells Fargo Bank, N.A.*, Civil Action No. 2:18-cv-366, dated Apr. 5, 2019, 199 pgs.

Defendant Wells Fargo Bank, N.A.'s Amended Answer, Affirmative Defenses, and Counterclaims to Plaintiff's Complaint, *United Services Automobile Association v. Wells Fargo Bank, N.A.*, Civil Action No. 2:18-cv-366, dated Apr. 12, 2019, 32 pgs.

Plaintiff and Counterclaim Defendant's Answer to Defendant and Counterclaims Plaintiff's Amended Answer, Affirmative Defenses, & Counterclaims, *United Services Automobile Association v. Wells Fargo Bank, N.A.*, Civil Action No. 2:18-cv-366, dated Apr. 26, 2019, 18 pgs.

Plaintiff and Counterclaim Defendant's Answer to Defendant and Counterclaims Plaintiff's Amended Answer, Affirmative Defenses, & Counterclaims, *United Services Automobile Association v. Wells Fargo Bank, N.A.*, Civil Action No. 2:18-cv-245, dated Mar. 21, 2019, 36 pgs.

USAA's Reply Claim Construction Brief, *United Services Automobile Association v. Wells Fargo Bank, N.A.*, Civil Action No. 2:18-cv-245, dated May 2, 2019, 227 pgs.

Parties' P.R. 4-5(D) Joint Claim Construction Chart, *United Services Automobile Association v. Wells Fargo Bank, N.A.*, Civil Action No. 2:18-cv-245, dated May 9, 2019, 25 pgs.

CBM2019-00002 U.S. Pat. No. 9,818,090, Decision Denying Institution of Covered Business Method Patent Review 37 C.F.R. § 42.208, dated Apr. 26, 2019, 5 pgs.

CBM2019-00003 U.S. Pat. No. 9,336,517, Decision Denying Institution of Covered Business Method Patent Review 37 C.F.R. § 42.208, dated Jun. 3, 2019, 28 pgs.

CBM2019-00004 U.S. Pat. No. 8,977,571, Decision Denying Institution of Covered Business Method Patent Review 37 C.F.R. § 42.208, dated May 15, 2019, 33 pgs.

CBM2019-00005 U.S. Pat. No. 8,699,779, Decision Denying Institution of Covered Business Method Patent Review 37 C.F.R. § 42.208, dated Jun. 3, 2019, 27 pgs.

USAA's Opening Claim Construction Brief, filed in Civil Action No. 2:18-CV-366, dated May 17, 2019, 670 pgs.

Defendant's Claim Construction Brief, filed in Civil Action No. 2:18-CV-366, dated May 31, 2019, 111 pgs.

Plaintiff's Notice of Filing Claim Construction Presentation, filed in Civil Action No. 2:18-CV-245, dated May 23, 2019, 106 pgs.

IPR2019-01081 U.S. Pat. No. 9,336,517, Petition for Inter Partes Review of Claims 1, 5-10, 12-14, 17-20 of U.S. Pat. No. 9,336,517, dated Jun. 5, 2019, 78 pgs.

IPR2019-01082 U.S. Pat. No. 8,977,571, Petition for Inter Partes Review of Claims 1-13 U.S. Pat. No. 9,336,517, dated Jun. 5, 2019, 75 pgs.

IPR2019-01083 U.S. Pat. No. 8,699,779, Petition for Inter Partes Review of Claims 1-18 U.S. Pat. No. 9,336,517, dated Jun. 5, 2019, 74 pgs.

Defendant Wells Fargo Bank, N.A.'s Answer, Affirmative Defenses, and Counterclaims to Plaintiff's Complaint, dated Aug. 14, 2018, 64 pgs.

Leica Digilux 2 Instructions located on the Internet http://www.Overgaard.dk/pdf/d2_manual.pdf (attached as Exhibit 2 from the Defendant Wells Fargo Bank N.A.'s Answer dated Aug. 14, 2018), 95 pgs.

SONY Digital Camera User's Guide/Trouble Shooting Operating Instructions, copyright 2005, located on the Internet at: <https://www.sony.co.uk/electronics/support/res/manuals/2654/26544941M.pdf> (attached as Exhibit 3 from the Defendant Wells Fargo Bank N.A.'s Answer dated Aug. 14, 2018), 136 pgs.

Panasonic Operating Instructions for Digital Camera/Lens Kit Model No. DMC-L1K, https://www.panasonic.com/content/dam/Panasonic/support_manual/Digital_Still_Camera/English_01-vqt0-vqt2/vqt0w95_L1_oi.pdf (attached as Exhibit 4 from the Defendant Wells Fargo Bank N.A.'s Answer dated Aug. 14, 2018), 129 pgs.

Nikon Digital Camera D300 User's Manual, located on the Internet at [http://download.nikonimglib.com/archive2/iBuJv00Aj97i01y8BrK49XX0Ts69/D300_EU\(En\)04.pdf](http://download.nikonimglib.com/archive2/iBuJv00Aj97i01y8BrK49XX0Ts69/D300_EU(En)04.pdf) (attached as Exhibit 5 from the Defendant Wells Fargo Bank, N.A.'s Answer dated Aug. 14, 2018), 195 pgs.

Canon EOS 40D Digital Camera Instruction Manual, located on the Internet at http://gdlp01.c-wss.com/gds/6/0900008236/01/EOS40D_HG_EN.pdf (attached as Exhibit 6 from the Defendant Wells Fargo Bank, N.A.'s Answer dated Aug. 14, 2018), 38 pgs.

Motorola RAZR MAXX V6 User Manual, located on the Internet at https://www.phonearena.com/phones/Motorola-RAZR-MAXX-V6_id1680, (attached as Exhibit 7 from the Defendant Wells Fargo Bank, N.A.'s Answer dated Aug. 14, 2018), 36 pgs.

Motomanual for Motorazr, located on the Internet at <https://www.cellphones.ca/downloads/phones/manuals/motorola-razr-v3xx-manual.pdf> (excerpts attached as Exhibit 8 from the Defendant Wells Fargo Bank, N.A.'s Answer dated Aug. 14, 2018), 34 pgs.

Nokia N95 8GB User Guide, copyright 2009, located on the Internet at https://www.nokia.com/en_int/phones/sites/default/files/user-guides/Nokia_N95_8GB_Extended_UG_en.pdf (excerpts attached as Exhibit 9 from the Defendant Wells Fargo Bank, N.A.'s Answer dated Aug. 14, 2018), 77 pgs.

Helio Ocean User Manual, located on the Internet at: https://standupwireless.com/wp-content/uploads/2017/04/Manual_PAN-TECH_OCEAN.pdf (excerpts attached as Exhibit 10 from the Defendant Wells Fargo Bank, N.A.'s Answer dated Aug. 14, 2018), 76 pgs.

HTC Touch Diamond Manual, copyright 2008, (attached as Exhibit 11 from the Defendant Wells Fargo Bank, N.A.'s Answer dated Aug. 14, 2018), 257 pgs.

Automated Clearing Houses (ACHs), Federal Reserve Bank of New York (May 2000) available at: <https://www.newyorkfed.org/aboutthefed/fedpoint/fed31.html>, (attached as Exhibit 12 from the Defendant Wells Fargo Bank, N.A.'s Answer dated Aug. 14, 2018), 4 pgs.

(56)

References Cited

OTHER PUBLICATIONS

POP, ARC and BOC—A Comparison, Federal Reserve Banks, at 1 (Jan. 7, 2009), available on the Internet at https://web.archive.org/web/20090107101808/https://www.frb-services.org/files/eventseducation/pdf/pop_arc_boc_comparison.pdf (attached as Exhibit 13 from the Defendant Wells Fargo Bank, N.A.’s Answer dated Aug. 14, 2018), 3 pgs.

David B. Humphrey & Robert Hunt, *Getting Rid of Paper: Savings From Check 21*, Working Paper No. 12-12, Research Department, Federal Reserve Bank of Philadelphia, (May 2012), available on the Internet at: <https://philadelphiafed.org/-/media/research-and-data/publications/working-papers/2012/wp12-12.pdf>, (attached as Exhibit 14 from the Defendant Wells Fargo Bank, N.A.’s Answer dated Aug. 14, 2018), 29 pgs.

Jeffrey M. Lacker, *Payment System Disruptions and the Federal Reserve Following Sep. 11, 2001*, The Federal Reserve Bank of Richmond, (Dec. 23, 2003) (attached as Exhibit 19 from the Defendant Wells Fargo Bank, N.A.’s Answer dated Aug. 14, 2018), 55 pgs.

Check Clearing for the 21st Century Act Foundation for Check 21 Compliance Training, Federal Financial Institutions Examination Council, (Oct. 16, 2004), available on the Internet at <https://web.archive.org/web/20041016100648/https://www.ffiec.gov/exam/check21/check21foundationdoc.htm>, (excerpts attached as Exhibit 20 from the Defendant Wells Fargo Bank, N.A.’s Answer dated Aug. 14, 2018), 11 pgs.

Big Red Book, Adobe Systems Incorporated, copyright 2000, (attached as Exhibit 27 from the Defendant Wells Fargo Bank, N.A.’s Answer dated Aug. 14, 2018), 45 pgs.

CBM2019-00005 U.S. Pat. No. 8,699,779, Patent Owner’s Sur-reply Brief to Petitioner’s Reply Brief to Patent Owner Preliminary Response Pursuant to Authorization Provided in Paper No. 15, dated May 1, 2019, 7 pgs.

CBM2019-00004 U.S. Pat. No. 8,977,571, Defendant’s Claim Construction Brief and supporting exhibits. *United Services Automobile Association v. Wells Fargo Bank, N.A.*, Action No. 2:18-cv-245, dated Apr. 25, 2019, 36 pgs.

Parties’ P.R. 4-5(D) Joint Claim Construction Chart, *United Services Automobile Association v. Wells Fargo Bank, N.A.*, Civil Action No. 2:18-cv-245, dated May 9, 2019, 5 pgs.

USAA’s Opening Claim Construction Brief, filed in Civil Action No. 2:18-CV-366, dated May 17, 2019, 32 pgs.

Plaintiff’s Notice of Filing Claim Construction Presentation, filed in Civil Action No. 2:18-CV-245, dated May 23, 2019, 106 pgs.

IPR2019-01082 U.S. Pat. No. 8,977,571, Petition for Inter Partes Review of Claims 1-13 U.S. Pat. No. 8,977,571, dated Jun. 5, 2019, 75 pgs.

IPR2019-01083 U.S. Pat. No. 8,699,779, Petition for Inter Partes Review of Claims 1-18 U.S. Pat. No. 8,699,779, dated Jun. 5, 2019, 74 pgs.

Plaintiff’s Notice of Decisions Denying Institution of Covered Business Method Patent Review, filed in Civil Action No. 2:18-CV-245, dated Jun. 6, 2019, 61 pgs.

Claim Construction Memorandum Opinion and Order, filed in Civil Action No. 2:18-CV-245, dated Jun. 13, 2019, 48 pgs.

Parties’ P.R.4-5(D) Joint Claim Construction Chart, filed in Civil Action No. 2:18-CV-245, ated Jun. 14, 2019, 28 pgs.

Defendant’s Claim Construction Brief, filed in Civil Action No. 2:18-CV-366, dated May 31, 2019, 28 pgs.

USAA’s Reply Claim Construction Brief, filed in Civil Action No. 2:18-CV-366, dated Jun. 7, 2019, 14 pgs.

Wells Fargo’s Objections to Magistrate Judge Payne’s Claim Construction Memorandum Opinion and Order, filed in Civil Action No. 2:18-CV-245, dated Jun. 27, 2019, 7 pgs.

USAA’s Objections to Magistrate Judge Payne’s Claim Construction Memorandum Opinion and Order, filed in Civil Action No. 2:18-CV-245, dated Jun. 27, 2019, 6 pgs.

Parties’ P.R. 4-5(D) Joint Claim Construction Chart, filed in Civil Action No. 2:18-CV-366, dated Jun. 18, 2019, 27 pgs.

IPR2019-00815, Invalidity Chart, uploaded on Jun. 27, 2019, 94 pgs.

IPR2019-00815, United Services Automobile Association (“USAA”)’s Patent Owner Preliminary Response, dated Jun. 27, 2019, 66 pgs.
IPR2019-00815, Supplemental Invalidity Chart, dated on Jun. 27, 2019, 16 pgs.

IPR2019-00815, Declaration of Matthew A. Calman in Support of Patent Owner Preliminary Response, dated Jun. 27, 2019, 25 pgs.
CBM 2019-00027, Declaration of Bharat Prasad, dated Jul. 8, 2019, 32 pgs.

CBM 2019-00027, Patent Owner Preliminary Response and Exhibits 2001-1042, dated Jul. 8, 2019, 91 pgs.

CBM 2019-00028, United Services Automobile Association (“USAA”)’s Patent Owner Preliminary Response, dated Jul. 8, 2019, 73 pgs.

CBM2019-00028, Declaration of Matthew A. Calman in Support of Patent Owner Preliminary Response, dated Jul. 8, 28 pgs.

CBM2019-00028, Malykhina, Elena “Get Smart”. Copyright 2006 by ProQuest Information and Learning Company, 6 pgs.

CBM2019-00028, Palm Treo 700W Smartphone manual, Copyright 2005 by Palm, Inc., 96 pgs.

CBM2019-00028, 00000 C720w User Manual for Windows Mobile Smart Phone, Copyright 2006, 352 pgs.

CBM2019-00028, “Smarter Than Your Average Phone”, Copyright 2006 by Factiva, 4 pgs.

CBM2019-00028, “64 Million Smart Phones Shipped Worldwide in 2006”, Canalys Newsroom, 2006, 3 pgs.

CBM2019-00028, Nokia 9500 Communicator user Guide, Copyright 2006 by Nokia Corporation, 112 pgs.

CBM2019-00028, Robinson, Daniel, “Client Week—Headsets advance at 3GSM”, Copyright 2004 by VNU Business Publications Ltd., 2 pgs.

CBM2019-00028, Burney, Brett “MacBook Pro with Intel processor is fast, innovative”, Copyright 2006 by Plain Dealer Publishing Co., 2 pgs.

CBM2019-00028, 17-inch MacBook Pro User’s Guide, Copyright 2006 by Apple Computer, Inc., 144 pgs.

CBM2019-00028, Wong, May “HP unveils new mobile computers”, Copyright 2006 by The Buffalo News, 2 pgs.

CBM2019-00028, Jewell, Mark “Cell Phone Shipments Reach Record 208M”, Copyright 2005 by Associated Press, 1 pg.

CBM 2019-00028, Lawler, Ryan “Apple shows Intel-based Macs, surge in revenue”, Copyright 2006 by The Yomiuri Shimibun, 2 pgs.

CBM 2019-00028, Aspire 9800 Series User Guide, Copyright 2006 by Acer International, 122 pgs.

CBM 2019-00028, Dell XPS M1210 Owner’s Manual, Copyright 2006 by Dell Inc., 192 pgs.

CBM 2019-00028, Estridge, Bonnie “Is your phone smart enough?: The series that cuts through the technobabble to bring you the best advice on the latest gadgets”, Copyright 2006 by XPRESS—A1 Nsr Media, 3 pgs.

CBM 2019-00028, “Motorola, Palm collaborate on smart phone”, Copyright 2000 by Crain Communications, Inc., 1 pg.

CBM 2019-00028, Nasaw, Daniel “Viruses Pose threat to “Smart” Cellphones—Computer Programs Could Cripple Devices and Shut Down Wireless Networks”, Copyright 2004 by Factiva, 2 pgs.

CBM 2019-00028, Seitz, Patrick “Multifunction Trend Shaking Up The Handheld Device industry; Solid Sales Expected in 2004; PDA, handset, camera—one single, small product can fill a variety of roles”, Copyright 2004 investor’s Business Daily, Inc., 3 pgs.

Microsoft Mobile Devices Buyer’s Guide, 2012, 4 pgs.

Microsoft Mobile Devices Smartphone, 2003, 2 pgs.

Plaintiff’s Notice of Decision Denying Institution of Covered Business Method Patent Review, filed in Civil Action No. 2:18-CV-245, dated May 15, 2019, 36 pgs.

Defendant’s Claim Construction Brief, filed in Civil Action No. 2:18-CV-366, dated Jun. 4, 2019, 28 pgs.

CBM2019-00029, United Services Automobile Association (USAA)’s Patent Owner Preliminary Response, dated Jul. 17, 2019, 76 pgs.

CBM2019-00029, Declaration of Matthew A. Calman in Support of Patent Owner Preliminary Response, dated Jul. 17, 2019, 29 pgs.

CBM2019-00029, Defendant’s Claim Construction Brief, filed in Civil Action No. 2:18-CV-366, dated May 31, 2019, 28 pgs.

(56)

References Cited

OTHER PUBLICATIONS

CBM2019-00029, Palenchar, Joseph, "PDA Phone Adds WiFi VoIP Turn-By-Turn GPS Navigation". Copyright 2006 by Reed Business Information, 2 pgs.

CBM2019-00029, HP User Guide, Additional Product Information, Copyright 2006 by Hewlett-Packard Development Company, L.P., 204 pgs.

CBM2019-00029, Pocket PC User Manual, Version 1, dated May 2006 by Microsoft, 225 pgs.

CBM2019-00029, "Dynamism.com: Take tomorrow's tech home today with Dynamism.com: Latest, gadgets merge next generation technology with high style design", Copyright 2006 Normans Media Limited, 2 pgs.

IPR2019-00815, Federal Reserve Financial Services Retired: DSTU X9.37-2003, Specifications for Electronic Exchange of Check and Image Data, Copyright 2006 by Accredited Standards Committee X9, Inc., dated Mar. 31, 2003, 157 pgs.

IPR2019-01081, Declaration of Peter Alexander, Ph.D, dated Jun. 5, 2019, 135 pgs.

P.R. 4-3 Joint Claim Construction and Pre-Hearing Statement, *United Services Automobile Association v. Wells Fargo Bank, N.A.*, Civil Action No. 2:18-cv-366, dated Apr. 5, 2019, 190 pgs.

IPR2020-00093, U.S. Pat. No. 9,892,454, Petition for Inter Parties Review of Claims 1-22 of U.S. Pat. No. 9,892,454, dated Nov. 7, 2019, 82 pgs.

IPR2020-00094, U.S. Pat. No. 9,898,778. Petition for Inter Parties Review of Claims 1, 4-7, 10-13 and 16-20 U.S. Pat. No. 9,898,778, dated Nov. 7, 2019, 60 pgs.

U.S. Appl. No. 61/022,279, dated Jan. 18, 2008, (cited in PR2020-00090, U.S. Pat. No. 9,177,197), 35 pgs.

Herley, Cormac, "Recursive Method To Extract Rectangular Objects From Scans", *Microsoft Research*, Oct. 2003, 4 pgs.

Panini My Vision X Operator Manual, Panini, 2004, (cited in IPR2020-00093, U.S. Pat. No. 9,892,454), 51 pgs.

Tochip, E. et al., "Camera Phone Color Appearance Utility", *Matlab at Stanford University*, 2007, 25 pgs.

Yeo, L.H. et al., "Submission of transaction from mobile workstations in a cooperative multidatabase environment", *IEEE*, 1994, (cited in IPR2020-00097, U.S. Pat. No. 7,885,880), 10 pgs.

Andrew S. Tanenbaum, *Modern Operating Systems*, Second Edition (2001).

Arnold et al, *The Java Programming Language*, Fourth Edition (2005).

Consumer Assistance & Information—Check 21 <https://www.fdic.gov/consumers/assistance/protection/check21.html> (FDIC).

Halonen et al., *GSM, GPRS, and EDGE Performance: Evolution Towards 3G/UMTS*, Second Edition (2003).

Heron, *Advanced Encryption Standard (AES)*, 12 Network Security 8 (2009).

Immich et al., *Performance Analysis of Five Interprocess Communication Mechanisms Across UNIX Operating Systems*, 68 J. Sys. & Software 27 (2003).

Leach, et al., *A Universally Unique Identifier (UUID) URN Namespace*, (Jul. 2005) retrieved from <https://www.ietf.org/rfc/rfc4122.txt>.

N. Ritter & M. Ruth, *The Geo Tiff Data Interchange Standard for Raster Geographic Images*, 18 Int. J. Remote Sensing 1637 (1997).

Pbmplus—image file format conversion package, retrieved from <https://web.archive.org/web/20040202224728/https://www.acme.com/software/pbmplus/>.

Petition filed by PNC Bank N.A. for Inter Parties Review of Claims 1-23 of U.S. Pat. No. 10,482,432, dated Jul. 14, 2021, IPR2021-01071, 106 pages.

Petition filed by PNC Bank N.A. for Inter Parties Review of Claims 1-7, 10-21 and 23 of U.S. Pat. No. 10,482,432, dated Jul. 14, 2021, IPR2021-01074.

Petition filed by PNC Bank N.A. for Inter Parties Review of Claims 1-18 of U.S. Pat. No. 10,621,559, dated Jul. 21, 2021, IPR2021-01076, 111 pages.

Petition filed by PNC Bank N.A. for Inter Parties Review of Claims 1-18 of U.S. Pat. No. 10,621,559, filed Jul. 21, 2021, IPR2021-01077; 100 pages.

Petition filed by PNC Bank N.A. for Inter Parties Review of Claims 1-30 of U.S. Pat. No. 10,013,681, filed Aug. 27, 2021, IPR2021-01381, 127 pages.

Petition filed by PNC Bank N.A. for Inter Parties Review of U.S. Pat. No. 10,013,605, filed Aug. 27, 2021, IPR2021-01399, 113 pages.

Readdle, *Why Scanner Pro is Way Better Than Your Camera?* (Jun. 27, 2016) retrieved from <https://readdle.com/blog/why-scanner-pro-is-way-better-than-your-camera>.

Santomero, *The Evolution of Payments in the U.S.: Paper vs. Electronic* (2005) retrieved from https://web.archive.org/web/20051210185509/https://www.philadelphiafed.org/publicaffairs/speeches/2005_santomero9.html.

Schindler, *Scanner Pro Review* (Dec. 27, 2016) retrieved from <https://www.pcmag.com/reviews/scanner-pro>.

Sing Li & Jonathan Knudsen, *Beginning J2ME: From Novice to Professional*, Third Edition (2005), ISBN (pbk): 1-59059-479-7, 468 pages.

Wang, Ching-Lin et al. "Chinese document image retrieval system based on proportion of black pixel area in a character image", the 6th International Conference on Advanced Communication Technology, 2004, vol. 1, IEEE, 2004.

Zaw, Kyi Pyar and Zin Mar Kyu, "Character Extraction and Recognition for Myanmar Script Signboard Images using Block based Pixel Count and Chain Codes" 2018 IEEE/ACIS 17th International Conference on Computer and Information Science (CS), IEEE, 2018.

Jung et al., "Rectangle Detection based on a Windowed Hough Transform", *IEEE Xplore*, 2004, 8 pgs.

Craig Vaream, "Image Deposit Solutions" *Emerging Solutions for More Efficient Check Processing*, Nov. 2005, 16 pages.

Certificate of Accuracy related to Article entitled, "Deposit checks by mobile" on webpage <https://www.elmundo.es/navegante/2005/07/21/empresas/1121957427.html> signed by Christian Paul Scrogum (translator) on Sep. 9, 2021.

Fletcher, Lloyd A., and Rangachar Kasturi, "A robust algorithm for text, string separation from mixed text/graphics images", *IEEE transactions on pattern analysis and machine intelligence* 10.6 (1988), 910-918 (1988).

IPR 2022-00076 filed Nov. 17, 2021 on behalf of PNC Bank N.A., 98 pages.

IPR 2022-00075 filed Nov. 5, 2021 on behalf of PNC Bank N.A., 90 pages.

IPR 2022-00050 filed Oct. 22, 2021 on behalf of PNC Bank N.A., 126 pages.

IPR 2022-00049 filed Oct. 22, 2021 on behalf of PNC Bank N.A., 70 pages.

About Network Servers, GlobalSpec (retrieved from https://web.archive.org/web/20051019130842/http://globalspec.com.80/LearnMore/Networking_Communication_Equipment/Networking_Equipment/Network_Servers ("GlobalSpec").

FDIC: Check Clearing for the 21st Century act (Check21), FED. Deposit Ins. Corp., Apr. 25, 2016 (retrieved from <https://web.archive.org/web/20161005124304/https://www.fdic.gov/consumers/assistance/protection/check21.html> ("FDIC").

Bruno-Britz, Maria "Mitek Launches Mobile Phone Check Capture Solution," *Bank Systems and Technologies Information Week* (Jan. 24, 2008).

V User Guide, [https://www.Iq.com/US/support/manualsdocuments?customerModelCode=20LGVX9800&csSalesCode=LGVX9800,select=VERSION\(USA\)en](https://www.Iq.com/US/support/manualsdocuments?customerModelCode=20LGVX9800&csSalesCode=LGVX9800,select=VERSION(USA)en); The V_UG_051125.pdf. Ming Phone User Manual, 2006.

Patel, Kunur, "How Mobile Technology is Changing Banking's Future" *AdAge*, Sep. 21, 2009, 4 pages.

Spencer, Harvey, "Controlling Image Quality at the Point of Capture" *Check 21, Digital Check Corporation & HSA* 2004.

Moseik, Celeste K., "Customer Adoption of Online Restaurant Services: A MultiChannel Approach", Order No. 1444649 Univer-

(56)

References Cited

OTHER PUBLICATIONS

city of Delaware, 2007, Ann Arbor ProQuest., Web. Jan. 10, 2022
(Year: 2007).

* cited by examiner

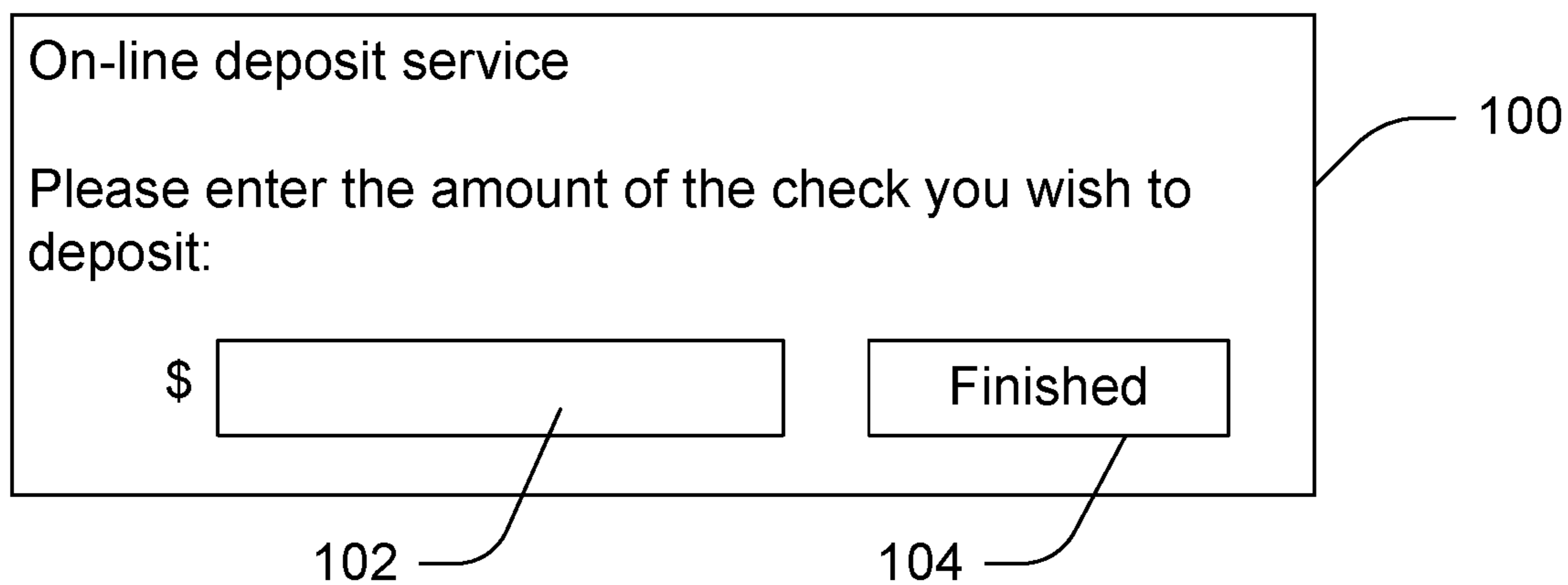

FIG. 1

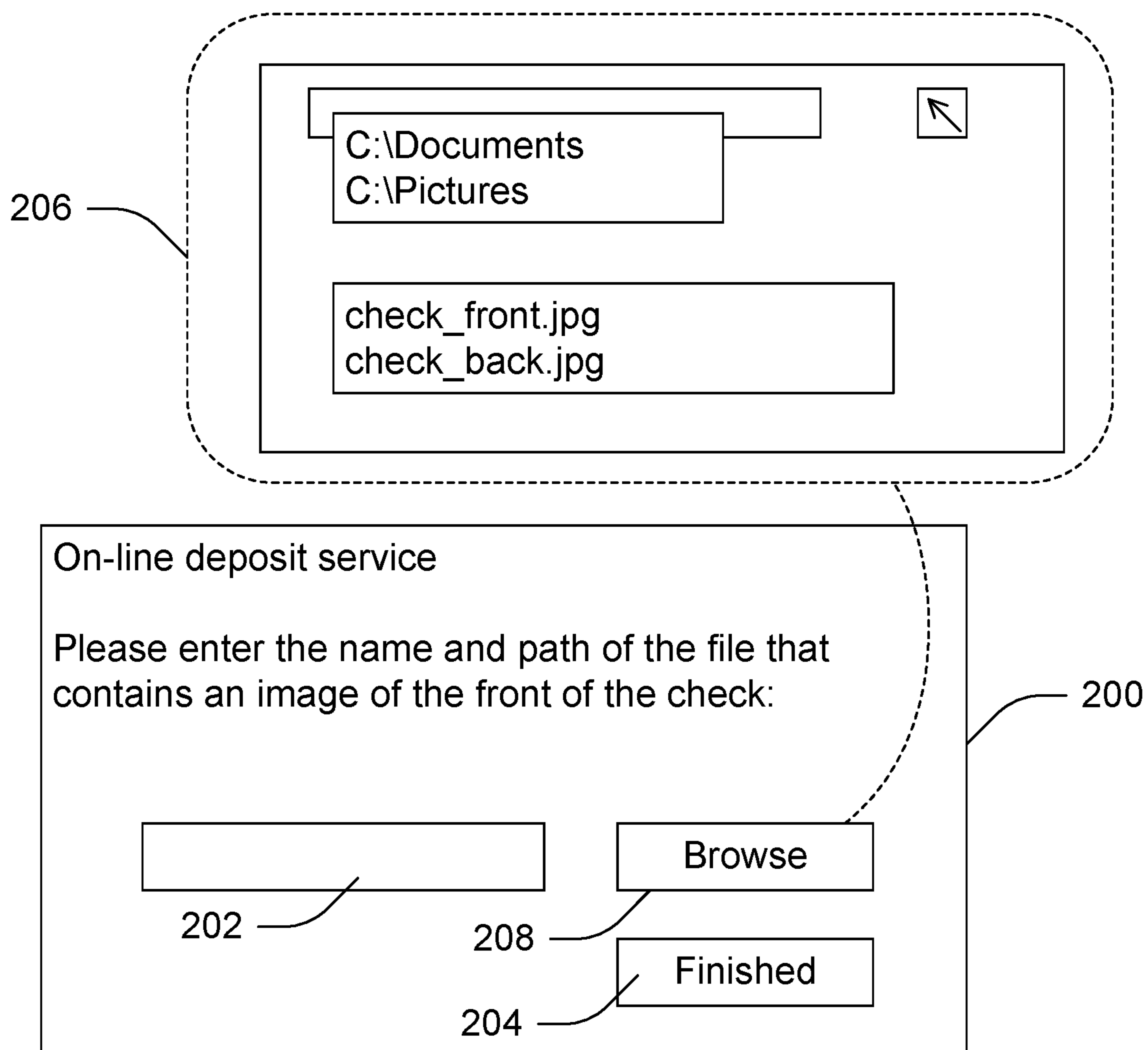

FIG. 2

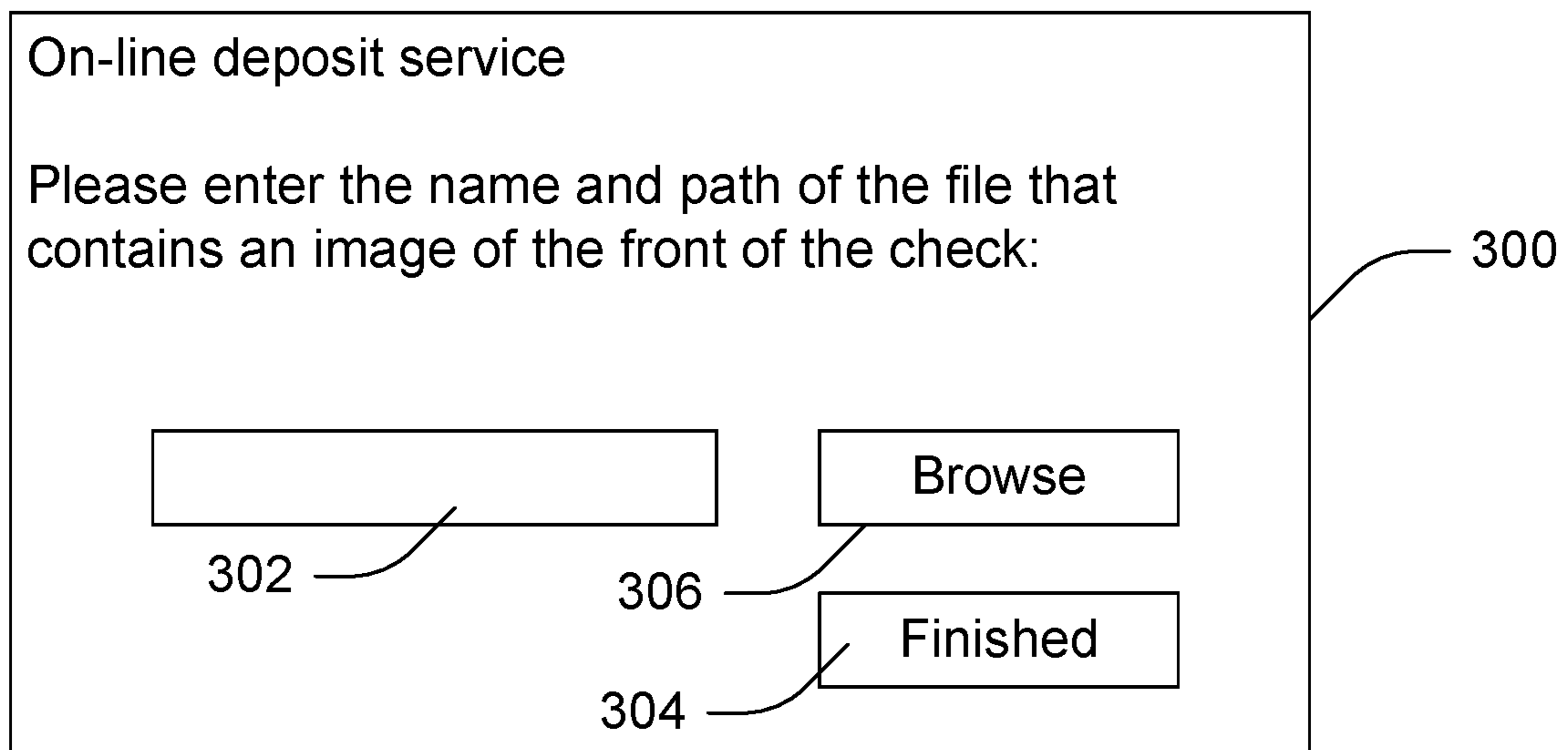

FIG. 3

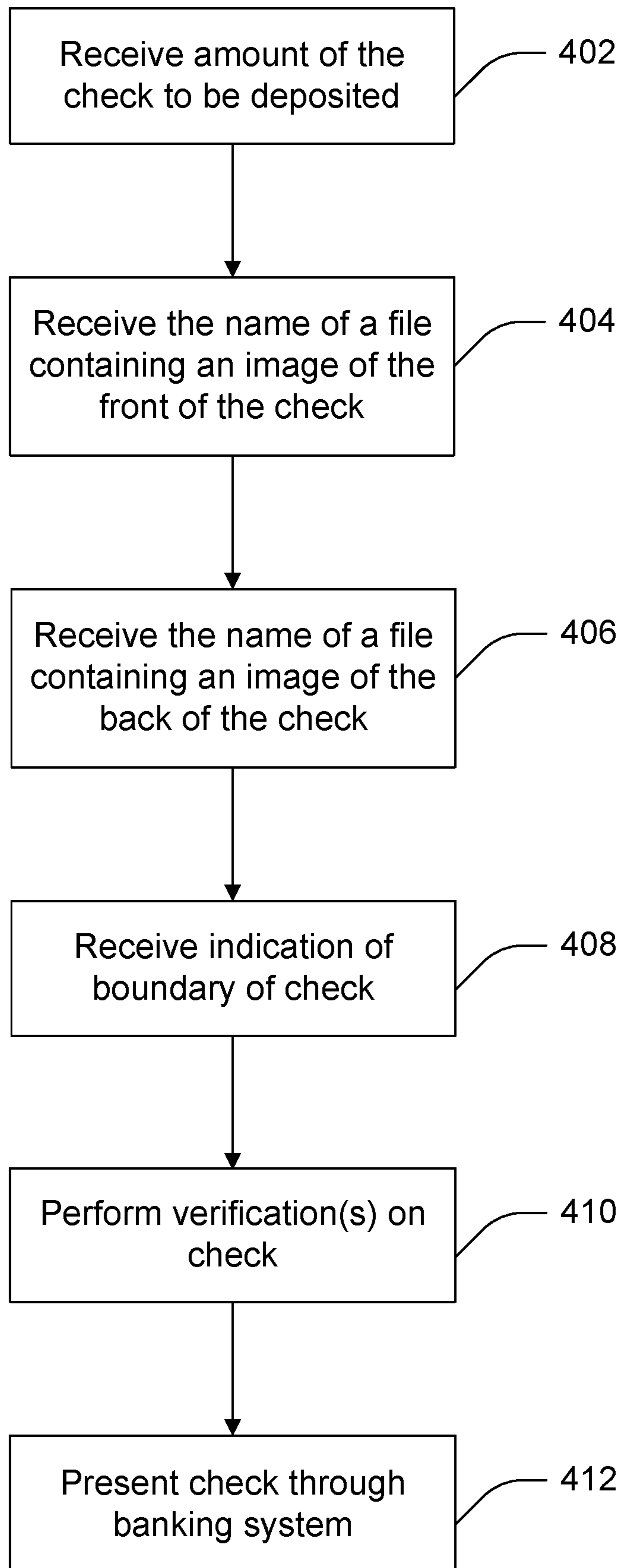

FIG. 4

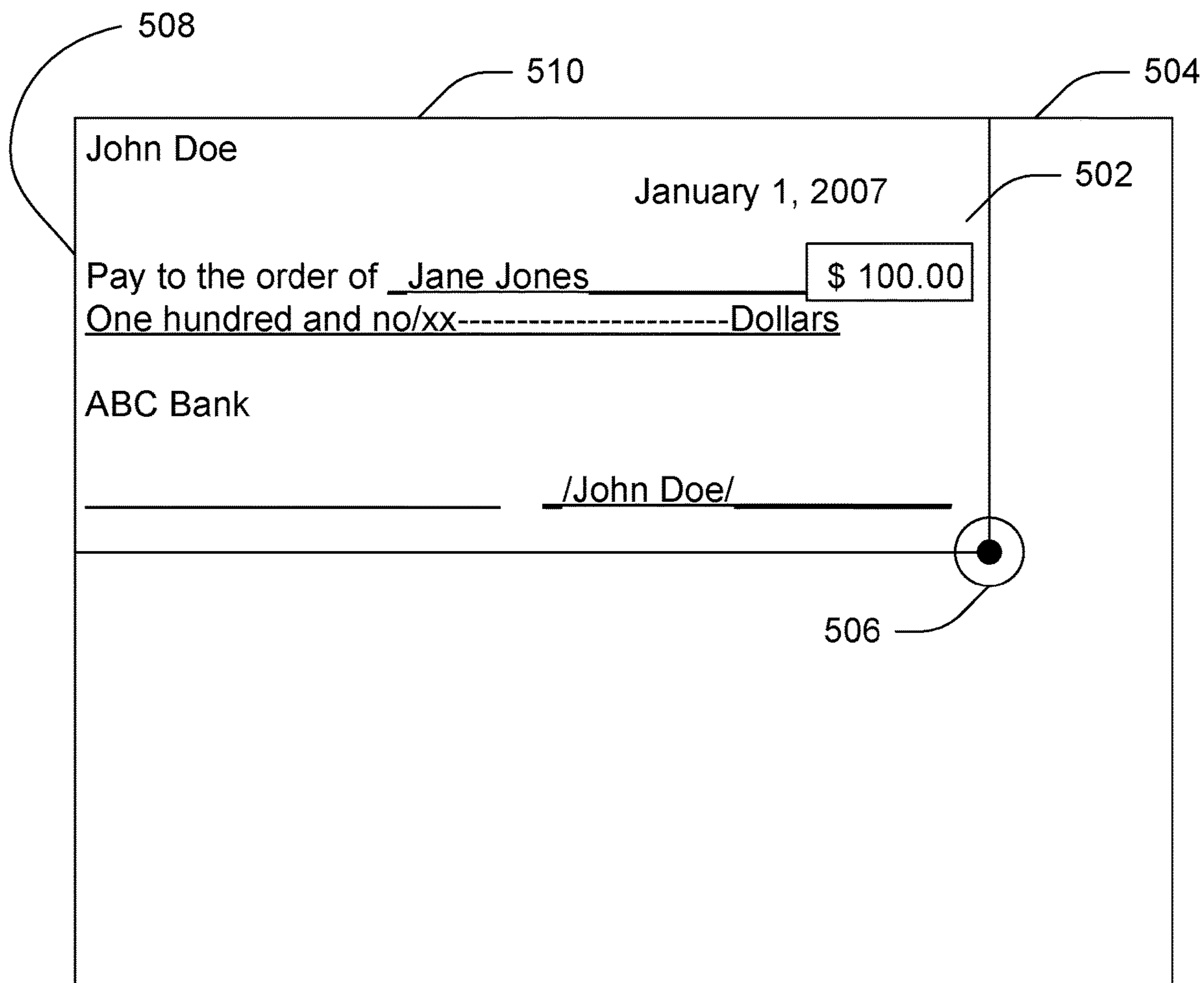

FIG. 5

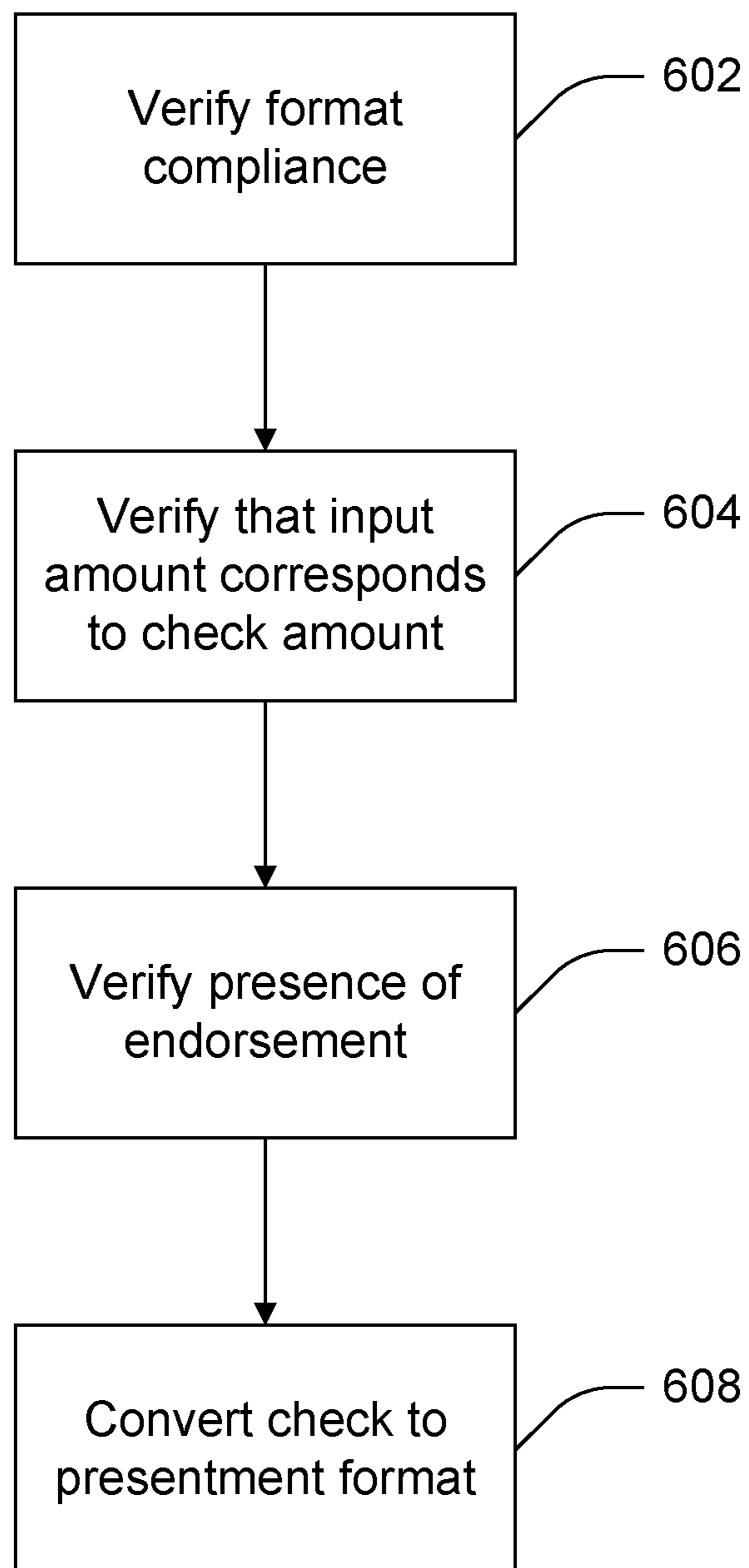

FIG. 6

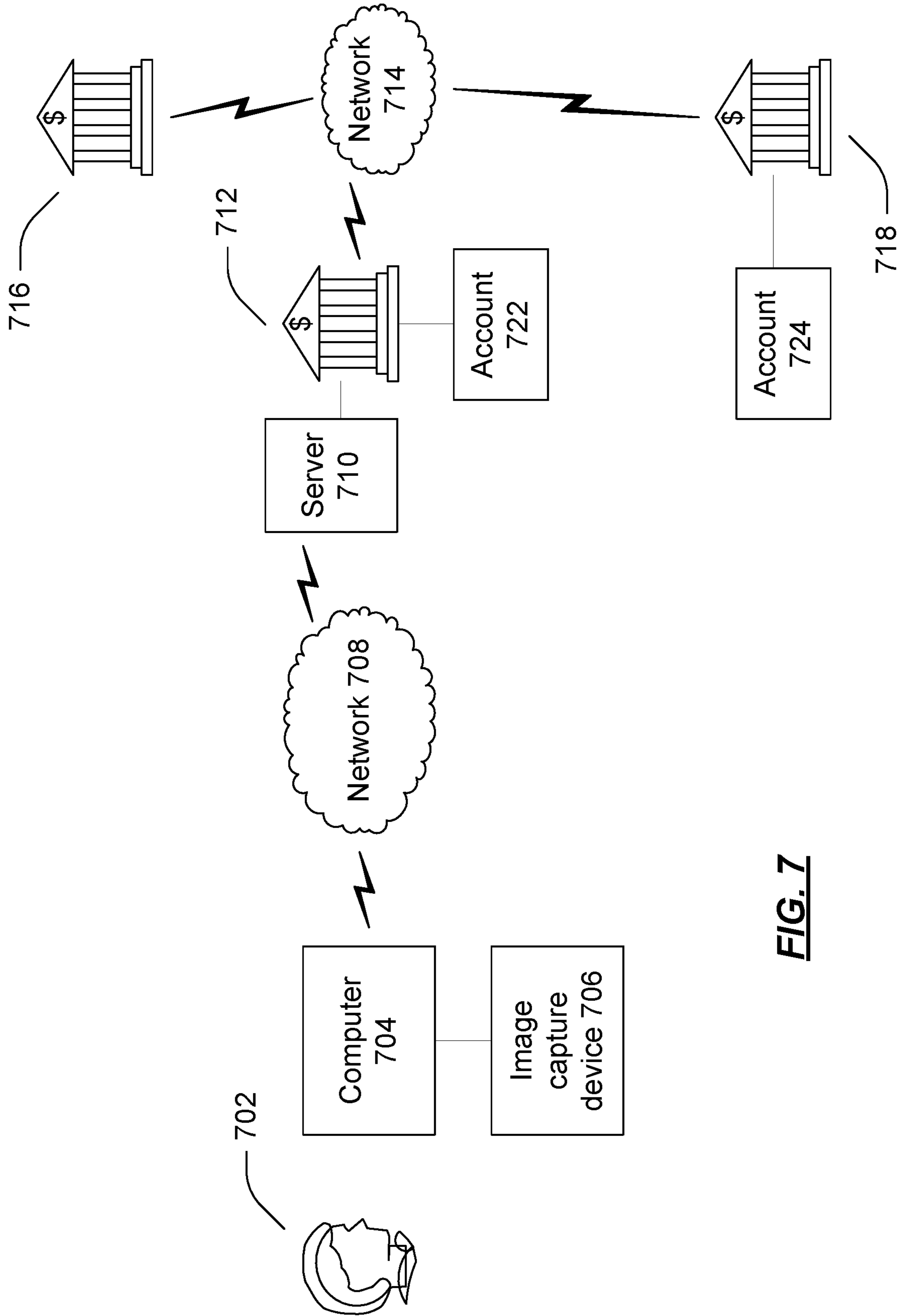

FIG. 7

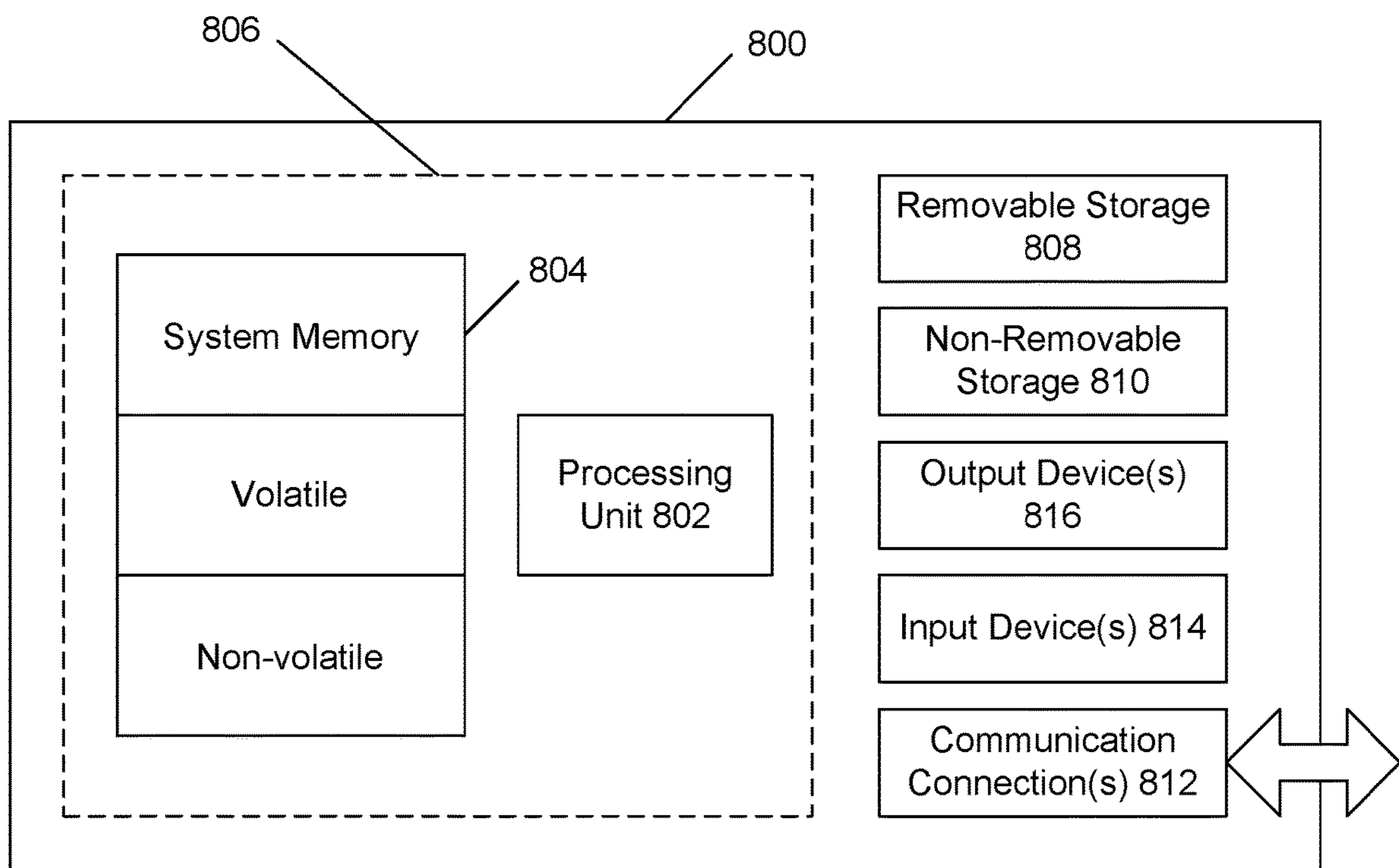

FIG. 8

IMAGE PROCESSING**CROSS-REFERENCE TO RELATED APPLICATIONS**

This application is a continuation of U.S. application Ser. No. 16/502,489, filed Jul. 3, 2019, pending, which is a continuation of U.S. application Ser. No. 14/879,868 (now U.S. Pat. No. 10,373,136), filed Oct. 9, 2015 pending, which is a continuation of U.S. application Ser. No. 13/327,478 (now U.S. Pat. No. 9,159,101), filed Dec. 15, 2011, which is a continuation of U.S. application Ser. No. 13/301,433, filed Nov. 21, 2011, abandoned, which is a continuation of U.S. application Ser. No. 11/877,307, filed Oct. 23, 2007, abandoned, each of which are hereby incorporated by reference herein in their entirety. This application is related by subject matter to the following commonly assigned applications, the entirety of which are hereby incorporated by reference herein: U.S. patent application Ser. No. 11/877,335, U.S. patent application Ser. No. 11/877,367, U.S. patent application Ser. No. 11/877,382, and U.S. patent application Ser. No. 11/877,404, each filed on Oct. 23, 2007, and each entitled "Systems And Methods For Obtaining An Image Of A Check To Be Deposited".

BACKGROUND

A check is a negotiable instrument. Formally, a check is an order that a "drawer" (the party who writes the check, and from whose bank account the money is to be drawn) issues to a "drawee bank" (the bank at which the drawer's money is located), and the order instructs the drawee bank to pay a "payee" (the party to whom the check is written). A check is negotiated by the payee's presenting the check to the drawee bank. The presentment process is normally initiated by the payee's bank, which presents the check to the drawee bank when the payee deposits the check with his or her bank.

Presentment of a check is normally done through the Federal Reserve or a commercial banking system. Traditionally, the mechanism by which this presentment occurs is by tendering the paper check through the banking system. The paper check is physically transmitted to the drawee bank, which either accepts and pays the paper check upon receipt, or declines payment and returns the paper check. Technological and legal developments, such as procedures set forth in the Check-21 law, allow images of checks (sometimes referred to as "substitute checks") to be presented electronically without presentment of a paper copy. Thus, starting the presentment process may involve collecting an image of the check rather than obtaining the original paper check. Check scanners have traditionally been available to read the Magnetic Ink Character Recognition (MICR) line at the bottom of the check, and this information can be used for presentment. However, it is possible to present an ordinary image of a check, where the image is collected with ordinary image scanning equipment.

A customer can take the paper check to a bank for deposit and have the bank scan the check to obtain an image. However, it is also possible to collect the image of the check from the customer who is depositing the check.

SUMMARY

An image of a check to be presented for payment can be collected from a banking customer using the customer's scanning equipment. The customer can scan the check into one or more files (e.g., one file for the front, a second file for

the back). The files can then be uploaded to a server operated by the customer's bank, and the images contained in the files can be presented through the banking system for payment by the drawee bank.

The customer's bank may operate software, such as software provided on a web site, that guides the customer through the process of obtaining the check images. For example, the customer may visit the bank's web site, and the web site may instruct the customer to obtain images of both sides of the check, may instruct the customer how to position the check in the scanner, may instruct the customer as to what image format and/or resolution to use, etc. The web site may also guide the user through the process of delimiting the boundary of the check, such as by identifying a corner of the check. The bank's software can also perform certain verifications on the check, such as verifying the check against legibility and/or size standards, verifying that there is an endorsement on the back of the check, verifying that the amount of money written on the check matches the amount that the customer has indicated in a deposit request, etc.

This summary is provided to introduce a selection of concepts in a simplified form that are further described in the detailed description. This summary is not intended to identify key features or essential features of the claimed subject matter, nor is it intended to be used to limit the scope of the claimed subject matter.

BRIEF DESCRIPTION OF THE DRAWINGS

FIG. 1 is a diagram of a user interface that requests that a depositor enter an amount of a deposit.

FIG. 2 is a diagram of a user interface that requests that a depositor provide an image of a first side of a check.

FIG. 3 is a diagram of a user interface that requests that a depositor provide an image of a second side of a check.

FIG. 4 is a flow diagram of an example process whereby an image of a check is received and presented for payment.

FIG. 5 is a diagram of an example user interface in which a user marks a boundary of a check.

FIG. 6 is a flow diagram of various stages that can be performed after an image of a check is received by a bank from a depositor.

FIG. 7 is a block diagram of an example environment in which checks may be deposited and presented.

FIG. 8 is a block diagram of an example computing environment in which example embodiments and aspects may be implemented.

DETAILED DESCRIPTION

A web site can guide a user through the process of collecting images of a check to be deposited. In some cases, the web site can provide software, such as a browser-executable applet, that drives the process of collecting images by operating the customer's scanner. For example, after the customer enters an amount of a check to be deposited, the software provided on the web site can instruct the user to place the check in the scanner bed and to click a button when ready. The software can then cause the scanner to be started, can collect the image in an appropriate format and resolution, and can then upload the image for deposit. The software can repeat the process for both sides of the check, in order to obtain images of the front and the back.

Having the web site drive the image-collection process may be simple for the customer (e.g., the bank depositor who uses the web site), since the customer may not have to address issues such as what to name the file, what format or

resolution to use. Having the web site drive the process also may avoid, for the customer, the process of identifying particular files to be uploaded. However, certain permissions may be used in order to allow the web site's software to operate the scanner. Scanners are normally operated by a device driver, such as a TWAIN driver. For security reasons, the driver may require certain certificates to be used before allowing a program to operate the scanner that the driver controls. Since users often transparently download programs to run in their web browsers without realizing that they are downloading programs, programs such as applets, scripts, etc., that run in web browsers often present a particular security risk, and a driver may require such a program to obtain a certificate before it allows the program to control the scanner. Each scanner (or the scanners within a brand-mate family), may have its own driver. The drivers may be different for different operating environments—e.g., the same scanner may use a different driver depending on whether it is being operated from an environment based on one of the WINDOWS operating systems, an environment based on one of the operating systems used in APPLE computers, an environment based on a version of the LINUX operating system, etc. Each driver may use different certificates. Moreover, the different environments may use various different environment-specific technologies to allow the scanner to be controlled from a remote web server. Since the bank that operates the web site does not know what scanning equipment or operating environment its customer will be using, it may need to obtain a large number of certificates, and may need to interface with a large number of different technologies, to support a large number of scanner-environment combinations, in order to allow its software to control scanners for a variety of customers.

At present, most consumers use computers whose environment is based on one of the WINDOWS operating systems. Thus, it may make sense from a cost-benefit perspective, for a bank to obtain the certificates to operate a wide variety of scanners in environments based on the WINDOWS operating systems, and to support the technology that allows the scanner to be controlled within that environment. However, it may not make sense from a cost-benefit perspective for the bank to obtain the certificates to operate lesser-used scanners, or scanners in environments other than those based on the WINDOWS operating systems. Thus, an alternative mechanism for obtaining an image of the check may be used. One example of such a mechanism is to have the customer scan an image of the check (or separate images of the front and back of the check) into a file, and then upload the file(s) to the bank's server for presentation through a banking system.

Turning to the drawings, FIGS. 1, 2, and 3 show examples of user interfaces that could be presented to a user in order to obtain a deposit amount and the appropriate check images. These user interfaces could be presented through a web site—e.g., by delivering to a depositor's computer or other machine, web pages that cause these user interfaces to be displayed on the depositor's browser. However, these user interfaces could be presented using any mechanism.

In FIGS. 1-3, the depositor is asked to enter an amount of a check to be deposited, and is then asked to provide scanned images of the front and back of the check. Thus, in FIG. 1, user interface 100, the depositor is requested to enter the amount of a check to be deposited into box 102. This amount can be entered in the form of text. When the depositor has entered the amount of the check to be deposited, the depositor may click button 104, indicating that he or she is "finished." FIG. 1 shows an example in which the depositor

is requested to enter an amount of a single check to be deposited. However, the depositor could also be given a set of boxes to enter an arbitrary number of checks, or could be asked to enter an aggregate amount of a deposit covering several checks, or could be asked for an amount of a deposit in any other way.

FIG. 2 shows user interface 200, which requests that the depositor enter a name of a file containing an image of the front of the check to be deposited. The name, and optionally the path, of the file can be entered into box 202. When the depositor has entered the name of the file, he or she can click button 204 to indicate that he or she is "finished" entering the name. The name can be entered either by the depositor typing the name as text into box 202. Or, as another example, the depositor can be presented with a file navigation user interface 206. The depositor may click button 208 ("browse") to access file navigation user interface 206. File navigation user interface 206 may show the depositor's local and/or network folder structure, and allow the depositor to navigate through folders and files to obtain the name of the file containing the image. When the depositor has selected the name of the file, the name (or name and path) of the file may appear in box 202 as if the depositor had typed the name (or name and path). User interface 200 could also include information and/or instructions for the depositor about the rules that govern the nature of the image to be provided—e.g., text could be displayed or communicated in user interface 200 that advises the depositor as to the format of the image to be provided (e.g., JPEG), the resolution of the image (e.g., 200 dpi), other parameters (e.g., turning on grayscale for the scan), etc. As another example, the depositor could be shown examples of "good" and "bad" scans—e.g., an image could be shown to the depositor indicating an example of scan that would be accepted, and another image could be shown to the depositor indicating an example of a scan that would not be accepted. A scan that would not be accepted might be shown as being smudged, or crooked, or obscured in some manner. There are a variety of reasons for which a scan might not be accepted, and examples demonstrating any one or more of these reasons could be shown to the depositor.

FIG. 3 shows user interface 300, which is similar to user interface 200 but asks the depositor to enter the name of a file containing an image of the back of the check instead of the front. Like user interface 200, user interface 300 may have a box 302 into which the depositor can enter the name of the file containing the appropriate image, a button 304 that the depositor can click when he or she is finished entering the file name, a browse button 306 that the depositor can use to access a file navigation user interface similar to that shown in FIG. 2 and previously discussed. Additionally user interface 300 may inform and/or instruct the depositor as to issues concerning format, resolution, other parameters, etc.

FIG. 4 is a flow diagram of an example process whereby an image of a check is received and presented for payment. It is noted that the process of FIG. 4, as well as the process discussed subsequently in connection with FIG. 5, are both described, by way of example, with reference to a web server that interacts with a depositor by communicating through a network with a browser running on the depositor's machine. However, these processes may be carried out in any system, and are not limited to the scenarios described. Moreover, these flow diagrams show examples in which stages of a process are carried out in a particular order, as indicated by the lines connecting the blocks, but the various

5

stages shown in these diagrams can be performed in any order, or in any combination or sub-combination.

At **402**, an amount of a check to be deposited is received. For example, a user interface (such as user interface **100**, shown in FIG. **1**) may be used to ask a depositor for the amount of a check to be deposited. As previously noted, the depositor may be given the opportunity to enter an amount of a single check, a list of amounts for plural checks, an aggregate total amount of plural checks, etc. At least one such amount is received at **402**.

At **404**, a name of a file that contains an image of the front side of the check is received. For example, a user interface (such as user interface **200**, shown in FIG. **2**) may be used to obtain the name (or name and path) of a file that contains an image of the check. The user may have already scanned the check and placed the image in a file, or the user can be instructed to scan the check (or a side of the check) at the time that the file name is to be received. The file whose name is entered may be uploaded to a server, such as a web server operated by the bank with which the check is to be deposited.

At **406**, a name of a file that contains an image of the back side of the check is received. For example, a user interface (such as user interface **300**, shown in FIG. **3**) may be used to obtain the name (or name and path) of a file that contains an image of the check. As with **404**, the user may already have scanned the check into an image file, or can be instructed to do so. The file whose name is entered may be uploaded to a server, such as a web server operated by the bank with which the check is to be deposited.

At **408**, the boundaries the check are received. For example, the user may be asked to draw a boundary on the image to indicate which part of the image is the check, and which part is merely background due to the fact that amount of area scanned is generally larger than a check. One way to obtain an indication of the location of this boundary is to ask the user to scan the check by placing the top and left edges of the check directly abutting the top and left sides of the scanner bed. Thus, the top and left edges of the boundary of the check are defined by the edges of the scanning sight. Presuming that the check is a rectangle, the bottom and right edges that define the remaining portion of the boundary can be indicated by a single point in the bottom, right corner of the check. An example of this technique is shown in FIG. **5**.

FIG. **5** shows a check **502**, which has been scanned. Sight **504** indicates the area that has been scanned, and it can be seen that left edge **508** and top edge **510** of check **502** abut the left and top edges of the scan sight. By placing a marker (such as dot **506**) in the right, bottom corner of the check, the rectangular boundary of the check is defined. Thus, it can be determined from the position of the marker which portion of sight **504** contains an image of a side of check **502**, and which portion contains background. The portion that contains the image can later be used to present the check for payment through a banking system. It is noted that the marker can be positioned through various mechanisms. For example, a web server that implements the process of collecting a deposit request and check images from a depositor can download software (e.g., a plug-in, an applet, a script, etc.) that executes in the depositor's browser and allows the depositor to position a marker such as dot **506** with a pointing device, such as a mouse, trackpad, etc. This program could be used to place the marker on the image before the image is uploaded to the bank's server. As another example, the bank's server could receive the image, and then send a copy or modified version of the image back to the depositor's web browser to be operated on the program. For

6

example, after the upload of the image, the bank's web server could cause a new window to be opened with a page containing the image, and a script, applet, plug-in, etc., that allows the depositor to place the marker. Any mechanism to allow the depositor to place the marker could be used.

Returning to FIG. **4**, certain types of verifications may be performed (at **410**) on the check images that have been received. For example, the images could be verified to determine they are in an acceptable format, at an acceptable resolution, or that the amount of the check shown on the front of the check matches the amount stated by the depositor, or that the back of the check contains an endorsement, or that the check complies with size standards (or other standards) according to applicable law such as the Check-21 law. In one example, the system may check that the images are in the JPEG format, or that the images are at least 200 dpi in resolution, or that the capture of the image preserves grayscale. Resolution and/or grayscale can be addressed as part of the process of verifying that the image is in an acceptable format, or compliance with resolution and grayscale parameters could be checked separately. A comparison of the amount of the check as stated by the depositor with the amount written on the check can be performed by using optical character recognition (OCR) on the check to determine the amount that it states. Or, as another example, the check could be examined by a human and compared with the amount entered by the depositor. Similarly, the presence of an endorsement on the image of the back of the check could be detected using OCR (or some other type of image processing), or could be evaluated by a human.

At **412**, the images of the front and back of the check are presented for payment through a banking system. For example, a banking system such as the Federal Reserve or a commercial banking system may operate a server to which these images can be provided, and the images can be presented to the drawee bank through such system. An example of a banking system is shown in FIG. **7**, and is discussed subsequently.

FIG. **6** shows an example of various stages that can be performed after an image of a check is received by a bank from a depositor. For example, when images of a check are from a depositor by the bank's web server, certain processing can be performed on the image to prepare the check for presentment through a banking system. FIG. **6** shows examples of stages of such processing. It should be noted that **602**, **604**, and **606**, as shown in FIG. **6**, provide additional detail of features that are discussed previously in connection with **410** in FIG. **4**.

At **602**, the files containing the image may be evaluated to determine whether they are in an appropriate format. For example, features of the images, such as file format (e.g., JPEG, GIF, TIF, etc.) may be evaluated. In one example, the depositor may be instructed to upload the images in JPEG format, and an image may be rejected if the evaluation at **602** determines that the image is in a different format. Additional features that may be evaluated include resolution of the image, the presence of grayscale, compliance with legal standards such as Check-21, etc.

At **604**, a verification may be performed to determine that the amount of money written on the check corresponds to the amount of the check reported by the depositor. For example, the image of the front of the check can be evaluated by an OCR process, read by a human, etc., and this amount can be compared to the amount of the deposit as entered by the depositor.

At **606**, the image of the back of the check may be evaluated to determine the presence of an endorsement. For

example, an OCR process, or other type of image processing, may be performed to determine whether the image contains an endorsement. Or the image can be given to a human to evaluate for the presence of an endorsement.

At 608, the images of the check may be converted to an appropriate format for presentment through a banking system. For example, the banking system may impose certain standards such as file format, headers, metadata, etc. The images may be modified and/or packaged to comply with these standards prior to presentment of the check images through a banking system.

FIG. 7 shows an example environment in which checks may be deposited and presented. Depositor 702 may be a customer of financial institution 712. Financial institution 712 may, for example, be a bank, but could also be any other type of financial institution, such as an investment company, an insurance company, etc. Depositor may operate a computer 704, which may be located at depositor 702's residence, but could also be located in any other place. Computer 704 may be connected to image capture device 706, which may be a scanner, camera, etc. Computer 704 may be connected to other machines through network 708. The Internet is an example of network 708, although computer 704 could be connected to other machines through any network.

One example of a machine that computer 704 could be connected to through network 708 is server 710, which, in this example, is a server operated by depositor 702's financial institution 712. Server 710 may operate software that implements a web site, and depositor 702 may use that web site to interact with financial institution 712, for example by tendering checks for deposit into an account with financial institution 712 through the web site. As previously discussed, one way that a depositor could tender a check for deposit is to provide scanned images of the check and to upload the images to a web site associated with a bank. If depositor 702 uses image capture device 706 to scan images of a check, and then uses a browser running on computer 704 to upload such images to server 710 through network 708, then this scenario would be one example of the subject matter described herein. However, the subject matter described herein encompasses other scenarios.

Financial institutions 716 and 718 are financial institutions such as banks, investment companies, insurance companies, etc. They may also include a clearinghouse or a national central bank (such as the Federal Reserve or a branch thereof). Financial institutions 712, 716, and 718 may communicate with each other via a network 714. Network 714 may be a publicly-accessible network, such as the Internet, but also may be a private network. For example, financial institutions 712, 716, and 718 may have security issues when they communicate with each other that do not apply to ordinary communications, and thus network 714 may provide security features that network 708 does not. However, network 714 could be any type of network.

Account 722, in the example of FIG. 7 is an account that depositor 702 maintains at financial institution 712. Depositor 702 may be in possession of a check that is drawn against account 724 maintained at financial institution 718 (in which case financial institution 718 is the drawee). Depositor 702 may deposit the check into account 722 by delivering the check to financial institution 712, where such delivery may be in the form of physical delivery of the original paper check, sending an image of the check, etc. Upon receipt of the check (whether in paper form, image form, or otherwise), financial institution 712 may clear the check by presenting the check through a banking system, such as

banking system 720. Presentment of the check may be made directly to drawee financial institution 718, or could be made to an intermediary financial institution, such as a branch of the Federal Reserve, a correspondent bank, a clearinghouse, etc. The intermediary bank can be a government actor (as in the case of the Federal Reserve in the United States, or the central bank of another country), or it could be a commercial actor, such as a correspondent bank or clearinghouse.

In one example, the check is cleared by presenting the check to financial institution 716, which may, for example, be a regional branch of the Federal Reserve, along with a request for payment. Financial institutions 712 and 718 may each have accounts at financial institution 716. Financial institution 712 may create a substitute check using an image provided by depositor 702, and may present the substitute check to financial institution 716. Upon receiving the substitute check, financial institution 716 may identify financial institution 718 as the drawee bank—e.g., by using the nine-digit routing number that is normally printed on checks in the United States. Financial institution 716 may then present the substitute check to financial institution 718 and request that the check be paid. If financial institution 718 agrees to honor the check, then financial institution 716 may then settle the check by debiting funds from an account of financial institution 718 and crediting funds to an account of financial institution 712.

It will be appreciated that the preceding examples are for illustration, and not limitation. For example, financial institution 718 may have a relationship with financial institution 712, and financial institution 712 may use this relationship to clear the check directly with financial institution 718, while bypassing the Federal Reserve, other national central bank, or clearinghouse. In addition, accounts 722 and 724 could be held at the same financial institution 712, in which case the check may be cleared internally.

The subject matter described herein may be implemented through the use of a computer system, or other type of device that has some computing mechanism(s). FIG. 8 shows an example computing environment in which example embodiments and aspects may be implemented. The computing system environment is only one example of a suitable computing environment and is not intended to suggest any limitation as to the scope of use or functionality.

Numerous other general purpose or special purpose computing system environments or configurations may be used. Examples of well known computing systems, environments, and/or configurations that may be suitable for use include, but are not limited to, personal computers (PCs), server computers, handheld or laptop devices, multiprocessor systems, microprocessor-based systems, network PCs, minicomputers, mainframe computers, embedded systems, distributed computing environments that include any of the previously-described systems or devices, and the like.

Computer-executable instructions, such as program modules, being executed by a computer may be used. Generally, program modules include routines, programs, objects, components, data structures, etc., that perform particular tasks or implement particular abstract data types. Distributed computing environments may be used where tasks are performed by remote processing devices that are linked through a communications network or other data transmission medium. In a distributed computing environment, program modules and other data may be located in both local and remote computer storage media including memory storage devices.

With reference to FIG. 8, an example system for implementing aspects described herein includes a computing

device, such as computing device **800**. In its most basic configuration, computing device **800** typically includes at least one processing unit **802** and memory **804**. Depending on the exact configuration and type of computing device, memory **804** may be volatile (such as random access memory (RAM)), non-volatile (such as read-only memory (ROM), flash memory, etc.), or some combination of the two. This most basic configuration is illustrated in FIG. **8** by dashed line **806**.

Computing device **800** may have additional features/functionality. For example, computing device **800** may include additional storage (removable and/or non-removable) including, but not limited to, magnetic or optical disks or tape. Such additional storage is illustrated in FIG. **8** by removable storage **808** and non-removable storage **810**.

Computing device **800** typically includes a variety of computer readable media. Computer readable media can be any available media that can be accessed by computing device **800** and includes both volatile and non-volatile media, removable and non-removable media. By way of example, and not limitation, computer readable media may comprise computer storage media and communication media.

Computer storage media includes volatile and non-volatile, removable and non-removable media implemented in any method or technology for storage of information such as computer readable instructions, data structures, program modules or other data. Memory **804**, removable storage **808**, and non-removable storage **810** are all examples of computer storage media. Computer storage media includes, but is not limited to, RAM, ROM, electrically erasable programmable read-only memory (EEPROM), flash memory or other memory technology, CD-ROM, digital versatile disks (DVD) or other optical storage, magnetic cassettes, magnetic tape, magnetic disk storage or other magnetic storage devices, or any other medium which can be used to store the desired information and which can be accessed by computing device **800**. Any such computer storage media may be part of computing device **800**.

Computing device **800** may also contain communications connection(s) **812** that allow the device to communicate with other devices. Communications connection(s) **812** is an example of communication media. Communication media typically embodies computer readable instructions, data structures, program modules or other data in a modulated data signal such as a carrier wave or other transport mechanism and includes any information delivery media. The term "modulated data signal" means a signal that has one or more of its characteristics set or changed in such a manner as to encode information in the signal. By way of example, and not limitation, communication media includes wired media such as a wired network or direct-wired connection, and wireless media such as acoustic, radio frequency (RF), infrared and other wireless media. The term computer readable media as used herein includes both storage media and communication media.

Computing device **800** may also have input device(s) **814** such as keyboard, mouse, pen, voice input device, touch input device, etc. Output device(s) **816** such as a display, speakers, printer, etc. may also be included. All these devices are well known in the art and need not be discussed at length here.

It should be understood that the various techniques described herein may be implemented in connection with hardware or software or, where appropriate, with a combination of both. Thus, the methods and apparatus of the presently disclosed subject matter, or certain aspects or

portions thereof, may take the form of program code (i.e., instructions) embodied in tangible media, such as floppy diskettes, CD-ROMs, hard drives, or any other machine-readable storage medium wherein, when the program code is loaded into and executed by a machine, such as a computer, the machine becomes an apparatus for practicing the presently disclosed subject matter. In the case of program code execution on programmable computers, the computing device generally includes a processor, a storage medium readable by the processor (including volatile and non-volatile memory and/or storage elements), at least one input device, and at least one output device. One or more programs may implement or utilize the processes described in connection with the presently disclosed subject matter, e.g., through the use of an API, reusable controls, or the like. Such programs are preferably implemented in a high level procedural or object oriented programming language to communicate with a computer system. However, the program(s) can be implemented in assembly or machine language, if desired. In any case, the language may be a compiled or interpreted language, and combined with hardware implementations.

Although example embodiments may refer to utilizing aspects of the presently disclosed subject matter in the context of one or more stand-alone computer systems, the subject matter is not so limited, but rather may be implemented in connection with any computing environment, such as a network or distributed computing environment. Still further, aspects of the presently disclosed subject matter may be implemented in or across a plurality of processing chips or devices, and storage may similarly be effected across a plurality of devices. Such devices might include personal computers, network servers, and handheld devices, for example.

Although the subject matter has been described in language specific to structural features and/or methodological acts, it is to be understood that the subject matter defined in the appended claims is not necessarily limited to the specific features or acts described previously. Rather, the specific features and acts described previously are disclosed as example forms of implementing the claims.

The invention claimed is:

1. An image processing system comprising:

a memory;

a processor in communication with the memory, and configured to:

transmit instructions to a depositor computing device that cause the depositor computing device to process an image containing a check displayed on the depositor computing device, the instructions comprising instructions to manually input at the depositor computing device an indication of a boundary of the check in the image displayed on the depositor computing device;

receive, via a network from the depositor computing device, a file comprising the image containing the check;

receive, via the network from the depositor computing device, the indication of the boundary of the check based on the manually input indication; and determine which portion of the image containing the check is background and which portion is a side of the check based on the received indication.

2. The system of claim 1, wherein:

the processor is further configured to receive a first image of a first side of the check and a second image of a second side of the check; and

11

the indication received from the depositor computing device comprises a first indication of where, in the first image, a first boundary of the first side of the check is located and a second indication of where, in the second image, a second boundary of the second side of said check is located.

3. The system of claim 2, wherein:

the first indication identifies a first corner the check in the first image; and

the second indication identifies a second corner the check in the second image.

4. The system of claim 1, wherein the indication comprises where, in the image, a corner of the check is located.

5. The system of claim 1, wherein the indication indicates which part of the image comprises the check and which part comprises background.

6. The system of claim 1, wherein the indication is generated by manual input of a pointing device of the depositor computing device.

7. The system of claim 6, wherein the processor is further configured to:

communicate with a network browser running on the depositor computing device; and

download software to the depositor computing device, the software configured for execution via the network browser of the depositor computing device to configure the depositor computing device to process the manual input related to the check received from the pointing device.

8. The system of claim 7, wherein the processor, in response to receiving the file comprising the image of the check, is further configured to:

send, via the network to the depositor computing device, a system image of the check for display using the depositor computing device in order for a depositor at the depositor computing device to input the manual input on the displayed system image, the system image being based on the image of the check.

9. The system of claim 8, wherein the system image comprises a copy of the image of the check.

10. The system of claim 8, wherein the system image comprises a modification of the image of the check.

11. The system of claim 8, wherein the sending of the system image to the depositor computing device causes the depositor computing device to display the system image in a new window for input of the manual input on the displayed system image.

12. The system of claim 1, wherein the processor is configured to receive a first image of a first side of the check and a second image of a second side of the check; and

wherein the indication received from the depositor computing device comprises a first indication of where, in the first image, a first edge of the first side of the check is located and a second indication of where, in the second image, a second edge of the second side of said check is located.

13. The system of claim 12, wherein:

the first indication is indicative of a first corner the check in the first image; and

the second indication is indicative of a second corner the check in the second image.

14. A method comprising:

transmitting instructions, with a processor, to a depositor computing device that cause the depositor computing device to process an image containing a check displayed on the depositor computing device, the instructions comprising instructions to manually input at the

12

depositor computing device an indication of a boundary of the check in the image displayed on the depositor computing device;

receiving, with the processor, via a network from the depositor computing device, a file comprising the image containing the check;

receiving, with the processor, via the network from the depositor computing device, the indication of the boundary of the check based on the manually input indication; and

determining, with the processor, which portion of the image containing the check is background and which portion is a side of the check based on the received indication.

15. The method of claim 14, further comprising:

receiving, with the processor, a first image of a first side of the check and a second image of a second side of the check;

wherein the indication received from the depositor computing device comprises a first indication of where, in the first image, a first boundary of the first side of the check is located and a second indication of where, in the second image, a second boundary of the second side of said check is located.

16. The method of claim 15, wherein:

the first indication identifies a first corner the check in the first image; and

the second indication identifies a second corner the check in the second image.

17. The method of claim 14, wherein the indication comprises where, in the image, a corner of the check is located.

18. The method of claim 14, wherein the indication indicates which part of the image comprises the check and which part comprises background.

19. The method of claim 14, wherein the indication is generated by manual input of a pointing device of the depositor computing device.

20. The method of claim 19, further comprising:

communicating with a network browser running on the depositor computing device with the processor; and download software to the depositor computing device, with the processor, the software configured for execution via the network browser of the depositor computing device to configure the depositor computing device to process the manual input related to the check received from the pointing device.

21. The system of claim 20, wherein the processor, in response to receiving the file comprising the image of the check, is further configured to:

send, via the network to the depositor computing device, a system image of the check for display using the depositor computing device in order for a depositor at the depositor computing device to input the manual input on the displayed system image, the system image being based on the image of the check.

22. The system of claim 21, wherein the system image comprises a copy of the image of the check.

23. The system of claim 21, wherein the system image comprises a modification of the image of the check.

24. The system of claim 21, wherein the sending of the system image to the depositor computing device causes the depositor computing device to display the system image in a new window for input of the manual input on the displayed system image.

25. The system of claim 14, wherein the processor is configured to receive a first image of a first side of the check and a second image of a second side of the check; and

wherein the indication received from the depositor computing device comprises a first indication of where, in the first image, a first edge of the first side of the check is located and a second indication of where, in the second image, a second edge of the second side of said check is located.

26. The system of claim 25, wherein:

the first indication is indicative of a first corner the check in the first image; and
the second indication is indicative of a second corner the check in the second image.

* * * * *

5
10
15