



US011251884B2

(12) **United States Patent**
Chisu et al.

(10) **Patent No.:** **US 11,251,884 B2**
(45) **Date of Patent:** **Feb. 15, 2022**

(54) **PROCESS BASED ANTENNA CONFIGURATION**

(71) Applicant: **Motorola Mobility LLC**, Chicago, IL (US)

(72) Inventors: **Daniel C. Chisu**, Franklin Park, IL (US); **Si Chen**, Chicago, IL (US)

(73) Assignee: **Motorola Mobility LLC**, Chicago, IL (US)

(*) Notice: Subject to any disclaimer, the term of this patent is extended or adjusted under 35 U.S.C. 154(b) by 0 days.

(21) Appl. No.: **17/161,241**

(22) Filed: **Jan. 28, 2021**

(65) **Prior Publication Data**
US 2021/0258087 A1 Aug. 19, 2021

Related U.S. Application Data

(62) Division of application No. 16/792,739, filed on Feb. 17, 2020.

(51) **Int. Cl.**
H04B 17/21 (2015.01)
H04B 17/318 (2015.01)
(Continued)

(52) **U.S. Cl.**
CPC **H04B 17/21** (2015.01); **H01Q 1/243** (2013.01); **H01Q 3/247** (2013.01); **H01Q 21/28** (2013.01); **H04B 7/0808** (2013.01); **H04B 7/0814** (2013.01); **H04B 7/0888** (2013.01); **H04B 17/318** (2015.01); **H04W 12/72** (2021.01); **H04W 16/28** (2013.01)

(58) **Field of Classification Search**

CPC H04B 17/21
See application file for complete search history.

(56) **References Cited**

U.S. PATENT DOCUMENTS

6,392,610 B1 * 5/2002 Braun H01Q 9/26 343/876
6,862,433 B2 3/2005 Callaway
(Continued)

OTHER PUBLICATIONS

“Notice of Allowance”, U.S. Appl. No. 16/792,739, dated Dec. 10, 2020, 8 pages.

(Continued)

Primary Examiner — Hsinchun Liao

(74) *Attorney, Agent, or Firm* — FIG. 1 Patents

(57) **ABSTRACT**

Techniques for process based antenna configuration are described, and may be implemented via a wireless device to identify different usage scenarios and to adapt antenna configurations to optimize wireless performance based on the scenarios. For instance, the described techniques enable a wireless device to be calibrated for wireless communication by identifying different obstruction states of a wireless device that correspond to ways that the wireless device is held (e.g., grasped) by a user in different scenarios. The obstruction states are then correlated to antenna positions in the wireless device to prioritize (e.g., activate) antennas that are relatively unobstructed, such as by activating unobstructed antennas and/or deactivating obstructed antennas. Further, calibration can take into specific processes (e.g., applications) and specific users to calibrate an optimize wireless performance based on ways in which a user typically interacts with a process.

20 Claims, 14 Drawing Sheets

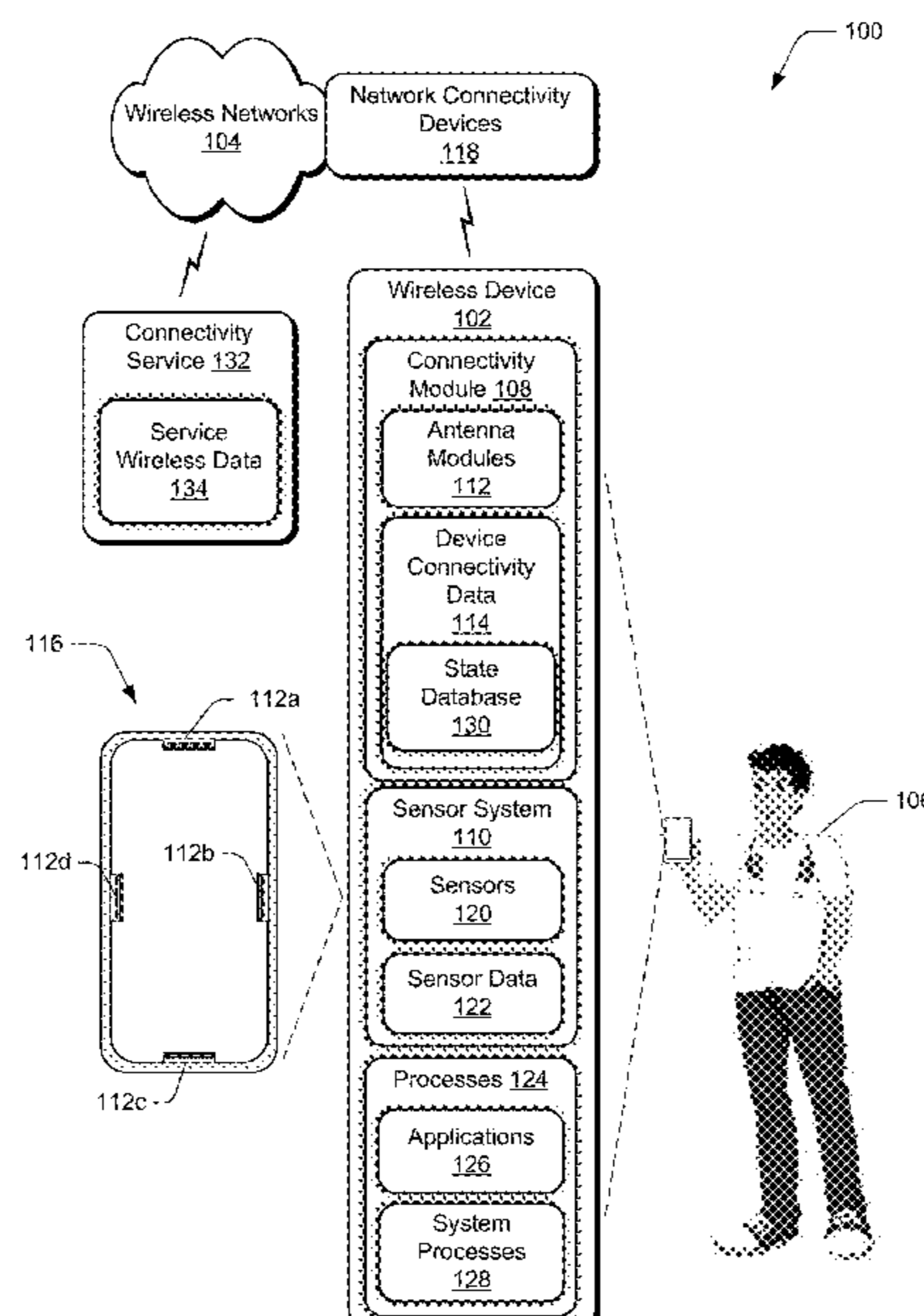

- (51) **Int. Cl.**
H04B 7/08 (2006.01)
H01Q 21/28 (2006.01)
H04W 16/28 (2009.01)
H01Q 3/24 (2006.01)
H01Q 1/24 (2006.01)
H04W 12/72 (2021.01)

(56) **References Cited**

U.S. PATENT DOCUMENTS

- 7,321,580 B1 * 1/2008 Ramanathan H04W 74/0816
370/252
10,951,331 B1 3/2021 Chisu et al.
2004/0002340 A1 1/2004 Lim et al.
2008/0032756 A1 2/2008 Kanazawa
2008/0182537 A1 7/2008 Manku et al.
2011/0202866 A1 8/2011 Huang et al.
2013/0051261 A1 * 2/2013 Kazmi H04W 52/0277
370/252
2019/0123433 A1 * 4/2019 Lee H01Q 1/3233

OTHER PUBLICATIONS

“Restriction Requirement”, U.S. Appl. No. 16/792,739, dated Oct. 19, 2020, 5 pages.

* cited by examiner

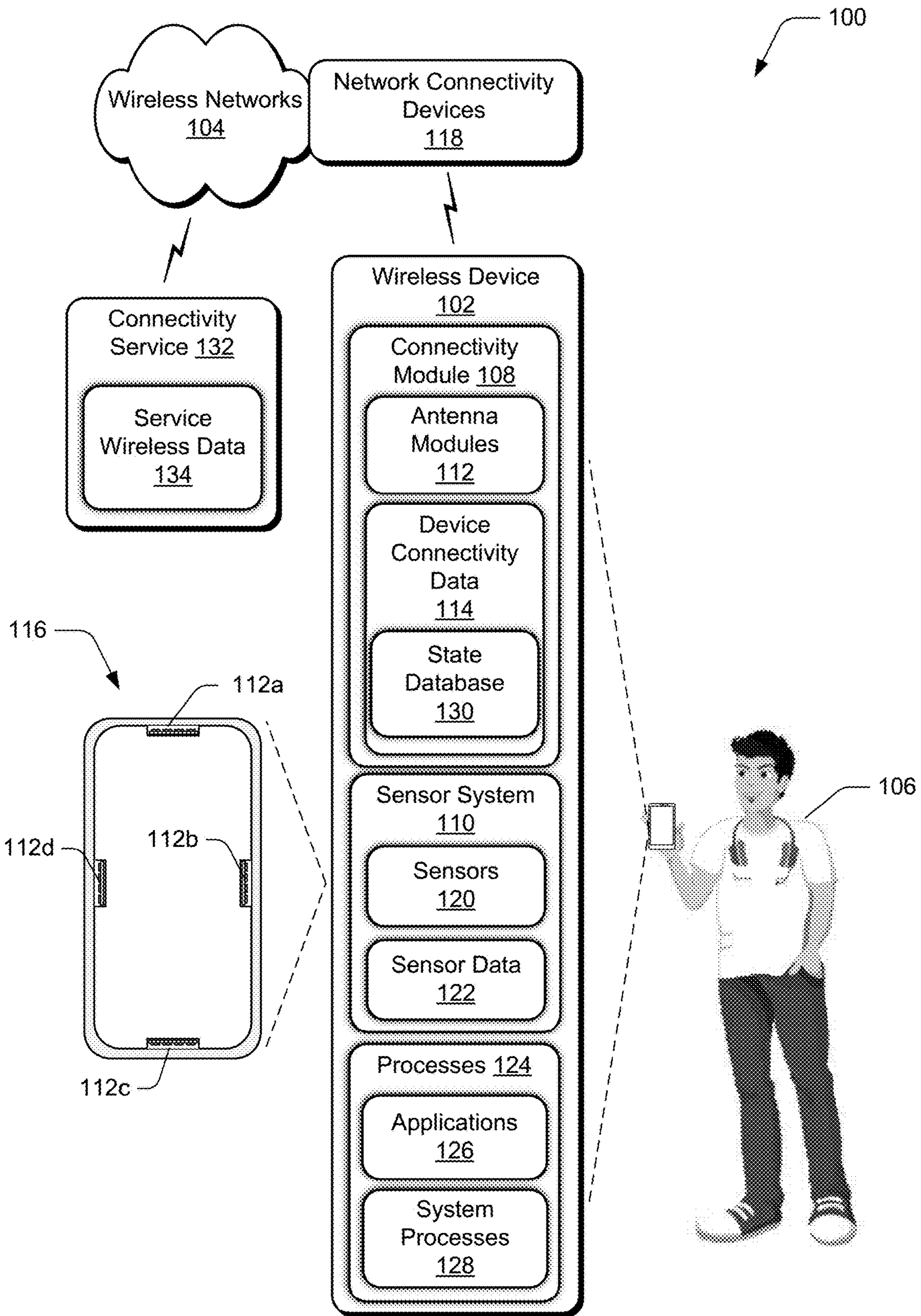

Fig. 1

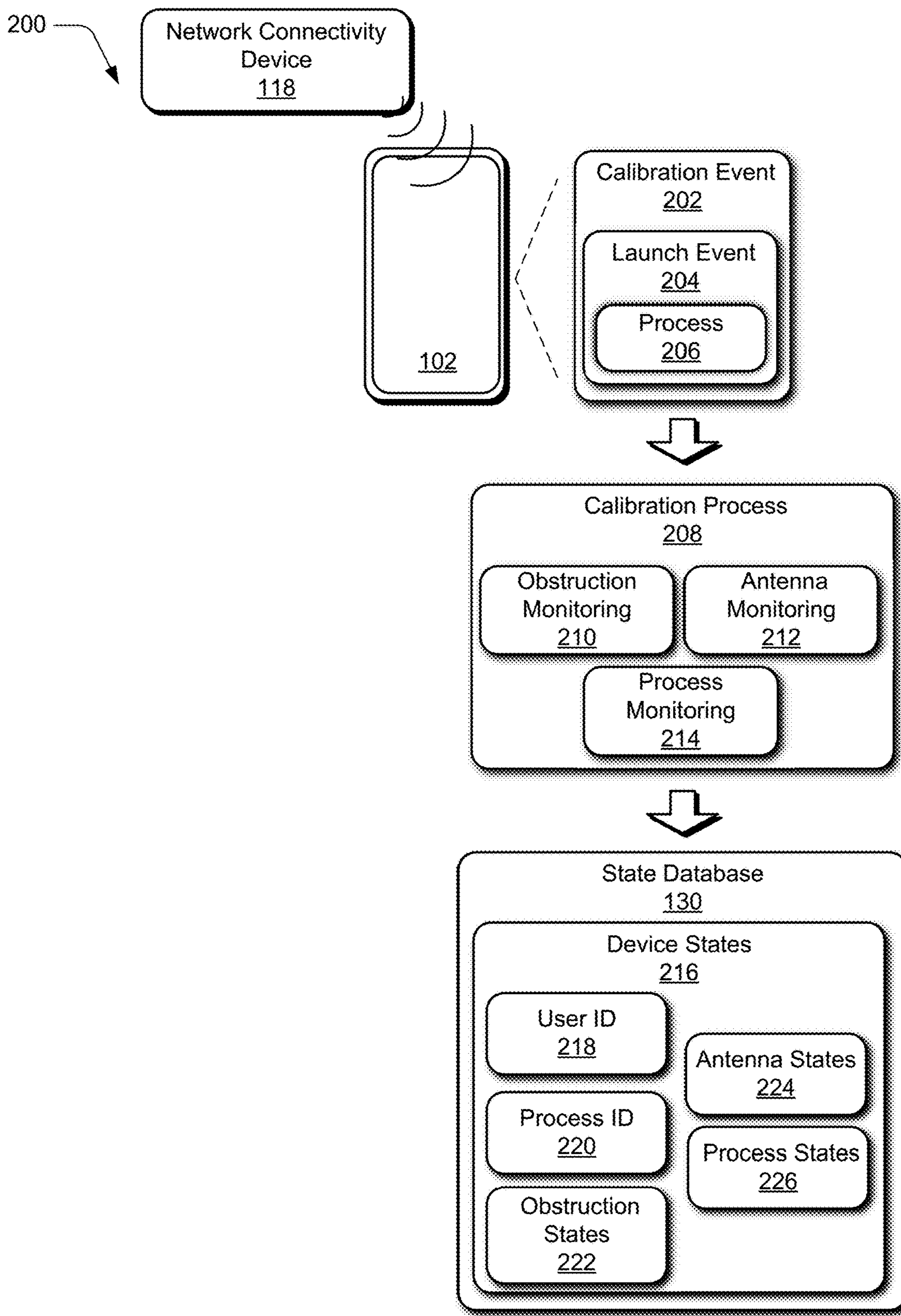

Fig. 2

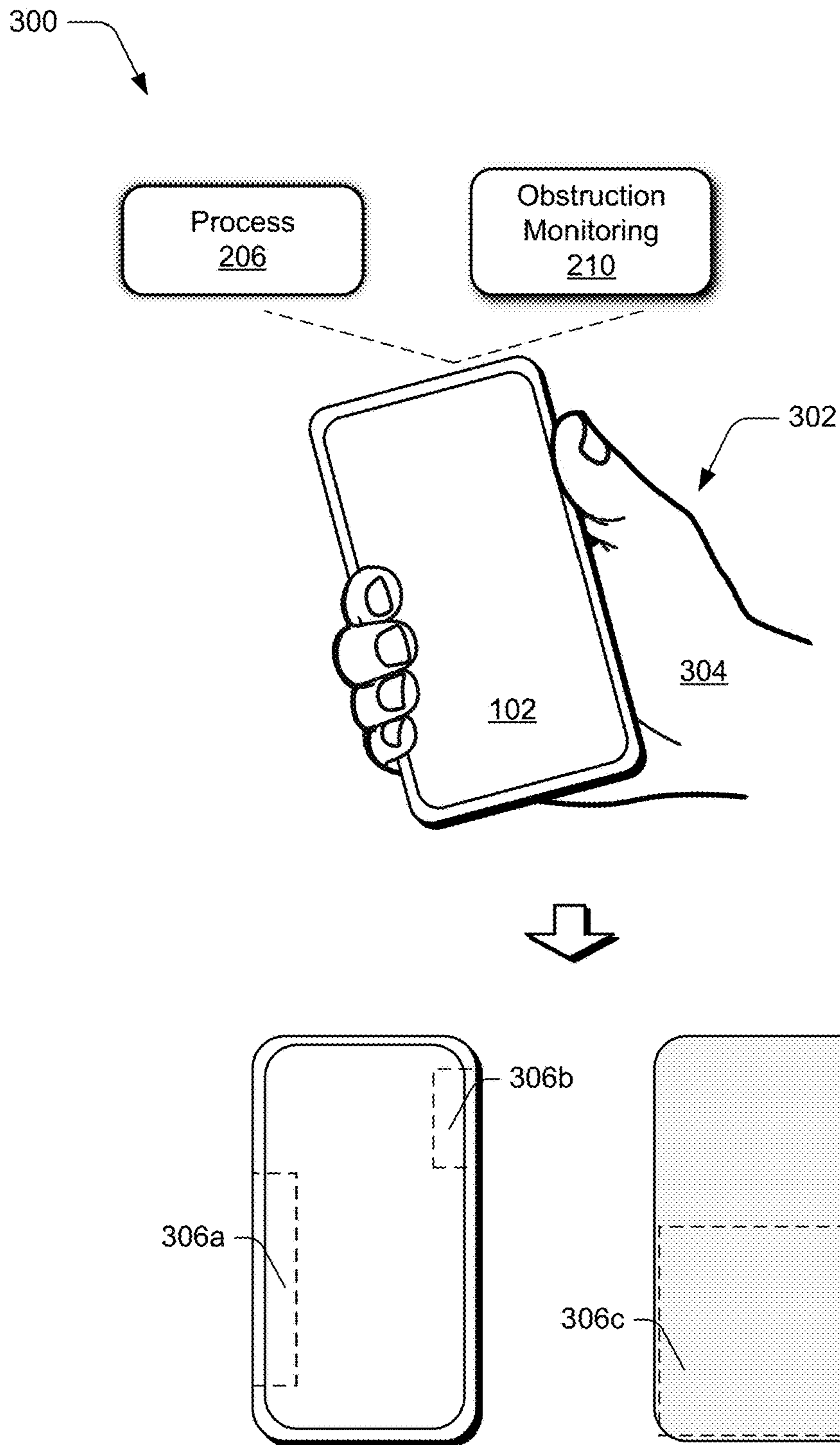
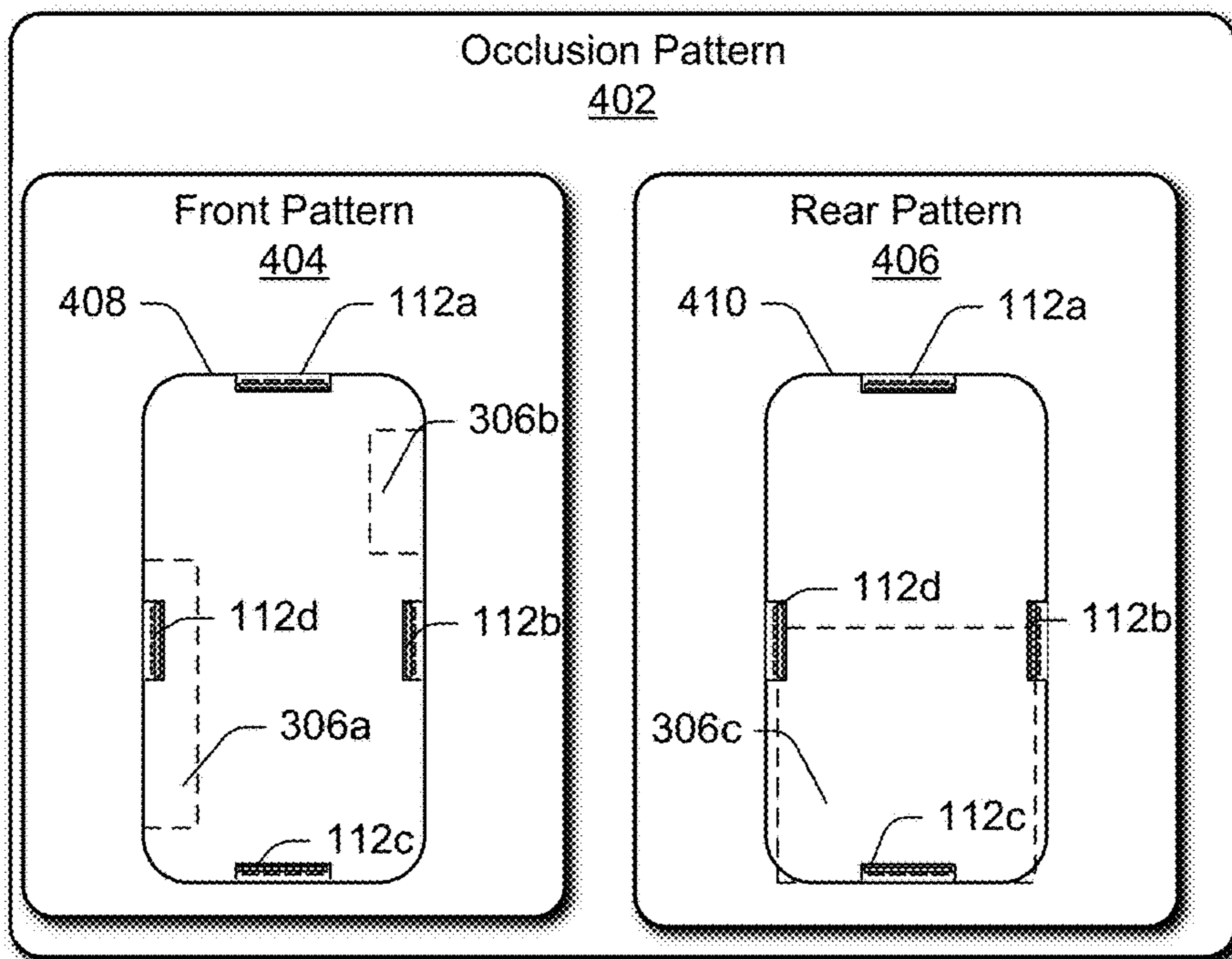

Fig. 3

400



Obstruction
State
412

Fig. 4

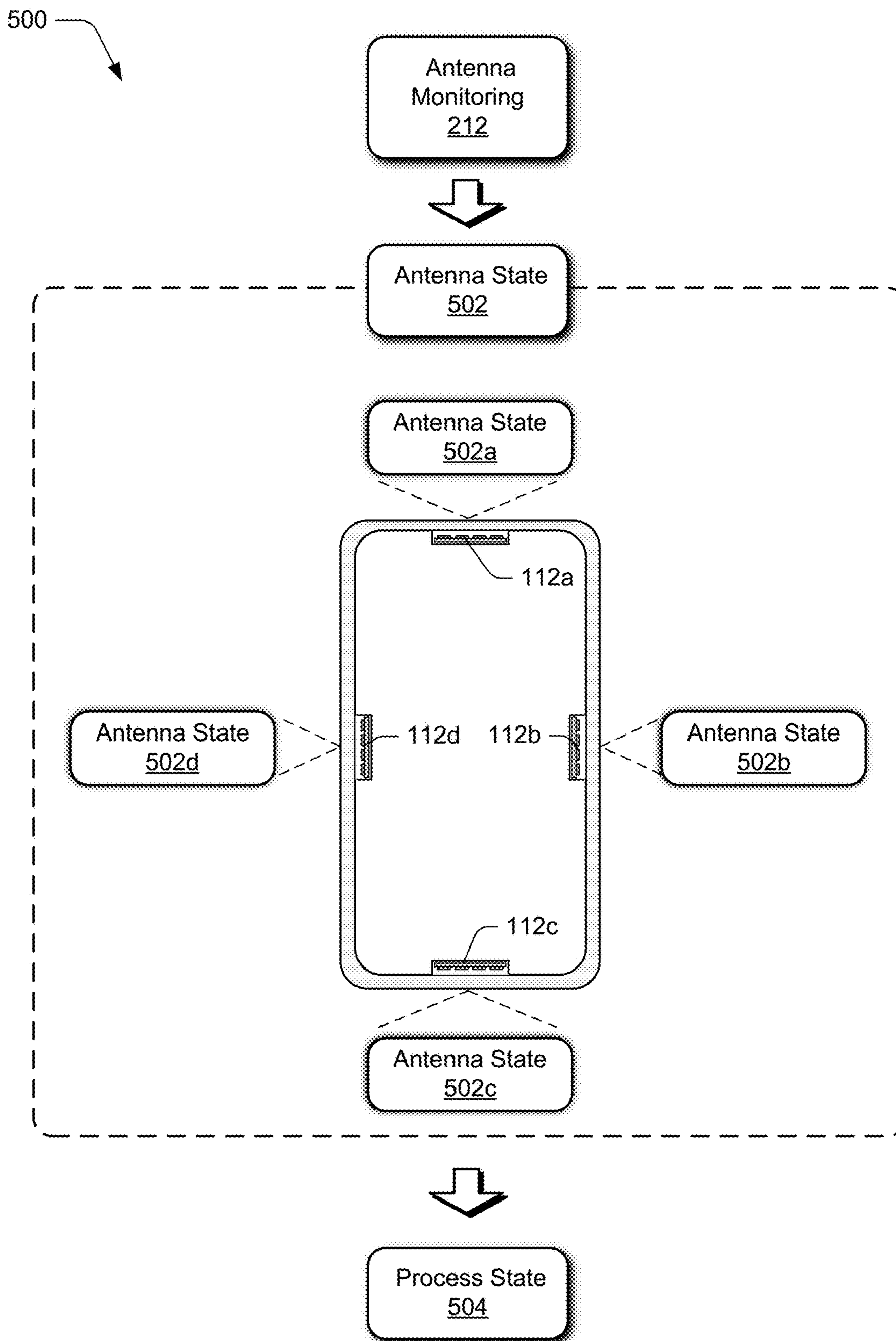

Fig. 5

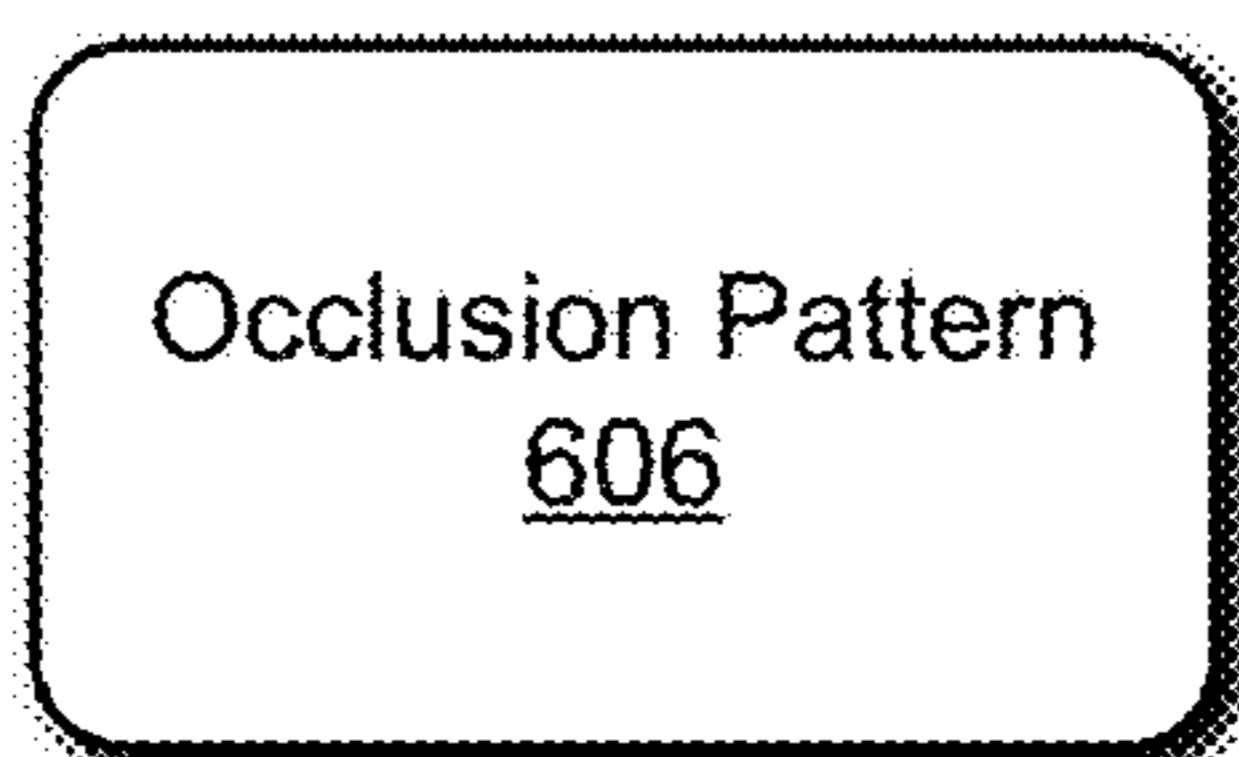
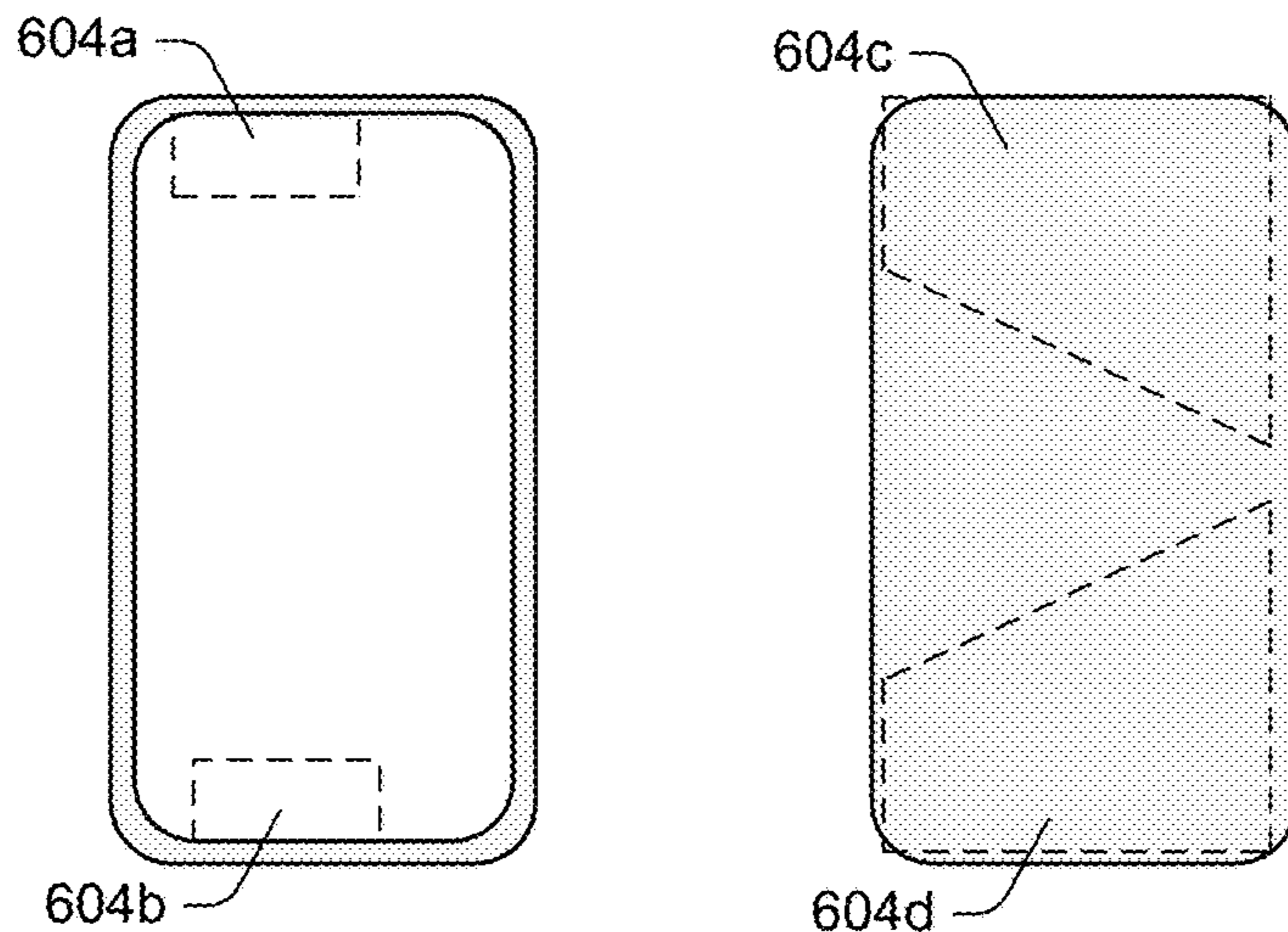
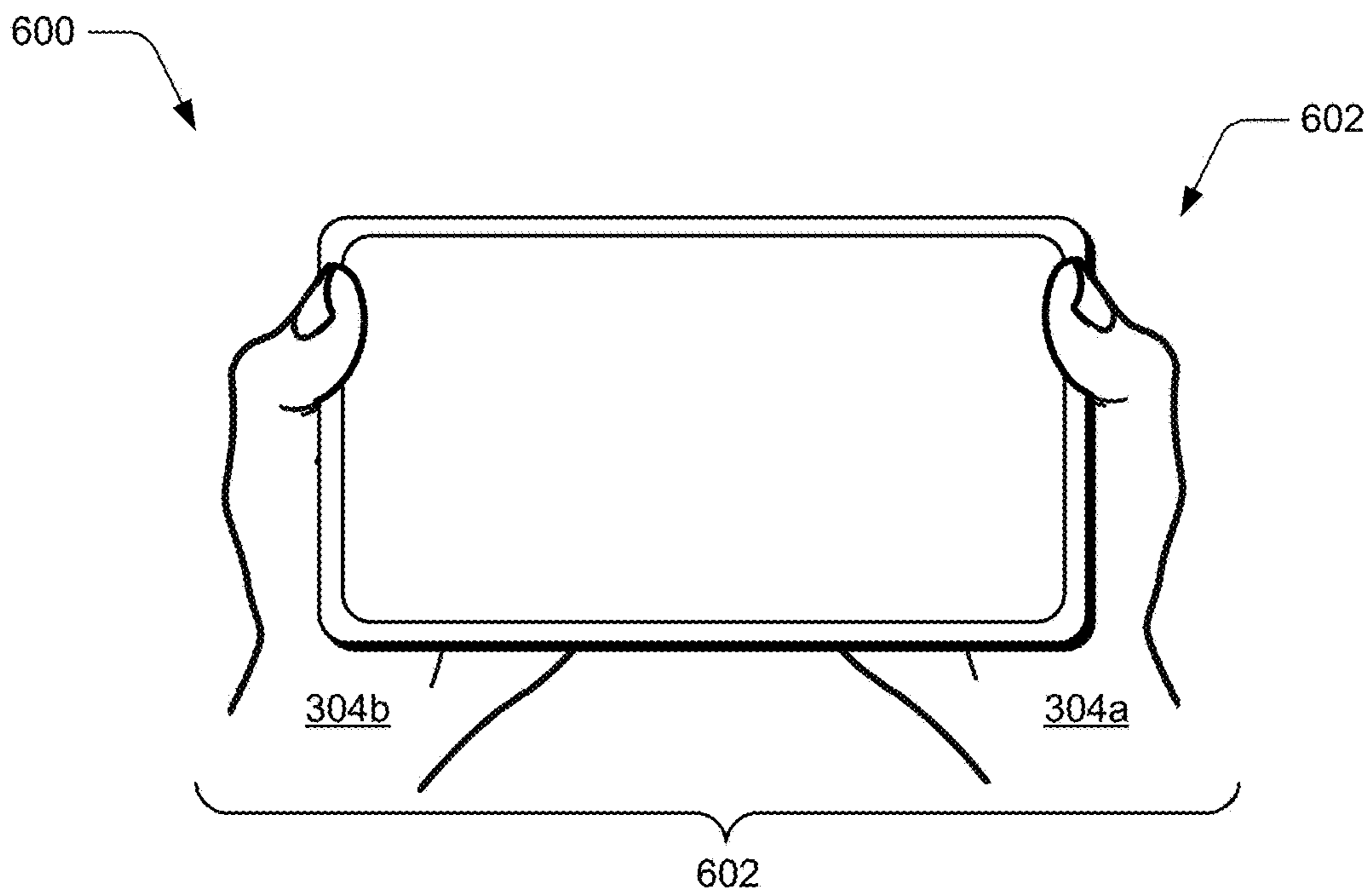

Fig. 6

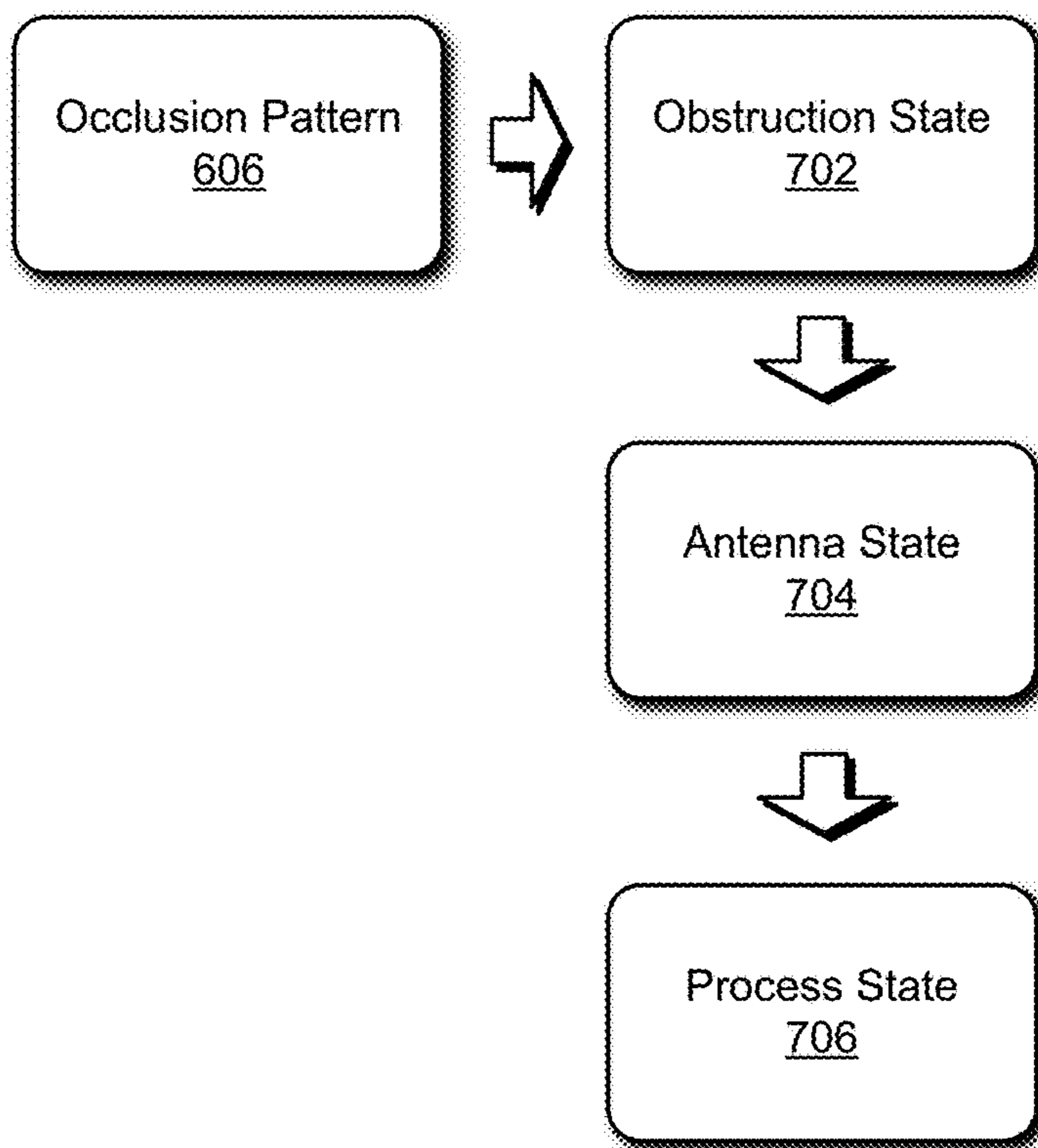
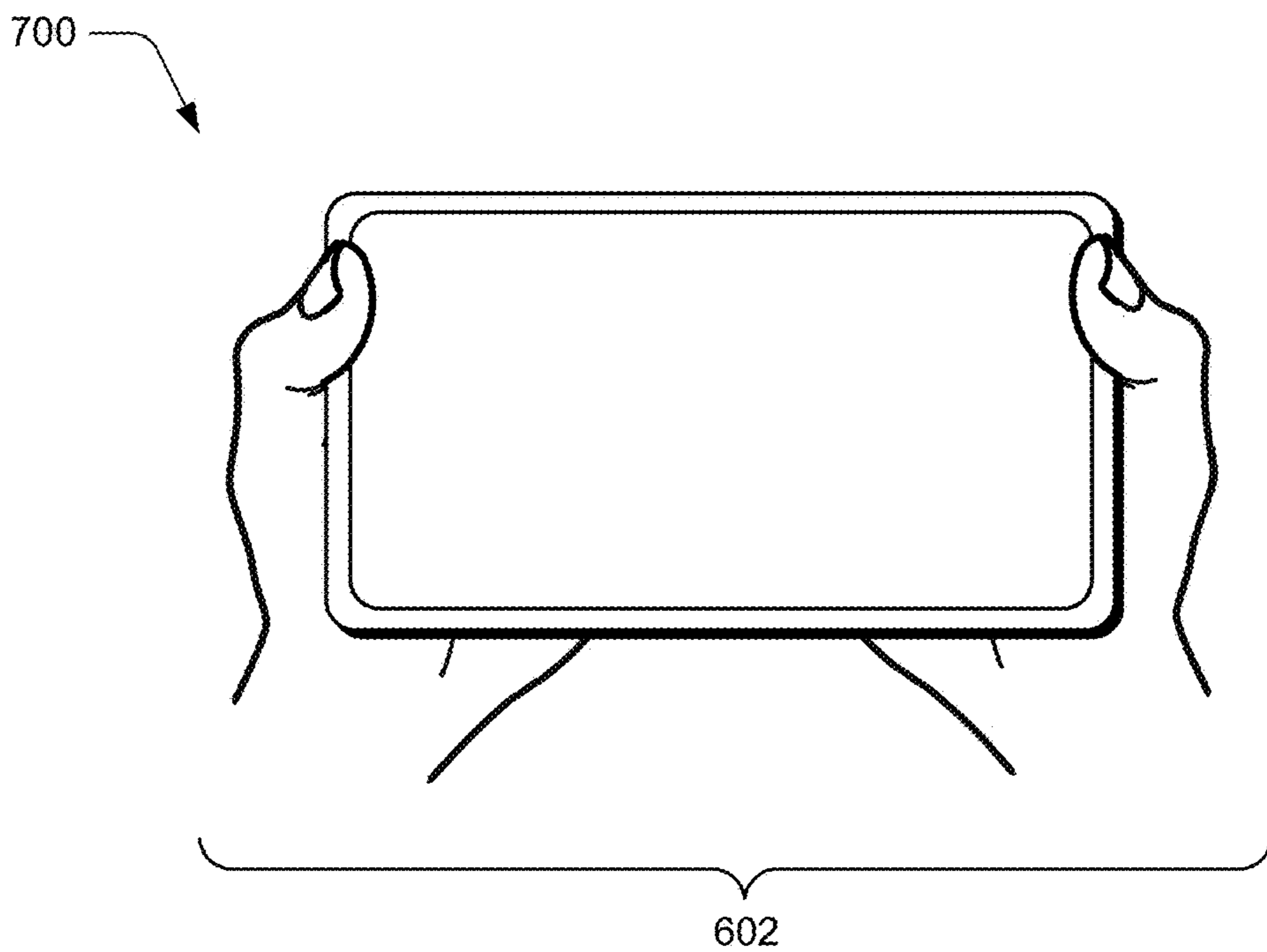

Fig. 7

800

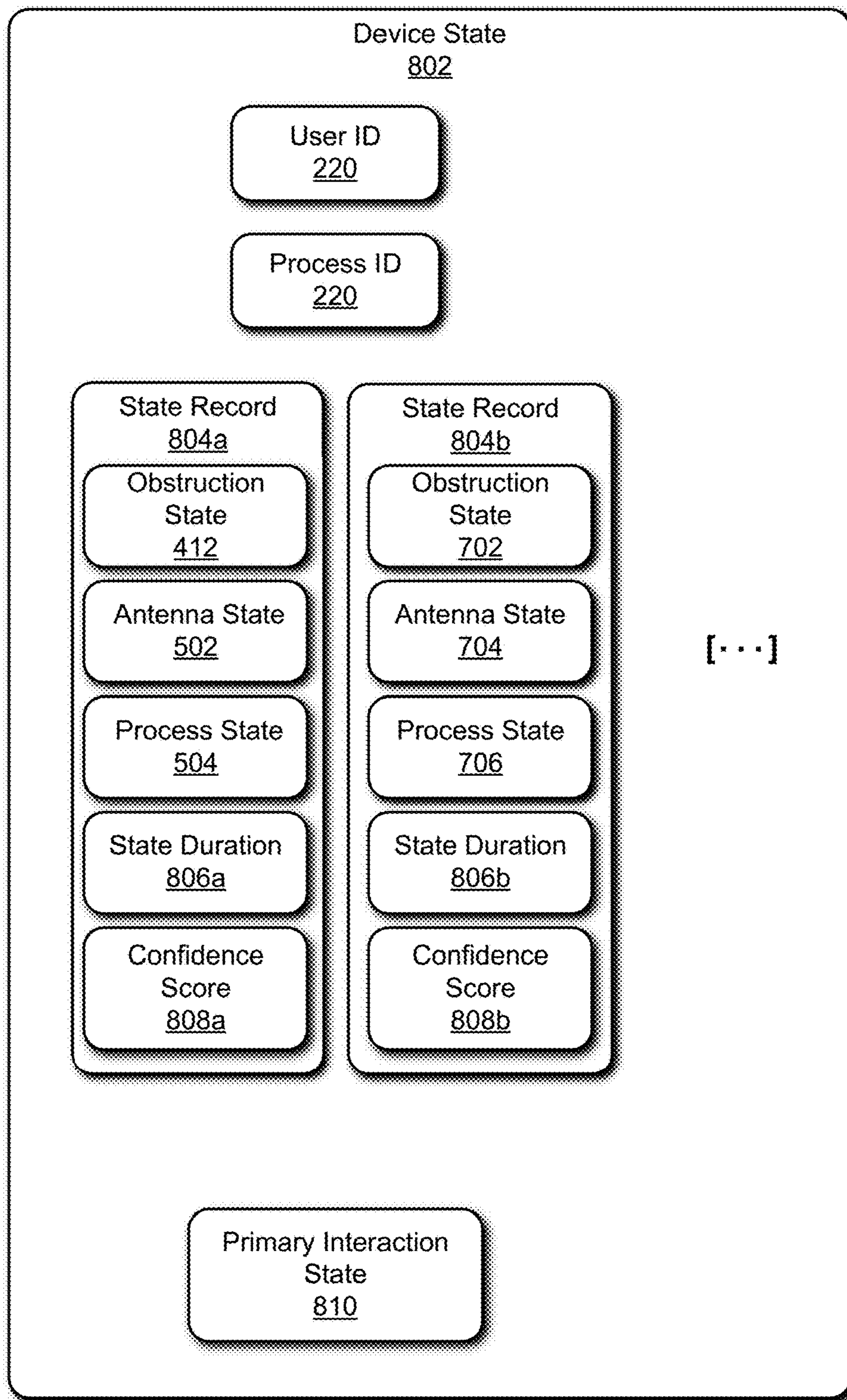

Fig. 8

900

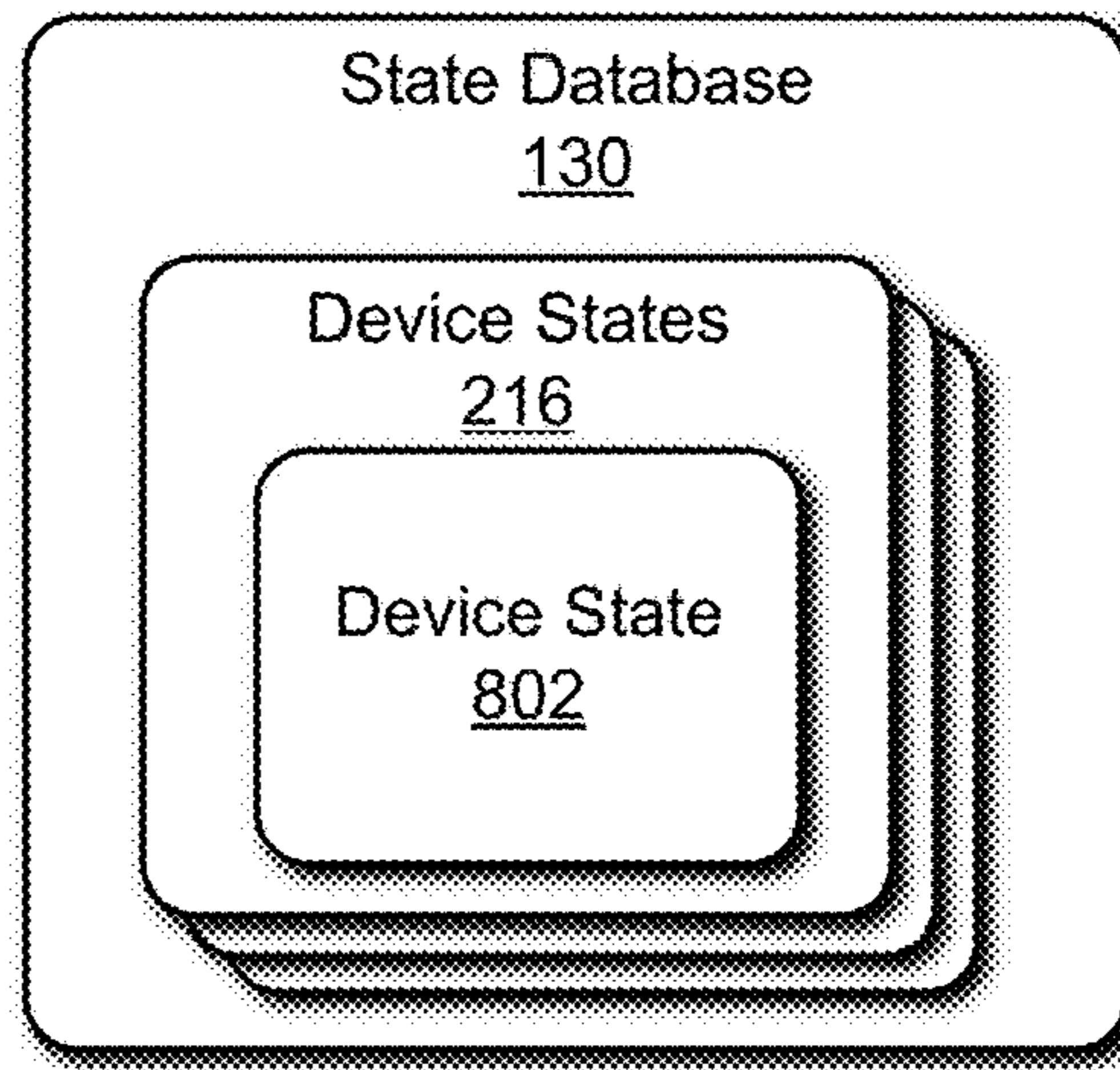
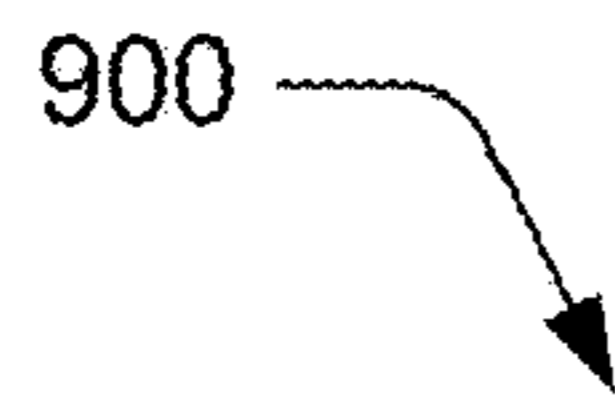

Fig. 9

1000

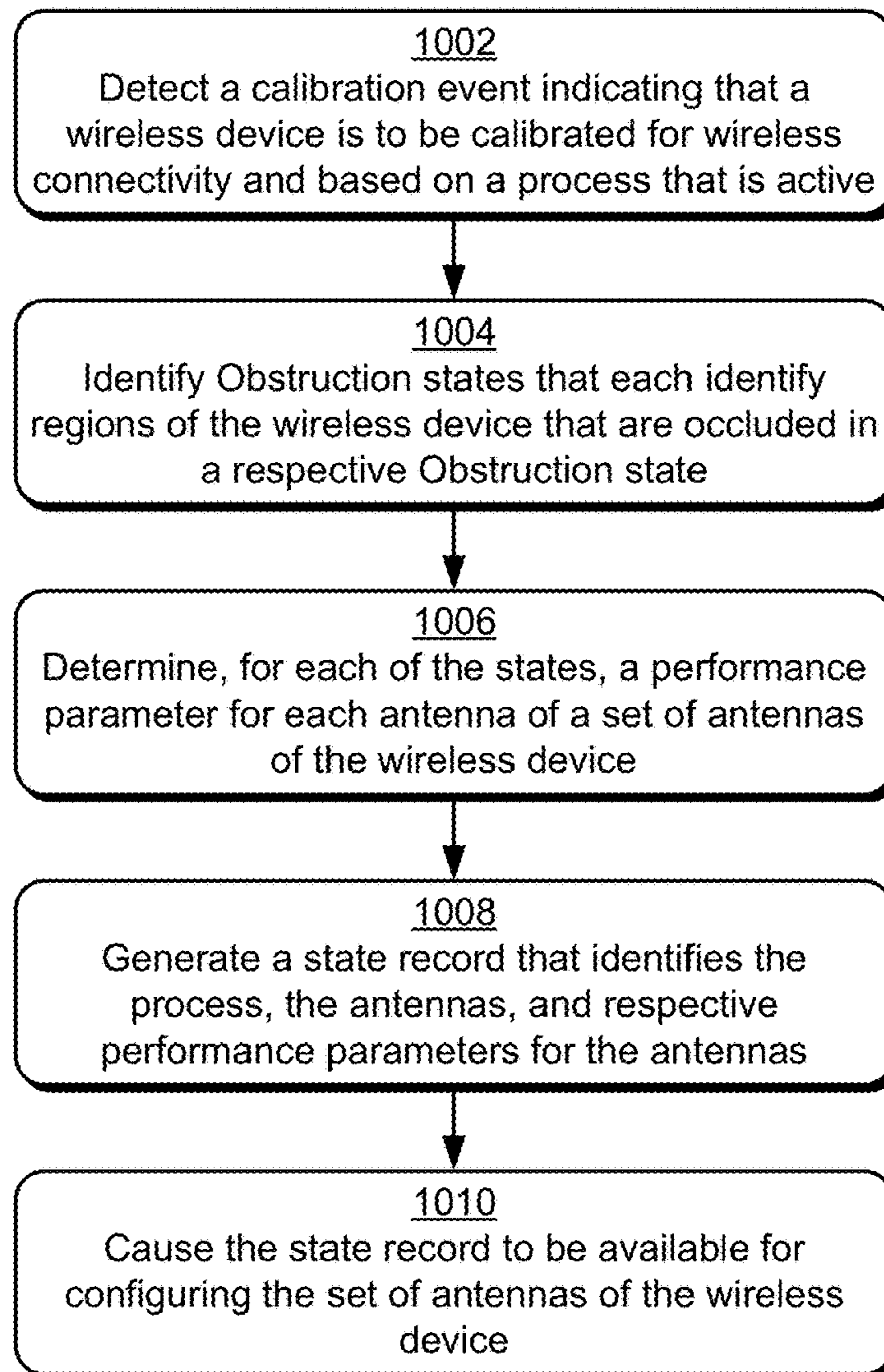



Fig. 10

1100 

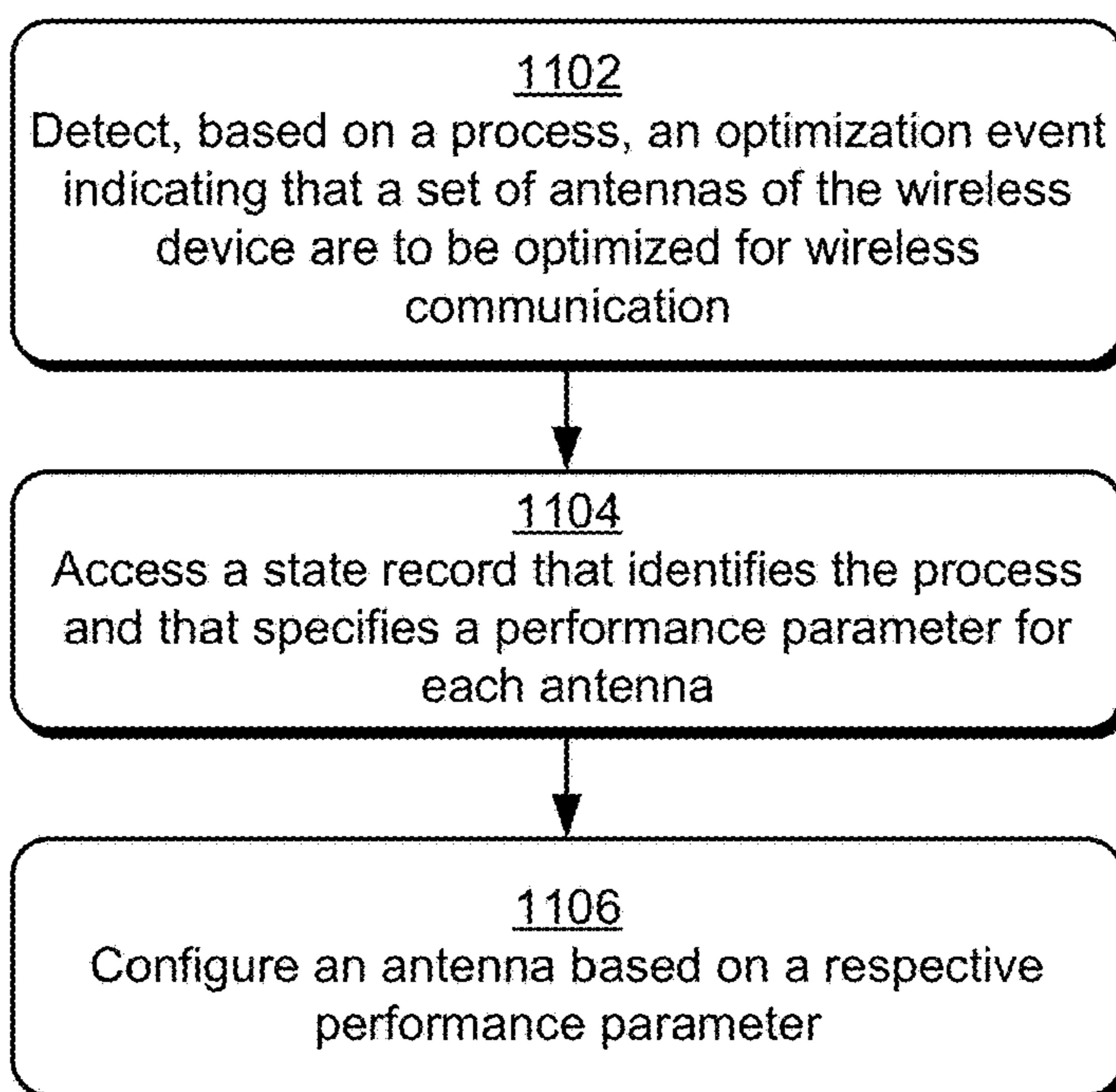

Fig. 11

1200

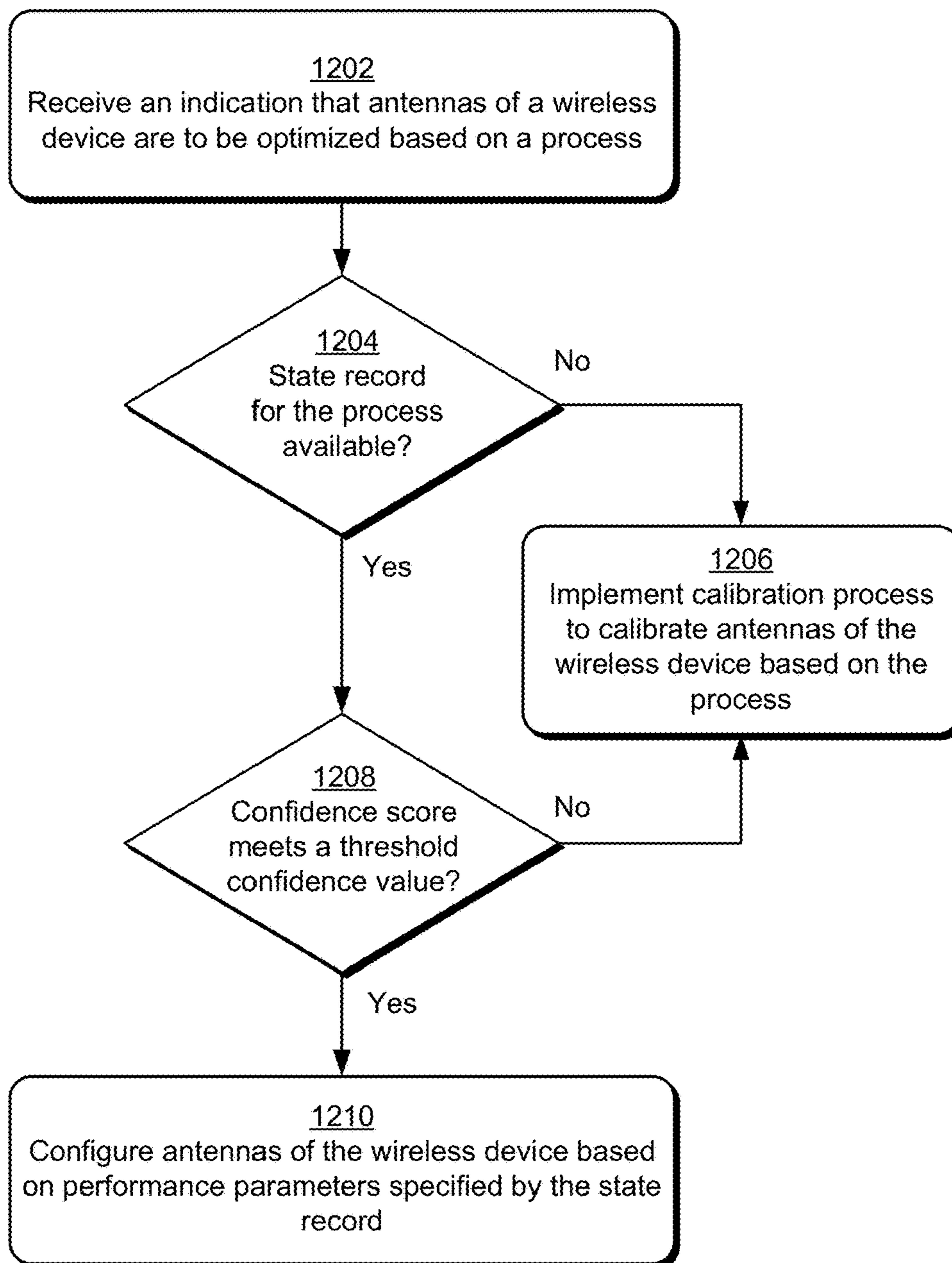

Fig. 12

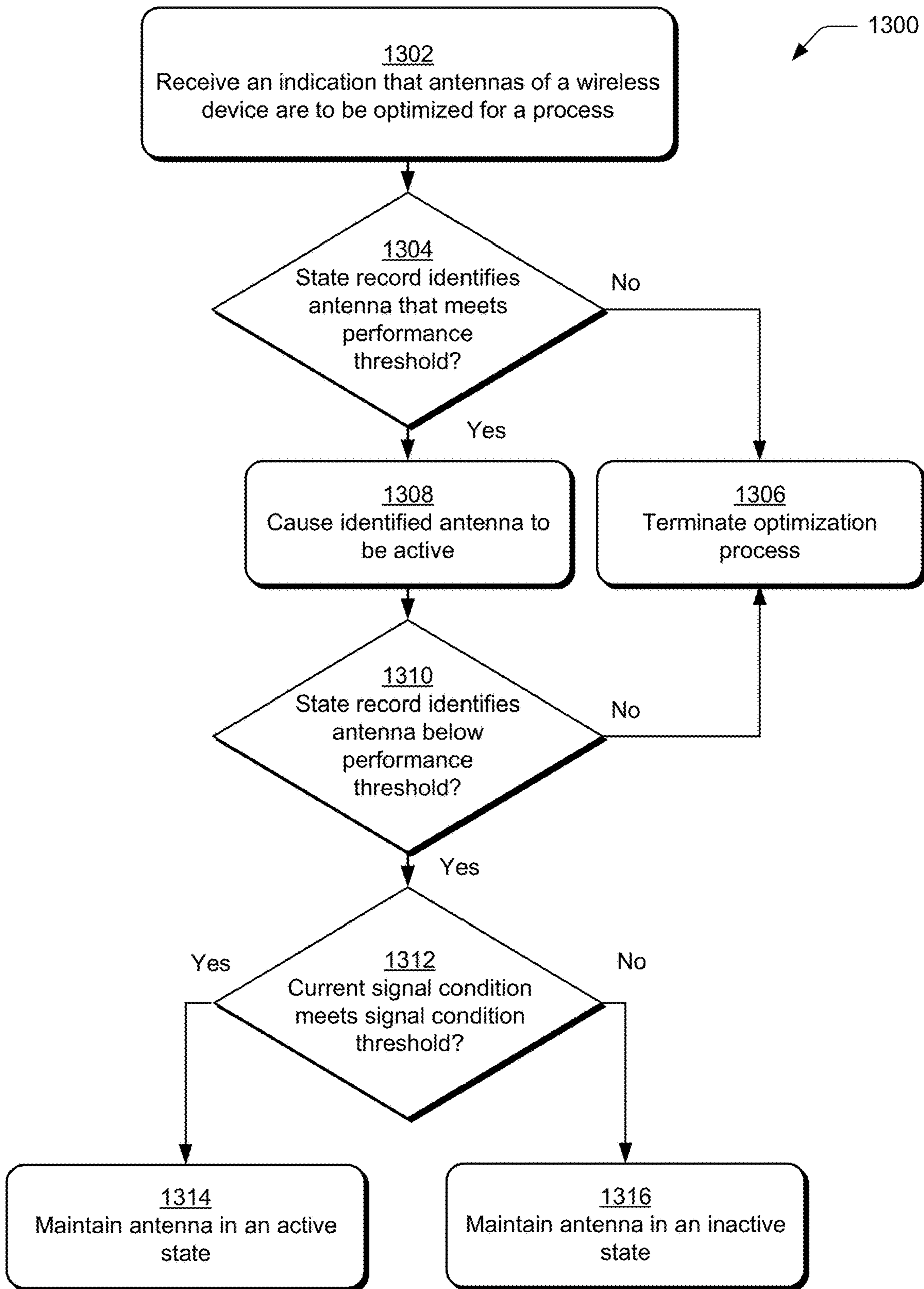

Fig. 13

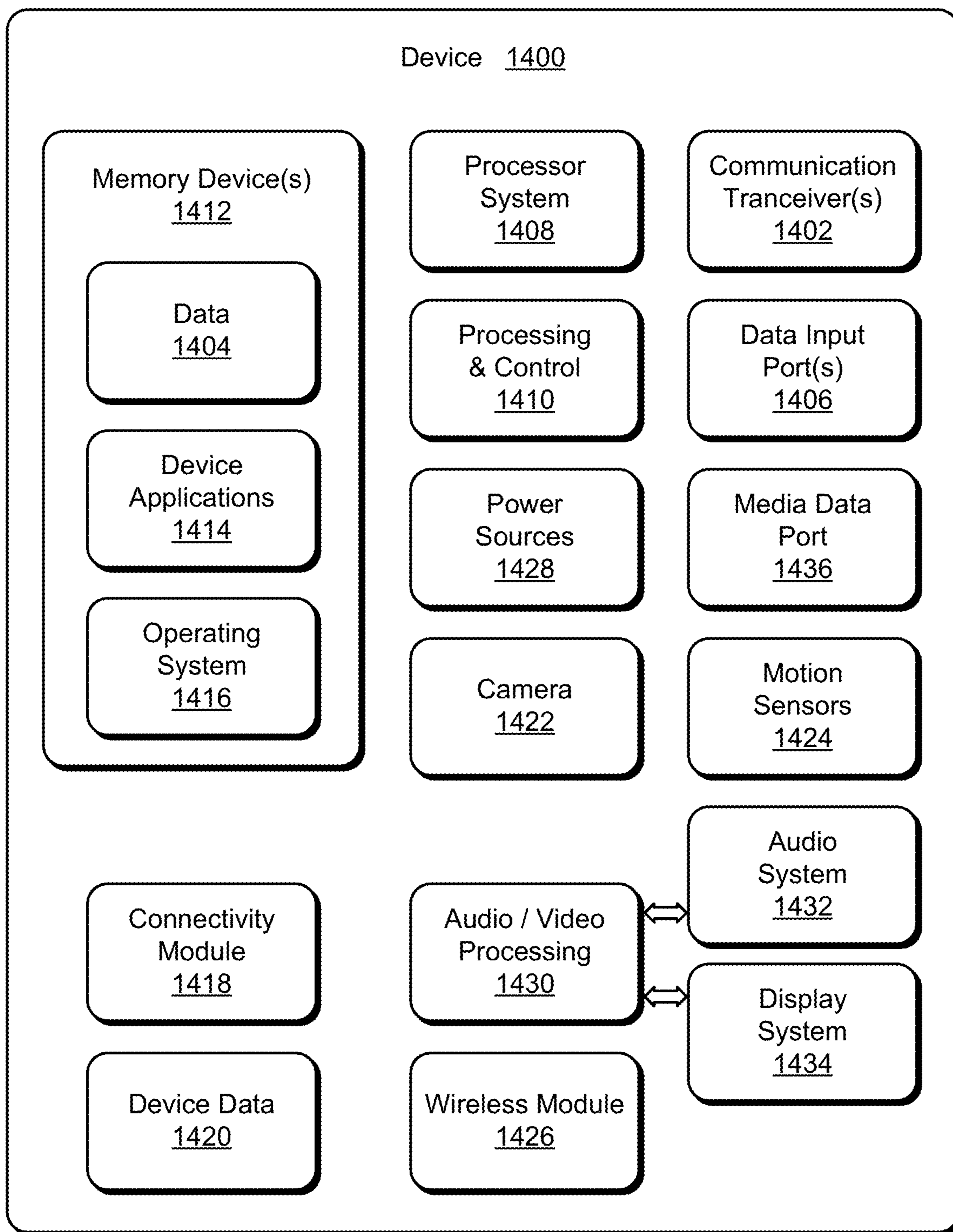

Fig. 14

1**PROCESS BASED ANTENNA
CONFIGURATION**

RELATED APPLICATION

This application is a divisional of and claims priority to U.S. patent application Ser. No. 16/792,739, filed 17 Feb. 2020 and titled "Process Based Antenna Configuration," the disclosure of which is hereby incorporated by reference in its entirety herein.

BACKGROUND

Wireless communication is ubiquitous and is used for a multitude of purposes, including wireless voice and data communication. Further, wireless protocols are constantly evolving to provide increased service levels for wireless users. For instance, recent developments in wireless technology have greatly increased the rate at which information can be transmitted wirelessly. One example of such a development is the 5G wireless cellular technology (e.g., 5G New Radio (NR)), which typically achieves higher data rates than previous wireless technologies. Such recently developed technologies achieve increased data rates at least in part by utilizing higher frequency wireless spectrum than previous technologies, such as 3.5 gigahertz (GHz) and higher. In fact, some implementations of these wireless technologies use extremely high frequency (EHF) frequencies, such as millimeter wave (mmWave) frequencies. While higher data rates can be achieved, such technologies exhibit a number of implementation challenges, such as increased directionality. Further, higher frequency wireless technologies can experience higher susceptibility to signal obstruction caused by physical interference, such as due to interference caused by a user grasping a device.

BRIEF DESCRIPTION OF THE DRAWINGS

Aspects of process based antenna configuration are described with reference to the following Figures. The same numbers may be used throughout to reference similar features and components that are shown in the Figures:

FIG. 1 illustrates an example environment in which aspects of process based antenna configuration can be implemented.

FIG. 2 depicts a scenario for performing aspects of a wireless calibration process for a wireless device in accordance with one or more implementations.

FIG. 3 depicts a scenario for identifying different device states for calibrating the wireless device in accordance with one or more implementations.

FIG. 4 depicts a scenario for generating an occlusion pattern as part of a calibration process in accordance with one or more implementations described herein.

FIG. 5 depicts a scenario for determining antenna state as part of a calibration process in accordance with one or more implementations described herein.

FIG. 6 depicts a scenario for detecting a grip change during a calibration process in accordance with one or more implementations described herein.

FIG. 7 depicts a scenario for incorporating a change in obstruction state into a calibration process in accordance with one or more implementations described herein.

FIG. 8 depicts a scenario for generating a representation of device state ascertained as part of a calibration process in accordance with one or more implementations described herein.

2

FIG. 9 depicts a method for calibrating wireless performance of a wireless device in accordance with one or more implementations described herein.

FIG. 10 depicts a method for performing tasks while positioned at an optimal position for wireless communication in accordance with one or more implementations described herein.

FIG. 11 depicts a method for configuring antennas of a wireless device in accordance with one or more implementations described herein.

FIG. 12 depicts a method for configuring antennas of a wireless device in accordance with one or more implementations described herein.

FIG. 13 depicts a method for configuring antennas of a wireless device in accordance with one or more implementations described herein.

FIG. 14 illustrates various components of an example device that can implement aspects of process based antenna configuration.

DETAILED DESCRIPTION

Techniques for process based antenna configuration are described, and may be implemented via a wireless device to identify different usage scenarios and to adapt antenna configurations to optimize wireless performance based on the scenarios. Generally, the described techniques enable the wireless device to be calibrated for wireless communication by identifying different obstruction states of a wireless device that correspond to how portions of a wireless device are obstructed based on different usage scenarios. Obstruction states, for instance, represent ways that a wireless device is held (e.g., grasped) by a user in different scenarios. The obstruction states are then correlated to antenna positions in the wireless device to prioritize (e.g., activate) antennas that are relatively unobstructed, such as by activating unobstructed antennas and/or deactivating obstructed antennas. Further, calibration can take into accounts specific processes (e.g., applications) and specific users to calibrate an optimize wireless performance based on ways in which a user typically interacts with a process.

Consider, for example, a scenario where a user launches an application on a wireless device and holds the wireless device in a particular way while interacting with the application. For instance, some applications may provide a preferable user experience in a portrait orientation of a wireless device (e.g., an email application), whereas other applications are more suited to a landscape orientation, e.g., a video player application. Thus, depending on application context and user preferences, a user may grasp a device in different ways to achieve a desired viewing and/or interaction perspective. Accordingly, techniques described herein enable device calibration to adapt antenna performance to these different interaction scenarios. For instance, when an application is launched on a wireless device (e.g., for the first time), a calibration process is initiated that detects how a user holds the wireless device while interacting with the application. Generally, this can be implemented by collecting sensor data that describes how a user grasps the wireless device, such as sensor data from contact-sensing sensors that detect regions of the wireless device that are in contact with the user. The different contact regions can then be correlated to antenna locations of the wireless device to identify antennas that may be occluded by the user's grasp and antennas that may be partially or fully free from occlusion.

Based on the calibration process, a state record can be generated that identifies the application and the user, and that

identifies an antenna state for the antennas. The antenna state, for example, indicates for each antenna whether the antenna will likely exhibit good wireless performance based on this usage scenario (e.g., is likely unobstructed), or whether each antenna may exhibit poor wireless performance, e.g., is likely obstructed. Accordingly, when the application is subsequently active on the wireless device, the state record can be utilized to determine which antennas to maintain in an active state (e.g., an unobstructed antenna) and which antennas to maintain in an inactive state, e.g., obstructed antennas. This not only increases wireless performance of the wireless device by prioritizing antennas that are likely to provide better wireless signal reception and/or transmission, but also conserves power resources (e.g., battery charge) by maintaining antennas that are likely to perform poorly in an inactive state. Further, once a state record for a particular process (e.g., application or system process) is generated, the state record can be utilized to proactively adapt antenna state when the process is implemented on a wireless device, such as when a user selects the application to be executed. For instance, instead of relying on conventional reactive processes that monitor antenna performance and respond to changes in antenna performance which may result in wireless performance degradation due to lag time in responding to such changes, the described techniques proactively configure individual antennas based on process state, thus avoiding such performance interruptions.

While features and concepts of process based antenna configuration can be implemented in any number of different devices, systems, environments, and/or configurations, aspects of process based antenna configuration are described in the context of the following example devices, systems, and methods.

FIG. 1 illustrates an example environment 100 in which aspects of process based antenna configuration can be implemented. The example environment 100 includes a wireless computing device (“wireless device”) 102 that is connectable to wireless networks 104. In this particular example, the wireless device 102 represents a portable device that can be carried by a user 106, such as a smartphone, a tablet device, a laptop, a wearable computing device, (e.g., a smartwatch or a fitness tracker), and so forth. These examples are not to be construed as limiting, however, and the wireless device 102 can be implemented in a variety of different ways and form factors. Further example attributes of the wireless device 102 are discussed below with reference to the device 1400 of FIG. 14.

The wireless device 102 includes various functionality that enables the wireless device 102 to perform different aspects of process based antenna configuration discussed herein, including a connectivity module 108 and a sensor system 110. The connectivity module 108 represents functionality (e.g., hardware and logic) that enables the wireless device 102 to communicate wirelessly, such as for wireless data and voice communication. The connectivity module 108, for instance, includes functionality to support different wireless protocols, such as wireless cellular (e.g., 3G, 4G, 5G), wireless broadband, Wireless Local Area Network (WLAN) (e.g., Wi-Fi), Wi-Fi Direct, Neighborhood Awareness Networking (NAN), wireless short distance communication (e.g., Bluetooth™ (including Bluetooth™ Low Energy (BLE)), Near Field Communication (NFC)), and so forth. The connectivity module 108 also includes antenna modules 112 and device connectivity data (“device data”) 114.

The antenna modules 112 represent functionality (e.g., hardware and logic) for enabling the wireless device 102 to send and receive wireless signal, such as for wireless connectivity to the wireless networks 104. At least some individual antenna modules 112, for instance, each include a physical antenna device that is operable to receive wireless signal transmitted by the wireless networks 104, and to transmit wireless signal for receipt by the wireless networks 104. The antenna modules 112 may include other hardware and logic, for as for adapting operating parameters of physical antennas. In at least one implementation, at least some of the antenna modules 112 represent antennas without integrated logic, such as patch antennas and/or arrays of antennas that are communicatively connected to the connectivity module 108. In at least some implementations, the wireless device 102 may employ instances of the antenna modules 112 physically arranged at different locations on the wireless device 102, such as to optimize wireless performance of the wireless device 102.

For instance, the environment 100 depicts an internal view 116 that represents a view of the wireless device 102 with a surface removed, such as a display screen of the wireless device 102. Depicted in the internal view 116 is an antenna module 112a, antenna module 112b, antenna module 112c, and antenna module 112d, which represent different instances of the antenna modules 112. As shown, the antenna modules 112a-112d are each positioned at different physical locations on the wireless device 102. Further, the antenna modules 112a-112d are interconnected to provide an integrated antenna structure for enabling the wireless device to send and receive wireless signal. This particular arrangement of antenna modules 112 is presented for purpose of example only, and it is to be appreciated that the described implementations can utilize a variety of different arrangements of antennas not expressly described herein.

The wireless device 102 generates and/or maintains the device data 114, which is representative of various types of data that is used and/or observed by the connectivity module 108. The device data 114, for instance, includes attributes of wireless signal received and/or detected by the connectivity module 108, such as base station identifiers, received signal strength indicator (RSSI), signal strength (e.g., in dBm), signal frequency band, signal quality (e.g., signal-to-noise (S/N) ratio), and so forth. The device data 114 also includes various device state information for the wireless device 102, such as described in more detail below.

In at least one implementation, the connectivity module 108 wirelessly connects the wireless device 102 to the wireless networks 104 via interaction between the connectivity module 108 and network connectivity devices 118. Generally, the network connectivity devices 118 are representative of functionality to receive and transmit wireless signal and serve as access portals for the wireless networks 104. Examples of the network connectivity devices 118 include a wireless cellular base station, a wireless access point (e.g., for a WLAN and/or a Wireless Wide Area Network (WWAN)), a short-range wireless network access point, and so forth. In at least one implementation, the network connectivity device 118 and/or the wireless networks represent wireless signal sources for the wireless device 102.

The sensor system 110 is representative of functionality to detect various physical and/or logical phenomena in relation to the wireless device 102, such as motion, light, image detection and recognition, time and date, position, location, touch detection, temperature, and so forth. To enable the sensor system 110 to detect such phenomena, the sensor

system 110 includes sensors 120 that are configured to generate sensor data 122. Examples of the sensors 120 include hardware and/or logical sensors such as an accelerometer, a gyroscope, a camera, a microphone, a clock, biometric sensors, touch input sensors, position sensors, environmental sensors (e.g., for temperature, pressure, humidity, and so on), geographical location information sensors (e.g., Global Positioning System (GPS) functionality), and so forth. In at least some implementations, the sensor data 122 represents raw sensor data collected by the sensors 120. Alternatively or in addition, the sensor data 122 represents raw sensor data from the sensors 120 that is processed to generate processed sensor data, such as sensor data from multiple sensors 120 that is combined to provide more complex representations of wireless device 102 state than can be provided by a single sensor 120.

The wireless device 102 further includes processes 124, examples of which include applications 126 and system processes 128. Generally, the processes are representative of different tasks that can be executed via the wireless device 102. For instance, the applications 126 represent programs that are executable via the wireless device 102 to perform various tasks, such as web browsing, social media interaction, content consumption (e.g., video and/or audio streaming), online shopping, mobile payments, productivity tasks, and so forth. The system processes 128 represent processes for performing various system-related tasks for the wireless device 102, such as configuring various system settings of the wireless device. In at least one implementation, the system processes 128 are hosted by an operating system of the wireless device 102.

Further to techniques described herein, the device data 114 further includes a state database 130, which stores various state information generating as part of the calibration processes described herein. For instance, as detailed below, different state records can be generated that describe antenna states for the antenna modules 112 in different usage scenarios. These antenna states can be stored in the state database 130, and utilized to proactively configure the antenna modules 112 based on various changes in device state, such as based on activity related to the processes 124.

The environment 100 further includes a connectivity service 132 which is connected to and accessible via the wireless networks 104. The wireless device 102, for instance, can interact with the connectivity service 132 to obtain various connectivity-related information and services. For example, the connectivity service 132 includes service wireless data (“service data”) 134, which represents various wireless connectivity-related data obtained by the connectivity service 132 in different ways. The service data 134, for instance, can include overlapping and/or identical information to the device data 114. Further details concerning how the service data 134 is obtained and utilized are discussed below.

FIGS. 2-9 depict different aspects of implementations for process based antenna configuration. For instance, FIG. 2 depicts a scenario 200 for performing aspects of a wireless calibration process for a wireless device. In the scenario 200, a calibration event 202 occurs indicating that the wireless device 102 is to calibrate its wireless connectivity. According to various implementations, the connectivity module 108 can detect the calibration event 202 based on different detected occurrences. In this particular example, the calibration event 202 is based on a process launch event 204 via which the connectivity module 108 detects that a process 206 is launched. Generally, the process 206 represents an implementation of a process 124. For instance, the launch

event 204 occurs based on the user 106 launching an instance of an application 126.

Based on the calibration event 202, the connectivity module 108 initiates a calibration process 208 for calibrating wireless connectivity of the wireless device 102. As part of the calibration process 208, the connectivity module 108 performs obstruction monitoring 210. Generally, the obstruction monitoring 210 determines how a user is holding (e.g., grasping) the wireless device 102, such as based on a position of a user’s hand(s) relative to the wireless device 102. The sensor system 110, for example, leverages the sensors 120 to detect which portions of the wireless device 102 are in contact with the user’s hand and/or other object, such as a different portion of the user’s body, a physical object other than the user (e.g., a phone holder, furniture, and so forth), and so on. In this way, the connectivity module 108 can receive obstruction position information from the sensor system 110 as part of the obstruction monitoring 210, and can correlate the obstruction position information to different device states of the wireless device 102.

Optionally, the calibration process 208 includes antenna monitoring 212 and process monitoring 214. The antenna monitoring 212, for instance, monitors wireless signal state at different instances of the antenna modules 112, such as different signal conditions of wireless signal received at instances of the antenna modules 112. Generally, wireless signal condition can include signal strength, signal quality, and so forth. The process monitoring 214 determines different states of the process 206, such as different execution states, different functionalities accessed by the user, execution time of the process 206, and so forth.

Further to the scenario 200, results of the calibration process 208 are stored to the device data 114 as part of device states 216 that include data describing different device states that occur in relation to (e.g., during) the calibration process 208. In this example, the device states 216 include user identifier (ID) 218, process identifier (ID) 220, and obstruction states 222. The user ID 218 identifies a user associated with the wireless device 102, such as a user that is authenticated with the wireless device 102 during the calibration process, and/or a user that is identified as interacting with wireless device 102 during the calibration process. For instance, sensor data 122 from the sensor system 110 can be utilized to identify a particular user, such as based on biometric attributes that are detected and correlated to the user ID 218. The process ID 220 identifies a process 124 involved in the calibration process 208, which in this example is the process 206.

The obstruction states 222 include results of the obstruction monitoring 210, and generally describe different obstruction positions of the wireless device 102 that occurred as part of the calibration process 208. The obstruction states 222, for example, can describe different obstruction patterns (e.g., collections of points) on the wireless device 102 that were in contact with a user as part of the calibration process, time duration of each obstruction pattern, timestamps for each obstruction pattern, and so forth.

Optionally, the device states 216 include antenna states 224 and process states 226. The antenna states 224 describe different wireless signal conditions observed as part of the antenna monitoring 212, such as signal strength and/or signal quality observed at different points during the calibration process 208. The process states 226 identify different states of the process 206 that are identified as part of the process monitoring. For example, the process states 226 can identify a time of day at which the process 206 was launched, a duration of execution of the process 206 (e.g., a

lapsed time between process launch and process termination), how frequently the user interacted with the process, which functionality of the process was accessed, and so forth.

In at least some implementations, the various states described in the device states **216** can be correlated with one another to indicate relationships between the different states. For instance, a change in a process state **226** may be correlated with a change in an obstruction state **222**, or vice-versa. This is presented as but one example, and it is to be appreciated that various interrelationships between the different states can be identified and utilized further to the techniques described herein.

In at least some implementations, the calibration process **208** may iterate for a period of time and may terminate based on an occurrence of a termination event, such as a calibration timer elapsing, termination of the process **206**, the connectivity module **108** determining that a threshold number of data points (e.g., different device states **216**) have been collected, the connectivity module **108** determining that an obstruction position of the wireless device **102** has not changed for a threshold period of time, and so forth. Thus, the device states **216** may be dynamically updated during the calibration process to provide a robust data set that is stored and used for optimizing wireless performance of the wireless device **102** in different scenarios. Consider now a discussion of some example device states.

FIG. 3 depicts a scenario **300** for identifying different device states for calibrating the wireless device **102**. In the scenario **300**, a user interacts with the wireless device **102** while the calibration process **208** is active. The user, for instance, launches the process **206**, which generates a calibration event **202** to initiate the calibration process **208**. The user interacts with the process **206** via the wireless device **102**, such as by providing input to the wireless device **102** to access functionality of the process **206**. Further, during interaction with the process **206**, the user holds the wireless device **102** with a grip **302** of their hand **304**.

Accordingly, the connectivity module **108** performs the various state monitoring described above. For instance, the obstruction monitoring **210** identifies portions of the wireless device **102** that are occluded by (e.g., in contact with and/or in proximity to) the grip **302**. The sensor system **110**, for example, utilizes the sensors **120** to identify which regions of the wireless device **102** are occluded by the user's hand **304**. Generally, this can involve various types of sensors **120**, such as a capacitive sensor, pressure sensor, a temperature sensor, an optical sensor, and so forth. Accordingly, the sensor system detects that the grip **302** occludes regions **306a**, **306b**, and **306c** of the wireless device **102**. The occluded regions **306a**, **306b**, for instance, are on a front surface and/or side edge of the wireless device **102**, and the occluded region **306c** is on a rear surface of the wireless device **102**. For example, the occluded region **306a** represents a portion of the wireless device **102** occluded by the user's fingertips, the occluded region **306b** is occluded by the user's thumb, and the occluded region **306c** is occluded by the palm of the user's hand **304**. These are presented for purpose of example only, and it is to be appreciated that various objects may be detected as occluding portions of the wireless device **102**, such as a user's face (e.g., in a phone call scenario), an external object such as a desk, a phone holder (e.g., in a vehicle), and so forth.

FIG. 4 depicts a scenario **400** for generating an occlusion pattern as part of a calibration process. The scenario **400**, for instance, is performed in conjunction with the scenario **300** and as part of the calibration process **208**. In the scenario

400, based on identification of the occluded regions **306a-306c**, an occlusion pattern **402** is generated. Generally the occlusion pattern **402** includes a front pattern **404** and a rear pattern **406**, which include a front mapping **408** and a rear mapping **410** of the wireless device **102**, respectively. The front mapping **408** is a data representation of a front surface of the wireless device **102**, such as a coordinate map that describes the physical bounds of the front surface. Further, the rear mapping **410** is a data representation of a rear surface of the wireless device **102**, such as a coordinate map that describes the physical bounds of the rear surface.

The front pattern **404** identifies the occluded regions **306a**, **306b** relative to the front mapping **408**, and the rear mapping identifies the occluded region **306c** relative to the rear mapping **410**. Further, and as depicted in the scenario **400**, the front mapping **408** and the rear mapping **410** describe relative positions of the antenna modules **112a-112d** on the wireless device **102**. In this way, the occlusion pattern **402** can indicate whether any of the antenna modules are occluded, and a relative amount of occlusion. In this example, the front pattern indicates that the antenna module **112d** is likely occluded by the occluded region **306a**. Further, the antenna module **112c** may be partially or fully occluded by the occluded region **306c**. The antenna modules **112b**, **112d** may be partially occluded by the occluded region **306c**, and the antenna module **112a** may be free from obstruction, e.g., non-occluded.

Thus, the occlusion pattern **402** describes different physical regions of the wireless device **102** and antenna modules **112** that are occluded by the grip **302**, and antenna modules **112** that are likely occluded, partially occluded, or non-occluded. The occlusion pattern **402** is accordingly identified as an obstruction state **412** of the wireless device as part of the calibration process **208**, which represents an example implementation of the obstruction states **222**.

FIG. 5 depicts a scenario **500** for determining antenna state as part of a calibration process. The scenario **500**, for instance, is optionally performed in conjunction with the scenarios **300**, **400** and as part of the calibration process **208**. In the scenario **500**, antenna state of the different antenna modules **112** is determined, such as part of the antenna monitoring **212**. The connectivity module **108**, for instance, monitors wireless signal condition at each of the antenna modules **112**. The connectivity module **108** then defines the antenna states **502** based on signal condition observed at each of the antenna modules **112**. The connectivity module **108**, for example, defines a separate antenna state **502a-502d** for each of the antenna modules **112**, and each antenna state **502a-502d** describes wireless signal condition observed at each of the antenna modules **112** as part of the calibration process **208**.

Generally, an antenna state **502** at a particular antenna module **112** can describe wireless signal condition in various ways. For instance, wireless signal condition can be described quantitatively across the calibration process **208**, such as wireless signal strength (e.g., RSSI, dBm) and/or wireless signal quality (e.g., S/N ratio) observed at various time steps during the calibration process **208**. Additionally or alternatively, wireless signal condition can be described qualitatively, such as by comparing observed signal condition to a signal threshold that is defined based on signal strength and/or signal quality. For instance, an antenna state **502** for an antenna module **112** that meets the signal threshold for the calibration process **208** can be indicated as "good," wherein as an antenna state for an antenna module **112** that is below the signal threshold can be indicated as "poor." In at least one implementation, observed wireless

signal condition of an antenna module **112** can be averaged over the time span of the calibration process **208** to define the antenna module's overall antenna state **502** for the calibration process. Thus, the antenna state **502** describes wireless signal condition observed at each antenna module **112** over the calibration process **208**.

For example, with the wireless device **102** held in the grip **302**, the antenna module **112a** may be free of occlusion and thus may exhibit good wireless performance. Thus, the antenna state **502a** may indicate a good wireless condition. However, in the grip **302**, the antenna module **112d** may be occluded by the user's thumb and thus may exhibit poor wireless performance. Accordingly, this performance attribute of the antenna module **112d** may be reflected in the antenna state **502d**.

In conjunction with the obstruction monitoring **210** and the antenna monitoring described above, the process monitoring **214** may also be performed to generate process state **504**. Accordingly this various state information combines to provide an overall indication of the device states **216** for the wireless device **102** that occur as part of (e.g., during) the calibration process **208**.

In some scenarios, during a calibration process, a user may switch their grip on a device being calibrated. For instance, FIG. **6** depicts a scenario **600** for detecting a grip change during a calibration process. The scenario **600**, for instance, represents a continuation of the scenarios **300-500**, and may occur while the calibration process **208** described in those scenarios is still active. In the scenario **600**, the user switches from the grip **302** to a grip **602** of the wireless device **102** while the process **206** remains active. As illustrated, the grip **602** involves the user grasping the wireless device **102** with two hands **304a**, **304b**. Accordingly, the sensor system **110** identifies regions of the wireless device **102** that are occluded by the grip **602** of the user's hands **304a**, **304b**. The sensor system **110**, for instance, detects occluded regions **604a**, **604b** on the front surface of the wireless device **102**, and occluded regions **604c**, **604d** on the rear surface of the wireless device **102**. The sensor system **110** notifies the connectivity module **108** of the occluded regions **604a-604d**, such as via a push and/or pull notification. Accordingly, the connectivity module **108** generates an occlusion pattern **606** that describes the occluded regions **604a-604d** relative to the wireless device **102**, e.g., front and rear surfaces of the wireless device **102**. Further, the occlusion pattern **606** may also indicate whether any of the antenna modules **112** are likely occluded and if so, which antenna modules. Generally, the occlusion pattern **606** may be generated and implemented similarly to the occlusion pattern **402**, discussed above.

FIG. **7** depicts a scenario **700** for incorporating a change in obstruction state into a calibration process. The scenario **700**, for instance, represents a continuation of the scenarios **300-700**. In the scenario **700**, the connectivity module **108** identifies the occlusion pattern **606** as an obstruction state **702** of the wireless device **102** as part of the calibration process **208**. Optionally, the connectivity module **108** performs further antenna monitoring **212** to ascertain antenna state **704** of the antenna modules **112** while the wireless device **102** is held via the grip **602**, e.g., the obstruction state **702**. The antenna state **704**, for instance, describes wireless signal conditions at the individual antenna modules **112**. For instance, the change from the grip **302** to the grip **602** may alter performance characteristics of an antenna module **112**. An antenna module **112** that was previously occluded by the grip **302** (e.g., the antenna module **112d**) may no longer be occluded by the grip **602**, and thus may exhibit a better

wireless signal condition in the grip **302**. Further, an antenna module **112** that previously exhibited good wireless signal condition in the grip **302** (e.g., the antenna module **112a**) may now be occluded by the grip **602**, and thus may exhibit decreased (e.g. poor) wireless signal condition. In at least some implementations, process monitoring **214** may be performed to ascertain a process state **706** while the wireless device **102** is held via the grip **602**.

While the example obstruction states presented above are discussed in the context of a user gripping the wireless device **102**, it is to be appreciated that the described techniques may also be employed to detect a wide variety of other obstruction states and to perform antenna configuration for the different obstruction states, such as when a wireless device is placed on a user's lap, when a wireless device is placed into a phone holder (e.g., for hands free operation in a vehicle), when a wireless device is placed on a piece of furniture (e.g., on a desk), and so forth.

FIG. **8** depicts a scenario **800** for generating a representation of device state ascertained as part of a calibration process. The scenario **800**, for instance, occurs in conjunction with the scenarios **300-800**. In the scenario **800**, the connectivity module **108** aggregates the various state information generated as part of the monitoring activities described above into a device state **802**, which is based on the user ID **218** and the process ID **220** involved in the calibration process **208** described above. Further, the device state **802** includes different state records **804** that are based on different states observed as part of the calibration process **208**. A state record **804a**, for instance, is based on the obstruction state **412**, and includes the antenna state **502** and the process state **504**. Further, a state record **804b** is based on the obstruction state **702**, and includes the antenna state **704** and the process state **706**. While two different state records **804** are depicted in the scenario **800**, it is to be appreciated that any number of state records may occur during a calibration process, such as more or less than two.

Each of the state records **804** include a respective state duration **806**, which represents a time value indicating how long each state record **804** occurred as part of the calibration process **208**. For instance, a state during **806a** of the state record **804a** indicates a duration of time that the obstruction state **412** occurred as part of the calibration process, and a state duration **806b** indicates a duration of time that the obstruction state **702** occurred as part of the calibration process. The state durations **806a**, **806b**, for example, indicate durations of time the user grasped the wireless device **102** via the grips **302**, **602**, respectively. In an implementation where a user changes grip multiple times over a calibration process **208** such that a particular instance of an obstruction state occurs multiple different times over the calibration process, a state duration **806** for the obstruction state can be determined as a cumulative total time duration that the obstruction state occurred as part of the calibration process.

Each of the state records **804** further includes a confidence score **808**, which indicates a confidence that a respective state record **804** is a primary interaction, e.g., for the user ID **218** and the process ID **220**. In at least one implementation, a confidence score **808** for a particular state record **804** is calculated based on a respective state duration **806**. For instance, consider a first scenario where the calibration process **208** proceeds for a calibration period of 5 minutes. Further, the state duration **806a** for the state record **804a** over the calibration period is 30 seconds, and the state duration **806b** for the state record **804b** is 4 minutes, 30 seconds. Accordingly, the confidence score **808b** for the

state record **804b** may be high (e.g., 0.9), whereas the confidence score **808a** for the state record **804a** may be lower, e.g., 0.1. In at least one implementation, this indicates that the state record **804b** is a primary interaction state.

Consider another example where, for a same duration of calibration period, the state duration **806a** for the state record **804a** over the calibration period is 2 minutes, 20 seconds, and the state duration **806b** for the state record **804b** is 2 minutes, 40 seconds. Accordingly, the confidence scores **808a**, **808b** may be similar and may be low, e.g., 0.54 and 0.56, respectively. Since the confidence scores **808a**, **808b** are low and/or are similar, neither state record **804a**, **804b** may be identified as a primary interaction state.

In an implementation where a confidence score **808** for a particular state record **804** exceeds a threshold confidence score, and/or where the confidence score **808** exceeds a threshold difference between confidence scores for other state records **804**, the particular state record **804** can be designated by the connectivity module **108** as a primary interaction state **810**. The primary interaction state **808**, for instance, is based on a state record **804** that occurs most frequently for the user ID **218** and the process ID **220**.

FIG. 9 depicts an example implementation of the state database **130**, which stores different device states **216** including the device state **802** detailed above. Generally, each device state **130** corresponds to a different instance of a process ID **220** and/or a user ID **218**, and thus can be used to configure wireless connectivity of a device based on matching a current user ID and/or process ID of the device to a corresponding device state **216**. For instance, based on a matching device state **216**, antenna state information from the device state can be utilized to determine which antenna(s) to activate or deactivate, and which antenna(s) to optimize. Further, the state database **130** is portable and can be shared between different devices to enable wireless performance optimization across the different devices. For instance, when the calibration process **208** is performed on the wireless device **102** to generate device state(s) **216** for the state database **130**, the generated device state(s) can be shared to the connectivity service **132** and saved to the service data **134**. The connectivity service **132** can make the device state(s) **216** available to other devices, such as in response to a request from a different device for device state information. Alternatively or in addition, the wireless device **102** can directly share the device state information, such as via direct device-to-device communication with another wireless device.

FIG. 10 depicts a method **1000** for calibrating wireless performance of a wireless device. At **1002**, a calibration event pertaining to a wireless device is detected indicating that a wireless device is to be calibrated for wireless connectivity and based on a process that is active on the wireless device. The connectivity module **108**, for instance, detects that a process **124** is launched on the wireless device, such as based on a user initiating an application **126** or a system process **128**. Accordingly, the calibration process **208** is initiated.

At **1004**, obstruction states are identified that each identify regions of the wireless device that are occluded in a respective obstruction state. For example, the sensor system **110** detects regions of the wireless device **102** that are occluded in each obstruction state, such as regions in contact with and/or obstructed by a user's grasp of the wireless device **102**. As described above, an obstruction state can correspond to an identified occlusion pattern that describes regions of a device that are occluded in the obstruction state.

At **1006**, for each of the obstruction states, a performance parameter is determined for each antenna of a set of antennas of the wireless device. Each performance parameter, for instance, is based on whether a respective antenna is at least partially occluded in a respective obstruction state. For each obstruction state, for instance, the connectivity module **108** maps occluded portions of the wireless device **102** to known locations for the antenna modules **112** to ascertain which antenna modules are likely occluded. A performance parameter can be specified in various ways, such as whether a respective antenna module **112** is partially or completely occluded, or is not occluded, e.g., is free of obstruction. Alternatively or in addition, a performance parameter can be specified as an antenna quality descriptor that describes an estimated signal quality of a respective antenna module **112**. For instance, if a particular antenna module **112** is determined to be occluded in an obstruction state, a performance parameter for the particular antenna module can be specified as "poor." If a particular antenna module **112** is determined to be partially occluded, a performance parameter can be specified as "fair." Further, if a particular antenna module **112** is determined to be free from occlusion (e.g., not obstructed), a performance parameter can be specified as "good." Generally, an antenna module **112** that identified as "poor" is expected to provide low quality wireless communication, whereas an antenna module **112** identified as "good" is expected to provide good quality wireless communication.

At **1008**, a state record is generated that identifies the process, the antennas, and respective performance parameters for the antennas. For example, the connectivity module **108** generates a state record **804** that includes a process ID for the process, identifiers for individual antennas of the set of antenna modules **112**, and a performance parameter for each antenna module. In at least one implementation, the state record **804** also includes a user ID **218** for a user involved in the calibration process.

As mentioned above, multiple state records **804** may be generated as part of a calibration process **208**, such as when a user switches a grip of the wireless device **102** during the calibration process. Accordingly, each state record can be assigned a confidence score that indicates a relative confidence that a respective state record represents a primary interaction state for the wireless device **102**. As discussed above, a confidence score for a state record may be calculated based on a time duration of an obstruction state associated with the state record, e.g., interaction state. In at least one implementation, a state record **804** with a highest confidence score is designated as a primary state record for the process, and for a particular user ID **218** that interacts with the process.

At **1010**, the state record is caused to be available for configuring the set of antennas of the wireless device. The connectivity module **108**, for instance, stores a state record **804** in the state database **130** for use in configuring the antenna modules **112** for wireless communication, such as when the process **124** identified by the state record **804** is subsequently launched on the wireless device **102**. Generally, the state database **130** stores multiple different instances of state records that are associated with a different process but that may each be associated with a common user ID **218** such that the state records describe how an individual user interacts with different instances of processes **124**. Further, the state database **130** may store device states **216** across multiple different user IDs **218** such that ways in which different users interact with different processes can be iden-

13

tified as utilized to configure operation of antenna modules **112** based on which user is currently involved, and which process is currently active.

FIG. **11** depicts a method **1100** for configuring antennas of a wireless device. At **1102**, based on a process that is active on a wireless device, an optimization event is detected indicating that a set of antennas of the wireless device are to be optimized for wireless communication. The connectivity module **108**, for instance, detects that an instance of a process **124** is launched on the wireless device **102**, and/or that wireless connectivity of the wireless device **102** is to be optimized based on a process that is active on the wireless device **102**. Generally, an “active” process may refer to a process that is scheduled to be executed, a process that is initializing execution, and/or a process that is currently executing, e.g., has at least one active thread on the wireless device **102**.

At **1104**, a state record is accessed that identifies the process and that specifies a performance parameter for each antenna. For example, the connectivity module **108** searches the state database **130** using a process ID **220** for the process to identify a state record **804** that includes the process ID **220**. In at least one implementation, in addition to the process ID **220**, the connectivity module **108** may also search using a user ID **218**, such as for a user associated with the wireless device **102**. A state record is identified that corresponds to the process ID and/or the user ID, and antenna performance parameters are identified from the state record.

At **1106**, an antenna is configured based on a respective performance parameter. For instance an antenna is activated based on its respective performance parameter, or an antenna is deactivated based on its respective performance parameter. Consider, for instance, that a performance parameter for a particular antenna module **112** indicates that the antenna module is “good” according to the current state record. Accordingly, the particular antenna module **112** can be activated. If that particular antenna module is determined to be already active, the antenna module is left active. Consider another example where a performance parameter for a particular antenna module **112** indicates that the antenna module is “poor” according to the identified state record. Accordingly, the particular antenna module can be deactivated, e.g., turned off or left inactive if already inactive. For a set of multiple antenna modules **112**, each antenna module can be configured based on its respective performance parameter.

FIG. **12** depicts a method **1200** for configuring antennas of a wireless device. At **1202**, an indication is received that antennas of a wireless device are to be optimized based on a process. The connectivity module **108**, for instance, determines that a process **124** is active on the wireless device **102**, such as based on a process launch event or other indication of a process. In at least one implementation, antenna optimization may occur as a background process while the subject process is executing. Generally, this may occur to refresh optimization values in the state database **130** from time-to-time to account for possible user behavior changes (e.g., if a user adopts a different way of grasping the wireless device **102**), and/or if the confidence scores are not high enough to make a decision on antenna configuration.

At **1204**, it is determined whether a state record for the process is available. For example, the connectivity module **108** searches the state database **130** for a state record **804** using a process ID **220** for the process, and/or a user ID **218** for a user associated with the wireless device **102**. If a state record for the process is not available (“No”), at **1206** a

14

calibration process is implemented to calibrate antennas of the wireless device based on the process. The calibration processes described above, for instance, are performed, such as described with reference to the method **1000**.

If a state record for the process is available, at **1208** it is determined if a confidence score for the state record meets a threshold confidence value. The connectivity module **108**, for instance, compares a confidence score for an identified state record to a threshold confidence value. The threshold confidence value, for instance, is predefined prior to initiating device calibration and/or antenna optimization. Different ways for generating confidence scores are described above. If the confidence score for the state record meets the threshold confidence value (“Yes”), at **1210** antennas of the wireless device are configured based on performance parameters specified by the state record. The connectivity module **108**, for instance, identifies a performance parameter in the state record, and configures an antenna module **112** based on the performance parameter. As described above, for instance, the connectivity module **108** can activate or deactivate an antenna module **112** based on whether a respective performance parameter indicates that the antenna module has a “poor” estimated signal condition, or a “good” or “fair” estimated signal condition. In at least one implementation, step **1210** implements the method **1100** for configuring a set of antennas of a wireless device using information in the state record.

If the confidence score for the state record does not meet the threshold confidence value (“No”), the method proceeds to **1206** where a calibration process is implemented to calibrate antennas of the wireless device based on the process. In at least one implementation, this represents a recalibration of the wireless device for the process, such as where a previous calibration process did not result in a state record with a sufficient reliable confidence value. Based on the calibration process, a new state record is generated for the process, or a previously generated state record with a low confidence score is updated. The state record may then be utilized to configure antennas of the wireless device, such as described above.

FIG. **13** depicts a method **1300** for configuring antennas of a wireless device. At **1302**, an indication is received to optimize antennas of a wireless device for a process. The connectivity module **108**, for instance, detects an optimization event, such as based on launch of a process **124** on the wireless device **102**. At **1304**, it is determined whether a state record associated with the process identifies an antenna that meets a performance parameter threshold. For example, the connectivity module **108** locates a state record **804** that correlates with the process (e.g., based on a matching process ID **220**), and determines whether the state record identifies any antennas that meet a performance parameter threshold. For instance, a performance parameter threshold can be defined as antennas that are identified as “good” or “fair,” such as based on the calibration processes described above. Alternatively or in addition, a performance parameter threshold can be defined based on relative occlusion of antennas based on an obstruction state, such as antennas that are free from occlusion or only partially occluded.

If the state record does not identify an antenna that meets the performance parameter threshold (“No”), at **1306** the optimization process terminates. In at least one implementation, based on termination of the optimization process, a default device behavior can be implemented for adapting antenna performance, such as a reactive behavior that monitors wireless performance of antennas and adapts antennas to compensate for observed changes in antenna perfor-

mance. Alternatively or additionally, a recalibration process can be performed, such as described above.

If the state record identifies an antenna that meets the performance parameter threshold (“Yes”), at **1308** the identified antenna is caused to be active. Generally, this includes activating the antenna module **112** if the antenna module is not currently active, or maintaining the antenna module as active if its already active.

At **1310**, it is determined whether the state record identifies an antenna that is below the performance parameter threshold. The connectivity module **108**, for instance, determines whether the identified state record **804** identifies an antenna with a performance parameter below the threshold, such as an antenna that is indicated as having a poor estimated signal condition, and/or an antenna that is identified as being occluded. If the state record does not identify an antenna that is below the performance parameter threshold (“No”), the method proceeds to **1306** where the optimization process terminates.

If the state record identifies an antenna that is below the performance parameter threshold (“Yes”), at **1312** it is determined whether a current signal condition of the antenna meets a signal condition threshold. Generally, a signal condition threshold can be defined in various ways, such as a threshold signal strength, a threshold signal quality, and so forth. Accordingly, the connectivity module **108** can determine a current signal condition of the antenna module **112**, (e.g., current signal strength, signal quality, and so forth) and compare the current signal condition to the signal condition threshold. If the current signal condition of the antenna meets the signal condition threshold (“Yes”), at **1314** the antenna is maintained in an active state. For instance, if the identified antenna module **112** is active, it is maintained in an active state. The method may then proceed to **1306** where the optimization process terminates.

If the current signal condition of the antenna does not meet the signal condition threshold (“No”), at **1316** the antenna is maintained in an inactive state. For instance, if the identified antenna module **112** is active, it is deactivated. The method may then proceed to **1306** where the optimization process terminates.

Thus, implementations of process based antenna configuration include ways for utilizing different usage states (e.g., device obstruction state) to make decisions regarding wireless connectivity.

The example methods described above may be performed in various ways, such as for implementing different aspects of the systems and scenarios described herein. Generally, any services, components, modules, methods, and/or operations described herein can be implemented using software, firmware, hardware (e.g., fixed logic circuitry), manual processing, or any combination thereof. Some operations of the example methods may be described in the general context of executable instructions stored on computer-readable storage memory that is local and/or remote to a computer processing system, and implementations can include software applications, programs, functions, and the like. Alternatively or in addition, any of the functionality described herein can be performed, at least in part, by one or more hardware logic components, such as, and without limitation, Field-programmable Gate Arrays (FPGAs), Application-specific Integrated Circuits (ASICs), Application-specific Standard Products (ASSPs), System-on-a-chip systems (SoCs), Complex Programmable Logic Devices (CPLDs), and the like. The order in which the methods are described is not intended to be construed as a limitation, and

any number or combination of the described method operations can be performed in any order to perform a method, or an alternate method.

FIG. **14** illustrates various components of an example device **1400** in which aspects of process based antenna configuration can be implemented. The example device **1400** can be implemented as any of the devices described with reference to the previous FIGS. **1-13**, such as any type of wireless device, mobile phone, mobile device, wearable device, tablet, computing, communication, entertainment, gaming, media playback, and/or other type of electronic device. For example, the wireless device **102** as shown and described with reference to FIGS. **1-13** may be implemented as the example device **1400**. In a wearable device implementation, the device may include any one or combination of a watch, armband, wristband, bracelet, glove or pair of gloves, glasses, jewelry items, clothing items, any type of footwear or headwear, and/or other types of wearables.

The device **1400** includes communication transceivers **1402** that enable wired and/or wireless communication of data **1404** with other devices. The data **1404** can include any of device identifying data, device location data, wireless connectivity data, and wireless protocol data. Additionally, the data **1404** can include any type of audio, video, and/or image data. Example communication transceivers **1402** include wireless personal area network (WPAN) radios compliant with various IEEE 1402.15 (Bluetooth™) standards, wireless local area network (WLAN) radios compliant with any of the various IEEE 1402.11 (Wi-Fi™) standards, wireless wide area network (WWAN) radios for cellular phone communication, wireless metropolitan area network (WMAN) radios compliant with various IEEE 1402.16 (WiMAX™) standards, and wired local area network (LAN) Ethernet transceivers for network data communication.

The device **1400** may also include one or more data input ports **1406** via which any type of data, media content, and/or inputs can be received, such as user-selectable inputs to the device, messages, music, television content, recorded content, and any other type of audio, video, and/or image data received from any content and/or data source. The data input ports may include USB ports, coaxial cable ports, and other serial or parallel connectors (including internal connectors) for flash memory, DVDs, CDs, and the like. These data input ports may be used to couple the device to any type of components, peripherals, or accessories such as microphones and/or cameras.

The device **1400** includes a processing system **1408** of one or more processors (e.g., any of microprocessors, controllers, and the like) and/or a processor and memory system implemented as a system-on-chip (SoC) that processes computer-executable instructions. The processor system may be implemented at least partially in hardware, which can include components of an integrated circuit or on-chip system, an application-specific integrated circuit (ASIC), a field-programmable gate array (FPGA), a complex programmable logic device (CPLD), and other implementations in silicon and/or other hardware. Alternatively or in addition, the device can be implemented with any one or combination of software, hardware, firmware, or fixed logic circuitry that is implemented in connection with processing and control circuits, which are generally identified at **1410**. The device **1400** may further include any type of a system bus or other data and command transfer system that couples the various components within the device. A system bus can include any one or combination of different bus structures and architectures, as well as control and data lines.

The device **1400** also includes computer-readable storage memory **1412** (e.g., memory devices) that enable data storage, such as data storage devices that can be accessed by a computing device, and that provide persistent storage of data and executable instructions (e.g., software applications, programs, functions, and the like). Examples of the computer-readable storage memory **1412** include volatile memory and non-volatile memory, fixed and removable media devices, and any suitable memory device or electronic data storage that maintains data for computing device access. The computer-readable storage memory can include various implementations of random access memory (RAM), read-only memory (ROM), flash memory, and other types of storage media in various memory device configurations. The device **1400** may also include a mass storage media device.

The computer-readable storage memory **1412** provides data storage mechanisms to store the data **1404**, other types of information and/or data, and various device applications **1414** (e.g., software applications). For example, an operating system **1416** can be maintained as software instructions with a memory device and executed by the processing system **1408**. The device applications may also include a device manager, such as any form of a control application, software application, signal-processing and control module, code that is native to a particular device, a hardware abstraction layer for a particular device, and so on. Computer-readable storage memory **1412** represents media and/or devices that enable persistent and/or non-transitory storage of information in contrast to mere signal transmission, carrier waves, or signals per se. Computer-readable storage memory **1412** do not include signals per se or transitory signals.

In this example, the device **1400** includes a connectivity module **1418** that implements aspects of process based antenna configuration, and may be implemented with hardware components and/or in software as one of the device applications **1414**, such as when the device **1400** is implemented as the wireless device **102**. An example, the connectivity module **1418** can be implemented as the connectivity module **108** described in detail above. In implementations, the connectivity module **1418** may include independent processing, memory, and logic components as a computing and/or electronic device integrated with the device **1400**. The device **1400** also includes device data **1420** for implementing aspects of process based antenna configuration, and may include data from the connectivity module **108**.

In this example, the example device **1400** also includes a camera **1422** and motion sensors **1424**, such as may be implemented in an inertial measurement unit (IMU). The motion sensors **1424** can be implemented with various sensors, such as a gyroscope, an accelerometer, and/or other types of motion sensors to sense motion of the device. The various motion sensors **1424** may also be implemented as components of an inertial measurement unit in the device.

The device **1400** also includes a wireless module **1426**, which is representative of functionality to perform various wireless communication tasks. For instance, for the wireless device **102**, the wireless module **1426** can be leveraged to scan for and detect wireless networks, as well as negotiate wireless connectivity to wireless networks for the wireless device **102**. The device **1400** can also include one or more power sources **1428**, such as when the device is implemented as a wireless device. The power sources **1428** may include a charging and/or power system, and can be implemented as a flexible strip battery, a rechargeable battery, a charged super-capacitor, and/or any other type of active or

passive power source. Generally, utilizing implementations of process based antenna configuration enables the power sources **1428** to be conserved as part of a wireless network connectivity process.

The device **1400** also includes an audio and/or video processing system **1430** that generates audio data for an audio system **1732** and/or generates display data for a display system **1434**. The audio system and/or the display system may include any devices that process, display, and/or otherwise render audio, video, display, and/or image data. Display data and audio signals can be communicated to an audio component and/or to a display component via an RF (radio frequency) link, S-video link, HDMI (high-definition multimedia interface), composite video link, component video link, DVI (digital video interface), analog audio connection, or other similar communication link, such as media data port **836**. In implementations, the audio system and/or the display system are integrated components of the example device. Alternatively, the audio system and/or the display system are external, peripheral components to the example device.

Although implementations of process based antenna configuration have been described in language specific to features and/or methods, the subject of the appended claims is not necessarily limited to the specific features or methods described. Rather, the features and methods are disclosed as example implementations of process based antenna configuration, and other equivalent features and methods are intended to be within the scope of the appended claims. Further, various different examples are described and it is to be appreciated that each described example can be implemented independently or in connection with one or more other described examples. Additional aspects of the techniques, features, and/or methods discussed herein relate to one or more of the following:

A method, comprising: detecting a calibration event indicating that a wireless device is to be calibrated for wireless connectivity and based on a process that resides on the wireless device; initiating calibration based on the calibration event, the calibration including: identifying one or more obstruction states that each identify one or more regions of the wireless device that are occluded in a respective obstruction state; determining, for each of the one or more obstruction states, a performance parameter for each antenna of a set of antennas of the wireless device, each performance parameter being based on whether a respective antenna is at least partially occluded in a respective obstruction state; generating a state record identifying the process, one or more of the antennas, and respective performance parameters for the one or more of the antennas; and causing the state record to be available for configuring the set of antennas of the wireless device.

Alternatively or in addition to the above described method, any one or combination of: wherein the calibration event is triggered based on detecting one or more of that the process is launched or that the process is active on the wireless device; wherein the process comprises one or more of an application or a system process of the wireless device; wherein said identifying the one or more obstruction states is based on sensor data indicating one or more regions of the wireless device that are one or more of in contact with a user or in proximity to a user; wherein a performance parameter for a particular antenna for a particular obstruction state indicates an estimated signal condition for the antenna in the particular obstruction state; wherein a performance parameter for a particular antenna for a particular obstruction state indicates an estimated signal condition for the antenna in the

particular obstruction state, and wherein the signal condition is estimated based on whether the particular antenna is at least partially occluded in the particular obstruction state; wherein said identifying the one or more obstruction states comprises identifying multiple obstruction states as part of the calibration, the method further comprising: generating, for each obstruction state, a confidence score indicating a confidence that the obstruction state is a primary interaction state for the process on the wireless device; wherein said generating a confidence score for each obstruction state is based on a respective time duration for each obstruction state; further comprising selecting a obstruction state with a highest confidence score, wherein said generating the state record comprises including, in the state record, performance parameters for the one or more of the antennas observed in conjunction with the obstruction state with the highest confidence score; wherein said generating the state record further comprises including a user identifier for a user associated with the wireless device.

A method comprising: detecting, based on a process that resides on a wireless device, an optimization event indicating that a set of antennas of the wireless device are to be optimized for wireless communication; accessing a state record that identifies the process and that specifies a performance parameter for each antenna; and configuring one or more of the antennas based on the performance parameter, including at least one of activating an antenna based on its respective performance parameter, or deactivating an antenna based on its respective performance parameter.

Alternatively or in addition to the above described method, any one or combination of: wherein said detecting the optimization event is based on an indication that the process is launched on the wireless device, the process comprising one or more of an application or a system process; wherein said accessing the state record comprises: searching a database of state records utilizing an identifier for the process; identifying the state record based on the state record including the identifier for the process; and selecting the state record based on a confidence score for the state record meeting a confidence threshold; wherein the state record indicates a poor estimated signal condition for a particular antenna, and wherein the method further comprises: measuring a current signal condition of the particular antenna; and determining whether to disable the particular antenna based on the current signal condition; further comprising: disabling the particular antenna if the current signal condition indicates a poor signal condition; or maintaining the particular antenna as active if the current signal condition indicates a good signal condition; wherein said configuring the one or more antennas is performed independent of a current observation of a signal condition of the one or more antennas; wherein the state record is generated based on a calibration process performed on a different device.

A wireless device comprising: a sensor system; a set of antennas; and a connectivity module implemented to: receive data from the sensor system describing an obstruction state that identifies one or more regions of the wireless device that are occluded while a particular process is active on the wireless device; determine for the obstruction state a performance parameter for each antenna of the set of antennas, each performance parameter being based on whether a respective antenna is at least partially occluded in the obstruction state; detecting a launch event indicating that the process is launched on the wireless device; and configuring, based on the launch event, one or more of the antennas based on a respective performance parameter for the one or more antennas.

Alternatively or in addition to the above described wireless device, any one or combination of: wherein the data from the sensor system identifies multiple obstruction states, and wherein the connectivity module is further implemented to: calculate a confidence score for each obstruction state, wherein each confidence score is indicative of a confidence that a respective obstruction state represents a primary interaction state for the particular process; and select the obstruction state based on its confidence score; wherein the data from the sensor system identifies multiple obstruction states, and wherein the connectivity module is further implemented to: calculate a confidence score for each obstruction state, wherein each confidence score is indicative of a confidence that a respective obstruction state represents a primary interaction state for the particular process; compare each confidence score to a confidence score threshold; and initiate recalibration of the wireless device based on each confidence score being below the confidence score threshold.

The invention claimed is:

1. A method comprising:

detecting, based on a process that resides on a wireless device, an optimization event indicating that a set of antennas of the wireless device are to be optimized for wireless communication;

accessing a state record that identifies the process and that specifies a performance parameter for each antenna, including:

searching a database of state records utilizing an identifier for the process;

identifying the state record based on the state record including the identifier for the process;

selecting the state record based on a confidence score for the state record meeting a confidence threshold; and

configuring one or more of the antennas based on the performance parameter, including at least one of activating an antenna based on its respective performance parameter, or deactivating an antenna based on its respective performance parameter.

2. The method as recited in claim 1, wherein said detecting the optimization event is based on an indication that the process is launched on the wireless device, the process comprising one or more of an application or a system process.

3. The method as recited in claim 1, wherein the state record indicates a poor estimated signal condition for a particular antenna, and wherein the method further comprises:

measuring a current signal condition of the particular antenna; and

determining whether to disable the particular antenna based on the current signal condition.

4. The method as recited in claim 3, further comprising: disabling the particular antenna if the current signal condition indicates a poor signal condition; or maintaining the particular antenna as active if the current signal condition indicates a good signal condition.

5. The method as recited in claim 1, wherein said configuring the one or more antennas is performed independent of a current observation of a signal condition of the one or more antennas.

6. The method as recited in claim 1, wherein the state record is generated based on a calibration process performed on a different device.

21

7. The method as recited in claim 1, further comprising generating the state record based on a calibration process that detects how a user holds the wireless device while interacting with the process.

8. A wireless device comprising:

a set of antennas; and

a connectivity module implemented to:

detect, based on a process that resides on the wireless device, an optimization event indicating that the set of antennas of the wireless device are to be optimized for wireless communication;

access a state record that identifies the process and that specifies a performance parameter for each antenna, including to:

search a database of state records utilizing an identifier for the process; and

select the state record based on the state record including the identifier for the process and based on a confidence score for the state record meeting a confidence threshold; and

configure one or more of the antennas based on the performance parameter, including at least one of to activate an antenna based on its respective performance parameter, or deactivate an antenna based on its respective performance parameter.

9. The wireless device as recited in claim 8, wherein to detect the optimization event is based on an indication that the process is launched on the wireless device, the process comprising one or more of an application or a system process.

10. The wireless device as recited in claim 8, wherein the state record indicates a poor estimated signal condition for a particular antenna, and wherein the connectivity module is further implemented to:

measure a current signal condition of the particular antenna; and

determine whether to disable the particular antenna based on the current signal condition.

11. The wireless device as recited in claim 10, wherein the connectivity module is further implemented to:

disable the particular antenna if the current signal condition indicates a poor signal condition; or

maintain the particular antenna as active if the current signal condition indicates a good signal condition.

12. The wireless device as recited in claim 8, wherein to configure the one or more antennas is performed independent of a current observation of a signal condition of the one or more antennas.

13. The wireless device as recited in claim 8, wherein the state record is generated based on a calibration process performed on a different device.

14. The wireless device as recited in claim 8, wherein the connectivity module is further implemented to generate the state record based on a calibration process that detects how a user holds the wireless device while interacting with the process.

22

15. A system comprising:

one or more processors implemented at least in part in hardware;

one or more computer-readable storage media storing instructions that are executable by the one or more processors to:

detect, based on a process that resides on a wireless device, an optimization event indicating that a set of antennas of the wireless device are to be optimized for wireless communication;

access a state record that identifies the process and that specifies a performance parameter for each antenna, including to:

search a database of state records utilizing an identifier for the process;

select the state record based on the state record including the identifier for the process and based on a confidence score for the state record meeting a confidence threshold; and

configure one or more of the antennas based on the performance parameter, including at least one of to activate an antenna based on its respective performance parameter, or deactivate an antenna based on its respective performance parameter.

16. The system as recited in claim 15, wherein to detect the optimization event is based on an indication that the process is launched on the wireless device, the process comprising one or more of an application or a system process.

17. The system as recited in claim 15, wherein the state record indicates a poor estimated signal condition for a particular antenna, and wherein the instructions are further executable by the one or more processors to:

measure a current signal condition of the particular antenna; and

determine whether to disable the particular antenna based on the current signal condition.

18. The system as recited in claim 17, wherein the instructions are further executable by the one or more processors to:

disable the particular antenna if the current signal condition indicates a poor signal condition; or

maintain the particular antenna as active if the current signal condition indicates a good signal condition.

19. The system as recited in claim 15, wherein to configure the one or more antennas is performed independent of a current observation of a signal condition of the one or more antennas.

20. The system as recited in claim 15, wherein the instructions are further executable by the one or more processors to generate the state record based on a calibration process that detects how a user holds the wireless device while interacting with the process.

* * * * *