



US011039435B2

(12) **United States Patent**
Au et al.

(10) **Patent No.:** **US 11,039,435 B2**
(45) **Date of Patent:** **Jun. 15, 2021**

(54) **SYSTEM AND METHOD FOR ADAPTIVE TRANSMISSION TIME INTERVAL (TTI) STRUCTURE**

(71) Applicant: **Huawei Technologies Co., Ltd.**,
Shenzhen (CN)
(72) Inventors: **Kelvin Kar Kin Au**, Kanata (CA);
Jianglei Ma, Ottawa (CA); **Liqing Zhang**,
Ottawa (CA); **Zhihang Yi**, Ottawa (CA); **Hosein Nikopour**, San
Jose, CA (US)

(73) Assignee: **Huawei Technologies Co., Ltd.**,
Shenzhen (CN)

(*) Notice: Subject to any disclaimer, the term of this
patent is extended or adjusted under 35
U.S.C. 154(b) by 50 days.

(21) Appl. No.: **16/191,999**

(22) Filed: **Nov. 15, 2018**

(65) **Prior Publication Data**
US 2019/0090236 A1 Mar. 21, 2019

Related U.S. Application Data
(63) Continuation of application No. 15/962,001, filed on
Apr. 25, 2018, now Pat. No. 10,285,175, which is a
(Continued)

(51) **Int. Cl.**
H04W 72/04 (2009.01)
H04W 28/02 (2009.01)
H04W 88/08 (2009.01)

(52) **U.S. Cl.**
CPC ... *H04W 72/0446* (2013.01); *H04W 28/0205*
(2013.01); *H04W 72/042* (2013.01); *H04W*
88/08 (2013.01)

(58) **Field of Classification Search**
CPC *H04W 72/0446*; *H04W 72/042*; *H04W*
28/0205; *H04W 88/08*
See application file for complete search history.

(56) **References Cited**

U.S. PATENT DOCUMENTS

6,240,094 B1 * 5/2001 Schneider H04L 1/002
370/412
7,065,051 B2 6/2006 Airy et al.
(Continued)

FOREIGN PATENT DOCUMENTS

CN 101292456 A 5/2008
CN 101223720 A 7/2008
(Continued)

OTHER PUBLICATIONS

3GPP, 3rd Generation Partnership Project; Technical Specification
Group Radio Access Network; Evolved Universal Terrestrial Radio
Access (E-UTRA); Physical channels and modulation (Release 12),
3GPP TS 36.211 V12.1.0, Mar. 2014, 120 pages.
(Continued)

Primary Examiner — Hashim S Bhatti
(74) *Attorney, Agent, or Firm* — Slater Matsil, LLP

(57) **ABSTRACT**

Methods and devices are provided for communicating data
in a wireless channel. In one example, a method includes
adapting the transmission time interval (TTI) length of
transport container for transmitting data in accordance with
a criteria. The criteria may include (but is not limited to) a
latency requirement of the data, a buffer size associated with
the data, a mobility characteristic of a device that will
receive the data. The lengths may be manipulated for a
variety of reasons; such as for reducing overhead, satisfy
quality of service (QoS) requirements, maximize network
throughput, etc. In some embodiments, TTIs having differ-
ent TTI lengths may be carried in a common radio frame. In
other embodiments, the wireless channel may partitioned
into multiple bands each of which carrying (exclusively or
otherwise) TTIs having a certain TTI length.

39 Claims, 10 Drawing Sheets

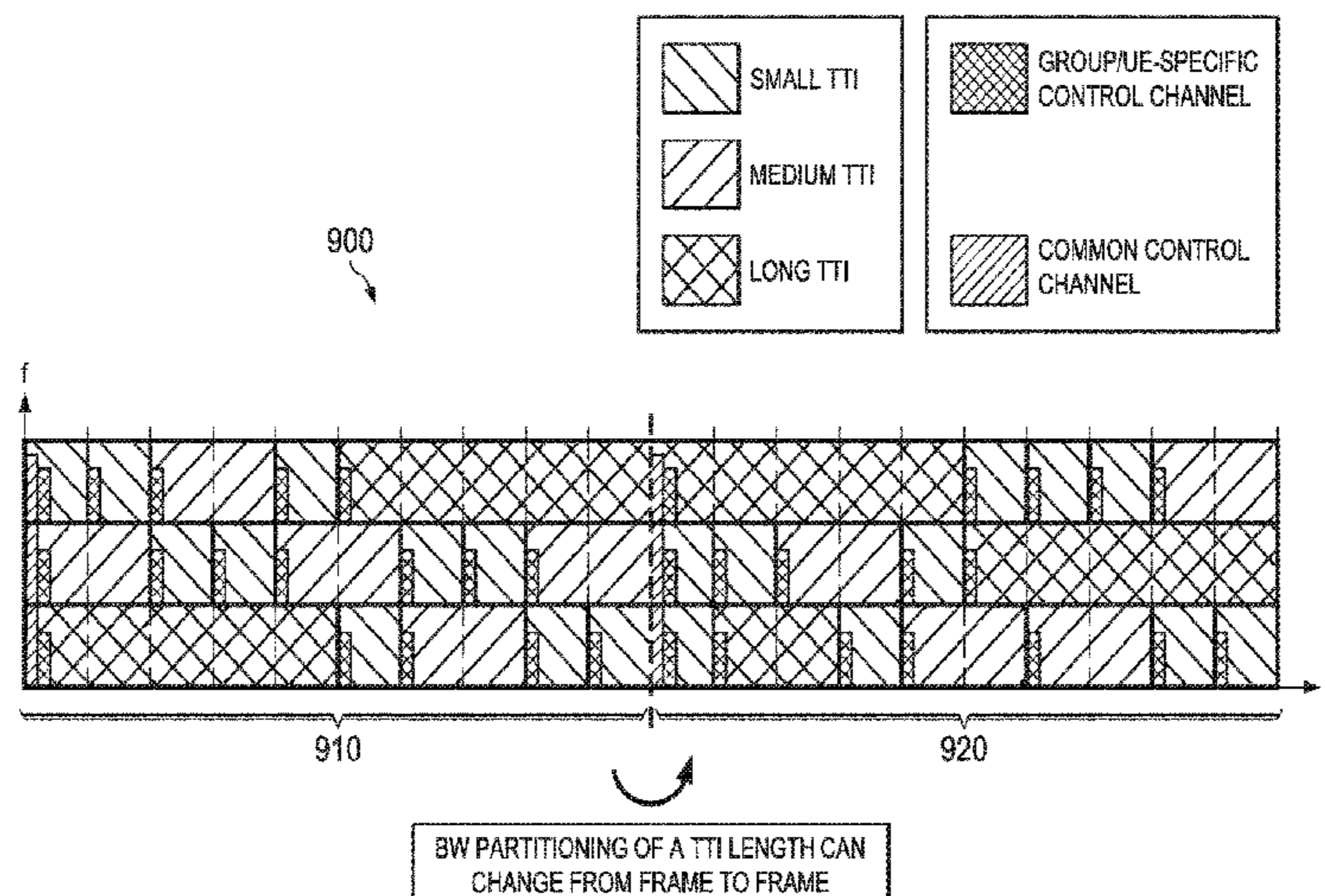

Related U.S. Application Data

continuation of application No. 15/648,186, filed on Jul. 12, 2017, now Pat. No. 10,582,494, which is a continuation of application No. 14/823,873, filed on Aug. 11, 2015, now Pat. No. 9,743,403, which is a continuation of application No. 13/611,823, filed on Sep. 12, 2012, now Pat. No. 9,131,498.

| | | | |
|--------------|-----|---------|-----------------------------------|
| 2012/0063294 | A1 | 3/2012 | Osterling et al. |
| 2012/0135773 | A1 | 5/2012 | Shen et al. |
| 2012/0230320 | A1 | 9/2012 | Kishiyama et al. |
| 2012/0281646 | A1* | 11/2012 | Liao H04W 72/042 370/329 |
| 2013/0016655 | A1 | 1/2013 | Heo et al. |
| 2013/0142138 | A1 | 6/2013 | Dinan |
| 2013/0322277 | A1 | 12/2013 | Vanganuru et al. |
| 2014/0016586 | A1* | 1/2014 | Khan H04L 1/0003 370/329 |
| 2014/0071954 | A1 | 3/2014 | Au et al. |

(56)

References Cited

U.S. PATENT DOCUMENTS

| | | | |
|--------------|-----|---------|--|
| 2004/0228315 | A1 | 11/2004 | Malkamaki |
| 2007/0047485 | A1* | 3/2007 | Gorokhov H04W 72/1231 370/329 |
| 2007/0245201 | A1 | 10/2007 | Sammour et al. |
| 2008/0080465 | A1* | 4/2008 | Pajukoski H04L 1/003 370/342 |
| 2008/0225802 | A1 | 9/2008 | Sun et al. |
| 2008/0310385 | A1 | 12/2008 | Iochi et al. |
| 2009/0034474 | A1 | 2/2009 | Yavuz et al. |
| 2009/0103447 | A1* | 4/2009 | Harada H04W 28/06 370/252 |
| 2009/0175245 | A1 | 7/2009 | Harada et al. |
| 2009/0245186 | A1* | 10/2009 | Klein H04L 1/1607 370/329 |
| 2009/0245190 | A1 | 10/2009 | Higuchi et al. |
| 2009/0258647 | A1 | 10/2009 | Yamada et al. |
| 2009/0316811 | A1 | 12/2009 | Maeda et al. |
| 2010/0046451 | A1 | 2/2010 | Tada et al. |
| 2010/0098020 | A1 | 4/2010 | Kim et al. |
| 2010/0226389 | A1 | 9/2010 | Cho et al. |
| 2010/0303045 | A1 | 12/2010 | Venkob et al. |
| 2010/0322229 | A1 | 12/2010 | Kim et al. |
| 2011/0216730 | A1 | 9/2011 | Kim et al. |

FOREIGN PATENT DOCUMENTS

| | | | |
|----|------------|----|---------|
| CN | 101292456 | A | 10/2008 |
| CN | 101572905 | A | 11/2009 |
| CN | 101999247 | A | 3/2011 |
| CN | 102523082 | A | 6/2012 |
| EP | 1328087 | A1 | 7/2003 |
| EP | 1898542 | A1 | 3/2008 |
| EP | 2268075 | A | 12/2010 |
| EP | 2268075 | A1 | 12/2010 |
| EP | 1938493 | B1 | 10/2014 |
| WO | 2009035280 | A2 | 3/2009 |
| WO | 2012113728 | A1 | 8/2012 |

OTHER PUBLICATIONS

NTT Docomo, Inc., "Variable TTI Length Control," 3GPP TSG RAN WG2 Ad Hoc on LTE, Draft: R2-061921, Jun. 27-30, 2006, Cannes, France, 3 pages.
 Motorola, "System Simulation Results with non-static TTI", 3GPP TSG RAN1 LTE Ad Hoc, R1-061715, Jun. 27-30, 2006, 8 Pages, Cannes, France.

* cited by examiner

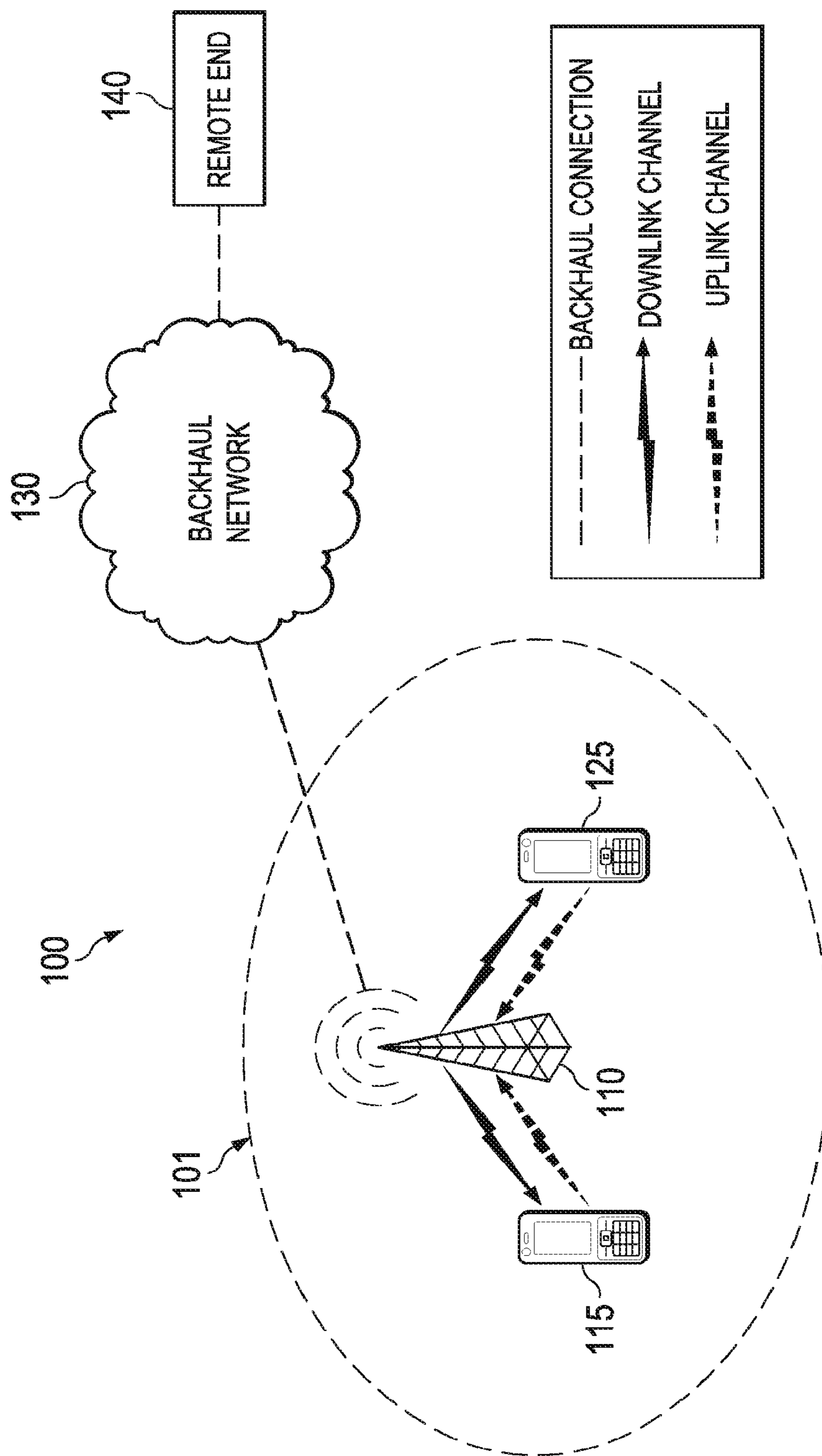
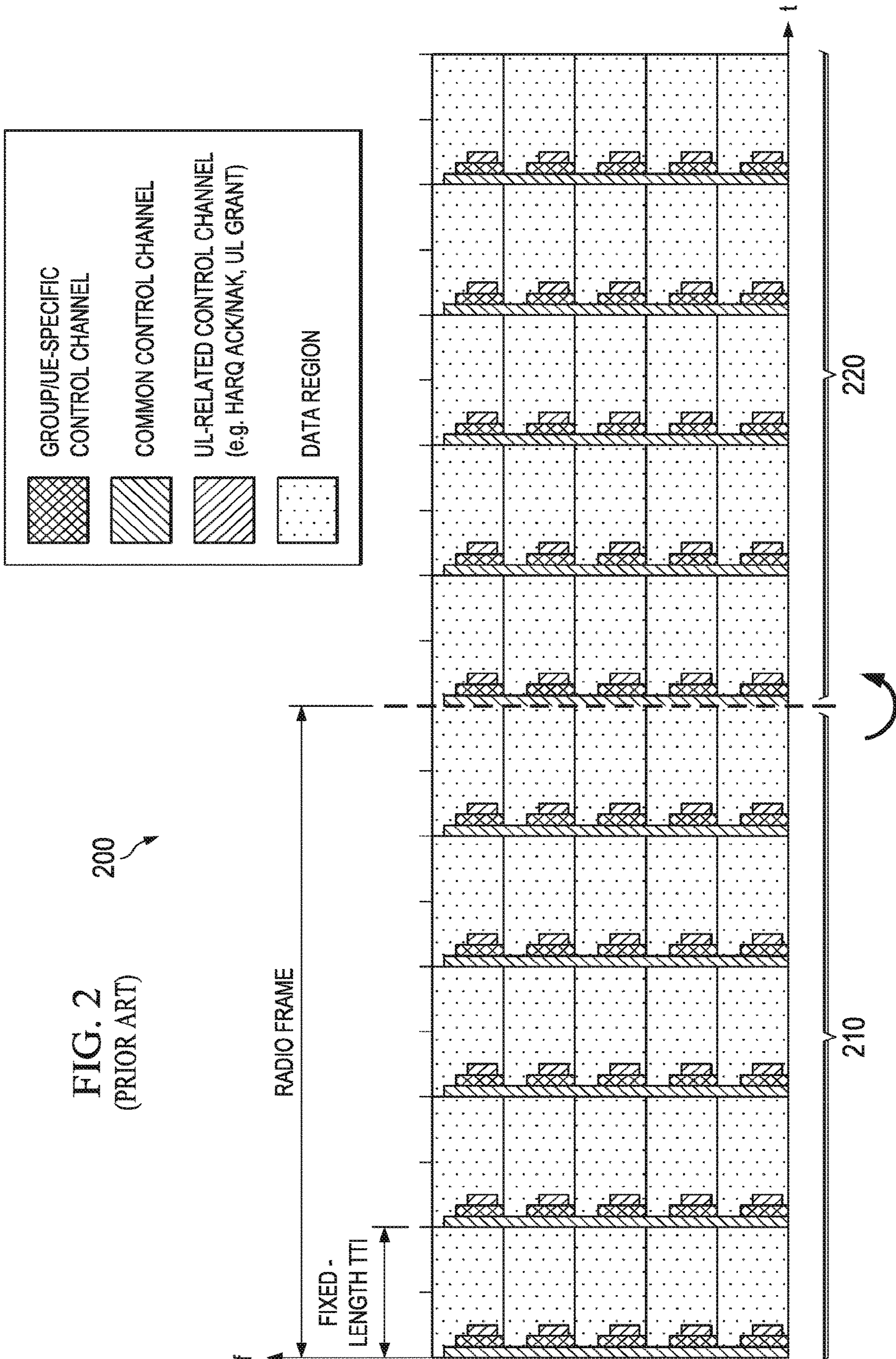
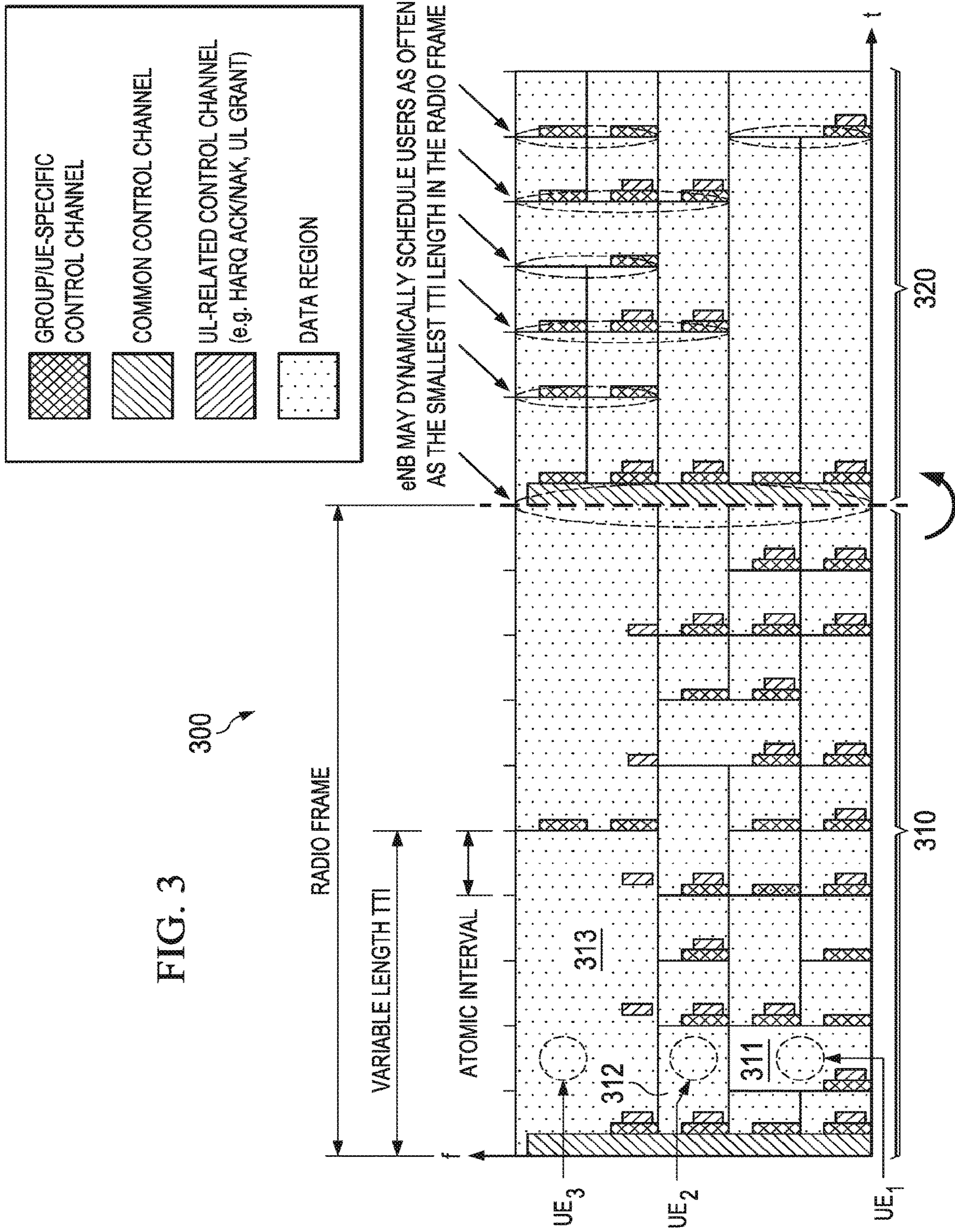

FIG. 1





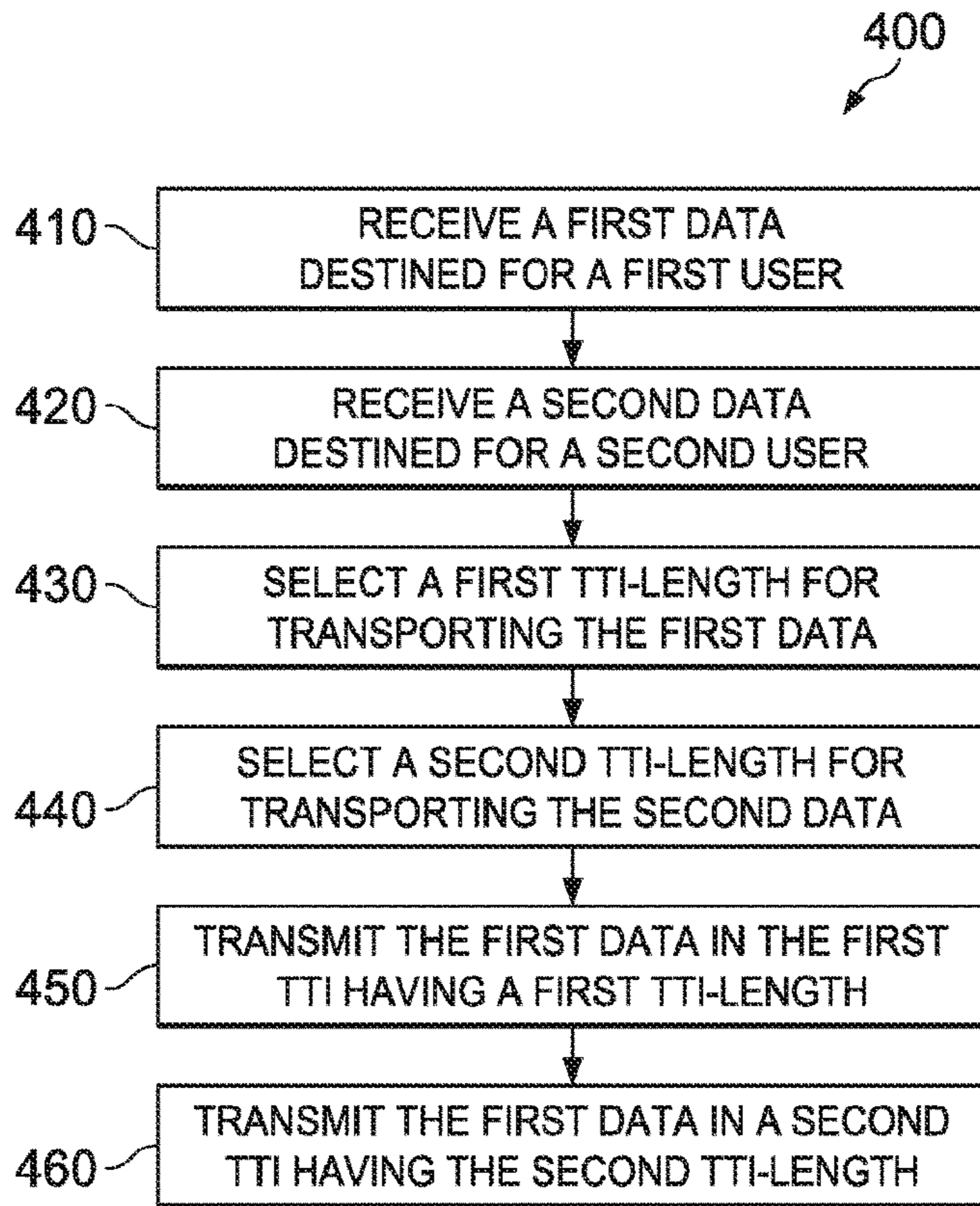

FIG. 4

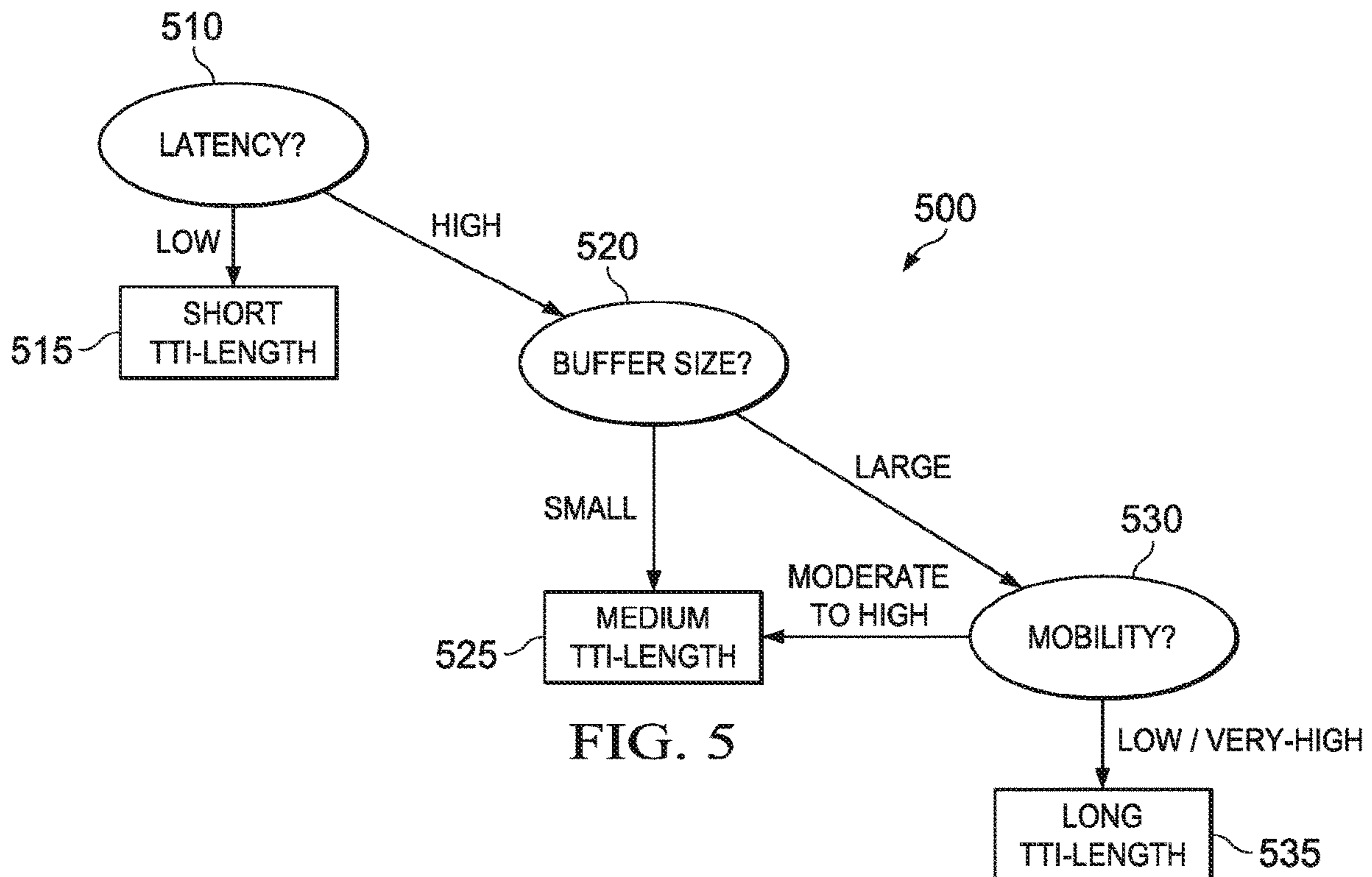
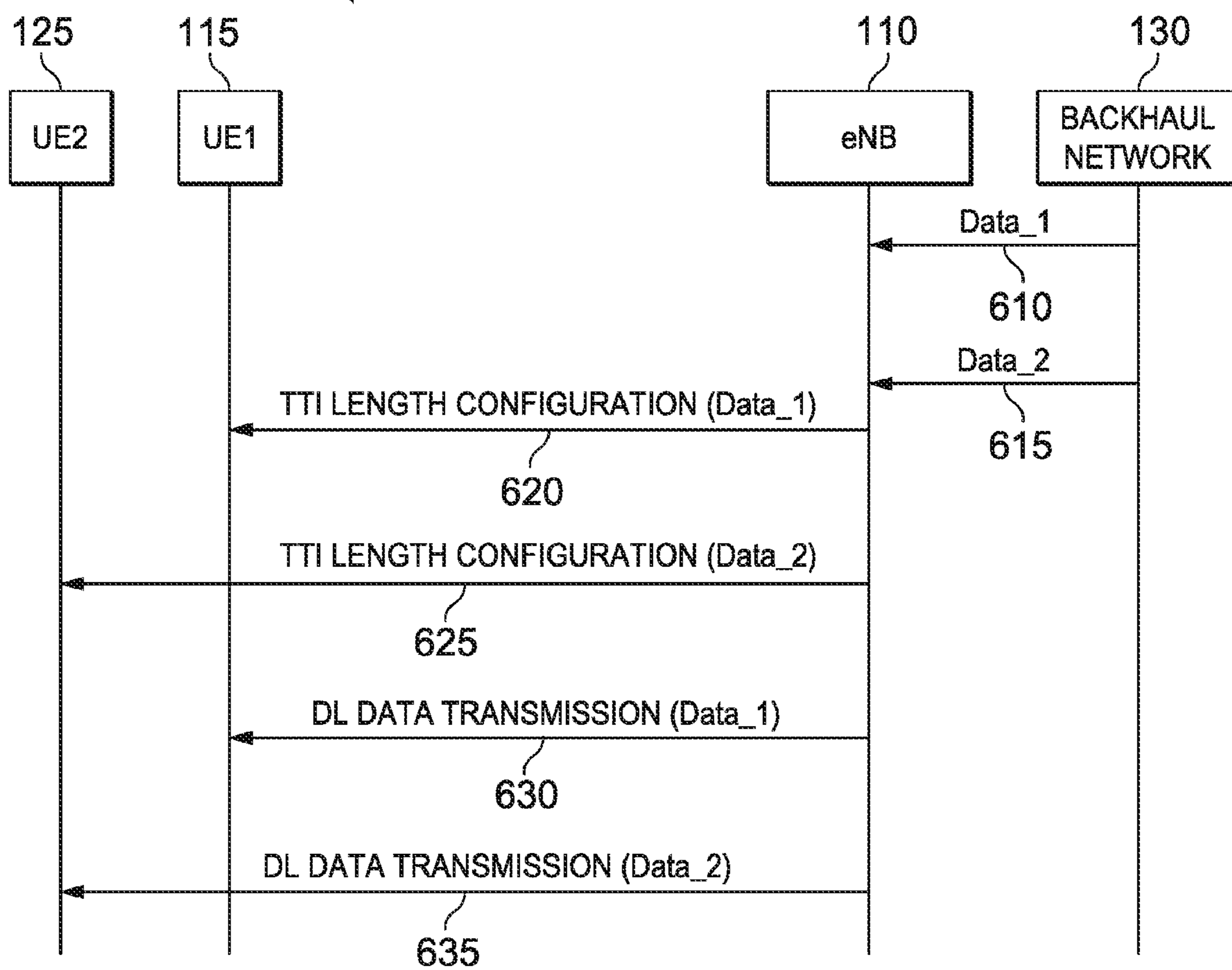

FIG. 5

600

FIG. 6



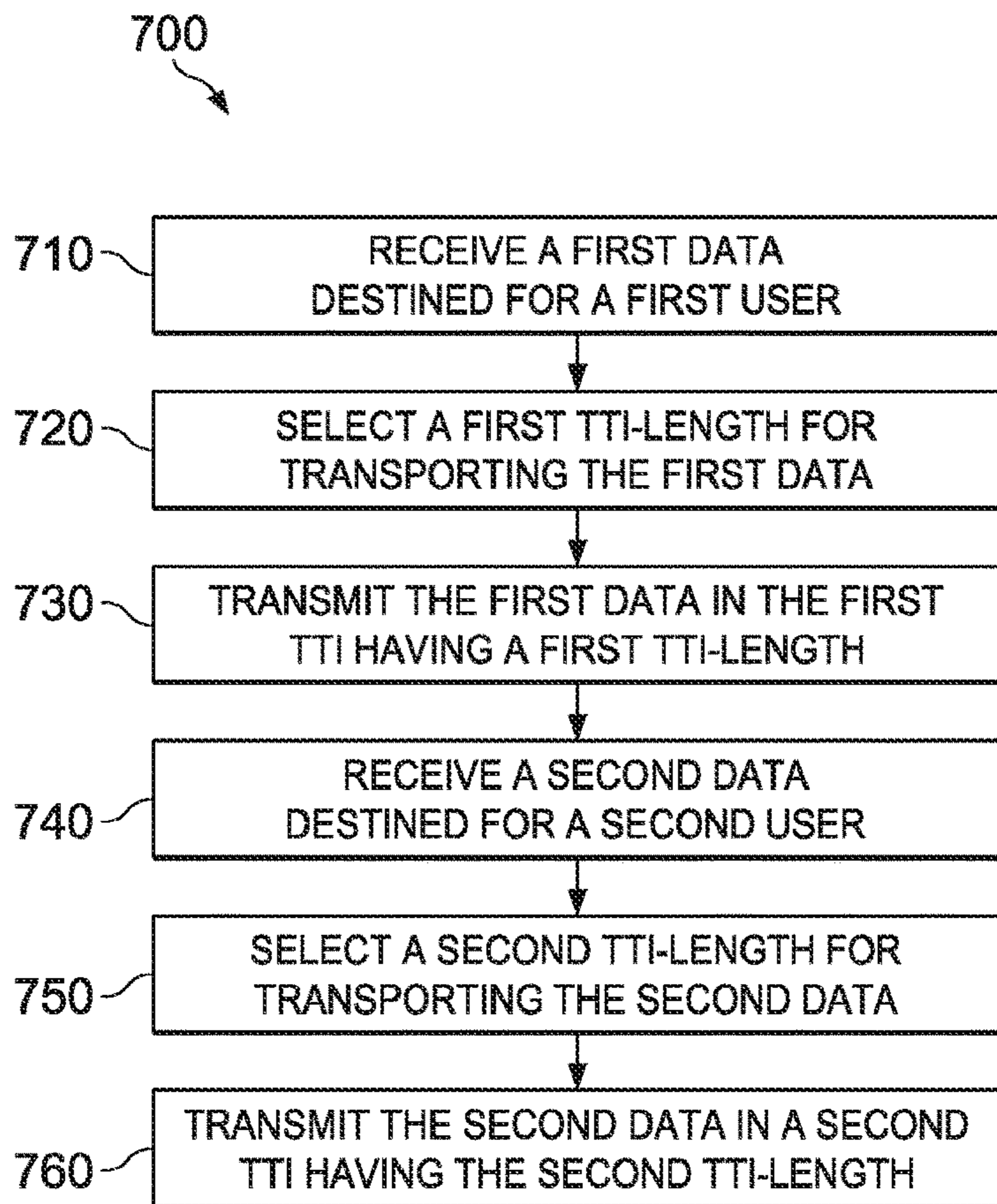

FIG. 7

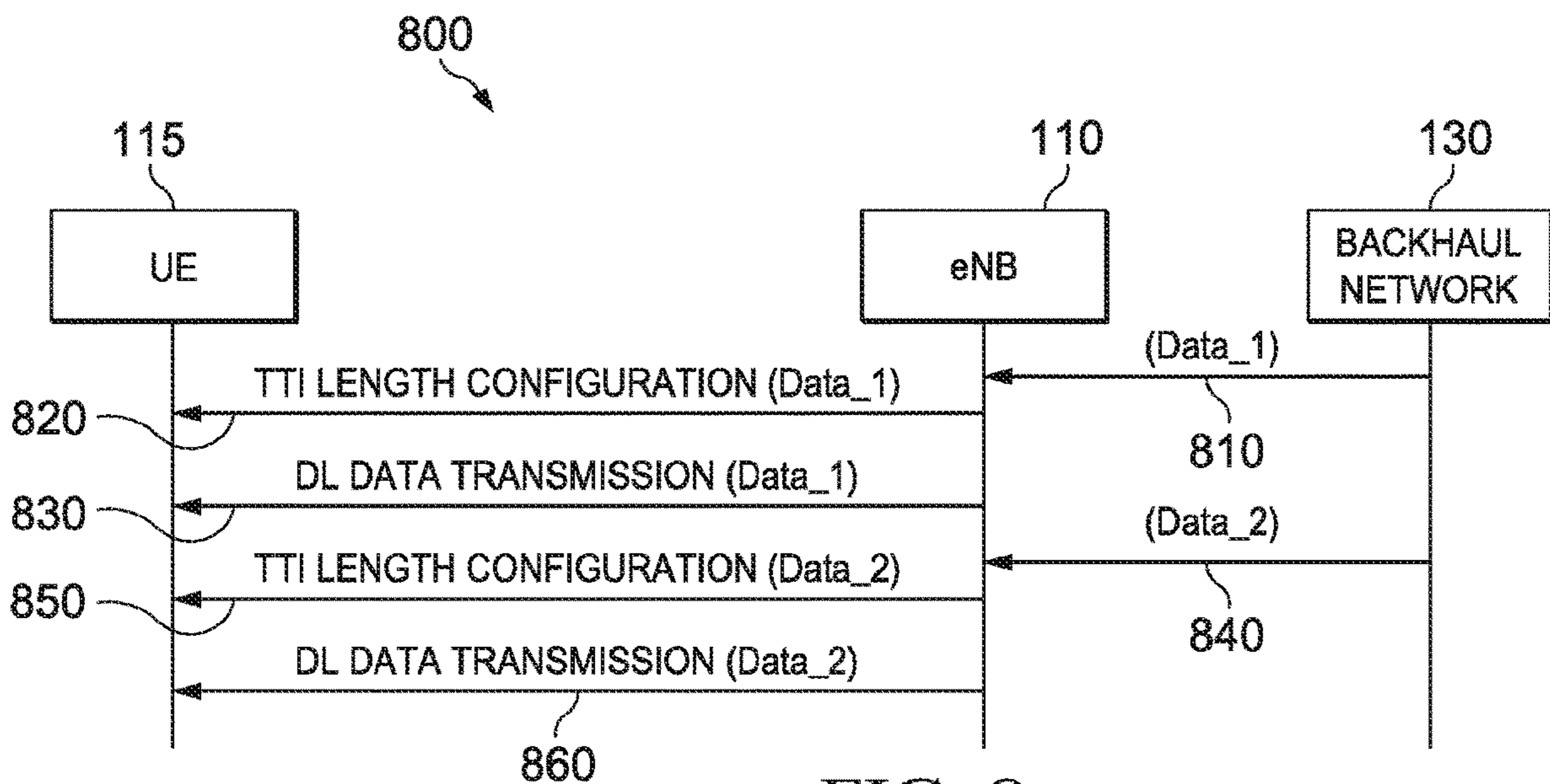

FIG. 8

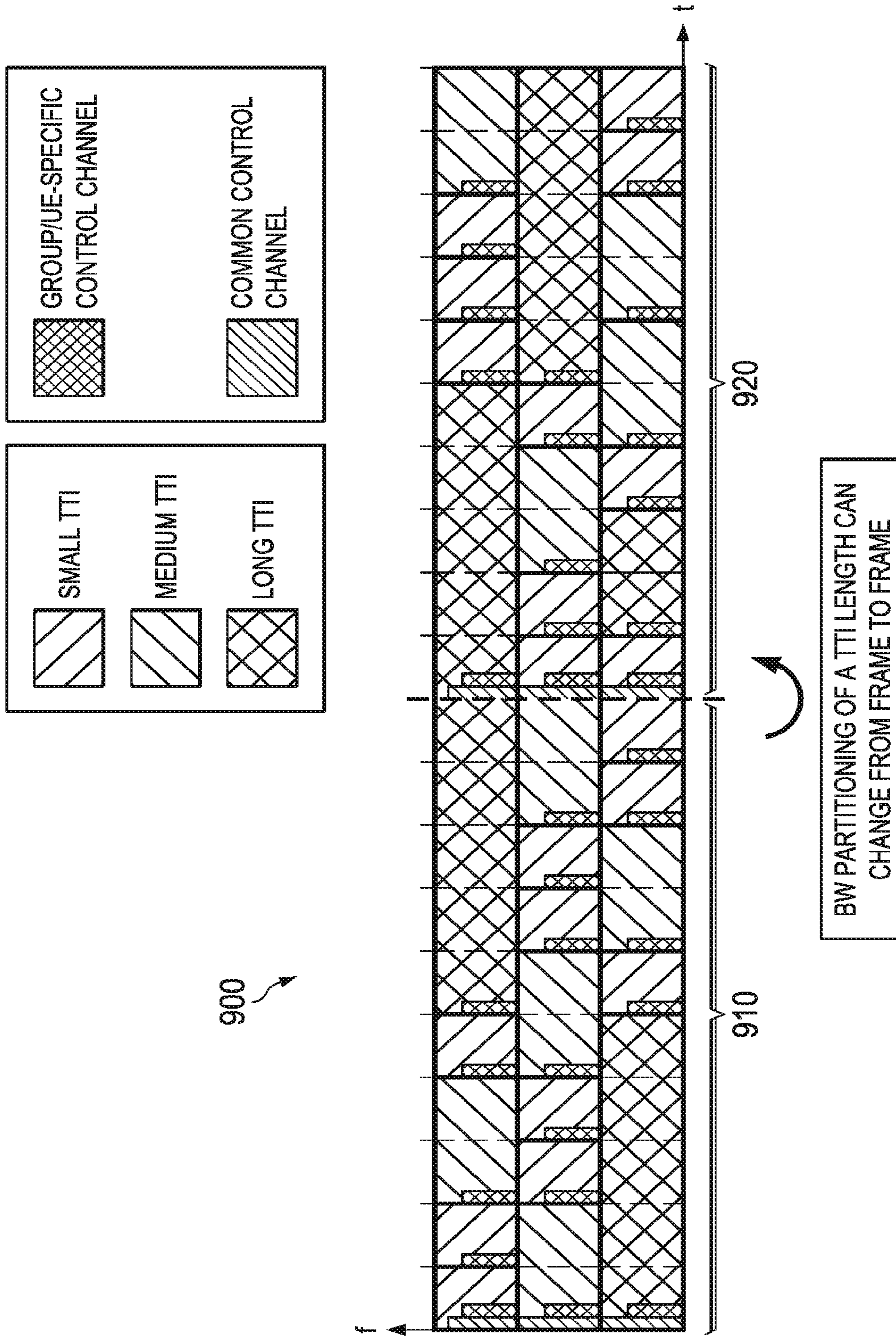

FIG. 9

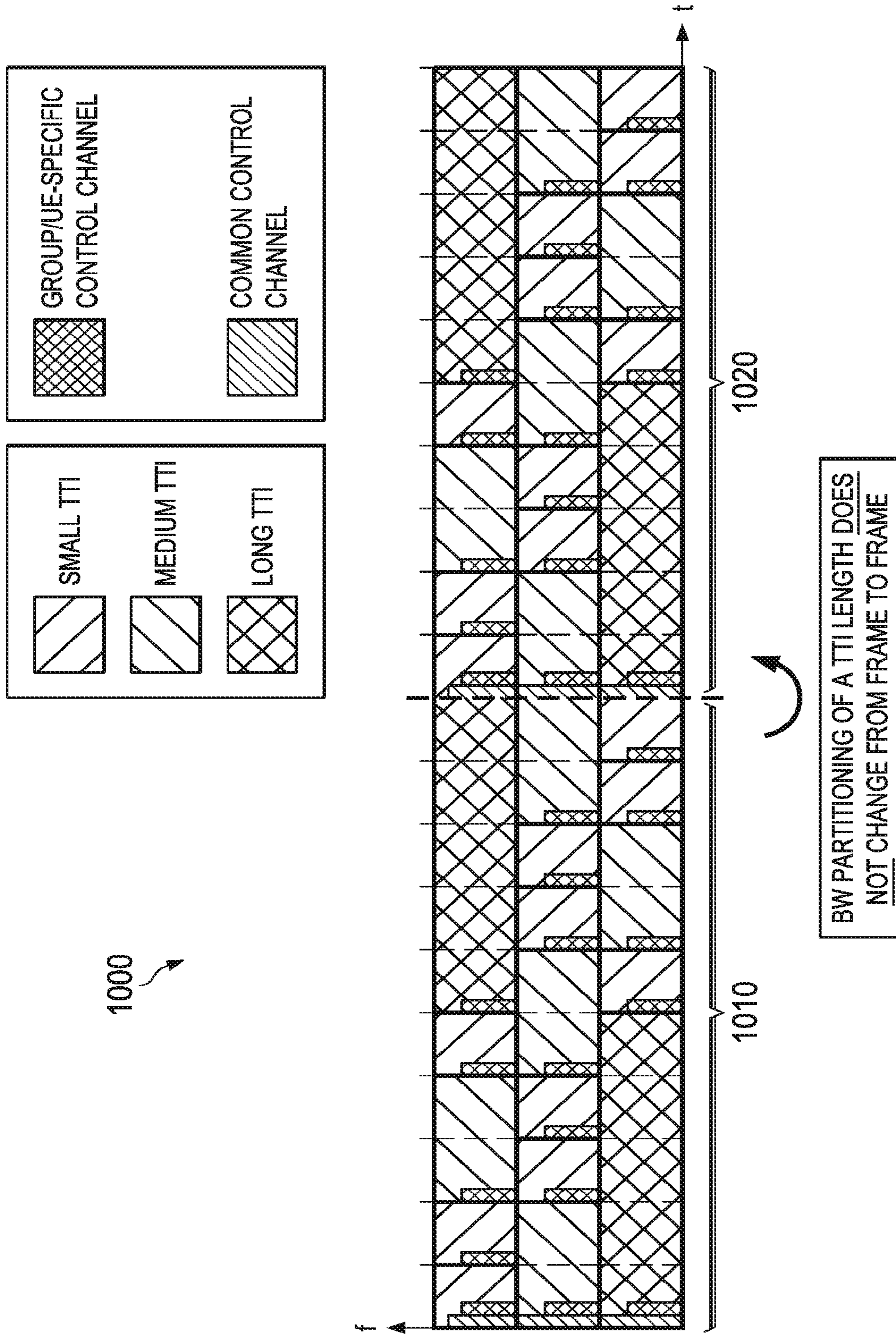

FIG. 10

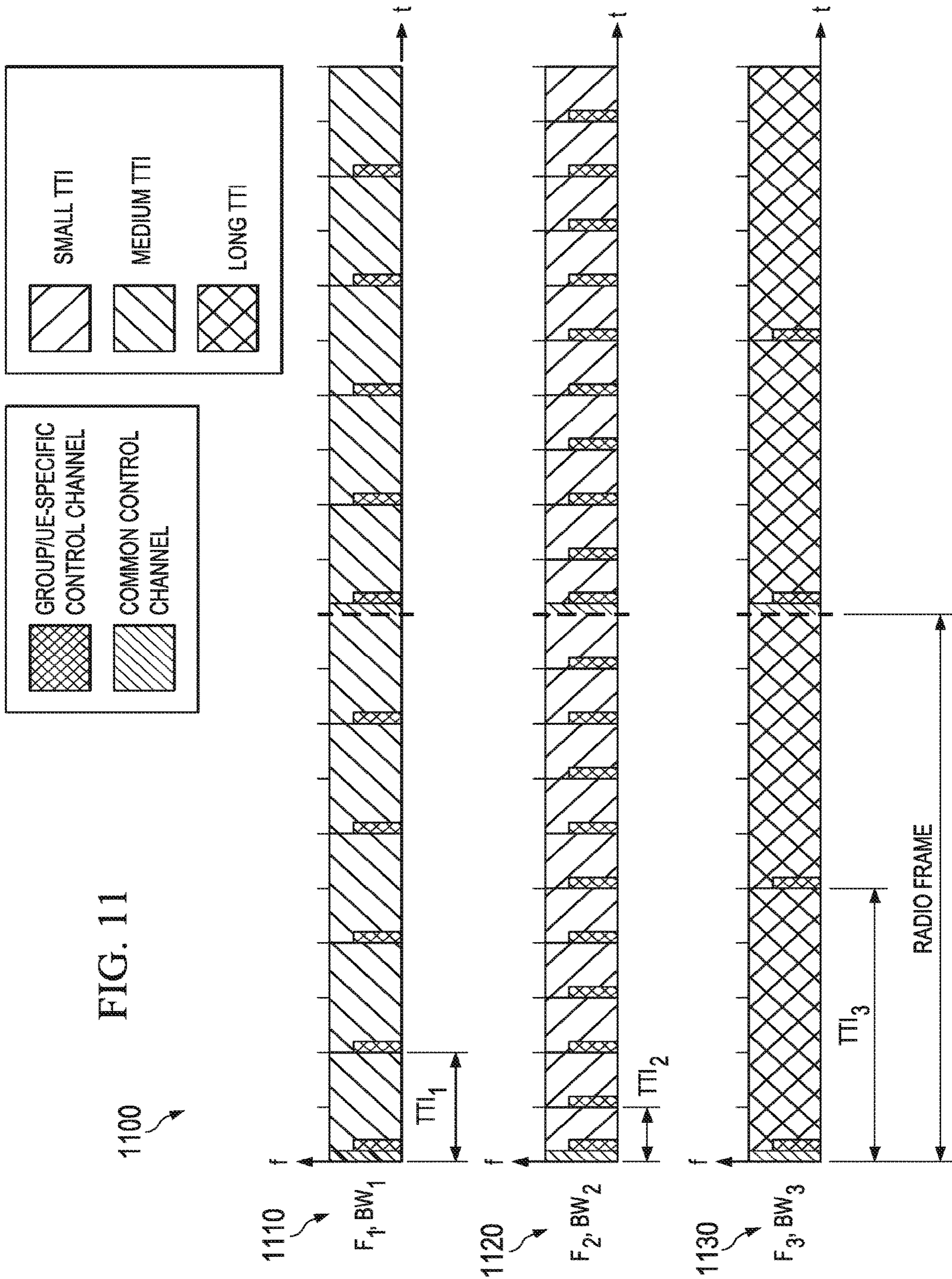

FIG. 11

1100

1110

F₁, BW₁

TTI₁

1120

F₂, BW₂

TTI₂

1130

F₃, BW₃

TTI₃

RADIO FRAME

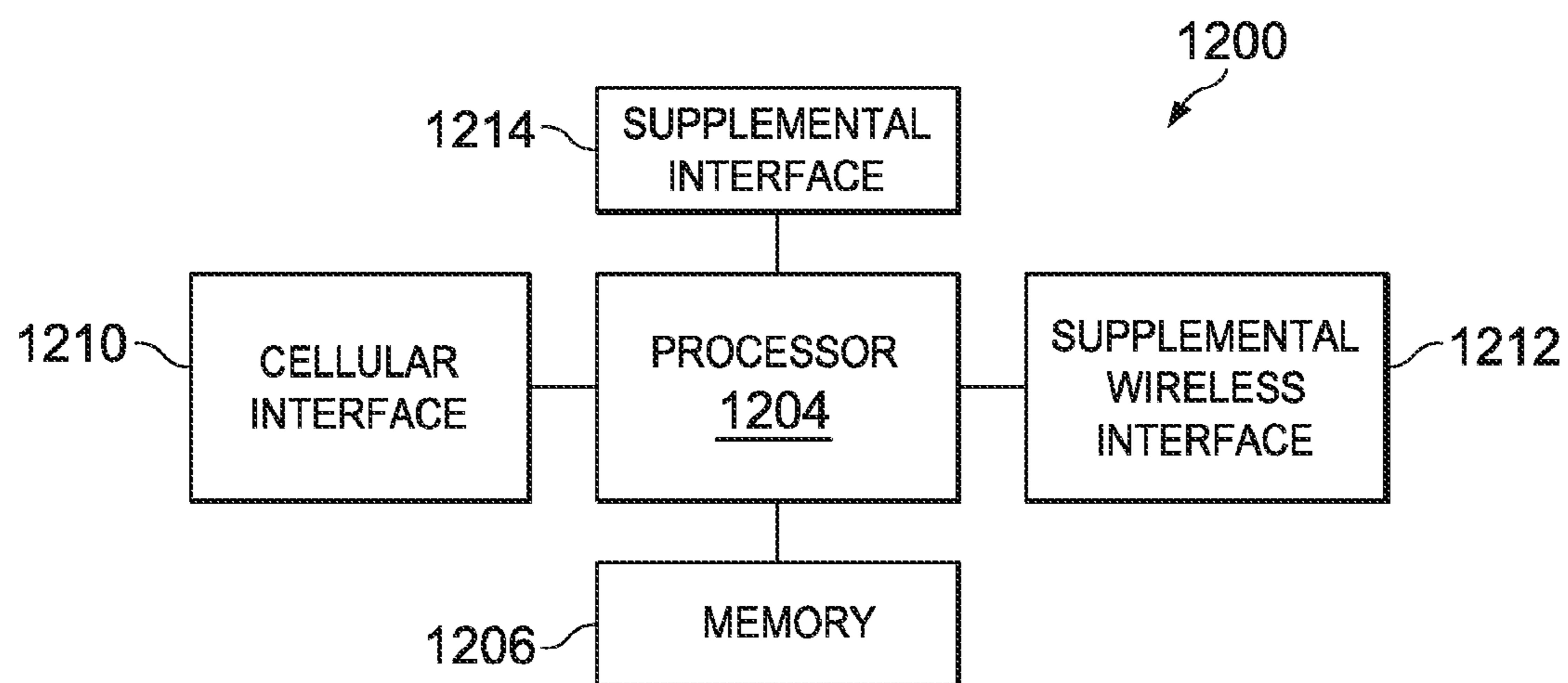

FIG. 12

SYSTEM AND METHOD FOR ADAPTIVE TRANSMISSION TIME INTERVAL (TTI) STRUCTURE

This patent application is a continuation of U.S. Non-Provisional application Ser. No. 15/962,001, filed on Apr. 25, 2018 and entitled "System and Method for Adaptive Transmission Time Interval (TTI) Structure," which is a continuation of U.S. Non-Provisional application Ser. No. 15/648,186 filed on, Jul. 12, 2017 and entitled "System and Method for Adaptive Transmission Time Interval (TTI) Structure," which is a continuation of U.S. Non-Provisional application Ser. No. 14/823,873, filed on Aug. 11, 2015 (now U.S. Pat. No. 9,743,403 issued Aug. 22, 2017) and entitled "System and Method for Adaptive Transmission Time Interval (TTI) Structure," which is a continuation of U.S. Non-Provisional application Ser. No. 13/611,823, filed on Sep. 12, 2012 (now U.S. Pat. No. 9,131,498 issued Sep. 8, 2015) and entitled "System and Method for Adaptive Transmission Time Interval (TTI) Structure," all of which applications are hereby incorporated herein by reference as if reproduced in their entireties.

TECHNICAL FIELD

The present invention relates generally to wireless communications, and more specifically, to a system and method for adapting the length of transmission time intervals (TTIs).

BACKGROUND

Modern wireless networks must support the communication of diverse traffic types (e.g., voice, data, etc.) having different latency requirements, while at the same time satisfying overall network/channel throughput requirements. The ability to satisfy these latency and throughput requirements is affected by, inter alia, wireless channel conditions and wireless channel parameters. One wireless channel parameter that significantly affects both latency and throughput performance is the size (or length) of the transport containers used to carry the traffic. Conventional networks use a single, fixed-length, transport container, and are therefore limited in their ability to adapt to changes in wireless channel conditions, usage, etc.

SUMMARY OF THE INVENTION

Technical advantages are generally achieved by embodiments of the present invention which adapt the length of downlink transmission time intervals (TTIs) in downlink radio frames to satisfy latency and/or throughput performance.

In accordance with an embodiment, a method of communicating data in a wireless channel is provided. In this example, the method comprises receiving a first data and a second data. The method further includes transporting the first data in transmission time intervals (TTIs) of the wireless channel having a first TTI length; and transporting the second data in TTIs of the wireless channel having a second TTI length that is different than the first TTI length. A transmitting device for performing this method is also provided. A device for receiving data transmitted in accordance with this method is also provided.

In accordance with another embodiment, another method for communicating data in a wireless channel is provided. In this example, the method includes receiving a first data destined for a receiving device, selecting a first TTI length

for transporting the first data, and transmitting the first data in a first TTI of the wireless channel having the first TTI length. The method further includes receiving a second data destined for the receiving device, selecting a second TTI length for transporting the second data, and transmitting the second data in a second TTI of the wireless channel having the second TTI length. A transmitting device for performing this method is also provided. A device for receiving data transmitted in accordance with this method is also provided.

BRIEF DESCRIPTION OF THE DRAWINGS

For a more complete understanding of the present invention, and the advantages thereof, reference is now made to the following descriptions taken in conjunction with the accompanying drawings, in which:

FIG. 1 illustrates a diagram of an embodiment of a wireless communications network;

FIG. 2 illustrates a diagram of a prior art downlink channel carrying fixed-length TTI;

FIG. 3 illustrates a diagram of an embodiment of a downlink channel carrying variable-length TTIs;

FIG. 4 illustrates a flowchart of an embodiment method for adapting TTI-lengths in a DL channel;

FIG. 5 illustrates a diagram of an embodiment for selecting TTI-lengths for transporting data in a DL channel;

FIG. 6 illustrates a protocol diagram of an embodiment communication sequence for adapting TTI-lengths in a DL channel; and

FIG. 7 illustrates a flowchart of another embodiment method for adapting TTI-lengths in a DL channel;

FIG. 8 illustrates a protocol diagram of another embodiment communication sequence for adapting TTI-lengths in a DL channel;

FIG. 9 illustrates a diagram of another embodiment of a DL channel carrying variable-length TTIs;

FIG. 10 illustrates a diagram of an embodiment of a DL channel carrying TTIs have various lengths;

FIG. 11 illustrates a diagram of an embodiment of a DL channel carrying TTIs have various lengths; and

FIG. 12 illustrates a block diagram of an embodiment of a communications device.

Corresponding numerals and symbols in the different figures generally refer to corresponding parts unless otherwise indicated. The figures are drawn to clearly illustrate the relevant aspects of the preferred embodiments and are not necessarily drawn to scale.

DETAILED DESCRIPTION OF ILLUSTRATIVE EMBODIMENTS

The making and using of the presently preferred embodiments are discussed in detail below. It should be appreciated, however, that the present invention provides many applicable inventive concepts that can be embodied in a wide variety of specific contexts. The specific embodiments discussed are merely illustrative of specific ways to make and use the invention, and do not limit the scope of the invention.

Conventional wireless networks use fixed length transport containers. For instance, networks operating under the third generation partnership (3GPP) long term evolution (LTE) release eight (rel-8) telecommunication standards use one millisecond (ms) transmission time intervals (TTIs). The length of a transport container can significantly affect latency performance and throughput performance of the network. Specifically, shorter transport containers achieve superior latency performance by providing more frequent

transmission opportunities, while longer transport containers achieve superior throughput performance by reducing signaling overhead. Hence, fixed length transport containers may be unable to satisfy latency requirements and/or provide desired throughput performance under some network conditions. As such, mechanisms or techniques for varying transport container length are desired in order to achieve improved network performance.

Aspects of this disclosure provide mechanisms for adapting the length of transport containers in accordance with various parameters (e.g., latency requirements, buffer size, user mobility characteristics, etc.). Although much of this disclosure is presented in the context of LTE (e.g., transport containers may be referred to as TTIs, etc.), the techniques and/or mechanisms discussed herein can be applied to non-LTE networks (e.g., any frequency division duplex and/or time division duplex communication systems). Although much of this disclosure are discussed in the context of downlink communications, the principles described herein can also be applied to provide adaptive TTI structures in uplink communications, as well as other forms of wireless communications (e.g., device-to-device, etc.).

FIG. 1 illustrates a wireless network 100 comprising a cellular coverage area 101 within which an eNB 110 provides wireless access to a plurality of UEs 115, 125. The eNB 110 may provide wireless access by establishing a downlink communication channel (solid arrows) and an uplink communication channel (dotted arrows) with the UEs 115, 125. In an embodiment, the wireless network 100 may operate in accordance with an LTE communication protocol. The downlink communication channel may carry data channels (e.g., physical downlink shared channel (PDSCH), etc.) and control channels (e.g., a physical downlink shared channels (PDCCH), etc.). More specifically, the control channels may include UE/group specific control channels and common control channels that carry downlink control information to the UEs (and/or relays), as well as uplink (UL)-related control channels that carry various uplink control information to the UEs (e.g., hybrid automatic repeat request (HARQ), acknowledge/negative-acknowledge (ACK/NACK), UL grant etc.).

FIG. 2 illustrates a prior art DL channel 200 carrying a plurality of radio frames 210-220. As shown, TTIs in the radio frames 210-220 are fixed length, with each TTI carrying a common control channel, a group/UE-specific control channel, and UL-related control channels.

FIG. 3 illustrates an embodiment of a DL channel 300 carrying a plurality of radio frames 310-320. Unlike the prior art DL channel 200, the DL channel 300 carries variable-length TTIs. The periodicity of the common control channel is determined by the periodicity of the radio frames (e.g., one common control channel per radio-frame). The periodicity of the group/UE-specific control channel is determined by the periodicity of variable-length TTIs (e.g., one group/UE-specific control channel per TTI). Notably, including a group/UE-specific control channel in each TTI allows the eNB to dynamically schedule UEs to TTIs as often as the smallest length-TTI (i.e., as often as the atomic interval). Further, the UL-related control channel is decoupled from the TTI structure, such that the periodicity of the UL-related control channel is independent from the length/periodicity of the variable-length TTIs. For instance, the TTI 311 carries one UL-related control channel, while the TTI 313 carries three UL-related control channels. Notably, some TTIs do not carry any UL-related control channels. Hence, the amount of control overhead in the DL channel 300 is variable, and depends on the periodicity of

the UL-related control channel (e.g., as configured by the network administrator) as well as the periodicity of the group/UE specific control channel (e.g., as determined by the TTI-length configurations of the radio frames 310-320).

FIG. 4 illustrates a flowchart of a method 400 for adapting TTI-lengths in a DL channel. The method 400 begins at step 410, where the eNB receives a first data destined for a first user. Thereafter, the method 400 proceeds to step 420, where the eNB receives a second data destined for a second user. The first data and the second data may be buffered in separate buffers of the eNB. Thereafter, the method 400 proceeds to step 430, where the eNB selects a first TTI-length for transporting the first data. This selection may be made in accordance with various selection criteria, including latency requirements, buffer size, mobility characteristics of the first user, etc. Thereafter, the method 400 proceeds to step 440, where the eNB selects a second TTI-length for transporting the second data. Next, the method 400 proceeds to step 450, where the eNB transmits the first data in a first TTI having the first TTI-length. Next, the method 400 proceeds to step 460, where the eNB transmits the second data in a second TTI having the second TTI-length. The first data and the second data may be transmitted in a common radio-frame.

FIG. 5 illustrates a flowchart of a method 500 for selecting TTI-lengths for transporting data in a DL channel. Notably, the method 500 represents just one example for selecting TTI-lengths. Other examples that consider other factors and/or have more TTI-length designations may also be used to select TTI-lengths for data transmission. The method 500 begins at step 510, where the eNB determines whether the latency requirement of the data (e.g., whether the data requires low latency), which may be determined in accordance with the traffic type of the data. For instance, some traffic types (e.g., voice, mobile gaming, etc.) may require low levels of latency, while other traffic types (e.g., messaging, email, etc.) may have less stringent latency requirements.

If the data requires low latency, then a short TTI-length 515 is selected to transport the data. If the data has a higher (i.e., less stringent) latency requirement, then the method 500 proceeds to step 520, where the eNB determines the buffer size used to store the data. Specifically, the buffer size of the data is indicative of the amount of data that needs to be transported. When large amounts of data need to be transported, then longer TTI-lengths may provide higher throughput rates by minimizing overhead. However, large TTI-lengths may not be warranted when only small amounts of data need to be transported. For instance, if there is not enough data to fill the long TTI, then a medium TTI-length may be more efficient. If the data has a small buffer size, then a medium TTI-length 525 is selected. Otherwise, if the data has a large buffer size, then the method 500 proceeds to step 530.

At step 530, the eNB determines whether the user has a low, medium, high or very-high mobility characteristic. A user's mobility characteristic may correspond to a rate at which the user is moving. For instance, users that are moving at a higher rates of speed (e.g., a user communicating in a car) have higher mobility characteristics than users moving at comparatively lower rates of speed (e.g., a user walking through a park). Notably, a user's mobility characteristic is highly correlated to wireless channel stability, as highly mobile users experience more volatile channel conditions than less mobile users. Moreover, wireless channel stability heavily influences the degree to which link adaptation can be improved through more frequent channel

estimation opportunities. That is, users having moderate to high mobility characteristics may achieve improved bit-rates when using medium TTI-lengths (or even short TTI-lengths) due to enhanced link adaptation resulting from more frequent channel estimation opportunities. These higher bit-rates may outweigh the overhead savings of long TTI-lengths, and consequently may increase overall throughput for those users. However, fast link adaptation capabilities may be less beneficial for stationary or slow moving users, as those users experience relatively stable channel conditions. As a result, low mobility users may derive higher throughput by exploiting the low-overhead nature of long TTI-lengths, rather than the faster link adaptation capabilities derived from medium or low TTI-lengths. In addition, users that have very high mobility characteristics (e.g., users moving at very-high rates of speed) may derive little or no gain from link adaptation, as channel conditions may be changing too quickly to perform channel estimation with sufficient accuracy to improve the bit-rate. Hence, very-high mobility users may achieve higher throughput from long TTI-lengths. Referring once again to the method 500, if the data is destined for a user having moderate to high mobility, then the eNB selects a medium TTI-length for transporting the data (at step 530). Alternatively, if the user has either low or very-high mobility, then the eNB selects a medium TTI-length for transporting the data (at step 530). Notability, degrees of mobility (low, medium, high, and very high) may be relative to the network conditions and/or capabilities of the wireless communication devices.

FIG. 6 illustrates a protocol diagram for a communications sequence 600 for communicating data in TTIs having varying TTI-lengths. The communications sequence 600 begins when a first data (Data_1) 610 and a second data (Data_1) 615 destined for the UE1 115 and UE 125 (respectively) are communicated from the backhaul network 130 to the eNB 110. Upon reception, the eNB 110 determines which TTI-length to transport the Data_1 610 and the Data_1 615. The eNB 110 communicates the TTI-lengths by sending a TTI length configuration (Data_1) message 620 and a TTI length configuration (Data_2) message 625 to the UEs 115 and 125 (respectively). Thereafter, the eNB 110 communicates the Data_1 610 and the Data_2 620 via the DL data transmission (Data_1) 630 and the DL data transmission (Data_2) 635. In an embodiment, the DL data transmission (Data_1) 630 and the DL data transmission (Data_2) 635 may be carried in different length TTIs of a common radio-frame.

FIG. 7 illustrates a flowchart of a method 700 for adapting TTI-lengths in a DL channel. The method 700 begins at step 710, where the eNB receives a first data destined for a user. Thereafter, the method 700 proceeds to step 720, where the eNB selects a first TTI-length for transporting the first data. Thereafter, the method 700 proceeds to step 730, where the eNB transmits the first data in a first TTI having the first TTI-length. Next, the method 700 proceeds to step 740, where the eNB receives a second data destined for the same user. Thereafter, the method 700 proceeds to step 750, where the eNB selects a second TTI-length for transporting the second data. The second TTI-length may be different than the first TTI-length for various reasons. For instance, the first data and the second data may have different latency requirements and/or buffer sizes, and/or then user's mobility characteristics may have changed. Next, the method 700 proceeds to step 760, where the eNB transmits the second data in a second TTI having the second TTI-length.

FIG. 8 illustrates a protocol diagram for a communications sequence 800 for adapting the TTI-lengths used for

carrying data to a common user. The communications sequence 800 begins when a Data_1 810 destined for a UE 115 is communicated from the backhaul network 130 to the eNB 110. Upon reception, the eNB 110 selects a TTI-length for transporting the Data_1 810, which the eNB 110 communicates to the UE 110 via the TTI length configuration (Data_1) message 820. Thereafter, the eNB 110 communicates the Data_1 810 in the DL data transmission (Data_1) 830. Thereafter, a Data_2 840 destined for a UE 115 is communicated from the backhaul network 130 to the eNB 110. Upon reception, the eNB 110 selects a TTI-length for transporting the Data_2 840, which the eNB 110 communicates to the UE 110 via the TTI length configuration (Data_2) message 850. Thereafter, the eNB 110 communicates the Data_2 840 in the DL data transmission (Data_2) 860. In an embodiment, the DL data transmission (Data_1) 830 and DL data transmission (Data_2) 860 may be carried in the TTIs having different TTI lengths. The DL data transmission (Data_1) 830 and DL data transmission (Data_2) 860 may be communicated in the same, or different, radio frames.

In some embodiments, the TTI structure of radio frames may be adapted dynamically, such the TTI length configuration messages/indications are included in the Group/UE-specific control channel of each TTI. On one hand, dynamically adapting the TTI structure of radio frames with such granularity may provide high degrees of flexibility with respect to TTI-length adaptation. On the other hand, the inclusion of additional control signaling in the UE/group specific control channel may significantly increase overhead in the radio frame, as the UE/group specific control channel is communicated relatively frequently (e.g., in each TTI). To reduce the overhead attributable to TTI-length adaptation, the TTI structure of radio frame may be adapted in a semi-static manner.

FIG. 9 illustrates an embodiment of a DL channel 900 carrying a plurality of variable-length TTIs in a plurality of radio frames 910-920. The DL channel 900 may be somewhat similar to the DL channel 300, with the exception that the DL channel 900 carries the TTI length configuration messages/indications in the common control channel, rather than the UE-Group specific control channels. This may reduce the overhead attributable TTI-length adaptation when high-frequency adaptation is unnecessary. Furthermore, different TTI-lengths may occupy different portions of the DL channel 900 through bandwidth partitioning. Such bandwidth partitioning may depend on the amount of UEs configured for a particular TTI length. For example, if there are twice the amount of UEs configured for the short TTI-length than the medium TTI-length, the bandwidth occupied by the short TTI-length may be twice the amount of bandwidth occupied by the medium-TTI length. An advantage of this semi-static arrangement is that the UEs know the TTI location in time and bandwidth partitioning by virtue of the aforementioned configuration messages/indications, and consequently the UEs only need to look for its UE/Group specific control channels in the time-frequency regions corresponding to the particular TTI-length. Hence, rather than having to search for the entire bandwidth and every atomic interval for its UE/Group specific control channels, this arrangement reduces the control channel decoding complexity of a UE.

A further alternative for reducing overhead is to perform TTI-length adaptation in radio frames that have a static TTI structure. In this context, radio frames having a static structure comprise a variety of TTI-lengths with which to schedule users, but the ratio and placement of TTIs is fixed

such that TTI-length does not change from one radio frame to another. FIG. 10 illustrates a downlink channel 1000 for communicating radio frames 1010-1020 having a static TTI structure. Notably, the radio frame 1010 and 1020 have identical TTI structures such that the placement/ratio of the short, medium, and long TTIs does not change from one radio frame to another. Hence, TTI-length adaptation is accomplished in the downlink channel 1000 through selective scheduling (e.g., scheduling users to different TTI-lengths), rather than by adapting the TTI structure of the radio frames 1010-1020. Similarly, TTI-length adaptation can be achieved via carrier aggregation. FIG. 11 illustrates a downlink channel 1000 for achieving TTI-length adaptation via carrier aggregation. As shown, mid-length TTIs are carried in the frequency band 1110, short-length TTIs are carried in the frequency band 1120, and long-length TTIs are carried in the frequency band 1130. Like the fixed-frame structure of the downlink channel 1000, TTI-length adaptation is accomplished in the downlink channel 1100 through selective scheduling (e.g., scheduling users to different TTI-lengths).

FIG. 12 illustrates a block diagram of an embodiment of a communications device 1200, which may be implemented as one or more devices (e.g., UEs, eNBs, etc.) discussed above. The communications device 1200 may include a processor 1204, a memory 1206, a cellular interface 1210, a supplemental wireless interface 1212, and a supplemental interface 1214, which may (or may not) be arranged as shown in FIG. 12. The processor 1204 may be any component capable of performing computations and/or other processing related tasks, and the memory 1206 may be any component (volatile, non-volatile, or otherwise) capable of storing programming and/or instructions for the processor 1204. In embodiments, the memory 1206 is non-transitory. The cellular interface 1210 may be any component or collection of components that allows the communications device 1200 to communicate using a cellular signal, and may be used to receive and/or transmit information over a cellular connection of a cellular network. The supplemental wireless interface 1212 may be any component or collection of components that allows the communications device 1200 to communicate via a non-cellular wireless protocol, such as a Wi-Fi or Bluetooth protocol, or a control protocol. The supplemental interface 1214 may be any component or collection of components that allows the communications device 1200 to communicate via a supplemental protocol, including wire-line protocols.

In accordance with an embodiment, a method of communicating data in a wireless channel is provided. In this example, the method comprises receiving, by an access point (AP), at least a first data and a second data from a network, and transmitting, by the AP, the first data in a first transmission time interval (TTI) and the second data in a second TTI of a downlink channel in accordance with a TTI configuration. The first TTI and the second TTI have different TTI lengths based on the configuration. The first TTI and the second TTI have different fixed TTI lengths based on the TTI configuration. The TTI lengths of the first TTI and the second TTI are determined based on characteristics of the first data and the second data, respectively, according to the TTI configuration. The TTI lengths of the first TTI and the second TTI are determined based on a buffer size associated with the first data and the second data, respectively, or based on a latency requirement of the first data and the second data, respectively.

The first data is transmitted to a first user equipment (UE) and the second data is transmitted to a second UE, or the first

data and second data are transmitted to the first UE; the TTI lengths of the first TTI and the second TTI are determined based on characteristics of the first UE and the second UE, respectively, according to the configuration. The TTI lengths of the first TTI and the second TTI are determined based on mobility characteristics of the first UE and the second UE, respectively, according to the TTI configuration.

In accordance with an embodiment, an access point (AP) is provided. In this example, the AP comprises a processor and a non-transitory computer readable storage medium storing programming for execution by the processor. The programming includes instructions to receive at least a first data and a second data from a network, and to transmit the first data in a first transmission time interval (TTI) and the second data in a second TTI of a downlink channel in accordance with a TTI configuration. The first TTI and the second TTI have different TTI lengths based on the configuration. The first TTI and the second TTI have different fixed TTI lengths based on the TTI configuration. The TTI lengths of the first TTI and the second TTI are determined based on characteristics of the first data and the second data, respectively, according to the TTI configuration. The TTI lengths of the first TTI and the second TTI are determined based on a latency requirement of the first data and the second data, respectively. The TTI lengths of the first TTI and the second TTI are determined based on a buffer size associated with the first data and the second data, respectively.

The first data is transmitted to a first user equipment (UE) and the second data is transmitted to a second UE, or the first data and second data are transmitted to the first UE; the TTI lengths of the first TTI and the second TTI are determined based on characteristics of the first UE and the second UE, respectively, according to the TTI configuration. The TTI lengths of the first TTI and the second TTI are dynamically determined based on mobility characteristics of the first UE and the second UE, respectively, according to the TTI configuration.

In accordance with an embodiment, a method of communicating data in a wireless channel is provided. In this example, the method comprises receiving, by an access point (AP), at least a first data from a network, and transmitting, by the AP, the at least the first data in a first transmission time interval (TTI) of a downlink channel. The downlink channel has at least a first radio frame, and the first radio frame comprises at least the first TTI and a second communicated in a common data channel according to a TTI configuration. The first TTI and the second TTI have different TTI lengths based on the TTI configuration.

The first TTI and the second TTI have different fixed TTI lengths based on the TTI configuration. The TTI lengths of the first TTI and the second TTI are determined based on characteristics of data carried by the first TTI and the second TTI, respectively, according to the TTI configuration. The TTI lengths of the first TTI and the second TTI are determined based on a buffer size associated with data carried by the first TTI and the second TTI, respectively. The TTI lengths of the first TTI and the second TTI are determined based on a latency requirement of data carried by the first TTI and the second TTI, respectively.

The TTI lengths of the first and the second TTI are determined based on a mobility characteristic of user equipments (UEs) receiving data carried by the first TTI and the second TTI, respectively.

In accordance with an embodiment, an access point (AP) is provided. In this example, the AP comprises a processor and a non-transitory computer readable storage medium

storing programming for execution by the processor. The programming includes instructions to receive at least a first data from a network, and to transmit the at least the first data in a first transmission time interval (TTI) of a downlink channel. The downlink channel has at least a first radio frame, and the first radio frame comprises at least the first TTI and a second TTI communicated in a common data channel according to a TTI configuration. The first TTI and the second TTI have different TTI lengths based on the configuration.

Although the present invention and its advantages have been described in detail, it should be understood that various changes, substitutions and alterations can be made herein without departing from the spirit and scope of the invention as defined by the appended claims. Moreover, the scope of the present application is not intended to be limited to the particular embodiments of the process, machine, manufacture, composition of matter, means, methods and steps described in the specification. As one of ordinary skill in the art will readily appreciate from the disclosure of the present invention, processes, machines, manufacture, compositions of matter, means, methods, or steps, presently existing or later to be developed, that perform substantially the same function or achieve substantially the same result as the corresponding embodiments described herein may be utilized according to the present invention. Accordingly, the appended claims are intended to include within their scope such processes, machines, manufacture, compositions of matter, means, methods, or steps.

In accordance with an embodiment, a method for communicating data in a wireless channel is provided. In this embodiment, the method includes receiving a first plurality of data, receiving a second plurality of data, transmitting the first plurality of data in a first plurality of transmission time intervals (TTI) of the wireless channel, and transmitting the second plurality of data in a second plurality of TTIs of the wireless channel. The first plurality of TTIs has a first TTI length, and the second plurality of TTIs has a second TTI length that is different than the first TTI length. In one example, the method of claim 1 further includes determining the first TTI length in accordance with a first latency requirement of the first plurality of data, and determining the second TTI length in accordance with a second latency requirement of the second plurality of data, where the first latency requirement is different than the second latency requirement. In the same example, or another example, the method further includes determining the first TTI length in accordance with a first buffer size associated with the first plurality of data, and determining the second TTI length in accordance with a second buffer size associated with the second plurality of data, the first buffer size being different than the second buffer size. In any one of the preceding examples, the method may include determining the first TTI length in accordance with a first mobility characteristic of a first receiving device, the first plurality of data being destined for the first receiving device, and determining the second TTI length in accordance with a second mobility characteristic of a second receiving device, the second plurality of data being destined for the second receiving device, wherein the first mobility characteristic is different than the second mobility characteristic. The first TTI and the second TTI may be carried in a common radio frame. The wireless channel may be partitioned into at least a first band and a second band, with the first band exclusively carrying TTIs having the first TTI length, and the second band exclusively carrying TTIs having the second TTI length.

In some examples, the method further includes periodically transmitting a first control channel carrying wireless control information in the first plurality of TTIs and periodically transmitting a second control channel carrying wireless control information in the second plurality of TTIs, where a periodicity of the first control channel depends on the first TTI length, and a periodicity of the second control channel depends on the second TTI length.

In such an example, the first control channel may be transmitted more often than second control channel when the first TTI length is less than the second TTI length, and the second control channel may be transmitted more often than the first control channel when the first TTI length is greater than the second TTI length. In any one of the preceding examples, the method may further include periodically transmitting a first control channel carrying wireless control information in the first plurality of TTI, where a periodicity of the first control channel depends on the first TTI length, and periodically transmitting a second control channel carrying uplink related control information in the first plurality of TTIs, where the second control channel is de-coupled from a TTI structure of the wireless channel such that a periodicity of the second control channel is independent of the first TTI length. The first TTI length may correspond to a scheduling interval for the first plurality of TTIs that dictates a frequency with which wireless devices are scheduled to transmit or receive data in the wireless channel. A device for receiving data transmitted in accordance with this method is also provided.

In accordance with another embodiment, a method for communicating data in a wireless channel is provided. The method includes receiving a first plurality of data destined for a receiving device, selecting a first one of a plurality of transmission time intervals (TTI) lengths for transporting the first plurality of data, transmitting the first plurality of data in a first TTI of the wireless channel, the first TTI having a first TTI length, receiving, by the transmitting device, a second plurality of data destined for the receiving device, selecting a second one of a plurality of TTI lengths for transporting the second plurality of data, and transmitting the second plurality of data in a second TTI of the wireless channel, the second TTI having a second TTI length that is different than the first TTI length. In one example, the first TTI length is selected in accordance with a first latency requirement of the first plurality of data, the second TTI length is selected in accordance with a second latency requirement of the second plurality of data, and a first latency requirement is different than the second latency requirement. In the same example, or another example, the second plurality of data is received after the first plurality of data is transmitted, and the method further includes identifying a first mobility characteristic of the receiving device upon receiving the first plurality of data, where the first length is selected in accordance with the first mobility characteristic, and identifying a second mobility characteristic of the receiving device upon receiving the second plurality of data, wherein the second TTI length is selected in accordance with the second mobility characteristic, and where the first mobility characteristic is different than the second mobility characteristic. A device for transmitting the data in accordance with this method is also provided.

In accordance with another embodiment, another method for communicating data in a wireless channel is provided. In this example, the method includes receiving, by an access point (AP), at least a first data and a second data from a network, and transmitting, by the AP, the first data in a first transmission time interval (TTI) and the second data in a

second TTI of a downlink channel in accordance with a TTI configuration. The first TTI and the second TTI have different TTI lengths based on the TTI configuration. In one example, the first TTI and the second TTI have different fixed TTI lengths based on the TTI configuration. In that example, or another example, then TTI lengths of the first TTI and the second TTI are determined based on characteristics of the first data and the second data, respectively, according to the TTI configuration. In such an example, the TTI lengths of the first TTI and the second TTI may be determined based on a buffer size associated with the first data and the second data, respectively. Alternatively, the TTI lengths of the first TTI and the second may be determined based on a latency requirement of the first data and the second data, respectively. In any one of the preceding examples, or in another example, the first data may be transmitted to a first user equipment (UE) and the second data may be transmitted to a second UE. Alternatively, the first data and second data may be transmitted to the first UE. The TTI lengths of the first TTI and the second TTI may be determined based on characteristics of the first UE and the second UE, respectively, according to the TTI configuration. In such an example, the TTI lengths of the first TTI and the second TTI may be determined based on mobility characteristics of the first UE and the second UE, respectively, according to the TTI configuration. A device for communicating data in accordance with this method is also provided.

In accordance with another embodiment, another method for communicating data in a wireless channel is provided. In this embodiment, the method includes receiving, by an access point (AP), at least a first data from a network; and transmitting, by the AP, the at least the first data in a first transmission time interval (TTI) of a downlink channel, where the downlink channel has at least a first radio frame, the first radio frame includes at least the first TTI and a second TTI communicated in a common data channel according to a TTI configuration, and the first TTI and the second TTI have different TTI lengths based on the TTI configuration. In one example, the first TTI and the second TTI have different fixed TTI lengths based on the TTI configuration. In another example, the TTI lengths of the first TTI and the second TTI are determined based on characteristics of data carried by the first TTI and the second TTI, respectively, according to the TTI configuration. In yet another example, the TTI lengths of the first TTI and the second TTI are determined based on a buffer size associated with data carried by the first TTI and the second TTI, respectively. In any one of the preceding examples, or in another example, the TTI lengths of the first TTI and the second TTI are determined based on a latency requirement of data carried by the first TTI and the second TTI, respectively. In any one of the preceding examples, or in another example, the TTI lengths of the first TTI and the second TTI are determined based on a mobility characteristic of user equipments (UEs) receiving data carried by the first TTI and the second TTI, respectively. An apparatus for performing this method is also provided.

In accordance with yet another embodiment, yet another method of communicating data in a wireless channel is provided. In this embodiment, the method includes sending a first message indicating a first time duration length to a first user equipment (UE), sending a first data transmission to the first UE in a first time-frequency region having the first time duration length, sending a second message indicating a second time duration length to the second UE, and sending a second data transmission to the second UE in a second time-frequency region having the second time duration

length, where the first time duration length is different from the second time duration length. In one example, the first UE is same as the second UE. In another example, the first UE is different from the second UE. The first data transmission and the second data transmission may be transmitted in a common radio frame. The first time-frequency region may occupy a different bandwidth partition than the second time-frequency region.

The first message and the second message may be transmitted in a group specific control channel, a UE specific control channel, or a common control channel. The first time duration length and the second time duration length may be dynamically determined by the transmitting device based on characteristics of the first data and the second data, respectively. The first time duration length and the second time duration length may be dynamically determined by the transmitting device based on at least one of a buffer size or a latency requirement associated with the first data and the second data, respectively.

In accordance with yet another embodiment, yet another method for communicating data in a wireless channel is provided. In this embodiment, the method includes receiving a first message indicating a first time duration length from a transmitting device, receiving a first data transmission from the transmitting device in a first time-frequency region having the first time duration length, receiving a second message indicating a second time duration length, and receiving a second data transmission from the transmitting device in a second time-frequency region having the second time duration length. The first time duration length is different from the second time duration length. In one example, the first data transmission and the second data transmission are received in a common radio frame. In another example, the first time-frequency region occupies a different bandwidth partition than the second time-frequency region. In yet another example, the first message and the second message are received in a group specific control channel or a UE specific control channel. The first time duration length and the second time duration length may be dynamically determined by the transmitting device based on characteristics of the first data and the second data, respectively. Alternatively, the first time duration length and the second time duration length may be dynamically determined by the transmitting device based on at least one of a buffer size or a latency requirement associated with the first data and the second data, respectively. A user equipment and transmitting device for communicating data in accordance with this method is also provided.

In accordance with yet another embodiment, another method of communicating data in a wireless channel is provided. In this example, the method includes receiving, by a base station, a first UL-related control channel within a first downlink transmission time interval of a radio frame, wherein the first transmission time interval has a first transmission time interval length; and receiving, by the base station, a second UL-related control channel within a second downlink transmission time interval of the radio frame. The second downlink transmission time interval has a second transmission time interval length that is different than the first transmission time interval length, and the periodicity of the first UL-related control channel is independent from first downlink transmission time interval, and the periodicity of the second UL-related control channel is independent from the second downlink transmission time interval. In one example, the first downlink transmission time interval corresponds to a first frequency band of a first time-frequency region, and the second downlink transmission time interval

corresponds to a second frequency band of a second time-frequency region, the first time-frequency region occupying a different bandwidth partition than the second time-frequency region. In another example, the base station receives the first UL-related control channel and the second UL-related control channel from the same UE or different UEs. In yet another example, the first UL-related control channel and the second UL-related control channel are transmitted in a common radio frame. In yet another example, the first transmission time interval length and the second transmission time interval length are dynamically determined by the base station based on characteristics of a first data and a second data, respectively. In yet another example, the first transmission time interval length and the second transmission time interval length are dynamically determined by the base station based on at least one of a buffer size or a latency requirement associated with the first data and the second data, respectively.

In accordance with yet another embodiment, another method for communicating data in a wireless channel is provided. In this example, the method includes sending, by a user equipment (UE), a first UL-related control channel within a first downlink transmission time interval of a radio frame, where the first transmission time interval has a first transmission time interval length, where the radio frame has a second downlink transmission time interval having a second transmission time interval length which is different from the first transmission time interval length, and where the periodicity of the first UL-related control channel is independent from first downlink transmission time interval. In some examples, the periodicity of the second UL-related control channel is independent from the second downlink transmission time interval. In one example, the method further includes sending, by the UE, a second UL-related control within the second downlink transmission time interval of the radio frame.

In the same example or another example, the first UL-related control channel and the second UL-related control channel are transmitted in a common radio frame. In any one of the preceding examples, the first transmission time interval length and the second transmission time interval length may be dynamically determined by a base station based on characteristics of a first data and a second data, respectively. A user equipment and base station for performing wireless communications in accordance with this method is also provided.

In accordance with embodiment, a method of communicating data in a wireless channel is provided. In this embodiment, the method includes sending a first data to a first user equipment (UE) through a first transmission time interval (TTI) of a first downlink channel within a radio frame, and sending a second data to a second UE through a second TTI of a second downlink channel within the radio frame. The first transmission time interval has a first transmission time interval length, and the second TTI has a second TTI length that is different than the first TTI length. The first downlink channel carries a first UL-related control channel indicating uplink control information to the first UE. The second downlink channel carries a second UL-related control channel indicating uplink control information to the second UE. A periodicity of the first UL-related control channel is different than a periodicity of the second UL-related control channel. In one example, the first TTI corresponds to a first frequency band of a first time-frequency region, and the second TTI corresponds to a second frequency band of a second time-frequency region, where the first time-frequency region occupying a different bandwidth partition

than the second time-frequency region. In the same example, or another example, the uplink control information indicated in the first UL-related control channel and the second UL-related control comprises at least one of the a hybrid automatic repeat request (HARQ), an acknowledge/negative-acknowledge (ACK/NACK), and an UL grant. In any one of the preceding examples, or in another example, the first UL-related control channel and the second UL-related control channel are transmitted in a common radio frame. In any one of the preceding examples, or in another example, the first transmission time interval length and the second transmission time interval length are dynamically determined by the base station based on characteristics of a first data and a second data, respectively. In any one of the preceding examples, or in another example, the first transmission time interval length and the second transmission time interval length are dynamically determined by the base station based on at least one of a buffer size or a latency requirement associated with the first data and the second data, respectively. An apparatus for performing this method is also provided.

In accordance with another embodiment, another method of communicating data in a wireless channel is provided. In this embodiment, the method includes receiving a first UL-related control channel from a base station over a first downlink transmission time interval of a radio frame. The first transmission time interval has a first transmission time interval length. The radio frame has a second downlink transmission time interval that carries a second UL-related control channel. The second downlink transmission time interval having a second transmission time interval length which is different from the first transmission time interval length. A periodicity of the first UL-related control channel is different than a periodicity of the second UL-related control channel. In one example, the method further includes receiving the second UL-related control within the second downlink transmission time interval of the radio frame. In the same example, or another example, the first UL-related control channel and the second UL-related control channel are transmitted in a common radio frame. In any one of the preceding examples, or in another example, the first transmission time interval length and the second transmission time interval length are dynamically determined by a base station based on characteristics of a first data and a second data, respectively. An apparatus for performing this method is also provided.

In accordance with an embodiment method, a transmitting device receives from a first user equipment (UE) a first data through a first transmission time interval (TTI) of a first uplink (UL) channel within a radio frame. The first TTI has a first TTI length. The transmitting device receives a second data through a second TTI of a second UL channel within the radio frame. The second TTI has a second TTI length that is different than the first TTI length. The first TTI corresponds to a first frequency band of a first time-frequency region, and the second TTI corresponds to a second frequency band of a second time-frequency region. The first time-frequency region occupies a different bandwidth partition than the second time-frequency region. In some embodiments, the first time-frequency region and the second time-frequency region have different fixed time durations.

In accordance with the embodiment method, the transmitting device receives from a third UE a third data through a third TTI of a third UL channel within the radio frame. The third TTI has a third TTI length that is different than any of the first TTI length and the second TTI length, and the third corresponds to a third frequency band of a third time-

15

frequency region. The third time-frequency region occupies a different bandwidth partition than at least one of the first time-frequency region or the second time-frequency region. In some embodiments the first UE is same as the second UE, or the first UE is different than the second UE.

In accordance with the embodiment method, the transmitting device sends to the first UE a first message, the first message indicating the first TTI length. The transmitting device sends to the second UE a second message, the second message indicating the second TTI length. The first message and the second message may be transmitted in a group specific control channel, a UE specific control channel, or a common control channel.

In accordance with the embodiment method, the first TTI length and the second TTI length are dynamically determined based on at least one of: characteristics of the first data and the second data, respectively; buffer sizes or a latency requirements associated with the first data and the second data, respectively; and mobility characteristics of the first UE and the second UE, respectively. An apparatus for performing this embodiment method is also provided.

In accordance with an embodiment method, a user equipment (UE) sends to a transmitting device a first data through a first transmission time interval (TTI) of a first uplink (UL) channel within a radio frame. The first TTI has a first TTI length. The UE sends to the transmitting device a second data through a second TTI of a second UL channel within the radio frame. The second TTI has a second TTI length that is different than the first length. The first TTI corresponds to a first frequency band of a first time-frequency region, and the second TTI corresponds to a second frequency band of a second time-frequency region. The first time-frequency region occupies a different bandwidth partition than the second time-frequency region. In some embodiments, the first time-frequency region and the second time-frequency region have different fixed time durations.

In accordance with embodiment method, the UE sends to the transmitting device a third data through a third TTI of a third UL channel within the radio frame. The third TTI has a third TTI length that is different than any of the first TTI length and the second TTI length, and the third TTI corresponds to a third frequency band of a third time-frequency region. The third time-frequency region occupies a different bandwidth partition than at least one of the first time-frequency region or the second time-frequency region.

In accordance with embodiment method, the UE receives from the transmitting device a first message, the first message indicating the first TTI length. The UE receives from the transmitting device a second message, the second message indicating the second TTI length. The first message and the second message may be transmitted in a group specific control channel, a UE specific control channel, or a common control channel.

In accordance with embodiment method, the first TTI length and the second TTI length are dynamically determined based on at least one of: characteristics of the first data and the second data, respectively; buffer sizes or a latency requirements associated with the first data and the second data, respectively; and mobility characteristics of the UE. An apparatus for performing this embodiment method is also provided.

What is claimed:

1. A method comprising:

receiving, by an apparatus, a first indication in a first group control channel or a first UE-specific control channel within a first bandwidth partition of a carrier from a network device, the first indication indicating a

16

first downlink (DL) transmission time interval (TTI) length, wherein the first bandwidth partition comprises a first uplink related (UL-related) control channel carrying a first UL grant, wherein a first periodicity of the first UL grant is configurable by the network device, and wherein the first periodicity of the first UL grant is independent from the first DL TTI length; and receiving, by the apparatus, first DL data from the network device using the first DL TTI length.

2. The method of claim 1, further comprising: searching, by the apparatus, the first UL grant based on the first periodicity.

3. The method of claim 1, further comprising: receiving, by the apparatus, a second indication in a second group control channel or a second UE-specific control channel within a second bandwidth partition of the carrier from the network device, the second indication indicating a second DL TTI length, wherein the second bandwidth partition comprises a second UL-related control channel carrying a second UL grant, and wherein a second periodicity of the second UL grant is configurable; and

receiving, by the apparatus, second DL data from the network device using the second DL TTI length.

4. The method of claim 3, further comprising: searching, by the apparatus, the second UL grant based on the second periodicity.

5. The method of claim 3, wherein the first periodicity of the first UL grant is different from the second periodicity of the second UL grant.

6. The method of claim 3, wherein the first DL data is received in a first frequency bandwidth partition, the second DL data is received in a second frequency bandwidth partition, and the first frequency bandwidth partition and the second frequency bandwidth partition occupy same or different bandwidth partitions within one carrier.

7. The method of claim 3, wherein the second UL grant indicates a fourth TTI length, the method further comprising:

transmitting, by the apparatus, fourth data to the network device using the fourth TTI length.

8. The method of claim 1, wherein the first UL grant indicates a third TTI length, the method further comprising: transmitting, by the apparatus, third data to the network device using the third TTI length.

9. The method of claim 1, further comprising: receiving, by the apparatus, a third indication in the first UL grant from the network device, the third indication indicating a first UL TTI length; and transmitting, by the apparatus, first UL data to the network device using the first UL TTI length.

10. An apparatus comprising: one or more processors; and a non-transitory computer readable storage medium storing programming for execution by the one or more processors, the programming including instructions to: receive a first indication in a first group control channel or a first UE-specific control channel within a first bandwidth partition of a carrier from a network device, the first indication indicating a first downlink (DL) transmission time interval (TTI) length, wherein the first bandwidth partition comprises a first uplink related (UL-related) control channel carrying a first UL grant, wherein a first periodicity of the first UL grant is configurable by the network

17

device, and wherein the first periodicity of the first UL grant is independent from the first DL TTI length; and

receive first DL data from the network device using the first DL TTI length.

11. The apparatus of claim 10, the programming further including instructions to:

search the first UL grant based on the first periodicity.

12. The apparatus of claim 10, the programming further including instructions to:

receive a second indication in a second group control channel or a second UE-specific control channel within a second bandwidth partition of the carrier from the network device, the second indication indicating a second DL TTI length, wherein the second bandwidth partition comprises a second UL-related control channel carrying a second UL grant, and wherein a second periodicity of the second UL grant is configurable; and receive second DL data from the network device using the second DL TTI length.

13. The apparatus of claim 12, the programming further including instructions to:

search the second UL grant based on the second periodicity.

14. The apparatus of claim 12, wherein the first periodicity of the first UL grant is different from the second periodicity of the second UL grant.

15. The apparatus of claim 12, wherein the first DL data is received in a first frequency bandwidth partition, the second DL data is received in a second frequency bandwidth partition, and the first frequency bandwidth partition and the second frequency bandwidth partition occupy same or different bandwidth partitions within one carrier.

16. The apparatus of claim 12, wherein the second UL grant indicates a fourth TTI length, the programming further including instructions to:

transmit fourth data to the network device using the fourth TTI length.

17. The apparatus of claim 10, wherein the first UL grant indicates a third TTI length, the programming further including instructions to:

transmit third data to the network device using the third TTI length.

18. The apparatus of claim 10, the programming further including instructions to:

receive a third indication in the first UL grant from the network device, the third indication indicating a first UL TTI length; and

transmit first UL data to the network device using the first UL TTI length.

19. A method comprising:

sending, by a network device to a first user equipment (UE), a first indication in a first group control channel or a first UE-specific control channel within a first bandwidth partition of a carrier, the first indication indicating a first downlink (DL) transmission time interval (TTI) length, wherein the first bandwidth partition comprises a first uplink related (UL-related) control channel carrying a first UL grant, wherein a first periodicity of the first UL grant is configurable, and wherein the first periodicity of the first UL grant is independent from the first DL TTI length; and

sending, by the network device to the first UE, first DL data using the first DL TTI length.

20. The method of claim 19, further comprising:

sending, by the network device to a second UE, a second indication in a second group control channel or a

18

second UE-specific control channel within a second bandwidth partition of the carrier, the second indication indicating a second DL TTI length, wherein the second bandwidth partition comprises a second UL-related control channel carrying a second UL grant, and wherein a second periodicity of the second UL grant is configurable; and

sending, by the network device to the second UE, second DL data using the second TTI DL length.

21. The method of claim 20, wherein the first periodicity of the first UL grant is different from the second periodicity of the second UL grant.

22. The method of claim 20, wherein the first DL data is transmitted in a first frequency bandwidth partition of one carrier, the carrier has a second frequency bandwidth partition for transmitting the second DL data in the second frequency bandwidth partition, and the first frequency bandwidth partition and the second frequency bandwidth partition occupy same or different bandwidth partitions within the carrier.

23. The method of claim 20, wherein the second UL grant indicates a fourth TTI length, the method further comprising:

receiving, by the network device from the second UE, fourth data using the fourth TTI length.

24. The method of claim 19, wherein the first UL grant indicates a third TTI length, the method further comprising: receiving, by the network device from the first UE, third data using the third TTI length.

25. The method of claim 19, further comprising:

transmitting, by the network device, a third indication in the first UL grant, the third indication indicating a first UL TTI length; and

receiving, by the network device, first UL data using the first UL TTI length.

26. A network device comprising:

one or more processors; and

a non-transitory computer readable storage medium storing programming for execution by the one or more processors, the programming including instructions to: send, to a first user equipment (UE), a first indication in a first group control channel or a first UE-specific control channel within a first bandwidth partition of a carrier, the first indication indicating a first downlink (DL) transmission time interval (TTI) length, wherein the first bandwidth partition comprises a first uplink related (UL-related) control channel carrying a first UL grant, wherein a first periodicity of the first UL grant is configurable, and wherein the first periodicity of the first UL grant is independent from the first DL TTI length; and send, to the first UE, first DL data using the first DL TTI length.

27. The network device of claim 26, the programming further including instructions to:

send, to a second UE, a second indication in a second group control channel or a second UE-specific control channel within a second bandwidth partition of the carrier, the second indication indicating a second DL TTI length, wherein the second bandwidth partition comprises a second UL-related control channel carrying a second UL grant, and wherein a second periodicity of the second UL grant is configurable; and send, to the second UE, second DL data using the second DL TTI length.

19

28. The network device of claim 27, wherein the first periodicity of the first UL grant is different from the second periodicity of the second UL grant.

29. The network device of claim 27, wherein the first DL data is transmitted in a first frequency bandwidth partition of one carrier, the carrier has a second frequency bandwidth partition for transmitting the second DL data in the second frequency bandwidth partition, and the first frequency bandwidth partition and the second frequency bandwidth partition occupy different bandwidth partitions within the carrier.

30. The network device of claim 27, wherein the second UL grant indicates a fourth TTI length, the programming further including instructions to:

receive, from the second UE, fourth data using the fourth TTI length.

31. The network device of claim 26, wherein the first UL grant indicates a third TTI length, the programming further including instructions to:

receive, from the first UE, third data using the third TTI length.

32. The network device of claim 26, the programming further including instructions to:

transmitting, by the network device, a third indication in the first UL grant, the third indication indicating a first UL TTI length; and

receiving, by the network device, first UL data using the first UL TTI length.

33. A network system, comprising:

a network entity in a backhaul network communicating with a base station; and

the base station, the base station performs operations of:

sending, to a first user equipment (UE), a first indication in a first group control channel or a first UE-specific control channel within a first bandwidth partition of a carrier, the first indication indicating a first downlink (DL) transmission time interval (TTI) length, wherein the first bandwidth partition comprises a first uplink related (UL-related) control channel carrying a first UL grant, wherein a first periodicity of the first UL grant is configurable, and wherein the first periodicity of the first UL grant is independent from the first DL TTI length; and

20

sending, from the first UE, first DL data using the first DL TTI length.

34. The network system of claim 33, the operations further comprising:

sending, to a second UE, a second indication in a second group control channel or a second UE-specific control channel within a second bandwidth partition of the carrier, the second indication indicating a second DL TTI length, wherein the second bandwidth partition comprises a second UL-related control channel carrying a second UL grant, and wherein a second periodicity of the second UL grant is configurable; and

sending, to the second UE, second DL data using the second DL TTI length.

35. The network system of claim 34, wherein the first periodicity of the first UL grant is different from the second periodicity of the second UL grant.

36. The network system of claim 34, wherein the first DL data is transmitted in a first frequency bandwidth partition of one carrier, the carrier has a second frequency bandwidth partition for transmitting the second DL data in the second frequency bandwidth partition, and the first frequency bandwidth partition and the second frequency bandwidth partition occupy same or different bandwidth partitions within the carrier.

37. The network system of claim 34, wherein the second UL grant indicates a fourth TTI length, the operations further comprising:

receiving, from the second UE, fourth data using the fourth TTI length.

38. The network system of claim 33, wherein the first UL grant indicates a third TTI length, the operations further comprising:

receiving, from the first UE, third data using the third TTI length.

39. The network system of claim 33, the operations further comprising:

transmitting a third indication in the first UL grant, the third indication indicating a first UL TTI length; and receiving first UL data using the first UL TTI length.

* * * * *

UNITED STATES PATENT AND TRADEMARK OFFICE
CERTIFICATE OF CORRECTION

PATENT NO. : 11,039,435 B2
APPLICATION NO. : 16/191999
DATED : June 15, 2021
INVENTOR(S) : Au et al.

Page 1 of 1

It is certified that error appears in the above-identified patent and that said Letters Patent is hereby corrected as shown below:

In the Claims

In Claim 39, Column 20; Line 41 delete "ITT" insert --TTI--

Signed and Sealed this
Thirty-first Day of August, 2021



Drew Hirshfeld
*Performing the Functions and Duties of the
Under Secretary of Commerce for Intellectual Property and
Director of the United States Patent and Trademark Office*