



US011014374B2

(12) **United States Patent**
Soh

(10) **Patent No.:** **US 11,014,374 B2**
(45) **Date of Patent:** **May 25, 2021**

(54) **REGION-OF-INTEREST BASED PRINT QUALITY OPTIMIZATION**

(71) Applicant: **Datamax-O'Neil Corporation**,
Altamonte Springs, FL (US)

(72) Inventor: **Teck Siong Soh**, Singapore (SG)

(73) Assignee: **DATAMAX-O'NEIL CORPORATION**, Altamonte Springs,
FL (US)

(*) Notice: Subject to any disclaimer, the term of this patent is extended or adjusted under 35 U.S.C. 154(b) by 47 days.

(21) Appl. No.: **16/562,004**

(22) Filed: **Sep. 5, 2019**

(65) **Prior Publication Data**

US 2020/0039236 A1 Feb. 6, 2020

Related U.S. Application Data

(63) Continuation of application No. 16/112,108, filed on Aug. 24, 2018, now Pat. No. 10,710,375, which is a
(Continued)

(51) **Int. Cl.**
B41J 2/335 (2006.01)
B41J 2/36 (2006.01)
B41J 2/32 (2006.01)
B41J 2/355 (2006.01)
G06K 15/02 (2006.01)

(52) **U.S. Cl.**
CPC *B41J 2/335* (2013.01); *B41J 2/32* (2013.01); *B41J 2/3551* (2013.01); *B41J 2/36* (2013.01); *G06K 15/028* (2013.01)

(58) **Field of Classification Search**
CPC B41J 2/335; B41J 2/36; B41J 2/32; B41J 2/3551; B41J 29/38; G06K 15/028
See application file for complete search history.

(56) **References Cited**

U.S. PATENT DOCUMENTS

4,918,462 A 4/1990 Tomita et al.
5,085,529 A 2/1992 McGourty et al.
(Continued)

FOREIGN PATENT DOCUMENTS

CN 101242960 A 8/2008
CN 102407680 A 4/2012
(Continued)

OTHER PUBLICATIONS

Machine translation of JP 2000-108395, published on Apr. 2000.
(Year: 2000).*

(Continued)

Primary Examiner — Huan H Tran

(74) *Attorney, Agent, or Firm* — Alston & Bird LLP

(57) **ABSTRACT**

A method for printing includes analyzing print quality requirements for a printing area; adjusting settings for heater elements (e.g., energy and/or firing durations) of strobe lines based on the requirements analysis; and providing a plurality of individual strobe signals to the strobe lines. The strobe signals can be transmitted simultaneously, for example with a field-programmable gate array. Analyzing print quality requirements can include separating the printing area into one or more areas of interest, such as rows and/or columns. For each area of interest individual print quality settings (e.g., darkness, contrast, and/or media sensitivity) may be selected.

20 Claims, 6 Drawing Sheets

300 →

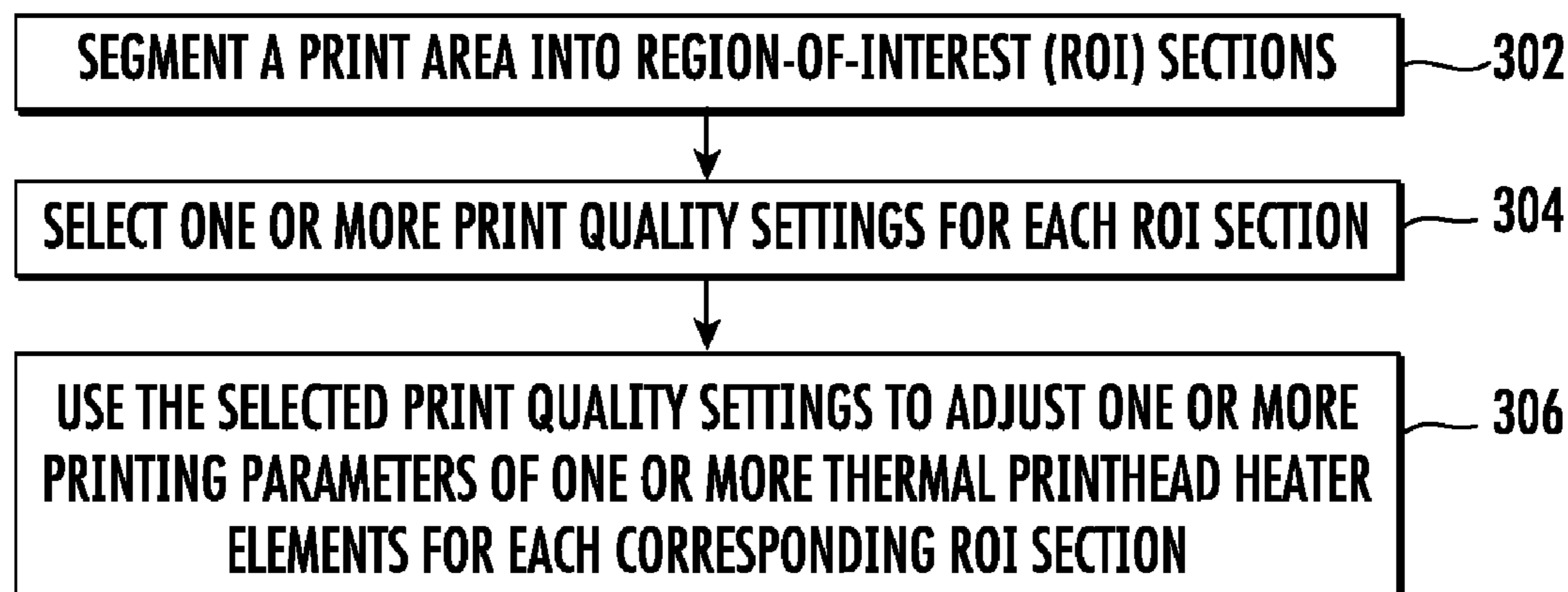

(56)

References Cited

U.S. PATENT DOCUMENTS

2015/0129659 A1 5/2015 Feng et al.
 2015/0133047 A1 5/2015 Smith et al.
 2015/0134470 A1 5/2015 Hejl et al.
 2015/0136851 A1 5/2015 Harding et al.
 2015/0136854 A1 5/2015 Lu et al.
 2015/0142492 A1 5/2015 Kumar
 2015/0144692 A1 5/2015 Hejl
 2015/0144698 A1 5/2015 Teng et al.
 2015/0144701 A1 5/2015 Xian et al.
 2015/0149946 A1 5/2015 Benos et al.
 2015/0161429 A1 6/2015 Xian
 2015/0169925 A1 6/2015 Chen et al.
 2015/0169929 A1 6/2015 Williams et al.
 2015/0178523 A1 6/2015 Gelay et al.
 2015/0178534 A1 6/2015 Jovanovski et al.
 2015/0178535 A1 6/2015 Bremer et al.
 2015/0178536 A1 6/2015 Hennick et al.
 2015/0178537 A1 6/2015 El et al.
 2015/0181093 A1 6/2015 Zhu et al.
 2015/0181109 A1 6/2015 Gillet et al.
 2015/0186703 A1 7/2015 Chen et al.
 2015/0193644 A1 7/2015 Kearney et al.
 2015/0193645 A1 7/2015 Colavito et al.
 2015/0199957 A1 7/2015 Funyak et al.
 2015/0204671 A1 7/2015 Showering
 2015/0210199 A1 7/2015 Payne
 2015/0220753 A1 8/2015 Zhu et al.
 2015/0254485 A1 9/2015 Feng et al.
 2015/0327012 A1 11/2015 Bian et al.
 2016/0014251 A1 1/2016 Hejl
 2016/0040982 A1 2/2016 Li et al.
 2016/0042241 A1 2/2016 Todeschini
 2016/0057230 A1 2/2016 Todeschini et al.
 2016/0109219 A1 4/2016 Ackley et al.
 2016/0109220 A1 4/2016 Laffargue et al.
 2016/0109224 A1 4/2016 Thuries et al.
 2016/0112631 A1 4/2016 Ackley et al.
 2016/0112643 A1 4/2016 Laffargue et al.
 2016/0124516 A1 5/2016 Schoon et al.
 2016/0125217 A1 5/2016 Todeschini
 2016/0125342 A1 5/2016 Miller et al.
 2016/0125873 A1 5/2016 Braho et al.
 2016/0133253 A1 5/2016 Braho et al.
 2016/0171720 A1 6/2016 Todeschini
 2016/0178479 A1 6/2016 Goldsmith
 2016/0180678 A1 6/2016 Ackley et al.
 2016/0189087 A1 6/2016 Morton et al.
 2016/0227912 A1 8/2016 Oberpriller et al.
 2016/0232891 A1 8/2016 Pecorari
 2016/0292477 A1 10/2016 Bidwell
 2016/0294779 A1 10/2016 Yeakley et al.
 2016/0306769 A1 10/2016 Kohtz et al.
 2016/0314276 A1 10/2016 Wilz et al.
 2016/0314294 A1 10/2016 Kubler et al.
 2016/0377414 A1 12/2016 Thuries et al.

FOREIGN PATENT DOCUMENTS

EP 1150245 A2 10/2001
 JP 60-168669 9/1985

JP 01-262155 A 10/1989
 JP H10-324015 A 12/1998
 JP 2000-108395 * 4/2000 B41J 2/355
 JP 2000-108395 A 4/2000
 WO 20131163789 A1 11/2013
 WO 20131173985 A1 11/2013
 WO 20141019130 A1 2/2014
 WO 20141110495 A1 7/2014

OTHER PUBLICATIONS

Annex to the communication dated May 14, 2020 for EP Application No. 18159338.5.
 Communication from the Examining Division dated May 14, 2020 for EP Application No. 18159338.5.
 Computer-generated translation of JP 2000-108395, published on Apr. 2000.
 U.S. Appl. for Terminal Having Illumination and Focus Control filed May 21, 2014 (Liu et al.); 31 pages; now abandoned., U.S. Appl. No. 14/283,282.
 U.S. Appl. No. 13/367,978, filed Feb. 7, 2012, (Feng et al.); now abandoned.
 U.S. Appl. No. 14/277,337 for Multipurpose Optical Reader, filed May 14, 2014 (Jovanovski et al.); 59 pages; now abandoned.
 U.S. Appl. No. 14/446,391 for Multifunction Point of Sale Apparatus With Optical Signature Capture filed Jul. 30, 2014 (Good et al.); 37 pages; now abandoned.
 Office Action for Chinese Patent Application No. 201810174593.1 dated Sep. 1, 2020, 17 pages.
 European search opinion dated Jul 6, 2018 for EP Application No. 18159338.5.
 European search report dated Jul 6, 2018 for EP Application No. 18159338.5.
 Non-Final Rejection dated Nov 15, 2018 for U.S. Appl. No. 16/112,108.
 Non-Final Rejection dated Sep 16, 2019 for U.S. Appl. No. 16/112,108.
 Notice of Allowance and Fees Due (PTOL-85) dated Jun 3, 2019 for U.S. Appl. No. 16/112,108.
 U.S. Appl. No. 16/112,108, filed Aug. 24, 2018, US-2018/0361757, Published.
 U.S. Appl. No. 15/449,445, filed Mar. 3, 2017, U.S. Pat. No. 10,105,963, Patented.
 Notice of Allowance and Fees Due (PTOL-85) dated Mar 4, 2020 for U.S. Appl. No. 16/112,108.
 Annex to the Communication Pursuant to Article 94(3) issued in EP Application No. 18159338.5 dated Dec. 23, 2020, 2 pages.
 Communication Pursuant to Article 94(3) issued in EP Application No. 18159338.5 dated Dec. 23, 2020, 2 pages.
 Notice of Allowance for U.S. Appl. No. 15/449,445, dated May 24, 2018, 5 pages.
 Office Action for U.S. Appl. No. 15/449,445, dated Jan. 25, 2018, 6 pages.
 U.S. Patent Application for Indicia Reader filed Apr. 1, 2015 (Huck), U.S. Appl. No. 14/676,109.
 Office Action issued in Chinese Application No. 201810174593.1 dated Mar. 9, 2021, 18 pages.

* cited by examiner

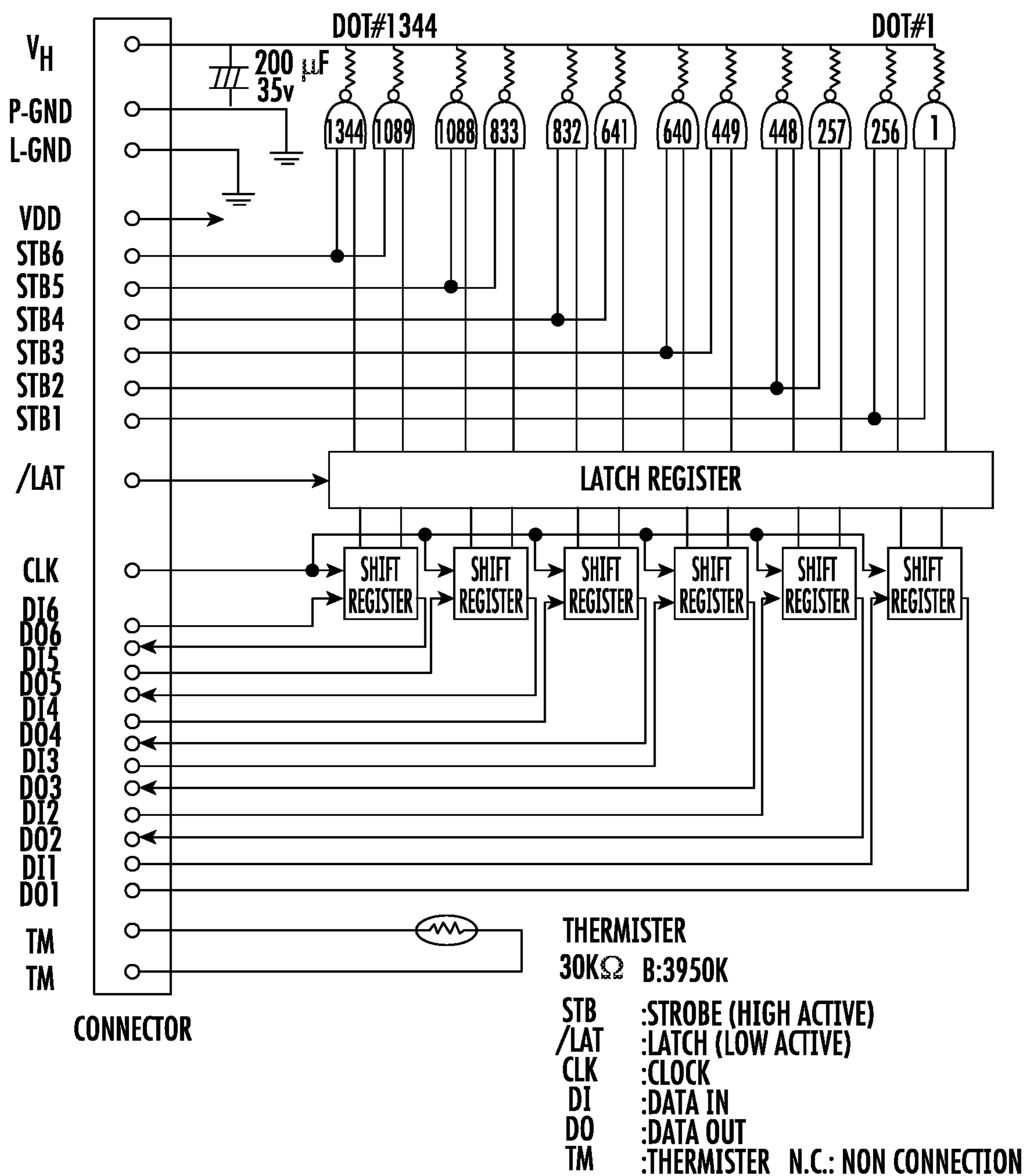
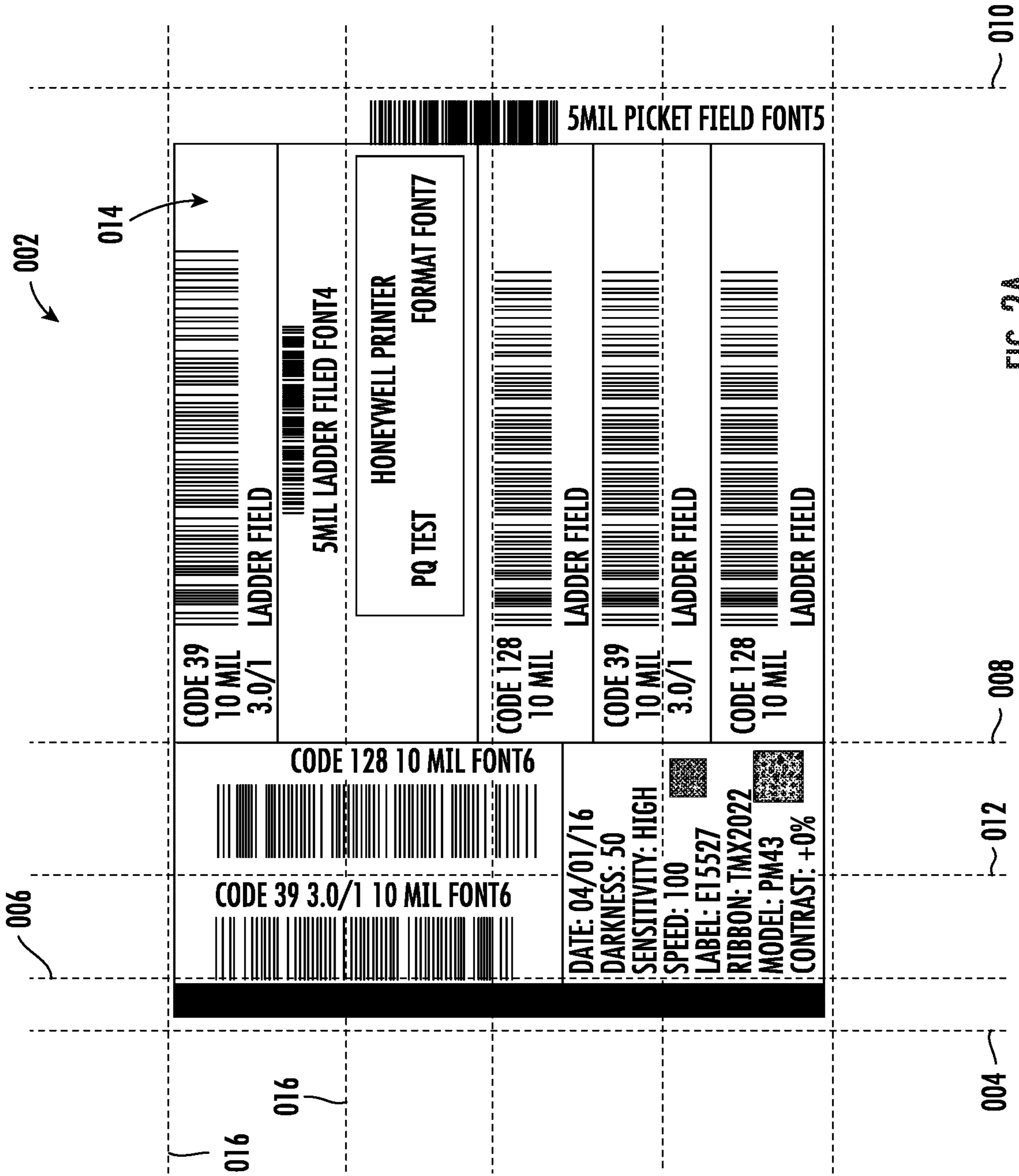

FIG. 1



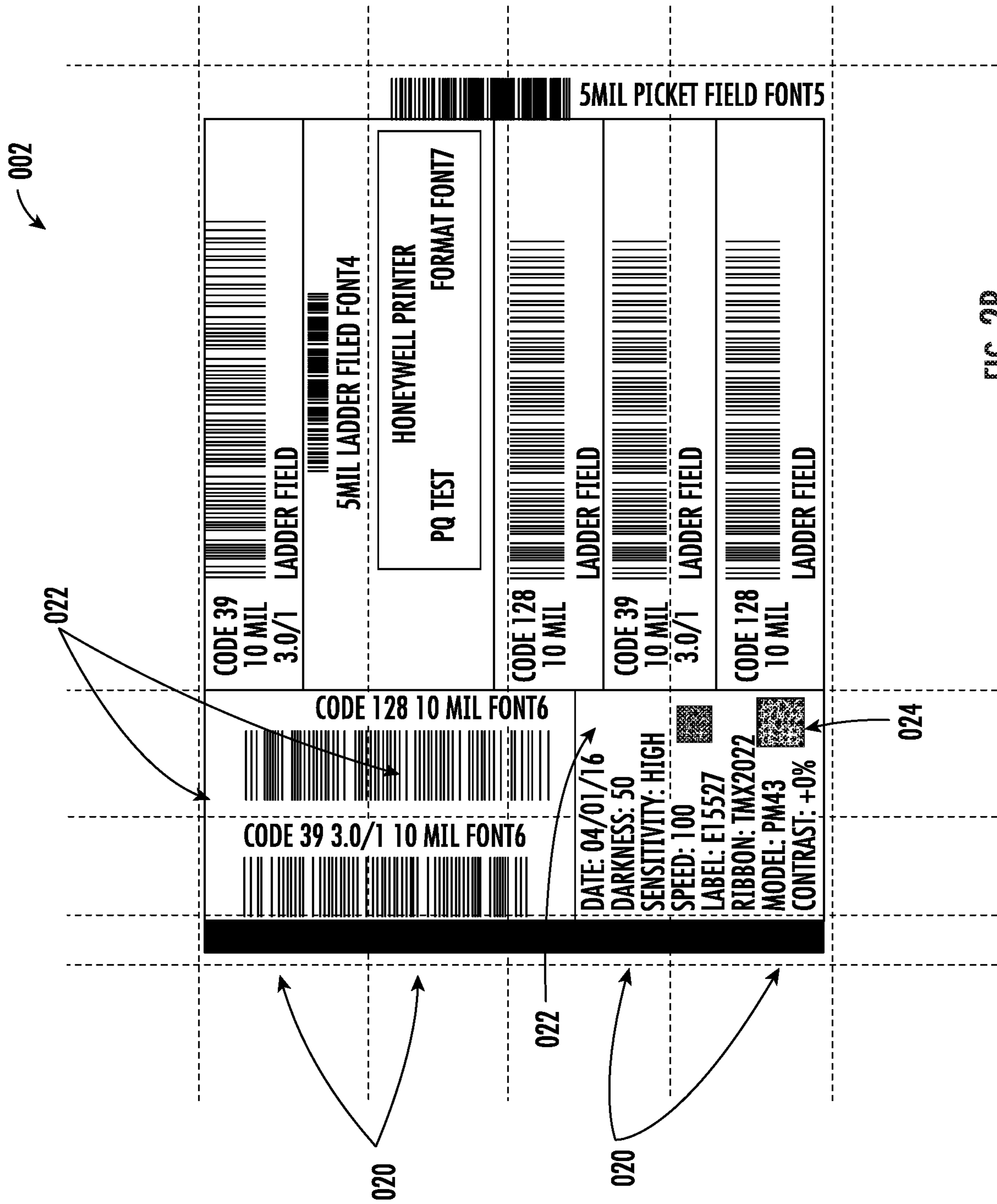

FIG. 2B

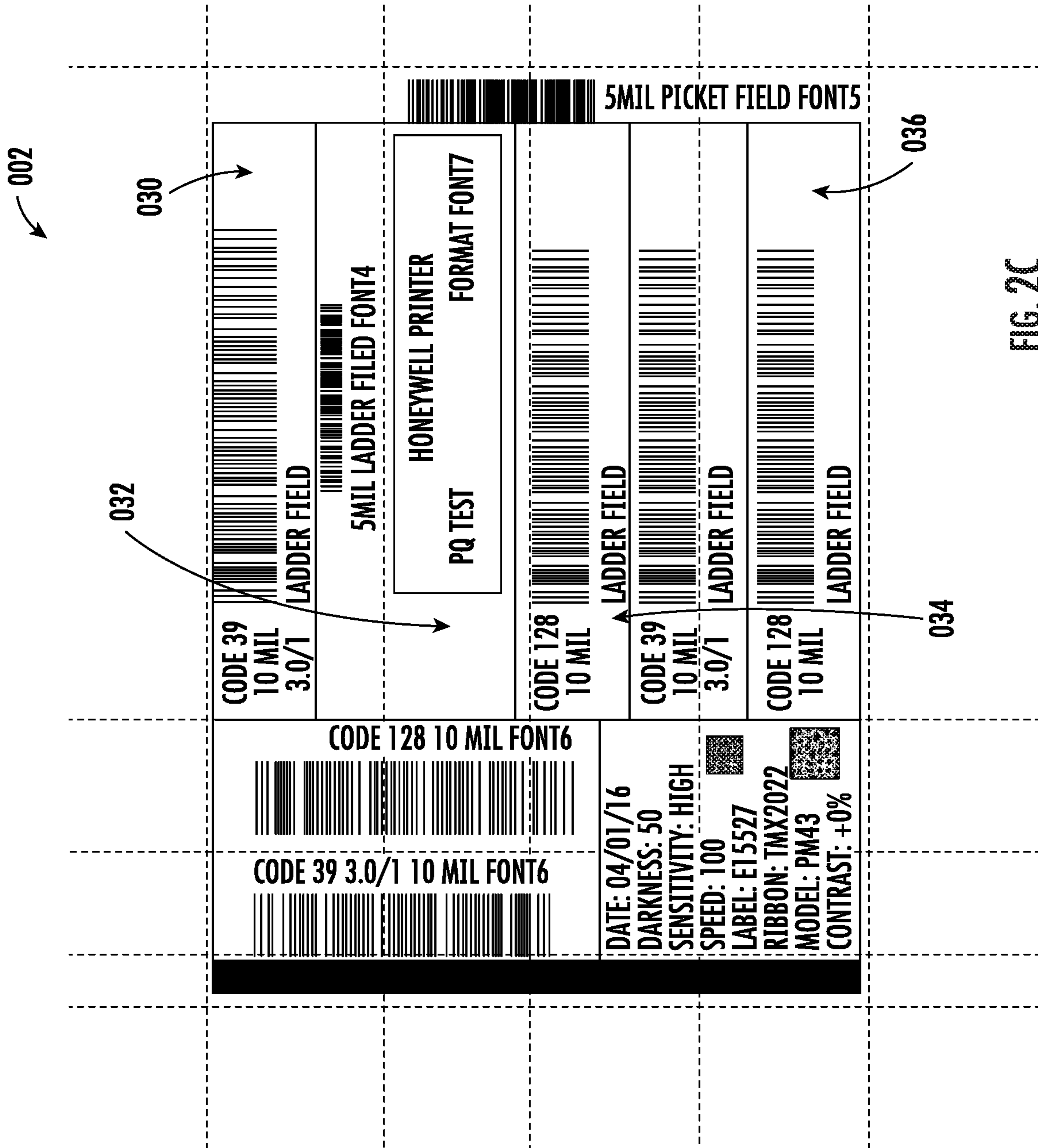

FIG. 2C

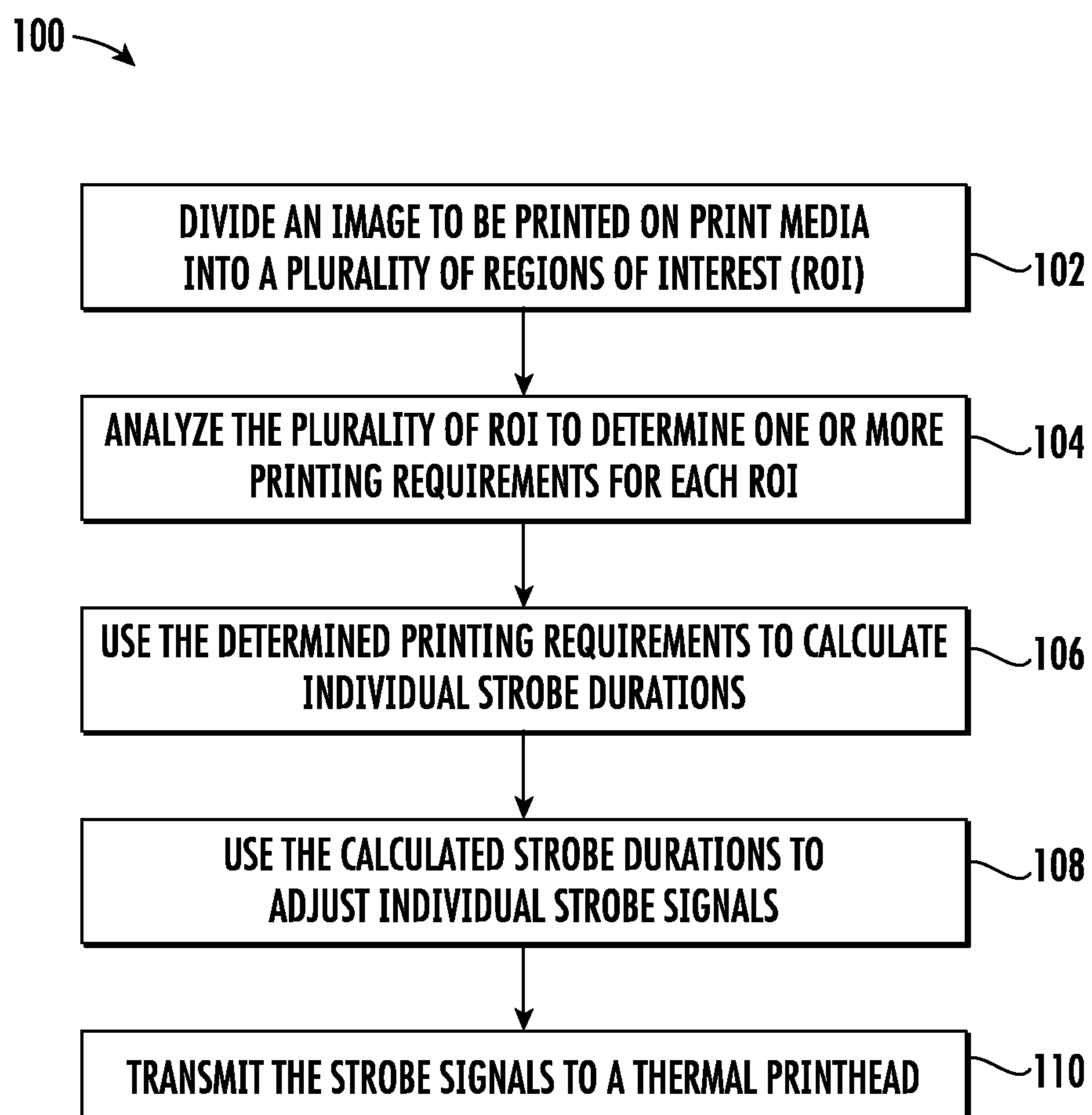

FIG. 3

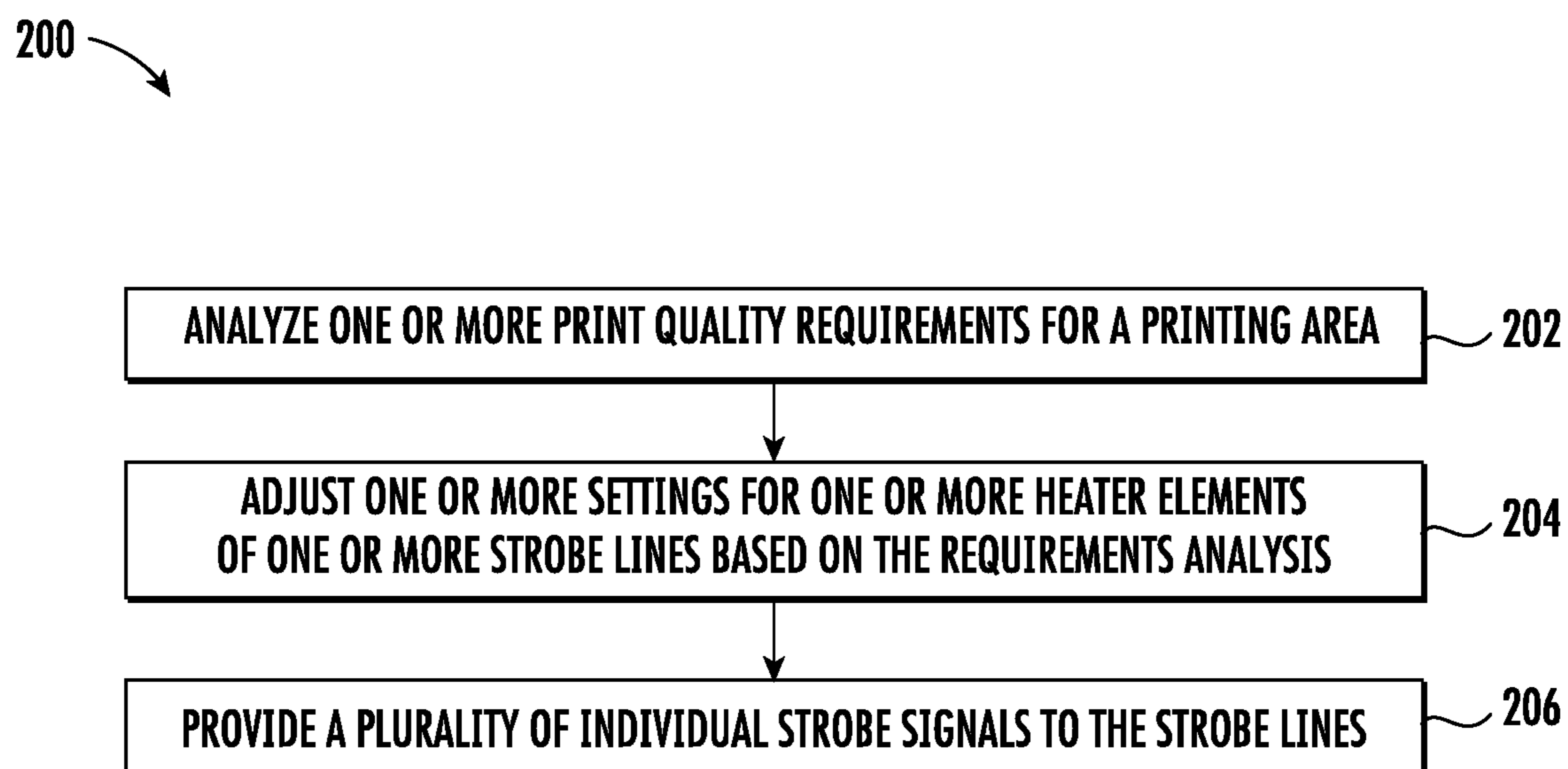

FIG. 4

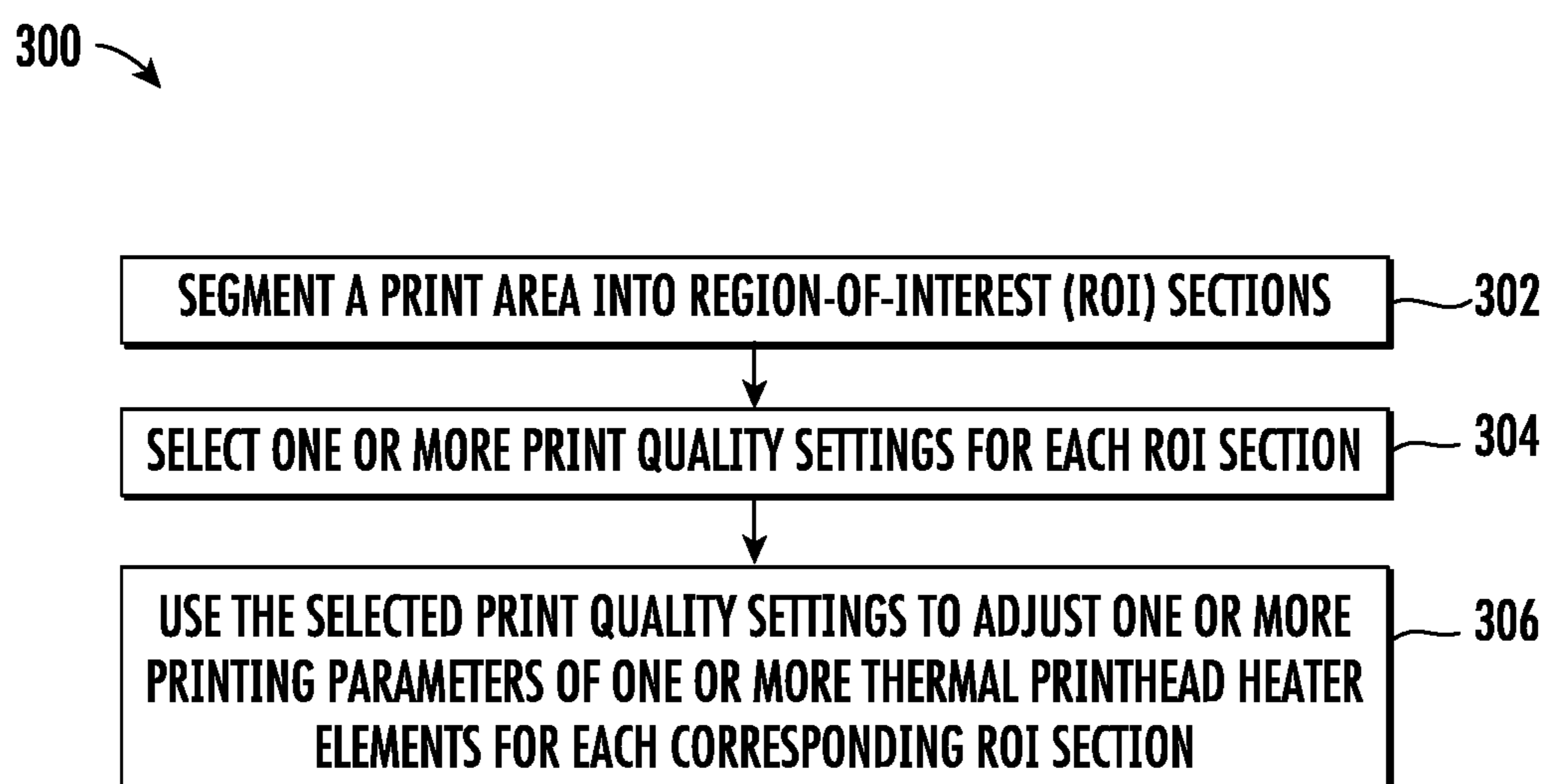

FIG. 5

REGION-OF-INTEREST BASED PRINT QUALITY OPTIMIZATION

CROSS-REFERENCE TO RELATED APPLICATIONS

This application is a continuation of U.S. patent application Ser. No. 16/112,108, filed Aug. 24, 2018, which is a continuation of U.S. patent application Ser. No. 15/449,445, filed Mar. 3, 2017, now U.S. Pat. No. 10,105,963, issued Oct. 23, 2018, each of which are hereby incorporated by reference in its entirety.

FIELD OF THE INVENTION

The present invention relates to print quality optimization, and more particularly to methods for print quality adjustment for individual regions of interest.

BACKGROUND

Generally speaking, multiple elements can be printed on the same label. For example, barcode symbologies (e.g., QR code, code 128, or code 39) can be combined with fonts or designs (e.g., black bar, or logo). Most printers allow selecting only unified print quality settings, which pertain to the collection of the elements to be printed in general, and do not take into account print quality requirements preferred for those elements individually. Consequently, the selected settings may not be optimal for every barcode symbology, font, and design on the label. This often leads to print quality variation between the elements displayed on the same label. Moreover, variation in thermal printhead pressure and heater element resistance may further lead to print quality variation throughout different areas of the same printed label.

Several attempts have been made to address this issue. For example, U.S. Pat. No. 8,774,654 by Kielland discloses a thermal printhead with four sets of heating elements arranged in rows, and controlled individually by driving circuits, while strobe signals are provided to each set in a particular pattern. However, the reference does not disclose print quality variation on desired regions within the same label. U.S. Pat. No. 5,809,214 by Nureki et al. discloses a thermal printer having a printhead divided into rows of heating blocks, which are driven by individual driver units. However, the reference does not disclose controlling heating arrays individually to optimize print quality of particular regions of a label. U.S. Pat. No. 5,085,529 by McGourty et al. discloses a method of printing on a print sheet having a score line across it. However, the reference does not disclose variation in print quality between different print areas. Additionally, the reference does not disclose a thermal printhead having multiple heating elements. U.S. Pat. No. 7,941,750 by Laughlin discloses an inkjet printer capable of adjusting print quality for different regions. However, the reference is not related to a thermal printer, and does not disclose individual control of multiple heating elements on a printhead for controlling print quality at a desired region of a print media. Consequently, none of the references mention printing different information of different print quality on desired regions of interest at a print media with a thermal printer.

Therefore, a need exists for a method of adjusting print quality settings, which can account for individual requirements of each element to be presented on print media.

SUMMARY

Accordingly, in one aspect, the present invention embraces print quality optimization based on dividing an

image to be printed on print media into regions of interest, and adjusting print quality settings for each region.

In an exemplary embodiment, a method for print settings control includes dividing an image to be printed on print media into regions of interest (ROI); analyzing the ROI to determine printing requirements for each ROI; calculating individual strobe durations and adjusting individual strobe signals; and transmitting the strobe signals to a thermal printhead.

In another exemplary embodiment, a method for printing includes analyzing print quality requirements for a printing area; adjusting settings for heater elements of strobe lines; and providing individual strobe signals to the strobe lines.

In yet another exemplary embodiment, a method for print quality adjustment includes segmenting a print area into region-of-interest sections; selecting print quality settings for each region-of-interest section; and adjusting printing parameters of thermal printhead heater elements for each corresponding region-of-interest section.

The foregoing illustrative summary, as well as other exemplary objectives and/or advantages of the invention, and the manner in which the same are accomplished, are further explained within the following detailed description and its accompanying drawings.

BRIEF DESCRIPTION OF THE DRAWINGS

FIG. 1 schematically depicts an exemplary embodiment of a thermal printhead circuit diagram.

FIG. 2A graphically depicts an image to be printed on print media divided into regions of interest, according to an embodiment.

FIG. 2B graphically depicts an image to be printed on print media divided into regions of interest, according to another embodiment.

FIG. 2C graphically depicts an image to be printed on print media divided into regions of interest, according to yet another embodiment.

FIG. 3 schematically depicts a method for print settings control, according to an embodiment.

FIG. 4 schematically depicts a method for printing, according to an embodiment.

FIG. 5 schematically depicts a method for print quality adjustment, according to an embodiment.

DETAILED DESCRIPTION

The present invention embraces methods for print quality adjustment for individual regions of interest.

Print quality settings of a printer are usually determined by balancing requirements for different barcode symbologies and designs to be printed on the same print media (e.g., a label), which can result in a print quality variation. To overcome this issue, a print area can be segmented into rows and/or columns of regions of interest, followed by applying separate print settings optimal for each element in each region of interest. Different print quality settings applied to individual regions can also be used to compensate for darkness variation in different areas of the print media. For example, the darkness variation can occur between a left and right sides of the printed label due to resistance and pressure variation.

FIG. 1 schematically depicts an exemplary embodiment of a thermal printhead circuit diagram. Firings of thermal printhead heater elements can be controlled by strobe lines (labeled STB1-STB6 in the diagram). Each strobe line can control firing durations of a group of heater elements (e.g.,

STB1 can control dots 1-256, etc.). By using different strobe signals for each of the strobe lines, energy of each heater element group can be adjusted by changing a corresponding strobe duration.

FIG. 2A graphically depicts an image **002** to be printed on print media divided into regions of interest, according to an embodiment. As shown in FIG. 2A, the first column of a region of interest (ROI) is marked with a first print line **004** and a next user defined print line **006**. The last column of the ROI is marked with a last user defined print line **008** and a last print line of the print job **010**. User can define any print line (for example, line **012**) as a vertical segmentation line of the ROIs. Each individual ROI can be identified by its row and/or column number. For example, ROI(1,4) **014** shown in FIG. 2A, refers to a ROI defined by the first row and the fourth column. Distance between rows **016** can be fixed, and determined by a heater element group. Printing direction can be chosen to be from the right-hand side of the figure to the left-hand side of the figure.

FIGS. 2B and 2C graphically depict an image **002** to be printed on print media divided into regions of interest, according to alternative embodiments. FIG. 2B shows how different groups of ROIs can be grouped together, and have print quality settings assigned to the groups to optimize print quality for different symbologies and designs. Specifically, Group A, marked with reference number **020**, includes ROI(1,1), ROI(2,1), ROI(3,1), and ROI(4,1); Group B includes ROI(1,2), ROI(2,2), and ROI(3, 2); Group C, marked with reference number **022**, includes ROI(1,3), ROI(2,3), and ROI(3,3); and Group D, marked with reference number **024**, includes ROI(4,3).

FIG. 2C shows how different groups of ROIs can be grouped together, and have print quality settings assigned to the groups to compensate for print quality variation from a left to a right side of the label. Specifically, Group A, marked with reference number **030**, includes ROI(1,1); Group B, marked with reference number **032**, includes ROI(2,1); Group C, marked with reference number **034**, includes ROI(3,1); and Group D, marked with reference number **036**, includes ROI(4,1).

FIG. 3 shows a method **100** for print settings control, according to an embodiment. At **102**, an image to be printed on print media is divided into a plurality of regions of interest. At **104**, the plurality of regions of interest is analyzed to determine one or more printing requirements for each region of interest. At **106**, the determined printing requirements are used to calculate individual strobe durations. At **108**, the calculated strobe durations are used to adjust individual strobe signals. At **110**, the strobe signals are transmitted to a thermal printhead.

In an embodiment, transmitting the strobe signals, **110**, can include transmitting all the strobe signals simultaneously. Additionally, transmitting the strobe signals simultaneously can include transmitting the signals with a field-programmable gate array (FPGA). Adjusting individual strobe signals, **108**, can include adjusting energy of one or more heater elements of the thermal printhead.

FIG. 4 shows a method **200** for printing, according to an embodiment. At **202**, one or more print quality requirements are analyzed for a printing area. At **204**, one or more settings for one or more heater elements of one or more strobe lines are adjusted based on the requirements analysis. At **206**, a plurality of individual strobe signals is provided to the strobe lines.

In an embodiment, adjusting settings for heater elements, **204**, can include adjusting energy and/or firing durations. Providing a plurality of individual strobe signals, **206**, can

include providing a plurality of individual strobe signals with an FPGA-based driver circuit. Analyzing print quality requirements for a printing area, **202**, can include separating the printing area into one or more areas of interest. Additionally, separating a printing area into areas of interest can include separating the printing area into rows and/or columns. The method **200** can further include determining individual print quality requirements for the one or more areas of interest. For example, print quality requirements can include temperature of a thermal printhead, tension on a platen roller, and/or printing speed. Additionally, analyzing print quality requirements, **202**, can include analyzing a print job request.

FIG. 5 shows a method **300** for print quality adjustment, according to an embodiment. At **302**, a print area is segmented into region-of-interest sections. At **304**, one or more print quality settings are selected for each region-of-interest section. At **306**, the selected print quality settings are used to adjust one or more printing parameters of one or more thermal printhead heater elements for each corresponding region-of-interest section.

In an embodiment, segmenting a print area into region-of-interest sections, **302**, can include segmenting the print area in rows. Additionally, the method **300** can include segmenting the print area in columns. Adjusting printing parameters, **306**, can include adjusting strobe durations for one or more heater groups. Selecting print quality settings, **304**, can include selecting darkness, contrast, and/or media sensitivity. Segmenting a print area, **302**, can include segmenting a print area having one or more barcodes and/or one or more designs.

Device and method components are meant to show only those specific details that are pertinent to understanding the embodiments of the present disclosure so as not to obscure the disclosure with details that will be readily apparent to those of ordinary skill in the art having the benefit of the description herein. In various embodiments, the sequence in which the elements of appear in exemplary embodiments disclosed herein may vary. Two or more method steps may be performed simultaneously or in a different order than the sequence in which the elements appear in the exemplary embodiments.

To supplement the present disclosure, this application incorporates entirely by reference the following commonly assigned patents, patent application publications, and patent applications:

U.S. Pat. Nos. 6,832,725; 7,128,266; 7,159,783; 7,413,127; 7,726,575 8,294,969; 8,317,105; 8,322,622; 8,366,005; 8,371,507; 8,376,233; 8,381,979; 8,390,909; 8,408,464; 8,408,468; 8,408,469; 8,424,768; 8,448,863; 8,457,013; 8,459,557; 8,469,272; 8,474,712; 8,479,992; 8,490,877; 8,517,271; 8,523,076; 8,528,818; 8,544,737; 8,548,242; 8,548,420; 8,550,335; 8,550,354; 8,550,357; 8,556,174; 8,556,176; 8,556,177; 8,559,767; 8,599,957; 8,561,895; 8,561,903; 8,561,905; 8,565,107; 8,571,307; 8,579,200; 8,583,924; 8,584,945; 8,587,595; 8,587,697; 8,588,869; 8,590,789; 8,596,539; 8,596,542; 8,596,543; 8,599,271; 8,599,957; 8,600,158; 8,600,167; 8,602,309; 8,608,053; 8,608,071; 8,611,309; 8,615,487; 8,616,454; 8,621,123; 8,622,303; 8,628,013; 8,628,015; 8,628,016; 8,629,926; 8,630,491; 8,635,309; 8,636,200; 8,636,212; 8,636,215; 8,636,224; 8,638,806; 8,640,958; 8,640,960; 8,643,717; 8,646,692; 8,646,694; 8,657,200; 8,659,397; 8,666,149; 8,678,285; 8,678,286; 8,682,077; 8,687,282; 8,692,927; 8,695,880; 8,698,949; 8,717,494; 8,717,494; 8,720,783; 8,723,804; 8,723,904; 8,727,223; D702,237; 8,740,082; 8,740,085; 8,746,563; 8,750,445; 8,752,766; 8,756,059;

8,757,495; 8,760,563; 8,763,909; 8,777,108; 8,777,109;
 8,779,898; 8,781,520; 8,783,573; 8,789,757; 8,789,758;
 8,789,759; 8,794,520; 8,794,522; 8,794,525; 8,794,526;
 8,798,367; 8,807,431; 8,807,432; 8,820,630; 8,822,848;
 8,824,692; 8,824,696; 8,842,849; 8,844,822; 8,844,823; 5
 8,849,019; 8,851,383; 8,854,633; 8,866,963; 8,868,421;
 8,868,519; 8,868,802; 8,868,803; 8,870,074; 8,879,639;
 8,880,426; 8,881,983; 8,881,987; 8,903,172; 8,908,995;
 8,910,870; 8,910,875; 8,914,290; 8,914,788; 8,915,439;
 8,915,444; 8,916,789; 8,918,250; 8,918,564; 8,925,818; 10
 8,939,374; 8,942,480; 8,944,313; 8,944,327; 8,944,332;
 8,950,678; 8,967,468; 8,971,346; 8,976,030; 8,976,368;
 8,978,981; 8,978,983; 8,978,984; 8,985,456; 8,985,457;
 8,985,459; 8,985,461; 8,988,578; 8,988,590; 8,991,704;
 8,996,194; 8,996,384; 9,002,641; 9,007,368; 9,010,641; 15
 9,015,513; 9,016,576; 9,022,288; 9,030,964; 9,033,240;
 9,033,242; 9,036,054; 9,037,344; 9,038,911; 9,038,915;
 9,047,098; 9,047,359; 9,047,420; 9,047,525; 9,047,531;
 9,053,055; 9,053,378; 9,053,380; 9,058,526; 9,064,165;
 9,064,167; 9,064,168; 9,064,254; 9,066,032; 9,070,032; 20
 U.S. Design Pat. No. D716,285;
 U.S. Design Pat. No. D723,560;
 U.S. Design Pat. No. D730,357;
 U.S. Design Pat. No. D730,901;
 U.S. Design Pat. No. D730,902;
 U.S. Design Pat. No. D733,112;
 U.S. Design Pat. No. D734,339;
 International Publication No. 2013/163789;
 International Publication No. 2013/173985;
 International Publication No. 2014/019130;
 International Publication No. 2014/110495; 30
 U.S. Patent Application Publication No. 2008/0185432;
 U.S. Patent Application Publication No. 2009/0134221;
 U.S. Patent Application Publication No. 2010/0177080;
 U.S. Patent Application Publication No. 2010/0177076;
 U.S. Patent Application Publication No. 2010/0177707; 35
 U.S. Patent Application Publication No. 2010/0177749;
 U.S. Patent Application Publication No. 2010/0265880;
 U.S. Patent Application Publication No. 2011/0202554;
 U.S. Patent Application Publication No. 2012/0111946; 40
 U.S. Patent Application Publication No. 2012/0168511;
 U.S. Patent Application Publication No. 2012/0168512;
 U.S. Patent Application Publication No. 2012/0193423;
 U.S. Patent Application Publication No. 2012/0203647;
 U.S. Patent Application Publication No. 2012/0223141; 45
 U.S. Patent Application Publication No. 2012/0228382;
 U.S. Patent Application Publication No. 2012/0248188;
 U.S. Patent Application Publication No. 2013/0043312;
 U.S. Patent Application Publication No. 2013/0082104;
 U.S. Patent Application Publication No. 2013/0175341; 50
 U.S. Patent Application Publication No. 2013/0175343;
 U.S. Patent Application Publication No. 2013/0257744;
 U.S. Patent Application Publication No. 2013/0257759;
 U.S. Patent Application Publication No. 2013/0270346;
 U.S. Patent Application Publication No. 2013/0287258; 55
 U.S. Patent Application Publication No. 2013/0292475;
 U.S. Patent Application Publication No. 2013/0292477;
 U.S. Patent Application Publication No. 2013/0293539;
 U.S. Patent Application Publication No. 2013/0293540;
 U.S. Patent Application Publication No. 2013/0306728; 60
 U.S. Patent Application Publication No. 2013/0306731;
 U.S. Patent Application Publication No. 2013/0307964;
 U.S. Patent Application Publication No. 2013/0308625;
 U.S. Patent Application Publication No. 2013/0313324;
 U.S. Patent Application Publication No. 2013/0313325; 65
 U.S. Patent Application Publication No. 2013/0342717;
 U.S. Patent Application Publication No. 2014/0001267;

U.S. Patent Application Publication No. 2014/0008439;
 U.S. Patent Application Publication No. 2014/0025584;
 U.S. Patent Application Publication No. 2014/0034734;
 U.S. Patent Application Publication No. 2014/0036848;
 U.S. Patent Application Publication No. 2014/0039693;
 U.S. Patent Application Publication No. 2014/0042814;
 U.S. Patent Application Publication No. 2014/0049120;
 U.S. Patent Application Publication No. 2014/0049635;
 U.S. Patent Application Publication No. 2014/0061306;
 U.S. Patent Application Publication No. 2014/0063289;
 U.S. Patent Application Publication No. 2014/0066136;
 U.S. Patent Application Publication No. 2014/0067692;
 U.S. Patent Application Publication No. 2014/0070005;
 U.S. Patent Application Publication No. 2014/0071840;
 U.S. Patent Application Publication No. 2014/0074746;
 U.S. Patent Application Publication No. 2014/0076974;
 U.S. Patent Application Publication No. 2014/0078341;
 U.S. Patent Application Publication No. 2014/0078345;
 U.S. Patent Application Publication No. 2014/0097249;
 U.S. Patent Application Publication No. 2014/0098792;
 U.S. Patent Application Publication No. 2014/0100813;
 U.S. Patent Application Publication No. 2014/0103115;
 U.S. Patent Application Publication No. 2014/0104413;
 U.S. Patent Application Publication No. 2014/0104414;
 U.S. Patent Application Publication No. 2014/0104416; 25
 U.S. Patent Application Publication No. 2014/0104451;
 U.S. Patent Application Publication No. 2014/0106594;
 U.S. Patent Application Publication No. 2014/0106725;
 U.S. Patent Application Publication No. 2014/0108010;
 U.S. Patent Application Publication No. 2014/0108402; 30
 U.S. Patent Application Publication No. 2014/0110485;
 U.S. Patent Application Publication No. 2014/0114530;
 U.S. Patent Application Publication No. 2014/0124577;
 U.S. Patent Application Publication No. 2014/0124579;
 U.S. Patent Application Publication No. 2014/0125842; 35
 U.S. Patent Application Publication No. 2014/0125853;
 U.S. Patent Application Publication No. 2014/0125999;
 U.S. Patent Application Publication No. 2014/0129378;
 U.S. Patent Application Publication No. 2014/0131438;
 U.S. Patent Application Publication No. 2014/0131441; 40
 U.S. Patent Application Publication No. 2014/0131443;
 U.S. Patent Application Publication No. 2014/0131444;
 U.S. Patent Application Publication No. 2014/0131445;
 U.S. Patent Application Publication No. 2014/0131448;
 U.S. Patent Application Publication No. 2014/0133379; 45
 U.S. Patent Application Publication No. 2014/0136208;
 U.S. Patent Application Publication No. 2014/0140585;
 U.S. Patent Application Publication No. 2014/0151453;
 U.S. Patent Application Publication No. 2014/0152882;
 U.S. Patent Application Publication No. 2014/0158770; 50
 U.S. Patent Application Publication No. 2014/0159869;
 U.S. Patent Application Publication No. 2014/0166755;
 U.S. Patent Application Publication No. 2014/0166759;
 U.S. Patent Application Publication No. 2014/0168787;
 U.S. Patent Application Publication No. 2014/0175165; 55
 U.S. Patent Application Publication No. 2014/0175172;
 U.S. Patent Application Publication No. 2014/0191644;
 U.S. Patent Application Publication No. 2014/0191913;
 U.S. Patent Application Publication No. 2014/0197238;
 U.S. Patent Application Publication No. 2014/0197239; 60
 U.S. Patent Application Publication No. 2014/0197304;
 U.S. Patent Application Publication No. 2014/0214631;
 U.S. Patent Application Publication No. 2014/0217166;
 U.S. Patent Application Publication No. 2014/0217180;
 U.S. Patent Application Publication No. 2014/0231500; 65
 U.S. Patent Application Publication No. 2014/0232930;
 U.S. Patent Application Publication No. 2014/0247315;

U.S. Patent Application Publication No. 2014/0263493;
 U.S. Patent Application Publication No. 2014/0263645;
 U.S. Patent Application Publication No. 2014/0267609;
 U.S. Patent Application Publication No. 2014/0270196;
 U.S. Patent Application Publication No. 2014/0270229;
 U.S. Patent Application Publication No. 2014/0278387;
 U.S. Patent Application Publication No. 2014/0278391;
 U.S. Patent Application Publication No. 2014/0282210;
 U.S. Patent Application Publication No. 2014/0284384;
 U.S. Patent Application Publication No. 2014/0288933;
 U.S. Patent Application Publication No. 2014/0297058;
 U.S. Patent Application Publication No. 2014/0299665;
 U.S. Patent Application Publication No. 2014/0312121;
 U.S. Patent Application Publication No. 2014/0319220;
 U.S. Patent Application Publication No. 2014/0319221;
 U.S. Patent Application Publication No. 2014/0326787;
 U.S. Patent Application Publication No. 2014/0332590;
 U.S. Patent Application Publication No. 2014/0344943;
 U.S. Patent Application Publication No. 2014/0346233;
 U.S. Patent Application Publication No. 2014/0351317;
 U.S. Patent Application Publication No. 2014/0353373;
 U.S. Patent Application Publication No. 2014/0361073;
 U.S. Patent Application Publication No. 2014/0361082;
 U.S. Patent Application Publication No. 2014/0362184;
 U.S. Patent Application Publication No. 2014/0363015;
 U.S. Patent Application Publication No. 2014/0369511;
 U.S. Patent Application Publication No. 2014/0374483;
 U.S. Patent Application Publication No. 2014/0374485;
 U.S. Patent Application Publication No. 2015/0001301;
 U.S. Patent Application Publication No. 2015/0001304;
 U.S. Patent Application Publication No. 2015/0003673;
 U.S. Patent Application Publication No. 2015/0009338;
 U.S. Patent Application Publication No. 2015/0009610;
 U.S. Patent Application Publication No. 2015/0014416;
 U.S. Patent Application Publication No. 2015/0021397;
 U.S. Patent Application Publication No. 2015/0028102;
 U.S. Patent Application Publication No. 2015/0028103;
 U.S. Patent Application Publication No. 2015/0028104;
 U.S. Patent Application Publication No. 2015/0029002;
 U.S. Patent Application Publication No. 2015/0032709;
 U.S. Patent Application Publication No. 2015/0039309;
 U.S. Patent Application Publication No. 2015/0039878;
 U.S. Patent Application Publication No. 2015/0040378;
 U.S. Patent Application Publication No. 2015/0048168;
 U.S. Patent Application Publication No. 2015/0049347;
 U.S. Patent Application Publication No. 2015/0051992;
 U.S. Patent Application Publication No. 2015/0053766;
 U.S. Patent Application Publication No. 2015/0053768;
 U.S. Patent Application Publication No. 2015/0053769;
 U.S. Patent Application Publication No. 2015/0060544;
 U.S. Patent Application Publication No. 2015/0062366;
 U.S. Patent Application Publication No. 2015/0063215;
 U.S. Patent Application Publication No. 2015/0063676;
 U.S. Patent Application Publication No. 2015/0069130;
 U.S. Patent Application Publication No. 2015/0071819;
 U.S. Patent Application Publication No. 2015/0083800;
 U.S. Patent Application Publication No. 2015/0086114;
 U.S. Patent Application Publication No. 2015/0088522;
 U.S. Patent Application Publication No. 2015/0096872;
 U.S. Patent Application Publication No. 2015/0099557;
 U.S. Patent Application Publication No. 2015/0100196;
 U.S. Patent Application Publication No. 2015/0102109;
 U.S. Patent Application Publication No. 2015/0115035;
 U.S. Patent Application Publication No. 2015/0127791;
 U.S. Patent Application Publication No. 2015/0128116;
 U.S. Patent Application Publication No. 2015/0129659;
 U.S. Patent Application Publication No. 2015/0133047;

U.S. Patent Application Publication No. 2015/0134470;
 U.S. Patent Application Publication No. 2015/0136851;
 U.S. Patent Application Publication No. 2015/0136854;
 U.S. Patent Application Publication No. 2015/0142492;
 U.S. Patent Application Publication No. 2015/0144692;
 U.S. Patent Application Publication No. 2015/0144698;
 U.S. Patent Application Publication No. 2015/0144701;
 U.S. Patent Application Publication No. 2015/0149946;
 U.S. Patent Application Publication No. 2015/0161429;
 U.S. Patent Application Publication No. 2015/0169925;
 U.S. Patent Application Publication No. 2015/0169929;
 U.S. Patent Application Publication No. 2015/0178523;
 U.S. Patent Application Publication No. 2015/0178534;
 U.S. Patent Application Publication No. 2015/0178535;
 U.S. Patent Application Publication No. 2015/0178536;
 U.S. Patent Application Publication No. 2015/0178537;
 U.S. Patent Application Publication No. 2015/0181093;
 U.S. Patent Application Publication No. 2015/0181109;
 U.S. patent application Ser. No. 13/367,978 for a LASER
 SCANNING MODULE EMPLOYING AN ELASTO-
 MERIC U-HINGE BASED LASER SCANNING ASSEM-
 BLY, filed Feb. 7, 2012 (Feng et al.);
 U.S. patent application Ser. No. 29/458,405 for an ELEC-
 TRONIC DEVICE, filed Jun. 19, 2013 (Fitch et al.);
 U.S. patent application Ser. No. 29/459,620 for an ELEC-
 TRONIC DEVICE ENCLOSURE, filed Jul. 2, 2013 (Lon-
 don et al.);
 U.S. patent application Ser. No. 29/468,118 for an ELEC-
 TRONIC DEVICE CASE, filed Sep. 26, 2013 (Oberpriller
 et al.);
 U.S. patent application Ser. No. 14/150,393 for INDICIA-
 READER HAVING UNITARY CONSTRUCTION SCAN-
 NER, filed Jan. 8, 2014 (Colavito et al.);
 U.S. patent application Ser. No. 14/200,405 for INDICIA
 READER FOR SIZE-LIMITED APPLICATIONS filed
 Mar. 7, 2014 (Feng et al.);
 U.S. patent application Ser. No. 14/231,898 for HAND-
 MOUNTED INDICIA-READING DEVICE WITH FIN-
 GER MOTION TRIGGERING filed Apr. 1, 2014 (Van Horn
 et al.);
 U.S. patent application Ser. No. 29/486,759 for an IMAG-
 ING TERMINAL, filed Apr. 2, 2014 (Oberpriller et al.);
 U.S. patent application Ser. No. 14/257,364 for DOCK-
 ING SYSTEM AND METHOD USING NEAR FIELD
 COMMUNICATION filed Apr. 21, 2014 (Showering);
 U.S. patent application Ser. No. 14/264,173 for AUTO-
 FOCUS LENS SYSTEM FOR INDICIA READERS filed
 Apr. 29, 2014 (Ackley et al.);
 U.S. patent application Ser. No. 14/277,337 for MULTI-
 PURPOSE OPTICAL READER, filed May 14, 2014 (Jo-
 vanovski et al.);
 U.S. patent application Ser. No. 14/283,282 for TERMI-
 NAL HAVING ILLUMINATION AND FOCUS CON-
 TROL filed May 21, 2014 (Liu et al.);
 U.S. patent application Ser. No. 14/327,827 for a
 MOBILE-PHONE ADAPTER FOR ELECTRONIC
 TRANSACTIONS, filed Jul. 10, 2014 (Hejl);
 U.S. patent application Ser. No. 14/334,934 for a SYS-
 TEM AND METHOD FOR INDICIA VERIFICATION,
 filed Jul. 18, 2014 (Hejl);
 U.S. patent application Ser. No. 14/339,708 for LASER
 SCANNING CODE SYMBOL READING SYSTEM, filed
 Jul. 24, 2014 (Xian et al.);
 U.S. patent application Ser. No. 14/340,627 for an AXI-
 ALLY REINFORCED FLEXIBLE SCAN ELEMENT, filed
 Jul. 25, 2014 (Rueblinger et al.);

U.S. patent application Ser. No. 14/446,391 for MULTI-FUNCTION POINT OF SALE APPARATUS WITH OPTICAL SIGNATURE CAPTURE filed Jul. 30, 2014 (Good et al.);

U.S. patent application Ser. No. 14/452,697 for INTERACTIVE INDICIA READER, filed Aug. 6, 2014 (Todeschini);

U.S. patent application Ser. No. 14/453,019 for DIMENSIONING SYSTEM WITH GUIDED ALIGNMENT, filed Aug. 6, 2014 (Li et al.);

U.S. patent application Ser. No. 14/462,801 for MOBILE COMPUTING DEVICE WITH DATA COGNITION SOFTWARE, filed on Aug. 19, 2014 (Todeschini et al.);

U.S. patent application Ser. No. 14/483,056 for VARIABLE DEPTH OF FIELD BARCODE SCANNER filed Sep. 10, 2014 (McCloskey et al.);

U.S. patent application Ser. No. 14/513,808 for IDENTIFYING INVENTORY ITEMS IN A STORAGE FACILITY filed Oct. 14, 2014 (Singel et al.);

U.S. patent application Ser. No. 14/519,195 for HANDHELD DIMENSIONING SYSTEM WITH FEEDBACK filed Oct. 21, 2014 (Laffargue et al.);

U.S. patent application Ser. No. 14/519,179 for DIMENSIONING SYSTEM WITH MULTIPATH INTERFERENCE MITIGATION filed Oct. 21, 2014 (Thuries et al.);

U.S. patent application Ser. No. 14/519,211 for SYSTEM AND METHOD FOR DIMENSIONING filed Oct. 21, 2014 (Ackley et al.);

U.S. patent application Ser. No. 14/519,233 for HANDHELD DIMENSIONER WITH DATA-QUALITY INDICATION filed Oct. 21, 2014 (Laffargue et al.);

U.S. patent application Ser. No. 14/519,249 for HANDHELD DIMENSIONING SYSTEM WITH MEASUREMENT-CONFORMANCE FEEDBACK filed Oct. 21, 2014 (Ackley et al.);

U.S. patent application Ser. No. 14/527,191 for METHOD AND SYSTEM FOR RECOGNIZING SPEECH USING WILDCARDS IN AN EXPECTED RESPONSE filed Oct. 29, 2014 (Braho et al.);

U.S. patent application Ser. No. 14/529,563 for ADAPTABLE INTERFACE FOR A MOBILE COMPUTING DEVICE filed Oct. 31, 2014 (Schoon et al.);

U.S. patent application Ser. No. 14/529,857 for BARCODE READER WITH SECURITY FEATURES filed Oct. 31, 2014 (Todeschini et al.);

U.S. patent application Ser. No. 14/398,542 for PORTABLE ELECTRONIC DEVICES HAVING A SEPARATE LOCATION TRIGGER UNIT FOR USE IN CONTROLLING AN APPLICATION UNIT filed Nov. 3, 2014 (Bian et al.);

U.S. patent application Ser. No. 14/531,154 for DIRECTING AN INSPECTOR THROUGH AN INSPECTION filed Nov. 3, 2014 (Miller et al.);

U.S. patent application Ser. No. 14/533,319 for BARCODE SCANNING SYSTEM USING WEARABLE DEVICE WITH EMBEDDED CAMERA filed Nov. 5, 2014 (Todeschini);

U.S. patent application Ser. No. 14/535,764 for CONCATENATED EXPECTED RESPONSES FOR SPEECH RECOGNITION filed Nov. 7, 2014 (Braho et al.);

U.S. patent application Ser. No. 14/568,305 for AUTO-CONTRAST VIEWFINDER FOR AN INDICIA READER filed Dec. 12, 2014 (Todeschini);

U.S. patent application Ser. No. 14/573,022 for DYNAMIC DIAGNOSTIC INDICATOR GENERATION filed Dec. 17, 2014 (Goldsmith);

U.S. patent application Ser. No. 14/578,627 for SAFETY SYSTEM AND METHOD filed Dec. 22, 2014 (Ackley et al.);

U.S. patent application Ser. No. 14/580,262 for MEDIA GATE FOR THERMAL TRANSFER PRINTERS filed Dec. 23, 2014 (Bowles);

U.S. patent application Ser. No. 14/590,024 for SHELVING AND PACKAGE LOCATING SYSTEMS FOR DELIVERY VEHICLES filed Jan. 6, 2015 (Payne);

U.S. patent application Ser. No. 14/596,757 for SYSTEM AND METHOD FOR DETECTING BARCODE PRINTING ERRORS filed Jan. 14, 2015 (Ackley);

U.S. patent application Ser. No. 14/416,147 for OPTICAL READING APPARATUS HAVING VARIABLE SETTINGS filed Jan. 21, 2015 (Chen et al.);

U.S. patent application Ser. No. 14/614,706 for DEVICE FOR SUPPORTING AN ELECTRONIC TOOL ON A USER'S HAND filed Feb. 5, 2015 (Oberpriller et al.);

U.S. patent application Ser. No. 14/614,796 for CARGO APPORTIONMENT TECHNIQUES filed Feb. 5, 2015 (Morton et al.);

U.S. patent application Ser. No. 29/516,892 for TABLE COMPUTER filed Feb. 6, 2015 (Bidwell et al.);

U.S. patent application Ser. No. 14/619,093 for METHODS FOR TRAINING A SPEECH RECOGNITION SYSTEM filed Feb. 11, 2015 (Pecorari);

U.S. patent application Ser. No. 14/628,708 for DEVICE, SYSTEM, AND METHOD FOR DETERMINING THE STATUS OF CHECKOUT LANES filed Feb. 23, 2015 (Todeschini);

U.S. patent application Ser. No. 14/630,841 for TERMINAL INCLUDING IMAGING ASSEMBLY filed Feb. 25, 2015 (Gomez et al.);

U.S. patent application Ser. No. 14/635,346 for SYSTEM AND METHOD FOR RELIABLE STORE-AND-FORWARD DATA HANDLING BY ENCODED INFORMATION READING TERMINALS filed Mar. 2, 2015 (Sevier);

U.S. Patent application Ser. No. 29/519,017 for SCANNER filed Mar. 2, 2015 (Zhou et al.);

U.S. Patent application Ser. No. 14/405,278 for DESIGN PATTERN FOR SECURE STORE filed Mar. 9, 2015 (Zhu et al.);

U.S. patent application Ser. No. 14/660,970 for DECODABLE INDICIA READING TERMINAL WITH COMBINED ILLUMINATION filed Mar. 18, 2015 (Kearney et al.);

U.S. patent application Ser. No. 14/661,013 for REPROGRAMMING SYSTEM AND METHOD FOR DEVICES INCLUDING PROGRAMMING SYMBOL filed Mar. 18, 2015 (Soule et al.);

U.S. patent application Ser. No. 14/662,922 for MULTI-FUNCTION POINT OF SALE SYSTEM filed Mar. 19, 2015 (Van Horn et al.);

U.S. patent application Ser. No. 14/663,638 for VEHICLE MOUNT COMPUTER WITH CONFIGURABLE IGNITION SWITCH BEHAVIOR filed Mar. 20, 2015 (Davis et al.);

U.S. patent application Ser. No. 14/664,063 for METHOD AND APPLICATION FOR SCANNING A BARCODE WITH A SMART DEVICE WHILE CONTINUOUSLY RUNNING AND DISPLAYING AN APPLICATION ON THE SMART DEVICE DISPLAY filed Mar. 20, 2015 (Todeschini);

U.S. patent application Ser. No. 14/669,280 for TRANSFORMING COMPONENTS OF A WEB PAGE TO VOICE PROMPTS filed Mar. 26, 2015 (Funyak et al.);

U.S. patent application Ser. No. 14/674,329 for AIMER FOR BARCODE SCANNING filed Mar. 31, 2015 (Bidwell);

U.S. patent application Ser. No. 14/676,109 for INDICIA READER filed Apr. 1, 2015 (Huck);

U.S. patent application Ser. No. 14/676,327 for DEVICE MANAGEMENT PROXY FOR SECURE DEVICES filed Apr. 1, 2015 (Yeakley et al.);

U.S. patent application Ser. No. 14/676,898 for NAVIGATION SYSTEM CONFIGURED TO INTEGRATE MOTION SENSING DEVICE INPUTS filed Apr. 2, 2015 (Showering);

U.S. patent application Ser. No. 14/679,275 for DIMENSIONING SYSTEM CALIBRATION SYSTEMS AND METHODS filed Apr. 6, 2015 (Laffargue et al.);

U.S. patent application Ser. No. 29/523,098 for HANDLE FOR A TABLET COMPUTER filed Apr. 7, 2015 (Bidwell et al.);

U.S. patent application Ser. No. 14/682,615 for SYSTEM AND METHOD FOR POWER MANAGEMENT OF MOBILE DEVICES filed Apr. 9, 2015 (Murawski et al.);

U.S. patent application Ser. No. 14/686,822 for MULTIPLE PLATFORM SUPPORT SYSTEM AND METHOD filed Apr. 15, 2015 (Qu et al.);

U.S. patent application Ser. No. 14/687,289 for SYSTEM FOR COMMUNICATION VIA A PERIPHERAL HUB filed Apr. 15, 2015 (Kohtz et al.);

U.S. patent application Ser. No. 29/524,186 for SCANNER filed Apr. 17, 2015 (Zhou et al.);

U.S. patent application Ser. No. 14/695,364 for MEDICATION MANAGEMENT SYSTEM filed Apr. 24, 2015 (Sewell et al.);

U.S. patent application Ser. No. 14/695,923 for SECURE UNATTENDED NETWORK AUTHENTICATION filed Apr. 24, 2015 (Kubler et al.);

U.S. patent application Ser. No. 29/525,068 for TABLET COMPUTER WITH REMOVABLE SCANNING DEVICE filed Apr. 27, 2015 (Schulte et al.);

U.S. patent application Ser. No. 14/699,436 for SYMBOL READING SYSTEM HAVING PREDICTIVE DIAGNOSTICS filed Apr. 29, 2015 (Nahill et al.);

U.S. patent application Ser. No. 14/702,110 for SYSTEM AND METHOD FOR REGULATING BARCODE DATA INJECTION INTO A RUNNING APPLICATION ON A SMART DEVICE filed May 1, 2015 (Todeschini et al.);

U.S. patent application Ser. No. 14/702,979 for TRACKING BATTERY CONDITIONS filed May 4, 2015 (Young et al.);

U.S. patent application Ser. No. 14/704,050 for INTERMEDIATE LINEAR POSITIONING filed May 5, 2015 (Charpentier et al.);

U.S. patent application Ser. No. 14/705,012 for HANDS-FREE HUMAN MACHINE INTERFACE RESPONSIVE TO A DRIVER OF A VEHICLE filed May 6, 2015 (Fitch et al.);

U.S. patent application Ser. No. 14/705,407 for METHOD AND SYSTEM TO PROTECT SOFTWARE-BASED NETWORK-CONNECTED DEVICES FROM ADVANCED PERSISTENT THREAT filed May 6, 2015 (Hussey et al.);

U.S. patent application Ser. No. 14/707,037 for SYSTEM AND METHOD FOR DISPLAY OF INFORMATION USING A VEHICLE-MOUNT COMPUTER filed May 8, 2015 (Chamberlin);

U.S. patent application Ser. No. 14/707,123 for APPLICATION INDEPENDENT DEX/UCS INTERFACE filed May 8, 2015 (Pape);

U.S. patent application Ser. No. 14/707,492 for METHOD AND APPARATUS FOR READING OPTICAL INDICIA USING A PLURALITY OF DATA SOURCES filed May 8, 2015 (Smith et al.);

U.S. patent application Ser. No. 14/710,666 for PREPAID USAGE SYSTEM FOR ENCODED INFORMATION READING TERMINALS filed May 13, 2015 (Smith);

U.S. patent application Ser. No. 29/526,918 for CHARGING BASE filed May 14, 2015 (Fitch et al.);

U.S. patent application Ser. No. 14/715,672 for AUGMENTED REALITY ENABLED HAZARD DISPLAY filed May 19, 2015 (Venkatesha et al.);

U.S. patent application Ser. No. 14/715,916 for EVALUATING IMAGE VALUES filed May 19, 2015 (Ackley);

U.S. patent application Ser. No. 14/722,608 for INTERACTIVE USER INTERFACE FOR CAPTURING A DOCUMENT IN AN IMAGE SIGNAL filed May 27, 2015 (Showering et al.);

U.S. patent application Ser. No. 29/528,165 for IN-COUNTER BARCODE SCANNER filed May 27, 2015 (Oberpriller et al.);

U.S. patent application Ser. No. 14/724,134 for ELECTRONIC DEVICE WITH WIRELESS PATH SELECTION CAPABILITY filed May 28, 2015 (Wang et al.);

U.S. patent application Ser. No. 14/724,849 for METHOD OF PROGRAMMING THE DEFAULT CABLE INTERFACE SOFTWARE IN AN INDICIA READING DEVICE filed May 29, 2015 (Barten);

U.S. patent application Ser. No. 14/724,908 for IMAGING APPARATUS HAVING IMAGING ASSEMBLY filed May 29, 2015 (Barber et al.);

U.S. patent application Ser. No. 14/725,352 for APPARATUS AND METHODS FOR MONITORING ONE OR MORE PORTABLE DATA TERMINALS (Caballero et al.);

U.S. patent application Ser. No. 29/528,590 for ELECTRONIC DEVICE filed May 29, 2015 (Fitch et al.);

U.S. patent application Ser. No. 29/528,890 for MOBILE COMPUTER HOUSING filed Jun. 2, 2015 (Fitch et al.);

U.S. patent application Ser. No. 14/728,397 for DEVICE MANAGEMENT USING VIRTUAL INTERFACES CROSS-REFERENCE TO RELATED APPLICATIONS filed Jun. 2, 2015 (Caballero);

U.S. patent application Ser. No. 14/732,870 for DATA COLLECTION MODULE AND SYSTEM filed Jun. 8, 2015 (Powilleit);

U.S. patent application Ser. No. 29/529,441 for INDICIA READING DEVICE filed Jun. 8, 2015 (Zhou et al.);

U.S. patent application Ser. No. 14/735,717 for INDICIA-READING SYSTEMS HAVING AN INTERFACE WITH A USER'S NERVOUS SYSTEM filed Jun. 10, 2015 (Todeschini);

U.S. patent application Ser. No. 14/738,038 for METHOD OF AND SYSTEM FOR DETECTING OBJECT WEIGHING INTERFERENCES filed Jun. 12, 2015 (Amundsen et al.);

U.S. patent application Ser. No. 14/740,320 for TACTILE SWITCH FOR A MOBILE ELECTRONIC DEVICE filed Jun. 16, 2015 (Bandringa); U.S. patent application Ser. No. 14/740,373 for CALIBRATING A VOLUME DIMENSIONER filed Jun. 16, 2015 (Ackley et al.);

U.S. patent application Ser. No. 14/742,818 for INDICIA READING SYSTEM EMPLOYING DIGITAL GAIN CONTROL filed Jun. 18, 2015 (Xian et al.);

U.S. patent application Ser. No. 14/743,257 for WIRELESS MESH POINT PORTABLE DATA TERMINAL filed Jun. 18, 2015 (Wang et al.);

U.S. patent application Ser. No. 29/530,600 for CYCLONE filed Jun. 18, 2015 (Vargo et al.);

U.S. patent application Ser. No. 14/744,633 for IMAGING APPARATUS COMPRISING IMAGE SENSOR ARRAY HAVING SHARED GLOBAL SHUTTER CIRCUITRY filed Jun. 19, 2015 (Wang);

U.S. patent application Ser. No. 14/744,836 for CLOUD-BASED SYSTEM FOR READING OF DECODABLE INDICIA filed Jun. 19, 2015 (Todeschini et al.);

U.S. patent application Ser. No. 14/745,006 for SELECTIVE OUTPUT OF DECODED MESSAGE DATA filed Jun. 19, 2015 (Todeschini et al.);

U.S. patent application Ser. No. 14/747,197 for OPTICAL PATTERN PROJECTOR filed Jun. 23, 2015 (Thuries et al.);

U.S. patent application Ser. No. 14/747,490 for DUAL-PROJECTOR THREE-DIMENSIONAL SCANNER filed Jun. 23, 2015 (Jovanovski et al.); and

U.S. patent application Ser. No. 14/748,446 for CORDLESS INDICIA READER WITH A MULTIFUNCTION COIL FOR WIRELESS CHARGING AND EAS DEACTIVATION, filed Jun. 24, 2015 (Xie et al.).

In the specification and/or figures, typical embodiments of the invention have been disclosed. The present invention is not limited to such exemplary embodiments. The use of the term “and/or” includes any and all combinations of one or more of the associated listed items. The figures are schematic representations and so are not necessarily drawn to scale. Unless otherwise noted, specific terms have been used in a generic and descriptive sense and not for purposes of limitation.

The invention claimed is:

1. A method for print settings control, the method comprising:

analyzing a content region in a print job request to determine one or more printing requirements for the content region;

based upon the one or more printing requirements for the content region, selecting one or more print quality settings for the content region; and

using the selected print quality settings to set one or more printing parameters for one or more thermal printhead heater elements that correspond to the content region.

2. The method according to claim **1**, wherein using the selected print quality settings to set the one or more printing parameters for the one or more thermal printhead heater elements further comprises based upon the set one or more printing parameters, calculating at least one individual strobe duration.

3. The method according to claim **2**, further comprising: setting at least one strobe signal based on the calculated at least one individual strobe duration; and

transmitting the at least one strobe signal to a thermal printhead to set the one or more thermal printhead heater elements.

4. The method according to claim **2**, wherein the calculated at least one individual strobe duration corresponds to an energy level of the one or more thermal printhead heater elements.

5. The method according to claim **1**, wherein the print job request comprises the content region and another content region.

6. The method according to claim **5**, further comprising analyzing the another content region to determine one or more printing requirements for the another content region; and

based upon the one or more printing requirements for the another content region, selecting one or more print quality settings for the another content region; and using the selected print quality settings to set one or more printing parameters of one or more thermal printhead heater elements that correspond to the another content region.

7. The method according to claim **1**, wherein the selected print quality settings are configured to compensate print quality variation from a left to a right side of a print area.

8. The method according to claim **1**, wherein the one or more printing requirements for the content region comprise one or more of an energy level, a battery level, a temperature of a thermal printhead, a tension on a platen roller, a selected print quality setting, or a printing speed.

9. The method according to claim **1**, wherein using the selected print quality settings to set the one or more printing parameters for the one or more thermal printhead heater elements that correspond to the content region further comprises setting an energy level for the one or more thermal printhead heater elements.

10. The method according to claim **1**, wherein using the selected print quality settings to set the one or more printing parameters for the one or more thermal printhead heater elements that correspond to the content region further comprises setting a firing duration for the one or more thermal printhead heater elements.

11. An apparatus for print settings control, the apparatus comprising:

a processor and a non-transitory memory including program code, the non-transitory memory and the program code configured to, with the processor, cause the apparatus to at least:

analyze a content region in a print job request to determine one or more printing requirements for the content region;

based upon the one or more printing requirements for the content region, select one or more print quality settings for the content region; and

use the selected print quality settings to set one or more printing parameters for one or more thermal printhead heater elements that correspond to the content region.

12. The apparatus according to claim **11**, wherein the at least one non-transitory memory and the program code that is configured to, with the processor, cause the apparatus to at least use the selected print quality settings to set the one or more printing parameters for the one or more thermal printhead heater elements is further configured to, based upon the set one or more printing parameters, calculate at least one individual strobe duration.

13. The apparatus according to claim **12**, wherein the at least one non-transitory memory and the program code is further configured to, with the processor, cause the apparatus to at least:

set at least one strobe signal based on the calculated at least one individual strobe duration; and

transmit the at least one strobe signal to a thermal printhead to set the one or more thermal printhead heater elements.

14. The apparatus according to claim **12**, wherein the calculated at least one individual strobe duration corresponds to an energy level of the one or more thermal printhead heater elements.

15. The apparatus according to claim **11**, wherein the print job request comprises the content region and another content region.

15

16. The apparatus according to claim **15**, wherein the at least one non-transitory memory and the program code is further configured to, with the processor, cause the apparatus to at least

analyze the another content region to determine one or more printing requirements for the another content region; and

based upon the one or more printing requirements for the another content region, select one or more print quality settings for the another content region; and

use the selected print quality settings to set one or more printing parameters of one or more thermal printhead heater elements that correspond to the another content region.

17. The apparatus according to claim **11**, wherein the selected print quality settings are configured to compensate print quality variation from a left to a right side of a print area.

18. The apparatus according to claim **11**, wherein the one or more printing requirements for the content region com-

16

prise one or more of an energy level, a battery level, a temperature of a thermal printhead, a tension on a platen roller, a selected print quality setting, or a printing speed.

19. The apparatus according to claim **11**, wherein the at least one non-transitory memory and the program code that is configured to, with the processor, cause the apparatus to at least use the selected print quality settings to set the one or more printing parameters for the one or more thermal printhead heater elements that correspond to the content region is further configured to set an energy level for the one or more thermal printhead heater elements.

20. The apparatus according to claim **11**, wherein the at least one non-transitory memory and the program code that is configured to, with the processor, cause the apparatus to at least use the selected print quality settings to set the one or more printing parameters for the one or more thermal printhead heater elements that correspond to the content region is further configured to set a firing duration for the one or more thermal printhead heater elements.

* * * * *