

US010936178B2

(12) **United States Patent**
Desmond et al.

(10) **Patent No.:** **US 10,936,178 B2**
(45) **Date of Patent:** **Mar. 2, 2021**

(54) **SYSTEMS AND METHODS FOR ANALYZING AND ORGANIZING DIGITAL PHOTOS AND VIDEOS**

16/54 (2019.01); *G06K 9/00288* (2013.01);
G06K 9/00744 (2013.01); *G06K 9/6215* (2013.01)

(71) Applicant: **MemoryWeb, LLC**, Glen Ellyn, IL (US)

(58) **Field of Classification Search**

CPC *G06F 3/04845*; *G06F 16/51*; *G06F 16/54*;
G06F 3/0482; *G06K 9/00288*; *G06K 9/00744*; *G06K 9/6215*

(72) Inventors: **Christopher J. Desmond**, Glen Ellyn, IL (US); **Nancy L. Desmond**, Glen Ellyn, IL (US); **L. Micahel Taylor**, Chicago, IL (US)

See application file for complete search history.

(73) Assignee: **MemoryWeb, LLC**, Glen Ellyn, IL (US)

(56) **References Cited**

U.S. PATENT DOCUMENTS

(*) Notice: Subject to any disclaimer, the term of this patent is extended or adjusted under 35 U.S.C. 154(b) by 0 days.

5,634,095 A * 5/1997 Wang *G06F 8/34*
715/763
6,722,574 B2 * 4/2004 Skantze *G06F 3/04886*
235/487

(Continued)

(21) Appl. No.: **16/719,798**

Primary Examiner — Jung-Mu T Chuang

(22) Filed: **Dec. 18, 2019**

(74) *Attorney, Agent, or Firm* — Nixon Peabody LLP

(65) **Prior Publication Data**

US 2020/0218435 A1 Jul. 9, 2020

(57) **ABSTRACT**

A computer-implemented method includes causing a first one of a plurality of digital photographs to be displayed on a video display device. Responsive to receiving an indication that a user desires to digitally link the first digital photograph with another one of the plurality of photographs, the method includes prompting the user to select one of the plurality of digital photographs to be digitally linked to the first digital photograph. Responsive to the user selecting a second one of the plurality of digital photographs, the method includes digitally linking the first digital photograph with the second digital photograph. The method includes causing the first digital photograph to be displayed with a user-selectable flipping element. Responsive to receiving a selection of the displayed user-selectable flipping element, the method includes causing the first digital photograph to be digitally flipped such that the second digital photograph is displayed on the video display device.

Related U.S. Application Data

(60) Provisional application No. 62/789,288, filed on Jan. 7, 2019.

(51) **Int. Cl.**

G06F 3/0484 (2013.01)
G06K 9/00 (2006.01)
G06F 16/54 (2019.01)
G06F 3/0482 (2013.01)

(Continued)

(52) **U.S. Cl.**

CPC *G06F 3/04845* (2013.01); *G06F 3/0482* (2013.01); *G06F 16/51* (2019.01); *G06F*

30 Claims, 39 Drawing Sheets

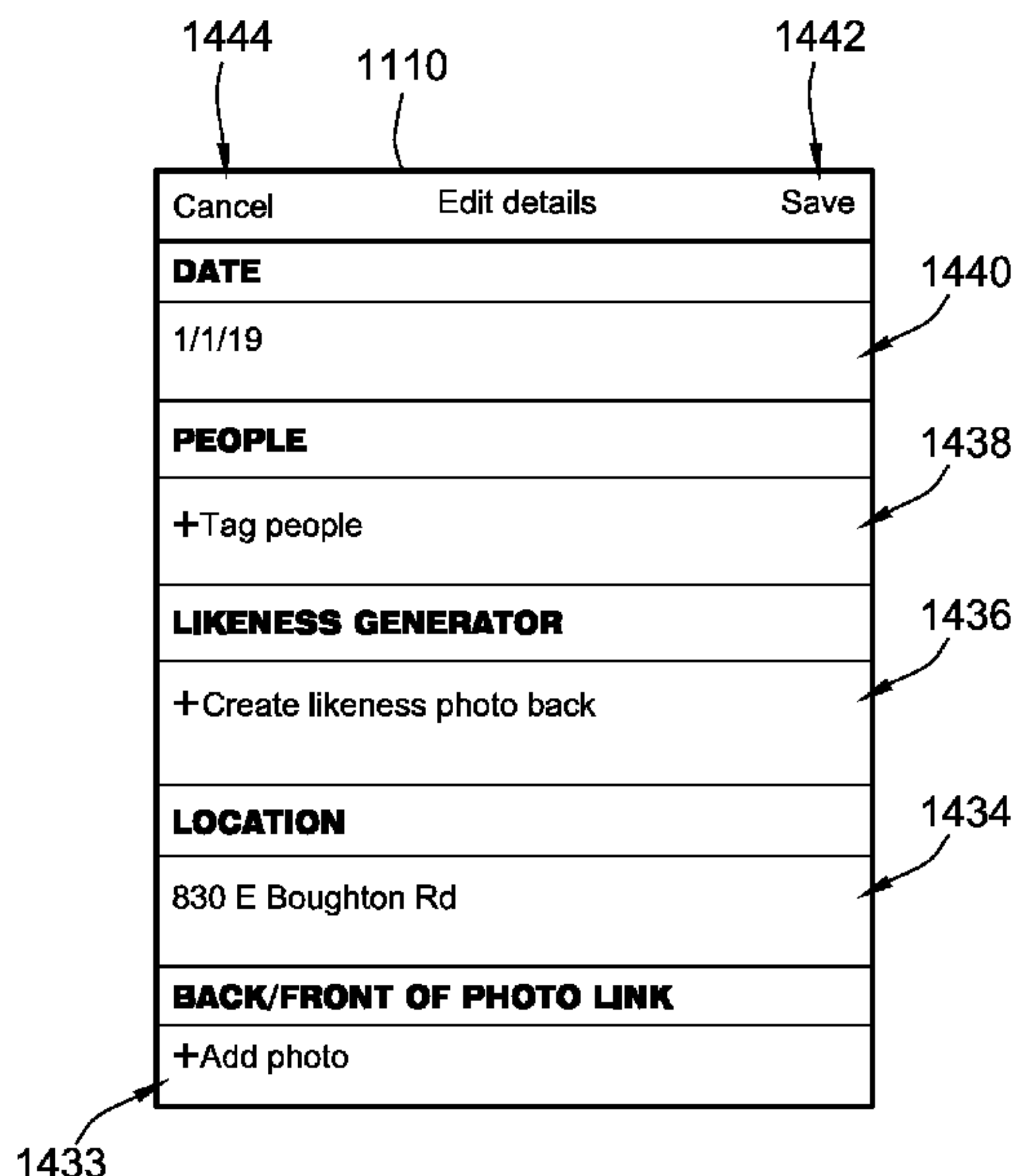

(51) **Int. Cl.**
G06F 16/51 (2019.01)
G06K 9/62 (2006.01)

(56) **References Cited**

U.S. PATENT DOCUMENTS

7,133,149 B2 * 11/2006 Keane G06Q 40/00
 358/1.15
 7,333,257 B2 * 2/2008 Reynolds G02F 1/155
 257/E21.273
 7,466,845 B2 * 12/2008 Bhaskaran G06T 5/50
 382/112
 7,516,895 B2 * 4/2009 Holoubek G06Q 10/107
 235/462.01
 7,676,767 B2 * 3/2010 Hofmeister G06F 3/0483
 345/173
 7,920,296 B2 * 4/2011 Beato H04N 1/0005
 358/3.28
 7,924,314 B2 * 4/2011 Getsch H04N 1/2166
 348/207.99
 7,982,909 B2 * 7/2011 Beato H04N 1/32128
 358/1.9
 7,986,831 B2 * 7/2011 Nielsen G06K 9/6224
 382/164
 8,036,417 B2 * 10/2011 Gallagher G06F 16/58
 382/100
 8,079,511 B2 * 12/2011 Silverbrook G06Q 20/3224
 235/375
 8,108,240 B2 * 1/2012 Gropper G06Q 10/1093
 705/7.18
 8,254,684 B2 * 8/2012 Raju G06F 16/58
 382/181
 8,290,205 B2 * 10/2012 Scalise G03D 15/003
 382/100
 8,295,881 B2 * 10/2012 Elleouet G06Q 10/10
 455/558
 9,208,177 B2 * 12/2015 Petrou G06F 16/24578
 9,563,643 B2 * 2/2017 Panneer G06F 16/583
 9,789,403 B1 * 10/2017 Furment A63F 13/428
 9,794,435 B1 * 10/2017 Islamov G06F 3/1256
 9,812,700 B2 * 11/2017 Okamoto H01M 4/661
 2002/0087546 A1 * 7/2002 Slater G06F 16/48
 2002/0089549 A1 * 7/2002 Munro G06T 11/60
 715/835
 2004/0047510 A1 * 3/2004 Kawabata G06F 3/14
 382/232
 2005/0251448 A1 * 11/2005 Gropper G06Q 30/0277
 705/14.61
 2005/0273356 A1 * 12/2005 Holoubek G06Q 10/107
 235/462.01
 2006/0268361 A1 * 11/2006 Krolczyk H04N 1/00474
 358/450
 2006/0284852 A1 * 12/2006 Hofmeister G06F 3/0483
 345/173
 2007/0047842 A1 * 3/2007 Bhaskaran G06F 16/583
 382/305
 2007/0066356 A1 * 3/2007 Lapstun B41J 3/445
 455/557
 2007/0162953 A1 * 7/2007 Bolliger G06F 16/4393
 725/142
 2007/0186164 A1 * 8/2007 Getsch H04N 1/32101
 715/723
 2007/0250529 A1 * 10/2007 Beato H04N 1/32128

2007/0266602 A1 * 11/2007 Daghighian G09F 1/00
 40/492
 2008/0056572 A1 * 3/2008 Nielsen G06K 9/6224
 382/173
 2008/0291507 A1 * 11/2008 Rodrigues H04N 1/32128
 358/474
 2008/0316508 A1 * 12/2008 Silverbrook G07F 17/3223
 358/1.1
 2009/0153925 A1 * 6/2009 Beato H04N 1/0005
 358/537
 2009/0171783 A1 * 7/2009 Raju G06F 16/58
 705/14.26
 2009/0310814 A1 * 12/2009 Gallagher G06F 16/58
 382/100
 2009/0323136 A1 * 12/2009 Fujiwara G03G 15/5025
 358/474
 2010/0273525 A1 * 10/2010 Silverbrook H04M 1/72561
 455/556.1
 2010/0329575 A1 * 12/2010 Scalise G06F 16/58
 382/218
 2011/0231747 A1 * 9/2011 Zuckerberg G06F 16/5866
 715/206
 2011/0292464 A1 * 12/2011 Shih H04N 1/233
 358/474
 2011/0316882 A1 * 12/2011 Blose G06K 9/3208
 345/636
 2011/0317193 A1 * 12/2011 Iwase G06F 3/0482
 358/1.13
 2011/0317195 A1 * 12/2011 Mitsui H04N 1/00411
 358/1.13
 2012/0105891 A1 * 5/2012 Mano H04N 1/40
 358/1.13
 2012/0272180 A1 * 10/2012 Larres G06F 3/04817
 715/784
 2012/0290601 A1 * 11/2012 Huang G06K 9/00469
 707/769
 2013/0091026 A1 * 4/2013 Deng G06Q 30/06
 705/14.73
 2013/0239056 A1 * 9/2013 Ubillos G06F 3/0482
 715/833
 2013/0254666 A1 * 9/2013 Snavely G06K 9/00637
 715/731
 2013/0293917 A1 * 11/2013 Safonov H04N 1/00413
 358/1.13
 2014/0172881 A1 * 6/2014 Petrou G06F 16/9535
 707/748
 2014/0195337 A1 * 7/2014 Taylor G06F 3/04883
 705/14.45
 2014/0229328 A1 * 8/2014 Butler G06Q 30/0633
 705/26.8
 2014/0355073 A1 * 12/2014 Beato G06K 9/00456
 358/449
 2015/0019579 A1 * 1/2015 Won G06F 16/48
 707/758
 2015/0149428 A1 * 5/2015 Smith G06F 3/0482
 707/706
 2015/0154736 A1 * 6/2015 Seitz G06T 3/0075
 348/36
 2015/0199385 A1 * 7/2015 Choi G06T 11/60
 382/305
 2015/0237268 A1 * 8/2015 Vaiaoga H04N 5/265
 348/218.1
 2017/0094023 A1 * 3/2017 Jack H04L 51/10
 2019/0132462 A1 * 5/2019 Ogawa H04N 1/00777
 2020/0053283 A1 * 2/2020 Li H04N 5/23293

* cited by examiner

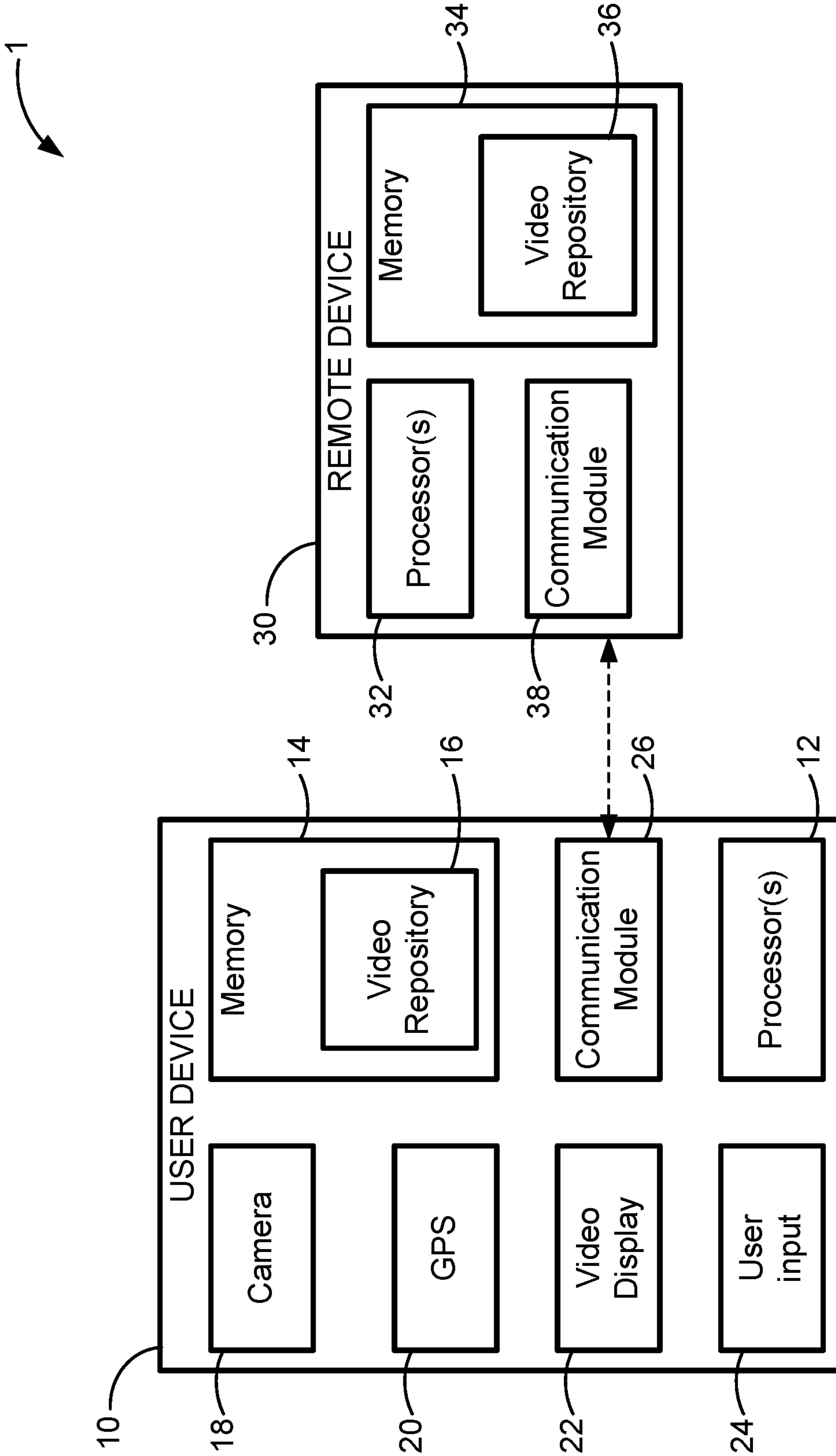

FIG. 1

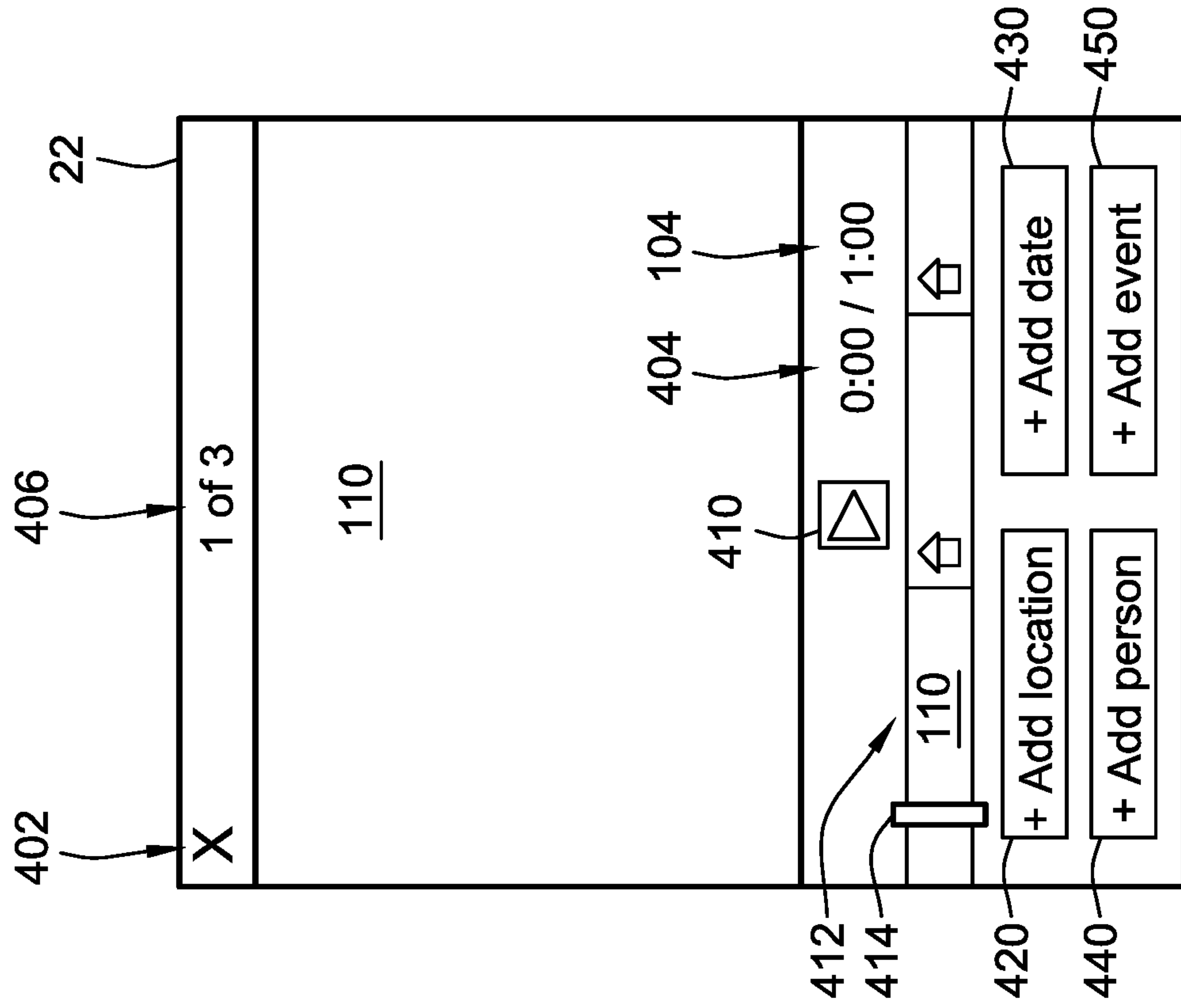

FIG. 2A

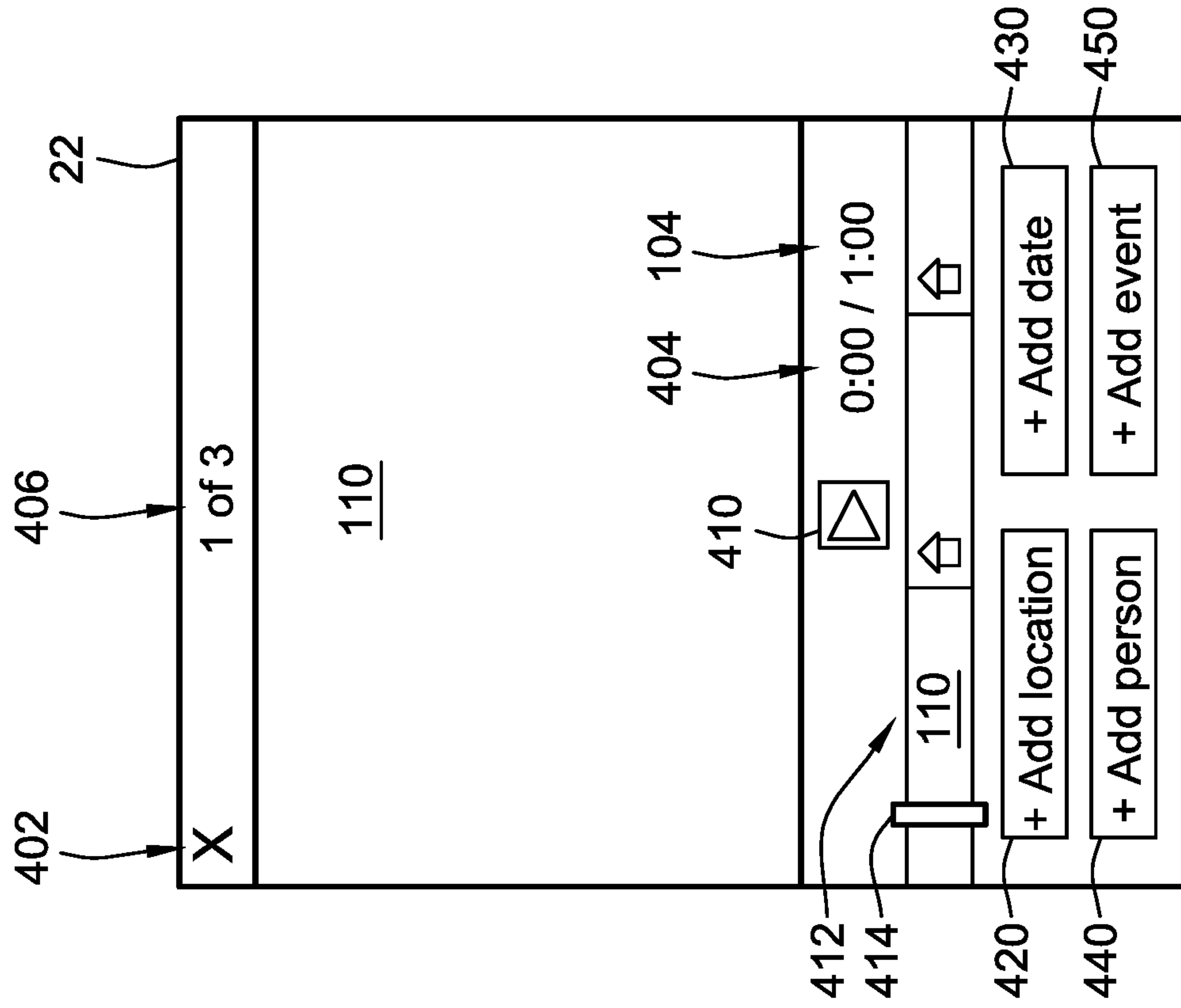

FIG. 2B

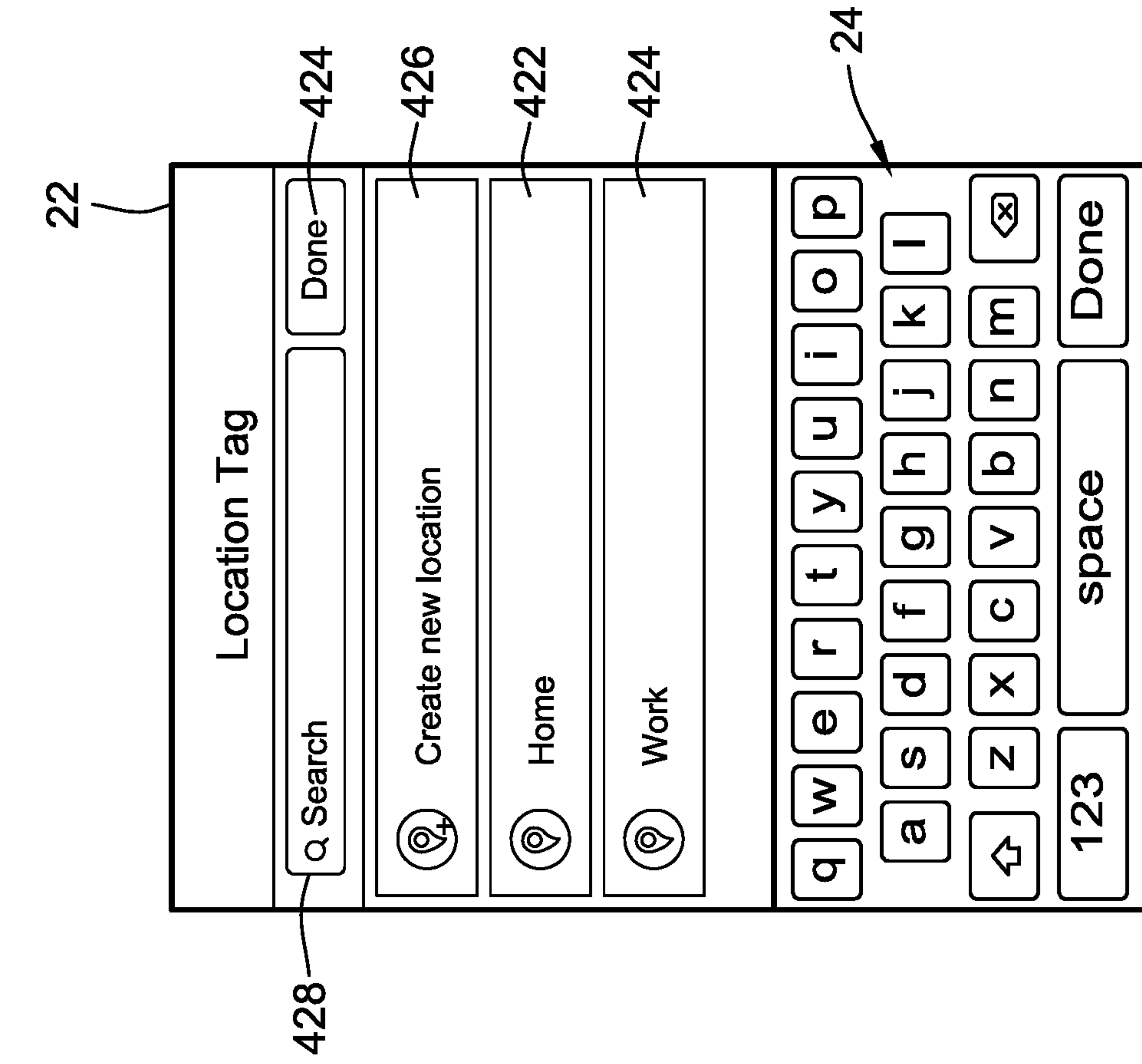

FIG. 2D

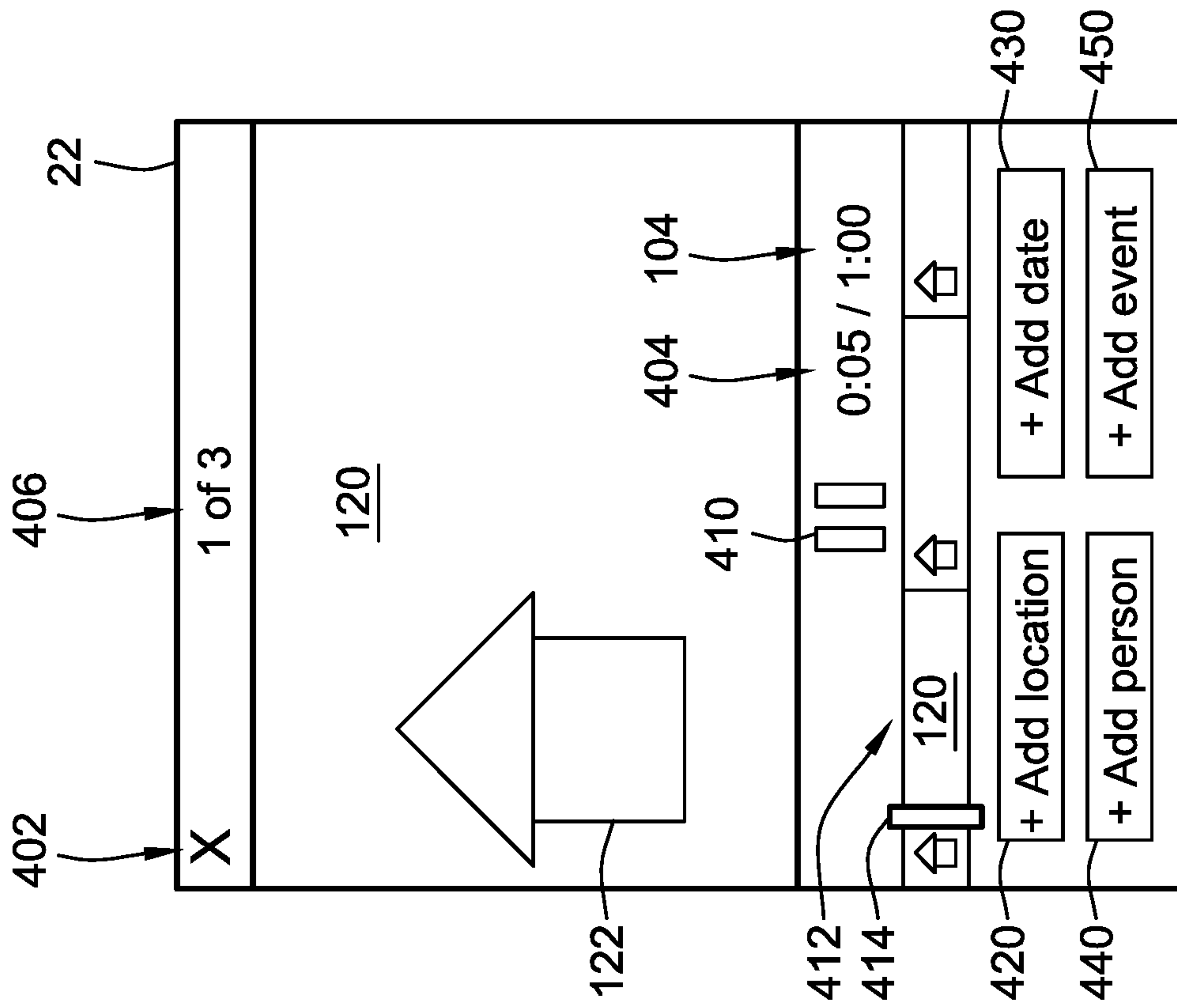

FIG. 2C

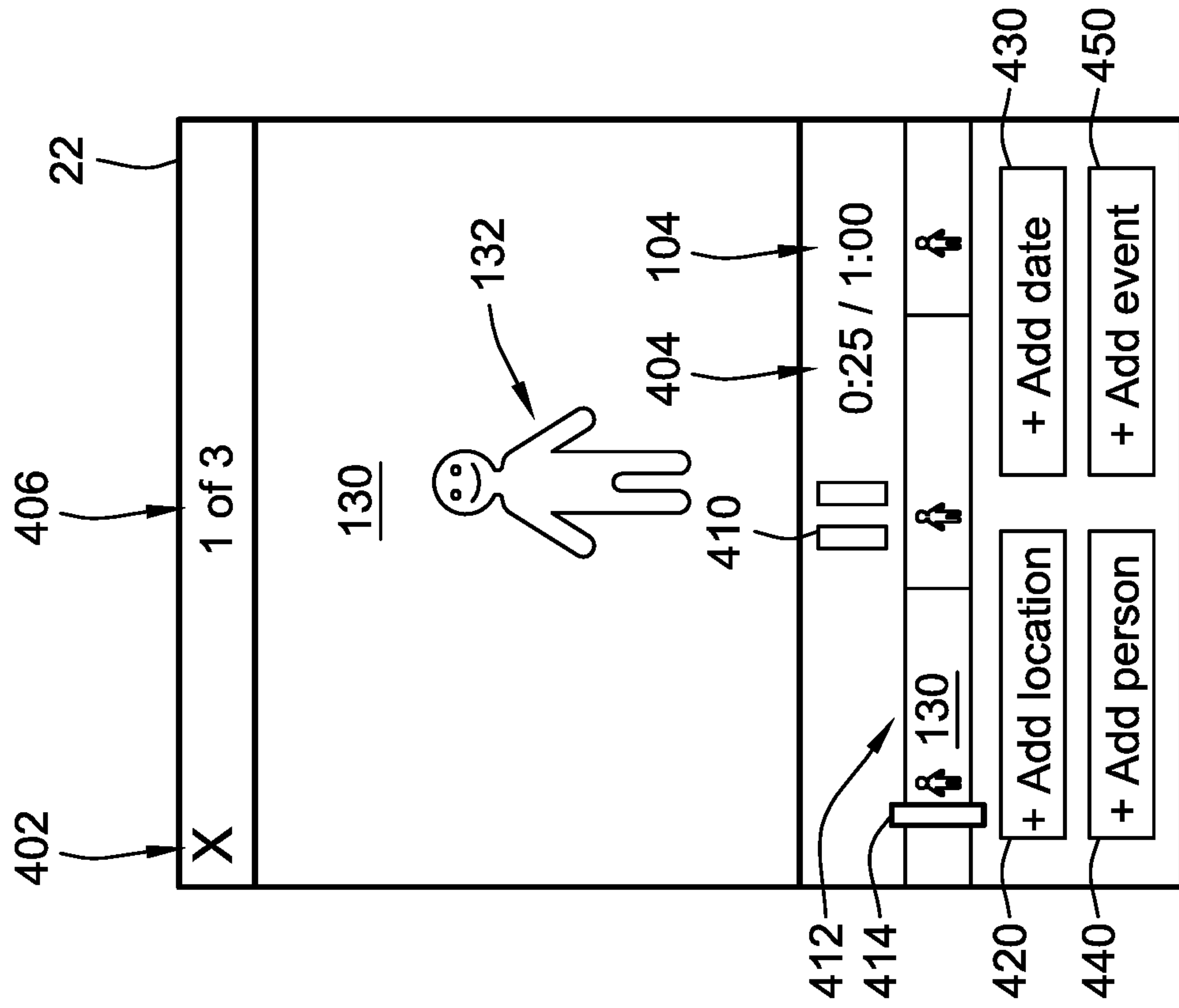

FIG. 2E

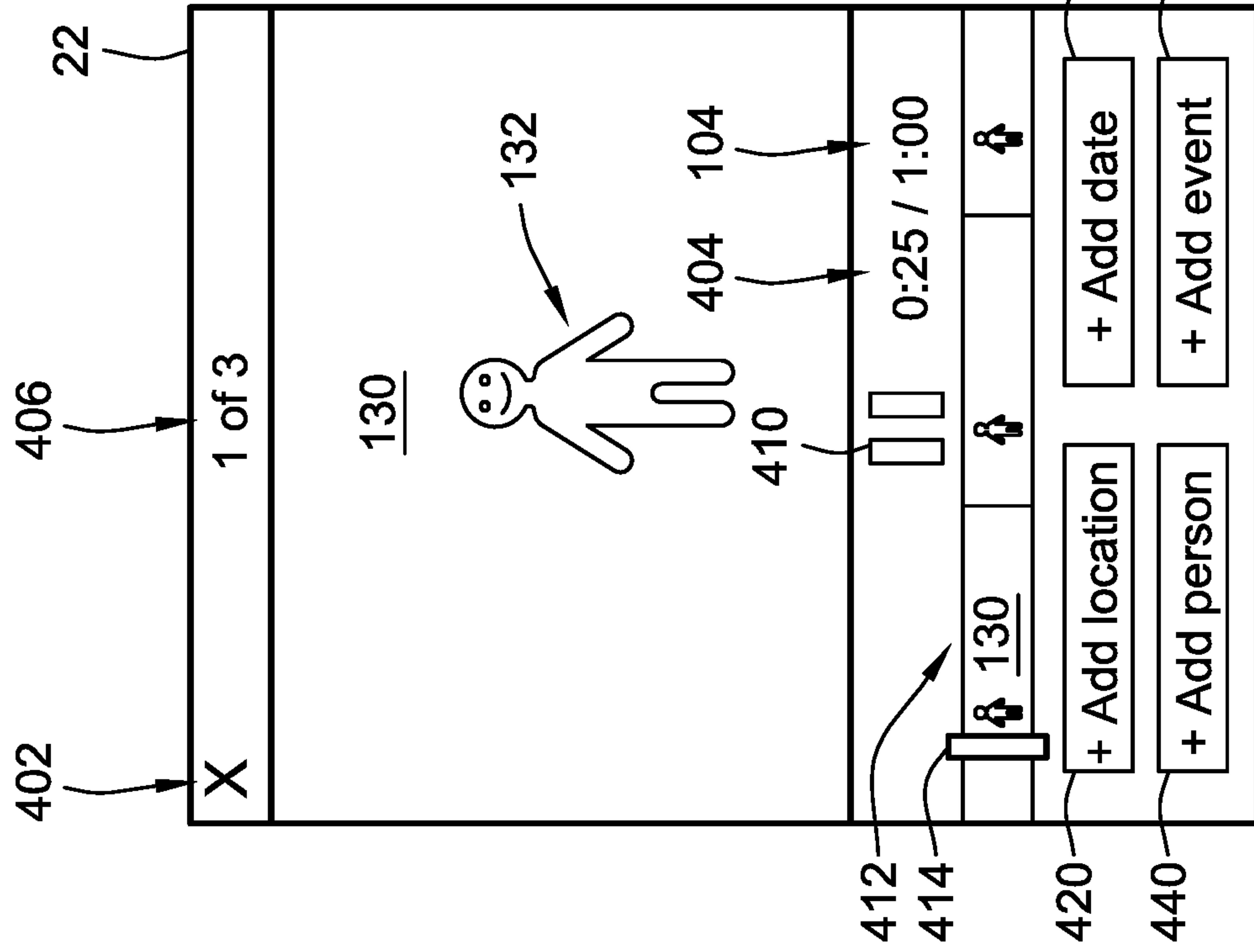

FIG. 2F

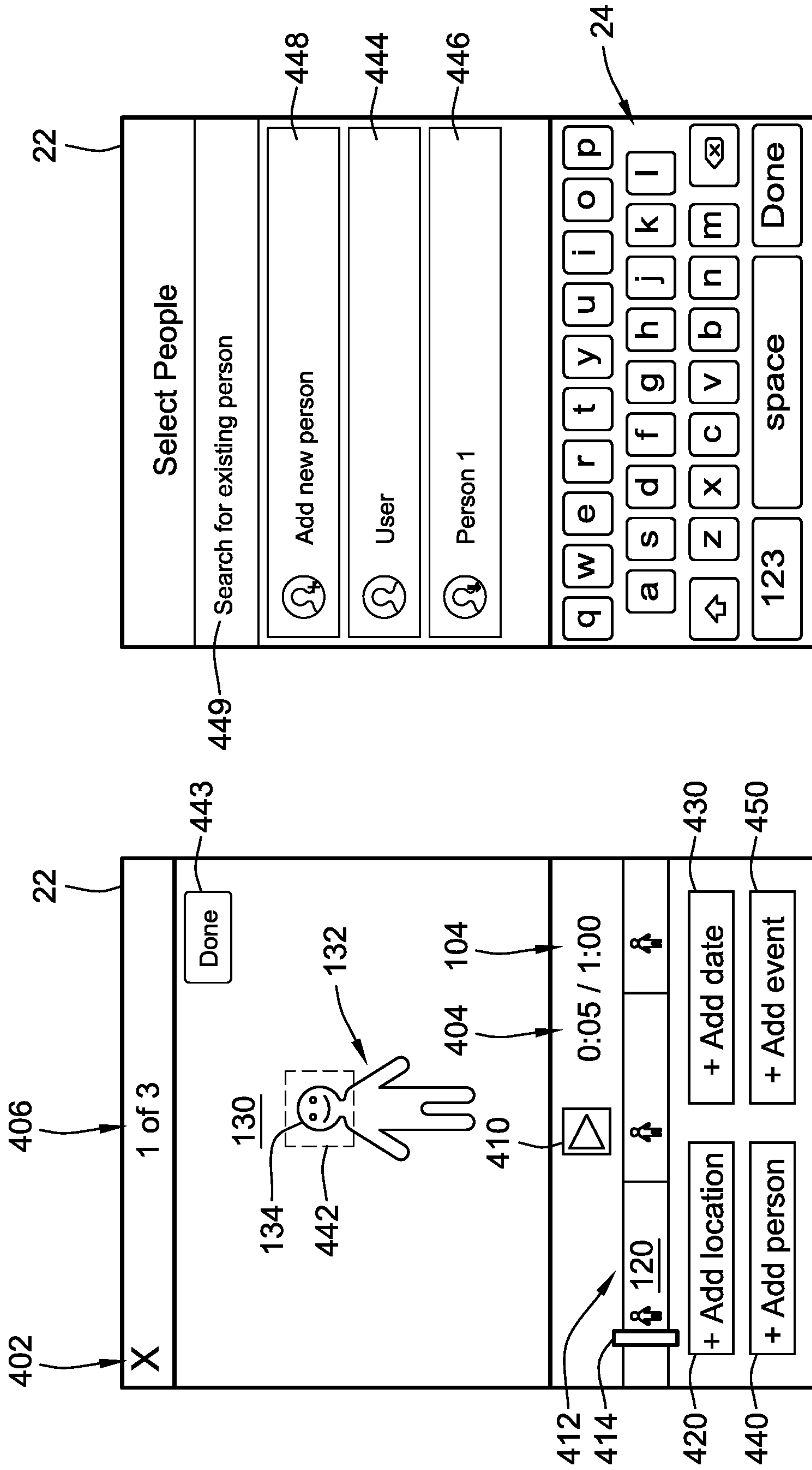

FIG. 2H

FIG. 2G

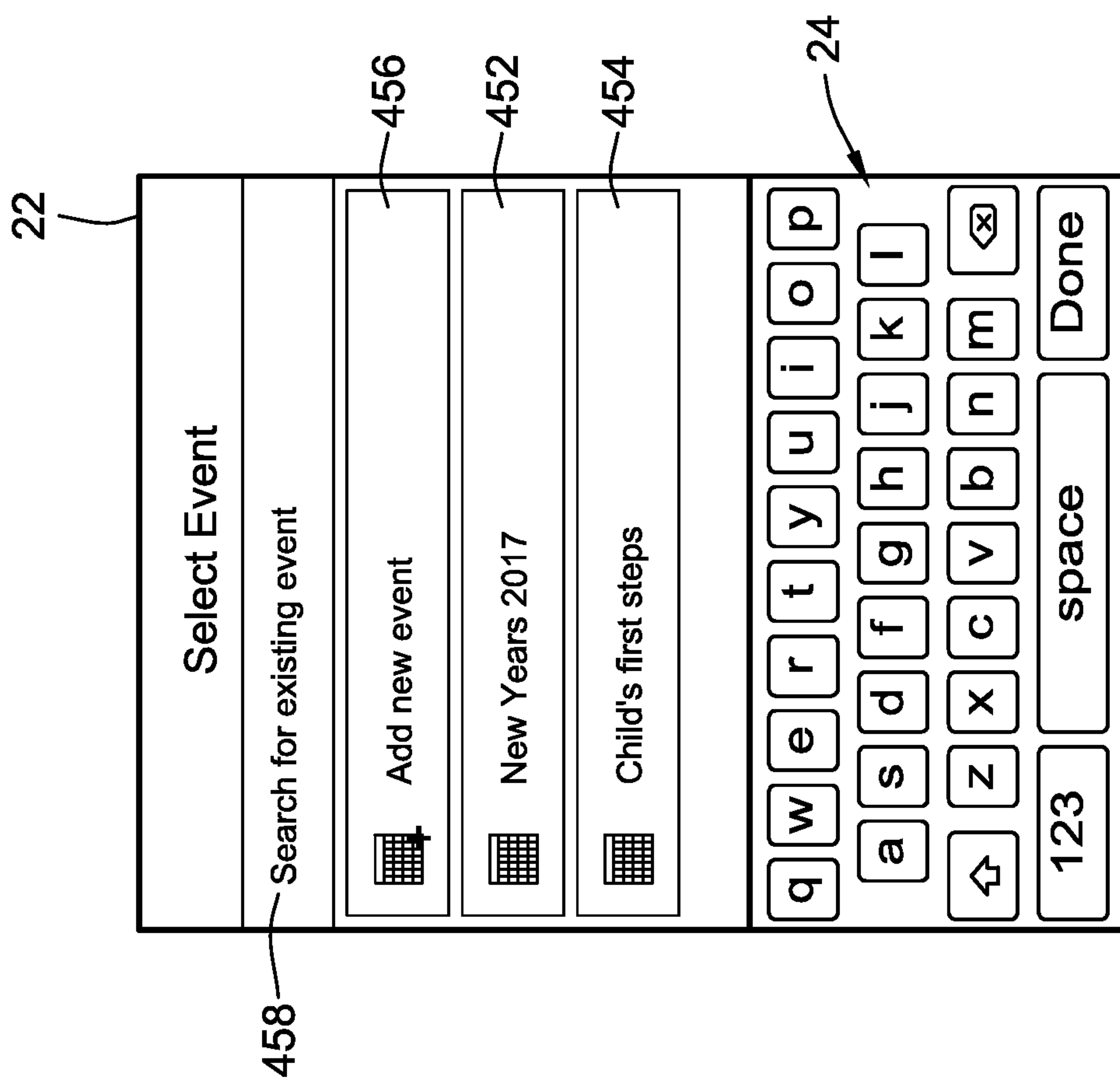

FIG. 2I

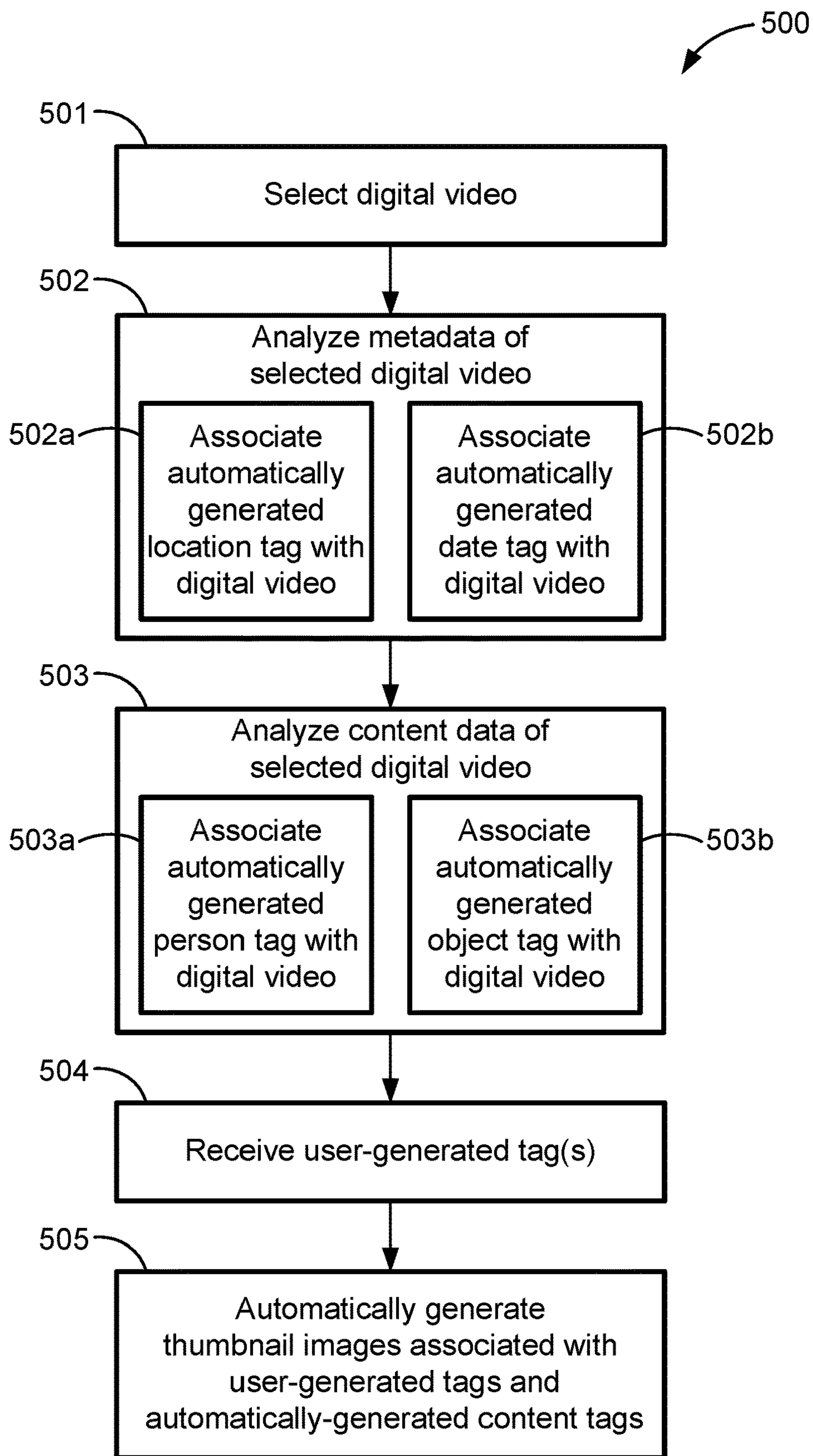

FIG. 3A

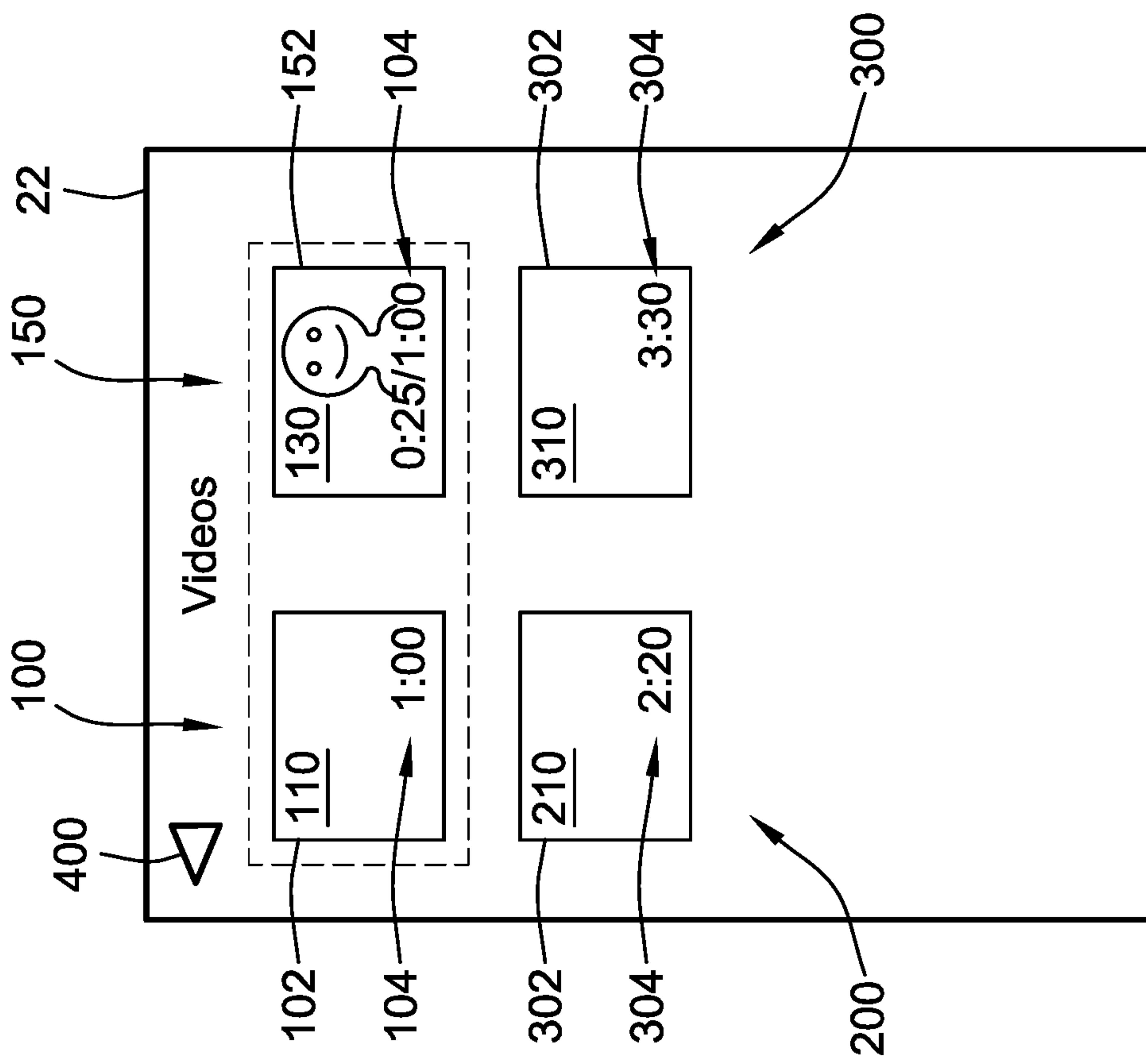

FIG. 3B

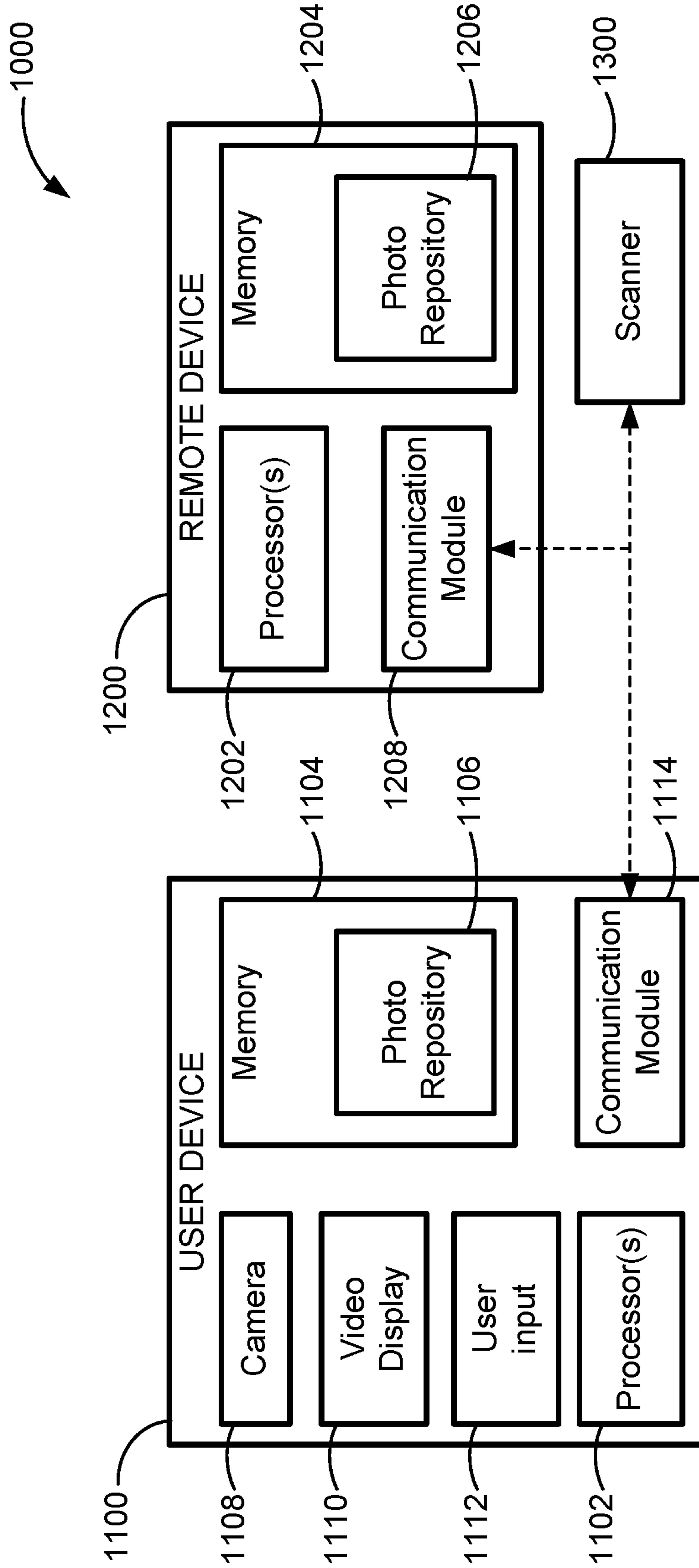

FIG. 4

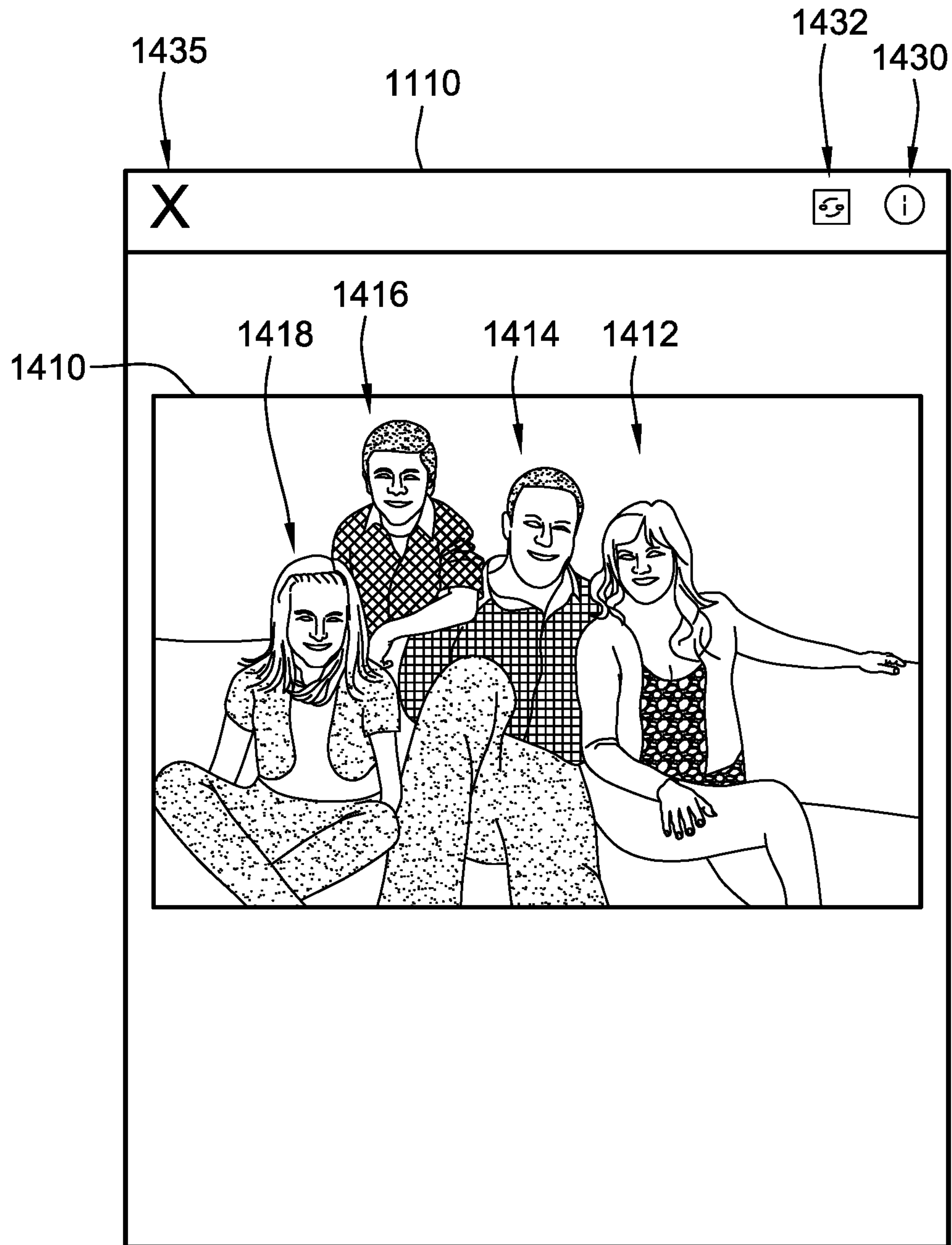

FIG. 5A

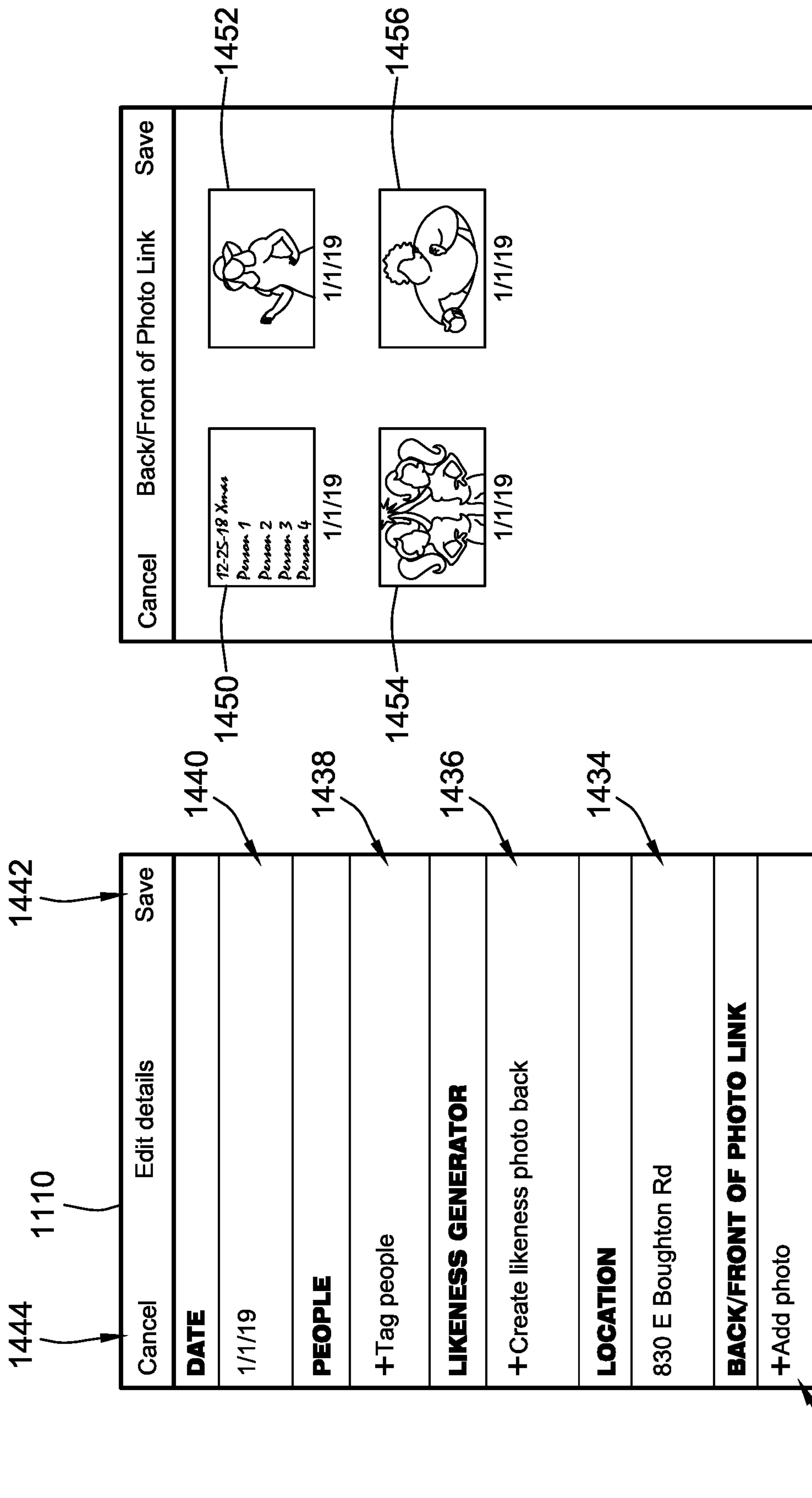

FIG. 5C

FIG. 5B

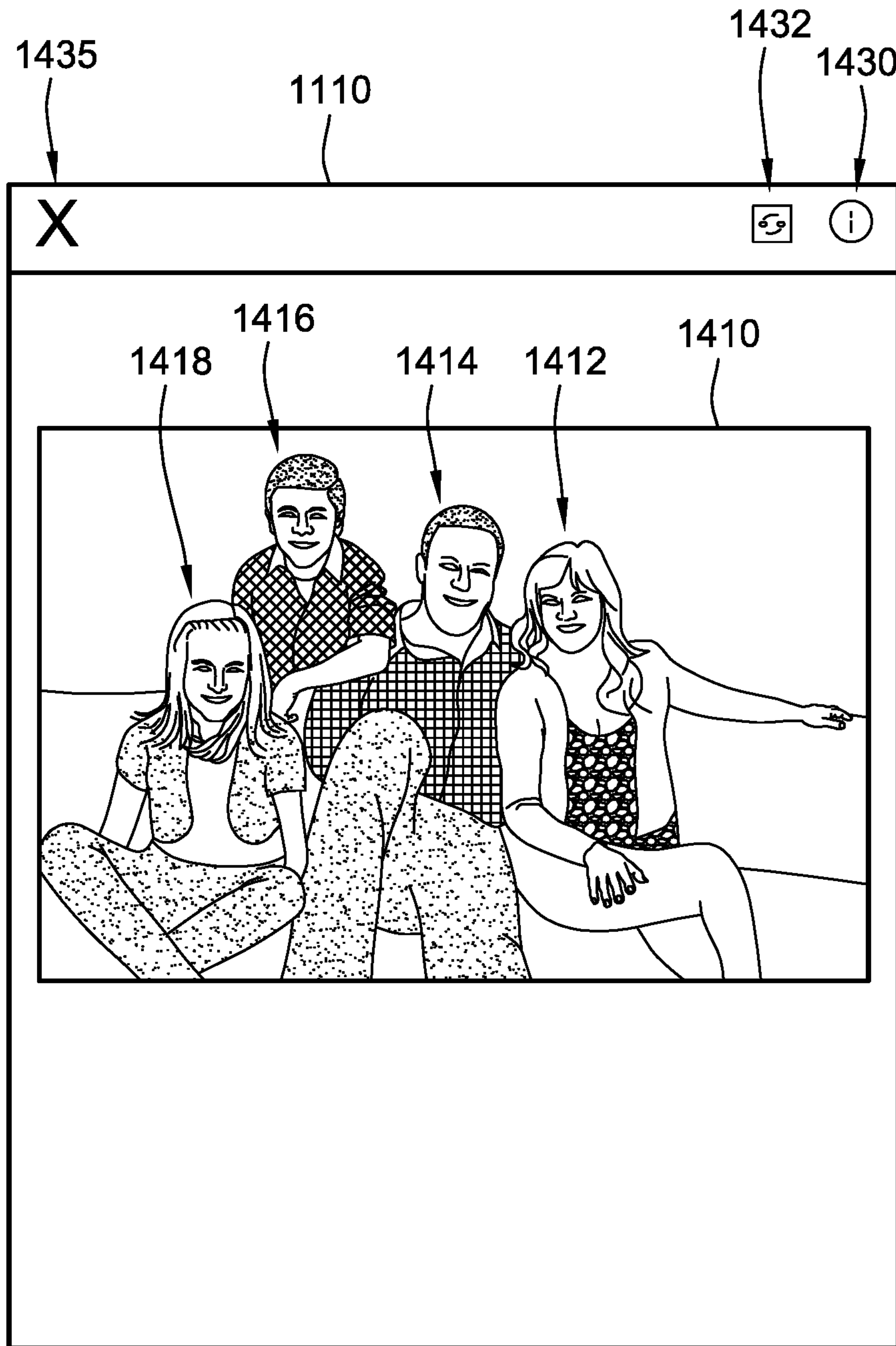

FIG. 6A

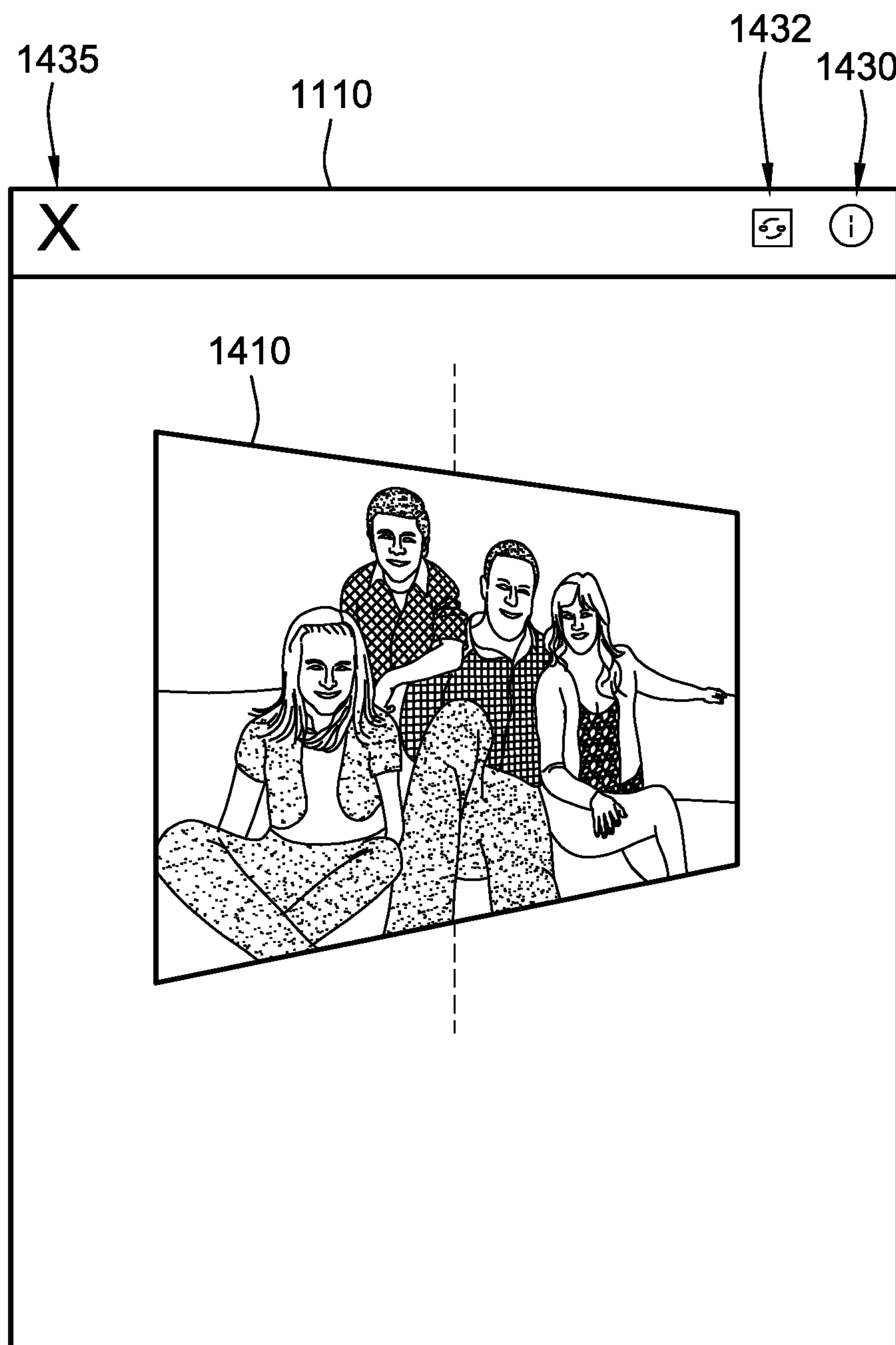

FIG. 6B

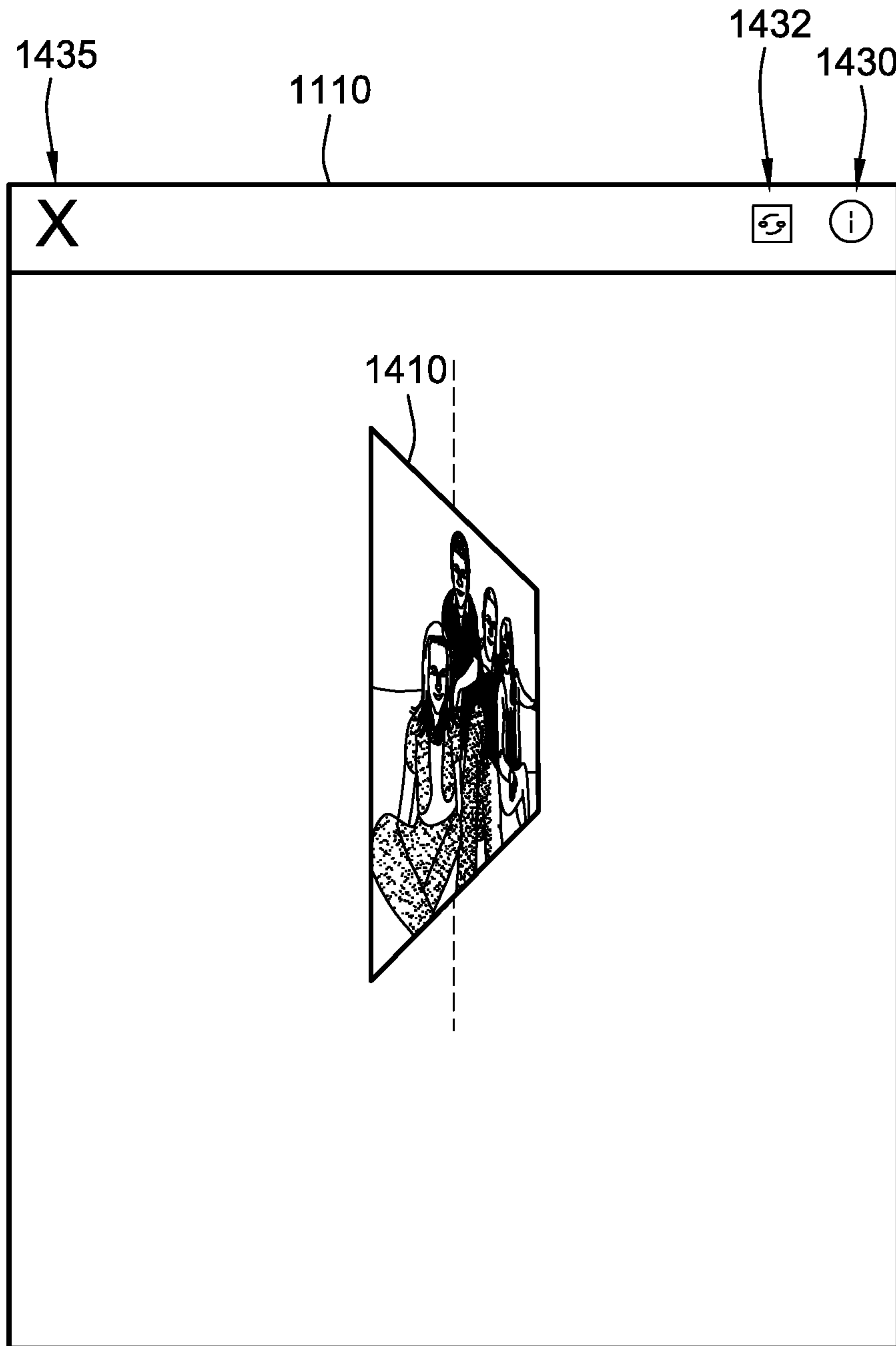

FIG. 6C

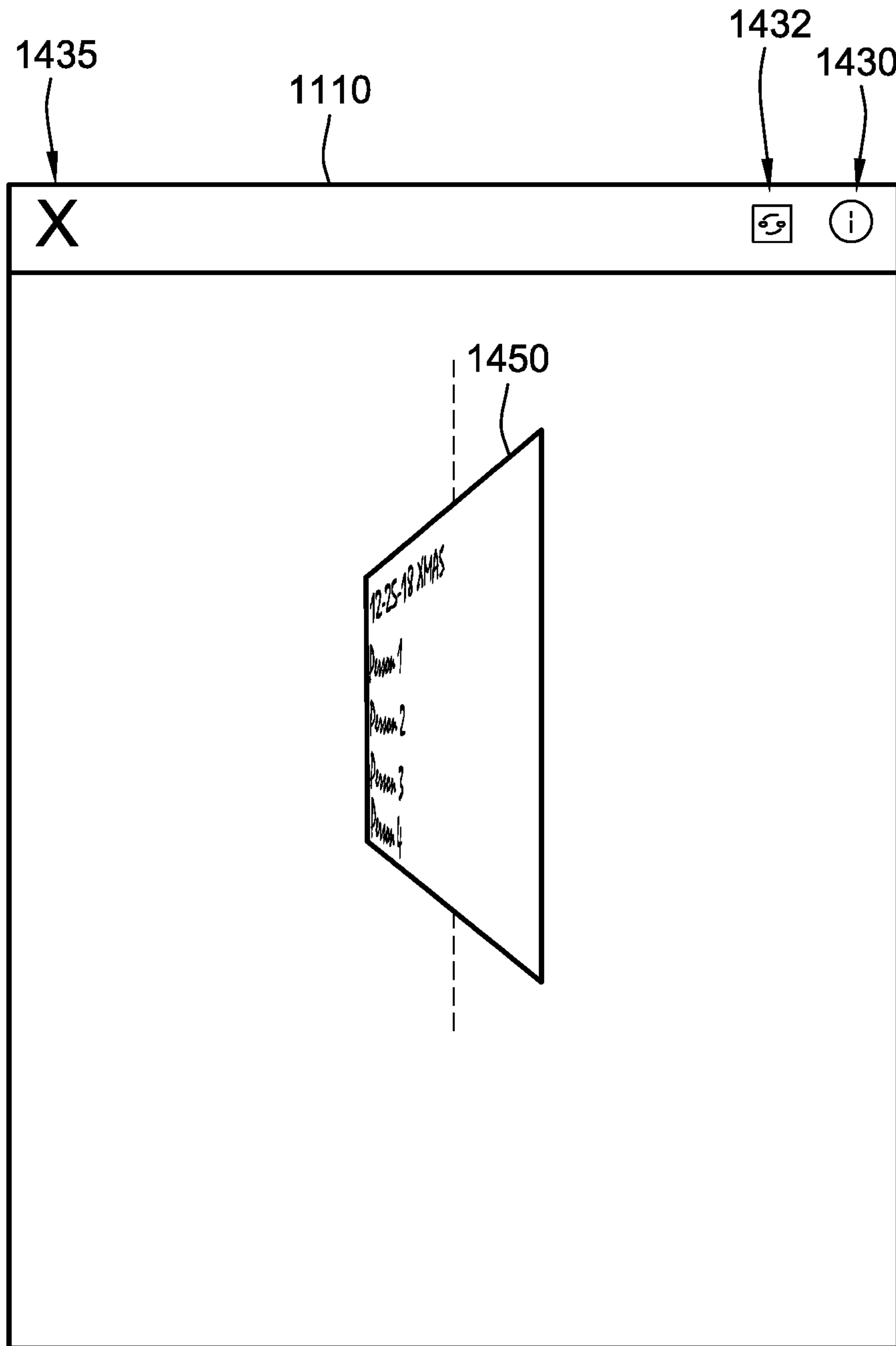

FIG. 6D

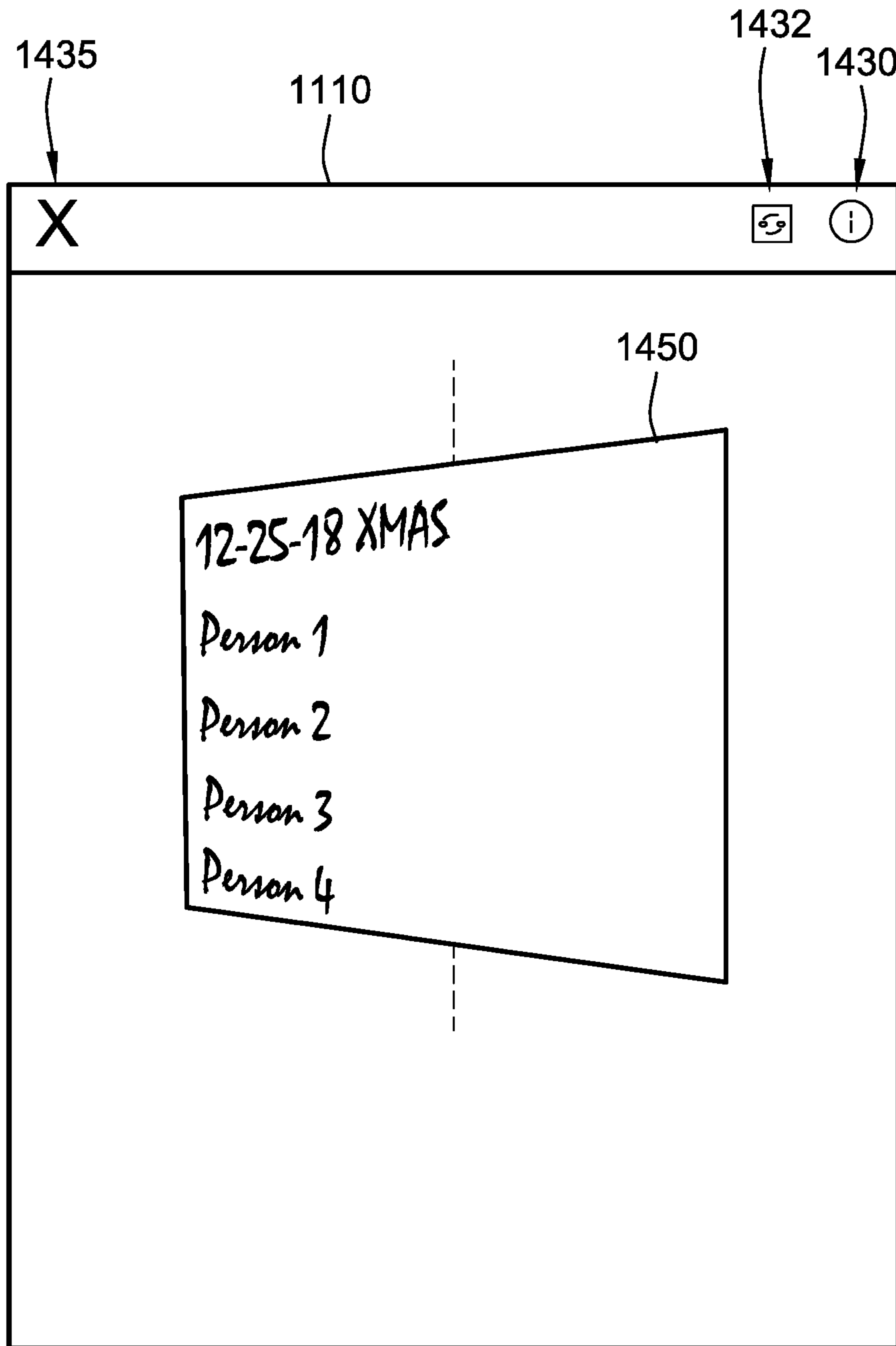

FIG. 6E

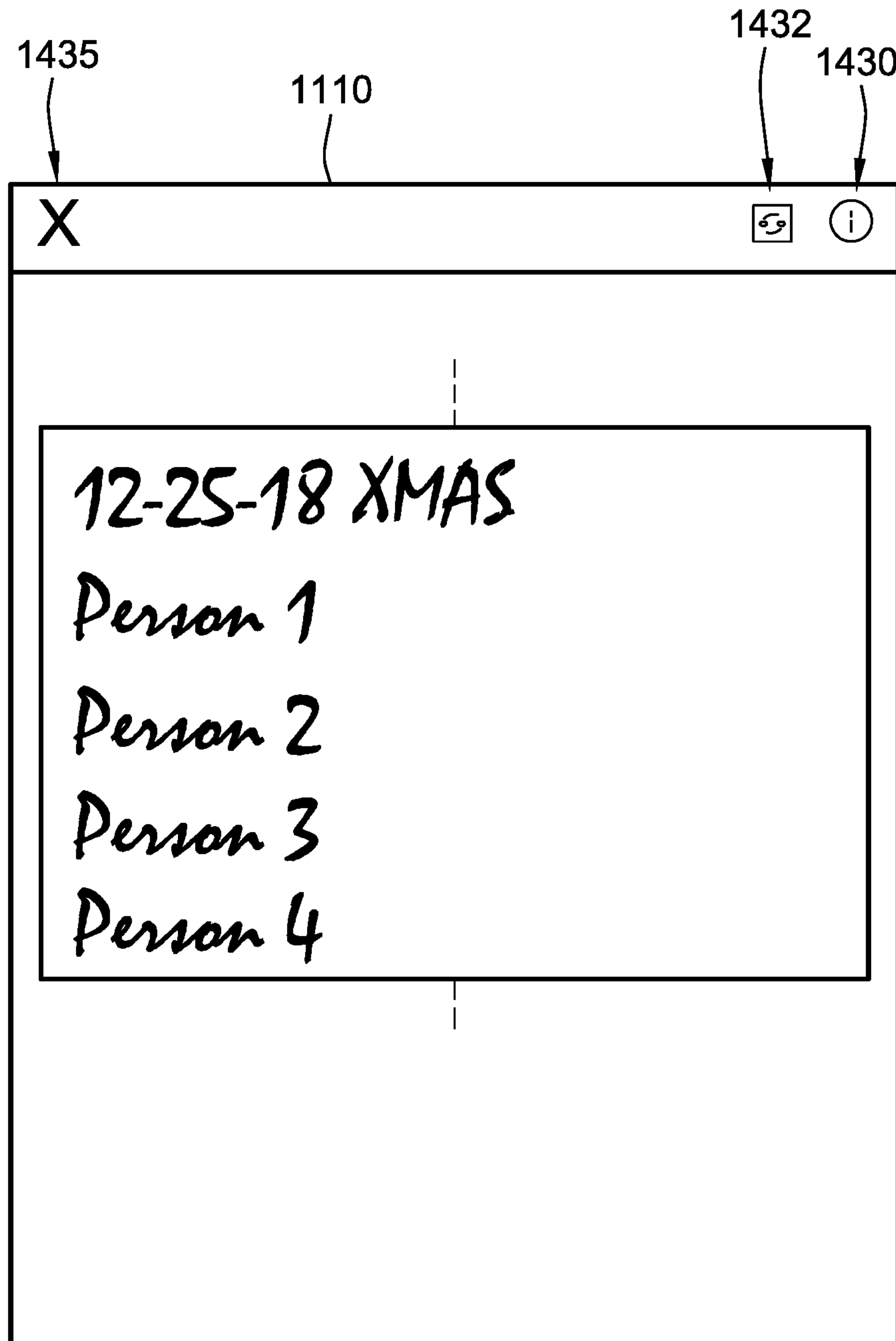

FIG. 6F

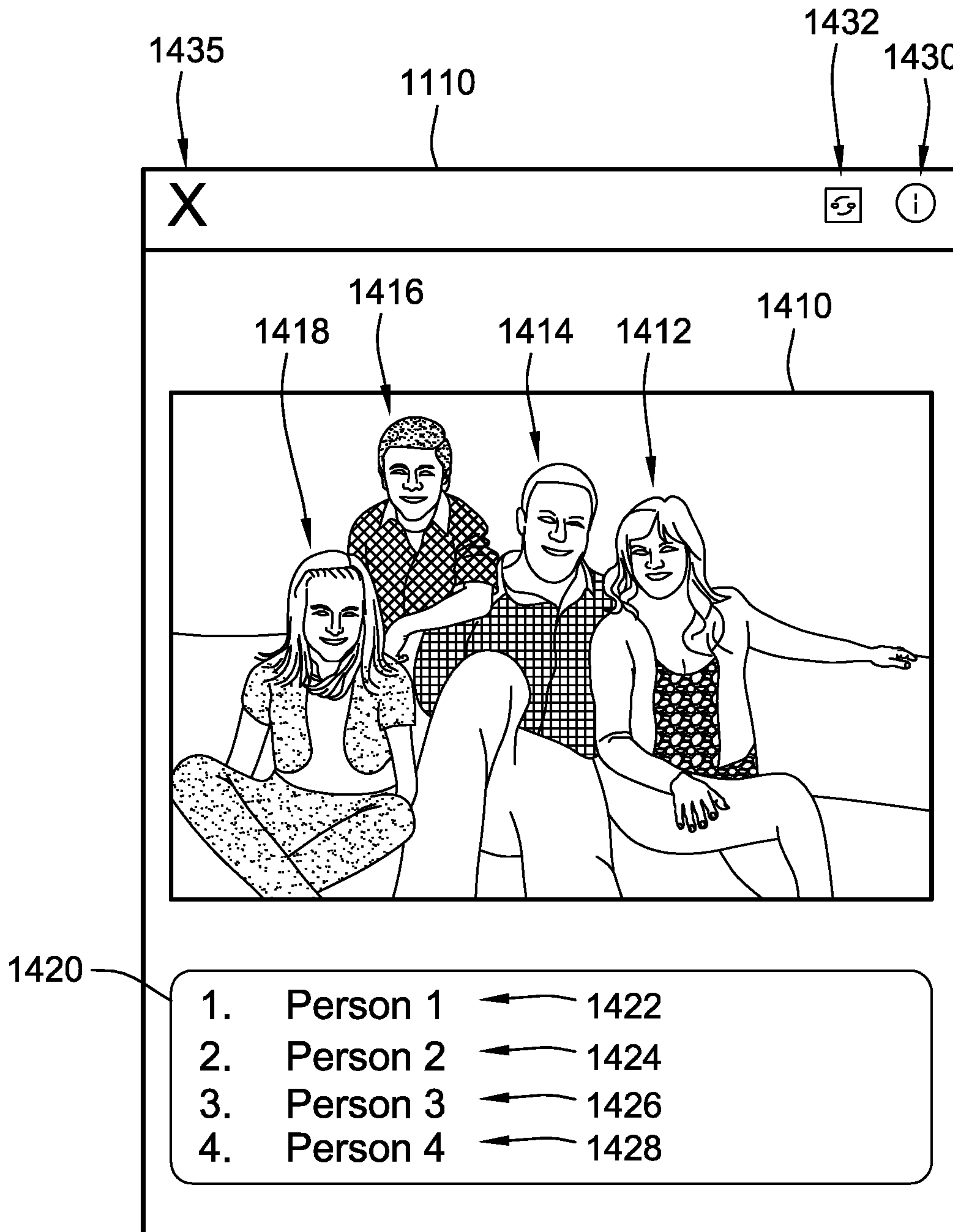

FIG. 7A

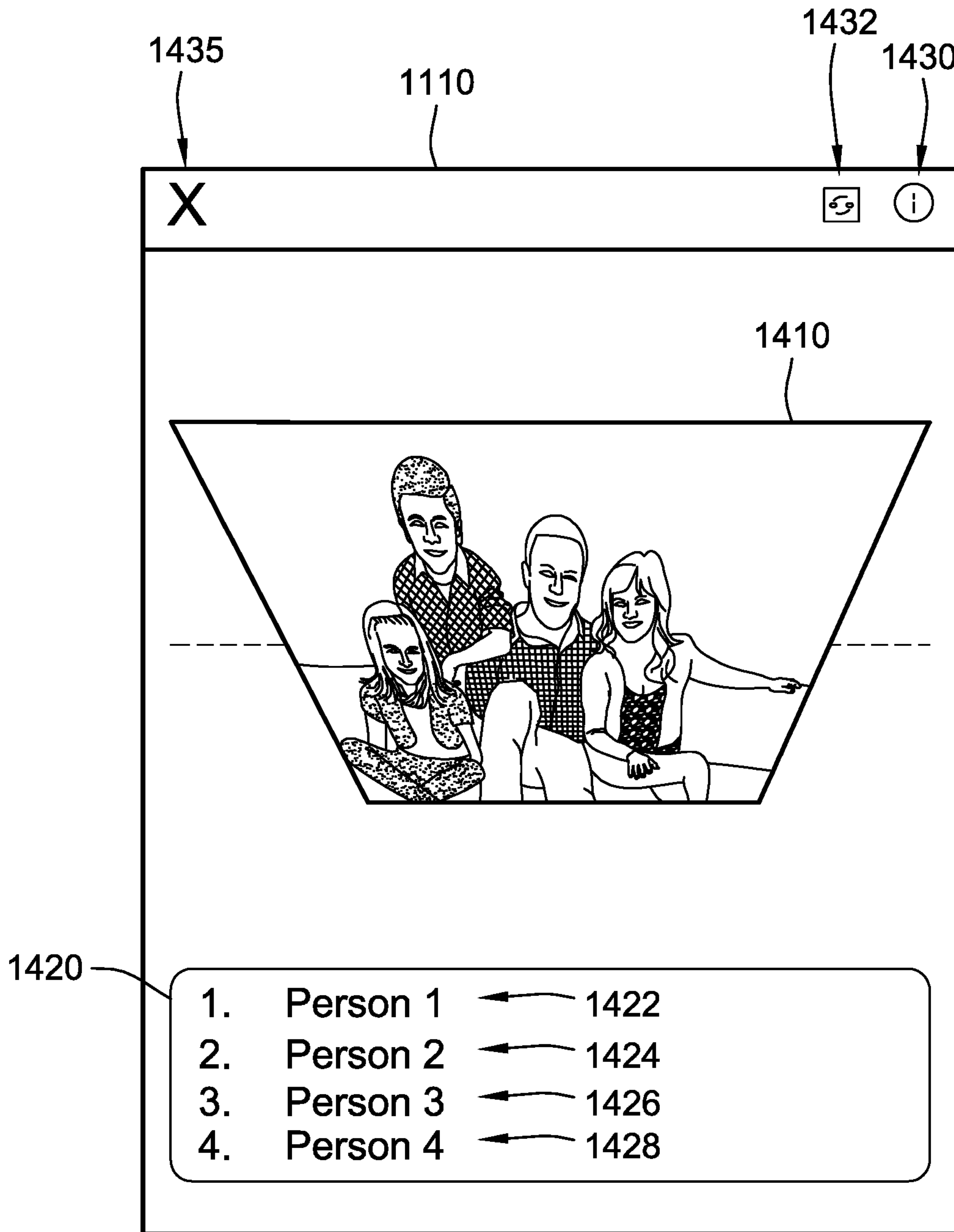

FIG. 7B

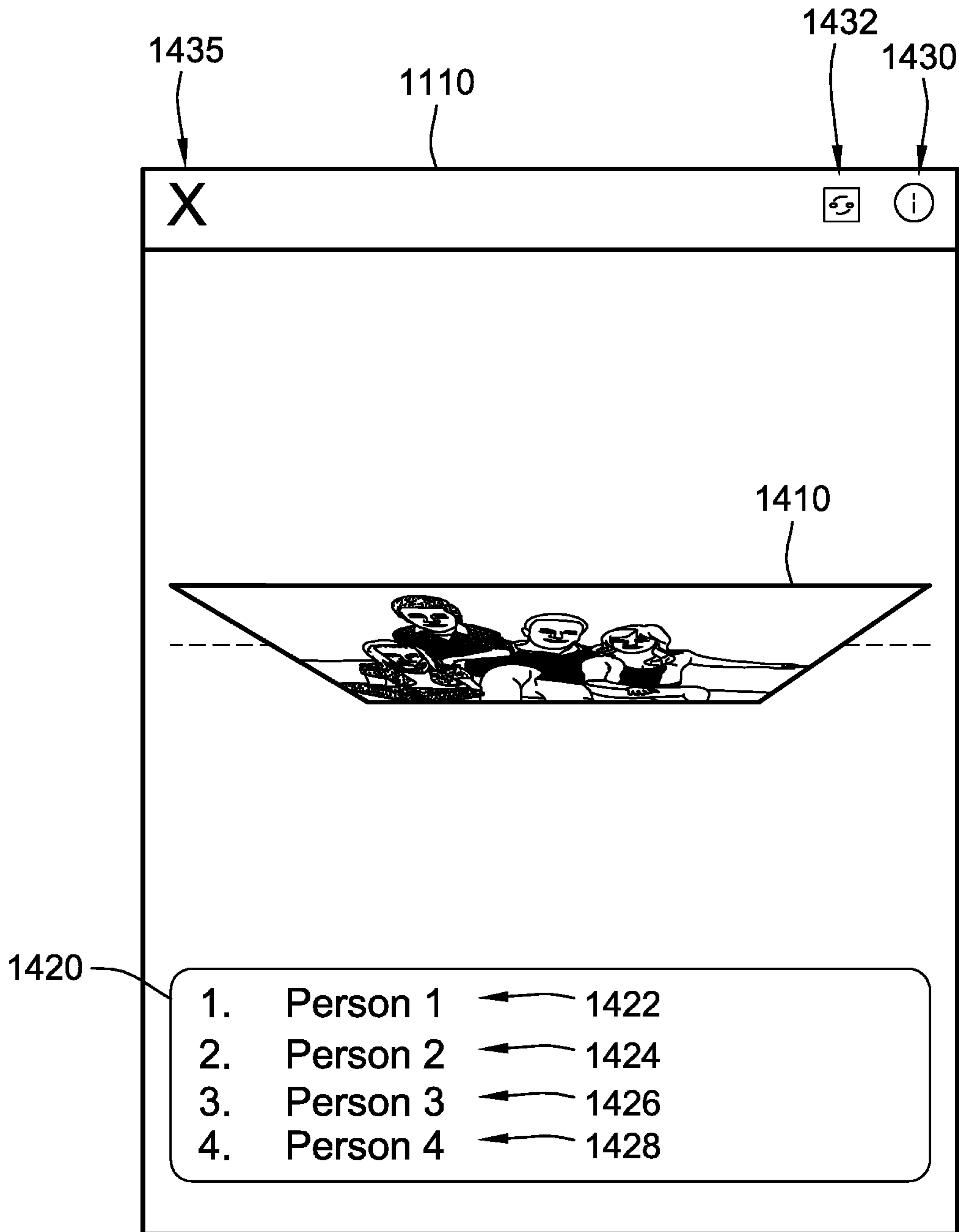

FIG. 7C

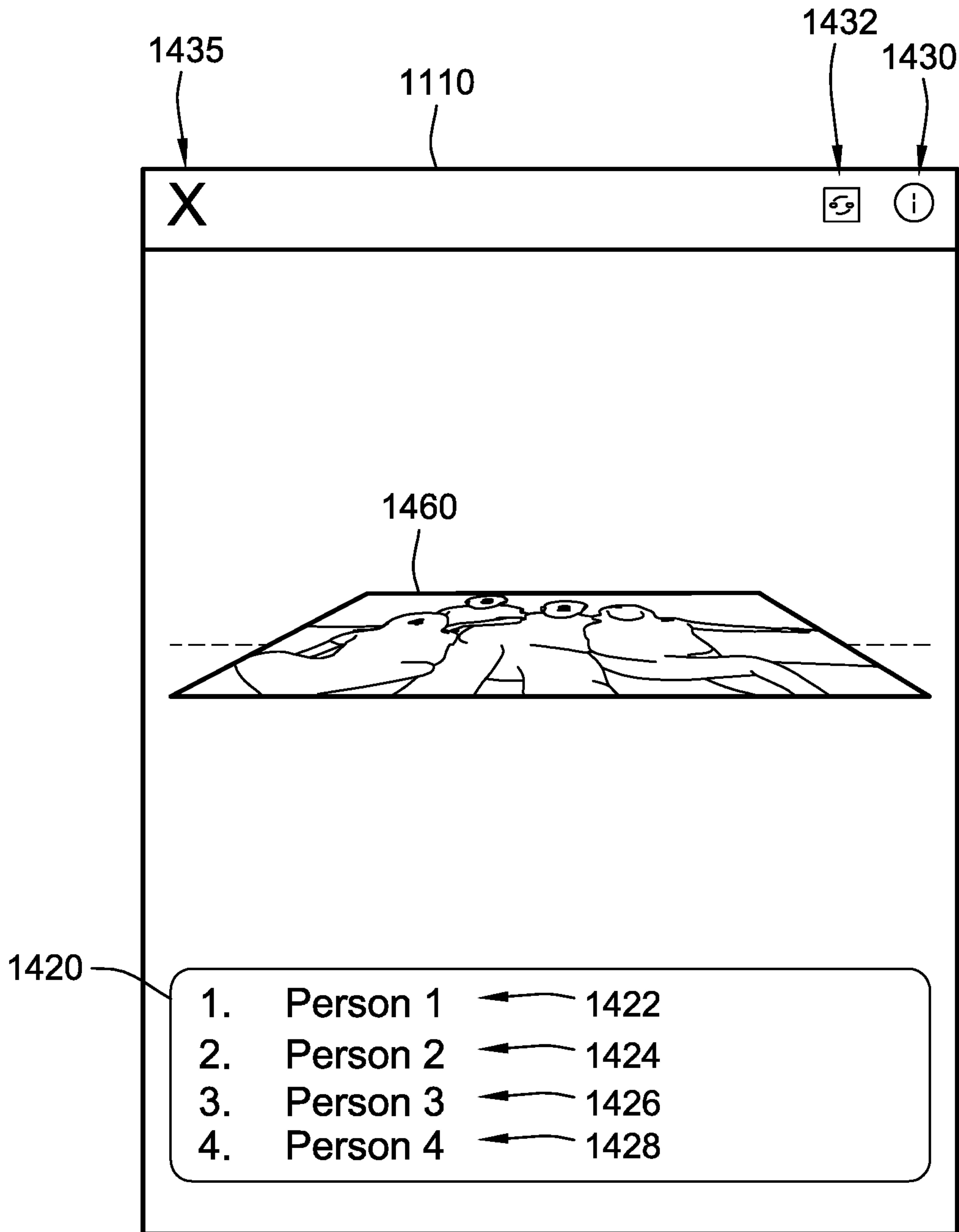

FIG. 7D

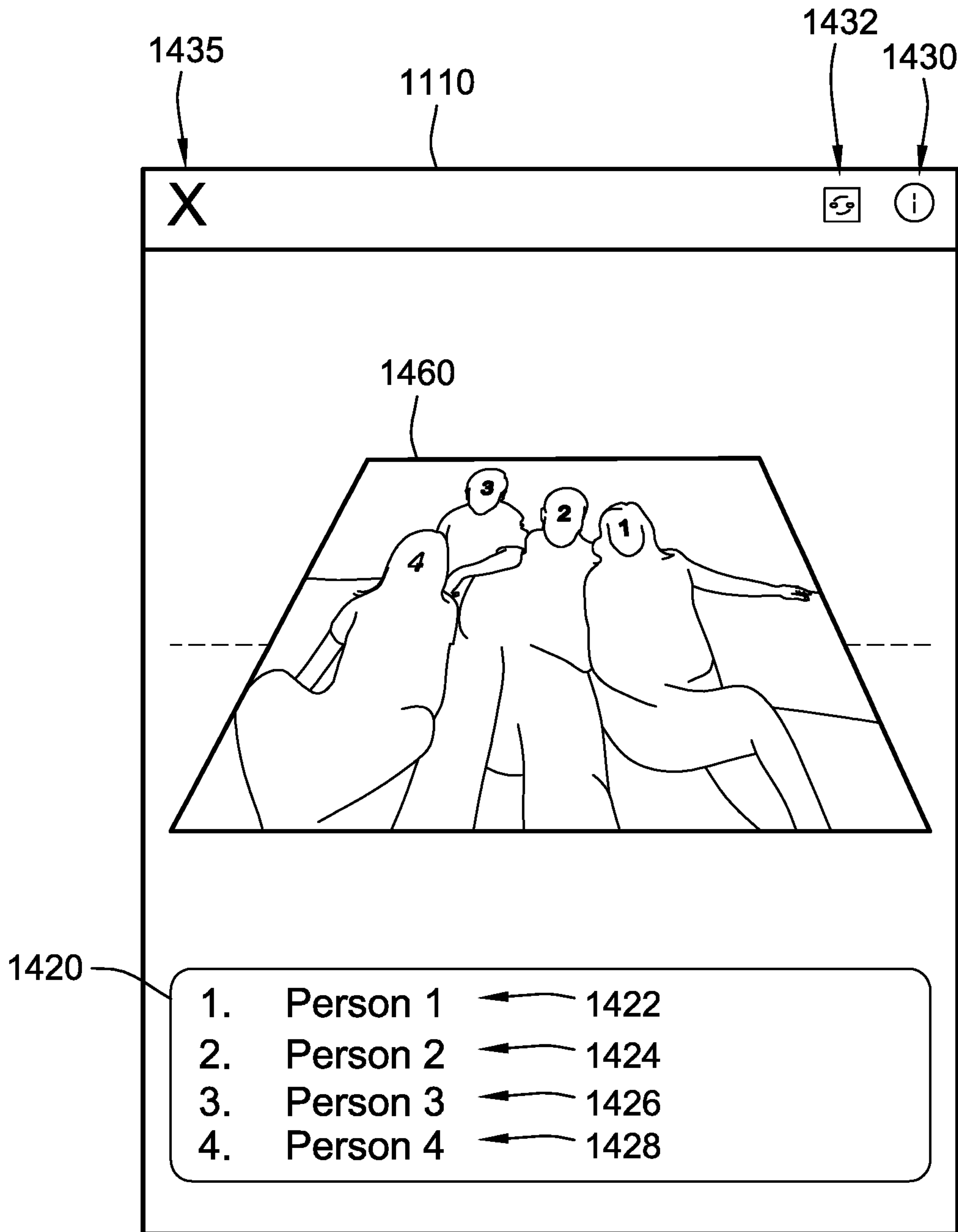

FIG. 7E

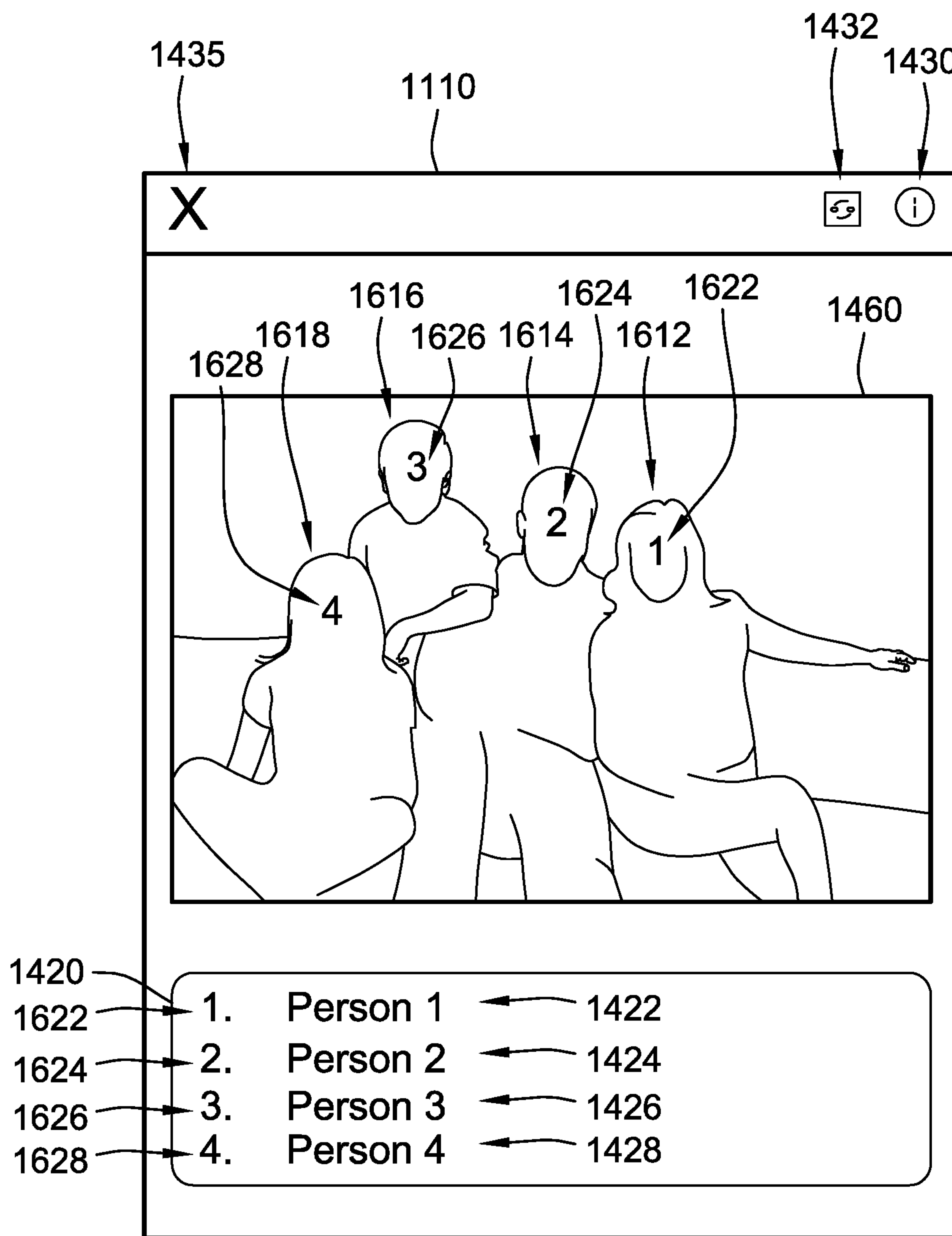

FIG. 7F

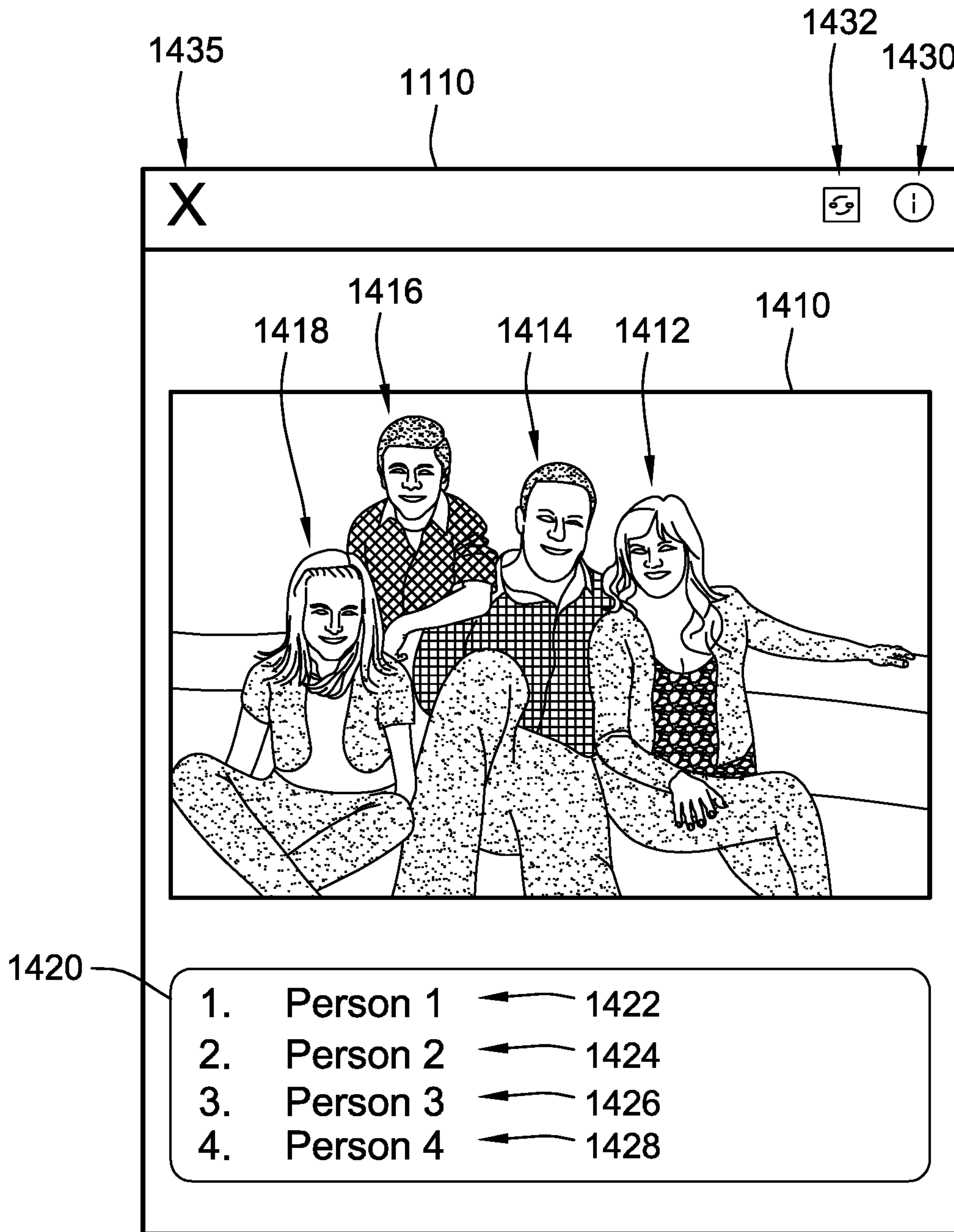

FIG. 8A

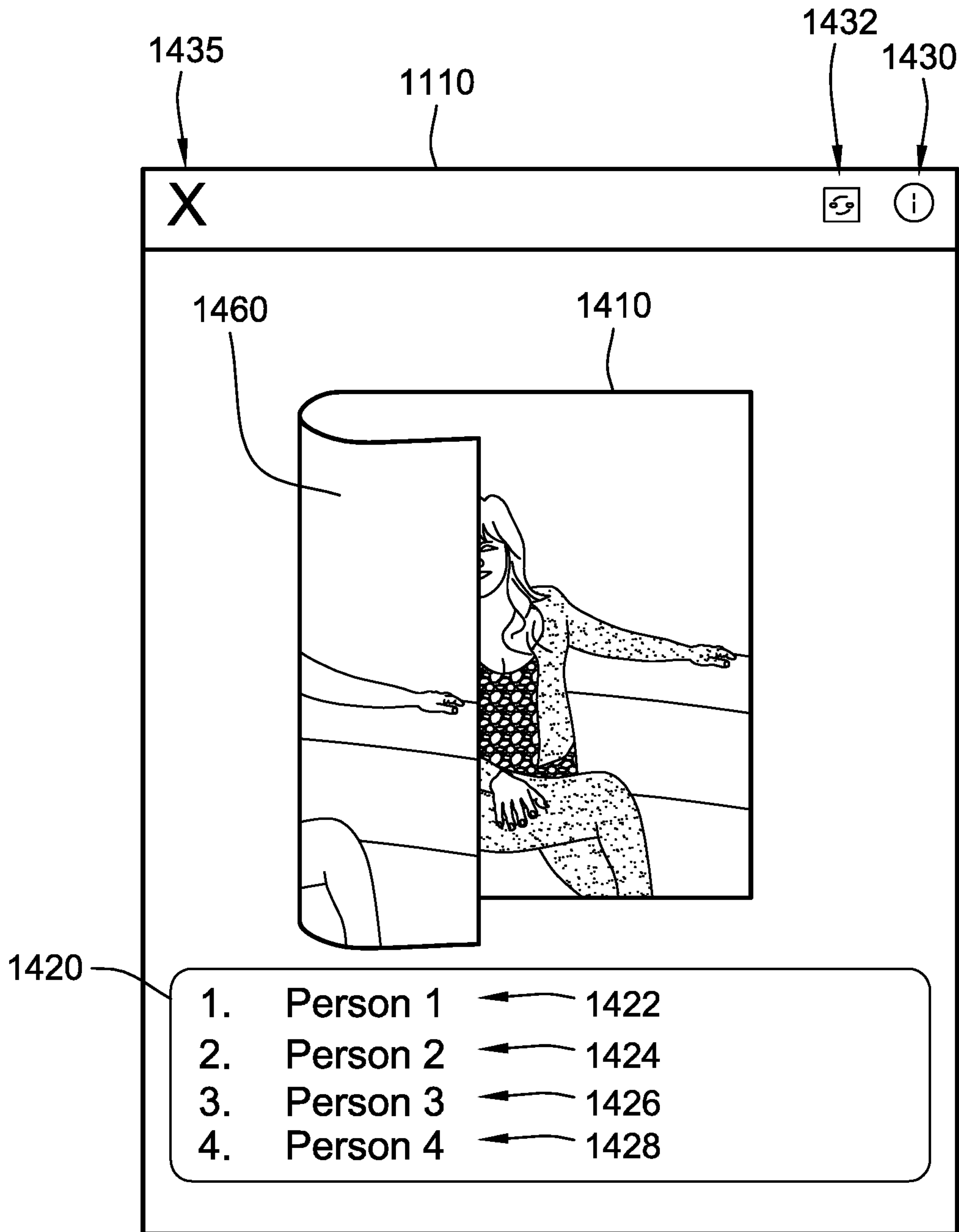

FIG. 8B

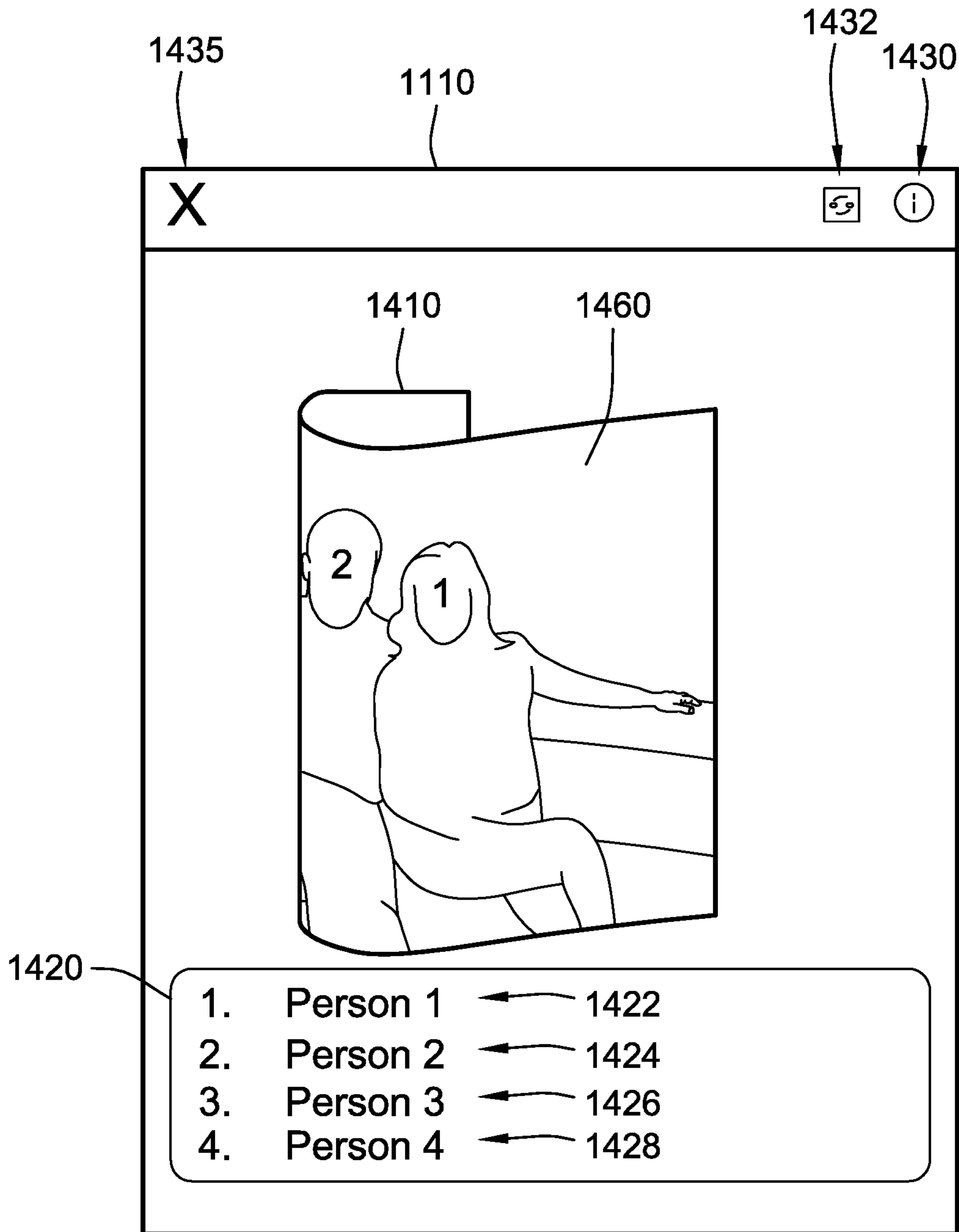

FIG. 8C

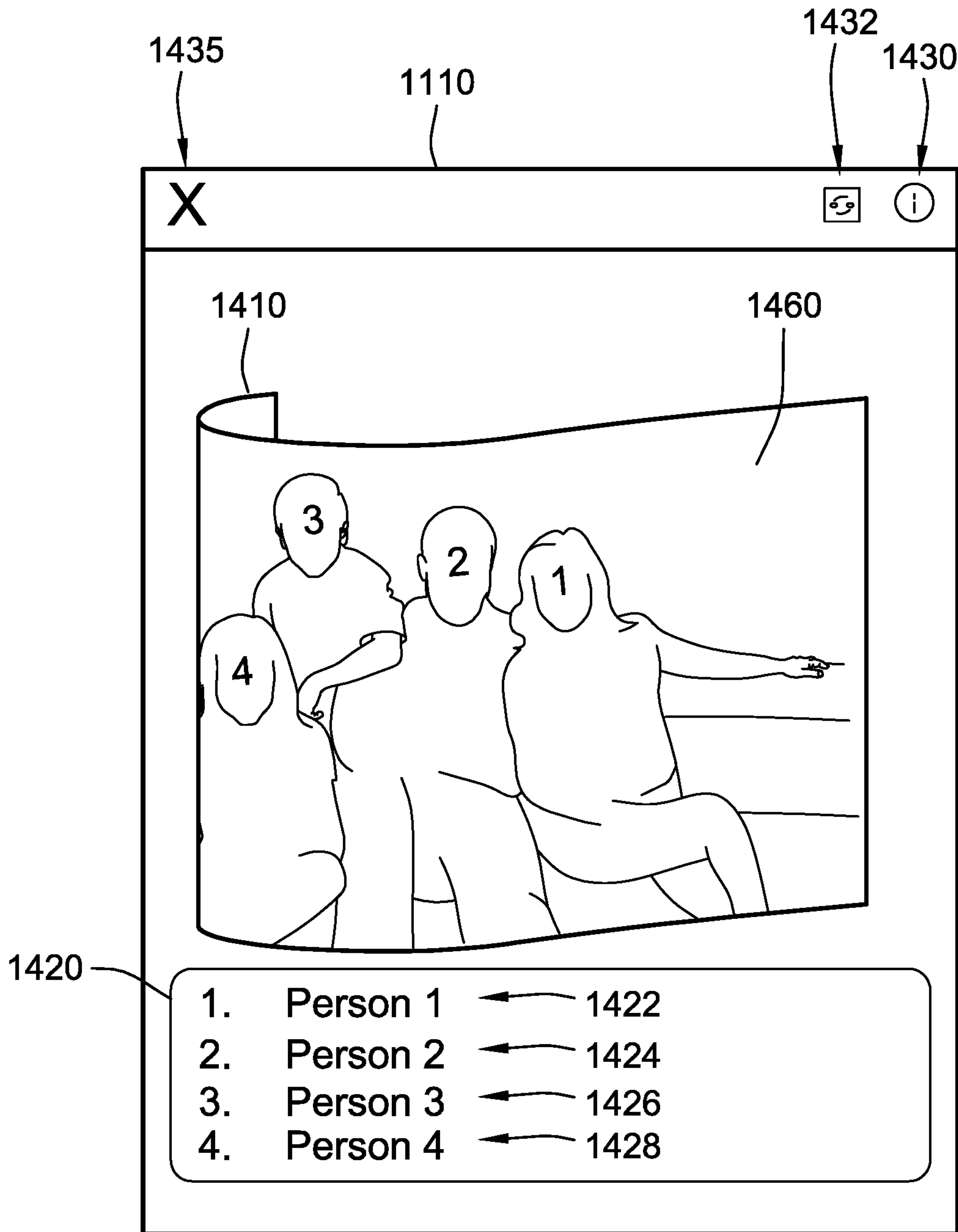

FIG. 8D

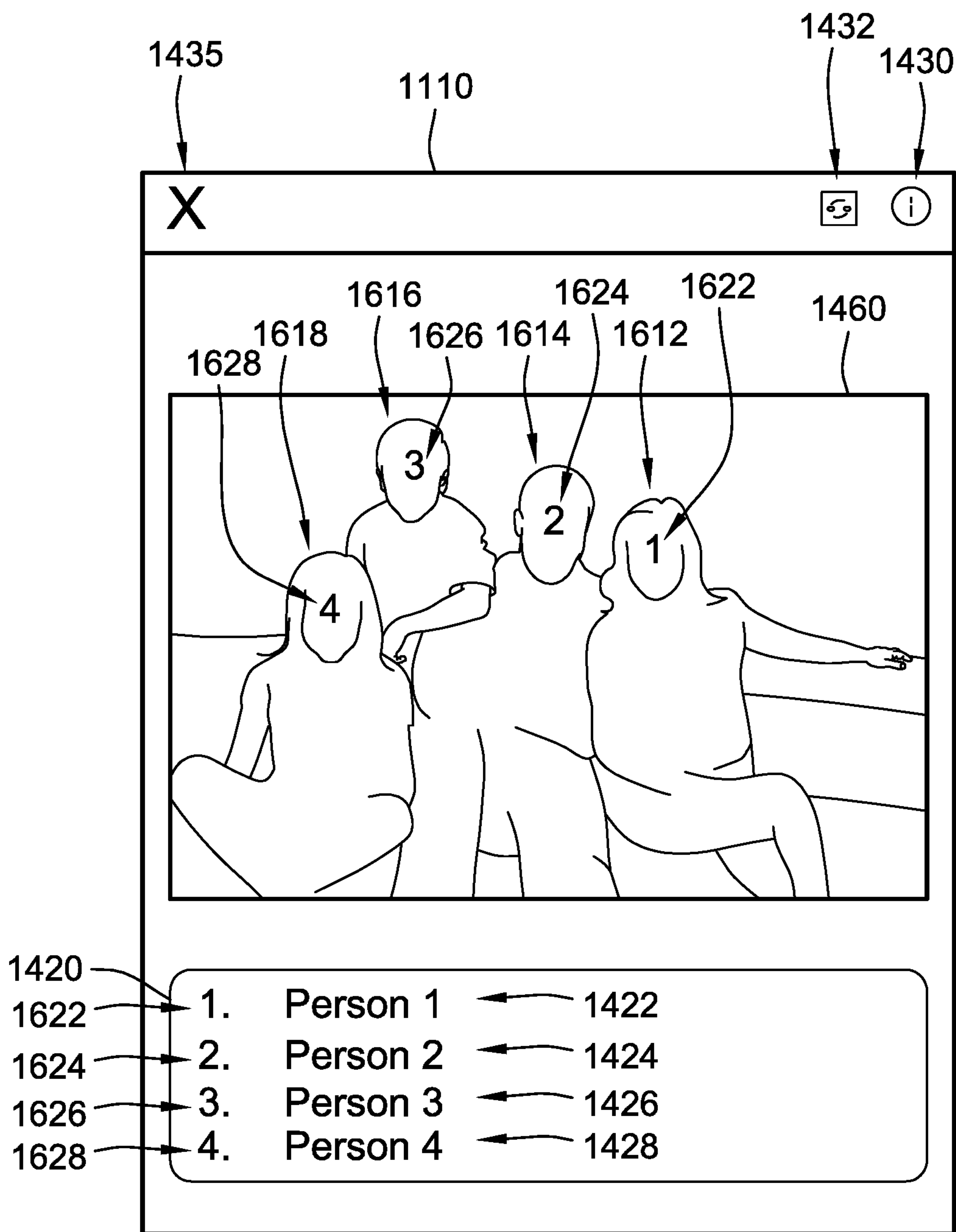

FIG. 8E

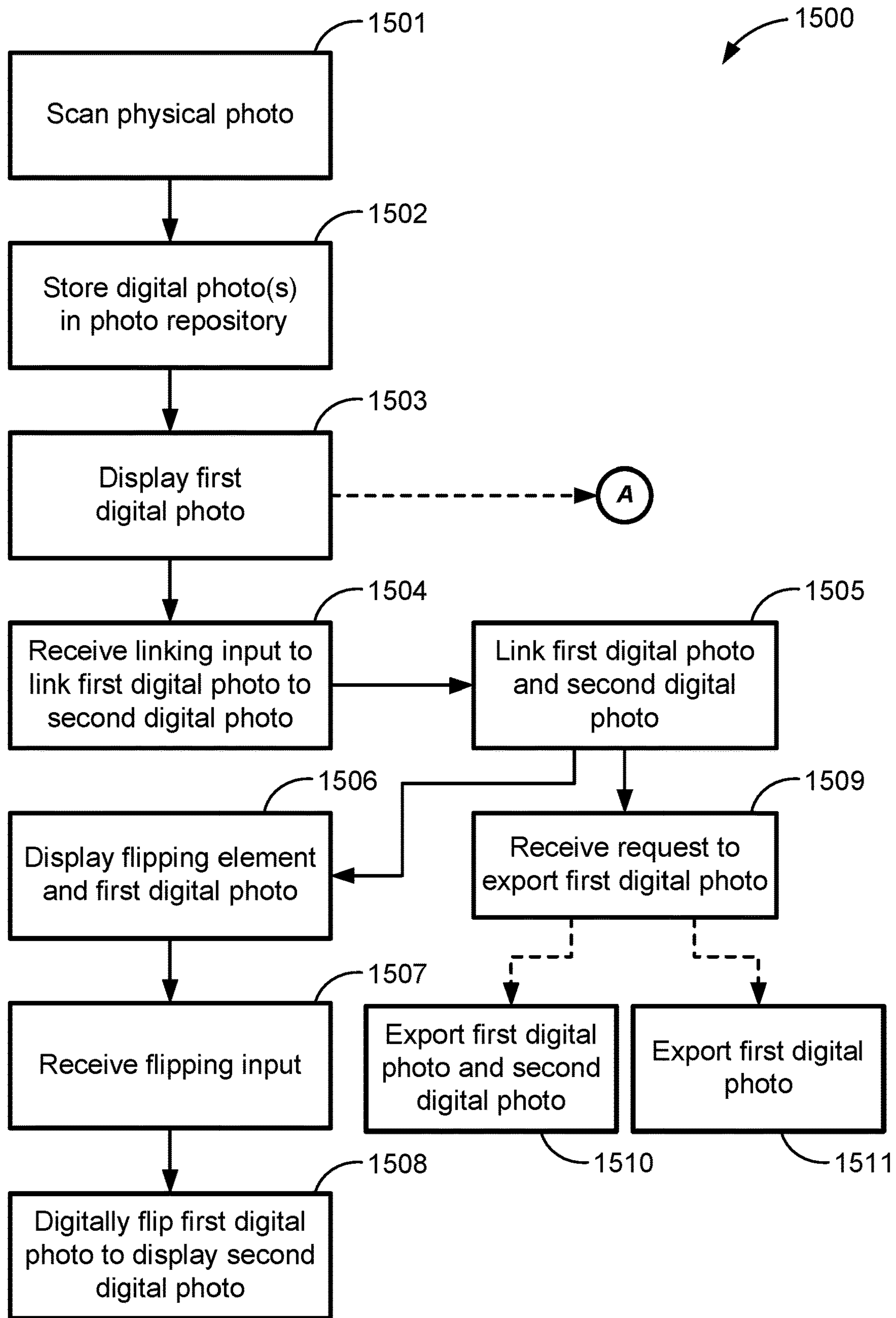

FIG. 9

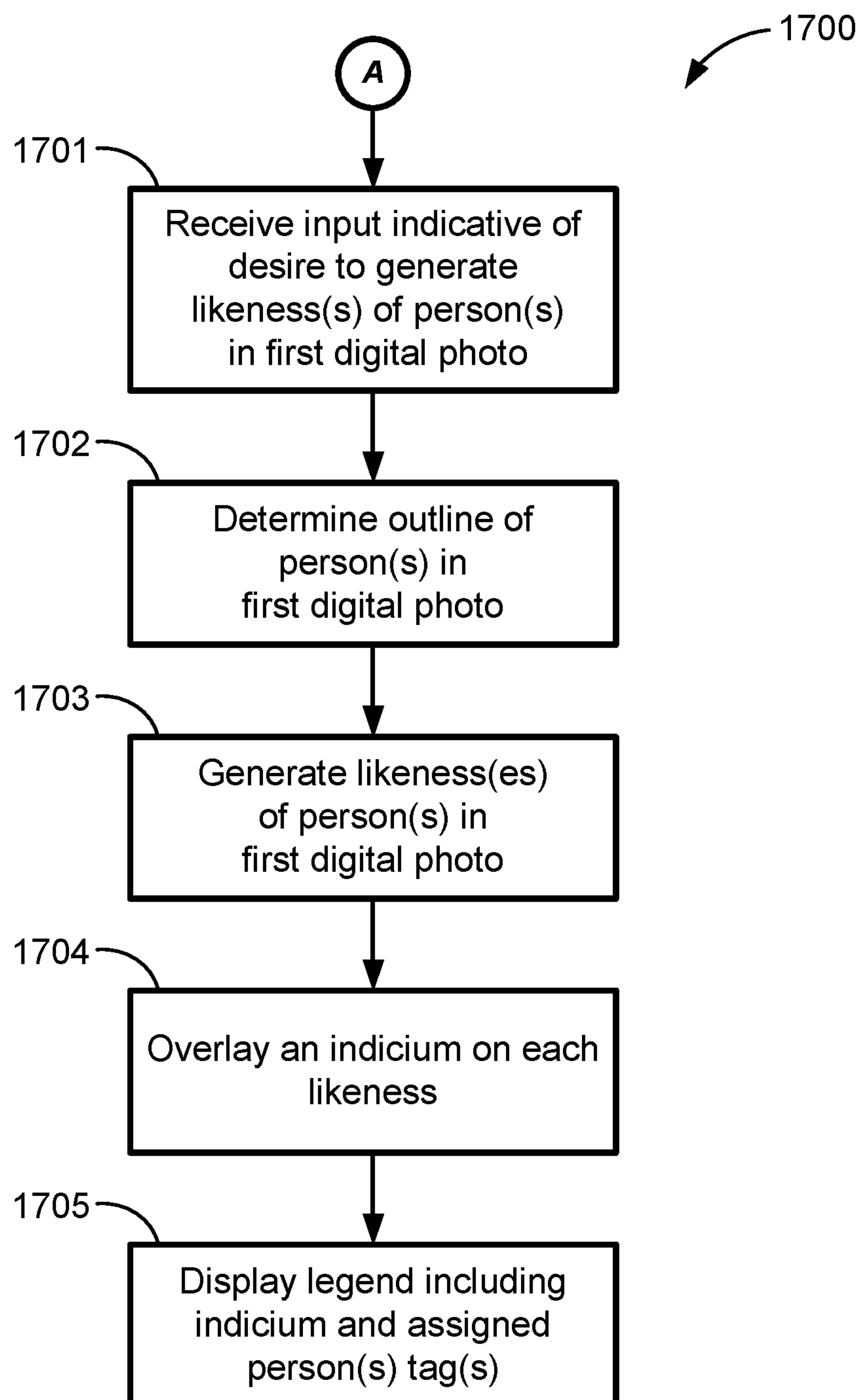

FIG. 10

1444 Cancel 1110 Edit details 1442 Save

OTHER

Exact Date: 1802

Approximate Date: 1804

1812 Select what you know

1810 Month or Season

-	-
January	Winter
February	Spring
March	Summer
April	Fall
May	
June	
July	

Exact or Range

-	-
2018	2018
2017	2017
2016	2016
2015	2015
2014	2014
2013	2013
2012	2012

1814

1816

FIG. 11B

FIG. 11A

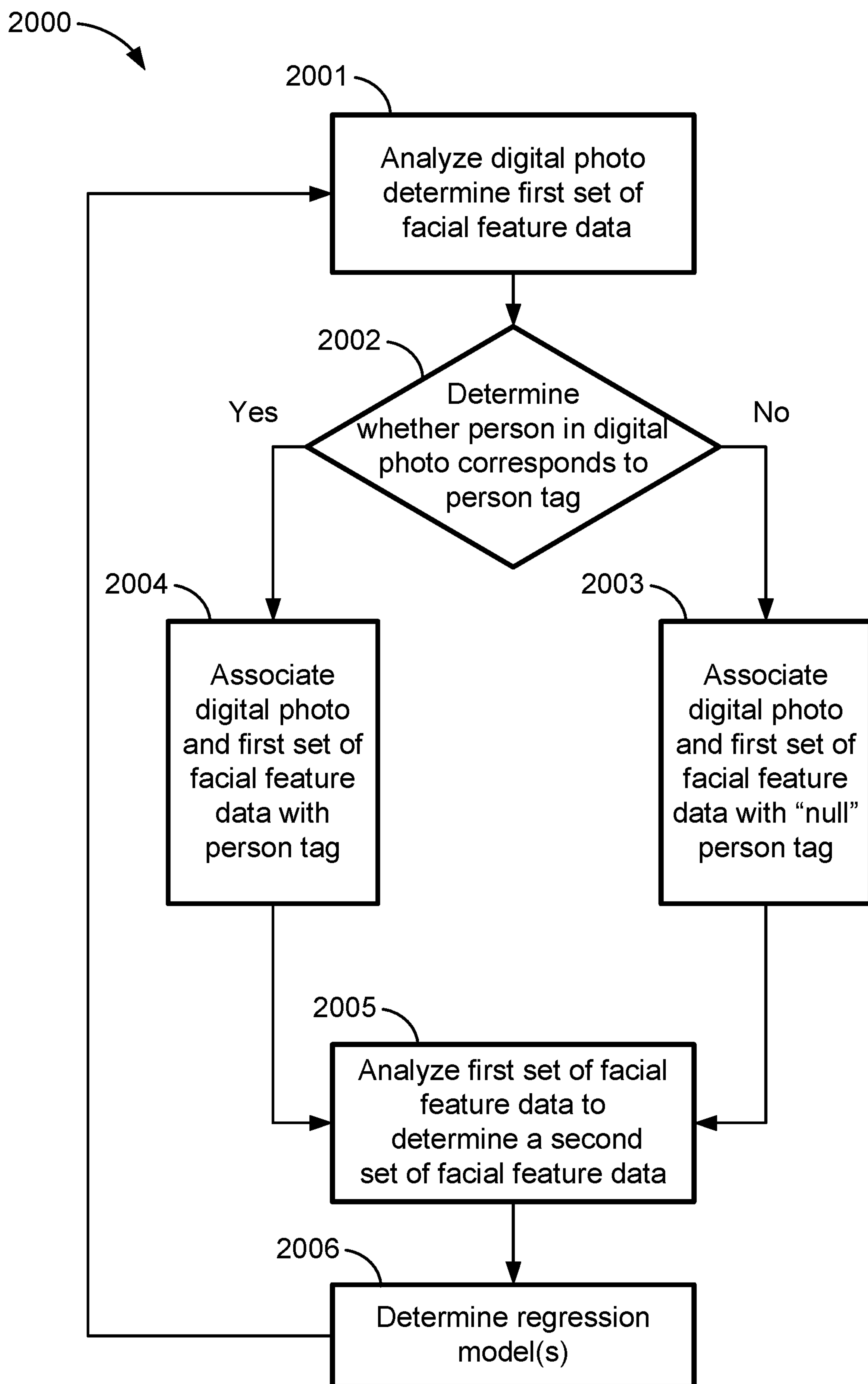

FIG. 12

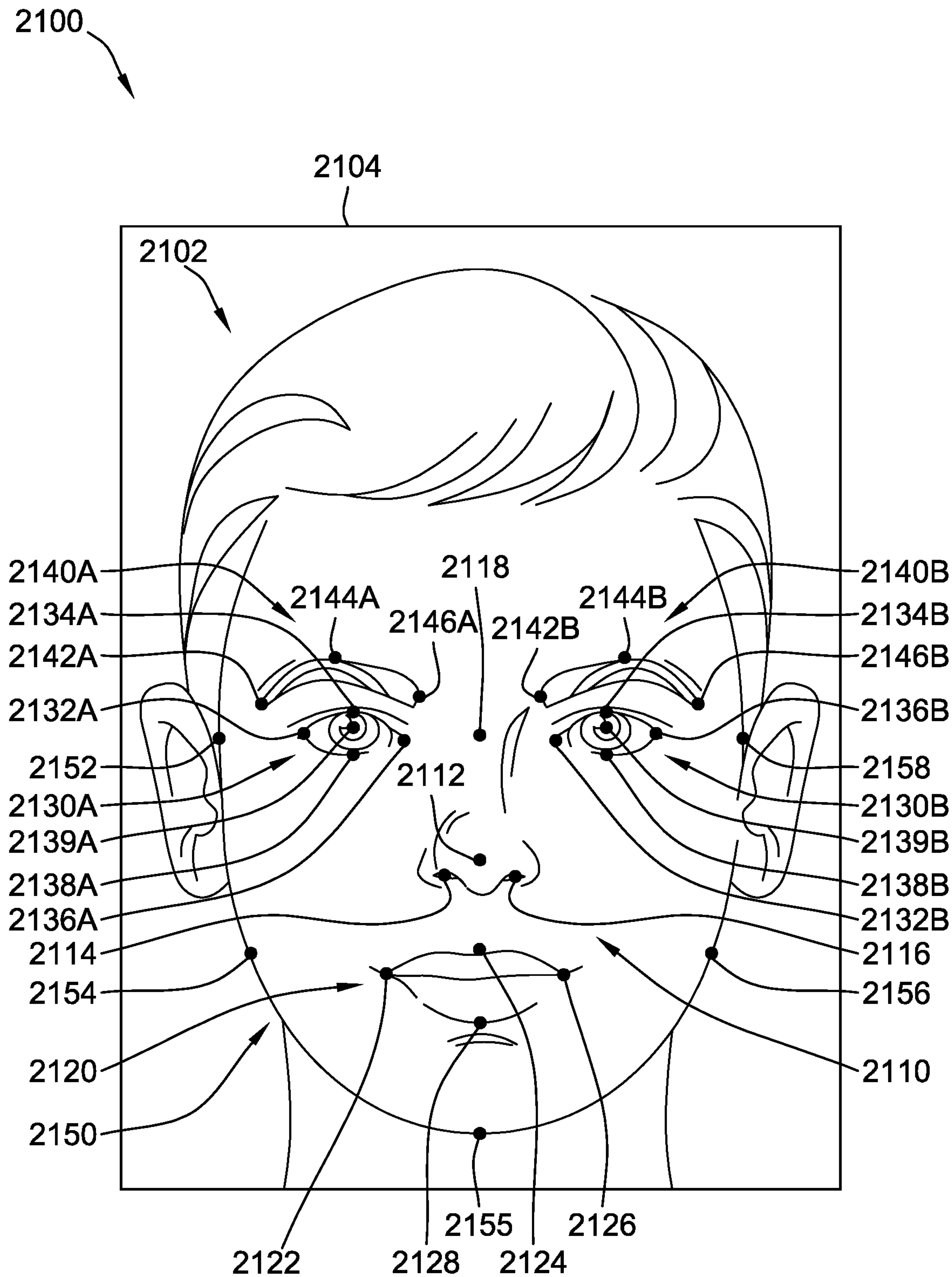

FIG. 13

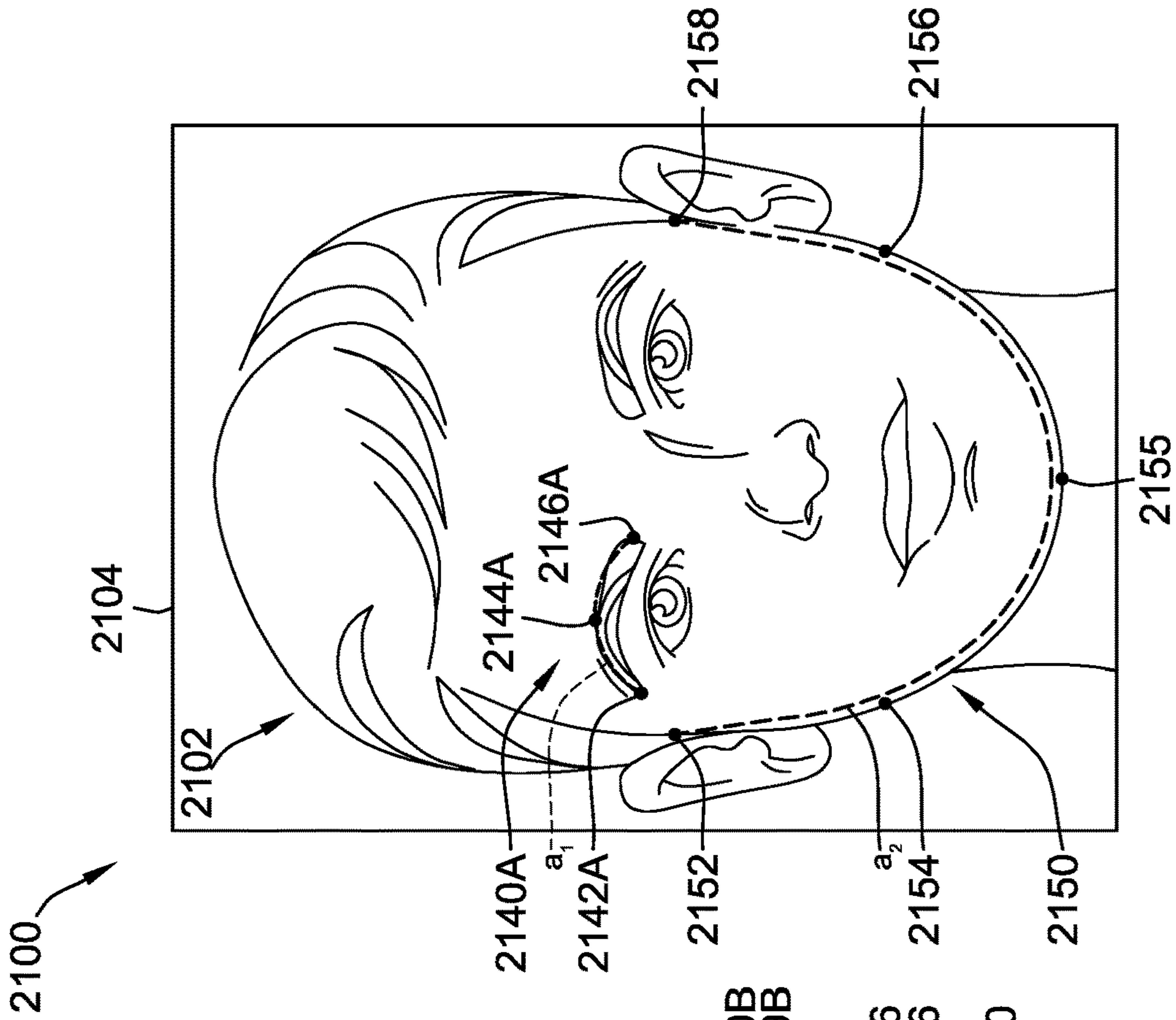

FIG. 14A

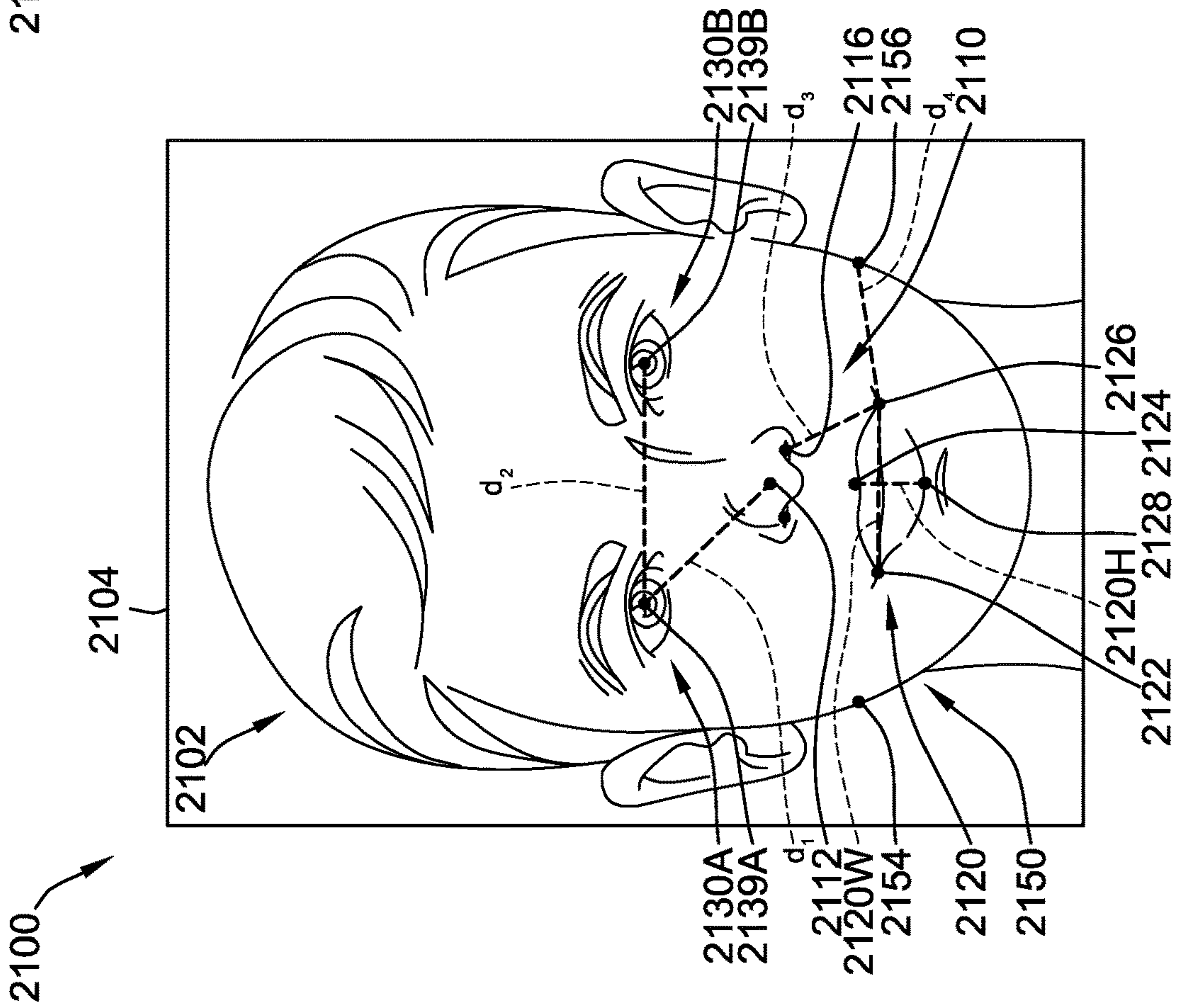

FIG. 14B

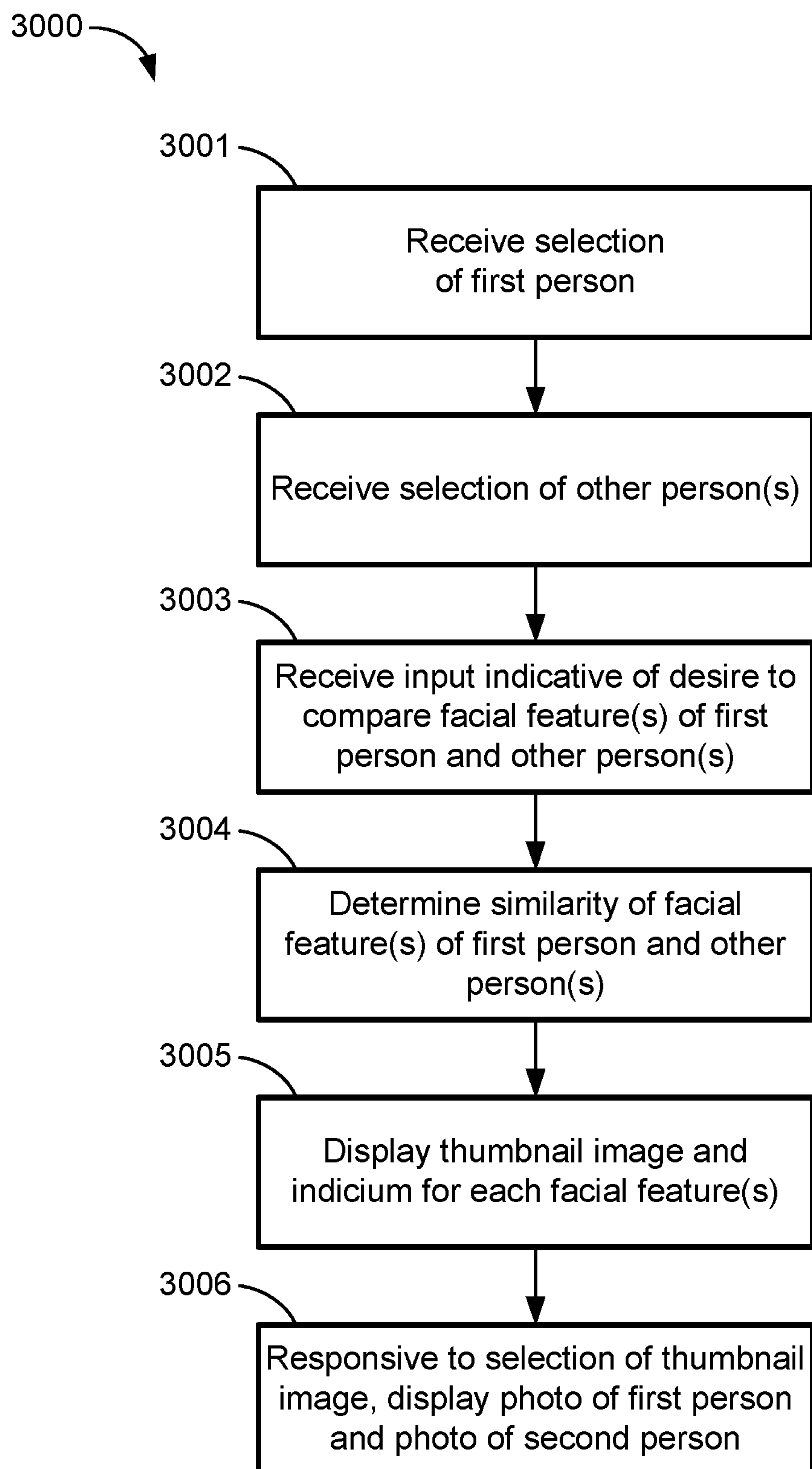

FIG. 15

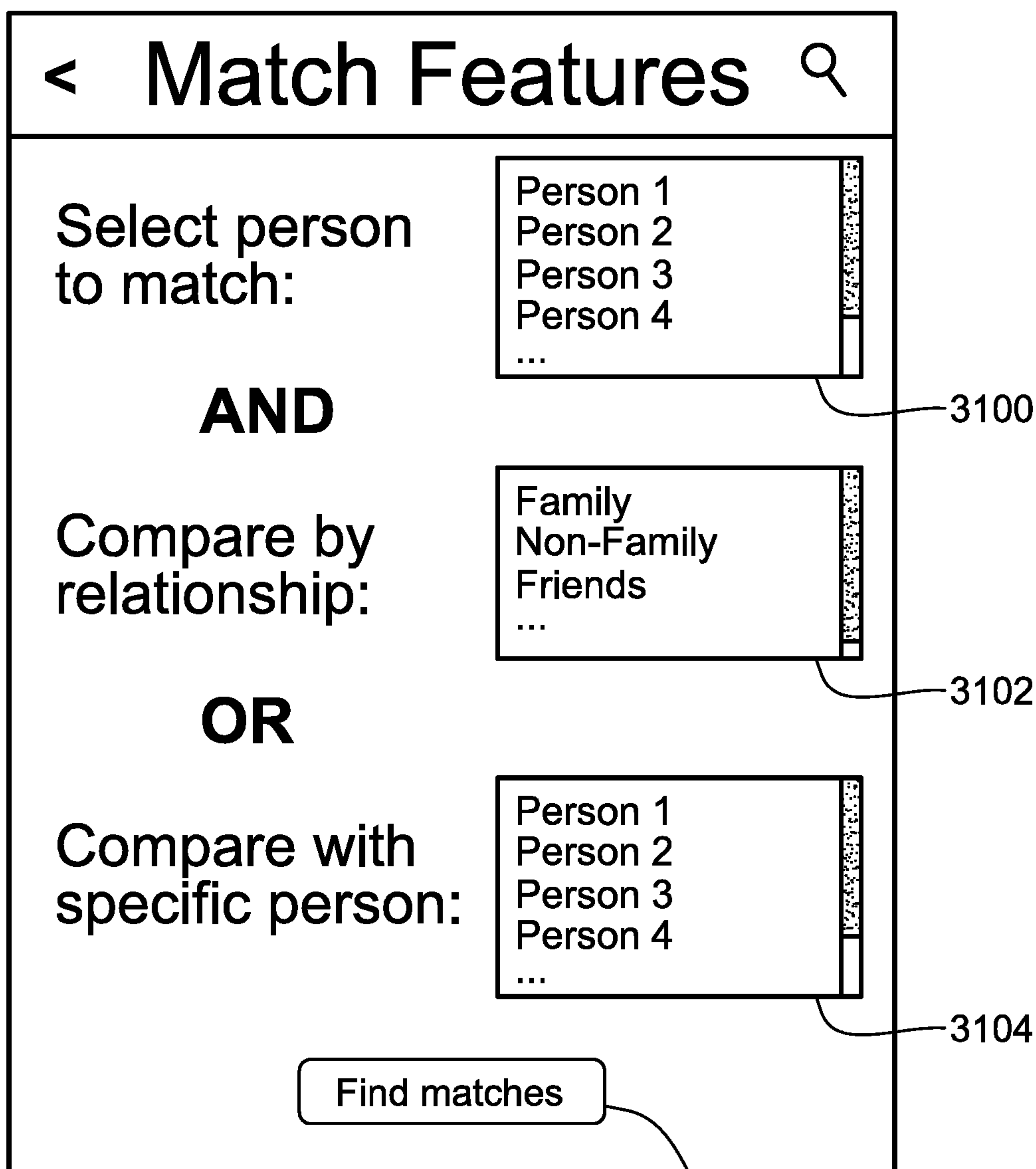

FIG. 16

3106

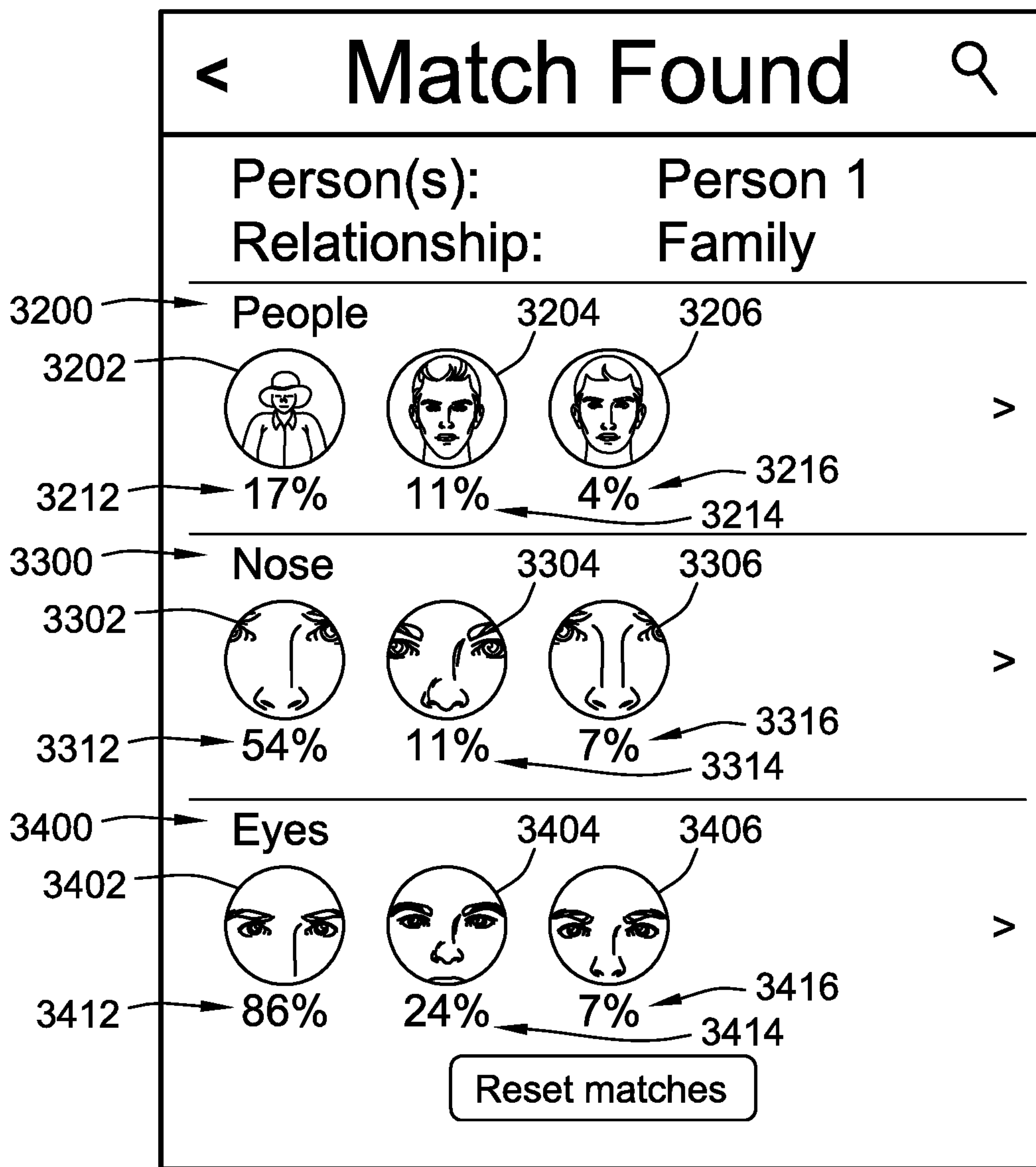

FIG. 17

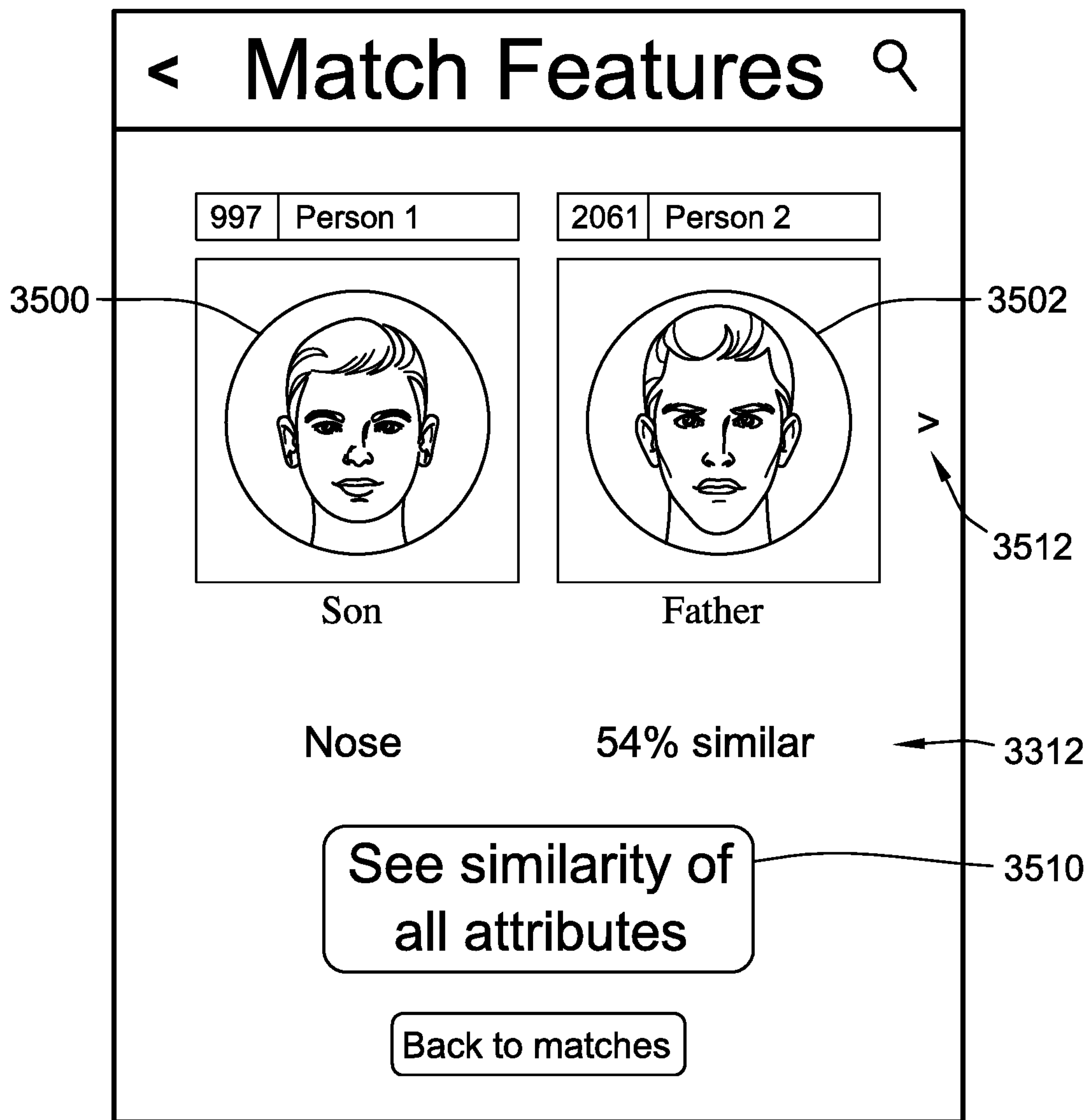

FIG. 18

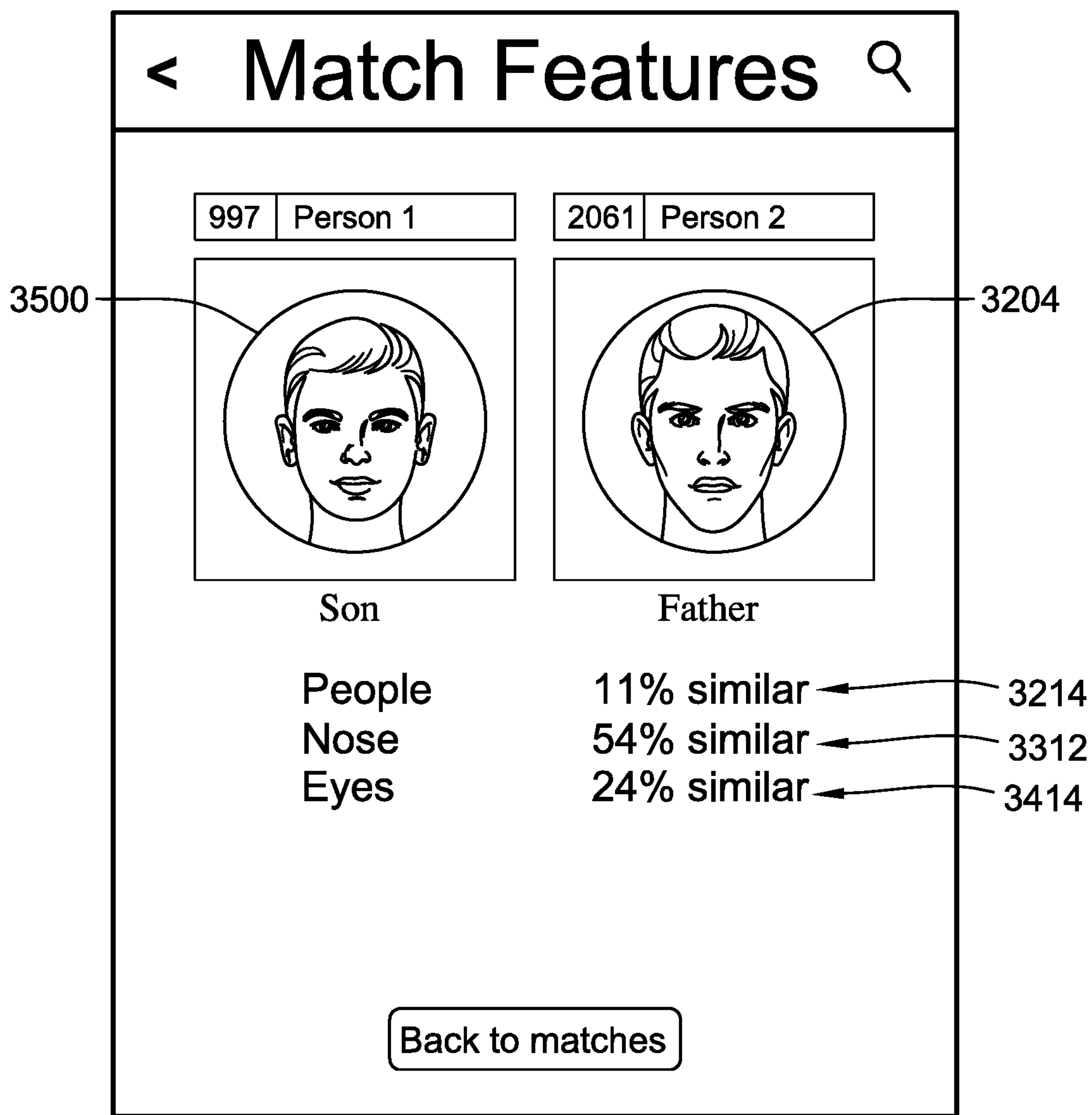

FIG. 19

1

SYSTEMS AND METHODS FOR ANALYZING AND ORGANIZING DIGITAL PHOTOS AND VIDEOS

CROSS-REFERENCE TO RELATED APPLICATIONS

This application claims the benefit of, and priority to, U.S. Provisional Application No. 62/789,288, filed Jan. 7, 2019, which is hereby incorporated by reference herein in its entirety.

TECHNICAL FIELD

The present disclosure relates generally to systems and methods for organizing digital files, and more particularly, to systems and methods for organizing and/or displaying digital photographs or videos.

BACKGROUND

With the evolution of digital cameras, people often store many digital photographs and/or digital videos (e.g., tens, hundreds, thousands, etc.) on personal devices (e.g., smartphones, tablets, laptop computers, etc.) It is often useful to organize these digital photograph and/or videos based on, for example, the date the photo/video was generated, the location that the photo/video was generated, and/or the content of the photo/video. Organizing digital photographs and/or digital videos can aid the user in quickly and efficiently finding digital photographs and/or digital videos stored within a large library of photos/videos. Similarly, it is often useful to associate a first digital photograph or video with at least one other digital photograph or video such that accessing one photograph or video permits a user to quickly access the associated photograph(s) or video(s) without having to individually search for them. The present disclosure is directed to solving these and other problems.

SUMMARY

According to some implementations of the present disclosure, a computer-implemented method for organizing digital videos, each of the digital videos having content data and metadata, the content data being reproducible as an initial video frame, a final video frame, and a plurality of video frames therebetween includes analyzing the content data of a first digital video to associate at least a first portion of a first one of the plurality of video frames of the first digital video with a first automatically-generated content tag, the first video frame of the first digital video being associated with a first time t_1 of the first digital video, automatically generating a first thumbnail image associated with the first digital video, the first thumbnail image including at least a second portion of the first video frame of the first digital video, displaying, on a video display device, the first thumbnail image associated with the first digital video, and responsive to receiving a selection of the first thumbnail image associated with the first digital video via a user interface, causing the first digital video to be played on the video display device starting at the first time t_1 .

According to some implementations of the present disclosure, a computer-implemented method for organizing digital videos, the digital videos having content data and metadata, the content data including an initial video frame, a final video frame, and a plurality of video frames therebetween includes while a first digital video is playing on a

2

video display device, causing the first digital video to be paused at a first time t_1 responsive to an input received via a user interface such that a first one of the plurality of video frames of the first digital video is displayed, receiving, via the user interface, a user-generated tag, associating the user-generated content tag with the first video frame of the first digital video, generating a first thumbnail image associated with the first digital video, the first thumbnail image including at least a portion of the first video frame of the first digital video, displaying the first thumbnail image associated with the first digital video on the video display device, and responsive to receiving a selection of the first thumbnail image via the user interface, causing the first digital video to be played on the video display device starting at the first time t_1 .

According to some implementations of the present disclosure, a computer-implemented method for organizing a plurality of digital videos, each of the plurality of digital videos having content data and metadata, the content data including an initial video frame, a final video frame, and a plurality of video frames therebetween includes analyzing the content data of a first one of the plurality of digital videos to associate at least a first portion of a first one of the plurality of video frames of the first digital video with a first automatically-generated content tag, the first video frame of the first digital video being associated with a first time t_1 of the first digital video, automatically generating a first thumbnail image associated with the first digital video, the first thumbnail image including at least a second portion of the first video frame of the first digital video, analyzing the content data of a second one of the plurality of digital videos to associate at least a first portion of a first one of the plurality of video frames of the second digital video with a second automatically-generated content tag, the first video frame of the second digital video being associated with a first time t_1 of the second digital video, automatically generating a second thumbnail image associated with the second digital video, the second thumbnail image including at least a second portion of the first video frame of the second digital video, displaying the first thumbnail image associated with the first digital video, the second thumbnail image associated with the second digital video, or both, on the video display device, responsive to a selection of the first thumbnail image associated with the first digital video, causing the first digital video to be played on the video display device starting at the first time t_1 of the first digital video, and responsive to a selection of the second thumbnail image associated with the second digital video, causing the second digital video to be played on the video display device starting at the first time t_1 of the second digital video.

According to some implementations of the present disclosure, a computer-implemented method includes storing, in a file repository, a plurality of digital photographs; causing a first one of the plurality of digital photograph to be displayed on a video display device; responsive to receiving an indication that a user desires to digitally link the first digital photograph with another one of the plurality of photographs, prompting the user to select one of the plurality of digital photographs to be digitally linked to the first digital photograph; responsive to the user selecting a second one of the plurality of digital photographs, digitally linking the first digital photograph with the second digital photograph; subsequent to the first digital photograph being digitally linked with the second digital photograph, causing the first digital photograph to be displayed on the display device along with an associated user-selectable flipping element; and responsive to receiving a selection of the displayed user-selectable

flipping element, causing the first digital photograph to be digitally flipped such that the second digital photograph is displayed on the video display device and the first digital photograph is not displayed on the video display device.

According to some implementations of the present disclosure, a computer-implemented method for digitally linking a first digital photograph and a second digital photograph includes storing, in a file repository, a plurality of digital photographs, the plurality of digital photographs including the first digital photograph and the second digital photograph; causing the first digital photograph to be displayed on a video display device; responsive to receiving a linking input indicative of a desire to link the first digital photograph and the second digital photograph, causing the first digital photograph to be digitally linked to the second digital photograph; causing a first user-selectable flipping element and the first digital photograph to be displayed on the video display device; and responsive to receiving a selection of the first user-selectable flipping element, digitally flipping, on the display device, the first digital photograph such that subsequent to the digitally flipping, the second digital photograph is displayed on the video display device and the first digital photograph is not displayed on the video display device.

According to some implementations of the present disclosure, a method for training a regression algorithm for use in comparing one or more facial features of a first person with one or more corresponding facial features of a second person includes analyzing a first digital photograph of the first person to determine a first set of facial feature data for a first facial feature of a face of the first person, the first set of facial feature data including a pose of the face in the first digital photograph, an area of the face in the first digital photograph, and one or more landmarks for the first facial feature in the first digital photograph, determining, based at least in part on the first set of facial feature data, a second set of facial feature data for the first facial feature of the face, analyzing a second digital photograph of the first person to determine a third set of facial feature data for the first facial feature of the face of the first person, the third set of facial feature data including a pose of the face in the second digital photograph, an area of the face in the second digital photograph, and one or more landmarks for the first facial feature of the face in the second digital photograph, determining, based at least in part on the third set of facial feature data, a fourth set of facial feature data for the first facial feature of the face, and determining a regression model for the first facial feature of the first person based on the first set of facial feature data, the second set of facial feature data, the third set of facial feature data, and the fourth set of facial feature data, wherein inputting facial feature data associated with a corresponding first facial feature of the second person into the regression model results in an output value that is indicative of a similarity between the first facial feature of the first person and the corresponding first facial feature of the second person.

According to some implementations of the present disclosure, a computer-implemented method for comparing one or more facial features of a plurality of persons and displaying the results includes receiving, via a user input device, a selection of a first person, the first person being associated with a regression model stored in a photo repository, the regression model being associated with a first facial feature of the first person, responsive to receiving an input indicative of a desire to compare the first person with a second person, causing facial feature data associated with a corresponding first facial feature of the second person to be

inputted into the regression model to obtain an output value from the regression model indicative of a similarity between the first facial feature of the first person and the corresponding first facial feature of the second person, and displaying, on a video display device, (i) a first thumbnail image including at least a portion of a digital photograph of the second person and (ii) an indicium indicative of the similarity between the first facial feature of the first person and the corresponding first facial feature of the second person.

According to some implementations of the present disclosure, a computer-implemented method for comparing one or more facial features of a plurality of persons and displaying the results includes receiving, via a user input device, a selection of a first person, the first person being associated with a first regression model is stored in a photo repository, the first regression model being associated with a first facial feature of the first person, responsive to receiving an input indicative of a desire to compare the first person to a plurality of other persons, causing facial feature data associated with each of the plurality of other persons to be inputted into the first regression model to obtain a first output value indicative of a similarity between the first facial feature of the first person and a corresponding first facial feature of each of the plurality of other persons, and responsive to determining that the first output value for at least one of the plurality of other persons is greater than a predetermined threshold, displaying, on a video display device, a thumbnail image including at least a portion of a digital photograph of the at least one of the plurality of other persons and an indicium indicative of the similarity between the first facial feature of the first person and the corresponding first facial feature of the at least one of the plurality of other persons.

The above summary is not intended to represent each embodiment or every aspect of the present invention. Additional features and benefits of the present invention are apparent from the detailed description and figures set forth below.

BRIEF DESCRIPTION OF THE DRAWINGS

FIG. 1 is a functional block diagram of a system for organizing digital videos according to some implementations of the present disclosure;

FIG. 2A illustrates exemplary thumbnail images associated with digital videos displayed on a video display device according to some implementations of the present disclosure;

FIG. 2B illustrates an initial video frame of a first digital video displayed on the video display device subsequent to a user's selection of a first thumbnail of FIG. 2A associated with the first digital video according to some implementations of the present disclosure;

FIG. 2C illustrates a first video frame of the first digital video displayed on the video display device according to some implementations of the present disclosure;

FIG. 2D illustrates selectable location tags displayed on the video display device responsive to a user selection of a location tag element of FIG. 2C according to some implementations of the present disclosure;

FIG. 2E illustrates selectable date tags displayed on the video display device responsive to a user selection of a date tag element of FIG. 2C according to some implementations of the present disclosure;

FIG. 2F illustrates a second video frame of the first digital video displayed on the video display device according to some implementations of the present disclosure;

5

FIG. 2G illustrates a movable region of interest overlaid on the second video frame of FIG. 2F responsive to a user selection of a person tag element of FIG. 2F according to some implementations of the present disclosure;

FIG. 2H illustrates selectable person tags displayed on the video display device according to some implementations of the present disclosure;

FIG. 2I illustrates selectable event tags displayed on the video display device responsive to a user selection of an event tag element of FIG. 2F according to some implementations of the present disclosure;

FIG. 3A is a process flow diagram for a method for organizing digital videos according to some implementations of the present disclosure;

FIG. 3B illustrates a second thumbnail image associated with the first digital video according to some implementations of the present disclosure;

FIG. 4 is a functional block diagram of a system for linking digital photographs according to some implementations of the present disclosure;

FIG. 5A illustrates a first digital photograph displayed on a video display device of the system of FIG. 4 according to some implementations of the present disclosure;

FIG. 5B illustrates a linking element displayed on the video display device according to some implementations of the present disclosure;

FIG. 5C illustrates a plurality of digital photographs displayed on the video display device according to some implementations of the present disclosure;

FIG. 6A illustrates a first digital photograph and a flipping element displayed on a video display device of the system of FIG. 4 prior to the initiation of a digital flipping action according to some implementations of the present disclosure;

FIG. 6B illustrates the first digital photograph of FIG. 6A in a first position during digital flipping according to some implementations of the present disclosure;

FIG. 6C illustrates the first digital photograph of FIG. 6A in a second position during digital flipping according to some implementations of the present disclosure;

FIG. 6D illustrates a second digital photograph in a first position during digital flipping according to some implementations of the present disclosure;

FIG. 6E illustrates the second digital photograph of FIG. 6D in a first position during digital flipping according to some implementations of the present disclosure;

FIG. 6F illustrates the second digital photograph of FIG. 6D upon completion of the digital flipping in FIGS. 6B-6E according to some implementations of the present disclosure;

FIG. 7A illustrates a first digital photograph and a flipping element displayed on a video display device of the system of FIG. 4 prior to the initiation of a digital flipping action according to some implementations of the present disclosure;

FIG. 7B illustrates the first digital photograph of FIG. 7A in a first position during digital flipping according to some implementations of the present disclosure;

FIG. 7C illustrates the first digital photograph of FIG. 7A in a second position during digital flipping according to some implementations of the present disclosure;

FIG. 7D illustrates a second digital photograph in a first position during digital flipping according to some implementations of the present disclosure;

FIG. 7E illustrates the second digital photograph of FIG. 7D in a first position during digital flipping according to some implementations of the present disclosure;

6

FIG. 7F illustrates the second digital photograph of FIG. 7D upon completion of the digital flipping in FIGS. 7B-7E according to some implementations of the present disclosure;

FIG. 8A illustrates a first digital photograph and a flipping element displayed on a video display device of the system of FIG. 4 prior to the initiation of a digital flipping action according to some implementations of the present disclosure;

FIG. 8B illustrates a first portion of the first digital photograph of FIG. 7A and a first portion of a second digital image during digital flipping according to some implementations of the present disclosure;

FIG. 8C illustrates a second portion of the second digital image of FIG. 8B during digital flipping according to some implementations of the present disclosure;

FIG. 8D illustrates a third portion of the second digital image of FIG. 8B during digital flipping according to some implementations of the present disclosure;

FIG. 8E illustrates the second digital photograph upon completion of the digital flipping according to some implementations of the present disclosure;

FIG. 9 is a process flow diagram for a method of linking digital photographs according to some implementations of the present disclosure;

FIG. 10 is a process flow diagram for a method for generating a second photograph including a likeness of a first person in a first photograph according to some implementations of the present disclosure;

FIG. 11A illustrates an exact date tag element and an approximate date tag element displayed on a video display device according to some implementations of the present disclosure;

FIG. 11B illustrates a month input element, a season input element, a first year input element, and a second year input element according to some implementations of the present disclosure;

FIG. 12 is a process flow diagram for a method comparing one or more facial features of a first person to one or more corresponding facial features of one or more other persons according to some implementations of the present disclosure;

FIG. 13 illustrates landmarks for facial feature of a face of a first person in a digital photograph according to some implementations of the present disclosure;

FIG. 14A illustrates relative distances between a plurality of facial features of the face of FIG. 13 according to some implementations of the present disclosure;

FIG. 14B illustrates arcs of a plurality of facial features of the face of FIG. 13 according to some implementations of the present disclosure;

FIG. 15 is a process flow diagram for a method for comparing facial features of one or more persons and displaying the results according to some implementations of the present disclosure;

FIG. 16 illustrates a plurality of selection elements displayed on a video display device according to some implementations of the present disclosure;

FIG. 17 illustrates people feature results, nose feature results, and eye features results displayed on a video display device according to some implementations of the present disclosure;

FIG. 18 illustrates a photographs of a plurality of matched persons and an indicium indicative of the similarity of a feature between those matched persons according to some implementations of the present disclosure; and

FIG. 19 illustrates indicia indicative of the similarity of a plurality of features between two people according to some implementations of the present disclosure.

While the disclosure is susceptible to various modifications and alternative forms, specific embodiments thereof have been shown by way of example in the drawings and will herein be described in detail. It should be understood, however, that it is not intended to limit the invention to the particular forms disclosed, but on the contrary, the intention is to cover all modifications, equivalents, and alternatives falling within the spirit and scope of the invention as defined by the appended claims.

DETAILED DESCRIPTION

Digital Video Tagging

With the evolution of digital cameras, people often have a voluminous library of digital videos (e.g., videos recorded using a smartphone camera) that stored and/or can be accessed on, for example, personal device(s) (e.g., smartphones, tablets, laptop computers, etc.) Often, digital videos are organized in a library based on the date that the video was generated, or in albums (e.g., user generated albums). Each digital video can be associated with a user-selectable thumbnail image that includes, for an example, an image from the digital video. Selecting the thumbnail image causes the digital video to be displayed on a display device. However, unlike digital photographs which are a single image, digital videos contain a series of video frames. If a user desires to view a certain event or person in a digital video (e.g., five minutes into the video), the user must either wait five minutes or take affirmative action(s) once the video starts playing (e.g., fast forwarding) to view that event or person. This leads to inefficiencies when attempting to view a particular point in time in one of many videos that are stored on the user's device.

With the advent of digital videos, people often convert older video formats (e.g., VHS, 8 mm film, etc.) to a digital format. In particular, a VHS tape or an 8 mm film, for example, are often converted into a single digital video file. However, old cameras would often record a series of videos on a single film (e.g., VHS or 8 mm film) such that when the film is converted, the digital video file contains a series of video segments. For example, a converted VHS tape that was originally recorded using a camcorder may contain video segments that were generated on different dates, different locations, and/or contain multiple people or events. While the converted digital version may be associated with a date of the conversion, it is a blank slate and not associated with a date that the video or video segments were generated, location information, or content information (e.g., the names of people or events in the video). Thus, it would be advantageous to permit a user to manually tag digital videos (e.g., with person tags, location tags, date tags, etc.) to aid in organizing and accessing these digital videos.

Referring to FIG. 1, a system 1 for organizing digital videos includes a user device 10 and a remote device 30. Generally, the system 1 organizes digital videos (e.g., digital videos generated by the user device 10) by automatically generating tags and associating them with the digital videos, receiving user-generated tags and associating them with the digital videos, or both. Assigning an automatically-generated tag and/or a user-generated tag to a desired time within a digital video causes a selectable thumbnail image to be generated, which can then be displayed on the video display device. Selecting the thumbnail image causes the digital video to be played starting at the desired time associated

with the assigned tag. Thus, the system 1 can be used to organize digital videos and provide an efficient and intuitive user interface for accessing (e.g., viewing) particular people, events, tags, locations, etc. that appear in a video.

The user device 10 includes one or more processors 12 (hereinafter "processor"), one or more memory devices 14 (hereinafter, "memory device"), a digital camera 18, a GPS module 20, a video display device 22, a user input device 24, and a communication module 26. The processor 12 of the user device 10 is communicatively coupled to the memory device 14, the digital camera 18, the GPS module 20, the video display device 22, the user input device 24, and the communication module 26. The processor 12 is generally used to control the operation of these various components of the system 1 and implement the methods described herein.

The processor 12 can be a general or special purpose processor or microprocessor, and the user device 10 can include any suitable number of processors (e.g., one processor, two processors, four processors, ten processors, etc.)

The memory device 14 is generally used to store machine readable instructions that are executable by the processor 12. The memory device 14 can be any suitable computer readable storage device or media, such as, for example, a random or serial access memory device, a hard disk drive, a solid state drive, a flash memory device, etc. In particular, the memory device 14 stores a video repository 16. The video repository 16 of the memory device 14 stores one or more digital videos (e.g., that are generated by the camera 18). As described in further detail herein, each of the digital videos stored in the video repository 16 include content data and metadata. While the memory device 14 is described herein as including video repository 16, the memory device 14 can also store therein one or more digital photographs (e.g., a combined video/photo repository).

The content data of each digital video includes data reproducible as a series of video frames that can be displayed in succession, for example, on the video display device 22. More specifically, the content data of a digital video includes an initial video frame associated with an initial time t_0 of the digital video (e.g., the beginning of the digital video), a final video frame associated with an end time t_{end} of the digital video (e.g., the end of the digital video), and a plurality of video frames therebetween. Each of the plurality of video frames is associated with a time between the initial t_0 of the digital video and the end time t_{end} of the digital video. The number of video frames in the content data of a digital video is a function of the total length (time) of the digital video and the number of frames per second ("fps") that were generated. For example, if the digital video is generated at 30 fps, and the digital video is 10 seconds long, the content data of that digital video includes 300 video frames: an initial video frame, a final video frame, and 298 video frames therebetween.

The metadata of a digital video stored in the video repository 16 includes location data indicative of a geographic location where the digital video was generated and/or date and time data associated with the date and/or time when the digital video was generated. In some implementations, the metadata of a digital video can also include file information (e.g., file name, file type, file size, etc.), camera information (e.g., camera make/model, fps, etc.), author information, (e.g. author name, device name, etc.)

The digital camera 18 is generally configured to generate image data reproducible as one or more digital images, including still images, video images, or both. Thus, the digital camera 18 can be used to generate the digital videos that are stored in the video repository 16 of the memory

device **14**. The digital camera **18** can optionally include optical and/or digital zoom features, a light to aid in generating digital videos, filters, or any combination thereof. While the user device **10** is shown as including one digital camera **18**, the user device **10** can include a plurality of digital cameras (e.g., two digital cameras, three digital cameras, etc.) For example, the user device **10** can include a first front-facing digital camera and an opposing, second rear-facing digital camera.

The GPS module **20** (e.g., GPS sensor) is configured to receive GPS signals for determining a location of the user device **10** (e.g., expressed in terms of latitude and longitudinal, or other coordinates). Thus, when a digital video is generated using the camera **18** of the user device **10**, the GPS module **20** can be used to generate the location data indicative of the geographic location of the user device **10** when the photo or video is generated that is then included in the metadata of the digital video when stored in the video repository **16** of the memory device **14**. This location data from the GPS module **20** is then stored as part of the digital video's metadata that can later be analyzed, for example, to automatically assign a location tag to the digital video.

The video display device **22** is a human-machine interface (HMI) including a graphical user interface (GUI) that can display images (e.g., still images, video images, etc.) As described in further detail herein, the video display device **22** of the user device **10** can be used to display digital videos that are stored in the video repository **16** of the memory device **14**. The video display device **22** can be, for example, a general or special purpose desktop computer, a laptop, a tablet computer, a smartphone, a display monitor, a television, LED display, LCD display, or the like, or any combination thereof. The user input device **24** is configured to sense inputs made by a human user interacting with the user device **10** and can be, for example, a touchscreen or touch-sensitive substrate, a mouse, a keyboard, or any combination thereof. For example, as described herein, the user input device **24** can receive input(s) from a human user that controls what is displayed on the video display device **22**. In some implementations, the user input device **24** is integrated within the video display device **22** (e.g., the user input device **24** and the video display device are a touchscreen display of a smartphone).

The communication module **26** is configured for wireless communication (e.g., via a cellular network) with the remote device **30**. As described in further detail herein, the communication module **26** can be used to transmit data stored in the video repository **16** of the memory device **14** of the user device **10** to the remote device **30** for processing, and/or transmit data stored in the video repository **36** of the memory device **34** of the remote device **30** to be displayed on the video display device **22** of the user device **10**. The communication module **26** can include, for example, an antenna, a receiver, a transmitter, a transceiver, or any combination thereof.

Generally, the user device **10** can be, for example, a general or special purpose desktop computer, a laptop computer, a tablet computer, or a smartphone, with all or some of the components contained therein. In some implementations, the user device **10** is a smartphone containing each of the processor **12**, memory device **14**, camera **18**, GPS module **20**, video display device **22**, user input device **24**, and the communication module **26** within a housing. While the user device **10** is shown in FIG. **1** as including all of the components described herein, more or fewer components can be included in a user device. For example, an alternative user device (not shown) includes the processor **12**, the

memory device **14**, the video display device **22**, the user input **116**, and the communication module **26**. Thus, various user devices can be formed using any portion of the components described herein.

The remote device **30** includes one or more processors **32** (hereinafter, "processor"), one or more memory devices **34** (hereinafter, "memory device"), and a communication module **38**. The processor **32** is the same as, or similar to, to the processor **12** of the user device **10** described herein and is communicatively coupled to the memory device **34** and communication module **128**. The memory device **34** is the same as, or similar to, the memory device **14** of the user device **10** and includes a video repository **36** that is the same as, or similar to, the video repository **16** of the memory device **14** of the user device **10**. The video repository **36** stores digital videos therein. The communication module **38** of the remote device **30** is configured to wirelessly communicate with the communication module **26** of the user device **10** (e.g., via a cellular network, WiFi, or the like). For example, the remote device **30** can receive data from the video repository **16** of the user device **10** via the communication module **38** and store the data in the video repository **36** (e.g., such that all of the data stored in the video repository **16** of the user device **10** is stored in the video repository **36**). In some implementations, the remote device **30** is a remote server that communicates with the user device **10** via the Internet (e.g., via a cellular network).

While the system **1** is shown in FIG. **1** as including one user device **10**, in some implementations, the remote device **30** can be communicatively coupled to a plurality of user devices that are the same as, or similar to, the user device **10** (e.g., two user devices, ten user devices, one hundred user devices, one thousand user devices, etc.) Thus, data from the video repository of each of a plurality of user devices can be transmitted and stored in the video repository **36** of the remote device **30**.

Referring to FIG. **2A**, a first thumbnail image **100**, a second thumbnail image **200**, and a third thumbnail image **300** are displayed on the video display device **22**. The first thumbnail image **100** is associated with a first digital video, the second thumbnail image **200** is associated with a second digital video, and the third thumbnail image **300** is associated with a third digital video. The first, second, and third digital videos are stored in the video repository **16** of the user device **10** and/or the video repository **36** of the remote device **30**. A user-selectable navigation element **400** is also displayed on the video display device **22**. The user-selectable navigation element **400** can be selected by a user (e.g., by tapping or clicking) to navigate away from the thumbnail images **100**, **200**, and **300** displayed on the video display device **22** (e.g., to an album of photos and videos, a home page/screen or dashboard, etc.)

As shown, the first thumbnail image **100** associated with the first digital video includes a boundary **102** and a runtime indicium **104** representative of the length (e.g., total time) of the first digital video. The first thumbnail image **100** also includes at least a portion of an initial video frame **110** of the first digital video that is associated with an initial time t_0 of the first digital video. As shown, both the initial video frame **110** and the runtime indicium **104** are positioned within the boundary **102**. The runtime indicium **104** is overlaid on a portion of the initial video frame **110** and includes alphanumeric text that provides an indication of the total length of the first digital video (e.g., expressed in terms of seconds, minutes, hours, or any other suitable measurement of time, or any combination thereof). In this example, the runtime indicium **104** indicates that the first digital video is one (1)

minute long. While the runtime indicium **104** is shown as being positioned within the boundary **102**, the runtime indicium **104** can more generally be positioned generally adjacent to the boundary **102** (e.g., below the boundary **102**).

The second thumbnail image **200** associated with the second digital video is similar to the first thumbnail image **100** associated with the first digital video and includes a boundary **202** and a runtime indicium **204**. At least a portion of an initial video frame **210** of the second digital video is displayed within the boundary **202** of the second thumbnail image **200**. The runtime indicium **204** of the second thumbnail image **200** differs from the runtime indicium **104** in that it indicates the second digital video is two (2) minutes and twenty (20) seconds long. The third thumbnail image **300** associated with the third digital video is similar to the first thumbnail image **100** and the second thumbnail image **200** and includes a boundary **302** and a runtime indicium **304**. At least a portion of an initial video frame **310** of the third digital video is displayed within the boundary **302** of the second thumbnail image **300**. The runtime indicium **304** of the third thumbnail image **300** differs from the runtime indicium **104** and the runtime indicium **204** in that the runtime indicium **304** indicates that the third digital video is three (3) minutes and thirty (30) seconds long.

Each of the first thumbnail image **100**, the second thumbnail image **200**, and the third thumbnail image **300** are user-selectable, such that responsive to a selection of the first thumbnail image **100** (e.g., by tapping or clicking within the boundary **102** of the first thumbnail image **100**), the initial video frame **110** of the first digital video is displayed on the video display device **22**. In this manner, a user can select one of the first digital video, second digital video, and the third digital video to be displayed on the video display device **22** by selecting one of the first thumbnail image **100**, the second thumbnail image **200**, or the third thumbnail image **300**, respectively.

Referring to FIG. 2B, responsive to a user selection of the first thumbnail image **100** (FIG. 2A), the initial video frame **110** of the first digital video is displayed on the video display device **22**. In addition to the initial video frame **110**, a user-selectable navigation element **402**, a current time indicium **404**, a video indicium **406**, a playback control element **410**, preview frames **412**, a playback slider element **414**, a location tag element **420**, a date tag element **430**, a person tag element **440**, and an event tag element **460** are displayed on the video display device **22**. The runtime indicium **104** (FIG. 2B) indicating the total length of the first digital video is also displayed adjacent to the current time indicium **404**, which indicates the time within the video that is associated with the displayed video frame (in this example, the initial video frame **110** of the first digital video). As described above, the initial video frame **110** of the first digital video is associated with the initial time t_0 of the first digital video. Thus, in the example shown in FIG. 2B, the current time indicium **404** indicates that the current time within the first digital video is zero (0) seconds. The video indicium **406** is also displayed to provide an indication of which of the digital videos is being displayed on the video display device **22**. As shown in FIG. 2A, there are three digital videos in the library, thus, the video indicium **406** indicates that the first digital video of three total digital videos is being displayed. Alternatively, the video indicium **406** can be a file or video name associated with the first digital video (e.g., "video #1").

The navigation element **402**, the playback control element **410**, the playback slider element **414**, the location tag element **420**, a date tag element **430**, the person tag element

440, and the event tag element **460** displayed on the video display device **22** are user-selectable (e.g., by clicking or tapping). Selecting the navigation element **402** causes the video display device **22** to revert to the previous display, such that the user can use the navigation element **402** to navigate from what is shown in FIG. 2B back to what is shown in FIG. 2A (e.g., to select a different digital video for playback). As shown in FIG. 2B when the first digital video is not playing, the playback control element **410** is a play symbol (e.g., a generally triangular shape). Selecting the playback control element **410** causes the first digital video to begin playing on the video display device **22**. That is, selecting the playback control element **410** causes each of the subsequent video frames of the first digital video to be displayed on the video display device **22**. Alternatively, in some implementations, the playback of the first digital video begins automatically responsive to a user selection of the first thumbnail image **100** (FIG. 2A). The playback slider **414** is overlaid on the preview frames **412** of the first digital video. The preview frames **412** include at least a portion of the next, successive video frames following the current video frame that is displayed on the video display device **22**. In this example, the preview frames **412** include three video frames: the initial video frame **110** (the current video frame displayed on the video display device), the next video frame following the initial video frame, and the next video frame after that. The playback slider **414** is overlaid on the preview frames **412** and more specifically, on the initial video frame **110** because the initial video frame **110** is displayed on the video display device. By sliding the playback slider **414** (e.g., by tapping or clicking and holding), a user can navigate through the various video frames of the first digital video to find a particular video frame or time within the first digital video.

Referring to FIG. 2C, responsive to a user selection of the playback control element **410**, the first digital video begins to play on the video display device **22** such that the first digital video is advanced from the initial video frame **110** at the initial time t_0 to a first video frame **120** at a first time t_1 that is subsequent to the initial time t_0 . As described above, in some implementations, selecting the first thumbnail image **100** (FIG. 2A) automatically begins playback of the first digital video, in which case playback will proceed to FIG. 2C without requiring the user to select the playback control element **410** (FIG. 2B). As shown, when the first digital video advances to the first video frame **120** (which is subsequent to the initial video frame **110**), the current time indicium **404** is updated to display the first time t_1 , which in this example is one (1) second. As shown in this example, a building **122** is included within the first video frame **120**.

When the building **122** is viewed by a user, the user may desire to associate the first digital video with a location. To do so, the user can pause playback of the first digital video using the playback control element **410** (which is now displayed as a pause symbol) and select (e.g., by clicking or tapping) the location tag element **420**. Referring to FIG. 2D, selecting the location tag element **420** causes a first location tag **422**, a second location tag **424**, and a custom location tag generator **426** to be displayed on the video display device **22**. In this example, the first location tag **422** is associated with a "home" location (e.g., the home of the user) and the second location tag **424** is associated with a "work" location (e.g., the workplace of the user). If the user desires to associate the first digital video with the home location (e.g., based on the building **122** in the first video frame **120**), the user can select (e.g., by clicking or tapping) the first location tag **422**, thereby associating the first digital video with the

first location tag **422**. Likewise, if the user desires to associate the first digital video with the work location (e.g., based on the building **122** in the first video frame **120**), the user can select the second location tag **424**, thereby associating the first digital video with the second location tag **424**.

If the user desires to associate the first digital video with a location other than those associated with the first location tag **422** or the second location tag **424**, the user can select the custom location tag generator **426**, which prompts the user to input the name of the location via the user input device **24** (in this example, a touchscreen keyboard displayed on the video display device **22**), generating a third location tag. In this manner, the user can create one or more custom location tags and associate digital videos with one or more of these locations. This may be especially desirable if the metadata of the digital video does not contain location data indicative of the geographic location where the digital video was generated (e.g., such that a location tag for the digital video cannot be automatically generated, as described in further detail herein). Once created, the third location tag generated by the user will be displayed along with the first location tag **422** and the second location tag **424** the next time that the user selects the location tag element **420** (e.g., when tagging another digital video). Additionally, a search bar **428** and a navigation element **429** are displayed on the video display device **22**. Responsive to a selection of the search bar **428** (e.g., by clicking or tapping the search bar **428**), a user can input search criteria via the user input device **24** (in this example, the touchscreen keyboard) to search for one or more location tags to then be selected (e.g., rather than scrolling through a long list of location tags). Responsive to a selection of the navigation element **429** (e.g., by clicking or tapping the navigation element **429**), the user is returned to the previous display (in this example, what is shown in FIG. 2C).

While only the first location tag **422** and the second location tag **424** are displayed on the video display device **22** in FIG. 2D responsive to a selection of the location tag element **420** (FIG. 2C), more generally, any suitable number of location tags can be displayed on the video display device (e.g., four location tags, ten location tags, twenty location tags, one-hundred location tags, etc.) either simultaneously or in a manner that permits a user to scroll through each of the various location tags. Further, the location tags can include alphanumeric text indicative of one or more types of location information, such as, for example, a street address, a town or city name, a county name, a country name, a landmark name, a business name, or any combination thereof.

As described above, the digital video may have been converted from an older film (e.g., VHS or 8 mm film) and thus contain video segments that were generated on different dates. A user can manually tag the digital video with a plurality of location tags (e.g., two, five, ten, twenty, etc.) in the same or similar manner as described above to associate the digital video with those locations. Thus, as described in further detail herein, a user-selectable thumbnail image will be generated for each of the plurality of location tags for the digital video.

The user may also desire to associate the first digital video with the date on which it was generated. To do so, the user can select the date tag element **430** (FIG. 2C), which causes an exact date **432**, an approximate date **434**, and a date tag **436** to be displayed on the video display device **22**, as shown in FIG. 2E. The exact date **432** indicates the actual, exact date when the first digital video was generated based on the metadata of the first digital video. If the user desires to

associate the first digital video with the exact date **432**, the user can select the date tag **436** (e.g., by clicking or tapping the date tag **436**), which causes the first digital video to be associated with the exact date **432** and also automatically returns the user to the previous display (FIG. 2C).

In some cases, the metadata of the first digital video does not include data indicative of the date when the first digital video was generated. For example, if the first digital video was not generated on the user device **10** and was instead imported from another source, the metadata may not contain data indicative of the date that it was generated. In particular, this may occur if the first digital video was converted to a digital format from some other format (e.g., historical video footage, a camcorder tape, a VHS tape, 8 mm film, etc.) In this scenario, a user can input the approximate date **434** based on the content of the first digital video (e.g., the user recognizes the building **122** shown in the first video frame **120** and approximates the date) using the user input device **24**. In this example, the user input device **24** includes slidable month, date, and year inputs. Once the user has input the approximate date **434** and desires the first digital video to be associated with that approximate date **434**, the user selects the date tag **436** (e.g., by clicking or tapping the date tag **436**), which causes the first digital video to be associated with the approximate date **434** and also returns the user to the previous display (in this example, what is shown in FIG. 2C). Moreover, the user can associate the digital video with a plurality of date tags (e.g., two, five, ten, twenty, etc.) in the same or similar manner described above. This may be advantageous when the digital video is converted from an older film (e.g., VHS or 8 mm film) and contains a plurality of video segments that were generated on different dates.

Referring now to FIG. 2F, as the first digital video continues to play (e.g., subsequent to the assignment of the location tag and/or date tag described above), a second video frame **130** associated with a second time t_2 of the first digital video is displayed on the video display device **22**. In this example, the second time t_2 is twenty-five (25) seconds, which is indicated on the video display device **22** via the current time indicium **404**. The second video frame **130** includes a person **132**. Upon identifying the person **132** in the second video frame **130**, a user can associate the appearance of the person **132** at time t_2 in the video with a person tag by selecting the person tag element **440** (e.g., by clicking or tapping the person tag element **440** via the user input device **24**). To do so, playback of the first digital video on the video display device **22** can be stopped by the user via the playback control element **410** (e.g., clicking or tapping the pause symbol), or automatically responsive to the user selecting the person tag element **440**.

As shown in FIG. 2G, in some implementations, responsive to the selection of the person tag element **440**, playback of the first digital video is paused and a movable region of interest **442** is displayed on the video display device **22**. More specifically, the movable region of interest **442** is overlaid on the second video frame **130**. The user can adjust the size and position of the region of interest **442** via the user input device **24** (e.g., by clicking and dragging the region of interest **442**, tapping and holding the region of interest **442**, using a multi-touch gesture on a touchscreen to resize the region of interest **442**, etc.) For example, as shown, the user can size and position the region of interest **442** over a face **134** of the person **132**. In some implementations, the second video frame **130** can be automatically analyzed (as described further herein) to identify the face **134** of the person **132**, and the region of interest **442** is automatically positioned on the

face 134. While the region of interest 442 is shown as having a square shape, the region of interest 442 more generally can have any suitable shape, such as, for example, a rectangular shape, a circular shape, an oval shape, a triangular shape, a polygonal shape, etc. Moreover, in other implementations, the contours of the region of interest 442 can be drawn by the user (e.g., using a touchscreen). A navigation element 443 is also displayed on the video display device 22, which a user can select to finalize the size and position of the region of interest 442.

Referring to FIG. 2H, responsive to selecting the size and position of the movable region of interest 442 and selecting the navigation element 443, a first person tag 444, a second person tag 446, a custom person tag generator 448, and a search bar 449 are displayed on the video display device 22. In this example, the first person tag 444 is associated with the user and the second person tag 446 is associated with a first person (a person other than the user, such as a friend, family member, etc.) If the user desires to associate the selected region of interest 442 (FIG. 2G) with the user (e.g., the user is the person 132 in the video), the user can select the first person tag 444 (e.g., by clicking or tapping the first person tag 444) to associate the selected region of interest 442 of the second video frame 130 with the first person tag 444, and thus the user. Likewise, if the user desires to associate the selected region of interest 442 (FIG. 2G) with the first person (someone other than the user), the user can select the second person tag 446 (e.g., by clicking or tapping the second person tag 446) to associate the selected region of interest 442 of the second video frame 130 with the second person tag 446 and thus the user. While only the first person tag 444 and the second person tag 446 are displayed on the video display device 22 in FIG. 2G, any suitable number of person tags can be displayed on the video display device 22 (e.g., a user can scroll up and down such that different person tags are displayed). In some implementations, additional person tags can be automatically populated from, for example, a contact list of the user (e.g., stored on the user device 10) and displayed on the video display device 22.

If the user desires to associate the movable region of interest 442 with a person other than those associated with the first person tag 444 or the second person tag 446, the user can generate a customized third person tag (not shown) associated with that person by selecting the custom person tag generator 448, which prompts the user to input the name of the person via the user input device 24 (in this example, a touchscreen keyboard displayed on the video display device 22). Responsive to this input, the movable region of interest 442 will then be associated with the third person tag. The generated third person tag will then be subsequently displayed with the first person tag 444 and the second person tag 446 the next time that the user selects the person tag element 440 (e.g., when tagging another digital video). Additionally, a search bar 449 is displayed on the video display device 22. Responsive to a selection of the search bar 449, the user can input search criteria (e.g., a person's first and/or last name) via the user input device (in this example, the touchscreen keyboard) to search for a person tag.

In some implementations, there may be multiple people in the second video frame 130. In such implementations, the user can associate the second video frame 130 of the first digital video with some or all of the people that are in the second video frame 130. For example, if a second person (not shown) is next to the person 132 (FIG. 2F), the user can associate the second video frame 130 with the second person

as described above by selecting the person tag element 440 and selecting, for example, the second person tag 446 (FIG. 2H) as described above. Once the person 132 is associated with the user, the user can then associate the second person (not shown) with the first person by selecting the person tag element 440 (FIG. 2F), thereby causing the movable region of interest 442 to be displayed, moving the movable region of interest 442 onto the face of the second person and selecting navigation element 443 (FIG. 2G), and selecting the second person tag 446 (FIG. 2H). In this manner, the user can associate a video frame of the first digital video with multiple people (e.g., three people, five people, ten people, twenty people, etc.)

In some implementations, rather than only associating the second video frame 130 with a person tag (e.g., the first person tag 444), the user can associate a group of video frames with the person tag. For example, if the user identifies the person 132 in the second video frame 130, the user can select the person tag element 440 and associate the first person tag 444 to the second video frame 130 as described herein. The user can then continue to view the first digital video, proceeding through video frames subsequent to the second video frame 130, until the person 132 is no longer in the video (e.g., the person 132 exits the field of view at a tenth video frame (not shown) of the first digital video). In such implementations, the user can then select the person tag element 440 at the tenth video frame, thereby associating multiple video frames with the first person tag 444 (e.g., the second video frame through the ninth video frame). As described in further detail herein, assigning a person tag to a particular video frame causes a thumbnail image associated with the person tag to be generated that when selected causes the digital video to be played starting at the video frame associated with the particular video frame. When multiple, sequential video frames within a digital video are associated with the person tag as described above, thereby constituting a video clip, a thumbnail image associated with the first digital video is generated that when displayed on the video display device 22 and selected by a user, causes the video clip to be played on the video display device 22.

In some implementations, selecting the person tag element 440 (FIG. 2F) does not cause the movable region of interest 442 (FIG. 2G) to be displayed on the video display device 22. Instead, in such implementations, selecting the person tag element 440 (FIG. 2F) causes the first person tag 444, the second person tag 446, and the custom person tag generator 448 to be displayed on the video display device 22, as shown in FIG. 2H. In such implementations, the entirety of the second video frame 130 is associated with the selected person tag (e.g., the first person tag 444), rather than just the portion of the second video frame 130 within the moveable region of interest 442 (FIG. 2G).

Referring back to FIG. 2F, in addition to, or in the alternative of, selecting the person tag element 440 to associate the second video frame 130 of the first digital video with a person tag, the user can select the event tag element 450 to associate the second video frame 130 of the first digital video with an event tag. Referring now to FIG. 2I, responsive to selecting the event tag element 450, a first event tag 452, a second event tag 454, a custom event tag generator 456, and a search bar 458 are displayed on the video display device 22. Generally, the event tag can be associated with any event, such as, for example, a milestone (e.g., a child's first steps, a graduation, an anniversary, a birthday, etc.), a holiday (e.g., Christmas, Hanukkah, New Years, Halloween, Thanksgiving, etc.), a sporting event, a performance event (e.g., a play, a movie, etc.), or any

combination thereof. In the example shown in FIG. 2I, the first event tag **452** contains alphanumeric text indicative of New Year's **2017**, a holiday event. The second event tag **454** includes alphanumeric text indicative of a milestone event, which in this example, is a child's first steps. For example, if the user sees that the person **132** in the second video frame **130** is wearing a "Happy New Year 2017" hat, the user can select the first event tag **452** to associate the first digital video with that particular event. Likewise, in another example of event tagging, if the person **132** in the second video frame **130** is a child and the user sees that the child begins walking in the second video frame **130**, the user can select the second event tag **454** and associate the second video frame **130** the first digital video with that event. The user may, of course, wish to associate the second video frame **130** of the first digital video with an event other than those associated with the first event tag **452** and the second event tag **454**. To do so, the user can select the custom event tag generator **456**, which prompts the user to input the name of the event via the user input device **24** (in this example, a touchscreen keyboard). In this manner, a user can associate the first digital video with any type event based on the content of the first digital video.

Referring now to FIG. 3, a method **500** for organizing digital videos is described. The method **500** can be implemented, for example, using the system **1** (FIG. 1) described herein. More specifically, the flowchart can be implemented as a computer algorithm that instructs or causes the processor **12** of the user device **10** to perform the following functions according to non-transitory, machine-readable instructions stored in the memory device **14**. Alternatively, the flowchart can be implemented as a computer algorithm that instructs or causes the processor **32** of the remote device **30** to perform the following functions according to non-transitory, machine-readable instructions stored in the memory device **34**. Alternatively still, the flowchart can be implemented as a computer algorithm that instructs or causes both the processor **32** of the remote device **30** to perform the following functions according to non-transitory, machine-readable instructions stored in the memory device **34** and the processor **12** of the user device **10** to perform the following functions according to non-transitory, machine-readable instructions stored in the memory device **14**.

First step **501** of the method **500** includes selecting a digital video stored in the video repository **16** of the user device **10** or the video repository **36** of the remote device **30**. For example, as described herein and shown in FIG. 2A, the first thumbnail image **100**, the second thumbnail image **200**, and the third thumbnail image **300** can be displayed on the video display device **22**. Selecting the first thumbnail image **100** (e.g., by clicking or tapping) causes the initial video frame **110** of the first digital video to be displayed on the video display device **22**, as shown in FIG. 2B.

Alternatively, rather than receiving a user selection of a digital video, first step **501** can include receiving an automatic selection of a digital video. As described in further detail herein, each of the digital videos stored in the video repository **16** of the user device **10** and/or the video repository **36** of the remote device **30** can be automatically selected (e.g., in succession or randomly) such that the metadata and/or content data thereof can be automatically analyzed (e.g., during steps **502** and **503**).

Second step **502** of the method **500** includes analyzing the metadata of the selected digital video, and includes performing one or both of first sub-step **502a** and second sub-step **502b**. First sub-step **502a** includes associating an automatically-generated location tag with the selected digital video.

As described herein, the metadata of each digital video can include location data indicative of a location where the digital video was generated (e.g., location data generated by the GPS module **20** of the user device **10**). First sub-step **502a** includes comparing the location data of the selected digital video (e.g., GPS coordinates) to, for example, a lookup table of locations (e.g., from a map) to associate the selected digital video with an automatically-generated location tag. Alternatively, the first sub-step **502a** includes comparing the location data of the selected digital video (e.g., GPS coordinates) to, for example, location data associated with user-generated location tags (e.g., the first location tag **422** and the second location tag **424** of FIG. 2D). That is, if the user has previously associated another digital video with a user-generated location tag (e.g., the first location tag **422** of FIG. 2D), first sub-step **502a** includes comparing the location data of the selected digital video to the location data associated with user-generated location tags. If the location data (e.g., GPS coordinates) of the selected digital video corresponds to location data associated with a user-generated location tag, the selected digital video is automatically associated with the user-generated location tag. In this manner, once a user-generated location tag is associated with one digital video, all subsequently analyzed digital videos with location data corresponding to that location can be automatically associated with the same user-generated location tag. If the metadata of the selected first digital video does not contain location data, first sub-step **502a** of second step **502** is not performed, however, a user-generated location tag can be associated with the first digital video (e.g., in step **505** of the method **500**).

Second sub-step **502b** of second step **502** of the method **500** includes associating an automatically-generated date tag with the selected digital video. As described herein, the metadata of each digital video can include date and time data indicative of a date and/or time that the digital video was generated. Second sub-step **502a** includes analyzing the date and time data within the metadata of the selected digital video to automatically generate a date tag that is associated with the date and time that the selected digital video was generated. The automatically-generated date tag is then associated with the selected digital video. If the metadata of the selected digital video does not include date and time data, then the second sub-step **502b** is not performed, however, a user-generated date tag can be associated with the selected digital video during fifth step **505** of the method **500**.

Third step **503** of the method **500** includes analyzing the content data of the selected digital video, and includes first sub-step **503a**. First sub-step **503a** includes associating an automatically-generated person tag with the selected digital video. As described herein, the content data of each digital video includes a series of video frames (e.g., an initial video frame, a final video frame, and a plurality of video frames therebetween). As also described herein, there may be one or more persons in one or more of the video frames of the selected digital video (e.g., the person **132** shown in the second video frame **130** of FIG. 2F). First sub-step **503a** includes analyzing the video frames of the selected digital video to identify one or more persons in a video frame and associate that video frame with an automatically-generated person tag. For example, the first sub-step **503** includes detecting a face of a person in a video frame and comparing the detected face of the person to a facial recognition database (e.g., that is stored in the memory device **14** of the user device **10** and/or the memory device **34** of the remote device **30** shown in FIG. 1) to identify a name of the person.

A person tag that is associated with the identified name of the person is then automatically generated and associated with the video frame in which the person was identified.

As one example, the initial video frame of the selected digital video is analyzed during first sub-step **503a** to identify the face of a person. If no face is detected in the initial video frame, the analysis proceeds to the subsequent video frame to identify a face of a person. This process continues until a face of a person is identified in, for example, a second video frame of the selected digital video. Once a face is identified in the second video frame, the portion of the second video frame containing the face is compared to images in a facial recognition database to find a match (e.g., the face in the second video frame is a 100% match with a face in the facial recognition database, a 95% match with a face in the facial recognition database, an 85% match with a face in the facial recognition database, etc.) Once the face in the second video frame is matched with a face in the facial recognition database, the name of the person is identified and a person tag associated with the identified name is automatically generated and associated with the second video frame of the selected digital video.

In some implementations, the third step **503** also includes second sub-step **503b**, which includes associating an automatically-generated object tag with the selected digital video. The automatically-generated object tag is similar to the automatically-generated person tag described herein, but differs in that instead of associating a video frame of the selected digital video with a person, the video frame is associated with an object. Various objects (e.g., animals, trees, food, clothing, cars, buildings, etc.) can be detected in the video frames of the selected digital video in the same or similar manner faces are detected during first sub-step **503b** (e.g., by comparing at least a portion of the video frame to a database or look-up table of objects).

Fourth step **504** of the method **500** includes receiving one or more user-generated tags via the user input device **24** of the user device **10** (FIG. 1). As described herein, responsive to the selection of a digital video during step **501** (e.g., selecting the first thumbnail image **100** associated with the first digital video), the location tag element **420**, the date tag element **430**, the person tag element **440**, and the event tag **450** are displayed on the video display device **22** (see, e.g., FIG. 2B). Thus, user-generated tags can be a user-generated location data, a user-generated date tag, a user-generated person tag, a user-generated event tag, or any combination thereof. For one example, as described above, the user can select the person tag element **440** and associate the second video frame **130** of the first digital video with the first person tag **444** (see FIGS. 2G and 2H). While not shown, in some implementations, an object tag element is also displayed on the video display device **22**, such that the system **1** can receive a user-generated object tag in the same or similar manner as the user-generated person tags described herein.

Fifth step **505** of the method **500** includes generating thumbnail images associated with the user-generated tags, the automatically-generated location tag, the automatically-generated date tag, the automatically-generated content tag(s), or any combination thereof, for the selected digital video. For example, referring to FIG. 3B, if the user selects the first digital video by selecting the first thumbnail image **100** (FIG. 2B) during step **501** and assigns the first person tag **444** (FIGS. 2G and 2H) to the second video frame **130** of the first digital video during step **504**, a fourth thumbnail image **540** associated with the first digital video is displayed along with the first thumbnail image **100** associated with the first digital video, the second thumbnail image **200** associ-

ated with the second digital video, and the third thumbnail image **300** associated with the third digital video. As shown, the fourth thumbnail image **540** includes the movable region of interest **442** (FIG. 2G), which includes the face **134** of the person **132** that was selected by the user when assigning the person tag to the second video frame **130** of the first digital video.

The fourth thumbnail image **540** is similar to the first thumbnail image **100** in that selecting the fourth thumbnail image **540** (e.g., by clicking or tapping) causes the first digital video to be displayed on the video display device **22**. However, a selection of the fourth thumbnail image **540** differs a selection of the first thumbnail image **100** (as shown in FIG. 2B) in that selecting the fourth thumbnail image **540** causes the first digital video to be played on the video display device **22** starting at the second video frame **130** associated with time t_2 (in this example, 25 seconds) (FIG. 2F) rather than the initial video frame **110** associated with the initial time t_0 (FIG. 2B). As shown, the fourth thumbnail image **540** includes the runtime indicium **104** (in this example, one minute) and the current time indicium **404** associated with the second video frame **130** of the first digital video. While the fourth thumbnail image **540** is shown as including the movable region of interest **442** which includes the face **134** of the person **132**, in some implementations, the fourth thumbnail image **540** includes the entire second video frame **130** rather than just the movable region of interest **442**.

Additional thumbnail images can be generated in the same or similar manner as the automatically-generated and user-generated tags described herein. For example, if a user-generated event tag is received during step **504** that is associated with a tenth video frame of the first digital video that occurs at time t_3 of the first digital video, a fifth thumbnail image (not shown) is generated that is associated with the first digital video. Selecting the fifth thumbnail image causes the first digital video to be played on the video display device **22** starting at time t_3 of the first digital video. Generating a plurality of thumbnail images for each of the digital videos during step **505** in this manner allows a user to organize the digital videos according to the associated tags. For example, the user can filter the thumbnail images displayed on the video display device **22** by selecting the first person tag **444**. In this example, only thumbnail images that are associated with the first person tag **444** will be displayed on the video display device **22**, and selecting one of these thumbnail images associated with the first person tag **444** will cause a digital video to be displayed on the video display device **22** starting at a video frame containing the person **132** that is associated with the first person tag **444**.

Steps **501-505** of the method **500** can be repeated one or more times for any number of digital videos that are stored in the video repository **16** of the user device **10** and/or the video repository **36** of the remote device **30** (e.g., two digital videos, ten digital videos, one-hundred digital videos, etc.) While assignment of various location, date/time, person, and event tags has been described herein in connection with certain video frames of a digital video, it should be understood that these various tags can be assigned at any video frame within a digital video, including the initial video frame and/or the final video frame. Thus, each digital video stored in the video repository **16** of the user device **10** and/or the video repository **36** of the remote device **30** can be associated with any number of different types of tags at one or more times within the digital video (e.g., a first digital video is associated with an automatically-generated location

tag, an automatically-generated date tag, and a user-generated person tag, and a second digital video is associated with an automatically-generated date tag and a user-generated event tag).

The video tagging systems and methods described herein (e.g., system **1** and method **500**) allows users to more efficiently and accurately retrieve digital videos associated with different types of information (e.g., location tags, date tags, people tags, event tags, etc.) As described herein, associating digital videos with automatically-generated and/or user-generated tags causes user-selectable thumbnail images to be generated and displayed on a video display device. Thus, rather than selecting a digital video and having to wait or fast-forward to a desired time, a user can simply search for the corresponding thumbnail image, select that thumbnail image, and the digital video will begin playing at the desired time.

Digital Photograph Linking

A physical photograph has two sides: a first side where the image is printed and a second, opposing side that is typically blank. Often, people desire to link the physical photograph with one or more details, such as, for example, the location where the photograph was taken, the date the photograph was taken, the people depicted in the photograph, the event depicted in the photograph, etc. To do so, people often write these details on the second (blank) side of the physical photograph so that a person can simply flip the physical photograph over to quickly access this linked information.

With the evolution of digital photography and personal electronic devices (e.g., smartphones, tablets, laptop computers, desktop computers, etc.), people often have a voluminous library of digital photographs. A user may desire to digitally link a first digital photograph and a second digital photograph such that when one is displayed, the user can quickly access the other without browsing through the library of photos, much like how one can flip a physical photograph to see the other side. Further, a user may desire to scan a physical photograph to create a digital version, and link a scanned image of the first side with a scanned image of the second side so that the writing on the back of the physical photograph stays linked with the image on the other side of the physical photograph.

Referring to FIG. **4**, a system **1000** for linking digital photographs includes a user device **1100**, a remote device **1200**, and a scanner **1300**. Generally, the system **1000** is used to store and organize digital photographs and implement the methods described herein. For example, the system **1000** can be used to digitally link a first digital photograph to a second digital photograph such that a user can digitally flip the first digital photograph to immediately view the second digital photograph. In another example, the system **1000** can be used to scan both sides of a physical photograph, creating two digital photographs (one for the first side and one for the second side), and digitally link the two digital photographs such that a user can digitally flip between the digital photographs in the same or similar manner as the physical photograph.

The user device **1100** includes one or more processors **1102** (hereinafter, "processor"), one or more memory devices **1104** (hereinafter, "memory device"), a camera **1108**, a video display device **1110**, a user input device **1112**, and a communication module **1114**. The processor **1102** is communicatively coupled to the memory device **1104**, the camera **1108**, the video display device **1110**, the user input device **1112**, and the communication module **1114** and is generally used to control the operation of these various components of the system **1000** and implement the methods

described herein. The processor **1102** can be a general or special purpose processor or microprocessor. The user device **1100** can include any suitable number of processors (e.g., one processor, two processors, four processors, ten processors, etc.)

The memory device **1104** is generally used to store machine readable instructions that are executable by the processor **1102**. The memory device **1104** can be any suitable computer readable storage device or media, such as, for example, a random or serial access memory device, a hard disk drive, a solid state drive, a flash memory device, etc. As shown, the memory device **1104** includes a digital file repository **1106**, which contains one or more digital photos (e.g., 2 digital photos, 100 digital photos, 100,000 digital photos, 1,000,000, digital photos, etc.) As described in further detail herein, each of the digital files includes image data reproducible as an image (e.g., a still image) and metadata. The metadata each digital file stored in the digital file repository **1106** can include location data indicative of a geographic location where the image of the digital file was generated and/or the date and time data associated with the date and/or time when the image of the digital file was generated.

The digital camera **1108** is generally configured to generate image data reproducible as one or more digital images, including still images, video images, or both. Thus, the digital camera **1108** can be used to generate the images of the digital files that are stored in the digital file repository **1106** of the memory device **1104**. The digital camera **1108** can optionally include optical and/or digital zoom features, a light to aid in generated digital photos and videos, filters, or any combination thereof. While the user device **1100** is shown as including one digital camera **1088**, the user device **1100** can include a plurality of digital cameras (e.g., two digital cameras, three digital cameras, etc.) For example, the user device **1100** can include a first front-facing digital camera and an opposing, second rear-facing digital camera.

The video display device **1110** is a human-machine interface (HMI) including a graphical user interface (GUI) that can display images (e.g., still images, video images, etc.) As described in further detail herein, the video display device **1110** of the user device **1100** can be used to display images of the digital files that are stored in the digital file repository **1106** of the memory device **1104**. The video display device **1110** can be, for example, a general or special purpose desktop computer, a laptop, a tablet computer, a smartphone, a display monitor, a television, LED display, LCD display, or the like, or any combination thereof. The user input device **1112** is configured to sense inputs made by a human user interacting with the user device **1100** and can be, for example, a touchscreen or touch-sent via substrate, a mouse, a keyboard, or any combination thereof. For example, as described herein, the user input device **1112** can receive input(s) from a human user that controls what is displayed on the video display device **1110**. In some implementations, the user input device **1112** is integrated within the video display device **1110** (e.g., the user input device **1112** and the video display device **1110** are a touchscreen display of a smartphone).

The communication module **1114** is configured for wireless communication (e.g., via a cellular network) with the remote device **1200**. As described in further detail herein, the communication module **1114** can be used to transmit data stored in the digital file repository **1106** of the memory device **1104** of the user device **1100** to the remote device **1200** for processing, and/or transmit data stored in the video/digital file repository **1206** of the memory device **1204**

of the remote device **1200** to be displayed or played on the video display device **1110** of the user device **1100**.

Generally, the user device **1100** can be, for example, a general or special purpose desktop computer, a laptop computer, a tablet computer, or a smartphone, with all or some of the components contained therein. In some implementations, the user device **1100** is a smartphone containing each of the processor **1102**, memory device **1104**, camera **1108**, video display device **1110**, user input device **1112**, and the communication module **1114** within a housing. While the user device **1100** is shown in FIG. 4 as including all of the components described herein, more or fewer components can be included in a user device. For example, an alternative user device (not shown) includes the processor **1102**, the memory device **1104**, the video display device **1110**, the user input device **1112**, and the communication module **1114**. Thus, various user devices can be formed using any portion of the components described herein.

The remote device **1200** includes one or more processors (hereinafter, “processor”) **1202**, one or more memory devices (hereinafter, “memory device”) **1204**, and a communication module **1208**. The processor **1202** is the same as, or similar to, the processor **1102** of the user device **1100** and is communicatively coupled to the memory device **1204** and the communication module **1208**. The memory device **1204** is the same as or similar to the memory device **1104** of the user device **1100** and includes a digital file repository **1206** that is the same as, or similar to, the digital file repository **1106** of the user device **1100**. The communication module **1208** of the remote device **1200** is configured to wirelessly communicate with the communication module **1114** of the user device **1100** (e.g., via a cellular network, WiFi, or the like). For example, the remote device **1200** can receive data from the digital file repository **1106** of the user device **1100** via the communication module **1208** and store the data in the video/photo repository **1206** (e.g., such that all of the data stored in the digital file repository **1106** of the user device **1100** is stored in the video/photo repository **1206**). In some implementations, the remote device **1200** is a remote server that communicates with the user device **1100** via the Internet (e.g., via a cellular network).

While the system **1** is shown in FIG. 1 as including one user device **1100**, in some implementations, the remote device **1200** can be communicatively coupled to a plurality of user devices that are the same as, or similar to, the user device **1100** (e.g., two user devices, ten user devices, one hundred user devices, one thousand user devices, etc.) Thus, data from the digital file repository of each of a plurality of user devices can be transmitted and stored in the video/photo repository **1206** of the remote device **1200**.

The scanner **1300** of the system **1000** is generally used to scan physical photographs (e.g., a photograph printed on film or paper) and generates digital versions of the scanned physical photographs (digital photographs). The scanner **1300** can be a flatbed scanner, a hand-held scanner, a sheet-fed scanner, an optical scanner, or the like. As shown, the scanner **1300** is communicatively coupled to the communication module **1114** of the user device **1100** such that digital files generated by the scanner **1300** can be transmitted to and stored in the digital file repository **1106** of the memory device **1104** of the user device **1100**. In some implementations, the system **1000** does not include the scanner **1300**; instead, in such implementations, the camera **1108** of the user device **1100** can be used to scan photographs or images and generate digital photographs.

Referring to FIG. 5A, a first digital photograph **1410** is displayed on the video display device **1110**. The first digital

photograph **1410** is stored in the digital file repository **1106** of the user device **1100**, the digital photo repository **1206** of the remote device **1200**, or both. In this example, four people are pictured in the first digital photograph **1410**: a first person **1412**, a second person **1414**, a third person **1416**, and a fourth person **1418**.

As shown in FIG. 5A, a user-selectable information element **1430** and a user-selectable navigation element **1435** are also displayed on the video display device **1110** along with the first digital photograph **1410**. The user-selectable navigation element **1435** can be selected by a user (e.g., by tapping or clicking) to navigate away from the first digital photograph **1410** (e.g., such that the first digital photograph **1410** is no longer displayed on the video display device **1110**). The user-selectable information element **1430** can be selected by a user (e.g., by clicking or tapping) to permit the user, for example, to digitally link the first digital photograph **1410** with another digital photograph as described in further detail herein.

Referring to FIG. 5B, responsive to a user selection of the information element **1430** (FIG. 5A), a linking element **1433**, a location tag element **1434**, a likeness generator element **1436**, a people tag element **1438**, a date tag element **1440**, a save element **1442**, and a cancel element **1444** are displayed on the video display device **1110**, each of which are user-selectable (e.g., by clicking or tapping). In some implementations, a caption element (not shown) is also displayed which permits a user to input a caption for the first digital photograph **1410**. Selecting the location tag element **1434** permits a user to input (e.g., using a touchscreen keyboard) a location associated with the first digital photograph **1410** (e.g., a street address, a town or city name, a county name, a country name, a landmark name, a business name, or any combination thereof). Selecting the people tag element **1438** permits a user to input a name of a person that is depicted in the first digital photograph **1410**. In some implementations, an album tag element (not shown) is also displayed and permits a user to associate the first digital photograph **1410** with one or more albums of digital photographs (e.g., an album that is stored in the digital photograph repository **1106** of the user device **1100**, an album that is stored in the digital photograph repository **1206** of the remote device **1200**, or both).

Selecting the date tag element **1440** permits a user to input a date that will be associated with the first digital photograph **1410**. As described herein, in some implementations, the first digital photograph **1410** can be a scanned version of a physical photograph. In such implementations, the first digital photograph **1410** will be automatically associated with the date that the scan was generated (e.g., in this example, 1/1/19). However, the first digital photograph **1410** may have actually been generated on an earlier date (e.g., 12/25/18). Thus, a user can select the date tag element **1440** and update or correct the date tag for the first digital photograph **1410** (e.g., change the date tag from 1/1/19 (the scan date) to 12/25/2018 (the date the photo was taken)). Selecting the save element **1442** causes any inputs to the linking element **1433**, the location tag element **1434**, the likeness generator element **1436**, the people tag element **1438**, the date tag element **1440** to be saved and permanently associated with the first digital photograph **1410** and automatically causes the first digital photograph **1410** to be displayed on the video display device **1110** (FIG. 2A). Selecting the cancel element **1444** causes any inputs to the linking element **1433**, the location tag element **1434**, the likeness generator element **1436**, the people tag element **1438**, the date tag **1440** that were added subsequent to

selecting the information element **1430** (FIG. **5A**) to be deleted and automatically causes the first digital photograph **1410** to be displayed on the video display device **1110** (FIG. **2A**).

If the user desires to link the first digital photograph **1410** (FIG. **5A**) with another digital photograph, the user can select the linking element **1433**. As shown in FIG. **5C**, selecting the linking element **1433** causes a plurality of digital photographs to be displayed on the video display device **1110**. More specifically, thumbnail images of a second digital photograph **1450**, a third digital photograph **1452**, a fourth digital photograph **1454**, and a fifth digital photograph **1456** are displayed on the video display device **1110**. While only four digital photographs are illustrated in FIG. **5C**, more generally, any suitable number of digital photographs can be displayed, including, for example, an entire library or album of photographs (e.g., one digital photograph, fifty digital photographs, one-hundred digital photographs, etc.). In this manner, the user can choose to link the first digital photograph **1410** (FIG. **5A**) with any digital photograph that is stored in the digital file repository **1106** of the user device **1100** and/or digital photo repository **1206** of the remote device **1200**. In some implementations, rather than displaying an entire library or album of photographs, selecting linking element **1433** causes thumbnail images to be displayed for digital photographs associated with the same date as the first digital photograph **1410**. For example, as shown, each of the second digital photograph **1450**, the third digital photograph **1452**, the fourth digital photograph **1454**, and the fifth digital photograph **1456** are associated with the same date as the original date tag **1440** (FIG. **5B**) of the first digital photograph **1410** (e.g., in this example, 1/1/19). As described herein, a user may desire to scan both sides of a physical photograph and link the two scanned, digital versions together. Thus, only displaying thumbnails of photographs with the same date as the first digital photograph **1410** aids a user in quickly finding the second side of the physical photograph that was scanned on the same date/time as the first side of the physical photograph.

Each of these thumbnail images is user-selectable such a selection (e.g., by clicking or tapping) of the second digital photograph **1450** causes the first digital photograph **1410** (FIG. **5A**) to be linked with the second digital photograph **1450** (FIG. **5C**). Once the user makes a selection, the user can select the save element **1442**, which automatically navigates the user to the previous screen (FIG. **5B**), where the user can select the save element **1442** again to navigate to the previous screen (FIG. **5A**). Alternatively, in some implementations, selecting one of the digital photographs shown in FIG. **5C** (e.g., the second digital photograph **1450**) causes the system **1000** to automatically navigate to either FIG. **5B** or FIG. **5A**.

While the linking element **1433**, the location tag element **1434**, the likeness generator element **1436**, the people tag element **1438**, the date tag **1440**, the save element **1442**, and the cancel element **1444** are each shown as being displayed on the video display device **1110** in FIG. **5B**, more generally, any combination of these elements can be displayed on the video display device **1110** responsive to a user selection of the information element **1430** (FIG. **5A**). Alternatively, in some implementations, the linking element **1433** (FIG. **5B**) can be displayed along with the first digital photograph **1410** in addition to or instead of the user-selectable information element **1434** in FIG. **5A**.

Referring to FIG. **6A**, subsequent to linking the first digital photograph **1410** to the second digital photograph

1450 as described above, a user-selectable flipping element **1432** is displayed on the video display device **1110** along with the first digital photograph **1410**. The flipping element **1432** thus provides an indication to a user of the video display device **1110** that the first digital photograph **1410** that is displayed on the video display device **1110** is linked with another digital photograph. Generally, selecting (e.g., by clicking or tapping) the flipping element **1432** causes the first digital photograph **1410** to be digitally flipped such that the second digital photograph **1450** is displayed on the video display device **1110** and the first digital photograph **1410** is not displayed on the video display device **1110**. This digitally flipping is similar to physically flipping a physical photograph where a person can quickly flip between viewing a first side of a physical photograph and a second side of the same physical photograph.

As shown in FIGS. **6A-6F**, in some implementations, the digitally flipping includes rotating the first digital photograph **1410** about a vertical axis until the first digital photograph **1410** no longer is displayed on the video display device **1110** and the second digital photograph **1450** is displayed on the video display device **1110**. Flipping the first digital photograph **1410** about the vertical axis is similar to rotating a physical photograph about a vertical axis to turn from the first side to the second side (or vice versa). Starting with FIG. **6A**, selecting (e.g., by clicking or tapping) the flipping element **1432** initiates the digital flipping of the first digital photograph **1410**. As shown in FIG. **6B**, the first digital photograph **1410** begins to rotate about its vertical axis such that the left side of the first digital photograph **1410** appears to be turning towards the user of the video display device **1110** and the right side of the first digital photograph **1410** appears to be turning away from the user of the video display device **1110**. As shown in FIG. **6C**, as the digital flipping continues, the first digital photograph **1410** continues to rotate about its vertical axis. Eventually, the first digital photograph **1410** rotates until it is no longer displayed on the video display device **1110**. As shown in FIG. **6D**, the first digital photograph **1410** is not displayed on the video display device **1110** and instead, the second digital photograph **1450** is displayed on the video display device **1110**. The second digital photograph **1450** rotates about its vertical axis in the same way that the first digital photograph **1410** rotated such that the right side of the second digital photograph **1450** appears to be moving away from the user of the video display device **1110** and the left side of the second digital photograph **1450** appears to be moving toward the user of the video display device **1110**. As shown in FIG. **6E**, as the second digital photograph **1450** continues to rotate, the area that the second digital photograph **1450** takes up on the video display device **1110** increases. Finally, as shown in FIG. **6F**, upon completion of the digital flipping the second digital photograph **1450** is displayed on the video display device **1110**. As shown, the second digital photograph **1450** includes handwriting from the back of the same physical photograph that the first digital photograph **1410** was scanned from. Thus, the user can flip between the first digital photograph **1410** and the second digital photograph **1450** in the same or similar manner as the user can flip the physical photograph from which the first digital photograph **1410** and the second digital photograph **1450** were scanned. The digital flipping in FIGS. **6A-6F** can have a predetermined time (e.g., the time it takes to go from FIG. **6A** to FIG. **6F**). Generally, the predetermined time can be any suitable time (e.g., 0.01 seconds, 0.1 seconds, 1 second, 3 seconds, 10 seconds, 30 seconds, etc.)

When the second digital photograph **1450** is displayed on the video display device **1110** (FIG. **6F**), the user can again select the flipping element **1432** to digitally flip the second digital photograph **1450** in the same or similar manner as the first digital photograph **1410** such that the first digital photograph **1410** is displayed on the video display device **1110** (FIG. **6A**). The second digital photograph **1450** can be flipped in the same direction about its vertical that the first digital photograph was flipped in FIGS. **6A-6F** or in the opposite direction about its vertical axis. In other implementations, the first digital photograph **1410** and second digital photograph **1450** can be digitally flipped in other ways (e.g., other than flipping the photos about a vertical axis), as described herein (e.g., as shown in FIGS. **7A-7F** or FIGS. **8A-8E**).

Referring back to FIG. **5B**, a likeness generator element **1436** is also displayed on the video display device **1110**. Selecting (e.g., by clicking or tapping) the likeness generator element **1436** causes a second digital image **1460** to be generated including a likeness of each of the people pictured in the first digital photograph **1410**. As described above, the first digital photograph **1410** includes the first person **1412**, the second person **1414**, the third person **1416**, and the fourth person **1418**. As shown in FIG. **7A**, in some implementations, the first digital photograph **1410** also includes the legend **1420**, which includes the first person tag **1422**, the second person tag **1424**, the third person tag **1426**, and the fourth person tag **1428**, which correspond to the first person **1412**, the second person **1414**, the third person **1416**, and the fourth person **1418**, respectively. Referring to FIG. **7F**, the second digital image **1460** includes a first person likeness **1612**, a second person likeness **1614**, a third person likeness **1616**, and a fourth person likeness **1618**, each of which correspond to the first person **1412**, the second person **1414**, the third person **1416**, and the fourth person **1418**, shown in FIG. **7A**, respectively.

As evident by a comparison of FIG. **7A** to FIG. **7F**, the first person likeness **1612** in FIG. **7F** is an outline of the first person **1412** in FIG. **7A**. In other words, the first person likeness **1612** is only an outline (e.g., the outer contours) of the first person **1412** and does not include details such as colors, facial features, clothing details, or the like. Likewise, as shown by a comparison of FIG. **7A** to FIG. **7F**, the second person likeness **1614** in FIG. **7F** is an outline of the second person **1414** in FIG. **7A**, the third person likeness **1616** in FIG. **7F** is an outline of the third person **1416** in FIG. **7A**, and the fourth person likeness **1618** in FIG. **7F** is an outline of the fourth person **1418** in FIG. **7A**.

As shown in FIG. **7F**, a first person indicium **1622**, a second person indicium **1624**, a third person indicium **1626**, and a fourth person indicium **1628** are also displayed on the video display device **1110**. More specifically, the first person indicium **1622** is overlaid on the first person likeness **1612**, the second person indicium **1624** is overlaid on the second person likeness **1614**, the third person indicium **1626** is overlaid on the third person likeness **1616**, and the fourth person indicium **1628** is overlaid on the fourth person likeness **1618**. As shown, each of the first person indicium **1622**, the second person indicium **1624**, the third person indicium **1626**, and the fourth person indicium **1628** are overlaid where the face of the corresponding person would be (cf FIGS. **6A** and **6F**). Alternatively, the first person indicium **1622**, the second person indicium **1624**, the third person indicium **1626**, and/or the fourth person indicium **1628** can more generally be overlaid on any portion of the corresponding person likeness.

Additionally, each of the first person indicium **1622**, the second person indicium **1624**, the third person indicium **1626**, and the fourth person indicium **1628** are also displayed within the legend **1420**. As shown, the first person indicium **1622** is positioned directly adjacent to the first person tag **1422**, the second person indicium **1624** is positioned directly adjacent to the second person tag **1424**, the third person indicium **1626** is positioned directly adjacent to the third person tag **1426**, and the fourth person indicium **1628** is positioned directly adjacent to the fourth person tag **1428**. This positioning of the person indicia relative to the person tags causes a user viewing the video display device **1110** to intuitively associate the adjacent indicium and person tag. For example, the first person indicium **1622** is intuitively linked to the first person tag **1422**. Thus, the user can determine that the first person likeness **1612** on which the first person indicium **1622** is overlaid corresponds to the first person tag **1422**.

In this manner, the indicia **1622-1628** act as unique identifier from which a user can intuitively determine who each of the individuals depicted in the first digital photograph **1410** are. As described herein, the user can digitally flip between the second digital photograph **1450** (FIG. **7F**) and the first digital photograph **1410** (FIG. **7A**), and vice versa. While a user can determine which people are in the first digital photograph **1410** based on the person tags **1422-1428** in the legend **1420**, the user may not know which people in the first digital photograph **1410** correspond to which person tags **1422-1428** (e.g., because the user does not personally recognize the people in the first digital photograph **1410**). In this case, the user can digitally flip the first digital photograph **1410** as described herein to view the second digital image **1460** (FIG. **7F**). Given that the indicia **1622-1628** are overlaid on the likenesses **1612-1618** in the second digital image **1460** (FIG. **7F**), the user can then determine which person tags **1422-1428** in the legend **1420** correspond to which of the persons **1412-1418** in the first digital photograph **1410** (FIG. **7A**) by digitally flipping between them.

Thus, advantageously, the person tags **1422-1426** do not need to be overlaid on the first digital photograph **1410** (FIG. **7A**), which would obscure the first digital photograph **1410**, for the user to determine who each person is the first digital photograph **1410**. Instead, the person tags **1422-1426** are positioned in the legend **1420** below the first digital photograph **1410**. Because the second digital image **1460** (FIG. **7F**) only includes the likenesses **1612-1618**, overlaying the indicia **1622-1628** on the second digital image **1460** does not obscure the image as would be the case if these were overlaid on the first digital photograph **1410** (FIG. **7A**). Thus, the combination of the legend **1420** containing person tags **1422-1428** that is displayed below the first digital photograph **1410** (FIG. **7A**) and the second digital image **1460** (FIG. **7F**) and the indicia **1622-1628** (FIG. **7F**) allow the user more quickly and easily identify the people depicted in the first digital photograph **1410**.

While each of the first person indicium **1622**, the second person indicium **1624**, the third person indicium **1626**, and the fourth person indicium **1628** (FIG. **7F**) are shown as including alphanumeric text (in this example, the numbers 1, 2, 3, and 4), alternatively, the first person indicium **1622**, the second person indicium **1624**, the third person indicium **1626**, and/or the fourth person indicium **1628** can be different symbols or shapes (e.g., the first person indicium **1622** is a square and the second person indicium **1624** is a triangle) such that the user can intuitively link the likenesses

1612-1618 to the person tags 1422-1428, and ultimately the persons 1412-1418 in the first digital photograph 1410 (FIG. 7A).

A user can flip between the first digital photograph 1410 and the second digital image 1460 in the same or similar manner as between the first digital photograph 1410 and the second digital image 1460 (FIGS. 6A-6F). For example, referring to FIGS. 7A-7F, the first digital photograph 1410 can be flipped about a horizontal axis rather than the vertical axis (FIGS. 6A-6F). Starting with FIG. 7A, the user initiates digital flipping of the first digital photograph 1410 by selecting (e.g., by clicking or tapping) the flipping element 1432. As shown in FIG. 7B, the first digital photograph 1410 begins to rotate about its horizontal axis such that the top edge of the first digital photograph 1410 appears to be moving towards the user of the video display device 1110 and the bottom edge of the first digital photograph 1410 appears to be moving away from the user of the video display device 1110. As shown in FIG. 7C, as the digital flipping continues, the first digital photograph 1410 continues to rotate about its horizontal axis. Eventually, the first digital photograph 1410 rotates until it is no longer displayed on the video display device 1110. As shown in FIG. 7D, the first digital photograph 1410 is not displayed on the video display device 1110 and instead, the second digital image 1460 is displayed on the video display device 1110. The second digital image 1460 rotates about its horizontal axis in the same way that the first digital photograph 1410 rotated such that the top edge or portion of the second digital image 1460 appears to be towards the user of the video display device 1110 and the bottom edge or portion of the second digital image 1460 appears to be moving away from the user of the video display device 1110. As shown in FIG. 7E, as the second digital image 1460 continues to rotate, the area that the second digital image 1460 takes up on the video display device 1110 increases. Finally, as shown in FIG. 7F, upon completion of the digital flipping the second digital image 1460 is displayed on the video display device 1110. The digital flipping in FIGS. 7A-7F can have a predetermined time (e.g., the time it takes to go from FIG. 7A to FIG. 7F). Generally, the predetermined time can be any suitable time (e.g., 0.01 seconds, 0.1 seconds, 1 second, 3 seconds, 10 seconds, 30 seconds, etc.)

Referring to FIG. 8A-8D, the first digital photograph 1410 is displayed on the video display device 1110. Responsive to a selection of the flipping element 1432, as shown in FIG. 8B, the left side of the first digital photograph 1410 begins to peel back revealing a portion of the second digital image 1460 that is on the back of the first digital photograph 1410 (e.g., as if a user was turning/curling a physical photograph to see the back like turning the page of a book). As shown in FIGS. 8C and 8D, as the digital flipping continues, the left side of the first digital photograph 1410 continues to move towards the right such that a larger portion of the second digital image 1460 is displayed and of the first digital photograph 1410 is no longer displayed on the video display device 1110. The digital flipping in FIGS. 8A-8D can have a predetermined time (e.g., the time it takes to go from FIG. 8A to FIG. 8D). Generally, the predetermined time can be any suitable time (e.g., 0.01 seconds, 0.1 seconds, 1 second, 3 seconds, 10 seconds, 30 seconds, etc.) Further, while the left side of the first digital photograph 1410 is shown as being moved towards the right for the flip in FIGS. 8A-8D, more generally, the first digital photograph 1410 can be flipped in this manner in any direction (e.g., the top right corner moves towards the bottom left corner, the bottom right corner moves towards the top left corner, the left edge

moves towards the right edge, the right edge moves towards the left edge, the top edge moves towards the bottom edge, the bottom edge moves towards the top edge, etc.)

In some implementations, rather than be digitally flipped responsive to a selection of the flipping element 1432, a user can cause the first digital photograph 1410 to be digitally flipped by clicking or tapping on the first digital photograph 1410 and dragging in a desired direction. For example, a user can click or tap the first digital photograph 1410 at or near the left edge thereof and pull to the right, causing the first digital photograph 1410 to flip about its vertical axis in the same or similar manner as shown in FIGS. 6A-6E. As another example, the user can click or tap the first digital photograph 1410 at or near the top edge thereof and pull down, causing the first digital photograph 1410 to flip about its horizontal axis in the same or similar manner as shown in FIGS. 7A-7E. As yet another example, the user can click or tap the first digital photograph 1410 at or near the left side thereof and pull towards the right, causing the first digital photograph 1410 to flip over to the second digital image 1460 in the same or similar manner as shown in FIGS. 8A-D.

Referring to FIG. 9, a method 1500 for digitally linking digital photograph is described. The method 1500 can be implemented, for example, using the system 1000 (FIG. 4) described herein. More specifically, the flowchart can be implemented as a computer algorithm that instructs or causes the processor 1102 of the user device 1100 to perform the following functions according to non-transitory, machine-readable instructions stored in the memory device 1104. Alternatively, the flowchart can be implemented as a computer algorithm that instructs or causes the processor 1202 of the remote device 1200 to perform the following functions according to non-transitory, machine-readable instructions stored in the memory device 1204. Alternatively still, the flowchart can be implemented as a computer algorithm that instructs or causes both the processor 1202 of the remote device 1200 to perform the following functions according to non-transitory, machine-readable instructions stored in the memory device 1104.

Step 1501 of the method 1500 includes scanning a physical photograph using, for example, the scanner 1300 of the system 1000 (FIG. 4). As described herein, a physical photograph has two sides (e.g., a first side on which the image is printed and a second side including writing). Thus, the scanning in step 1501 can include scanning both sides of the physical photograph. Scanning allows each side of the physical photograph to be converted to a digital photograph that can be stored on the user device 1100 and/or the remote device 1200 (FIG. 4).

Step 1502 of the method 1500 includes storing one or more digital photographs in the file repository 1106 of the user device 1100, the photo repository 1206 of the remote device 1200, or both. Storing the digital photographs allows each digital photograph to be retrieved and displayed on the video display device 1110 of the user device 1100. Upon completion of step 501, the digital photographs generated by the scanner 1300 are received and stored in the digital file repository 1106 of the user device 1100, the photo repository 1206 of the remote device 1200, or both. In some implementations, the method 1500 does not include first step 1501. In such implementations, the digital photographs are not scanned versions of a physical photograph (e.g., the

digital photographs are digital photograph that were generated by the camera 1108 of the user device 1100 shown in FIG. 4).

Step 1503 of the method 1500 includes displaying a first digital photograph on the video display device (e.g., the first digital photograph 1410 described and illustrated herein). As shown in FIG. 5A, the user-selectable information element 1430 and the user-selectable navigation element 1435 are also displayed on the video display device 1110 along with the first digital photograph 1410.

Step 1504 of the method 1500 includes receiving a linking input indicative of a desire to link the first digital photograph with a second digital photograph. For example, step 1504 includes receiving a selection of the user-selectable information element 1430 shown in FIG. 5A, which causes the linking element 1433 to be displayed on the video display device 1110 as shown in FIG. 5B. Selecting the linking element 1433 causes a plurality of digital photographs to be displayed on the video display device 1110, including the second digital photograph 1450, as shown in FIG. 5C. If the user desires to link the first digital photograph 1410 (FIG. 5A) with the second digital photograph 1450 (FIG. 5C), the user selects the second digital photograph 1450.

Step 1505 of the method 1500 includes digitally linking the first digital photograph and the second digital photograph together. For example, step 1505 includes causing the first digital photograph 1410 to be digitally linked to the second digital photograph 1450. The linking during step 1505 also includes modifying the metadata of the first digital photograph to include information associated with the second digital photograph responsive to receiving a linking input (step 1504). As described herein, the each of the digital photographs includes metadata. Step 1508 includes modifying the metadata of the first digital photograph to include a name of the linked second digital photograph.

Step 1506 of the method 1500 includes displaying the first digital photograph and a flipping element on the video display device. For example, as shown in FIG. 6A, the first digital photograph 1410 and the flipping element 1432 are displayed on the video display device 1110 responsive to receiving the linking input indicative of a desire to link the first digital photograph 1410 and the second digital photograph 1450 during step 1504 described above. Displaying the flipping element 1432 provides an indication to the user that the displayed first digital photograph 1410 is linked with another digital photograph.

Step 1507 of the method 1500 includes receiving a flipping input from the user indicative of a desire to flip the first digital photograph and view the linked second digital photograph. As described herein, in some implementations, the flipping input is a selection (e.g., by clicking or tapping) of the flipping element 1432 (FIG. 6A).

Step 1508 of the method 1500 includes digitally flipping the first digital photograph. As described herein, the first digital photograph 1410 can be flipped such that the second digital photograph 1450 is displayed on the video display device 1110. For example, the first digital photograph 1410 can be flipped to the second digital photograph 1450, for example, as shown in FIGS. 6A-6E. Additionally, while flipping between the first digital photograph 1410 and the second digital image 1460 are shown in FIGS. 7A-7E and FIGS. 8A-8D, step 1508 can include flipping between the first digital photograph 1410 and the second digital photograph 1450 in the same or similar manner.

In some implementations, the method optionally includes step 1509. Step 1509 includes receiving a request to export the first digital photograph to a remote device (e.g., export

the first digital photograph 1410 from the user device 1100 or the remote device 1200 to some other remote device). Responsive to receiving a request to export the first digital photograph, the user is prompted to input whether the user desires to: (1) export only the first digital photograph; or (2) export both the first digital photograph and the second digital photograph. If an input indicative of a desire to export the first digital photograph and the second digital photograph is received, the method 1500 proceeds to step 1510, which includes exporting both the first digital photograph and the second digital photograph to the remote device. If an input indicative of a desire to export only the first digital photograph is received, the method proceeds to step 1511. Step 1510 includes exporting the first digital photograph to the remote device. As described above, the first digital photograph is linked to the second digital photograph during step 1505 and the metadata of the first digital photograph is modified during step 1508. Thus, in both steps 1510 and 1511, the metadata of the exported first digital photograph will include the name of the second digital photograph. In step 1511 where the second digital photograph is not exported, the metadata of the first digital photograph will include the name of the linked second digital photograph.

The digital photograph linking systems and methods described herein (e.g., system 1000 and method 1500) allow users to more efficiency and accurately retrieve and display digital photographs. Unlike a physical photograph that is a three-dimensional object that can be flipped back and forth to see both sides, digital photographs are generally two-dimensional when displayed on display devices. Moreover, in the case of a physical photograph, the two sides are physically linked together, whereas two digital photographs in a database may be stored in different locations. If a user desires to link two digital photographs together such that the user can quickly flip between the two digital photographs (e.g., like the first and second sides of a physical photograph), typically, the digital photographs would need to be displayed side-by-side or organized in the database of digital photographs such that the user can swipe between them (e.g., the two are sequentially stored in the database or photo repository). Digitally linking digital photographs as described herein offers several advantages. For example, the two digital photographs can be stored in different library or albums and yet need only find and select one of the digital photographs, and once that digital photograph is displayed, the user can digitally flip it to view the linked photograph. The systems and methods described herein improve the speed, accuracy, and usability of a database containing a plurality of digital photographs.

Referring to FIG. 10, a method 1700 for generating the second digital image 1460 (FIG. 7F) from the first digital photograph 1410 (FIG. 7A) is described. The method 1700 can be implemented, for example, using the system 1000 (FIG. 4) described herein. More specifically, the flowchart can be implemented as a computer algorithm that instructs or causes the processor 1102 of the user device 1100 to perform the following functions according to non-transitory, machine-readable instructions stored in the memory device 1104. Alternatively, the flowchart can be implemented as a computer algorithm that instructs or causes the processor 1202 of the remote device 1200 to perform the following functions according to non-transitory, machine-readable instructions stored in the memory device 1204. Alternatively still, the flowchart can be implemented as a computer algorithm that instructs or causes both the processor 1202 of the remote device 1200 to perform the following functions according to non-transitory, machine-readable instructions

stored in the memory device **1204** and the processor **1102** of the user device **1100** to perform the following functions according to non-transitory, machine-readable instructions stored in the memory device **1104**.

Referring back to FIG. **9**, in some implementations, method **1700** is performed following step **1503** of the method **1500**. That is, a user can choose to generate the second digital image **1460** instead of linking the first digital photograph **1410** and the second digital photograph **1450** (step **1504** of the method **1500**). Step **1701** of the method **1700** (FIG. **10**) includes receiving an input indicative of a desire to generate likeness(es) of the person(s) in the first digital photo. As described herein, in some implementations, the first digital photograph is associated with person tags that are generated by a user and assigned to each person in the first digital photograph **1410** by the user. Referring to FIGS. **5A** and **5B**, as described herein, a user can select the information element **1430** (FIG. **5A**), which causes the people tag element **1438** (FIG. **5B**) to be displayed on the video display device **1110**. The user can use the people tag element **1438** (FIG. **5B**) to input the first person tag **1422**, the second person tag **1424**, the third person tag **1426**, and the fourth person tag **1428**. For example, in some implementations, selecting the people tag element **1438** (FIG. **5B**) and inputting a person tag causes the first digital photograph **1410** to be displayed on the video display device **1110** such that a user can select (e.g., click or tap) the associated person in the first digital photograph **1410**, thereby associating the person depicted in the first digital photograph **1410** and the inputted person tag.

In other implementations, the person tags are automatically generated and automatically assigned to each person in the first digital photograph **1410**. In such implementations, step **1701** includes detecting a face of a person in the first digital photograph **1410** and comparing the detected face of the person to a facial recognition database (e.g., that is stored in the memory device **1101** of the user device **1100** and/or the memory device **1204** of the remote device **1200** shown in FIG. **4**) to identify the person. A person tag that is associated with the identified person is then automatically generated and associated with the person in the first digital photograph **1410**. For example, the face of the first person **1412** is detected, compared to the facial recognition database to determine that this is the first person **1412**, and the first person tag **1422** is automatically generated and automatically assigned to the first person **1412** in the first digital photograph **1410**.

Step **1702** of the method **1700** includes determining an outline of each person that is assigned a person tag during step **1701**. That is, step **1702** includes analyzing the first digital photograph **1410** and identifying the outline or outer contours of each person that is tagged during step **1701**. In some implementations, analyzing the first digital photograph **1410** includes using one or more filters (e.g., a color filter, a shape filter, or the like, or any combination thereof) to identify the outline or outer contours of each person to analyze the first digital photograph **1410**.

Step **1703** of the method **1700** includes generating a likeness of each person in the first digital photograph that is assigned a person tag during step **1701**. As shown in FIG. **7F**, the second digital image **1460** includes the first person likeness **1612**, the second person likeness **1614**, the third person likeness **1616**, and the fourth person likeness **1618**, each of which is the outline of the corresponding person in the first digital photograph **1410** (compare FIGS. **6A** and **6F**). As described above, each likeness is the outline of each person and does not include additional details (e.g., facial

features, colors, etc.) for simplicity. Each likeness is displayed in the second digital image **1460** in the same position as the outline of the corresponding person in the first digital photograph **1410**. For example, as evidenced by a comparison of FIGS. **6A** and **6F**, the first person likeness **1612** in the second digital image **1460** is in the same position as the first person **1412** in the first digital photograph **1410**. In other words, if one were to Step **1704** of the method **1700** includes overlaying an indicium on each likeness. As shown in FIG. **7F**, the first indicium **1622** is overlaid on the first person likeness **1612**, the second person indicium **1624** is overlaid on the second person likeness **1614**, the third person indicium **1626** is overlaid on the third person likeness **1616**, and the fourth person likeness is overlaid on the fourth person likeness **1618**. More specifically, each indicium is overlaid within the boundaries of the corresponding likeness.

Step **1705** of the method **1700** includes displaying the legend **1420** (FIG. **7F**) and the second digital image **1460** (e.g., on the video display device **1110**). As shown in FIG. **7F**, the legend **1420** is displayed below the second digital image **1460**, which contains the likenesses **1612-1618** and the indicia **1622-1628**. Thus, as described above, a user can intuitively determine who each person is in the first digital photograph **1410** (FIG. **7A**) by viewing the second digital image **1460** (e.g., by digitally flipping the first digital photograph **1410**, as described herein), viewing the indicium overlaid on the likeness (e.g., the first person indicium **1622** overlaid on the first person likeness **1612**), viewing the legend **1420** to determine which person tag corresponds to the indicium (e.g., the first person tag **1422** positioned displayed directly adjacent to the first person indicium **1622**), and thus determine that the first person **1412** in the first digital photograph **1410** corresponds to the first person tag **1422**.

While the first digital photograph **1410** (FIG. **7A**) is shown and described herein as including four people (the first person **1412**, the second person **1414**, the third person **1416**, and the fourth person **1418**), in some implementations, the first digital photograph **1410** can more generally include any number of people (e.g., one person, ten people, twenty people, one hundred people, etc.) And while the second digital image **1460** is shown and described herein as including four likenesses (the first person likeness **1612**, the second person likeness **1614**, the third person likeness **1616**, and the fourth person likeness **1618**), in some implementations, the second digital image **1460** can include a different number of likenesses than the number of people in the first digital photograph **1410** (e.g., the first digital photograph **1410** includes three people and the second digital image **1460** includes one likeness).

Approximate Date Tagging

As described herein, each digital photograph can include metadata, which includes data indicative of a date (e.g., day, month, year, time, etc.) that the digital photograph was generated (i.e., when the photograph was taken). However, some digital photographs may not include metadata with the date that the digital photograph was generated. For example, if the digital photograph is a scanned copy of a physical photograph, the metadata may contain the date that the digital photograph was scanned from the physical photograph, but does not contain the date that the actual physical photograph was generated.

Referring to FIG. **5A**, the first digital photograph **1410** and the user-selectable information element **1430** are displayed on the video display device **1110**. As described herein, a selection (e.g., by clicking or tapping) of the information element **1430** causes the linking element **1433**,

the location tag element **1434**, the likeness generator element **1436**, the people tag element **1438**, the date tag **1440**, the save element **1442**, and the cancel element **1444** are displayed on the video display device **1110**, as shown in FIG. **5B**. Referring to FIG. **11A**, in some implementations, a selection (e.g., by clicking or tapping) of the information element **1430** causes an exact date tag element **1802** and an approximate date tag element **1804** to be displayed on the video display device **1110**. Displaying the exact date tag element **1802** and the approximate date tag element **1804** (FIG. **11A**) can be in addition to, or in the alternative of, also displaying the linking element **1433**, the location tag element **1434**, the likeness generator element **1436**, the people tag element **1438**, and the date tag **1440** (FIG. **5B**).

In some implementations, the exact date tag element **1802** is automatically populated with the date that the first digital photograph **1410** was taken based on the metadata of the first digital photograph **1410**. However, if the metadata does not contain the date that the first digital photograph **1410** was generated, the exact date tag element **1802** will not be automatically populated. In this case, the exact date tag element **1802** is user-selectable such that responsive to a selection (e.g., by clicking or tapping) of the exact date tag element **1802**, the user can input (e.g., via a touchscreen keyboard) the exact date that the digital photograph **1410** was generated. Thus, if the user knows the exact date on which the first digital photograph **1410** was generated, the user can input that information via the exact date tag element **1802**, thereby associating the first digital photograph **1410** with the exact date.

However, in some cases, the metadata of the first digital photograph **1410** does not include a date that the photo was generated and/or the user does not know the exact date, the user can select the approximate date tag element **1804**. Referring to FIG. **11B**, a selection of the user approximate date tag element **1804** causes a month input element **1810**, a season input element **1812**, a first year input element **1814**, and a second year input element **1816** are displayed on the video display device **1110**. The user can input known information and/or estimated information regarding the date that the first digital photograph **1410** was generated via the month input element **1810**, the season input element **1812**, the first year input element **1814**, and the second year input element **1816**. For example, a user selection of the month input element **1810** allows the user to enter more granular information regarding the date that the first digital photograph **1410** was generated. For example, a user may see Christmas decorations in the first digital photograph **1410** and input "December" using the month input element **1810**. A user selection of the season input element **1812** prompts the user to input a season (e.g., winter, spring, summer, fall) during which the first digital photograph **1410** was generated. The season input element **1812** is useful for estimating when the first digital photograph **1410** if the user does not know or cannot estimate the month that the first digital photograph **1410** was generated. For example, the user may not know what month the first digital photograph **1410** was generated, but may see that it is snowing in the first digital photograph **1410** and input "winter" using the season input element **1812**.

While the month input element **1810** and/or the season input element **1812** allow the user to input the time of the year that the first digital photograph **1410** was generated, the first year input element **1814** and the second year input element **1816** allow the user to input an exact year that the first digital photograph **1410** was generated, or a range of years during which the first digital photograph **1410**. A user

selection (e.g., by clicking or tapping) the first year input element **1814** prompts the user to input a year that the first digital photograph **1410** was generated. However, if the user desires to input a range of years, the user can input a first year via the first year input element **1814** and a second year via the second year input element **1816** (e.g., **2010** and **2015**). In other words, entering a year into only the first year input element **1814** is an indication of an exact year, whereas entering different years into the first year input element **1814** and the second year input element **1816** is an indication of a range of years.

Once the user has input information via the month input element **1810**, the season input element **1812**, the first year input element **1814**, and the second year input element **1816**, this information can be displayed with the first digital photograph **1410** on the video display device **1100**. For example, if the user inputs an exact date using the exact date tag element **1802**, the exact date can be displayed with the first digital photograph **1410** (e.g., below the first digital photograph **1410**). As another example, if the user inputs an approximate date via the approximate date tag element **1804**, the approximate date can be displayed with the first digital photograph **1410** (e.g., below the first digital photograph **1410**). When an approximate date is displayed, an indicium can also be displayed that provides an indication to the user that the displayed date is an approximate date (and not an exact date). For example, the indicium can be the letter "c," which is an abbreviation for "circa," which indicates that the date is an approximate date, although the indicium ## can more generally include any other indication that the date is an approximate date (e.g., a symbol such as "~").

In some implementations, rather than prompting a user to input known information about the first digital photograph **1410** via the approximate date tag element **1804** (FIG. **11A**) and the month input element **1810**, the season input element **1812**, the first year input element **1814**, and the second year input element **1816** (FIG. **11B**), the approximate date tag element **1804** (FIG. **11A**) can be automatically populated. In such implementations, the approximate date tag element **1804** is automatically populated by analyzing the first digital photograph **1410** to estimate the date that it was generated. For example, the size of the photograph, the type of film used for the photograph, the type of camera used for the photograph, the color or shading of the photograph, or any combination thereof can be analyzed (e.g., by comparing them to a look-up table of values) to estimate a date that it was generated. For example, the color of the photograph can be analyzed to identify fading that may be indicative of an older photograph.

Comparing Facial Features and Displaying the Results

People often desire to compare a person's facial features (e.g., nose, mouth, eyes, etc.) to those of another person and evaluate the resemblance (or lack thereof) between those people. For example, a person may see a child and their parents (e.g., in a photograph) remark that the child has the father's nose and the mother's eyes. Indeed, people may desire to know from which family member (e.g., parents, aunts/uncles, grandparents, etc.) they inherited a given facial feature, or to whom they are most similar (e.g., parent, sibling, cousin, etc.) However, this comparison is typically done by the naked eye, which cannot accurately quantify the similarities (or lack thereof). Moreover, this type of comparison often requires one to simultaneously view either the actual people, or photographs of those people. And, if one desires to compare a first person's facial features to multiple other people, they must either have a photograph with the

first person and the other people together, or compile a series of photographs and review them individually. While a photograph can be analyzed with facial recognition software, facial recognition processes generally involve identifying a face in a photograph and comparing the face to known faces (e.g., in a database) to identify the person. Thus, it would be advantageous to quickly and efficiently compare one or more facial features of a first person to corresponding facial features of multiple other people (e.g., ten, fifty, one-hundred, one-thousand), quantify the similarities (or lack thereof), and intuitively display the results.

Referring to FIG. 12, a method 2000 for comparing one or more facial features of a first person to one or more corresponding facial features of one or more other persons is described. The method 2000 can be implemented, for example, using a system that is the same as, or similar to, the system 1 (FIG. 1) and/or the system 1000 (FIG. 4) described herein.

Step 2001 of the method 2000 includes analyzing a digital photograph to determine a first set of facial feature data for a face of a person in the digital photograph. More specifically, step 2001 includes analyzing a digital photograph to identify a face of a person, identify one or more facial features of the face of the person (e.g., nose, mouth, eyes, eye brows, jawline, ears, forehead, hairline, etc.), and identify one or more landmarks (e.g., coordinates) of the identified one or more facial features. The first set of facial feature data includes landmarks for each of the identified facial features, a pose (e.g., a yaw angle, a pitch angle, and a roll angle, where 0 degrees for all three angles means that the face is looking directly at the camera) of the identified face, a confidence value indicative of a percentage likelihood that the identified face is an actual face, a face image quality (e.g., brightness, sharpness, etc.), or any combination thereof. In some implementations, the first set of facial feature data can further include facial condition information, where the facial condition information can be indicative of an open mouth, a closed mouth, an open eye, a closed eye, a squinted eye, the presence of eyewear (e.g., glasses or sunglasses), a smile, an emotion (e.g., happy, angry, calm, confused, sad, etc.), yawning, nostril flaring, the presence of facial hair (e.g., a beard, mustache, etc.) or any combination thereof.

Referring to FIG. 13, a first digital photograph 2100 of a first person is illustrated. Using first digital photograph 2100 of FIG. 13 as an example, during step 2001, the first digital photograph 2100 is analyzed to identify a face 2102 of a person. As shown, the location of the face 2102 within the first digital photograph 2100 is identified by a bounding box 2104. The bounding box 2104 is defined by a height expressed as a ratio of the overall height of the first digital photograph 2100 and a width expressed as a ratio of the overall width of the first digital photograph 2100. For example, if the digital photograph 2100 is 500 pixels by 500 pixels and the bounding box starts at 75 pixels from the left edge of the digital photograph and 75 pixels from the top edge of the digital photograph, the bounding box 2104 is located at coordinates 0.15, 0.15. If the bounding box 2104 is 100 pixels in width and 200 pixels in height, this means that the bounding box 2104 is 20% of the width of the digital photograph (i.e., 500 pixels/100 pixels) and the relative area of the bounding box 2104 is 40% of the height of the digital photograph (i.e., 500 pixels/200 pixels).

During step 2001, the face 2102 contained within the bounding box 2104 is analyzed to identify one or more facial features, including a nose 2110, a mouth 2120, a left eye 2130A, a right eye 2130B, a left eyebrow 2140A, a right

eyebrow 2140B, and a jawline 2150. Each of the various landmarks described herein includes coordinates (e.g., x and y coordinates in terms of pixels) to define the position of the corresponding facial feature. That is, if a landmark is located 100 pixels from the left edge of the photograph (which is 500 pixels by 500 pixels) and 150 pixels from the top edge of the photograph, the x-coordinate for the landmark is 0.2 and the y-coordinate for the landmark is 0.3. The various landmarks for the various facial features described herein can be expressed in the same or similar manner (e.g., as a value between 0 and 1).

As shown, the relative position of the nose 2110 is defined by a nose tip landmark 2112, a left nostril landmark 2114, a right nostril landmark 2116, and a nose bridge landmark 2118. The nose tip landmark 2112 is located at approximately the tip of the nose (e.g., the forward-most protruding point of the nose 2110), the left nostril landmark 2114 is located at approximately the center of the left nostril, the right nostril landmark 2116 is located at approximately the center of the right nostril, and the nose bridge landmark 2118 is located at approximately the bridge of the nose 2110. The relative position of the mouth 2120 is defined by a left mouth landmark 2122, an upper mouth landmark 2124, a right mouth landmark 2126, and a lower mouth landmark 2128. As shown, the left mouth landmark 2122 and the right mouth landmark 2126 are located approximately at the corners of the mouth 2120 where the upper and lower lips intersect. The upper mouth landmark 2124 and the lower mouth landmark 2128 are located approximately at the upper and lower edges of the upper and lower lips of the mouth 2120, respectively. The relative position of the left eye 2130A is defined by a left eye landmark 2132A, an upper eye landmark 2134A, a right eye landmark 2136A, a lower eye landmark 2138A, and a left pupil landmark 2139A. As shown, the left eye landmark 2132A and the right eye landmark 2136A are located approximately at the corners of the left eye 2130A where the upper and lower eyelids intersect, and the upper eye landmark 2134A and the lower eye landmark 2138A are located approximate at the upper and lower edges of the upper and lower eye lids of the left eye 2130A, respectively. The left pupil landmark 2139A is located approximately at the center of the left pupil of the left eye 2130A. The location of the right eye 2130B is defined by a left eye landmark 2132B, an upper eye landmark 2134B, a right eye landmark 2136B, a lower eye landmark 2138B, and a right pupil landmark 2139B that are the same as, or similar to, the corresponding landmarks for the left eye 2130A. The relative position of the left eyebrow 2140A is defined by a left eyebrow landmark 2142A, an upper eyebrow landmark 2144A, and a right eyebrow landmark 2146A. As shown, the left eyebrow landmark 2142A and the right eyebrow landmark 2146A are located approximately at the corners of the left eyebrow 2140A, and the upper eyebrow landmark 2144A is located approximate at the upper edge of the left eyebrow 2140A. The position of the right eyebrow 2140B is defined by a left eyebrow landmark 2142B, an upper eyebrow landmark 2144B, and a right eyebrow landmark 2146B. As shown, the left eyebrow landmark 2142B and the right eyebrow landmark 2146B are located approximately at the corners of the right eyebrow 2140B, and the upper eyebrow landmark 2144B is located approximate at the upper edge of the right eyebrow 2140B. The relative position of the jawline 2150 is defined by an upper left jawline landmark 2152, a lower left jawline landmark 2154, a chin landmark 2155, a lower right jawline landmark 2156, and an upper right jawline landmark 2158.

Referring back to FIG. 12, step 2002 of the method 2000 includes determining whether the face of the person in the digital photograph (identified during step 2001) corresponds to a person tag. As described herein, digital photographs can be associated with a person tag (e.g., manually or automatically) for a given person and stored in a photo repository. A person tag for a given person can be associated with one or more digital photographs of that person and facial feature data (that is the same as, or similar to, the first set of facial feature data obtained during step 2001) for that person. Thus, during step 2002, the first set of facial feature data obtained during step 2001 from the digital photograph is compared to facial feature data associated with various person tags to identify a match (e.g., exceeding a predetermined confidence interval). For example, as described in further detail herein, each person tag can be associated with a trained regression model. The first set of facial feature data can be inputted into trained regression models for each person tag to determine a match (e.g., if the output of a regression model is greater than 0.8, greater than 0.9, greater than 0.95, etc.)

If it is determined that the person in the first digital photograph does not correspond to a previously generated/assigned person tag during step 2002, the method 2000 proceeds to step 2003, which includes associating the digital photograph and the first set of facial features determined during step 2001 with a “null” person tag. The digital photograph, the first set of facial features, and the “null” person tag are then stored in the photo repository. This allows the digital photograph and the first set of facial feature data to be associated with a person tag in the future (e.g., a user can manually assign a new person tag to this digital photograph). If it is determined that the person in the first digital photograph corresponds to a previously generated/assigned person tag during step 2002, step 2004 of the method 2000 includes associating the digital photograph and the first set of facial features determined during step 2001 with the person tag identified during step 2002. The digital photograph, the first set of facial features, and the person tag are then stored in the photo repository.

Step 2005 of the method 2000 includes analyzing the first set of facial feature data (obtained during step 2001) to determine a second set of facial feature data. The second set of facial feature data can include, for example, one or more relative dimensions of one or more identified facial features of the person in the digital photograph. That is, the second set of facial feature data (step 2005) is calculated based at least in part on the first set of facial feature data (step 2001). As described in further detail herein, the second set of facial feature data determined during step 2005, along with the first set of facial feature data determined during step 2001, are used to determine a regression model for each of the facial features. The second set of facial feature data obtained during step 2005 aids in generating a more accurate regression model than using the first set of facial feature data alone to generate a regression model.

Referring to FIGS. 14A and 14B, the second set of facial feature data can include one or more relative dimensions for one or more facial features. For example, the second set of facial feature data can include a height and/or a width of the nose 2110, the mouth 2120, the left eye 2130A, the right eye 2130B, the left eyebrow 2140A, the right eyebrow 2140B, the jawline 2150, or any combination thereof. The height and/or width of the facial features can be expressed relative to the total area of the face 2102 (e.g., relative to the area of the bounding box 2104) and/or the pose (e.g., pitch, roll, yaw) of the face 2102. For example, as shown in FIG. 14A,

a width 2120W of the mouth 2120 can be obtained by determining the distance between the left mouth landmark 2122 and the right mouth landmark 2126. The width 2120W can be expressed as a portion of the overall width of the face 2102 (e.g., if the width 2120W is 100 pixels and the width of the bounding box 2104 is 1000 pixels, the width 2120W of the mouth 2120 can be expressed as 0.1). A height 2120H of the mouth 2120 can be obtained by determining the distance between the upper mouth landmark 2124 and the lower mouth landmark 2128. The height 2120H can be expressed in the same or similar manner as the width 2120W. Likewise, a height and/or a width of each of the nose 2110, the left eye 2130A, the right eye 2130B, the left eyebrow 2140A, the right eyebrow 2140B, the jawline 2150, or any combination thereof, can be determined in the same or similar manner as the width 2120W and/or the height 2120H of the mouth 2120.

As another example, the second set of facial feature data can include one or more relative dimensions between various facial features. For example, as shown in FIG. 14A, a first relative distance d_1 between the left eye 2130A and the nose 2110 can be obtained by determining a distance between the nose tip landmark 2112 and the left pupil landmark 2139A. Alternatively, the relative distance d_1 between the left eye 2130A and the nose 2110 can be obtained by determining a distance between any combination of the landmarks for the nose 2110 and the landmarks for the left eye 2130A (e.g., a distance between the left upper eye landmark 2134A and the left nostril landmark 2114 (FIG. 13), etc.) As another example, a second relative distance d_2 between the left eye 2130A and the right eye 2130B can be obtained by determining a distance between the left pupil landmark 2139A and the right pupil landmark 2139B. As yet another example, the second set of facial feature data can include a relative dimension between more than two facial features such a third relative distance d_1 between the nose 2110, the mouth 2120, and the jawline 2150, which can be obtained by determining a distance between the left nostril landmark 2114, the right mouth landmark 2126, and the lower right jawline landmark 2156. In this manner, relative distances can be calculated between any combination of facial features using any combination of the various landmarks for each of the facial features.

Referring to FIG. 14B, in some implementations, in addition to determining a height and/or width of individual facial features, the second set of facial feature data can include an arc that defines a facial feature. For example, a first arc a_1 for the left eyebrow 2140A can be determined by defining an arc through the right eyebrow landmark 2142A, the upper eyebrow landmark 2144A, and the left eyebrow landmark 2146A. Similarly, a second arc a_2 for the jawline 2150 can be determined by defining an arc through the upper left jawline landmark 2152, the lower left jawline landmark 2154, the chin landmark 2155, the lower right jawline landmark 2156, the upper right jawline landmark 2158, or any combination thereof. In this manner, various arcs can be determined for any combination of landmarks for any one of the facial features. In other implementations, the second set of facial feature data can include a shape (e.g., curved, straight, square, round, triangular, etc.), an area (e.g., expressed as a portion of the total area of the face 2102), a color (e.g., skin tone, eye color, etc.), of any one of the various facial features.

In some implementations, step 2005 of the method 2000 includes determining a bounding box for one or both of the eyes of the person. For example, the bounding box for the left eye 2130A (FIG. 13) can be determined based on the left

eye landmark **2132A**, the upper eye landmark **2134A**, the right eye landmark **2136A**, and the lower eye landmark **2138A**. The bounding box for the right eye **2130B** can be determined in the same or similar manner. Once the bounding box(es) are determined, the color of the eye(s) can be determined using a histogram processor that extracts the color palette from the bytes of the photograph within the bounding box to determine the color and/or calculate color variations. The determined color(s) can be used to determine whether the person has two different colored eyes (e.g., heterochromia) or multi-color irises (e.g., central heterochromia), which tend to be inherited from ancestors. Similarly, in such implementations, step **2005** can determine based on the pupil landmark **2139A** for the left eye **2130A** and the pupil landmark **2139B** for the right eye **2130B** whether the person has strabismus (lazy eye) or amblyopia (crossed eyes), which tend to be inherited from ancestors, based on a relative distance between the pupil landmark **2139A** and the pupil landmark **2139B** (e.g., which can be indicative of strabismus), or a relative distance between the pupil landmark **2139A** or the pupil landmark **2139B** the various other landmarks of the corresponding eye (e.g., which can be indicative of amblyopia).

Table 1 below includes exemplary calculations that can be included in the second set of facial feature data calculated during step **2005**.

	Distance	Color	Shape, arcs, angles
Eyes	Distance between eyes, size of eyeballs, size of first eye compared to second eye	Actual colors, differing eye colors	Longer, wider, eyelid coverage, shape of eye lids, deep set eye, mongoloid, hooded eyelids, protruding eyes, upturned eyes, close set eyes, wide set eyes, bug eyes, reset eyes, distance one eye is set back from the other
Nose	Nostrils size, bridge size, distances from points of nose to other parts (e.g., eyes, mouth), crookedness to one side or another		Shape of nostrils, shape of nose bridge, side view shape, bump in nose (side/profile view) bridge, fleshy nose, nose types (e.g., turned-up nose, Roman nose, bumpy nose, snub nose, hawk nose, Greek nose, nubian nose)
Mouth	Overall height of top and bottom lips, width	Lip color	Naturally full lips, thin top and bottom lips, lips that are plumper in the center, lips with a peaked cupid's bow, lips with a rounded cupid's bow, lips with an undefined cupid's bow, Goldilocks lips
Chin/Jaw	Width, height		Short, long, double, rounded, fleshy, protruding, jutting, pointed, square, receding, dimpled
Ears	One ear higher than another, one ear bigger than another		Side view shape of ears, differences in ear curvature, ears "sticking out" (prominent ear), cupped ear (cryptotia), small, stub-like ear (microtia), an absence of any ear at

-continued

	Distance	Color	Shape, arcs, angles
			all (anotia), Stahl's ear (where the top part of the ear has an extra crus, which is a fold in the ear that causes the top portion of the ear to appear pointy), prominent ear happens (when there a fold missing at the edge of the ear in addition to an overabundance at the bowl of the ear).
Eyebrow	Length of eyebrows, one bigger than another, one thicker than another, one higher/lower than another	Eyebrow color	Structured brow with angled arches and longer ends for round face, well-balanced and contoured brows for oval face, soft, rounded arch for heart shaped face, brows with angled peak for square face, shorter brows for oblong face, linear brow shape for diamond-shaped face
Forehead	Size on the divisions of the forehead for upper section, middle section, lower section.		Divisions of the forehead for upper section, middle section, lower section (brow ridge), broad vs. narrow, curved, sloped, lines on forehead
Face	Facial points to aid in determining overall height or width	Face color	Oval, square, heart shape, round, rectangular, triangle
Hairline			High and broad, low and narrow, straight and square, rounded hairline, M-shaped hairline, widow's peak hairline, uneven or zigzag hairline, receding, bald

Step **2006** of the method **2000** includes determining a regression model for each of the facial features based on the first set of facial feature data (step **2001**) and the second set of facial feature data (step **2005**). More specifically, during step **2006**, a regression model is generated for each of the facial features (e.g., nose, mouth, eyes, jawline, etc.) based on a portion of the first set of facial feature data and a portion of the second set of facial feature data associated with that facial feature. The regression model includes a plurality of independent variables, where data points from the first set of facial feature data and data points from the second set of facial feature data are the independent variables. The regression model can be a logistic regression, a deep learning regression, a neural network regression, or any combination thereof.

As shown by the arrow in FIG. **12**, steps **2001-2006** can be repeated one or more times to train each regression model. That is, steps **2001-2005** can be repeated for a second photograph of the same person to update the regression model. The more times that the steps of the method **2000** are repeated, the more accurate the resulting regression model in step **2006** will be. In the case of a neural network regression,

there are a plurality of inputs that define a net input function, where each of the plurality of inputs are weighted (e.g., with a value between -1 and 1). Repeating the method **2000** for a series of photographs of the person updates the weights of the plurality of inputs so as to increase the accuracy of the regression model. For example, if it is determined that there is a small variance between a certain data point (e.g., a relative distance between facial features) in the first or second set of facial feature data between a series of photographs of the person, that input will be accorded a greater weight in the neural network model. Conversely, if it is determined that there is a large variance between a certain data point in the first or second set of facial feature data between a series of photographs of the person, that input will be accorded a lesser weight in the neural network model. In this manner, the regression model can be trained to minimize errors.

In addition to determining a regression model for each of the individual facial features, step **2006** also includes determining a regression model for a person feature. As used herein, a person feature refers to a combination of a plurality of facial features (e.g., two or more of the nose, the mouth, the left eye, the right eye, the left eyebrow, the right eyebrow, the jawline, etc.). That is, the person feature is an aggregate of all or some of the regression models of the facial features together into a single value indicative of the overall appearance/likeness of the face of the person. For example, the regression model for the person feature can be an average of the outputs all of the regression models for each of the individual facial features. Alternatively, the regression model for the person feature can be a weighted average of all or some of the regression models for the individual facial features (e.g., each regression for each individual facial feature is assigned a weight between 0.1% and 99.9%).

Referring to FIG. **15**, a method **3000** for comparing facial features of one or more persons and displaying the results is described. The method **3000** can be implemented, for example, using a system that is the same as, or similar to, the system **1** (FIG. **1**) and/or the system **1000** (FIG. **4**) described herein.

Step **3001** of the method **3000** includes receiving (e.g., via a user input device) a selection of a first person whose facial feature(s) are to be compared to those of at least one other person. As described herein, a photo repository can include a library containing photographs and associated information for a plurality of people (e.g., 10 people, 100 people, 1,000 people, 10,000 people, etc.) Step **3001** includes selecting a first one of these people stored in the library that will then be compared to at least one different person stored in the library.

Referring to FIG. **16**, a first selection element **3100** is displayed on a video display device (e.g., that is the same as or similar to the video display device **1110** described herein). The first selection element **3100** permits the system to receive a selection of the first person during step **3001**. In this example, the first selection element **3100** is a dropdown menu configured to allow a user to select (e.g., by clicking or tapping) a first person, a second person, a third person, or a fourth person whose facial feature(s) will be compared to those of at least one other person during subsequent steps of the method **3000**.

Step **3002** includes receiving a selection of at least one other person to be compared to the first person selected during step **3001**. Referring to FIG. **16**, a second selection element **3102** and a third selection element **3104** are displayed on the video display device. The second selection

element **3102** permits the system to receive a selection of a plurality of persons to be compared to the first person, where each of the plurality of persons have been previously associated with the first person by a relationship. That is, the second selection element **3102** permits a user to select a plurality of persons based on their relationship to the first person, rather than having to individually select each of the plurality of persons (e.g., in a dropdown menu). The relationship can be, for example, a family relationship, a non-family relationship, or friend relationship, or any other relationship that can be customized by the user. In this example, the second selection element **3102** is a dropdown menu in which a user can select (e.g., by clicking or tapping) a family relationship (e.g., immediate family, extended family, etc.), a non-family relationship, or a friend relationship. The third selection element **3104** is similar to the first selection element **3100** in that it permits the system to receive a selection of a second person to be compared to the first person selected during step **3001** via the first selection element **3100**. That is, the third selection element **3104** allows a user to selection a single person to be compared to the first person selected during step **3001**. Alternatively, in some implementations, the third selection element **3104** can allow a user to select a plurality of individual persons (e.g., two, three, five, etc.) to be compared to the first person, rather than an entire group of persons (e.g., as would be the case when using the second selection element **3102**).

Step **3003** (FIG. **15**) of the method **3000** includes receiving an input from a user indicative of a desire to compare one or more facial features of the first person (step **3001**) and the other person(s) (step **3002**). Referring to FIG. **16**, a matching element **3106** is displayed on the video display device along with the first selection element **3100**, the second selection element **3102**, and the third selection element **3104**. In this example, the user can indicate a desire to match the selected first person (step **3001**) and the selected other person(s) (step **3002**) by selecting (e.g., by clicking or tapping) the displayed matching element **3106**.

Step **3004** (FIG. **15**) of the method **3000** includes determining and quantifying the similarity of facial features of the first person (step **3001**) and the other person(s) (step **3002**). For example, the similarity of facial features of the first person and other person(s) can be determined using the method **2000** (FIG. **12**) described herein. As an example, during step **3004**, it can be determined that a person feature of the first person is 17% similar to a second person, 11% similar to a third person, and 4% similar to a fourth person; a nose feature of the first person is 54% similar to the third person, 11% similar to the second person, and 7% similar to the fourth person; and an eye feature of the first person is 86% similar to a fifth person, 24% similar to the third person, and 7% similar to the second person.

Step **3005** (FIG. **15**) of the method **3000** includes displaying the results of step **3004**, and more specifically, displaying a thumbnail image and an indicium for a plurality of facial features. Referring to FIG. **18**, using the example above, person feature results **3200**, nose feature results **3300**, and eye feature results **3400** are displayed on the video display device. The person feature results **3200** include a first thumbnail image **3202**, a second thumbnail image **3204**, a third thumbnail image **3206**, a first indicium **3212**, a second indicium **3214**, and a third indicium **3216**. As described above, in this example, it was determined during step **3004** that the person feature of the first person is 17% similar to a second person, 11% similar to a third person, and 4% similar to a fourth person. The first thumbnail image **3202** includes a portion of a photograph of the second person

(e.g., the face of the second person) and the first indicium **3212** includes alphanumeric text indicative of the percentage similarity (in this example, 17%). Similarly, second thumbnail image **3204** includes a portion of a photograph of the third person (e.g., the face of the third person) and the second indicium **3214** includes alphanumeric text indicative of the percentage similarity (11%), and the third thumbnail image **3206** includes a portion of a photograph of the fourth person (e.g., the face of the fourth person) and the third indicium **3216** includes alphanumeric text indicative of the percentage similarity (4%). As shown, the thumbnail images and indicia are displayed left to right in a predetermined sequence according to the percentage similarity.

As described above, in this example, it was determined during step **3004** that the nose feature of the first person is 54% similar to the third person, 11% similar to the second person, and 7% similar to the fourth person. Thus, within the nose feature results **3300**, the first thumbnail image **3302** includes a portion of a photograph of the third person (e.g., the face of the third person) and the first indicium **3312** includes alphanumeric text indicative of the percentage similarity (54%). Similarly, second thumbnail image **3304** includes a portion of a photograph of the second person (e.g., the face of the second person) and the second indicium **3314** includes alphanumeric text indicative of the percentage similarity (11%), and the third thumbnail image **3306** includes a portion of a photograph of the fourth person (e.g., the face of the fourth person) and the third indicium **3316** includes alphanumeric text indicative of the percentage similarity (7%). It was also determined during step **3004** in this example that the eye feature of the first person is 86% similar to a fifth person, 24% similar to the third person, and 7% similar to the second person. Thus, within the eye feature results **3400**, the first thumbnail image **3402** includes a portion of a photograph of the fifth person (e.g., the face of the fifth person) and the first indicium **3412** includes alphanumeric text indicative of the percentage similarity (86%). Similarly, the second thumbnail image **3404** includes a portion of a photograph of the third person (e.g., the face of the third person) and the second indicium **3414** includes alphanumeric text indicative of the percentage similarity (24%), and the third thumbnail image **3406** includes a portion of a photograph of the second person (e.g., the face of the second person) and the third indicium **3416** includes alphanumeric text indicative of the percentage similarity (7%).

While only three results are shown in each of the person feature results **3200**, the nose feature results **3300**, and the eye feature results **3400** in the example of FIG. 17, more generally, the person feature results **3200**, the nose feature results **3300**, and the eye feature results **3400** can include any suitable number of results. For example, in some implementations, the person feature results **3200**, the nose feature results **3300**, and the eye feature results **3400** only display results if the output of the regression model is greater than a predetermined threshold (e.g., greater than 0.05, greater than 0.1, greater than 0.3, greater than 0.5, greater than 0.8, etc.) Alternatively, the person feature results **3200**, the nose feature results **3300**, and the eye feature results **3400** can be configured to display a predetermined number of the closest matches (e.g., the two most similar people for each feature, the four most similar people for each feature, etc.) Further, any combination of feature results can be displayed in addition to, or in the alternative of, the person feature results **3200**, the nose feature results **3300**, and the eye feature results **3400** (e.g., eyebrow feature results, jawline feature results, mouth feature results, etc.)

Referring back to FIG. 15, step **3005** of the method **3000** includes displaying a photo of the first person and a photograph of another person responsive to receiving a selection of a thumbnail image. Each of the various thumbnail images displayed on the video display device in FIG. 17 are user-selectable (e.g., by clicking or tapping). Responsive to a selection of the first thumbnail image **3302** (FIG. 17), for example, a photograph of the first person **3500**, a photograph of the third person **3502**, and the first indicium **3312** are displayed on the video display device, as shown in FIG. 18. The photograph of the first person **3500** and the photograph of the third person **3502** each include a face of the first person and the third person, respectively. A first user-selectable navigation element **3510** and a second user-selectable navigation element **3512** are also displayed on the video display device. Selecting the first user-selectable navigation element **3510** causes all of the indicia associated with the third person displayed in FIG. 17 to be displayed simultaneously on the display with the photograph of the first person **3500** and the photograph of the third person **3502**, as shown in FIG. 19. This allows a user to view all of the determined similarities between the first person and the third person. Selecting the second user-selectable navigation element **3512** the next result in the nose feature results **3300** (FIG. 17) to be displayed in the same or similar manner as if the user had selected the third thumbnail image **3306**. This allows a user to navigation between each of the people within the results for a particular feature.

In some implementations, the method **3000** includes importing a plurality of digital photographs from an external system (e.g., a website or database), where each of the plurality of digital photographs have been previously linked or associated together by a predetermined relationship, such as, for example, a familial relationship. The photographs can be linked or associated by the predetermined relationship using, for example, user inputs (e.g., a user inputs a family tree including people that are related) or DNA testing results (e.g., each of the people in the photos have submitted a DNA sample for analysis and the people are linked together based on the results). After these digital photographs are imported, they may be selected during step **3002** (e.g., using the second selection element **3102** of FIG. 16) and the method **3000** proceeds as described herein to compare those people with the selected first person.

In other implementations, an alternative method that is similar to the method **3000** includes receiving a selection of a first person (e.g., in the same or similar manner as step **3001**). The alternative method differs from method **3000** in that the alternative method includes importing a digital photograph of the selected first person from an external system (e.g., uploading the photograph to a website). For example, the photograph of the selected first person can be uploaded to a website (e.g., an ancestry website such as ancestry.com, My Heritage, FamilySearch, etc.) and then compared to photographs of one or more other persons in the same or similar manner as method **3000**. For example, a previously trained regression model(s) for facial feature(s) of the first person can be imported from the external system along with the first digital photograph. Alternatively, a series of photographs of the first person can be imported from the external and a regression model can be trained subsequent to the importing in the same or similar manner as described herein. Facial feature data for a plurality of other persons having a predetermined relationship (e.g., familial) with the first person are then passed through a regression model for each facial feature of the first person to determine the similarity between the first person and each of those people.

Alternative Implementations

Alternative Implementation 1.

A computer-implemented method for organizing digital videos, each of the digital videos having content data and metadata, the content data being reproducible as an initial video frame, a final video frame, and a plurality of video frames therebetween includes analyzing the content data of a first digital video to associate at least a first portion of a first one of the plurality of video frames of the first digital video with a first automatically-generated content tag, the first video frame of the first digital video being associated with a first time t_1 of the first digital video; automatically generating a first thumbnail image associated with the first digital video, the first thumbnail image including at least a second portion of the first video frame of the first digital video; displaying, on a video display device, the first thumbnail image associated with the first digital video; and responsive to receiving a selection of the first thumbnail image associated with the first digital video via a user interface, causing the first digital video to be played on the video display device starting at the first time t_1 .

Alternative Implementation 2.

The method according to alternative implementation 1, further comprising analyzing the metadata of the first digital video to associate the first digital video with an automatically-generated location tag and an automatically-generated date tag, the metadata including (i) location data associated with a geographic location where the first digital video was generated and (ii) date and time data associated with the date and time when the first digital video was generated.

Alternative Implementation 3.

The method according to alternative implementation 1, further comprising automatically generating a second thumbnail image associated with the first digital video, the second thumbnail image including at least a portion of the initial video frame associated with an initial time t_0 of the first digital video; displaying, on the video display device, the second thumbnail image associated with the first digital video; and responsive to receiving a selection of the second thumbnail image via the user interface of the video display device, causing the first digital video to be played on the video display device starting at the initial time t_0 of the first digital video.

Alternative Implementation 4.

The method according to alternative implementation 1, wherein the first automatically-generated content tag is a person tag or an object tag.

Alternative Implementation 5.

The method according to alternative implementation 1, wherein the analyzing the content data includes detecting a face of a person in the first video frame of the first digital video, comparing the detected face of the person to a facial recognition database to identify a name of the person, and wherein the first automatically-generated content tag is a person tag associated with the identified name of the person.

Alternative Implementation 6.

The method according to alternative implementation 1, further comprising analyzing the content data of a second digital video to associate at least a first portion of a first one of the plurality of video frames of the second digital video with a second automatically-generated content tag, the first video frame of the second digital video being associated with a first time t_1 of the second digital video; automatically generating a second thumbnail image associated with the second digital video, the second-video thumbnail image including at least a second portion of the second video

frame; displaying, on the video display device, the second thumbnail image associated with the second digital video; and responsive to receiving a selection of the second thumbnail image associated with the second digital video via the user interface of the video display device, playing the second digital video on the video display device starting at the first time t_1 of the second digital video.

Alternative Implementation 7.

The method according to alternative implementation 6, wherein the first automatically-generated content tag associated with the first video frame of the first digital video is different than the second automatically-generated content tag associated with the first video frame of the second digital video.

Alternative Implementation 8.

The method according to alternative implementation 7, wherein responsive to a selection of the first automatically-generated content tag, causing the first thumbnail image associated with the first digital video to be displayed on the video display device and causing the second thumbnail image associated with the second digital video not to be displayed on the video display device.

Alternative Implementation 9.

The method according to alternative implementation 1, wherein the analyzing the content data of the first digital video includes associating at least a first portion of a second one of the plurality of video frames of the first digital video with the first automatically-generated content tag, the second video frame of the first digital video being associated with a second time t_2 of the first digital video that is subsequent to the first time t_1 of the first digital video, and responsive to receiving a selection of the first thumbnail image via the user interface of the video display device, playing a clip of first digital video defined by the first time t_1 and the second time t_2 on the video display device.

Alternative Implementation 10.

The method according to alternative implementation 1, further comprising analyzing the content data of the first digital video to associate at least a first portion of a second one of the plurality of video frames with a second automatically-generated content tag, the second video frame of the first digital video being associated with a second time t_2 of the first digital video that is different than the first time t_1 of the first digital video; automatically generating a second thumbnail image associated with the first digital video, the second thumbnail image including at least a second portion of the second video frame of the first digital video; displaying, on the video display device, the second thumbnail image associated with the first digital video; and responsive to receiving a selection of the second thumbnail image via a user interface, causing the first digital video to be played on the video display device starting at the second time t_2 .

Alternative Implementation 11.

The method according to alternative implementation 1, wherein the first portion of the first video frame of the first digital video that is associated with the first automatically-generated content tag is the same as the second portion of the first video frame of the first digital video included in the first thumbnail image.

Alternative Implementation 12.

The method according to alternative implementation 1, wherein the first portion the first portion of the first video frame of the first digital video that is associated with the first automatically-generated content tag is different than the second portion of the first video frame of the first digital video included in the first thumbnail image.

Alternative Implementation 13.

A computer-implemented method for organizing digital videos, the digital videos having content data and metadata, the content data including an initial video frame, a final video frame, and a plurality of video frames therebetween includes: while a first digital video is playing on a video display device, causing the first digital video to be paused at a first time t_1 such that a first one of the plurality of video frames of the first digital video is displayed; receiving, via a user interface, a user-generated content tag; associating the user-generated content tag with the first video frame of the first digital video; generating a first thumbnail image associated with the first digital video, the first thumbnail image including at least a portion of the first video frame of the first digital video; displaying, on the video display device, the first thumbnail image that is associated with the first digital video; and responsive to receiving a selection of the first thumbnail image, causing the first digital video to be played on the video display device starting at the first time t_1 .

Alternative Implementation 14.

The method according to alternative implementation 13, wherein the user-generated tag is a person tag, an object tag, an event tag, a location tag, or a date tag.

Alternative Implementation 15.

The method according to alternative implementation 14, wherein the user-generated tag is the event tag, the event tag being indicative of a milestone, a holiday, a vacation, a sporting event, a performance event, or any combination thereof

Alternative Implementation 16.

The method according to alternative implementation 13, wherein the generating the first thumbnail image includes receiving, via the user interface, a selection of a region of interest within the first video frame of the first digital video, and the portion of the first video frame included in the first thumbnail image is the selected region of interest.

Alternative Implementation 17.

The method according to alternative implementation 16, wherein the selected region of interest of the first video frame includes at least a face of a person in the first video frame of the first digital video.

Alternative Implementation 18.

The method according to alternative implementation 13, wherein the metadata of the first digital video includes location data indicative of a geographic location where the first digital video was generated, the user-generated content tag is a user-generated location tag, and wherein the associating includes associating the user-generated location tag with the location data indicative of where the first digital video was generated.

Alternative Implementation 19.

The method according to alternative implementation 18, further comprising comparing location data indicative of a geographic location where a second digital video was generated to the location data indicative of the geographic location where the first digital video was generated; and responsive to determining that the geographic location where the second digital video was generated is the same as the geographic location where the first digital video was generated, automatically associating the user-generated location tag with the second digital video.

Alternative Implementation 20.

The method according to alternative implementation 13, further comprising: subsequent to receiving the user-generated content tag, causing the first digital video to resume playing on the video display device; responsive to an input received via the user interface, causing the first digital video

to be paused at a second time t_2 such that a second one of the plurality of video frames of the first digital video is displayed; receiving, via the user interface, a second user-generated content tag; associating the second video frame of the first digital video with the second user-generated content tag; generating a second thumbnail image associated with the first digital video, the second thumbnail image including at least a portion of the second video frame of the first digital video; displaying the second thumbnail image on the video display device; and responsive to receiving a selection of the second thumbnail image of the first digital video via the user interface, causing the first digital video to be played on the video display device starting at the second time t_2 .

Alternative Implementation 21.

The method according to alternative implementation 20, wherein responsive to a selection of the second user-generated content tag via the user interface, the second thumbnail image associated with the first digital video is displayed on the video display device and the first thumbnail image associated with the first digital video is not displayed on the video display device.

Alternative Implementation 22.

The method according to alternative implementation 20, wherein (i) the first user-generated content tag is a first date tag and the second user-generated content tag is a second date tag, wherein the first date tag is associated with a first date that is different than a second date that is associated with the second date tag or (ii) the first user-generated content tag is a first location tag and the second user-generated content tag is a second location tag, wherein the first location tag is associated with a first location that is different than a second location that is associated with the second location tag.

Alternative Implementation 23.

The method according to alternative implementation 13, wherein the receiving includes receiving a selection of a face of a person within the first video frame, and the user-generated tag is a person tag associated with the person.

Alternative Implementation 24.

The method according to alternative implementation 23, further comprising: analyzing the content data of a second digital video to identify the face of the person one of the video frames of the second digital video; responsive to identifying the face of the person in one of the video frames of the second digital video, automatically associating the one of the video frames including the face of the person with the person tag; generating a second thumbnail image associated with the second digital video, the second thumbnail image including at least the face of the person in the one of the video frames; and responsive to a selection of the second thumbnail image associated with the second digital video, causing the second digital video to be played on the video display device starting at the one of the video frames including the face of the person.

Alternative Implementation 25.

The method according to alternative implementation 13, further comprising: generating a second thumbnail image associated with the first digital video, the second thumbnail image including at least a first portion of the initial video frame of the first digital video, the initial video frame being associated with an initial time t_0 of the first digital video; displaying the second thumbnail image associated with the first digital video on the video display device; and responsive to receiving a selection of the second thumbnail image via the user interface, causing the first digital video to be played on the video display device starting the initial time t_0 .

51

Alternative Implementation 26.

The method according to alternative implementation 13, wherein the first digital video is paused at the first time t_1 responsive to an input received via a user interface.

Alternative Implementation 27.

The method according to alternative implementation 13, wherein the first time t_1 associated with the first video frame of the first digital video is subsequent to an initial time t_0 associated with the initial video frame of the first digital video.

Alternative Implementation 28.

A computer-implemented method for organizing a plurality of digital videos, each of the plurality of digital videos having content data and metadata, the content data including a plurality of video frames, the method comprising: analyzing the content data of a first one of the plurality of digital videos to associate at least a first portion of a first one of the plurality of video frames of the first digital video with a first automatically-generated content tag, the first video frame of the first digital video being associated with a first time t_1 of the first digital video; automatically generating a first thumbnail image associated with the first digital video, the first thumbnail image including at least a second portion of the first video frame of the first digital video; analyzing the content data of a second one of the plurality of digital videos to associate at least a first portion of a first one of the plurality of video frames of the second digital video with a second automatically-generated content tag, the first video frame of the second digital video being associated with a first time t_1 of the second digital video; automatically generating a second thumbnail image associated with the second digital video, the second thumbnail image including at least a second portion of the first video frame of the second digital video; displaying the first thumbnail image associated with the first digital video, the second thumbnail image associated with the second digital video, or both, on the video display device; responsive to a selection of the first thumbnail image associated with the first digital video, causing the first digital video to be played on the video display device starting at the first time t_1 of the first digital video; and responsive to a selection of the second thumbnail image associated with the second digital video, causing the second digital video to be played on the video display device starting at the first time t_1 of the second digital video.

Alternative Implementation 29.

The method according to alternative implementation 28, wherein the first digital video is paused at the first time t_1 responsive to an input received via a user interface.

Alternative Implementation 30.

The method according to alternative implementation 28, wherein the first time t_1 associated with the first video frame of the first digital video is subsequent to an initial time t_0 associated with the initial video frame of the first digital video.

Alternative Implementation 31.

A computer-implemented method for organizing a plurality of digital videos, each of the plurality of digital videos having content data and metadata, the content data including a plurality of video frames, the method comprising: analyzing the content data of a first one of the plurality of digital videos to associate at least a first portion of a first one of the plurality of video frames of the first digital video with a first automatically-generated content tag, the first video frame of the first digital video being associated with a first time t_1 of the first digital video; automatically generating a first thumbnail image associated with the first digital video, the first thumbnail image including at least a second portion of the

52

first video frame of the first digital video; analyzing the content data of a second one of the plurality of digital videos to associate at least a first portion of a first one of the plurality of video frames of the second digital video with a second automatically-generated content tag, the first video frame of the second digital video being associated with a first time t_1 of the second digital video; automatically generating a second thumbnail image associated with the second digital video, the second thumbnail image including at least a second portion of the first video frame of the second digital video; displaying the first thumbnail image associated with the first digital video, the second thumbnail image associated with the second digital video, or both, on the video display device; responsive to a selection of the first thumbnail image associated with the first digital video, causing the first digital video to be played on the video display device starting at the first time t_1 of the first digital video; and responsive to a selection of the second thumbnail image associated with the second digital video, causing the second digital video to be played on the video display device starting at the first time t_1 of the second digital video.

Alternative Implementation 32.

The method according to alternative implementation 31, wherein the first time t_1 associated with the first video frame of the plurality of video frames of the first digital video is subsequent to an initial time t_0 associated with an initial video frame of the plurality of video frames of the first digital video.

Alternative Implementation 33.

A computer-implemented method comprising: storing, in a file repository, a plurality of digital photographs; causing a first one of the plurality of digital photograph to be displayed on a video display device; responsive to receiving an indication that a user desires to digitally link the first digital photograph with another one of the plurality of photographs, prompting the user to select one of the plurality of digital photographs to be digitally linked to the first digital photograph; responsive to the user selecting a second one of the plurality of digital photographs, digitally linking the first digital photograph with the second digital photograph; subsequent to the first digital photograph being digitally linked with the second digital photograph, causing the first digital photograph to be displayed on the display device along with an associated user-selectable flipping element; and responsive to receiving a selection of the displayed user-selectable flipping element, causing the first digital photograph to be digitally flipped such that the second digital photograph is displayed on the video display device and the first digital photograph is not displayed on the video display device.

Alternative Implementation 34.

The method according to alternative implementation 33, wherein the receiving the indication that the user desires to digitally link the first digital photograph with another one of the plurality of photographs includes (i) displaying thumbnail images of one or more of the plurality of digital photographs on the video display device.

Alternative Implementation 35.

The method according to alternative implementation 34, wherein the selecting the second digital photograph includes receiving a selection of a thumbnail image of the second digital photograph.

Alternative Implementation 36.

The method according to alternative implementation 33, wherein during a portion of the digital flipping of the first digital photograph, a portion of the first digital photograph and a portion of the second digital photograph are both displayed on the video display device at the same time.

53

Alternative Implementation 37.

The method according to alternative implementation 33, wherein the first digital photograph and the second digital photograph include metadata.

Alternative Implementation 38.

The method according to alternative implementation 37, further comprising, responsive to causing the first digital photograph to be digitally linked to the second digital photograph, modifying the metadata of the first digital photograph to include information associated with the second digital photograph.

Alternative Implementation 39.

The method according to alternative implementation 38, wherein the information associated with the second digital photograph includes a file name of the second digital photograph.

Alternative Implementation 40.

A computer-implemented method for digitally linking a first digital photograph and a second digital photograph, the method comprising: storing, in a file repository, a plurality of digital photographs, the plurality of digital photographs including the first digital photograph and the second digital photograph; causing the first digital photograph to be displayed on a video display device; responsive to receiving a linking input indicative of a desire to link the first digital photograph and the second digital photograph, causing the first digital photograph to be digitally linked to the second digital photograph; causing a first user-selectable flipping element and the first digital photograph to be displayed on the video display device; and responsive to receiving a selection of the first user-selectable flipping element, digitally flipping, on the display device, the first digital photograph such that subsequent to the digitally flipping, the second digital photograph is displayed on the video display device and the first digital photograph is not displayed on the video display device.

Alternative Implementation 41.

The method according to alternative implementation 40, wherein the receiving the linking input indicative of the desire to link the first digital photograph and the second digital photograph includes (i) displaying thumbnail images of one or more of the plurality of digital photographs on the video display device, including a thumbnail image of the second digital photograph and (ii) receiving a selection of the thumbnail image of the second digital photograph.

Alternative Implementation 42.

The method according to alternative implementation 40, wherein the digital flipping, on the display device, of the first digital photograph causes a second user-selectable flipping element to be displayed on the video display device with the second digital photograph.

Alternative Implementation 43.

The method according to alternative implementation 42, further comprising responsive to receiving, via the user input device, a selection of the second user-selectable flipping element, digitally flipping, on the display device, the second digital photograph such that the first digital photograph and the first user-selectable flipping element are displayed on the video display device and the second digital photograph is not displayed on the video display device.

Alternative Implementation 44.

The method according to alternative implementation 40, wherein during a portion of the digital flipping of the first digital photograph, a portion of the first digital photograph and a portion of the second digital photograph are both displayed on the video display device at the same time.

54

Alternative Implementation 45.

The method according to alternative implementation 40, wherein during a portion of the digital flipping of the first digital photograph, a portion of the second digital photograph is visually overlaid on a portion of the first digital photograph.

Alternative Implementation 46.

The method according to alternative implementation 40, wherein the first digital photograph and the second digital photograph include metadata.

Alternative Implementation 47.

The method according to alternative implementation 46, further comprising responsive to causing the first digital photograph to be digitally linked to the second digital photograph, modifying the metadata of the first digital photograph to include information associated with the second digital photograph.

Alternative Implementation 48.

The method according to alternative implementation 47, wherein the information associated with the second digital photograph includes a file name of the second digital photograph.

Alternative Implementation 49.

The method according to alternative implementation 48, further comprising responsive to receiving a request to export the first digital photograph to a remote device, causing the first digital photograph, including the metadata including the file name of the second digital photograph, to be exported to the remote device.

Alternative Implementation 50.

The method according to alternative implementation 40, further comprising responsive to receiving a request to export the first digital photograph to a remote device, causing the first digital photograph and the digitally linked second digital photograph to be exported to the remote device.

Alternative Implementation 51.

The method according to alternative implementation 40, wherein the displaying the first digital photograph includes displaying a location tag associated with a location where the first digital photograph was generated, a date tag associated with the date when the first digital photograph was generated, a person tag associated with a person in the first digital photograph, or any combination thereof.

Alternative Implementation 52.

The method according to alternative implementation 51, wherein the location tag, the date tag, and the person tag are displayed on the video display device (i) during the digital flipping of the first digital photograph and (ii) subsequent to the digital flipping of the first digital photograph.

Alternative Implementation 53.

The method according to alternative implementation 40, wherein the first digital photograph is a scanned image of a first side of a physical photograph.

Alternative Implementation 54.

The method according to alternative implementation 53, wherein the second digital photograph is a scanned image of a second opposing side of the physical photograph.

Alternative Implementation 55.

The method according to alternative implementation 40, wherein a person is pictured in the first digital photograph and a likeness of the person is pictured in the second digital photograph, wherein the likeness of the person in the second digital photograph is generated from the first digital photograph.

55

Alternative Implementation 56.

The method according to alternative implementation 55, wherein the likeness of the person in the second digital photograph includes an outline of the person in the first digital photograph.

Alternative Implementation 57.

The method according to alternative implementation 55, wherein a unique identifier associated with a name of the person is at least partially overlaid on the likeness of the person in the second digital photograph.

Alternative Implementation 58.

The method according to alternative implementation 57, wherein a table including the unique identifier and the associated name of the person is displayed on the video display device.

Alternative Implementation 59.

A method for training a regression algorithm for use in comparing one or more facial features of a first person with one or more corresponding facial features of a second person, the method comprising: analyzing a first digital photograph of the first person to determine a first set of facial feature data for a first facial feature of a face of the first person, the first set of facial feature data including a pose of the face in the first digital photograph, an area of the face in the first digital photograph, and one or more landmarks for the first facial feature in the first digital photograph; determining, based at least in part on the first set of facial feature data, a second set of facial feature data for the first facial feature of the face; analyzing a second digital photograph of the first person to determine a third set of facial feature data for the first facial feature of the face of the first person, the third set of facial feature data including a pose of the face in the second digital photograph, an area of the face in the second digital photograph, and one or more landmarks for the first facial feature of the face in the second digital photograph; determining, based at least in part on the third set of facial feature data, a fourth set of facial feature data for the first facial feature of the face; and determining a regression model for the first facial feature of the first person based on the first set of facial feature data, the second set of facial feature data, the third set of facial feature data, and the fourth set of facial feature data, wherein inputting facial feature data associated with a corresponding first facial feature of the second person into the regression model results in an output value that is indicative of a similarity between the first facial feature of the first person and the corresponding first facial feature of the second person.

Alternative Implementation 60.

The method according to alternative implementation 59, wherein the second set of facial feature data includes a relative width of the first facial feature, a relative height of the first facial feature, a relative distance between a first landmark for the first facial feature and a landmark for a second facial feature of the face of the first person, or any combination thereof

Alternative Implementation 61.

The method according to alternative implementation 60, wherein the first facial feature of the face of the first person is an eye, the one or more landmarks of the first set of facial feature data includes a left eye landmark, an upper eye landmark, a right eye landmark, and a lower eye landmark.

Alternative Implementation 62.

The method according to alternative implementation 61, wherein the relative height of the first facial feature is a proportion of a distance between the lower eye landmark and the upper eye landmark and a height of a bounding box surrounding the face of the first person.

56

Alternative Implementation 63.

The method according to alternative implementation 61, wherein the relative width of the first facial feature is a proportion of a distance between the left eye landmark and the right eye landmark and a width of a bounding box surrounding the face of the first person.

Alternative Implementation 64.

The method according to alternative implementation 61, wherein the determining the second set of facial feature data includes determining a bounding box for the eye based the left eye landmark, the upper eye landmark, the right eye landmark, and the lower eye landmark.

Alternative Implementation 65.

The method according to alternative implementation 64, wherein the second set of facial feature data includes a color of the eye.

Alternative Implementation 66.

The method according to alternative implementation 59, wherein the pose of the face includes a yaw angle, a pitch angle, and a roll angle.

Alternative Implementation 67.

The method according to alternative implementation 59, wherein the first facial feature of the face of the first person is a nose, a left eye, a right eye, a mouth, an eyebrow, a jawline, or an ear.

Alternative Implementation 68.

The method according to alternative implementation 59, wherein the regression model is a logistic algorithm regression, a neural network algorithm regression, a deep learning algorithm regression, or any combination thereof

Alternative Implementation 69.

The method according to alternative implementation 59, wherein the output value of the regression model is between 0 and 1.

Alternative Implementation 70.

The method according to alternative implementation 59, wherein the first set of facial feature data includes a gender of the first person.

Alternative Implementation 71.

A computer-implemented method for comparing one or more facial features of a plurality of persons and displaying the results, the method comprising: receiving, via a user input device, a selection of a first person, the first person being associated with a regression model stored in a photo repository, the regression model being associated with a first facial feature of the first person; responsive to receiving an input indicative of a desire to compare the first person with a second person, causing facial feature data associated with a corresponding first facial feature of the second person to be inputted into the regression model to obtain an output value from the regression model indicative of a similarity between the first facial feature of the first person and the corresponding first facial feature of the second person; and displaying, on a video display device, (i) a first thumbnail image including at least a portion of a digital photograph of the second person and (ii) an indicium indicative of the similarity between the first facial feature of the first person and the corresponding first facial feature of the second person.

Alternative Implementation 72.

The method according to alternative implementation 71, wherein the portion of the digital photograph of the second person includes the corresponding first facial feature of the second person.

Alternative Implementation 73.

The method according to alternative implementation 71, wherein the first facial feature of the first person and the

57

corresponding first facial feature of the second person is a nose, a mouth, an eye, an eyebrow, a jawline, or an ear.

Alternative Implementation 74.

The method according to alternative implementation 71, wherein the output value of the regression model is between 0 and 1.

Alternative Implementation 75.

The method according to alternative implementation 71, wherein the indicium indicative of the similarity between the first facial feature of the first person and the corresponding first facial feature of the second person is a percentage.

Alternative Implementation 76.

The method according to alternative implementation 71, wherein the displaying includes displaying a second indicium indicative of a relationship between the first person and the second person.

Alternative Implementation 77.

The method according to alternative implementation 76, wherein the relationship between the first person and the second person is a familial relationship.

Alternative Implementation 78.

The method according to alternative implementation 71, wherein the first facial feature of the first person and the corresponding first facial feature of the second person are a person feature, wherein the person feature is a combination of a plurality of facial features.

Alternative Implementation 79.

The method according to alternative implementation 78, wherein the plurality of facial features includes a nose, a mouth, an eye, an eyebrow, a jawline, or any combination thereof.

Alternative Implementation 80.

The method according to alternative implementation 71, further comprising responsive to receiving a selection of the first thumbnail image, displaying, on the video display device, the digital photograph of the second person, a digital photograph of the first person, and the indicium indicative of the similarity between the first facial feature of the first person and the corresponding first facial feature of the second person.

Alternative Implementation 81.

A computer-implemented method for comparing one or more facial features of a plurality of persons and displaying the results, the method comprising: receiving, via a user input device, a selection of a first person, the first person being associated with a first regression model is stored in a photo repository, the first regression model being associated with a first facial feature of the first person; responsive to receiving an input indicative of a desire to compare the first person to a plurality of other persons, causing facial feature data associated with each of the plurality of other persons to be inputted into the first regression model to obtain a first output value indicative of a similarity between the first facial feature of the first person and a corresponding first facial feature of each of the plurality of other persons; and responsive to determining that the first output value for at least one of the plurality of other persons is greater than a predetermined threshold, displaying, on a video display device, a thumbnail image including at least a portion of a digital photograph of the at least one of the plurality of other persons and an indicium indicative of the similarity between the first facial feature of the first person and the corresponding first facial feature of the at least one of the plurality of other persons.

Alternative Implementation 82.

The method according to alternative implementation 80, wherein the first person is associated with a second regres-

58

sion model stored in the photo repository, the second regression model being associated with a first facial feature of the first person.

Alternative Implementation 83.

The method according to alternative implementation 82, further comprising responsive to receiving the input indicative of the desire to compare the first person to the plurality of other persons, causing facial feature data associated with each of the plurality of other persons to be inputted into the second regression model to obtain a second output value indicative of a similarity between the second facial feature of the first person and a corresponding second facial feature of each of the plurality of other persons; and responsive to determining that the second output value for at least one of the plurality of other persons is greater than a predetermined threshold, displaying, on the video display device, a second thumbnail image including at least a portion of a digital photograph of the at least one of the plurality of other persons and a second indicium indicative of the similarity between the second facial feature of the first person and the corresponding second facial feature of the at least one of the plurality of other persons.

Alternative Implementation 84.

The method according to alternative implementation 80, wherein the at least one of the plurality of other persons includes a second person and a third person and the displaying includes displaying a first thumbnail image including at least a portion of a digital photograph of the second person, a first indicium indicative of the similarity between the first facial feature of the first person and the corresponding first facial feature of the second person, a second thumbnail image including at least a portion of a digital photograph of the third person, and a second indicium indicative of the similarity between the first facial feature of the first person and the corresponding first facial feature of the second person.

Alternative Implementation 85.

The method according to alternative implementation 84, further comprising responsive to receiving a selection of the first thumbnail image, displaying a digital photograph of the first person, the digital photograph of the second person, and the first indicium on the video display device.

Alternative Implementation 86.

The method according to alternative implementation 85, further comprising displaying a navigation element along with the digital photograph of the first person, the digital photograph of the second person, and the first indicium on the video display device; and responsive to a selection of the navigation element, displaying the digital photograph of the first person, the digital photograph of the third person, and the second indicium on the video display device.

Alternative Implementation 87.

The method according to alternative implementation 81, wherein the first person and the plurality of other persons are associated with one another in the photo repository by a relationship.

Alternative Implementation 88.

The method according to alternative implementation 87, wherein the relationship is a familial relationship.

Alternative Implementation 89.

A computer-implemented method for comparing one or more facial features of a plurality of persons, the method comprising: receiving, via a user input device, a selection of a first person, the first person being associated with a first regression model is stored in a photo repository, the first regression model being associated with a first facial feature of the first person; responsive to receiving an input indica-

tive of a desire to compare the first person with a plurality of other persons, importing at least one photograph of each of the plurality of other persons from an external system, each of the plurality of other persons being associated with one another by a predetermined relationship; causing facial feature data associated with a corresponding first facial feature of each of the plurality of other persons to be inputted into the regression model to obtain an output value from the regression model indicative of a similarity between the first facial feature of the first person and the corresponding first facial each of the plurality of other persons; and responsive to determining that the first output value for at least one of the plurality of other persons is greater than a predetermined threshold, displaying, on a video display device, a thumbnail image including at least a portion of a digital photograph of the at least one of the plurality of other persons and an indicium indicative of the similarity between the first facial feature of the first person and the corresponding first facial feature of the at least one of the plurality of other persons.

Alternative Implementation 90.

The method according to alternative implementation 89, wherein the predetermined relationship is a familial relationship.

Alternative Implementation 91.

A computer-implemented method for comparing one or more facial features of a plurality of persons, the method comprising: responsive to receiving an input indicative of a desire to compare a first person with a plurality of other persons, importing, from an external system, a first digital photograph of the first person and a first regression model for a first facial feature for the first person; inputting facial feature data associated with a corresponding first facial feature of each of the plurality of other persons into first the regression model to obtain an output value from the regression model indicative of a similarity between the first facial feature of the first person and the corresponding first facial each of the plurality of other persons; and responsive to determining that the output value for at least one of the plurality of other persons is greater than a predetermined threshold, displaying, on a video display device, a thumbnail image including at least a portion of a digital photograph of the at least one of the plurality of other persons and an indicium indicative of the similarity between the first facial feature of the first person and the corresponding first facial feature of the at least one of the plurality of other persons.

One or more elements or aspects or steps, or any portion(s) thereof, from one or more of any of the Alternative Implementations 1-91 above can be combined with one or more elements or aspects or steps, or any portion(s) thereof, from one or more of any of the other Alternative Implementations 1-91, or combinations thereof, to form one or more additional alternative implementations of the present disclosure.

While the present disclosure has been described with reference to one or more particular embodiments or implementations, those skilled in the art will recognize that many changes may be made thereto without departing from the spirit and scope of the present disclosure. Each of these embodiments or implementations and obvious variations thereof is contemplated as falling within the spirit and scope of the present disclosure. It is also contemplated that additional embodiments implementations according to aspects of the present disclosure may combine any number of features from any of the embodiments described herein.

What is claimed is:

1. A computer-implemented method comprising:
 - storing, in a file repository, a plurality of digital photographs;
 - causing a first one of the plurality of digital photographs to be displayed on a video display device, a person being pictured in the first digital photograph;
 - in response to receiving an input from a user, causing a second digital photograph to be generated including a likeness of the person pictured in the first digital photograph, the likeness of the person including an outline of at least a portion of the person in the first digital photograph;
 - digitally linking the first digital photograph with the second digital photograph;
 - subsequent to the first digital photograph being digitally linked with the second digital photograph, causing the first digital photograph to be displayed on the display device along with an associated user-selectable flipping element; and
 - responsive to receiving a selection of the displayed user-selectable flipping element, causing the first digital photograph to be digitally flipped such that the second digital photograph is displayed on the video display device and the first digital photograph is not displayed on the video display device.
2. The method of claim 1, wherein the digitally linking the first digital photograph with the second digital photograph occurs automatically.
3. The method of claim 1, wherein the digitally linking the first digital photograph with the second digital photograph includes receiving a linking input from the user indicative of a desire to link the first digital photograph and the second digital photograph.
4. The method of claim 3, wherein the receiving the linking input indicative of the desire to link the first digital photograph and the second digital photograph includes (i) displaying thumbnail images of one or more of the plurality of digital photographs on the video display device, including a thumbnail image of the second digital photograph and (ii) receiving a selection of the thumbnail image of the second digital photograph.
5. The method of claim 1, wherein during a portion of the digital flipping of the first digital photograph, a portion of the first digital photograph and a portion of the second digital photograph are both displayed on the video display device at the same time.
6. The method of claim 1, wherein during a portion of the digital flipping of the first digital photograph, a portion of the second digital photograph is visually overlaid on a portion of the first digital photograph.
7. The method of claim 1, wherein the digital flipping, on the display device, of the first digital photograph causes a second user-selectable flipping element to be displayed on the video display device with the second digital photograph.
8. The method of claim 7, further comprising responsive to receiving a selection of the second user-selectable flipping element, digitally flipping, on the display device, the second digital photograph such that the first digital photograph and the associated user-selectable flipping element are displayed on the video display device and the second digital photograph is not displayed on the video display device.
9. The method of claim 1, further comprising, responsive to causing the first digital photograph to be digitally linked to the second digital photograph, modifying metadata of the first digital photograph to include information associated with the second digital photograph.

61

10. The method of claim 9, wherein the information associated with the second digital photograph includes a file name of the second digital photograph.

11. The method of claim 1, further comprising responsive to receiving a request to export the first digital photograph to a remote device, causing the first digital photograph and the digitally linked second digital photograph to be exported to the remote device.

12. The method of claim 1, wherein the displaying the first digital photograph includes displaying a location tag associated with a location where the first digital photograph was generated, a date tag associated with the date when the first digital photograph was generated, a person tag associated with the person in the first digital photograph, or any combination thereof.

13. The method of claim 12, wherein the location tag, the date tag, and the person tag are displayed on the video display device (i) during the digital flipping of the first digital photograph and (ii) subsequent to the digital flipping of the first digital photograph.

14. The method of claim 1, wherein the generated second digital photograph further includes a unique identifier associated with a name of the person, the unique identifier being at least partially overlaid on the likeness of the person in the second digital photograph.

15. The method of claim 14, further comprising, subsequent to the first digital photograph being digitally linked with the second digital photograph, causing the first digital photograph to be displayed on the display device along with a table including the unique identifier and the associated name of the person.

16. A system comprising:

a video display device;

a memory storing machine-readable instructions; and

one or more processors configured to execute the machine-readable instructions to:

causing a first one of a plurality of digital photographs that are stored in a file repository to be displayed on the video display device, a person being pictured in the first digital photograph;

in response to receiving an input from a user, cause a second digital photograph to be generated including a likeness of the person pictured in the first digital photograph, the likeness of the person including an outline of at least a portion of the person in the first digital photograph;

digitally link the first digital photograph with the second digital photograph;

subsequent to the first digital photograph being digitally linked with the second digital photograph, cause the first digital photograph to be displayed on the display device along with an associated user-selectable flipping element; and

responsive to receiving a selection of the displayed user-selectable flipping element, cause the first digital photograph to be digitally flipped such that the second digital photograph is displayed on the video display device and the first digital photograph is not displayed on the video display device.

17. The system of claim 16, wherein the digitally linking the first digital photograph with the second digital photograph occurs automatically.

18. The system of claim 16, wherein the digitally linking the first digital photograph with the second digital photograph includes receiving, via the video display device, a linking input from the user indicative of a desire to link the first digital photograph and the second digital photograph.

62

19. The system of claim 18, wherein the receiving the linking input includes (i) displaying thumbnail images of one or more of the plurality of digital photographs on the video display device, including a thumbnail image of the second digital photograph and (ii) receiving a selection of the thumbnail image of the second digital photograph.

20. The system of claim 16, wherein during a portion of the digital flipping of the first digital photograph, a portion of the first digital photograph and a portion of the second digital photograph are both displayed on the video display device at the same time.

21. The system of claim 16, wherein during a portion of the digital flipping of the first digital photograph, a portion of the second digital photograph is visually overlaid on a portion of the first digital photograph.

22. The system of claim 16, wherein the digital flipping, on the display device, of the first digital photograph causes a second user-selectable flipping element to be displayed on the video display device with the second digital photograph.

23. The system of claim 16, wherein the one or more processors are further configured to, in response to receiving a selection of the second user-selectable flipping element, digitally flip, on the video display device, the second digital photograph such that the first digital photograph and the associated user-selectable flipping element are displayed on the video display device and the second digital photograph is not displayed on the video display device.

24. The system of claim 16, wherein the one or more processors are configured to, in response to digitally linking the first digital photograph with the second digital photograph, modify metadata of the first digital photograph to include information associated with the second digital photograph.

25. The system of claim 24, wherein the information associated with the second digital photograph includes a file name of the second digital photograph.

26. The system of claim 16, wherein the one or more processors are further configured to cause the first digital photograph and the digitally linked second digital photograph to be exported to a remote device responsive to receiving a request, via the video display device, to export the first digital photograph to the remote device.

27. The system of claim 16, wherein the displaying the first digital photograph includes displaying a location tag associated with a location where the first digital photograph was generated, a date tag associated with the date when the first digital photograph was generated, a person tag associated with the person in the first digital photograph, or any combination thereof.

28. The system of claim 27, wherein the location tag, the date tag, and the person tag are displayed on the video display device (i) during the digital flipping of the first digital photograph and (ii) subsequent to the digital flipping of the first digital photograph.

29. The system of claim 16, wherein the generated second digital photograph further includes a unique identifier associated with a name of the person, the unique identifier being at least partially overlaid on the likeness of the person in the second digital photograph.

30. The system of claim 29, wherein the one or more processors are further configured to, subsequent to the first digital photograph being digitally linked with the second digital photograph, cause the first digital photograph to be displayed on the display device along with a table including the unique identifier and the associated name of the person.

UNITED STATES PATENT AND TRADEMARK OFFICE
CERTIFICATE OF CORRECTION

PATENT NO. : 10,936,178 B2
APPLICATION NO. : 16/719798
DATED : March 2, 2021
INVENTOR(S) : Christopher J. Desmond et al.

Page 1 of 1

It is certified that error appears in the above-identified patent and that said Letters Patent is hereby corrected as shown below:

In the Claims

At Column 60, Line 39 (Claim 4, Line 5), please delete “photographson” and insert --photographs on-- therefor.

Signed and Sealed this
Fourth Day of May, 2021



Drew Hirshfeld
*Performing the Functions and Duties of the
Under Secretary of Commerce for Intellectual Property and
Director of the United States Patent and Trademark Office*