

US010918151B2

(12) **United States Patent**
Mahanty et al.

(10) **Patent No.:** **US 10,918,151 B2**
(45) **Date of Patent:** **Feb. 16, 2021**

(54) **COLLABORATION IN AN APPAREL DESIGN SYSTEM**

(71) Applicant: **Levi Strauss & Co.**, San Francisco, CA (US)

(72) Inventors: **Debdulal Mahanty**, Fremont, CA (US); **Christopher Schultz**, San Francisco, CA (US); **Jennifer Schultz**, San Francisco, CA (US); **Benjamin Bell**, San Francisco, CA (US); **Ozgur Taylan Kuzucu**, Walnut Creek, CA (US)

(73) Assignee: **Levi Strauss & Co.**, San Francisco, CA (US)

(*) Notice: Subject to any disclaimer, the term of this patent is extended or adjusted under 35 U.S.C. 154(b) by 114 days.

(21) Appl. No.: **16/288,038**

(22) Filed: **Feb. 27, 2019**

(65) **Prior Publication Data**

US 2020/0063333 A1 Feb. 27, 2020

Related U.S. Application Data

(60) Provisional application No. 62/636,112, filed on Feb. 27, 2018, provisional application No. 62/636,108, filed on Feb. 27, 2018.

(51) **Int. Cl.**

A41H 43/00 (2006.01)
A41D 1/06 (2006.01)

(Continued)

(52) **U.S. Cl.**

CPC **A41H 43/00** (2013.01); **A41D 1/06** (2013.01); **A41D 27/00** (2013.01); **A41D 27/08** (2013.01); **A41H 3/08** (2013.01); **B23K 26/352** (2015.10); **D03D 1/00** (2013.01); **D06C 23/00** (2013.01); **D06C 23/02** (2013.01); **D06M 10/005** (2013.01); **G05B**

19/4097 (2013.01); **G06F 3/011** (2013.01); **G06F 3/0482** (2013.01); **G06F 3/04845** (2013.01); **G06F 30/00** (2020.01); **G06Q 10/06315** (2013.01); **G06Q 30/0621** (2013.01); **G06Q 30/0643** (2013.01); **G06T 3/005** (2013.01); **G06T 19/006** (2013.01); **G06T 19/20** (2013.01); **A41D 2500/20** (2013.01); **D03D 2700/0174** (2013.01);

(Continued)

(58) **Field of Classification Search**

CPC **A41H 3/007**; **D06C 23/00**; **D06C 23/02**; **D06M 10/005**; **G06F 2113/12**; **G06T 2210/16**
USPC **700/130-132**
See application file for complete search history.

(56) **References Cited**

U.S. PATENT DOCUMENTS

7,657,341 B2 2/2010 Lind
9,971,854 B1* 5/2018 Bowen **G06F 3/0482**
(Continued)

OTHER PUBLICATIONS

International Search Report, PCT Application PCT/US2019/019917, dated Jul. 1, 2019, 3 pages.

Primary Examiner — Nathan E Durham

(74) *Attorney, Agent, or Firm* — Aka Chan LLP

(57) **ABSTRACT**

A system allows a user to create new designs for apparel and preview these designs before manufacture. Software and lasers are used in finishing apparel to produce a desired wear pattern or other design. Users may communicate with other users on how wear patterns should be applied onto base garments and make changes to the wear patterns or other garment features, while sharing with other users their progress.

41 Claims, 27 Drawing Sheets

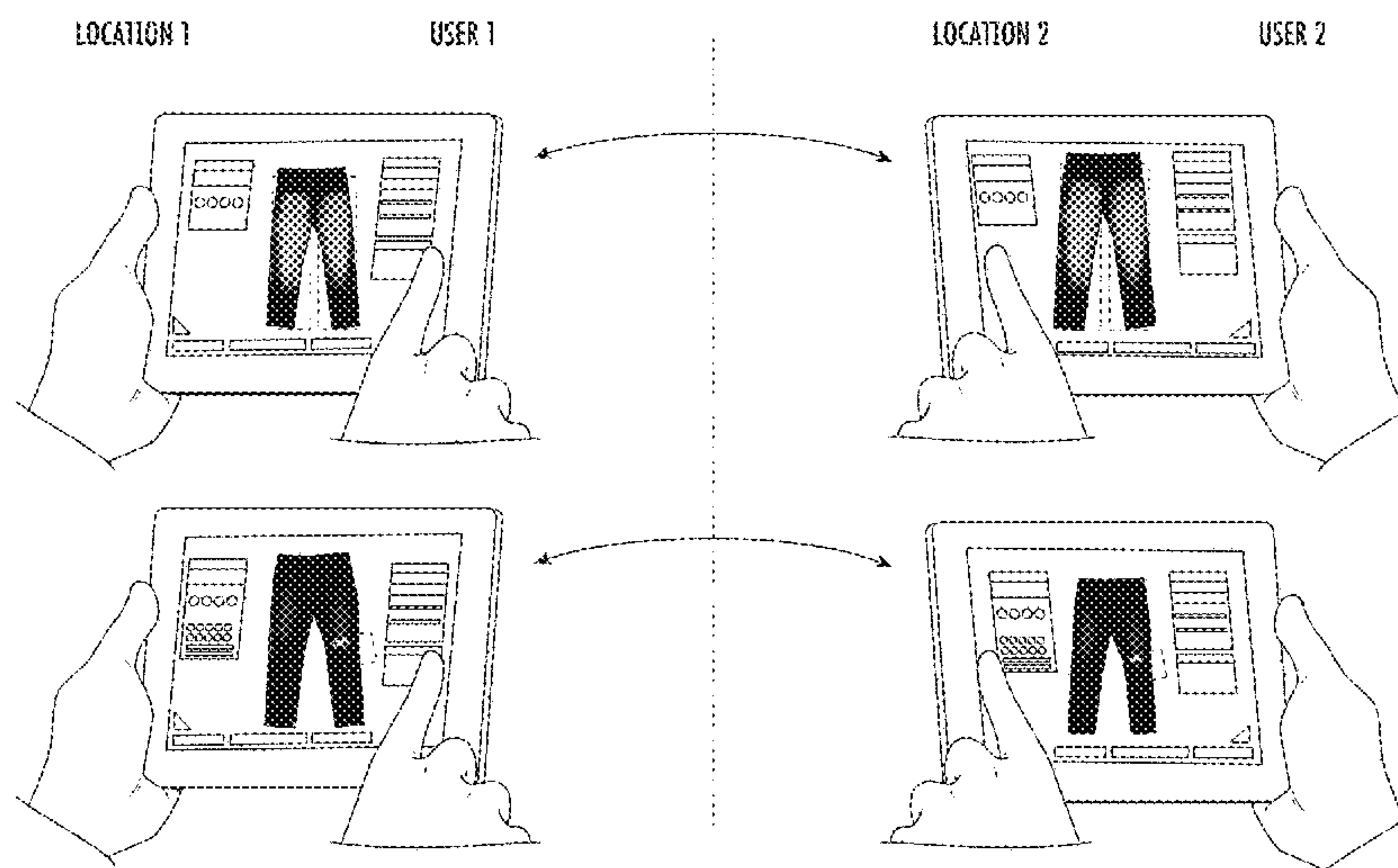

(51) **Int. Cl.**
A41D 27/08 (2006.01)
D03D 1/00 (2006.01)
G06Q 30/06 (2012.01)
G05B 19/4097 (2006.01)
D06C 23/00 (2006.01)
G06Q 10/06 (2012.01)
D06C 23/02 (2006.01)
G06F 30/00 (2020.01)
A41D 27/00 (2006.01)
D06M 10/00 (2006.01)
G06F 3/01 (2006.01)
G06T 19/00 (2011.01)
G06T 19/20 (2011.01)
G06F 3/0482 (2013.01)
G06F 3/0484 (2013.01)
G06T 3/00 (2006.01)
B23K 26/352 (2014.01)

A41H 3/08 (2006.01)
G06F 113/12 (2020.01)
(52) **U.S. Cl.**
CPC *D06C 2700/31* (2013.01); *D10B 2201/02*
(2013.01); *D10B 2501/04* (2013.01); *D10B*
2501/06 (2013.01); *G05B 2219/35008*
(2013.01); *G05B 2219/35012* (2013.01); *G05B*
2219/45222 (2013.01); *G06F 2113/12*
(2020.01); *G06T 2210/16* (2013.01)

(56) **References Cited**

U.S. PATENT DOCUMENTS

2005/0131571 A1 6/2005 Costin
2013/0097234 A1 4/2013 Beinvel et al.
2015/0066189 A1 3/2015 Mulligan et al.
2018/0165737 A1* 6/2018 Love A41H 42/00

* cited by examiner

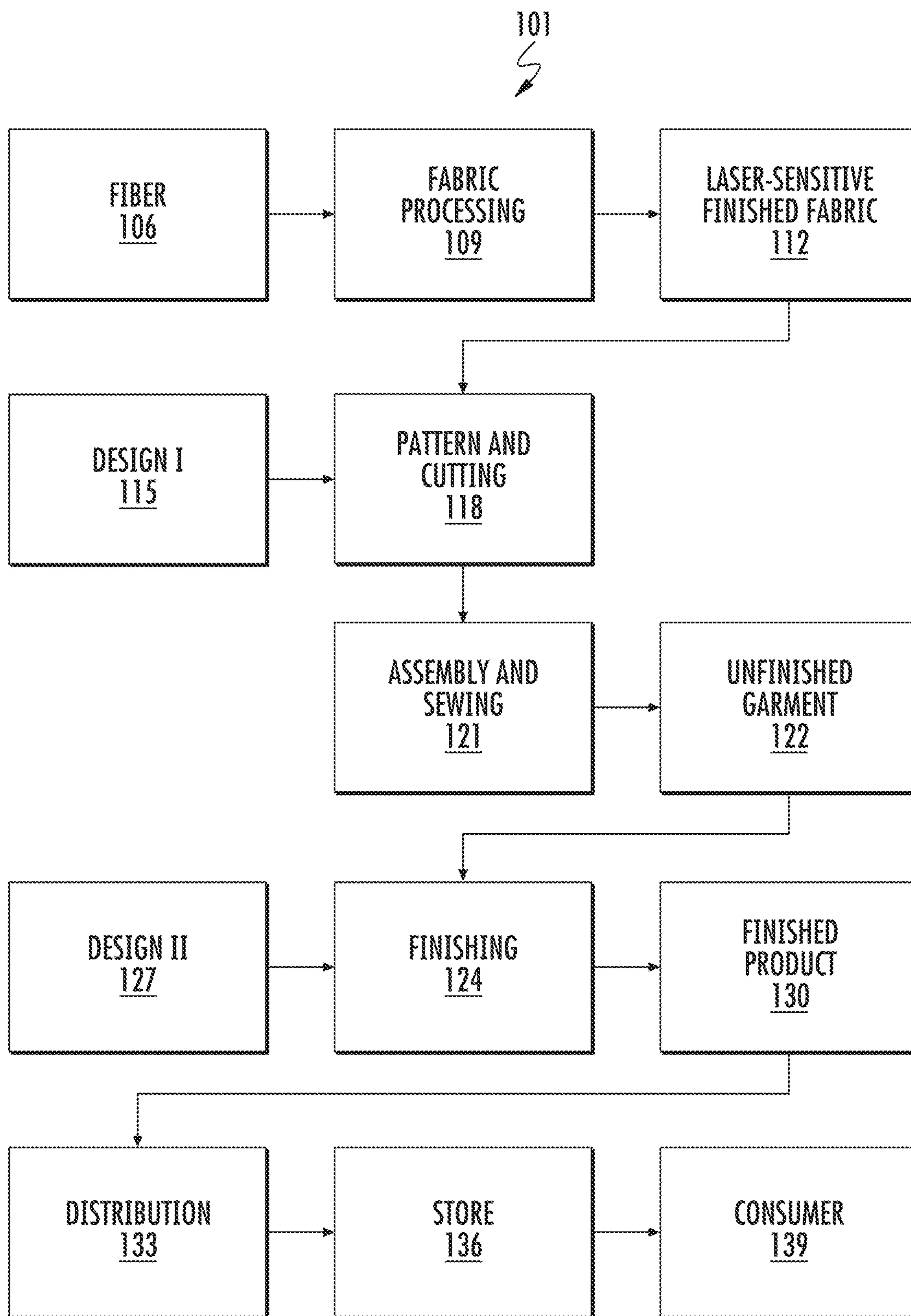

FIG. 1

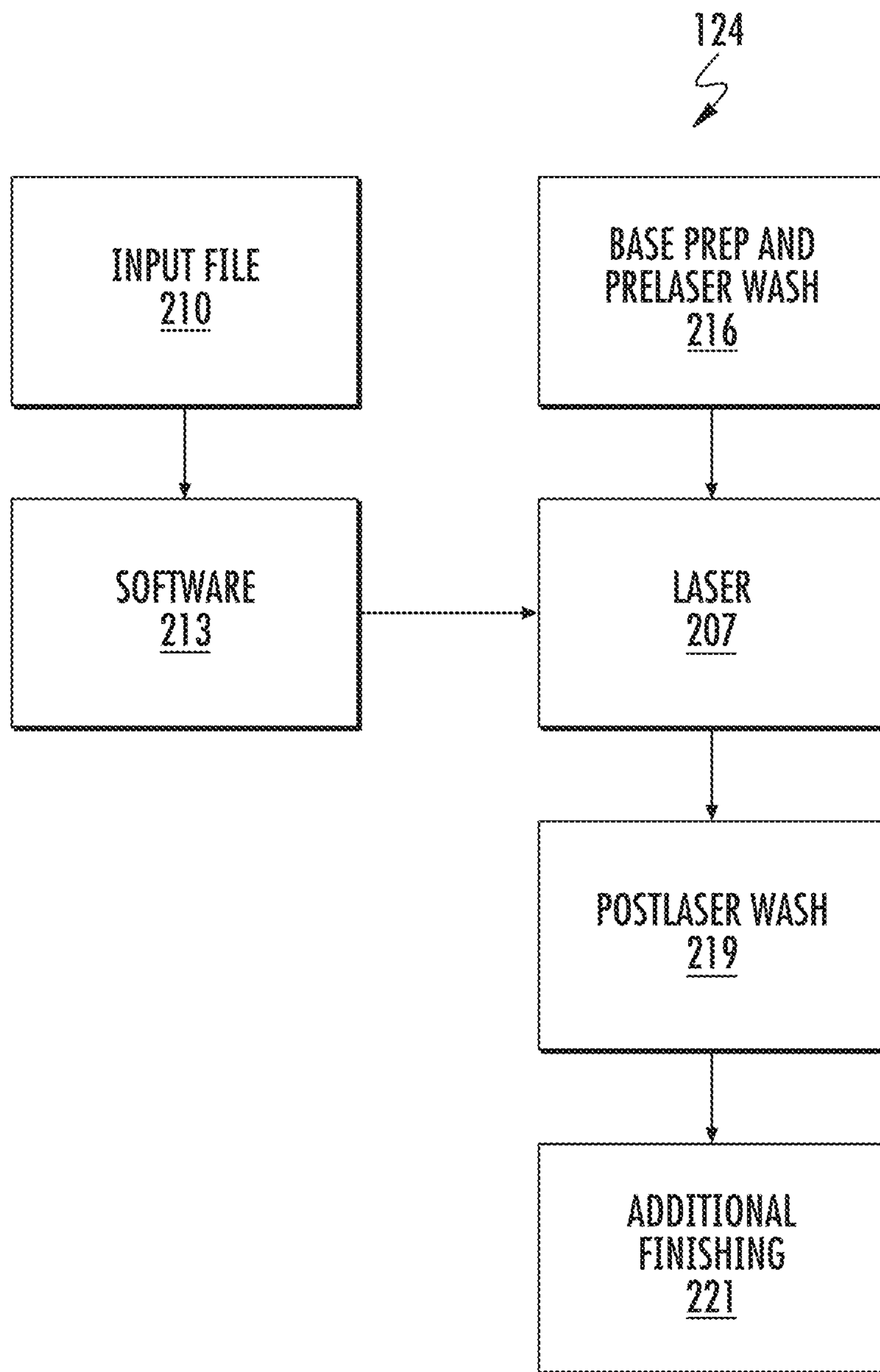

FIG. 2

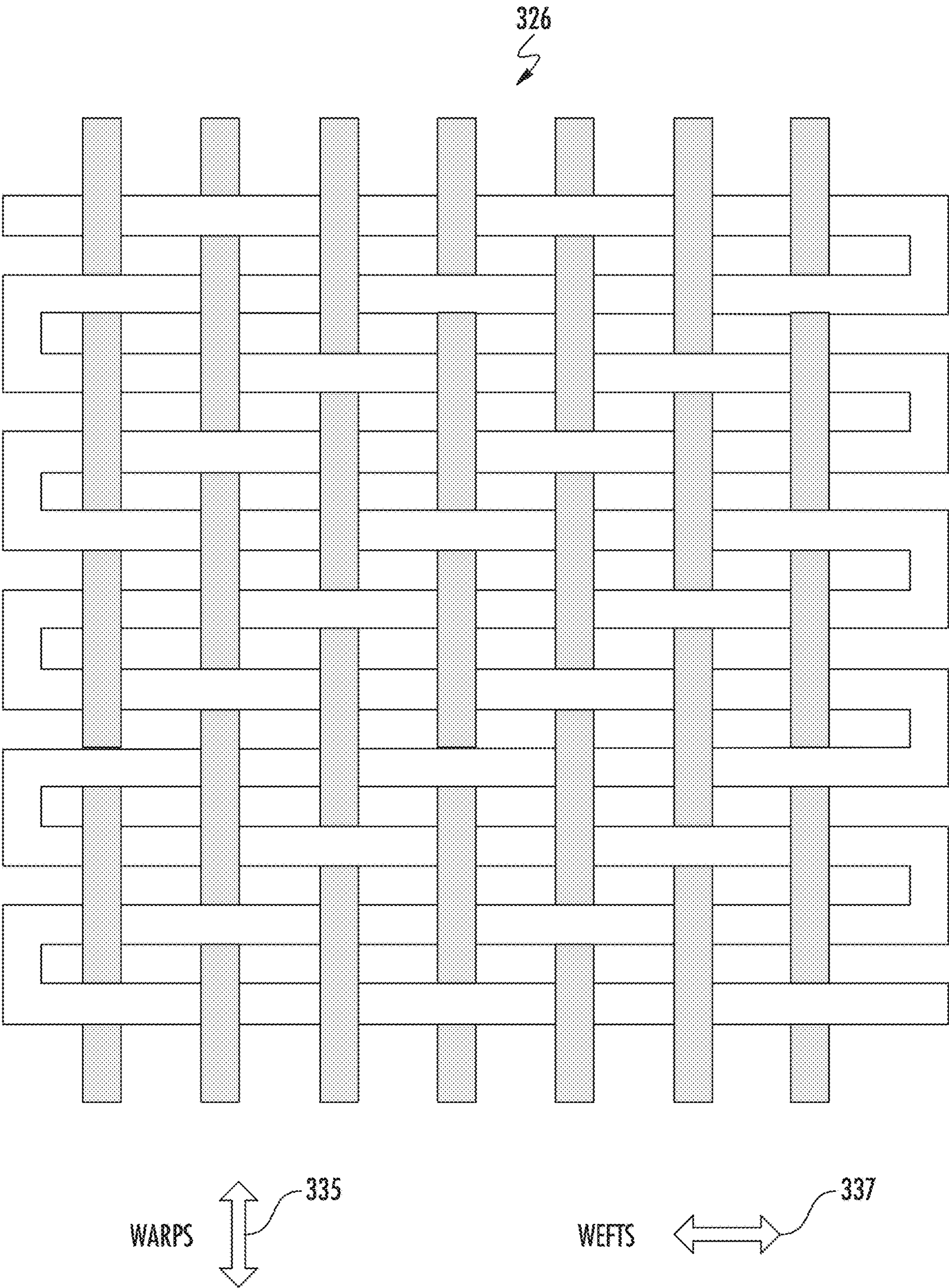

FIG. 3

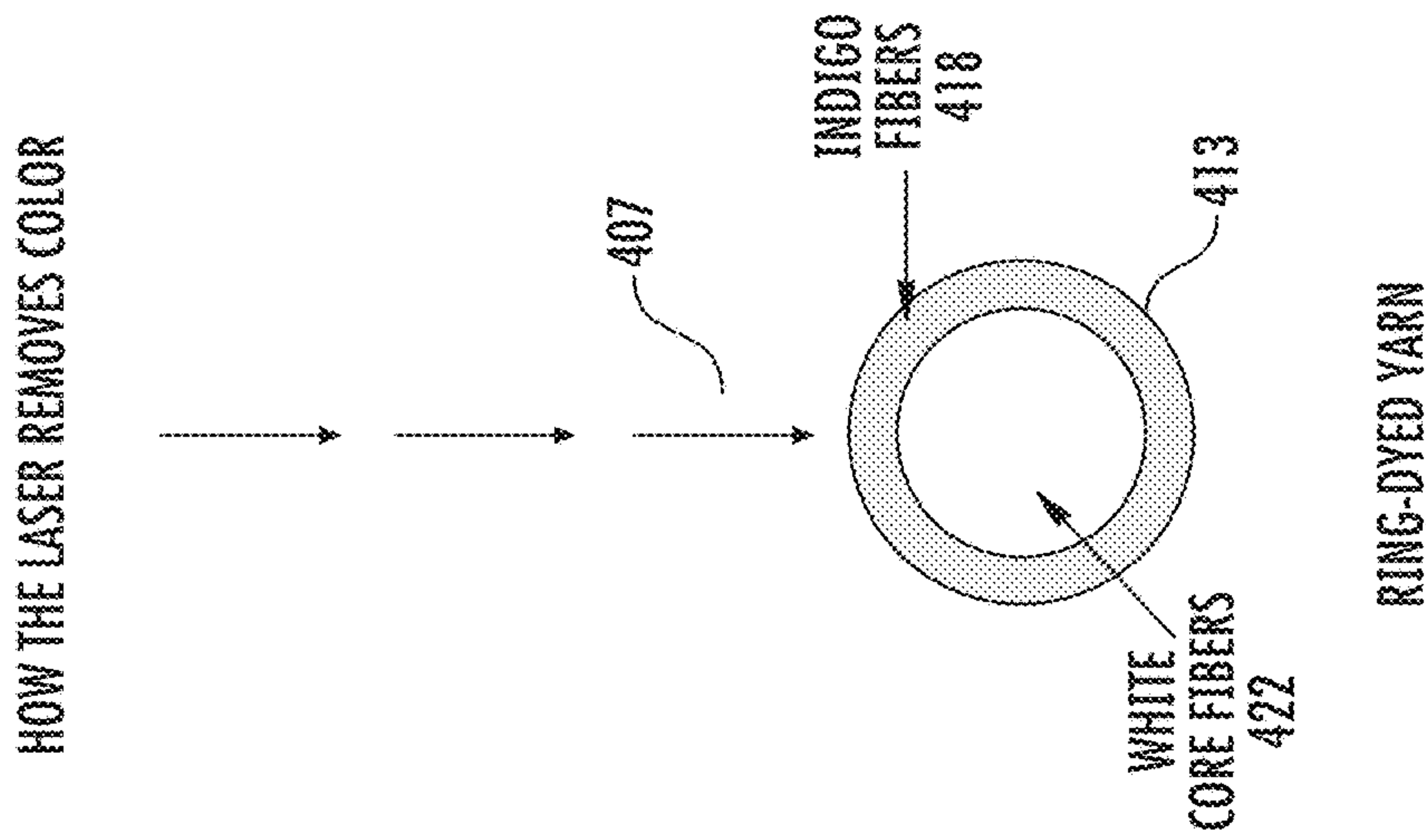

FIG. 4

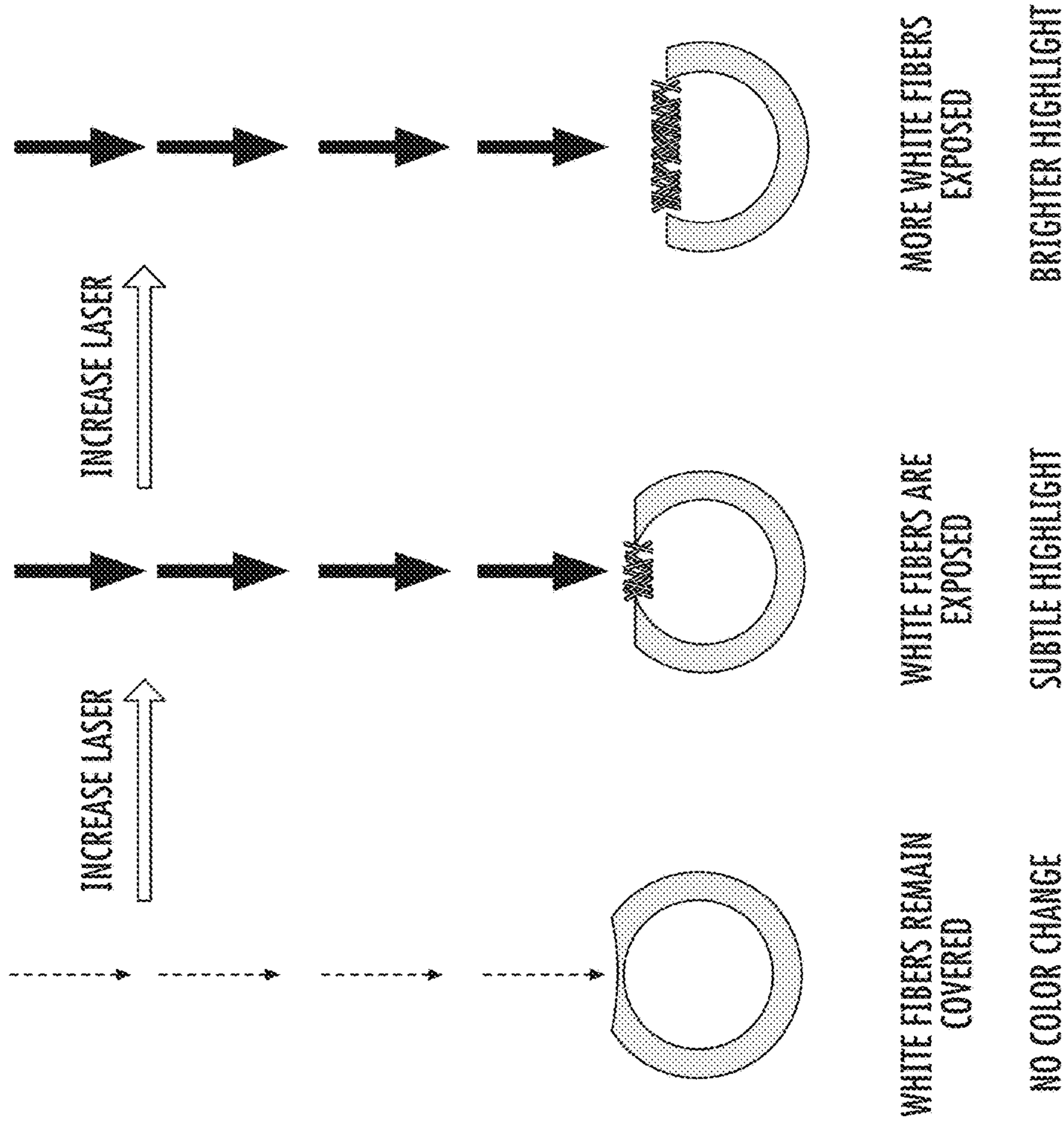

FIG. 5

FIG. 6

FIG. 7

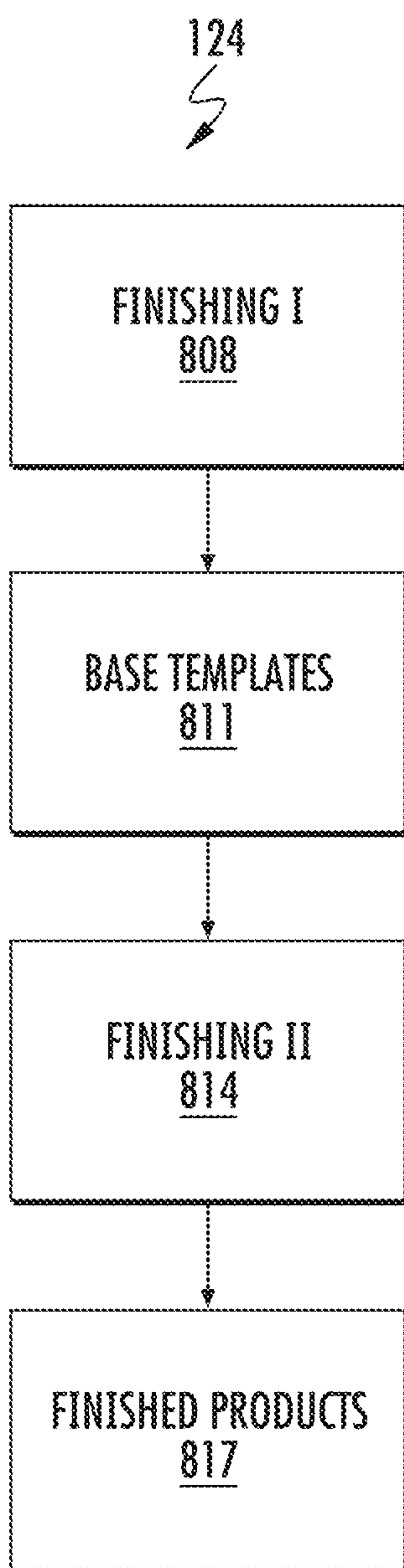

FIG. 8

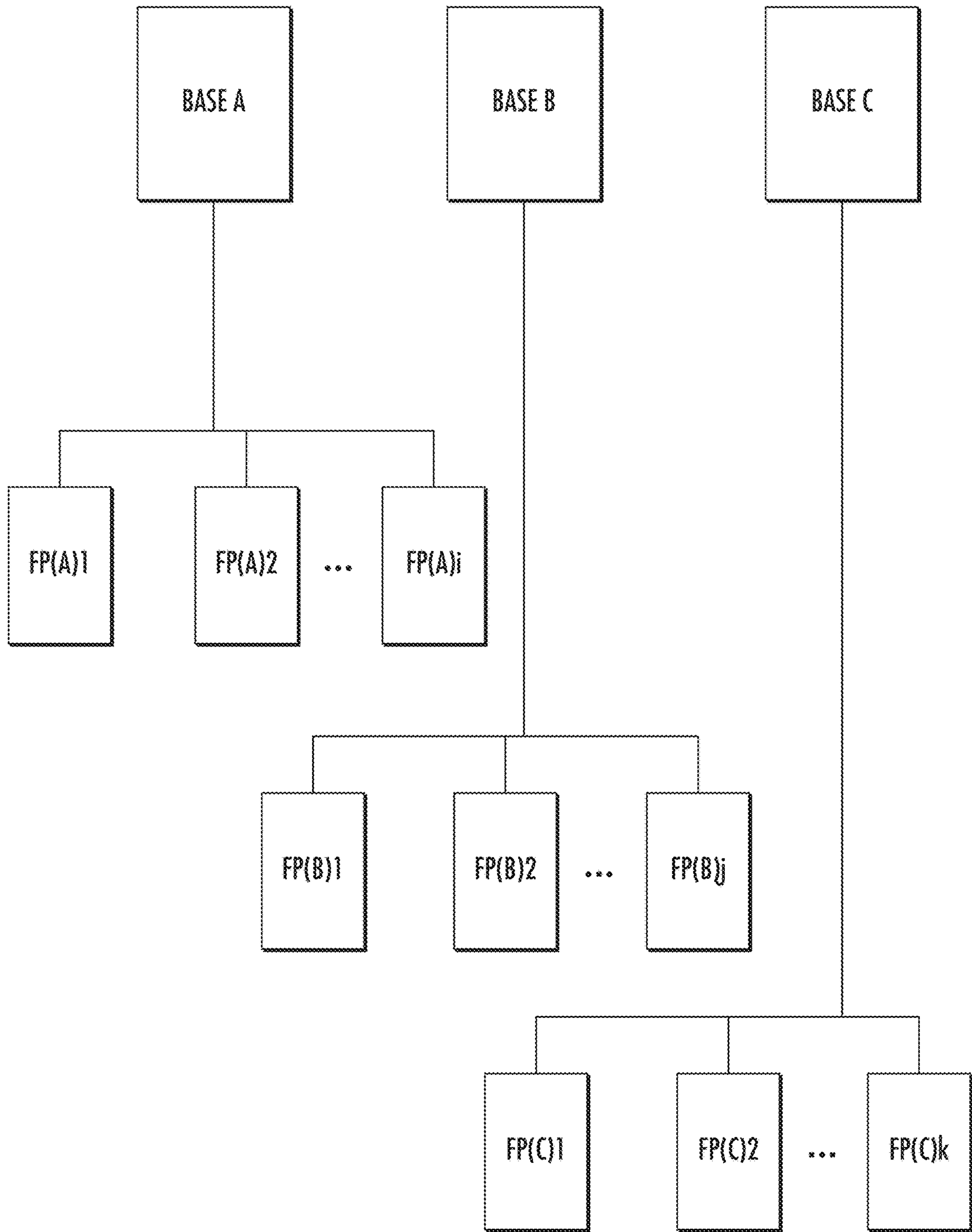

FIG. 9

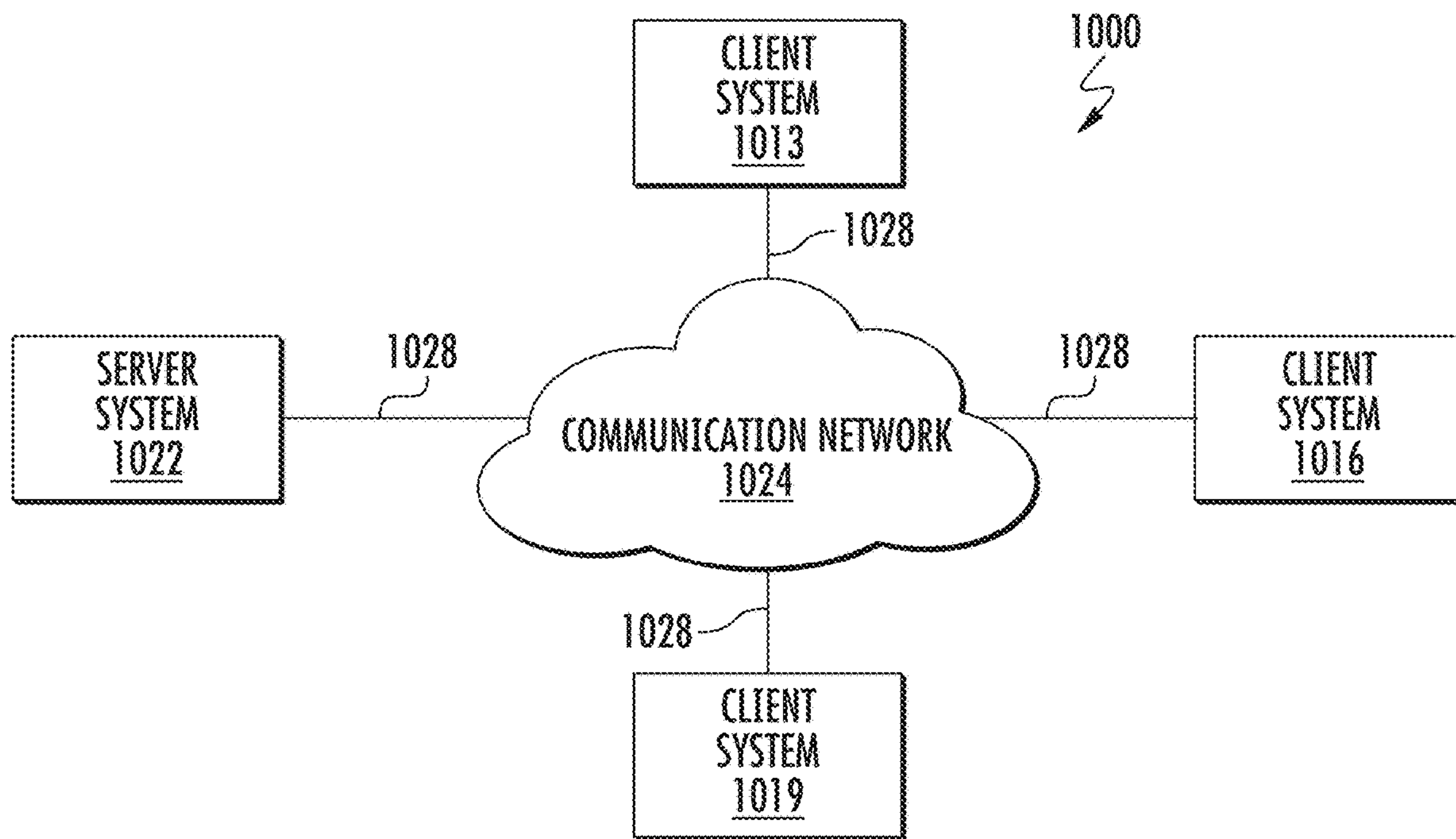

FIG. 10

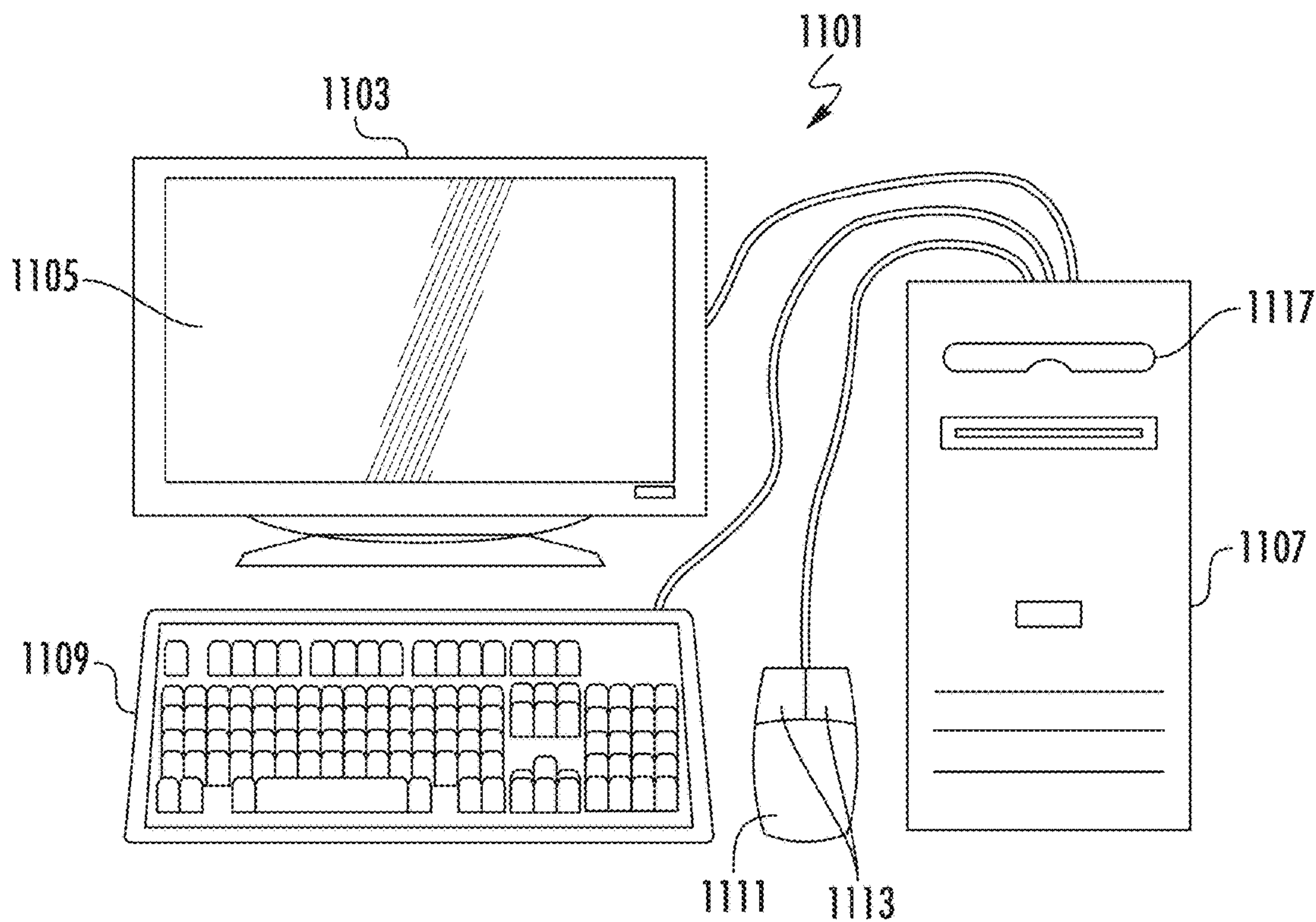

FIG. 11

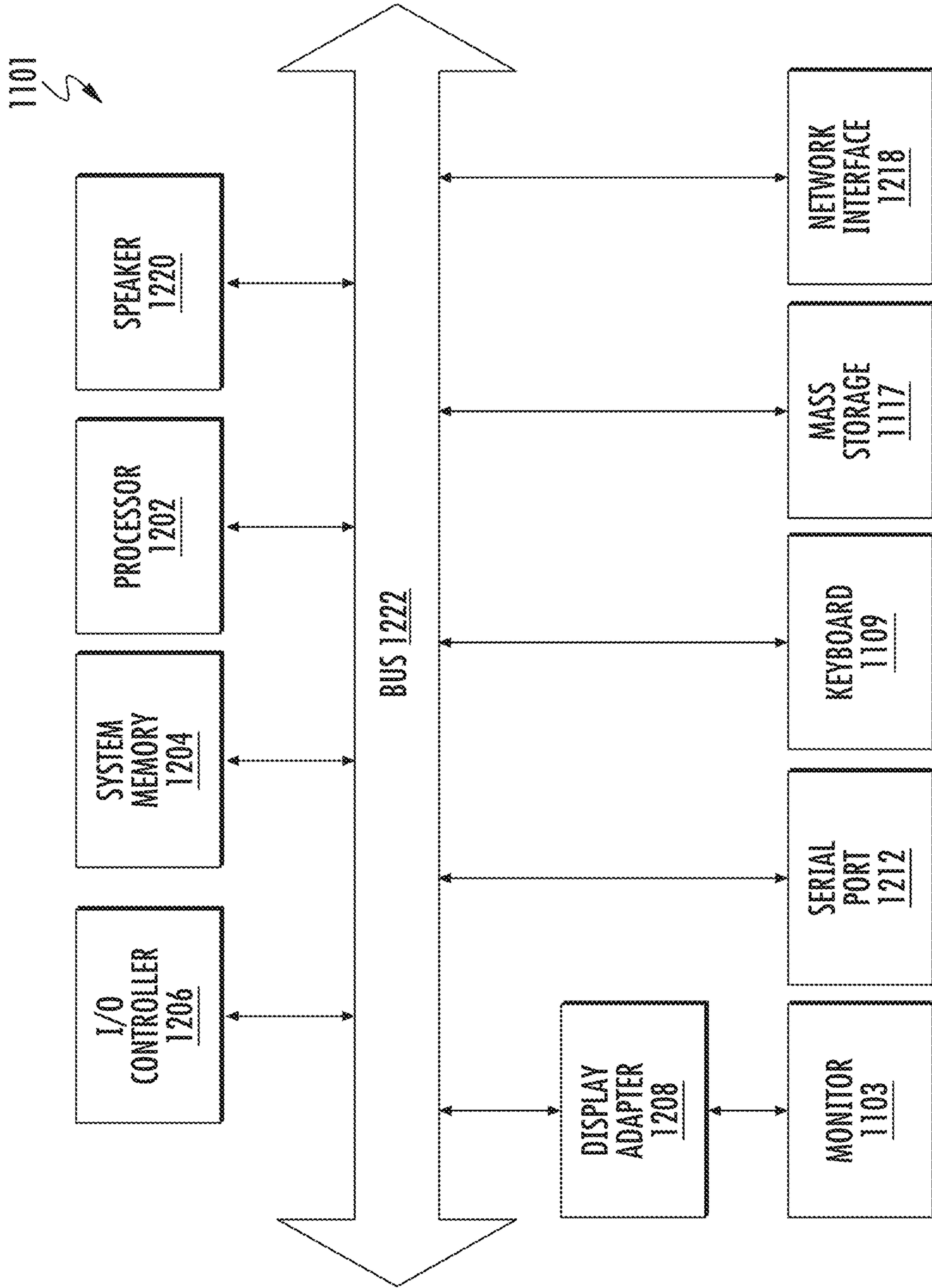

FIG. 12

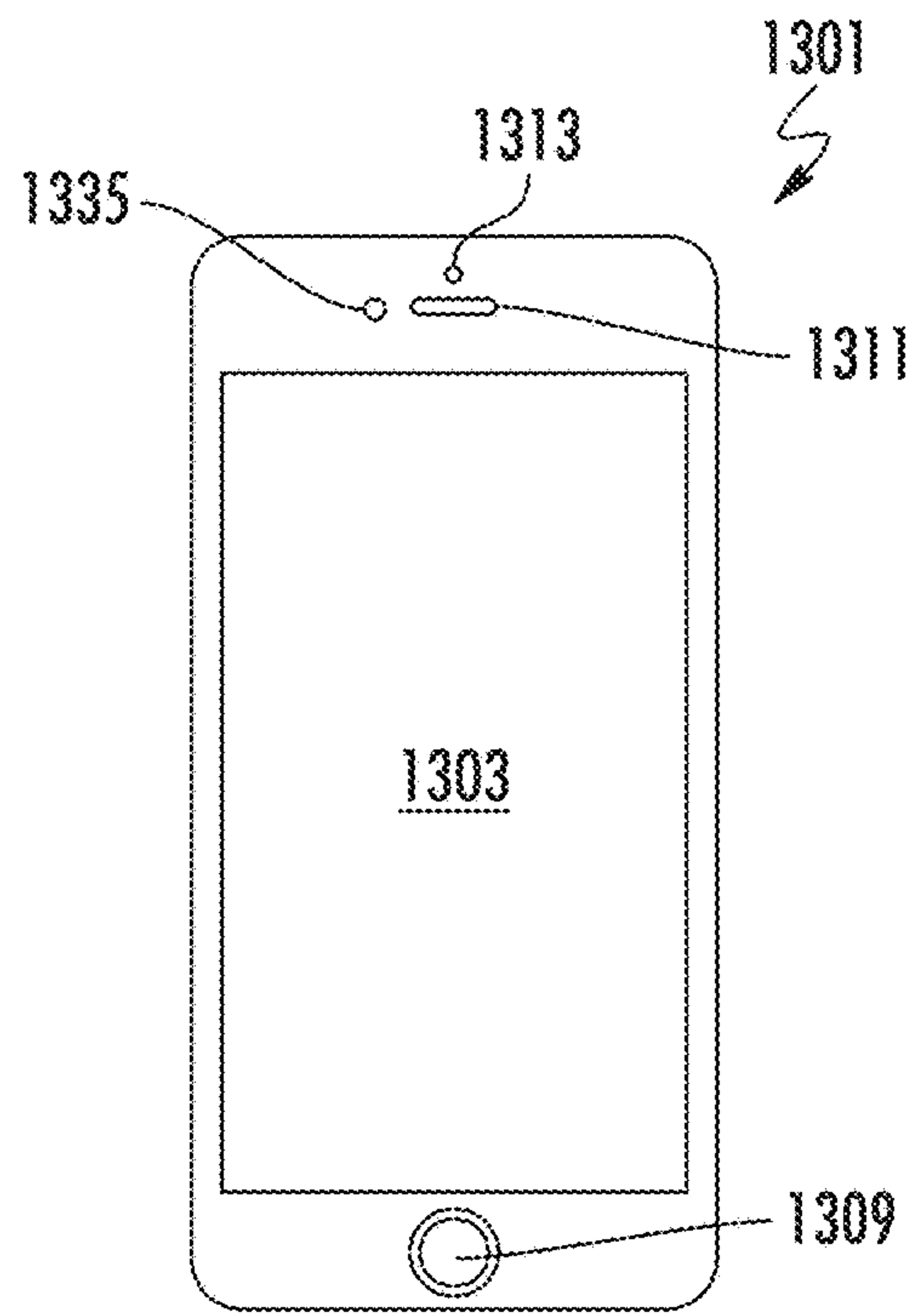

FIG. 13

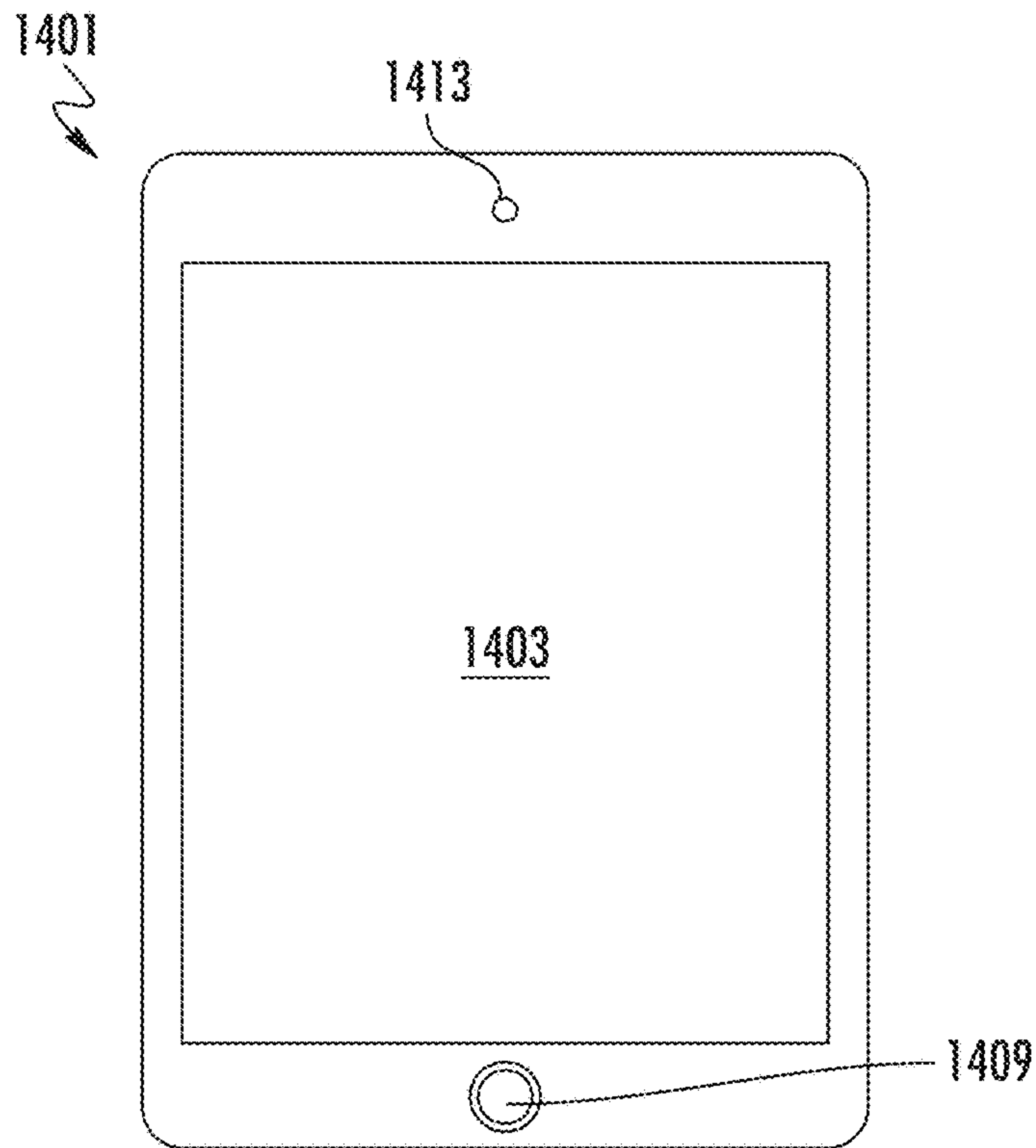

FIG. 14

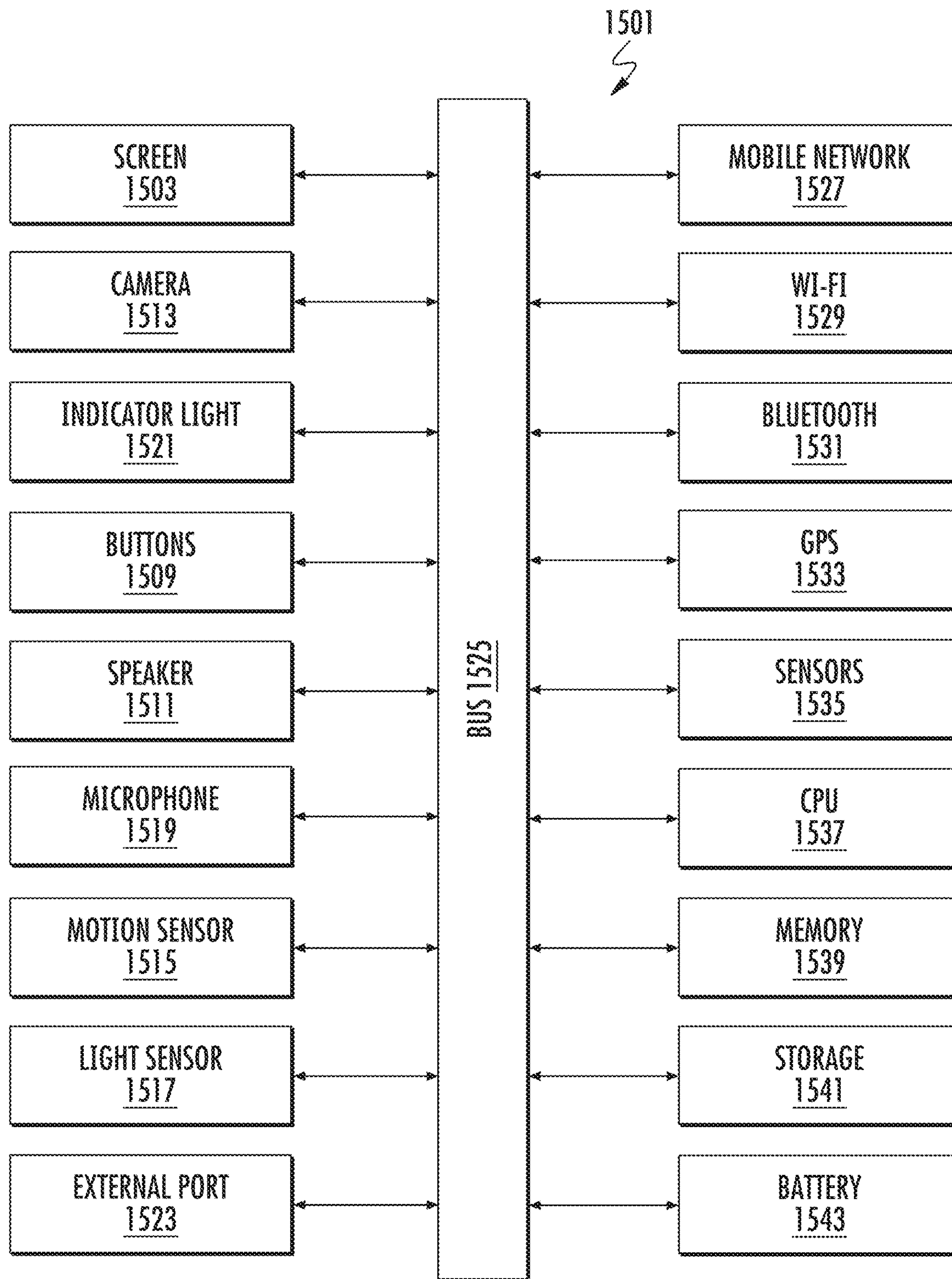

FIG. 15

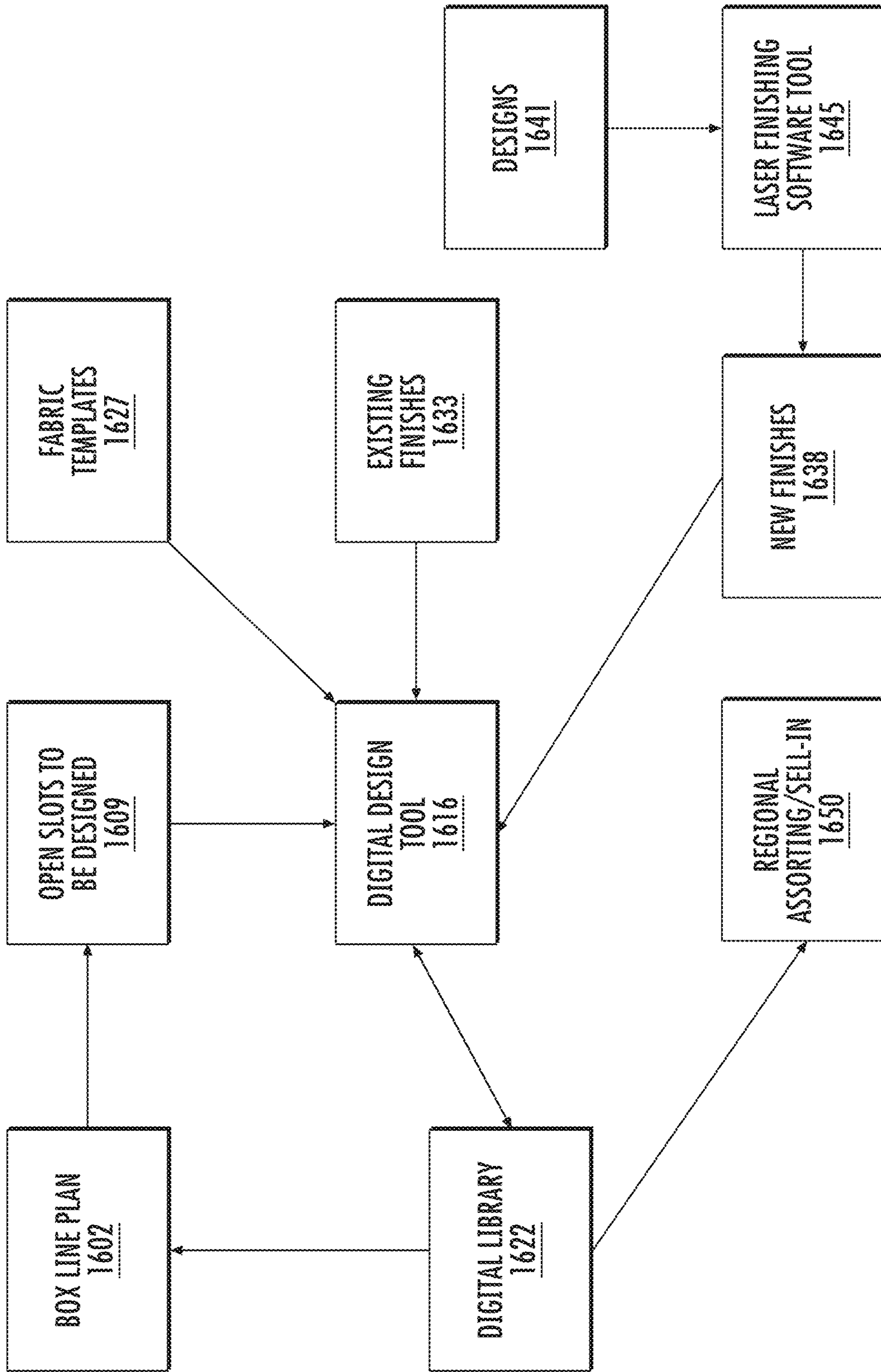

FIG. 16

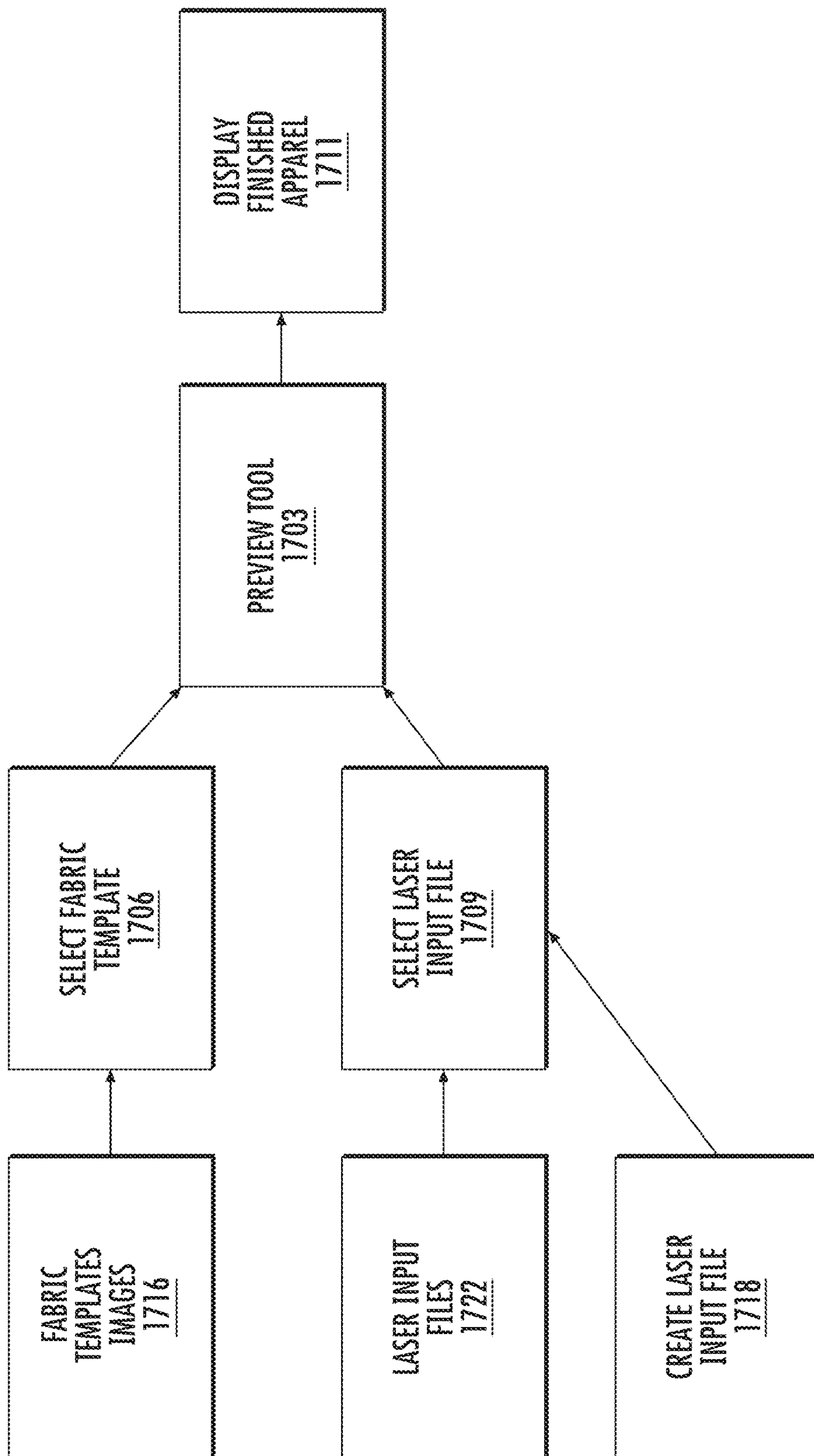

FIG. 17

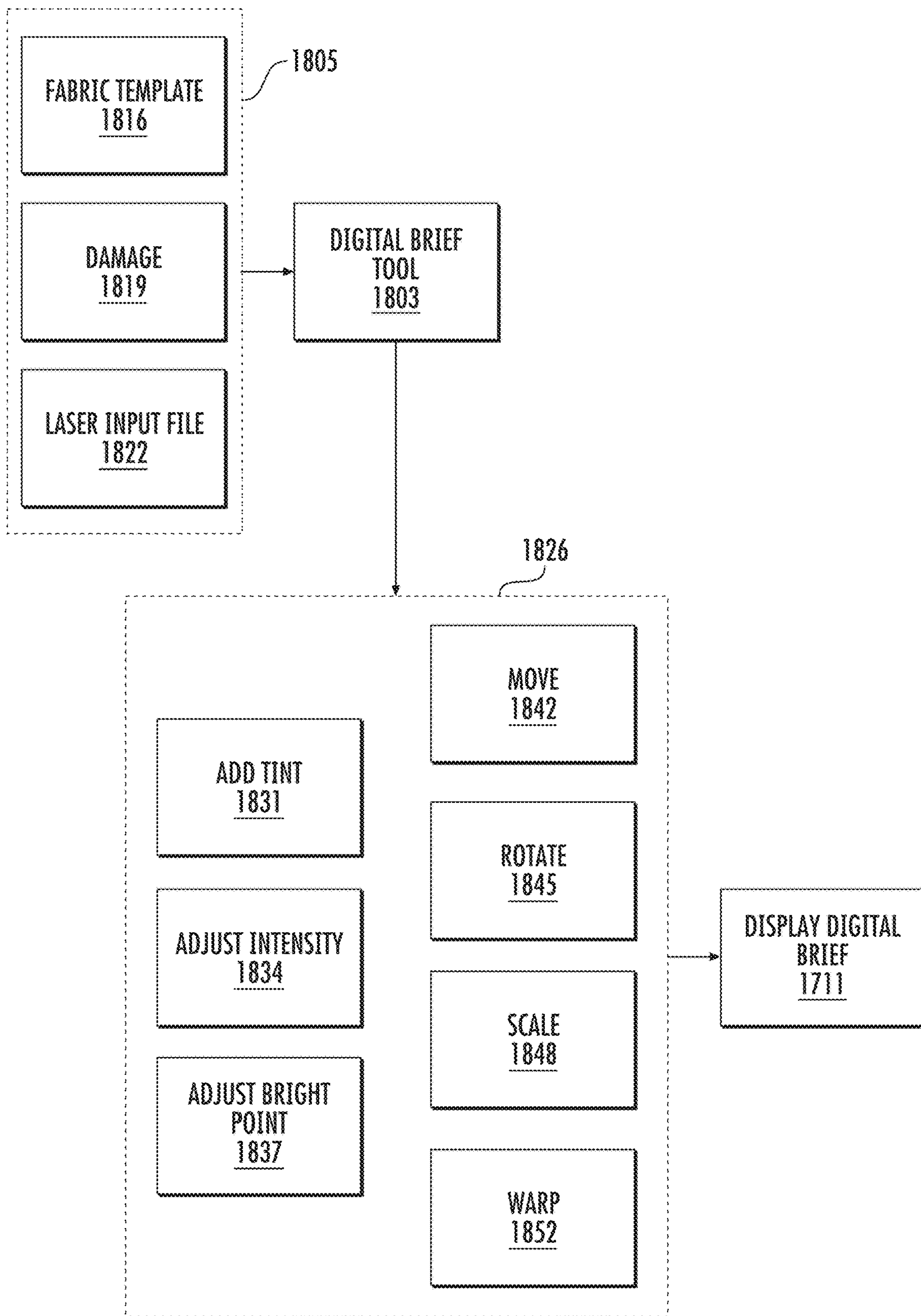

FIG. 18

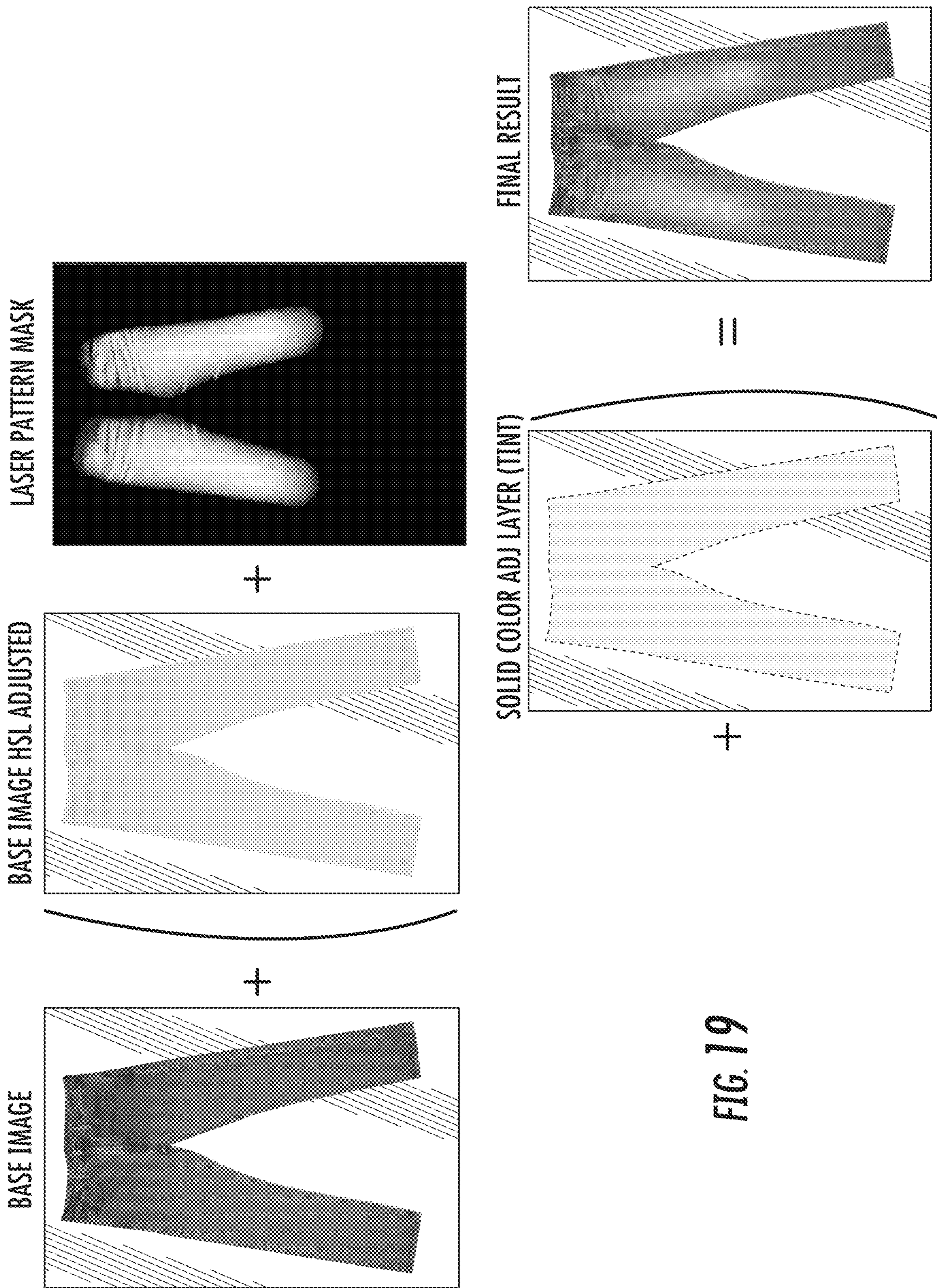

FIG. 19

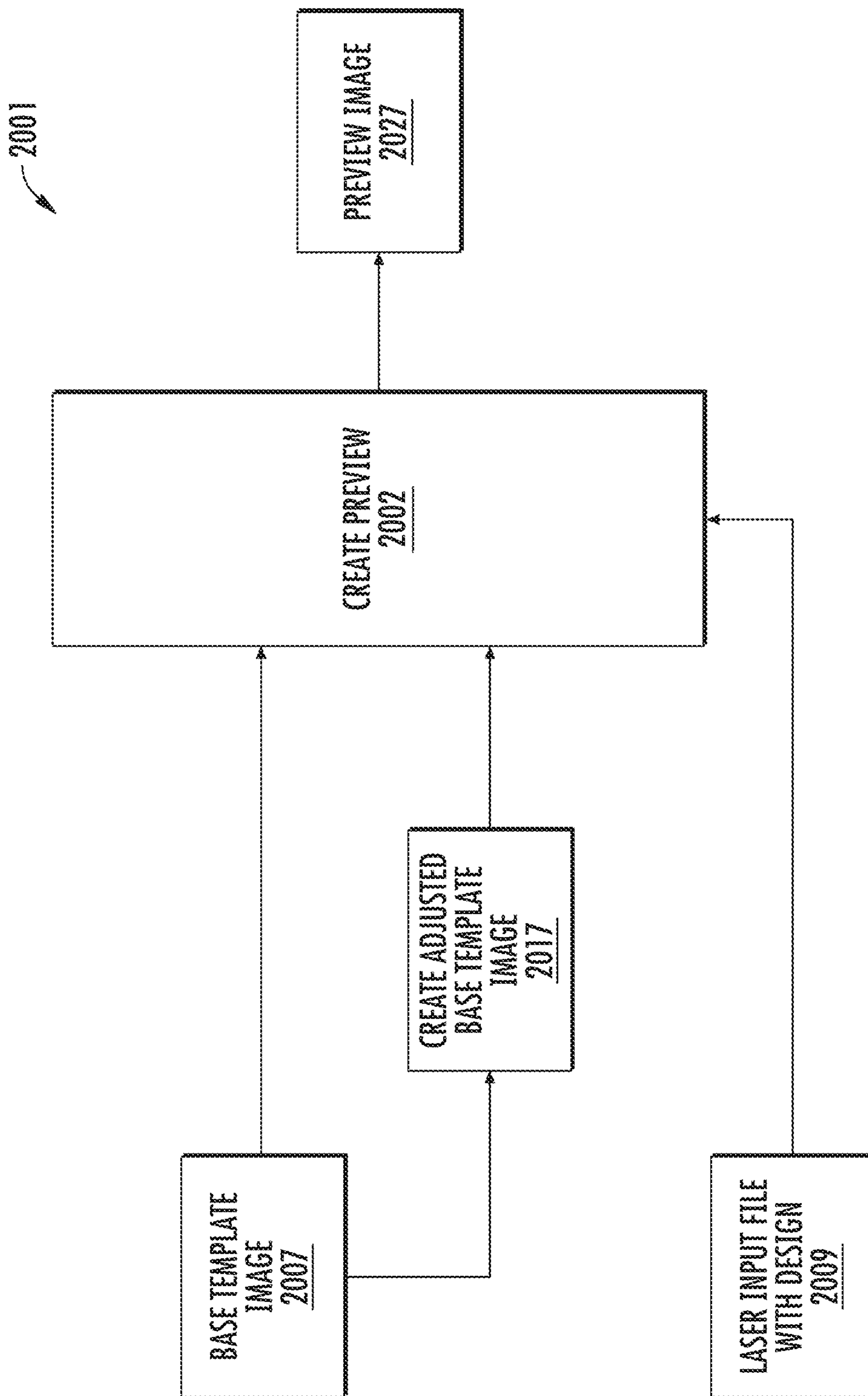

FIG. 20

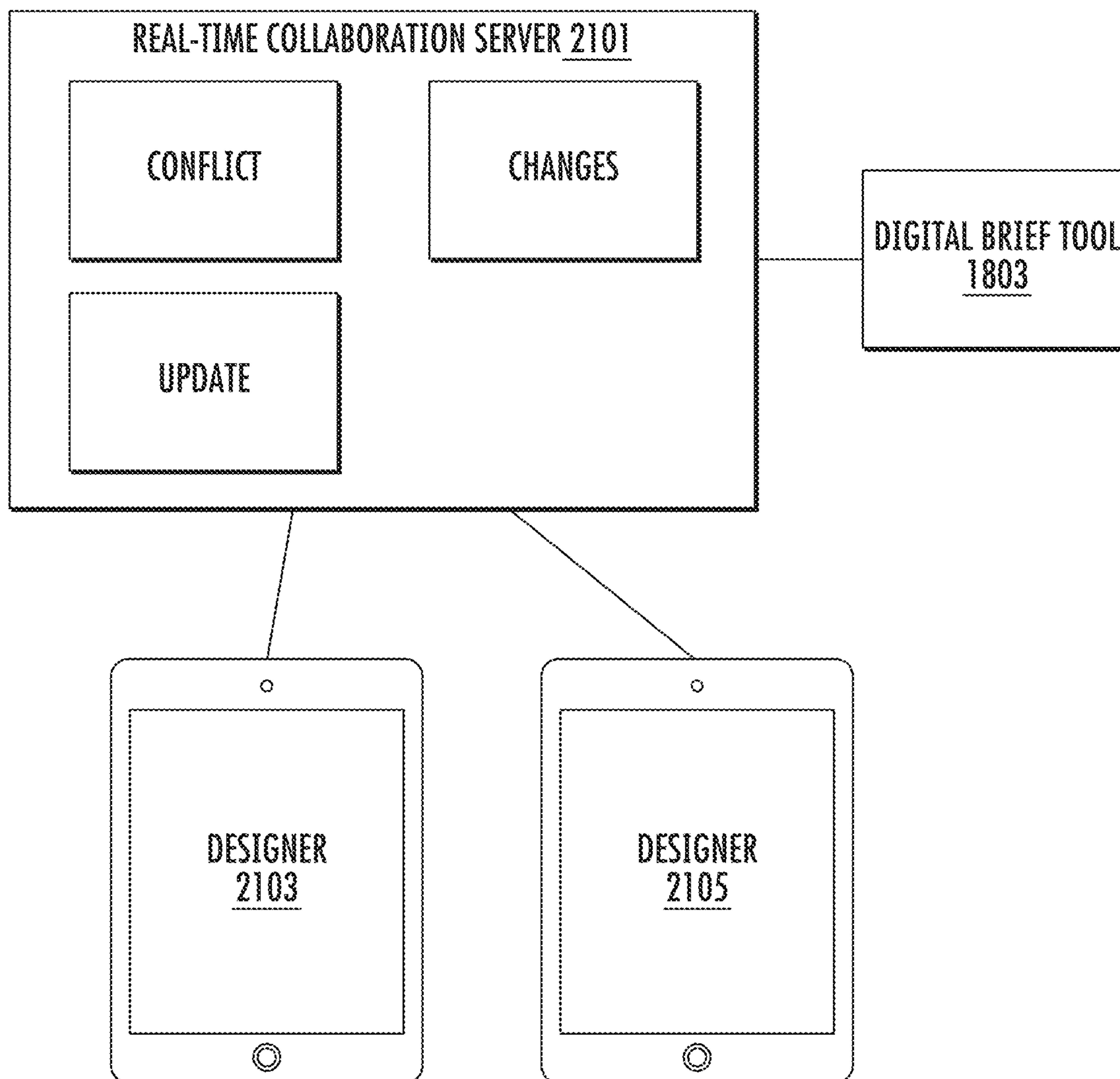

FIG. 21

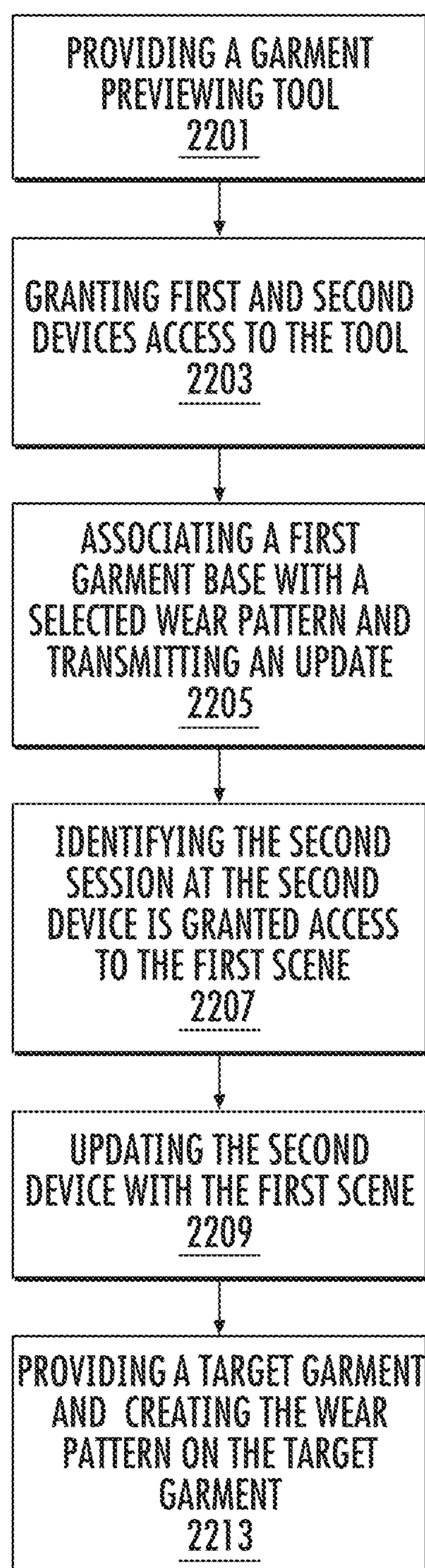

FIG. 22

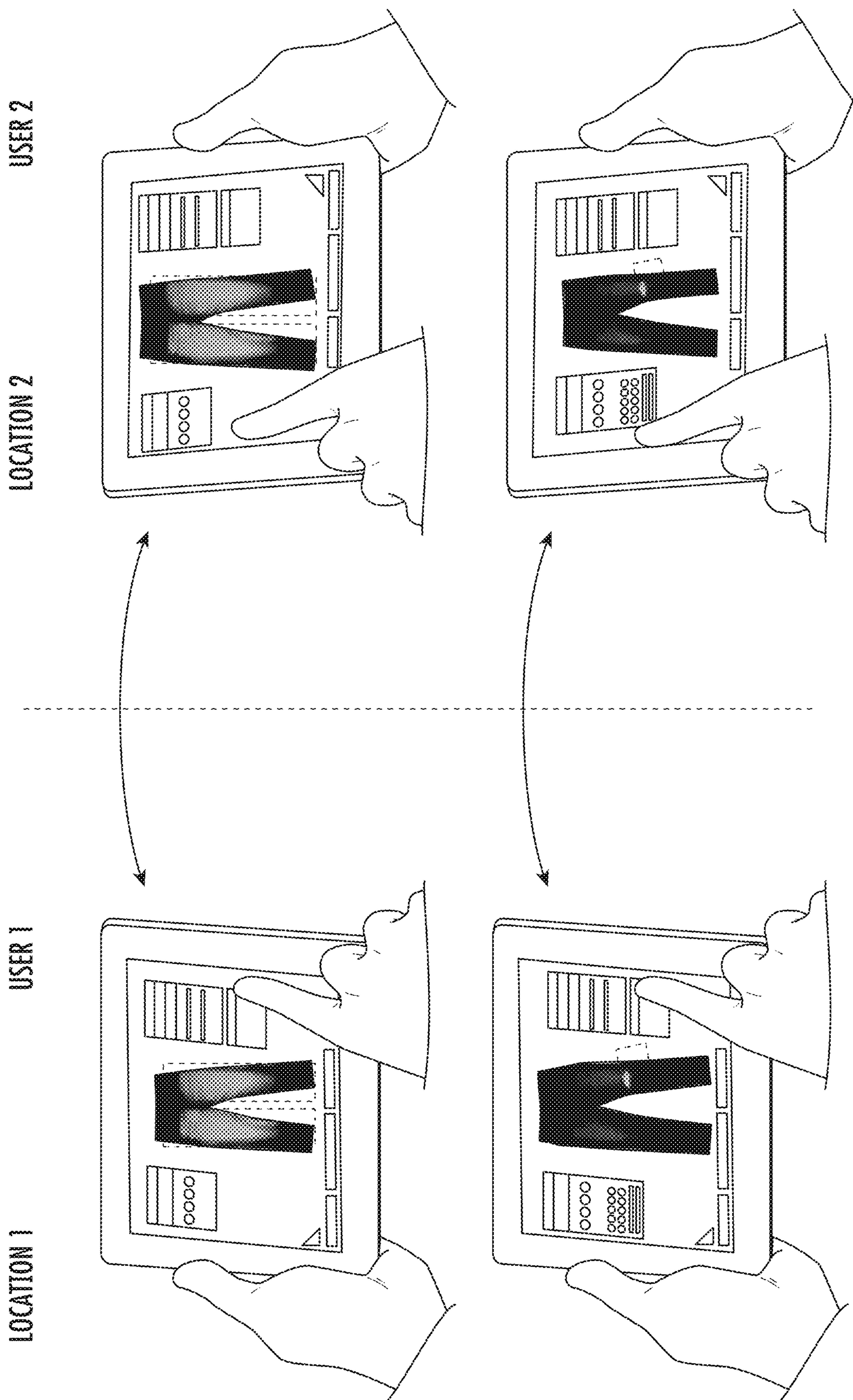

FIG. 23

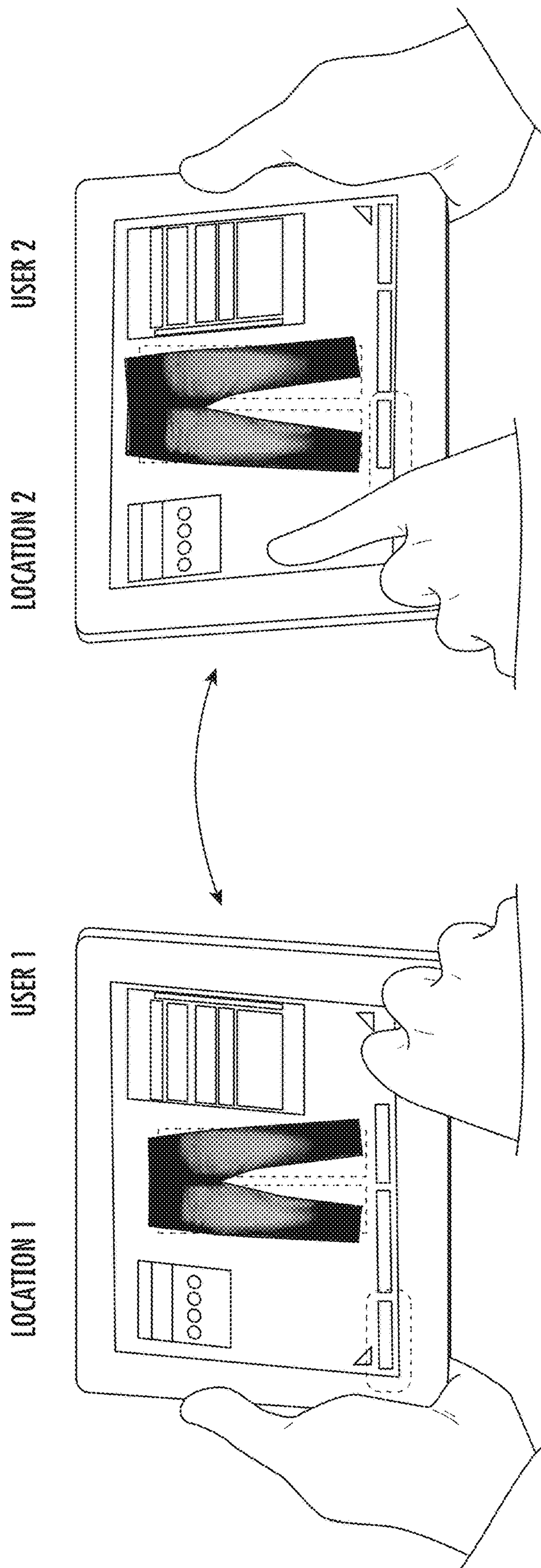

FIG. 24

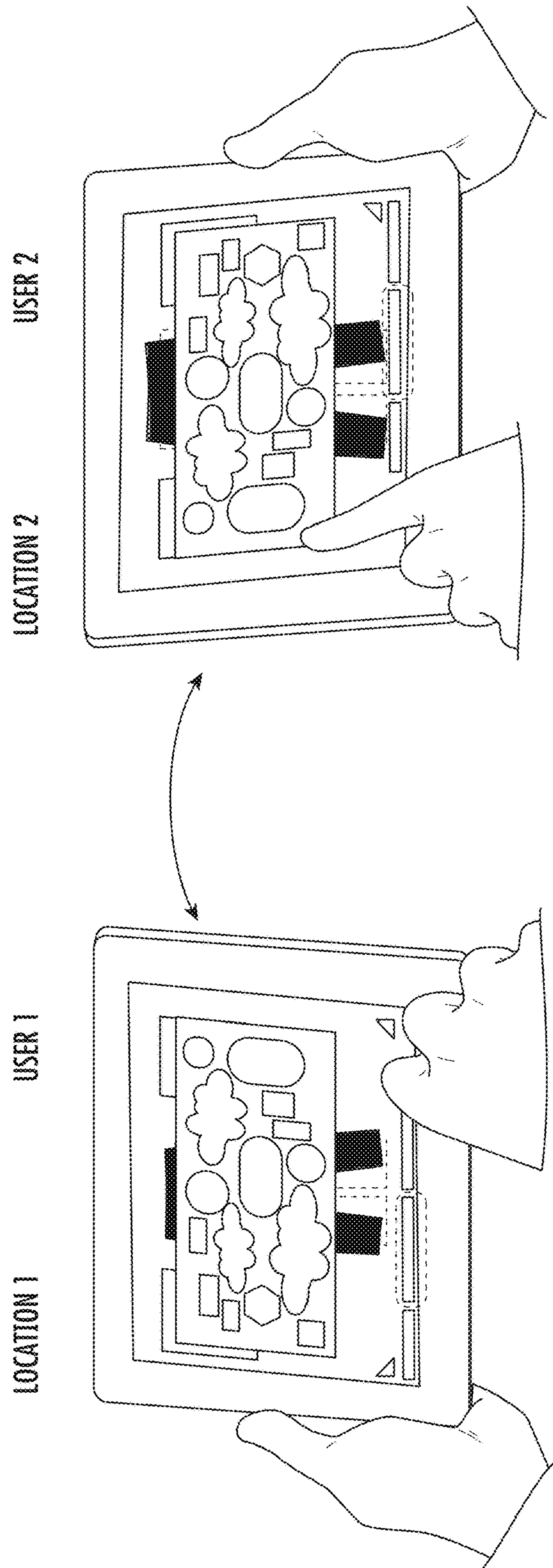

FIG. 25

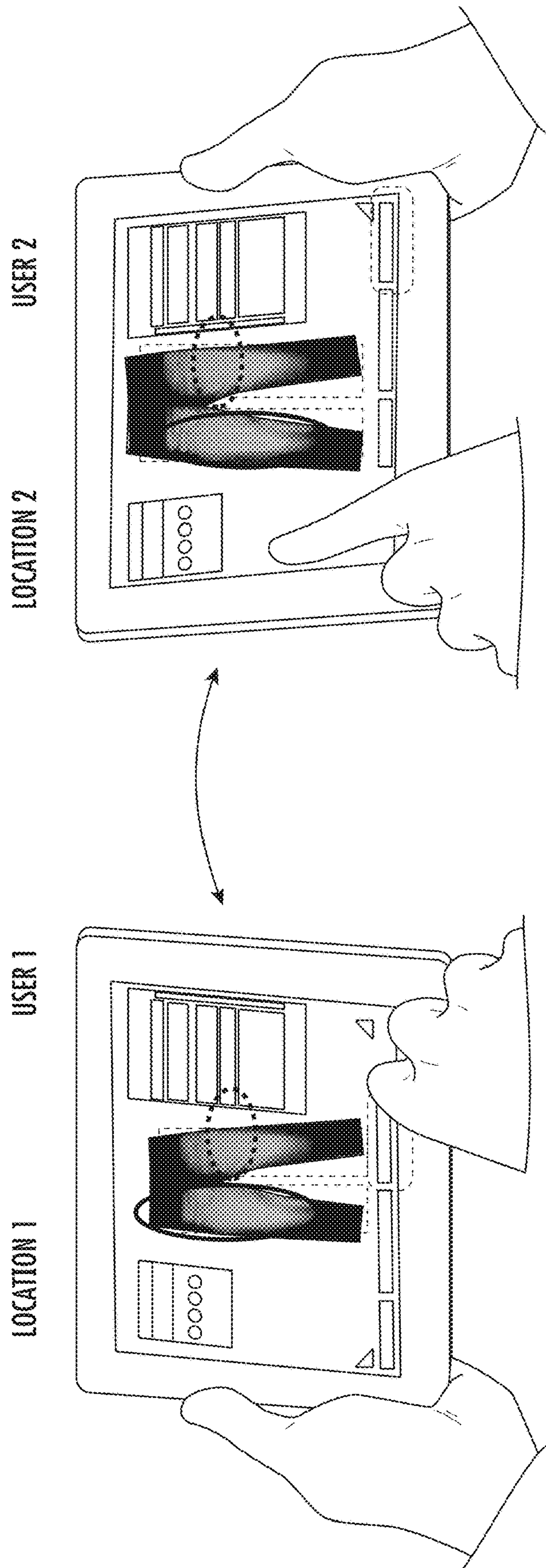

FIG. 26

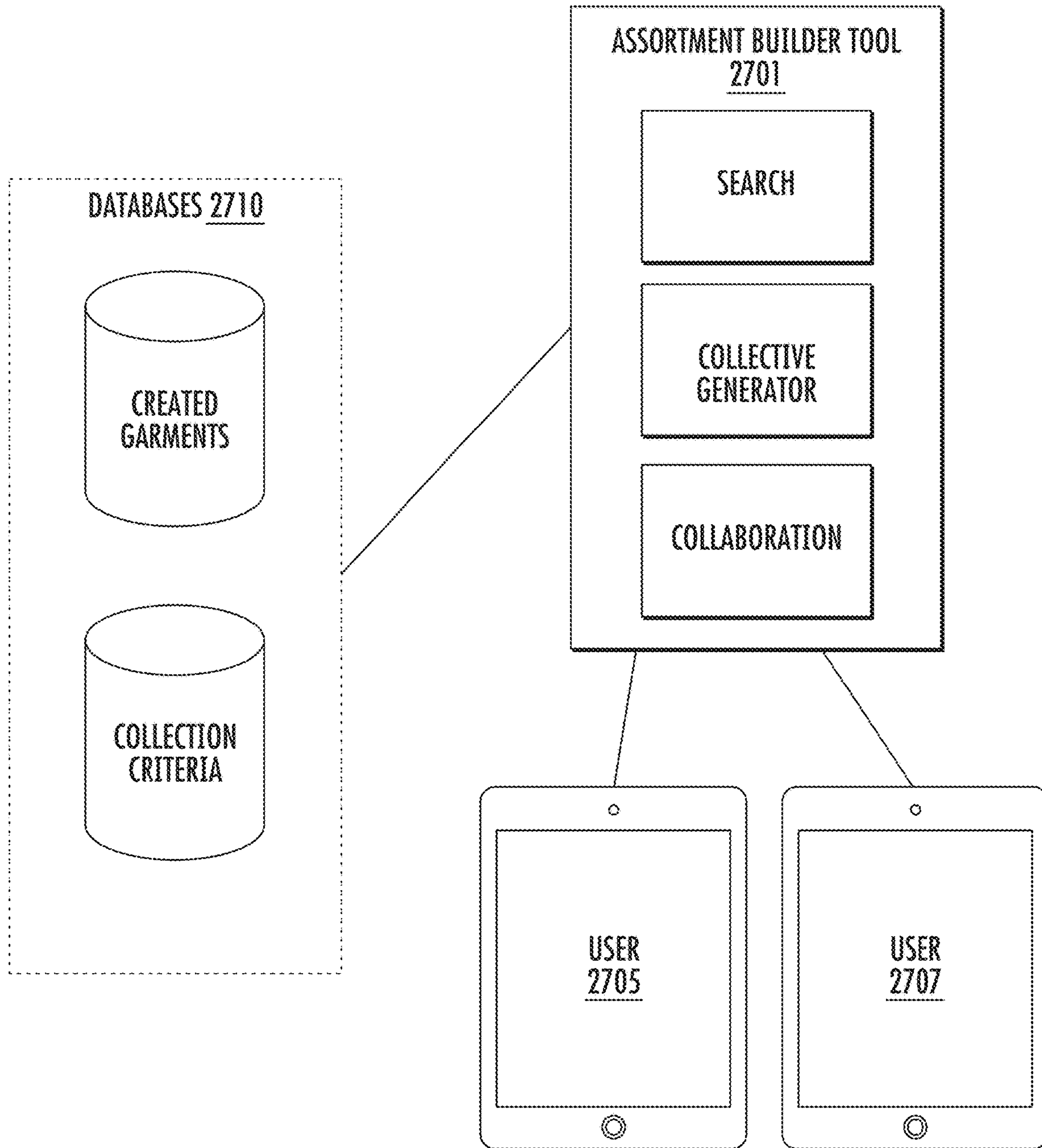

FIG. 27

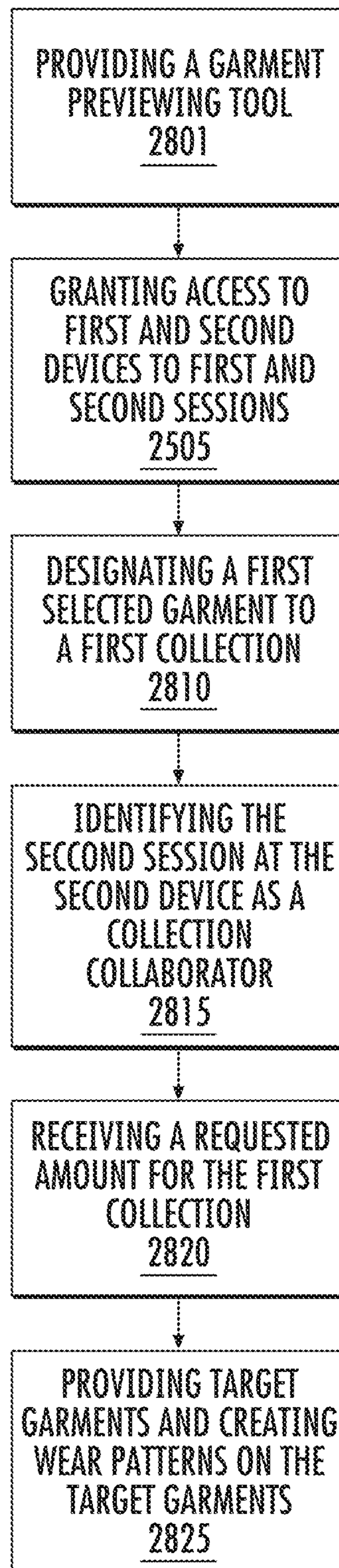

FIG. 28

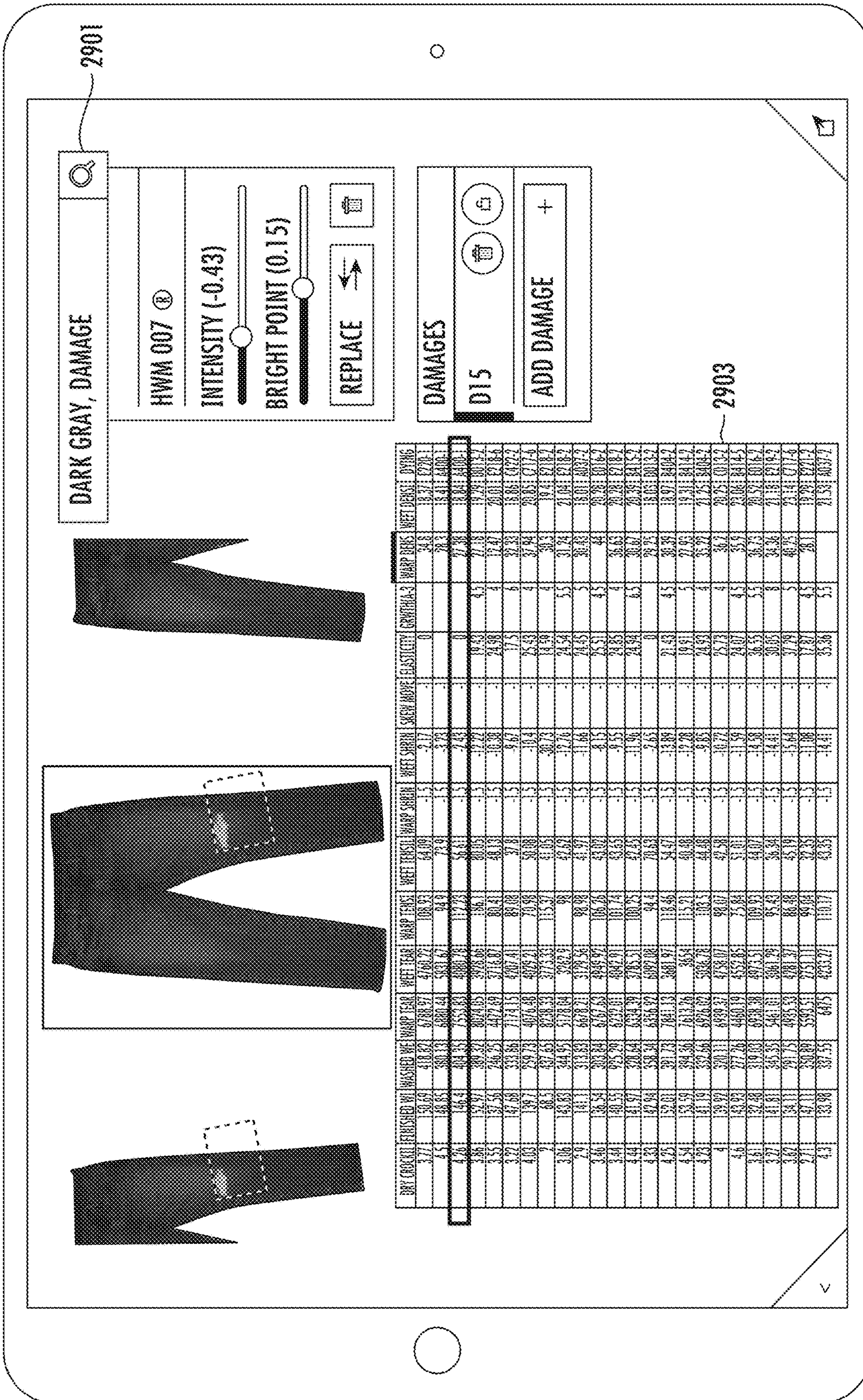

FIG. 29

| DRY CROCKI | FINISHED WT | WASHED WE | WARP TEAR | WEFT TEAR | WARP TENSI | WEFT TENSI | WARP SHRIN | WEFT SHRIN | WEFT SHRIN | SKREW MOVE | ELASTICITY | GRNTHIA-3 | WARP DENS | WEFT DENS | DYING |
|------------|-------------|-----------|-----------|-----------|------------|------------|------------|------------|------------|------------|------------|-----------|-----------|-----------|--------|
| 3.77 | 150.69 | 418.82 | 6788.97 | 4760.22 | 108.93 | 64.09 | -1.5 | -2.17 | -1 | 0 | 0 | | 34.8 | 18.37 | E220-1 |
| 4.5 | 148.85 | 380.13 | 6880.44 | 5831.67 | 94.9 | 73.9 | -1.5 | -3.73 | -1 | | | | 28.3 | 18.41 | A400-1 |
| 4.26 | 146.4 | 404.35 | 7553.83 | 4080.78 | 112.23 | 56.61 | -1.5 | -2.43 | -1 | 0 | 0 | | 27.38 | 18.84 | A400-1 |
| 3.86 | 152.97 | 389.32 | 8024.05 | 3928.66 | 186.1 | 80.05 | -1.5 | -12.22 | -1 | 19.43 | 4.5 | | 27.18 | 19.29 | D013-2 |
| 3.55 | 137.56 | 246.75 | 4472.69 | 3716.87 | 80.41 | 48.13 | -1.5 | -10.38 | -1 | 24.98 | 4 | | 12.47 | 20.01 | E218-6 |
| 3.22 | 147.68 | 333.86 | 7174.15 | 4207.41 | 89.08 | 37.8 | -1.5 | -9.67 | -1 | 17.5 | 6 | | 32.33 | 18.86 | C422-2 |
| 4.03 | 139.7 | 239.73 | 4076.48 | 4029.21 | 70.98 | 50.08 | -1.5 | -10.4 | -1 | 25.43 | 4 | | 37.94 | 20.85 | C17-6 |
| 2 | 68.5 | 437.65 | 8238.33 | 3773.33 | 115.37 | 41.05 | -1.5 | -30.73 | -1 | 14.59 | 4 | | 30.3 | 19.4 | E218-2 |
| 3.06 | 143.83 | 344.95 | 5178.04 | 3262.9 | 98 | 42.62 | -1.5 | -12.76 | -1 | 24.54 | 5.5 | | 31.24 | 21.04 | E218-2 |
| 2.9 | 141.1 | 313.83 | 6678.21 | 3129.56 | 98.98 | 41.97 | -1.5 | -11.66 | -1 | 24.45 | 5 | | 30.43 | 18.01 | A037-2 |
| 3.46 | 136.54 | 303.84 | 6767.63 | 4949.92 | 106.26 | 43.02 | -1.5 | -8.15 | -1 | 25.51 | 4.5 | | 44 | 20.28 | E016-2 |
| 3.44 | 140.55 | 925.29 | 6232.01 | 4042.91 | 101.74 | 43.65 | -1.5 | -9.55 | -1 | 24.85 | 4 | | 36.63 | 20.28 | E218-2 |
| 4.44 | 141.97 | 328.64 | 6334.39 | 3785.51 | 100.25 | 42.45 | -1.5 | -11.96 | -1 | 24.94 | 6.5 | | 30.67 | 20.39 | B415-2 |
| 4.33 | 142.94 | 358.34 | 6356.92 | 6092.08 | 94.4 | 70.63 | -1.5 | -2.65 | -1 | 0 | 0 | | 29.25 | 18.03 | D013-2 |
| 4.25 | 152.01 | 391.73 | 7841.13 | 3681.97 | 118.46 | 54.47 | -1.5 | -13.89 | -1 | 21.43 | 4.5 | | 30.39 | 18.97 | B404-2 |
| 4.54 | 153.59 | 394.36 | 7613.26 | 3654 | 115.21 | 40.48 | -1.5 | -12.28 | -1 | 19.91 | 5 | | 27.93 | 19.31 | B414-2 |
| 4.23 | 141.19 | 332.66 | 6976.02 | 5036.78 | 103.5 | 44.48 | -1.5 | -9.85 | -1 | 24.93 | 4 | | 35.22 | 21.25 | B404-2 |
| 4 | 139.92 | 320.11 | 6939.37 | 4758.07 | 98.07 | 42.58 | -1.5 | -10.72 | -1 | 25.73 | 4 | | 36.2 | 20.25 | C013-2 |
| 4.6 | 143.93 | 277.26 | 4460.19 | 4552.85 | 75.84 | 51.01 | -1.5 | -11.59 | -1 | 24.07 | 4.5 | | 35.9 | 23.06 | B414-5 |
| 3.61 | 132.48 | 319.03 | 6938.38 | 4973.51 | 109.93 | 44.07 | -1.5 | -14.58 | -1 | 36.55 | 5.5 | | 36.73 | 20.52 | E016-2 |
| 3.27 | 141.81 | 345.35 | 5461.01 | 3061.29 | 95.43 | 36.34 | -1.5 | -14.41 | -1 | 30.05 | 8 | | 34.36 | 21.18 | E219-2 |
| 3.62 | 134.11 | 291.75 | 4935.53 | 4281.37 | 86.48 | 45.19 | -1.5 | -15.64 | -1 | 37.29 | 5 | | 40.25 | 23.14 | C17-6 |
| 2.71 | 147.11 | 350.89 | 5593.51 | 2751.11 | 99.04 | 32.35 | -1.5 | -11.08 | -1 | 17.87 | 4.5 | | 28.1 | 19.29 | E221-2 |
| 4.3 | 133.98 | 337.55 | 6475 | 4233.27 | 110.17 | 43.35 | -1.5 | -14.41 | -1 | 35.36 | 5.5 | | 21.53 | 21.53 | A037-2 |

2903

FIG. 30

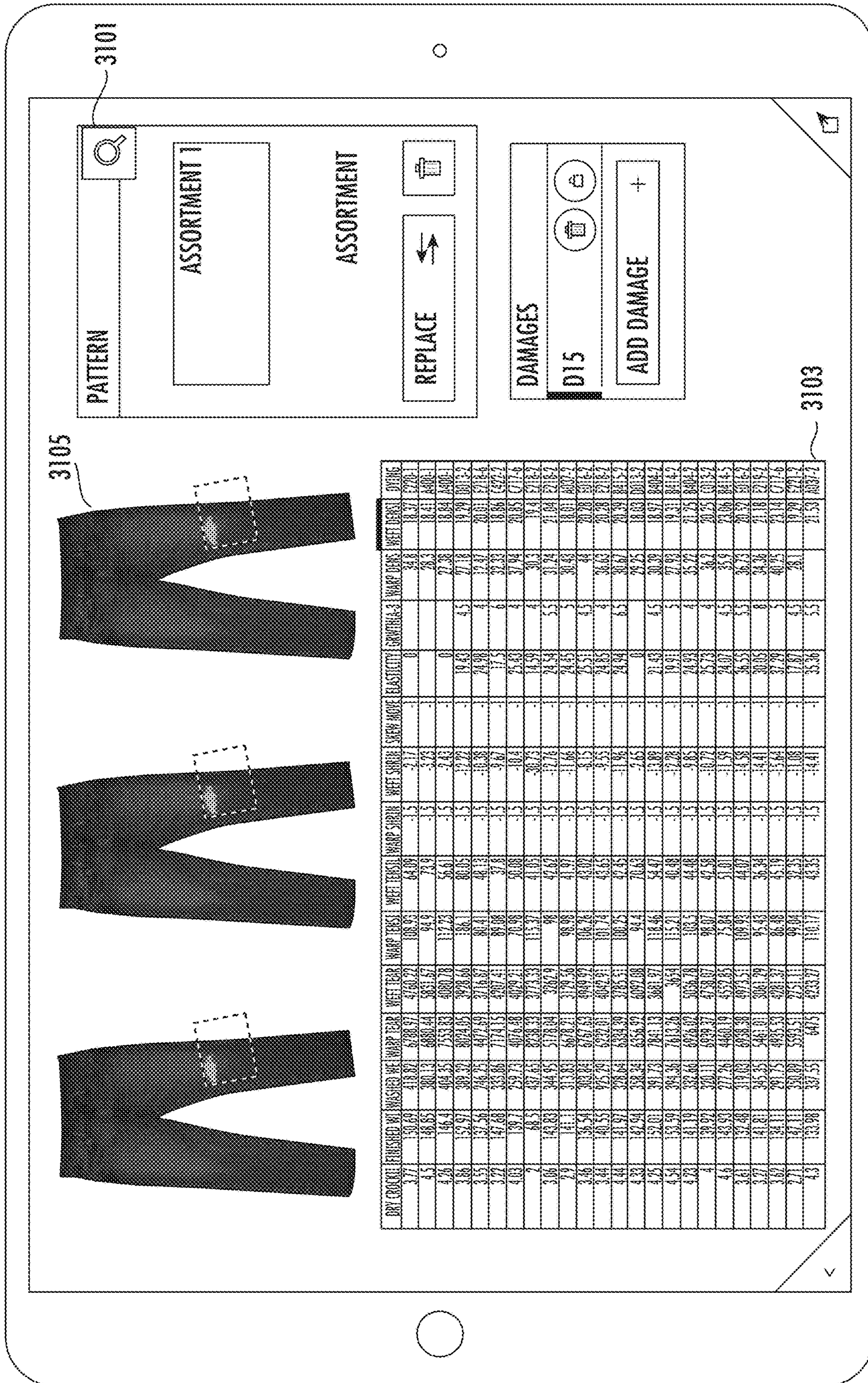

FIG. 31

| DRY CROCKIT | FINISHED WT | WASHED WF | WARP TEAR | WEFT TEAR | WARP TENSI | WEFT TENSI | WARP SHRIN | WEFT SHRIN | SKEW MOVE | ELASTICITY | GRNTHIA-3 | WARP DENSI | WEFT DENSI | DYING |
|-------------|-------------|-----------|-----------|-----------|------------|------------|------------|------------|-----------|------------|-----------|------------|------------|--------|
| 3.77 | 150.69 | 418.82 | 6788.97 | 4760.22 | 108.93 | 64.09 | -1.5 | -2.17 | -1 | 0 | | 34.8 | 18.37 | E220-1 |
| 4.5 | 148.85 | 380.13 | 6880.44 | 5831.67 | 94.9 | 73.9 | -1.5 | -3.23 | -1 | | | 28.3 | 18.41 | A400-1 |
| 4.26 | 146.4 | 404.35 | 7553.83 | 4080.78 | 112.23 | 56.61 | -1.5 | -2.43 | -1 | 0 | | 27.38 | 18.84 | A400-1 |
| 3.86 | 152.97 | 389.32 | 8024.05 | 3928.66 | 186.1 | 80.05 | -1.5 | -12.22 | -1 | 19.43 | 4.5 | 27.18 | 19.29 | D013-2 |
| 3.55 | 137.56 | 246.25 | 4472.69 | 3716.87 | 80.41 | 48.13 | -1.5 | -10.38 | -1 | 24.98 | 4 | 12.47 | 20.01 | E218-6 |
| 3.22 | 147.68 | 333.86 | 7174.15 | 4207.41 | 89.08 | 37.8 | -1.5 | -9.67 | -1 | 17.5 | 6 | 32.33 | 18.86 | C422-2 |
| 4.03 | 139.7 | 239.73 | 4076.48 | 4029.21 | 70.98 | 50.08 | -1.5 | -10.4 | -1 | 25.43 | 4 | 37.94 | 20.85 | C717-6 |
| 2 | 68.5 | 437.65 | 8238.33 | 3773.33 | 115.37 | 41.05 | -1.5 | -30.73 | -1 | 14.59 | 4 | 30.3 | 19.4 | E218-2 |
| 3.06 | 143.83 | 344.95 | 5178.04 | 3282.9 | 98 | 42.62 | -1.5 | -12.76 | -1 | 24.54 | 5.5 | 31.24 | 21.04 | E218-2 |
| 2.9 | 141.1 | 313.83 | 6678.21 | 3129.56 | 98.98 | 41.97 | -1.5 | -11.66 | -1 | 24.45 | 5 | 30.43 | 18.01 | A037-2 |
| 3.46 | 136.54 | 303.84 | 6767.63 | 4949.92 | 106.26 | 43.02 | -1.5 | -8.15 | -1 | 25.51 | 4.5 | 44 | 20.28 | E016-2 |
| 3.44 | 140.55 | 925.29 | 6232.01 | 4042.91 | 101.74 | 43.65 | -1.5 | -9.55 | -1 | 24.85 | 4 | 36.63 | 20.28 | E218-2 |
| 4.44 | 141.97 | 328.64 | 6334.39 | 3785.51 | 100.25 | 42.45 | -1.5 | -11.96 | -1 | 24.94 | 6.5 | 30.67 | 20.39 | 8415-2 |
| 4.33 | 142.94 | 358.34 | 6356.92 | 6092.08 | 94.4 | 70.63 | -1.5 | -2.65 | -1 | 0 | | 29.25 | 18.03 | D013-2 |
| 4.25 | 152.01 | 391.73 | 7841.13 | 3681.97 | 118.46 | 54.47 | -1.5 | -13.89 | -1 | 21.43 | 4.5 | 30.39 | 18.97 | 8404-2 |
| 4.54 | 153.59 | 394.36 | 7613.26 | 3654 | 115.21 | 40.48 | -1.5 | -12.28 | -1 | 19.91 | 5 | 27.93 | 19.31 | 8414-2 |
| 4.23 | 141.19 | 332.66 | 6926.02 | 5036.78 | 103.5 | 44.48 | -1.5 | -9.85 | -1 | 24.93 | 4 | 35.22 | 21.25 | 8404-2 |
| 4 | 139.92 | 320.11 | 6939.37 | 4758.07 | 98.07 | 42.58 | -1.5 | -10.72 | -1 | 25.73 | 4 | 36.2 | 20.25 | C013-2 |
| 4.6 | 143.93 | 277.26 | 4460.19 | 4552.85 | 75.84 | 51.01 | -1.5 | -11.59 | -1 | 24.07 | 4.5 | 35.9 | 23.06 | 8414-5 |
| 3.61 | 132.48 | 319.03 | 6938.38 | 4973.51 | 109.93 | 44.07 | -1.5 | -14.58 | -1 | 36.55 | 5.5 | 36.73 | 20.52 | E016-2 |
| 3.27 | 141.81 | 345.35 | 5461.01 | 3061.29 | 95.43 | 36.34 | -1.5 | -14.41 | -1 | 30.05 | 8 | 34.36 | 21.18 | E219-2 |
| 3.62 | 134.11 | 291.75 | 4935.53 | 4281.37 | 86.48 | 45.19 | -1.5 | -15.64 | -1 | 37.29 | 5 | 40.25 | 23.14 | C717-6 |
| 2.71 | 147.11 | 350.89 | 5593.51 | 2751.11 | 99.04 | 32.35 | -1.5 | -11.08 | -1 | 17.87 | 4.5 | 28.1 | 19.29 | E221-2 |
| 4.3 | 133.98 | 337.55 | 6475 | 4233.27 | 110.17 | 43.35 | -1.5 | -14.41 | -1 | 35.36 | 5.5 | | 21.53 | A037-2 |

3103

FIG. 32

COLLABORATION IN AN APPAREL DESIGN SYSTEM

CROSS-REFERENCE TO RELATED APPLICATIONS

This patent application claims the benefit of U.S. patent applications 62/636,108 and 62/636,112, filed Feb. 27, 2018, which are incorporated by reference along with all other references cited in this application.

BACKGROUND OF THE INVENTION

The present invention relates to apparel finishing and, more specifically, the use of a laser in the finishing of garments, especially denim including jeans, shirts, shorts, jackets, vests, and skirts, to obtain a faded, distressed, washed, or worn finish or appearance.

In 1853, during the California Gold Rush, Levi Strauss, a 24-year-old German immigrant, left New York for San Francisco with a small supply of dry goods with the intention of opening a branch of his brother's New York dry goods business. Shortly after arriving in San Francisco, Mr. Strauss realized that the miners and prospectors (called the "forty niners") needed pants strong enough to last through the hard work conditions they endured. So, Mr. Strauss developed the now familiar jeans which he sold to the miners. The company he founded, Levi Strauss & Co., still sells jeans and is the most widely known jeans brand in the world. Levi's is a trademark of Levi Strauss & Co. or LS&Co.

Though jeans at the time of the Gold Rush were used as work clothes, jeans have evolved to be fashionably worn everyday by men and women, showing up on billboards, television commercials, and fashion runways. Fashion is one of the largest consumer industries in the U.S. and around the world. Jeans and related apparel are a significant segment of the industry.

As fashion, people are concerned with the appearance of their jeans. Many people desire a faded or worn blue jeans look. In the past, jeans became faded or distressed through normal wash and wear. The apparel industry recognized people's desire for the worn blue jeans look and began producing jeans and apparel with a variety of wear patterns. The wear patterns have become part of the jeans style and fashion. Some examples of wear patterns include combs or honeycombs, whiskers, stacks, and train tracks.

Despite the widespread success jeans have enjoyed, the process to produce modern jeans with wear patterns takes processing time, has relatively high processing cost, and is resource intensive. A typical process to produce jeans uses significant amounts of water, chemicals (e.g., bleaching or oxidizing agents), ozone, enzymes, and pumice stone. For example, it may take about twenty to sixty liters of water to finish each pair of jeans.

Therefore, there is a need for an improved process for finishing jeans that reduces environmental impact, processing time, and processing costs, while maintaining the look and style of traditional finishing techniques. There is a need for tool to creating and previewing patterns on jeans before laser finishing.

BRIEF SUMMARY OF THE INVENTION

A tool allows a user to create new designs for apparel and preview these designs before manufacture. Software and lasers are used in finishing apparel to produce a desired wear

pattern or other design. Based on a laser input file with a pattern, a laser will burn the pattern onto apparel. With the tool, the user will be able to create, make changes, and view images of a design, in real time, before burning by a laser.

5 Input to the tool includes fabric template images, laser input files, and damage input. The tool allows adding of tinting and adjusting of intensity and bright point. The user can also move, rotate, scale, and warp the image input.

In an implementation, a method for collaboration in an apparel design system includes providing a garment previewing tool that allows previewing on a computer screen of a selected garment base customized by a user with a finishing pattern created using a laser input file by a laser. The method includes granting access to a first scene via a first session of the garment previewing tool on a first device, where the first scene identifies the first garment base and the first session identifies the first device and granting access to the first scene via a second session of the garment previewing tool on a second device. The first and second devices may be different users, with different instances of the garment previewing tool executing on their respective device. The method includes receiving, from the first device, a selected wear pattern to apply to the selected garment base and, in response to receiving the selected wear pattern on the first device, updating the first scene including the selected garment base to reflect the selected wear pattern. The method includes in response to updating the first scene to reflect the selected wear pattern, identifying the second session at the second device as associated with the first scene and, in response to identifying the second session, transmitting information identifying the selected wear pattern and the selected garment base. The method includes providing a target garment corresponding to the garment base selected by the user; and based on a laser input file associated with a selected wear pattern with modified sizing or modified positioning, or a combination, using a laser to create a finishing pattern on an outer surface of the target garment.

The method includes allowing positioning and sizing to be modified. The method includes where transmitting the information identifying the selected wear pattern includes causing, on a computer screen of the second device, showing a garment preview image on the computer screen including the jeans base image and selected wear pattern. The method includes: receiving, from the first device, modification of a sizing of the wear pattern relative to a jeans base image or a position of the wear pattern relative to a jeans base image and, in response to receiving the modification of the wear pattern on the first device, updating the first scene to reflect the modification of the wear pattern. The method includes in response to updating the first scene to reflect the modification of the wear pattern, identifying the second session at the second device as associated with the first scene; in response to identifying the second session, transmitting information identifying the modification of the wear pattern; and causing, on a computer screen of the second device, showing a garment preview image on the computer screen including the jeans base image and selected wear pattern, with modified sizing or modified positioning, or a combination.

The method may include conflict resolution for changes. The method includes before transmitting information identifying the modification of the wear pattern, comparing a first timestamp of the modification of the wear pattern from the first device with a second timestamp of another modification of the wear pattern from a third device; and if the first timestamp is after the second timestamp, determining to transfer the modification of the wear pattern from the first device.

The method may include feature locking. The method includes before receiving the modification of the wear pattern, receiving, from the first device, that the wear pattern has been selected for modification; in response to receiving that the wear pattern has been selected for modification, updating the first scene to reflect that the wear pattern has been selected for modification; in response to updating the first scene to reflect that the wear pattern has been selected for modification, identifying the second session at the second device as associated with the first scene; and in response to identifying the second session, transmitting to the second device instructions to prevent the modification of the wear pattern.

The method may include a second device making modifications. The method includes: receiving, from the second device, modification of a sizing of the wear pattern relative to a jeans base image or a position of the wear pattern relative to a jeans base image; in response to receiving the modification of the wear pattern on the second device, updating the first scene to reflect the modification of the wear pattern; in response to updating the first scene to reflect the modification of the wear pattern, identifying the first session at the first device as associated with the first scene; in response to identifying the first session, transmitting information identifying the modification of the wear pattern; and causing, on a computer screen of the first device, showing a garment preview image on the computer screen including the jeans base image and selected wear pattern, with modified sizing or modified positioning, or a combination.

The method may include before transmitting information identifying the modification of the wear pattern, comparing a first timestamp of the modification of the wear pattern from the second device with a second timestamp of another modification of the wear pattern from a third device; and if the first timestamp is after the second timestamp, determining to transfer the modification of the wear pattern from the second device.

The method may include before receiving the modification of the wear pattern, receiving, from the second device, that the wear pattern has been selected for modification; in response to receiving that the wear pattern has been selected for modification, updating the first scene to reflect that the wear pattern has been selected for modification; in response to updating the first scene to reflect that the wear pattern has been selected for modification, identifying the first session at the first device as associated with the first scene; and, in response to identifying the first session, transmitting to the first device instructions to prevent the modification of the wear pattern.

The method includes granting access to the first scene via a third session of the garment previewing tool on a third device; in response to updating the first scene to reflect the selected wear pattern, identifying the third session at the third device as associated with the first scene; in response to identifying the third session, transmitting information identifying the selected wear pattern and the selected garment base to the third device.

The method includes wherein the first and second sessions are concurrently or asynchronously accessing the garment previewing tool.

The method may include the garment previewing tool allowing changes to a wear pattern. The method includes where the garment previewing tool on the first device includes: providing an option for the user to select the garment base and upon the user's selection, showing a first garment preview image on the computer screen including a

jeans base image for the selected garment base, providing an option for the user to select a wear pattern from a menu of wear patterns, where each wear pattern is associated with a laser input file to be used by a laser to produce that wear pattern onto a jeans garment, after the wear pattern is selected, showing a second garment preview image on the computer screen including the selected wear pattern in combination with the jeans base image, where the second garment preview image replaces the first garment preview image, in the second garment preview image, allowing the user to select the wear pattern and modify a sizing of the wear pattern relative to the jeans base image, where as the user makes changes, the modified sizing of the wear pattern is displayed to the user in response to selecting the wear pattern, in the second garment preview image, allowing the user to select the wear pattern and modify a position of the wear pattern relative to the jeans base image, where as the user makes changes, the modified positioning of the wear pattern is displayed to the user in response to modifying the position of the wear pattern, and showing a third garment preview image on the computer screen including the jeans base image and selected wear pattern, with modified sizing or modified positioning, or a combination.

The method includes where the target garment is made of at least one of a twill material or a cotton twill material. The method includes: receiving, from the second device, modification of a sizing of the wear pattern relative to a jeans base image or a position of the wear pattern relative to a jeans base image; in response to receiving the modification of the wear pattern on the second device, updating the first scene to reflect the modification of the wear pattern; in response to updating the first scene to reflect the modification of the wear pattern, identifying the first session at the first device as associated with the first scene; in response to identifying the first session, transmitting information identifying the modification of the wear pattern to the first device; and causing, on a computer screen of the first device, showing a garment preview image on the computer screen including the jeans base image and selected wear pattern, with modified sizing or modified positioning, or a combination.

The method may include a text chat feature. The method includes: receiving a text message from the first device to associate with the first session; in response to receiving the text message, identifying the second session at the second device as associated with the first scene; and in response to identifying the second session, transmitting the text message to the second device.

Other objects, features, and advantages of the present invention will become apparent upon consideration of the following detailed description and the accompanying drawings, in which like reference designations represent like features throughout the figures.

BRIEF DESCRIPTION OF THE DRAWINGS

FIG. 1 shows a block diagram of a system for creating, designing, producing apparel products with laser finishing.

FIG. 2 shows a flow for a finishing technique that includes the use of a laser.

FIG. 3 shows a weave pattern for a denim fabric.

FIGS. 4-7 show how the laser alters the color of ring-dyed yarn.

FIG. 8 shows a flow for finishing in two finishing steps and using base templates.

FIG. 9 shows multiple base templates and multiple resulting finished products from each of these templates.

FIG. 10 shows a distributed computer network.

FIG. 11 shows a computer system that can be used in laser finishing.

FIG. 12 shows a system block diagram of the computer system.

FIGS. 13-14 show examples of mobile devices.

FIG. 15 shows a system block diagram of a mobile device.

FIG. 16 shows a block diagram of a system for creating, designing, producing apparel products with laser finishing.

FIG. 17 shows a block diagram of a specific implementation of a preview tool.

FIG. 18 shows a block diagram of a brief tool.

FIG. 19 shows a technique of generating a preview of a finished image using a brief tool.

FIG. 20 shows a block diagram of a technique of generating a preview of a laser finishing pattern on a garment.

FIG. 21 shows a system diagram for a real-time collaboration tool.

FIG. 22 shows a flow of a system including the real-time collaboration tool.

FIG. 23 shows a first user using first tablet at a first location collaborating with a second user using second tablet at a second location.

FIG. 24 shows a chat feature.

FIG. 25 shows a white board collaboration feature.

FIG. 26 shows a mark-up collaboration feature.

FIG. 27 shows a system diagram for an assortment builder tool.

FIG. 28 shows a flow for a system including the assortment builder tool.

FIG. 29 shows a search using the assortment builder tool.

FIG. 30 shows a zoomed view of a listing of garments.

FIG. 31 shows an assortment 1 and its associated detailed product lifecycle management data.

FIG. 32 shows a zoomed view of a listing of garments.

DETAILED DESCRIPTION OF THE INVENTION

FIG. 1 shows a process flow 101 for manufacturing apparel such as jeans, where garments are finished using a laser. The fabric or material for various apparel including jeans is made from natural or synthetic fibers 106, or a combination of these. A fabric mill takes fibers and processes 109 these fibers to produce a laser-sensitive finished fabric 112, which has enhanced response characteristics for laser finishing.

Some examples of natural fibers include cotton, flax, hemp, sisal, jute, kenaf, and coconut; fibers from animal sources include silk, wool, cashmere, and mohair. Some examples of synthetic fibers include polyester, nylon, spandex or elastane, and other polymers. Some examples of semisynthetic fibers include rayon, viscose, modal, and lyocell, which are made from a regenerated cellulose fiber. A fabric can be a natural fiber alone (e.g., cotton), a synthetic fiber alone (e.g., polyester alone), a blend of natural and synthetic fibers (e.g., cotton and polyester blend, or cotton and spandex), or a blend of natural and semisynthetic fibers, or any combination of these or other fibers.

For jeans, the fabric is typically a denim, which is a sturdy cotton warp-faced textile in which a weft passes under two or more warp threads. This twill weaving produces a diagonal ribbing. The yarns (e.g., warp yarns) are dyed using an indigo or blue dye, which is characteristic of blue jeans.

Although this patent describes the apparel processing and finishing with respect to jeans, the invention is not limited jeans or denim products, such as shirts, shorts, jackets, vests, and skirts. The techniques and approaches described are

applicable to other apparel and products, including non-denim products and products made from knit materials. Some examples include T-shirts, sweaters, coats, sweatshirts (e.g., hoodies), casual wear, athletic wear, outerwear, dresses, evening wear, sleepwear, loungewear, underwear, socks, bags, backpacks, uniforms, umbrellas, swimwear, bed sheets, scarves, and many others.

A manufacturer creates a design 115 (design I) of its product. The design can be for a particular type of clothing or garment (e.g., men's or women's jean, or jacket), sizing of the garment (e.g., small, medium, or large, or waist size and inseam length), or other design feature. The design can be specified by a pattern or cut used to form pieces of the pattern. A fabric is selected and patterned and cut 118 based on the design. The pattern pieces are assembled together 121 into the garment, typically by sewing, but can be joined together using other techniques (e.g., rivets, buttons, zipper, hoop and loop, adhesives, or other techniques and structures to join fabrics and materials together).

Some garments can be complete after assembly and ready for sale. However, other garments are unfinished 122 and have additional finishing 124, which includes laser finishing. The finishing may include tinting, washing, softening, and fixing. For distressed denim products, the finishing can include using a laser to produce a wear pattern according to a design 127 (design II). Some additional details of laser finishing are described in U.S. patent application 62/377,447, filed Aug. 19, 2016, and Ser. No. 15/682,507, filed Aug. 21, 2017, issued as U.S. Pat. No. 10,051,905 on Aug. 21, 2018, are incorporated by reference along with all other references cited in this application. U.S. patent applications 62/636,108, filed Feb. 27, 2018, and 62/715,788, filed Aug. 7, 2018, describe some specific implementations of a brief builder application and are incorporated by reference.

U.S. patent application Ser. Nos. 16/288,035, 16/288,036, 16/288,042, 16/288,046, 16/288,047, 16/288,048, 16/288,050, 16/288,053, and 16/288,054, filed Feb. 27, 2019, are incorporated by reference.

Design 127 is for postassembly aspects of a garment while design 115 is for preassembly aspects of a garment. After finishing, a finished product 130 (e.g., a pair of jeans) is complete and ready for sale. The finished product is inventoried and distributed 133, delivered to stores 136, and sold to consumers or customers 139. The consumer can buy and wear worn blue jeans without having to wear out the jeans themselves, which usually takes significant time and effort.

Traditionally, to produce distressed denim products, finishing techniques include dry abrasion, wet processing, oxidation, or other techniques, or combinations of these, to accelerate wear of the material in order to produce a desired wear pattern. Dry abrasion can include sandblasting or using sandpaper. For example, some portions or localized areas of the fabric are sanded to abrade the fabric surface. Wet processing can include washing in water, washing with oxidizers (e.g., bleach, peroxide, ozone, or potassium permanganate), spraying with oxidizers, washing with abrasives (e.g., pumice, stone, or grit).

These traditional finishing approaches take time, incur expense, and impact the environment by utilizing resources and producing waste. It is desirable to reduce water and chemical usage, which can include eliminating the use agents such as potassium permanganate and pumice. An alternative to these traditional finishing approaches is laser finishing.

FIG. 2 shows a finishing technique that includes the use of a laser 207. A laser is a device that emits light through a

process of optical amplification based on the stimulated emission of electromagnetic radiation. Lasers are used for bar code scanning, medical procedures such as corrective eye surgery, and industrial applications such as welding. A particular type of laser for finishing apparel is a carbon dioxide laser, which emits a beam of infrared radiation.

The laser is controlled by an input file **210** and control software **213** to emit a laser beam onto fabric at a particular position or location at a specific power level for a specific amount of time. Further, the power of the laser beam can be varied according to a waveform such as a pulse wave with a particular frequency, period, pulse width, or other characteristic. Some aspects of the laser that can be controlled include the duty cycle, frequency, marking or burning speed, and other parameters.

The duty cycle is a percentage of laser emission time. Some examples of duty cycle percentages include 40, 45, 50, 55, 60, 80, and 100 percent. The frequency is the laser pulse frequency. A low frequency might be, for example, 5 kilohertz, while a high frequency might be, for example, 25 kilohertz. Generally, lower frequencies will have higher surface penetration than high frequencies, which has less surface penetration.

The laser acts like a printer and “prints,” “marks,” or “burns” a wear pattern (specified by input file **210**) onto the garment. The fabric that is exposed to the laser beam (e.g., infrared beam) changes color, lightening the fabric at a specified position by a certain amount based on the laser power, time of exposure, and waveform used. The laser continues from position to position until the wear pattern is completely printed on the garment.

In a specific implementation, the laser has a resolution of about 34 dots per inch (dpi), which on the garment is about 0.7 millimeters per pixel. The technique described in this patent is not dependent on the laser’s resolution, and will work with lasers have more or less resolution than 34 dots per inch. For example, the laser can have a resolution of 10, 15, 20, 25, 30, 40, 50, 60, 72, 80, 96, 100, 120, 150, 200, 300, or 600 dots per inch, or more or less than any of these or other values. Typically, the greater the resolution, the finer the features that can be printed on the garment in a single pass. By using multiple passes (e.g., 2, 3, 4, 5, or more passes) with the laser, the effective resolution can be increased. In an implementation, multiple laser passes are used.

Jeans are dyed using an indigo dye, which results in a blue colored fabric. The blue color is caused by chromophores trapped in the fabric which reflect light as a blue color. U.S. patent application 62/433,739, filed Dec. 13, 2016, which is incorporated by reference, describes a denim material with enhanced response characteristics to laser finishing. Using a denim material made from indigo ring-dyed yarn, variations in highs and lows in indigo color shading is achieved by using a laser.

FIG. 3 shows a weave pattern of a denim fabric **326**. A loom does the weaving. In weaving, warp is the lengthwise or longitudinal yarn or thread in a roll, while weft or woof is the transverse thread. The weft yarn is drawn through the warp yarns to create the fabric. In FIG. 3, the warps extend in a first direction **335** (e.g., north and south) while the wefts extend in a direction **337** (e.g., east and west). The wefts are shown as a continuous yarn that zigzags across the wefts (e.g., carried across by a shuttle or a rapier of the loom). Alternatively, the wefts could be separate yarns. In some specific implementations, the warp yarn has a different weight or thickness than the weft yarns. For example, warp yarns can be coarser than the weft yarns.

For denim, dyed yarn is used for the warp, and undyed or white yarn is typically used for the weft yarn. In some denim fabrics, the weft yarn can be dyed and have a color other than white, such as red. In the denim weave, the weft passes under two or more warp threads. FIG. 3 shows a weave with the weft passing under two warp threads. Specifically, the fabric weave is known as a 2×1 right-hand twill. For a right-hand twill, a direction of the diagonal is from a lower left to an upper right. For a left-hand twill, a direction of the diagonal is from a lower right to an upper left. But in other denim weaves, the weft can pass under a different number of warp threads, such as 3, 4, 5, 6, 7, 8, or more. In other implementation, the denim is a 3×1 right-hand twill, which means the weft passes under three warp threads.

Because of the weave, one side of the fabric exposes more of the warp yarns (e.g., warp-faced side), while the other side exposes more of the weft yarns (e.g., weft-faced side). When the warp yarns are blue and weft yarns are white, a result of the weave is the warp-faced side will appear mostly blue while the reverse side, weft-faced side, will appear mostly white.

In denim, the warp is typically 100 percent cotton. But some warp yarns can be a blend with, for example, elastane to allow for warp stretch. And some yarns for other fabrics may contain other fibers, such as polyester or elastane as examples.

In an indigo ring-dyed yarn, the indigo does not fully penetrate to a core of the yarn. Rather, the indigo dye is applied at a surface of the cotton yarn and diffuses toward the interior of the yarn. So when the yarn is viewed cross-sectionally, the indigo dyed material will appear as a ring on around an outer edge of the yarn. The shading of the indigo dye will generally lighten in a gradient as a distance increases from the surface of the yarn to the center (or core) of the yarn.

During laser finishing, the laser removes a selected amount of the surface of the indigo dyed yarn (e.g., blue color) to reveal a lighter color (e.g., white color) of the inner core of the ring-dyed yarn. The more of the indigo dyed material that is removed, the lighter the color (e.g., lighter shade of blue). The more of the indigo dyed material that remains, the darker the color (e.g., deeper shade of blue). The laser can be controlled precisely to remove a desired amount of material to achieve a desired shade of blue in a desired place or position on the material.

With laser finishing, a finish can be applied (e.g., printed or burned via the laser) onto apparel (e.g., jeans and denim garments) that will appear similar to or indistinguishable from a finish obtained using traditional processing techniques (e.g., dry abrasion, wet processing, and oxidation). Laser finishing of apparel is less costly and is faster than traditional finishing techniques and also has reduced environmental impact (e.g., eliminating the use of harsh chemical agents and reducing waste).

FIGS. 4-7 show how the laser alters the color of ring-dyed yarn. FIG. 4 shows a laser beam **407** striking a ring-dyed yarn **413** having indigo-dyed fibers **418** and white core fibers **422**. The laser removes the dyed fibers, which can be by vaporizing or otherwise destroying the cotton fiber via heat or high temperature that the laser beam causes.

FIG. 5 shows the laser using a first power level setting or first exposure time setting, or a combination of these, to remove some of the dyed fibers, but not revealing any of the white core fibers. The undyed fibers remain covered. There is no color change.

FIG. 6 shows the laser using a second power level setting or second exposure time setting, or a combination of these,

to remove more of the dyed fibers than in FIG. 5. The second power level is greater than the first power level, or the second exposure time setting is greater than the first exposure time setting, or a combination of these. The result is some of the undyed fibers are revealed. There is a color change, subtle highlighting.

FIG. 7 shows the laser using a third power level setting or third exposure time setting, or a combination of these, to remove even more of the dyed fibers than in FIG. 6. The third power level is greater than the second power level, or the third exposure time setting is greater than the second exposure time setting, or a combination of these. The result is more of the undyed fibers are revealed. There is a color change, brighter highlighting.

As shown in FIG. 2, before laser 207, the fabric can be prepared 216 for the laser, which may be referred to as a base preparation, and can include a prelaser wash. This step helps improve the results of the laser. After the laser, there can be a postlaser wash 219. This wash can clean or remove any residue caused by the laser, such as removing any charring (which would appear as brown or slightly burning). There can be additional finish 221, which may be including tinting, softening, or fixing, to complete finishing.

FIG. 8 shows a technique where finishing 124 is divided into two finishing steps, finishing I and finishing II. Finishing I 808 is an initial finishing to create base templates 811. With finishing II 814, each base template can be used to manufacture multiple final finishes 817.

FIG. 9 shows multiple base templates, base A, base B, and base C. These base templates may be referred to as base fit fabrics or BFFs. In an implementation, the base templates can be created during base prep and prelaser wash 216 (see FIG. 2). During finishing I, by using different wash 216 methods or recipes, each different base template can be created.

Finishing II can include laser finishing. Base A is lasered with different designs to obtain various final product based on base A (e.g., FP(A)1 to FP(A)i, where i is an integer). Base B is lasered with different designs to obtain various final products based on base B (e.g., FP(B)1 to FP(B)j, where j is an integer). Base C is lasered with different designs to obtain various final products based on base C (e.g., FP(C)1 to FP(C)k, where k is an integer). Each base can be used to obtain a number of different final designs. For example, the integers i, j, and k can have different values.

As described above and shown in FIG. 2, after finishing II, there can be additional finishing during post laser wash 219 and additional finishing 221. For example, during the postlaser wash, there may be additional tinting to the lasered garments. This tinting can result in an overall color cast to change the look of the garment.

In an implementation, laser finishing is used to create many different finishes (each a different product) easily and quickly from the same fabric template or BFF or "blank." For each fabric, there will be a number of base fit fabrics. These base fit fabrics are lasered to produce many different finishes, each being a different product for a product line. Laser finishing allows greater efficiency because by using fabric templates (or base fit fabrics), a single fabric or material can be used to create many different products for a product line, more than is possible with traditional processing. This reduces the inventory of different fabric and finish raw materials.

For a particular product (e.g., 511 product), there can be two different fabrics, such as base B and base C of FIG. 9. The fabrics can be part of a fabric tool kit. For base B, there are multiple base fit fabrics, FP(B)1, FP(B)2, and so forth.

Using laser finishing, a base fit fabric (e.g., FP(B)1) can be used to product any number of different finishes (e.g., eight different finishes), each of which would be considered a different product model.

For example, FP(B)1 can be laser finished using different laser files (e.g., laser file 1, laser file 2, laser file 3, or others) or have different postlaser wash (e.g., postlaser wash recipe 1, postlaser wash recipe 2, postlaser wash recipe 3, or others), or any combination of these. A first product would be base fit fabric FP(B)1 lasered using laser file 1 and washed using postlaser wash recipe 1. A second product would be base fit fabric FP(B)1 lasered using laser file 2 and washed using postlaser wash recipe 1. A third product would be base fit fabric FP(B)1 lasered using laser file 2 and washed using postlaser wash recipe 2. And there can be many more products based on the same base fit fabric. Each can have a different product identifier or unique identifier, such as a different PC9 or nine-digit product code.

With laser finishing, many products or PC9s are produced for each base fit fabric or blank. Compared to traditional processing, this is a significant improvement in providing greater numbers of different products with less different fabrics and finishes (each of which in traditional processing consume resources, increasing cost, and take time). Inventory is reduced. The technique of providing base fit finishes or fabric templates for laser finishing has significant and many benefits.

A system incorporating laser finishing can include a computer to control or monitor operation, or both. FIG. 10 shows an example of a computer that is component of a laser finishing system. The computer may be a separate unit that is connected to a system, or may be embedded in electronics of the system. In an embodiment, the invention includes software that executes on a computer workstation system or server, such as shown in FIG. 10.

FIG. 10 is a simplified block diagram of a distributed computer network 1000 incorporating an embodiment of the present invention. Computer network 1000 includes a number of client systems 1013, 1016, and 1019, and a server system 1022 coupled to a communication network 1024 via a plurality of communication links 1028. Communication network 1024 provides a mechanism for allowing the various components of distributed network 1000 to communicate and exchange information with each other.

Communication network 1024 may itself be comprised of many interconnected computer systems and communication links. Communication links 1028 may be hardwire links, optical links, satellite or other wireless communications links, wave propagation links, or any other mechanisms for communication of information. Communication links 1028 may be DSL, Cable, Ethernet or other hardwire links, passive or active optical links, 3G, 3.5G, 4G and other mobility, satellite or other wireless communications links, wave propagation links, or any other mechanisms for communication of information.

Various communication protocols may be used to facilitate communication between the various systems shown in FIG. 10. These communication protocols may include VLAN, MPLS, TCP/IP, Tunneling, HTTP protocols, wireless application protocol (WAP), vendor-specific protocols, customized protocols, and others. While in one embodiment, communication network 1024 is the Internet, in other embodiments, communication network 1024 may be any suitable communication network including a local area network (LAN), a wide area network (WAN), a wireless network, an intranet, a private network, a public network, a switched network, and combinations of these, and the like.

11

Distributed computer network **1000** in FIG. **10** is merely illustrative of an embodiment incorporating the present invention and does not limit the scope of the invention as recited in the claims. One of ordinary skill in the art would recognize other variations, modifications, and alternatives. For example, more than one server system **1022** may be connected to communication network **1024**. As another example, a number of client systems **1013**, **1016**, and **1019** may be coupled to communication network **1024** via an access provider (not shown) or via some other server system.

Client systems **1013**, **1016**, and **1019** typically request information from a server system which provides the information. For this reason, server systems typically have more computing and storage capacity than client systems. However, a particular computer system may act as both as a client or a server depending on whether the computer system is requesting or providing information. Additionally, although aspects of the invention have been described using a client-server environment, it should be apparent that the invention may also be embodied in a standalone computer system.

Server **1022** is responsible for receiving information requests from client systems **1013**, **1016**, and **1019**, performing processing required to satisfy the requests, and for forwarding the results corresponding to the requests back to the requesting client system. The processing required to satisfy the request may be performed by server system **1022** or may alternatively be delegated to other servers connected to communication network **1024**.

Client systems **1013**, **1016**, and **1019** enable users to access and query information stored by server system **1022**. In a specific embodiment, the client systems can run as a standalone application such as a desktop application or mobile smartphone or tablet application. In another embodiment, a “Web browser” application executing on a client system enables users to select, access, retrieve, or query information stored by server system **1022**. Examples of Web browsers include the Internet Explorer browser program provided by Microsoft Corporation, Firefox browser provided by Mozilla, Chrome browser provided by Google, Safari browser provided by Apple, and others.

In a client-server environment, some resources (e.g., files, music, video, or data) are stored at the client while others are stored or delivered from elsewhere in the network, such as a server, and accessible via the network (e.g., the Internet). Therefore, the user’s data can be stored in the network or “cloud.” For example, the user can work on documents on a client device that are stored remotely on the cloud (e.g., server). Data on the client device can be synchronized with the cloud.

FIG. **11** shows an exemplary client or server system of the present invention. In an embodiment, a user interfaces with the system through a computer workstation system, such as shown in FIG. **11**. FIG. **11** shows a computer system **1101** that includes a monitor **1103**, screen **1105**, enclosure **1107** (may also be referred to as a system unit, cabinet, or case), keyboard or other human input device **1109**, and mouse or other pointing device **1111**. Mouse **1111** may have one or more buttons such as mouse buttons **1113**.

It should be understood that the present invention is not limited any computing device in a specific form factor (e.g., desktop computer form factor), but can include all types of computing devices in various form factors. A user can interface with any computing device, including smartphones, personal computers, laptops, electronic tablet devices, global positioning system (GPS) receivers, portable media players, personal digital assistants (PDAs), other

12

network access devices, and other processing devices capable of receiving or transmitting data.

For example, in a specific implementation, the client device can be a smartphone or tablet device, such as the Apple iPhone (e.g., Apple iPhone 6), Apple iPad (e.g., Apple iPad, Apple iPad Pro, or Apple iPad mini), Apple iPod (e.g., Apple iPod Touch), Samsung Galaxy product (e.g., Galaxy S series product or Galaxy Note series product), Google Nexus and Pixel devices (e.g., Google Nexus 6, Google Nexus 7, or Google Nexus 9), and Microsoft devices (e.g., Microsoft Surface tablet). Typically, a smartphone includes a telephony portion (and associated radios) and a computer portion, which are accessible via a touch screen display.

There is nonvolatile memory to store data of the telephone portion (e.g., contacts and phone numbers) and the computer portion (e.g., application programs including a browser, pictures, games, videos, and music). The smartphone typically includes a camera (e.g., front facing camera or rear camera, or both) for taking pictures and video. For example, a smartphone or tablet can be used to take live video that can be streamed to one or more other devices.

Enclosure **1107** houses familiar computer components, some of which are not shown, such as a processor, memory, mass storage devices **1117**, and the like. Mass storage devices **1117** may include mass disk drives, floppy disks, magnetic disks, optical disks, magneto-optical disks, fixed disks, hard disks, CD-ROMs, recordable CDs, DVDs, recordable DVDs (e.g., DVD-R, DVD+R, DVD-RW, DVD+RW, HD-DVD, or Blu-ray Disc), flash and other nonvolatile solid-state storage (e.g., USB flash drive or solid state drive (SSD)), battery-backed-up volatile memory, tape storage, reader, and other similar media, and combinations of these.

A computer-implemented or computer-executable version or computer program product of the invention may be embodied using, stored on, or associated with computer-readable medium. A computer-readable medium may include any medium that participates in providing instructions to one or more processors for execution. Such a medium may take many forms including, but not limited to, nonvolatile, volatile, and transmission media. Nonvolatile media includes, for example, flash memory, or optical or magnetic disks. Volatile media includes static or dynamic memory, such as cache memory or RAM. Transmission media includes coaxial cables, copper wire, fiber optic lines, and wires arranged in a bus. Transmission media can also take the form of electromagnetic, radio frequency, acoustic, or light waves, such as those generated during radio wave and infrared data communications.

For example, a binary, machine-executable version, of the software of the present invention may be stored or reside in RAM or cache memory, or on mass storage device **1117**. The source code of the software of the present invention may also be stored or reside on mass storage device **1117** (e.g., hard disk, magnetic disk, tape, or CD-ROM). As a further example, code of the invention may be transmitted via wires, radio waves, or through a network such as the Internet.

FIG. **12** shows a system block diagram of computer system **1101** used to execute the software of the present invention. As in FIG. **11**, computer system **1101** includes monitor **1103**, keyboard **1109**, and mass storage devices **1117**. Computer system **1101** further includes subsystems such as central processor **1202**, system memory **1204**, input/output (I/O) controller **1206**, display adapter **1208**, serial or universal serial bus (USB) port **1212**, network interface **1218**, and speaker **1220**. The invention may also be used with computer systems with additional or fewer subsystems. For example, a computer system could include

13

more than one processor **1202** (i.e., a multiprocessor system) or a system may include a cache memory.

Arrows such as **1222** represent the system bus architecture of computer system **1101**. However, these arrows are illustrative of any interconnection scheme serving to link the subsystems. For example, speaker **1220** could be connected to the other subsystems through a port or have an internal direct connection to central processor **1202**. The processor may include multiple processors or a multicore processor, which may permit parallel processing of information. Computer system **1101** shown in FIG. **12** is but an example of a computer system suitable for use with the present invention. Other configurations of subsystems suitable for use with the present invention will be readily apparent to one of ordinary skill in the art.

Computer software products may be written in any of various suitable programming languages, such as C, C++, C#, Pascal, Fortran, Perl, MATLAB (from MathWorks, www.mathworks.com), SAS, SPSS, JavaScript, AJAX, Java, Python, Erlang, and Ruby on Rails. The computer software product may be an independent application with data input and data display modules. Alternatively, the computer software products may be classes that may be instantiated as distributed objects. The computer software products may also be component software such as Java Beans (from Oracle Corporation) or Enterprise Java Beans (EJB from Oracle Corporation).

An operating system for the system may be one of the Microsoft Windows® family of systems (e.g., Windows 95, 98, Me, Windows NT, Windows 2000, Windows XP, Windows XP x64 Edition, Windows Vista, Windows 7, Windows 8, Windows 10, Windows CE, Windows Mobile, Windows RT), Symbian OS, Tizen, Linux, HP-UX, UNIX, Sun OS, Solaris, Mac OS X, Apple iOS, Android, Alpha OS, AIX, IRIX32, or IRIX64. Other operating systems may be used. Microsoft Windows is a trademark of Microsoft Corporation.

Any trademarks or service marks used in this patent are property of their respective owner. Any company, product, or service names in this patent are for identification purposes only. Use of these names, logos, and brands does not imply endorsement.

Furthermore, the computer may be connected to a network and may interface to other computers using this network. The network may be an intranet, internet, or the Internet, among others. The network may be a wired network (e.g., using copper), telephone network, packet network, an optical network (e.g., using optical fiber), or a wireless network, or any combination of these. For example, data and other information may be passed between the computer and components (or steps) of a system of the invention using a wireless network using a protocol such as Wi-Fi (IEEE standards 802.11, 802.11a, 802.11b, 802.11e, 802.11g, 802.11i, 802.11n, 802.11ac, and 802.11ad, just to name a few examples), near field communication (NFC), radio-frequency identification (RFID), mobile or cellular wireless (e.g., 2G, 3G, 4G, 3GPP LTE, WiMAX, LTE, LTE Advanced, Flash-OFDM, HIPERMAN, iBurst, EDGE Evolution, UMTS, UMTS-TDD, 1xRDD, and EV-DO). For example, signals from a computer may be transferred, at least in part, wirelessly to components or other computers.

In an embodiment, with a Web browser executing on a computer workstation system, a user accesses a system on the World Wide Web (WWW) through a network such as the Internet. The Web browser is used to download Web pages or other content in various formats including HTML, XML, text, PDF, and postscript, and may be used to upload

14

information to other parts of the system. The Web browser may use uniform resource identifiers (URLs) to identify resources on the Web and hypertext transfer protocol (HTTP) in transferring files on the Web.

In other implementations, the user accesses the system through either or both of native and nonnative applications. Native applications are locally installed on the particular computing system and are specific to the operating system or one or more hardware devices of that computing system, or a combination of these. These applications (which are sometimes also referred to as “apps”) can be updated (e.g., periodically) via a direct internet upgrade patching mechanism or through an applications store (e.g., Apple iTunes and App store, Google Play store, Windows Phone store, and Blackberry App World store).

The system can run in platform-independent, nonnative applications. For example, client can access the system through a Web application from one or more servers using a network connection with the server or servers and load the Web application in a Web browser. For example, a Web application can be downloaded from an application server over the Internet by a Web browser. Nonnative applications can also be obtained from other sources, such as a disk.

FIGS. **13-14** show examples of mobile devices, which can be mobile clients. Mobile devices are specific implementations of a computer, such as described above. FIG. **13** shows a smartphone device **1301**, and FIG. **14** shows a tablet device **1401**. Some examples of smartphones include the Apple iPhone, Samsung Galaxy, and Google Nexus family of devices. Some examples of tablet devices include the Apple iPad, Apple iPad Pro, Samsung Galaxy Tab, and Google Nexus family of devices.

Smartphone **1301** has an enclosure that includes a screen **1303**, button **1309**, speaker **1311**, camera **1313**, and proximity sensor **1335**. The screen can be a touch screen that detects and accepts input from finger touch or a stylus. The technology of the touch screen can be a resistive, capacitive, infrared grid, optical imaging, or pressure-sensitive, dispersive signal, acoustic pulse recognition, or others. The touch screen is screen and a user input device interface that acts as a mouse and keyboard of a computer.

Button **1309** is sometimes referred to as a home button and is used to exit a program and return the user to the home screen. The phone may also include other buttons (not shown) such as volume buttons and on-off button on a side. The proximity detector can detect a user’s face is close to the phone, and can disable the phone screen and its touch sensor, so that there will be no false inputs from the user’s face being next to screen when talking.

Tablet **1401** is similar to a smartphone. Tablet **1401** has an enclosure that includes a screen **1403**, button **1409**, and camera **1413**. Typically the screen (e.g., touch screen) of a tablet is larger than a smartphone, usually 7, 8, 9, 10, 12, 13, or more inches (measured diagonally).

FIG. **15** shows a system block diagram of mobile device **1501** used to execute the software of the present invention. This block diagram is representative of the components of smartphone or tablet device. The mobile device system includes a screen **1503** (e.g., touch screen), buttons **1509**, speaker **1511**, camera **1513**, motion sensor **1515**, light sensor **1517**, microphone **1519**, indicator light **1521**, and external port **1523** (e.g., USB port or Apple Lightning port). These components can communicate with each other via a bus **1525**.

The system includes wireless components such as a mobile network connection **1527** (e.g., mobile telephone or mobile data), Wi-Fi **1529**, Bluetooth **1531**, GPS **1533** (e.g.,

detect GPS positioning), other sensors **1535** such as a proximity sensor, CPU **1537**, RAM memory **1539**, storage **1541** (e.g. nonvolatile memory), and battery **1543** (lithium ion or lithium polymer cell). The battery supplies power to the electronic components and is rechargeable, which allows the system to be mobile.

FIG. **16** shows a block diagram of a system for creating, designing, producing apparel products with laser finishing. A box line plan **1602** is an internal and interim tool for communication between a merchandising group and design group. Through the box line plan, merchandising can communicate what needs to be designed by the design group. The box line plan can have open slots to be designed **1609**.

There is a digital design tool **1616** merchants and design can use to click and drag finish effects (e.g., laser files) and tint casts over images of base washes in order to visualize possible combinations and build the line visually before the garment finish is actually finished by the laser. The visualizations can be by rendering on a computer system, such as using three-dimensional (3D) graphics.

U.S. patent application 62/433,746, filed Dec. 13, 2016, which is incorporated by reference, describes a system and operating model of apparel manufacture with laser finishing. Laser finishing of apparel products allows an operating model that reduces finishing cost, lowers carrying costs, increases productivity, shortens time to market, be more reactive to trends, reduce product constraints, reduces lost sales and dilution, and more. Improved aspects include design, development, planning, merchandising, selling, making, and delivering. The model uses fabric templates, each of which can be used to produce a multitude of laser finishes. Operational efficiency is improved.

Designers can use the digital design tool to design products that are used to satisfy the requests in open slots **1609**. Designs created using the digital design tool can be stored in a digital library **1622**. Input to the digital design tool include fabric templates or blanks **1627** (e.g., base fit fabrics or BFFs), existing finishes **1633** (e.g., can be further modified by the tool **1616**), and new finishes **1638**. New finishes can be from designs **1641** (e.g., vintage design) captured using a laser finish software tool **1645**, examples of which are described in U.S. patent applications 62/377,447, filed Aug. 19, 2016, and Ser. No. 15/682,507, filed Aug. 21, 2017. Digital library **1622** can be accessible by the region assorting and sell-in **1650**. And the digital library can be used to populate or satisfy the box line plan.

FIG. **17** shows a block diagram of a specific implementation of a digital design tool, a preview tool **1703**. Digital design tool **1616** can be representative of a collection of tools, such as an application suite, including desktop or mobile apps, or a combination.

Preview tool **1703** can be a single tool in a toolbox or toolkit used for laser finishing of garments, or the tool can be incorporated as a feature of another tool. The preview tool allows a user such as a clothing designer to preview on a computer screen or to generate a digital representation (e.g., image file, JPEG file, BMP file, TIFF file, GIF file, PNG file, PSD file, or others) of jeans in a selected base fit fabric or fabric template **1706** with a selected laser pattern **1709** (e.g., from a laser input file). With the digital representation, the user will be able to see or preview the jeans in the selected base fit fabric as if it had been burned with the selected laser input file, without needing to actually laser or burn the jeans.

Some files are described as being of an image file type. Some examples of image file types or file formats include bitmap or raster graphics formats including IMG, TIFF, EXIF, JPEG, GIF, PNG, PBM, PGM, PPM, BMP, and RAW.

The compression for the file can be lossless (e.g., TIFF) or lossy (e.g., JPEG). Other image file types or file formats include vector graphics including DXF, SVG, and the like.

Bitmaps or raster graphics are resolution dependent while vector graphics are resolution independent. Raster graphics generally cannot scale up to an arbitrary resolution without loss of apparent quality. This property contrasts with the capabilities of vector graphics, which generally easily scale up to the quality of the device rendering them.

A raster graphics image is a dot matrix data structure representing a generally rectangular grid of pixels, or points of color, viewable via a monitor, paper, or other display medium. A bitmap, such as a single-bit raster, corresponds bit-for-bit with an image displayed on a screen or output medium. A raster is characterized by the width and height of the image in pixels and by the number of bits per pixel (or color depth, which determines the number of colors it can represent).

The BMP file format is an example of a bitmap. The BMP file format, also known as bitmap image file or device independent bitmap (DIB) file format or simply a bitmap, is a raster graphics image file format used to store bitmap digital images, independently of the display device. The BMP file format is capable of storing two-dimensional digital images of arbitrary width, height, and resolution, both monochrome and color, in various color depths, and optionally with data compression, alpha channels, and color profiles.

The fabric template can be selected from a library of fabric template images **1716** or may be a new image uploaded or provided by the user. Each fabric template images is an image file of a jeans in a base fit fabric or other material. For each jeans model or fit (e.g., models or fits **311**, **501**, **505**, **511**, **515**, **541**, **569**, **721**, and others), there would be one image in each different material or base fit fabric.

The laser input file can be selected from a library of laser input files **1722** (e.g., files created from vintage jeans or from a group of designers), may be a file **1718** created by the user, or may be a file uploaded or provided by the user. For example, the user may have created the laser pattern (contained within a laser input file) manually using a graphical or image editing tool (e.g., Adobe Photoshop and similar photo editing programs). Or the laser pattern may have been created by another, such as selected from a library of laser files. The laser pattern may be generated by a computer or automated process, such as may be used to obtain a laser pattern from vintage jeans. The user will be able to see the results of a burn, make any manual changes or alterations to the pattern (such as additional changes to a vintage jean pattern in a digital image file) and preview the results again. The preview tool allows a user to make and see changes, to the user can obtain feedback faster than having to laser jeans to see the results and also avoiding unneeded waste (e.g., preliminary versions of burned jeans).

Each digital representation can be saved in a separate images, and a group or set of the images can be called brief of collection of jeans. The preview tool can be used for merchandising, such as generating images of a proposed line of products for a particular season, and these images can be shared among members of a team to discuss any additions, changes, or deletions to a collection.

A specific version of the preview tool overlays a fabric template input file and a laser input file, and then generates an image to display them together as a representation of the laser-finished apparel. The laser input file is aligned to the garment in the fabric template input file, so that the positioning of features in the laser input file and at appropriate

positions or places on the garment. The alignment may be by using alignment marks that are in the input files. The alignment may be an automated alignment or scaling, or a combination.

Brightness, intensity, opacity, blending, transparency, or other adjustable parameters for an image layer, or any combination of these, are selected or adjusted for the laser input file, so that when the laser input file is overlaid above the fabric template image, the look of the garment will appear of simulate the look of a garment had been burned by a laser using that laser input file.

Adjustable parameters such as opacity can be used to blend two or more image layers together. For example, a layer's overall opacity determines to what degree it obscures or reveals the layer beneath it. For example, a layer with 1 percent opacity appears nearly transparent, while one with 100 percent opacity appears completely opaque.

Further, a dots per inch (dpi) of the combined image can be adjusted to also more properly simulate the look of a garment more closely with a burned garment. Dots per inch refers to the number of dots in a printed inch. The more dots, the higher the quality of the print (e.g., more sharpness and detail). By reducing the dpi of the image, this will reduce the image quality, resulting a blurring of the image. In an implementation, the preview tool reduces a dpi of the combined image, to be of less dpi than the fabric template input file or the laser input file. By blurring the preview image, this results in improved simulation that corresponds better to a burned laser garment. When burning a garment, the garment material or fabric typically limits the resolution of the result to less than that of the input file.

In an implementation, the dpi of the laser input file is about 72 dpi, while the dpi of the preview image is about 34 dpi. In an implementation, the dpi of the fabric template input file and laser input file are about 36 dpi or above, while the dpi of the preview image is about 36 dpi or lower.

FIG. 18 shows a block diagram of a digital brief tool 1803, which also like preview tool 1703, provides a real-time preview of an appearance of pair of jeans when a finishing pattern is applied by burning using a laser input file. The digital brief tool has additional features to allow more flexible designing of jeans.

It should be understood that the invention is not limited to the specific flows and steps presented. A flow of the invention may have additional steps (not necessarily described in this patent), different steps which replace some of the steps presented, fewer steps or a subset of the steps presented, or steps in a different order than presented, or any combination of these. Further, the steps in other implementations of the invention may not be exactly the same as the steps presented and may be modified or altered as appropriate for a particular application or based on the data or situation.

The digital brief tool takes as input three types of digital assets 1805, fabric template input 1816, damage input 1819, and laser input file 1822. Fabric template input 1816 and laser input file 1822 are similar to the inputs for the preview tool. Damage input 1819 is an image of damage (e.g., holes, rips, shredded regions, or openings of various shapes and sizes) that can be burned by a laser into jeans. The digital brief tool overlays the damage and laser input files over the fabric template.

The user selects a fabric template input, which an image of a jeans style in a particular base fit fabric. The user can optionally select one or more damage inputs. If a damage input is selected, the damage input will be a layer that overlays the fabric template layer. As for the preview tool, the user selects a laser input file with laser pattern and

overlays the fabric template layer. As the user selects the inputs, the user will be able to see in real time the inputs and any changes or updates in a preview image or brief.

After the inputs are selected, the user can select and perform one or more operations 1826 on the inputs using the digital brief tool. These operations including adding tint 1831, adjusting intensity 1834, adjusting bright point 1837, move digital asset 1842, rotate digital asset 1845, scale digital asset 1848, and warp digital asset 1852. As the user selects and performs one or more operations, the user will be able to see in real time the changes or updates in the preview image or brief.

After the fabric template input, the user can add tinting 1831. Tinting will adjust the hue of the color of the fabric template input. Tinting is representative of the tinting which can be added during the postlaser wash or finishing II, described above. The user will be able to select a tint color, and this tint color will be blended with the existing color of the fabric template input. The amount or intensity of the tinting can be increased or decreased, such as by using a slider bar.

The user can adjust intensity 1834. In an implementation, intensity adjusts a weight matrix by a percentage of each value in the array. In an implementation, intensity (or brightness) adjusts an opacity of a generated adjustment layer (see hue saturation lightness adjustment layer described below). The greater the opacity, the more opaque this layer will appear in the preview or brief image. The less the opacity, the less opaque this layer will appear in the preview or brief image; the layer will appear more transparent so that the layer beneath will show through more.

When increasing brightness, the opacity of the adjustment layer increases, and since the adjustment layer is above the fabric template input, the generated adjustment layer will become more prominent or visible, thus making this layer (which has the wear pattern) brighter. Similarly, when decreasing brightness, the opacity of the adjustment layer decreases, the generated adjustment layer will become less prominent or visible, thus making this layer (which has the wear pattern) less bright or fainter. The amount of the intensity can be increased or decreased, such as by using a slider bar.

The user can adjust bright point 1837. Bright point adjusts the effect of the laser input file on the fabric template input. In an implementation, bright point adjustment changes a midpoint of a grayscale, creating a piecewise linear mapping of the pattern file.

Increasing the bright point will increase an effect of the laser pattern (e.g., causing greater laser pattern highlights) in the laser input file on the fabric template input, while decreasing the bright point does the opposite (e.g., diminishing laser pattern highlights). The bright point adjustment can be analogous to changing a pixel time or the time that the laser stays at a particular position for a given input from the laser input file. The amount of the bright point can be increased or decreased, such as by using a slider bar.

The user can move 1842 or reposition a selected digital asset. For example, a damage input (or fabric template or laser file) may be moved to a position desired by the user. The user can rotate 1845 a selected digital asset. For example, a damage input (or fabric template or laser file) may be rotated to any angle relative to the other layers as desired by the user.

The user can scale 1848 a selected digital asset. This scaling can be locked, maintaining the original aspect ratio of the digital asset, or can be unlocked, such that the user can change the aspect ratio. The user can warp 1852 a selected

digital asset. With warping, the user can adjust an aspect ratio of a portion of the digital asset differently from another portion. For example, one portion of a damage input (or fabric template or laser file) can be squished (e.g., right and left edges of image pushed toward each other) while another portion is expanded (e.g., right and left edges of image pulled away from each other).

After the user has performed selected operations **1826**, the digital brief tool shows an image of the jeans with the laser finishing pattern, including any tinting, damage, or other adjustments, as created by the user. This image can be saved and viewed again later. A user can create multiple designs, and these can be saved together as part of a collection.

FIG. **19** shows a technique of generating a preview of a finished image using a digital brief tool. A base image (or fabric template input) is selected. A hue saturation lightness (HSL) adjustment layer is created or generated for the selected base image. The HSL adjustment layer can be the base layer with an adjustment for hue saturation lightness. When tinting is selected, a solid color adjustment layer is created or generated. The solid color adjustment layer has a solid color (e.g., yellow, green, red, blue, or other color that is used for tinting the garment) that is in the same form or outline as the garment (e.g., pants), as indicated by the dotted lines in the figure.

To obtain a final result, which is the final image of the jeans with laser finishing pattern, a laser pattern mask is combined with the base image and HSL adjustment layer. A resulting combination will be based on intensity and bright point settings.

The laser pattern mask is a negative image or reverse image of the laser input file. For the laser input file, during laser burning, a white pixel means the pixel is not lasered (which results in the original indigo color of the fabric), and a black pixel means the pixel will be lasered at highest level (which results in the whitest color that can be achieved on the fabric). In an implementation, the laser input file has 256 levels of gray, and for levels between 0 (e.g., black) and **255** (e.g., white), then the amount of laser burning will be proportionally somewhere in between.

FIG. **20** shows a block diagram of a technique of generating a preview of a laser finishing pattern on a garment, such as jeans. The technique may be embodied in a preview generation tool **2001**. Inputs to a create preview image process **2002** include a base template image **2007** and laser input file **2009**. The base template image is used to create an adjusted base template image **2017**, which is also input to the create preview image process. These create preview image process uses these three inputs to create a preview image **2027**, which can be displayed on a computer screen for the user.

The adjusted base template image is created from the base template image by adjusting its hue, saturation, or lightness, or any combination of these. Compared to the original base template image, the adjusted base template image will appear washed out or bleached. In other words, the adjusted base template image will appear as if the garment in the base template image were fully bleached or lasered. The adjusted base template image can be an HLS adjustment layer as discussed above.

Digital Brief Tool

Embodiments of a digital brief tool (or garment preview tool) may execute on Apple Inc.'s iPad Pro tablet computer device. Although the screens portray the digital brief tool as executing on an iPad Pro, other suitable electronic devices may execute the digital brief tool. For example, the digital brief tool may execute on a Windows device (e.g., Windows

10 tablet), an Android device, other iPad product family models (e.g., iPad or iPad mini), or many other devices.

The iPad Pro 12.9 is a tablet device with rectangular dimensions of 12 inches by 8.68 inch, and is 0.27 inches thick. The iPad Pro has a 12.9-inch screen, and has non-volatile memory storage of 64, 256, or 512 gigabytes. The iPad Pro has network connectivity via Wi-Fi and optionally cellular. The iPad Pro has an A10X Fusion chip with 64-bit architecture and an embedded M10 coprocessor. Some features of the digital brief tool can be accelerated by using specialized features available in the A10X Fusion chip or embedded M10 coprocessor, or both. An operating system of the iPad Pro is Apple iOS 11 (or greater when released). Further, the iPad Pro can be operated with a stylus, the Apple Pencil product. And in an implementation, the user can use the Apple Pencil with the digital brief tool.

The digital brief tool includes various features, allowing a designer to select, create, and visualize how an apparel item will look with certain characteristics, before the apparel item is produced. The digital brief tool may allow the designer, for one or more characteristics of a proposed apparel item, to assign one or more options to each of the characteristics. While assigning the options for characteristics, the digital brief tool allows the designer to see, based on currently assigned options, how the apparel item may appear when produced, in real time as changes are made.

Selecting gender, series, fit, fabric, or other characteristics in the digital brief tool may result in having only relevant options presented to the designer. For example, some characteristics or options may be specific to a particular gender. Upon selection of the particular gender, characteristics and options with the selected gender will appear for the designer to use for a proposed apparel item.

In an implementation, the digital brief tool is adapted for use with producing jeans. For example, the following figures may include various characteristics and options relevant to designing and stylizing of jeans. However, the digital brief tool may be adapted for use with other apparel items, such as shirts, jackets, pants, or socks.

Embodiments of the digital brief tool are discussed in greater details in U.S. application Ser. Nos. 16/177,387, 16/177,412, and 16/177,407, all filed Oct. 31, 2018, and are incorporated by reference.

Real-Time Collaboration

FIGS. **21-26** describe a real-time collaboration tool of a laser finishing design tool, such as a digital brief tool (e.g., digital brief tool **1803** of FIG. **18**). The real-time collaboration tool may be used in the system for creating, designing, producing apparel products with laser finishing as shown in FIG. **16**. The real-time collaboration tool allows two people in different locations to collaborate using the digital brief tool. For example, there may two or more designers that are working on the same apparel or apparel collection. The designers may be designers associated with an apparel manufacturer, a retailer, a brand designer, or a combination of any of these. It may be difficult for the designers to collaborate in the process of developing apparel together, as opposed to sharing finished apparel designs. With the real-time collaboration tool, the designers may discuss with each other, at any stage of the design process, and get feedback from each other as to what works and what does not. The designers may also propose changes with each other and show other designers how the changes may appear if accepted, so that they can have a better idea of how their proposed changes may appear and whether they are acceptable.

FIG. 21 shows a system diagram for a real-time collaboration tool. The tool includes a real-time collaboration server **2101** including a changes feature that receives changes from different designers connected onto the digital brief tool **1803**, such as designers **2103** and **2105**. The designers may be connected to the tool with their own respective session, and the session may be related to a document that stores changes to a project, such as a design project for a garment. In an implementation, the real-time collaboration tool includes a real-time database server where each collaborating user is connected to the real-time database server and associated with a unique session. This session includes a garment to be modified and other sessions by other users may be connected onto the same session at the same time or at different times. A document may be stored that describes the scene and all of the modifications being made to a garment project. When a user makes a modification to the garment on the front end that change is also logged on the back end to the shared document within the session and is reflected on the screen of the other users in that session.

The tool includes a conflict feature, which reconciles differences or changes from the designers. For example, the conflict feature may lock certain features of the digital brief tool, to prevent the designers from working on the same change by both designers at the same time. The tool includes an update feature that, depending on whether a change is valid (e.g., conflict feature has approved a change, a change does not violate rules of the digital brief tool), will commit the changes to the document for the garment.

FIG. 22 shows a flow of a system including the real-time collaboration tool. In a step **2201**, the system includes providing a garment previewing tool. The garment previewing tool may be the digital brief tool, as described elsewhere in this application. The digital brief may provide various options for a user, such as providing options for the user to select a base garment image. For example, the base garment image may be a jeans base garment. The base garment image may be composed of any material suitable for laser finishing. The user may also select a wear pattern, associated with a laser pattern file that may be processed to create the wear pattern onto a target garment corresponding to the base garment image. The user may also modify the position, the sizing, or a combination, of the wear pattern. For example, as the base garment image is shown, the user may modify the position, the sizing, or the combination, of the wear pattern. In response to, or in near real-time, the system may show to the user the modifications, without needing to first manufacture the target garment.

In a step **2203**, the system includes granting first and second devices access to the tool. For example, the first and second devices may connect over a network to the system. Each device may include their own session, and each session is associated to a scene where a first garment is being designed.

In a step **2205**, the system includes the first device associating a first garment base with a selected wear pattern and transmitting an update. The first device may also provide a location for where, in an image of the first garment base, the selected wear pattern appears. The update is transmitted to a real-time collaboration server, in response to the update.

In a step **2207**, the system includes identifying that the second session at the second device is granted access to the first scene. For example, the real-time collaboration server performs a lookup to see which devices have been granted an active session to the first scene. There may be multiple devices connected onto the system, but some devices may

not be granted access to the first scene or, having previously been granted access to the first scene, have had their rights to access the first scene revoked. Rights to access a certain scene may be provided by an administrator of the system or shared by a user or device that already has access to a scene.

In an implementation, the system may need to determine whether one or more updates to a scene are the latest changes to the scene. For example, each update transmitted to the real-time collaboration server may include a time-stamp. The system may process the updates, to determine whether any of the updates conflict. For example, if a wear pattern has been repositioned twice, during a first and second updates. If the timestamp associated with the first update is after the second update, the system will determine that the first update is a valid update and choose not to transmit the second update in response to a request for the scene.

In a step **2209**, the system includes updating the second device with the first scene. For example, the first scene may include the update made at the first device. A user of the second device may display the first garment base and wear pattern with updates and approve or deny the updates. The second device may provide additional updates to the selected wear pattern, such as further updating a sizing or position of the selected wear pattern. Changes made at the second device are transmitted to the real-time collaboration server, where they may be retrieved for viewing at the first device.

In an implementation, the first and second devices do not need to be connected to the system at the same time. For example, a first device may make changes to a scene and, when the second device connects onto the system, the latest changes to the scene are transmitted in a batch transfer to the second device.

In a step **2213**, the system includes providing a target garment and creating the wear pattern on the target garment. The target garment includes a real-world version of the base garment selected by the user. For example, the target garment is a pair of jeans, adapted for laser finishing. From the input with modified sizing or positioning from the user, the target garment is finished with the wear pattern.

FIG. 23 shows a first user using first tablet at a first location collaborating with a second user using second tablet at a second location. For example, the users can be in same room, different offices, different buildings (e.g., Eureka Innovation Lab and Levi's Plaza), different cities (e.g., San Francisco and Las Vegas), or different countries (e.g., United States and China), and so forth. The tablets are connected via a wireless connection and a network (e.g., Wi-Fi, intranet, Internet, or cellular data network, or any combination of these).

The feature allows collaboration from user to user is available in real time, allowing for collaboration during the product creation process. Both users may control operations and make modifications at the same time. Actions by one user at one tablet will be visible to the other user at the other tablet.

In an implementation, the system may include a locking feature. This means that, if two users are accessing the same scene at a single time, certain features may be locked to other users when a user has selected a restricted feature. This locking feature allows a user to prevent other users from accessing the same restricted feature or related features until the user has indicated they are completed with the restricted feature. Some of these features that may be locked include positioning or sizing of wear patterns, damages, or some garment features. For example, if a user has indicated that they are about to access a restricted sizing modification

feature for a wear pattern, in response to the user's selection, the system may identify other users associated with the same scene and restrict these other users access to the restricted sizing modification feature. When the user has indicated that they have completed access to the restricted feature, the system may indicate to the other users that they have access to the restricted feature. For example, a message may appear on screens of the other users or the changes made by the user may appear on the devices of the other users so that they know that the user has completed their modifications. The locking feature may be useful for the system to prevent undesirable behavior, such as choppiness on the other users' devices as the user makes their changes.

Although FIGS. 23-26 show two tablet devices, the real-time collaboration tool can be used with other device types including smartphones, laptops, or desktops, or on machines through a Web browser interface, and any combination of devices and software. For example, users may collaborate between tablet and laptop.

FIG. 24 shows a chat feature. Users may text, voice, or video chat during real-time collaboration. A notes field within the editable document allows a common place to capture thoughts about the garment being created. For example, the first user can type and send a text message to the second user using a text input box of a first chat window of the first tablet. The second user will see the text message from the first user in a second chat window of the second tablet. The second user can respond by typing and sending a reply text message in the second chat window. The users can also have a voice call or video call through the chat feature. A voice call or video call (e.g., audio portion) can use voice-over-IP technology.

FIG. 25 shows a white board collaboration feature. Users may also collaborate visually around timeline, schedule, or overall vision using a white board functionality. Each user can contribute or modify a white board that is shared between the two devices.

FIG. 26 shows a mark-up collaboration feature. User may provide live mark-up feedback to communicate regions they are referring to or see issue with. For example, a user can use graphics to mark-up the image of the jeans or other apparel item being shown on the screen. The mark-up can include notes to communicate suggestions, comments, or reminders. The mark-ups can be saved and retrieved later when the design is opened again for further work.

Collection Management

FIGS. 27-30 describe an assortment builder tool, which can be used in conjunction with a digital brief tool, such as digital brief tool 1803 of FIG. 18. The assortment builder tool may be used in the system for creating, designing, producing apparel products with laser finishing as shown in FIG. 16. For example, the assortment builder tool allows a user to create collections of items created using the digital brief tool. The assortment builder tool allows the user to, in conjunction with the digital brief tool, create items and associate the items with different labels or collections. The collections may be based on any criteria that the user feels are important, such as environmentally friendly items, items in a specific color class, or any other collection category.

The assortment builder tool allows a user (e.g., merchandiser) to select designs to build an assortment or collection by adding or removing product. Then, the user can save this assortment. Multiple assortments can be created. Also, the assortment builder tool can have a collaboration feature, such as the real-time collaboration tool discussed above, so that two or more people can build an assortment together. For example, the tool includes allowing devices or sessions

to make changes to a collection. A server collects the changes and, after identifying which devices or collections are associated with the collection, transmits additions or removals from a collection to associated devices. A device or session may also indicate how many of each item in a collection to purchase, which after associated devices or session are identified, transmitted to the associated devices.

A design added to an assortment may have been created using the digital brief tool, or may have been created using other tools or techniques. An assortment is used to show and market a set or group of products to others, such as internal buyers, retail buyers, and other customers of the products. Assortments can be organized according to seasons, demographics, gender, or other categories. For example, there may be a spring collection, summer collection, fall collection, winter collection, children's collection, sportswear collection, or other category. An assortment can include multiple types or classes of product, such as a jeans, shirts, and accessories that coordinate together well for a particular target category. Using the assortment builder tool, a user creates an assortment or collection of products. When starting a new assortment, the assortment is empty and products can be added.

FIG. 27 shows a system diagram for an assortment builder tool 2701. The tool 2701 includes inputs from a user on a device 2705. The tool includes a search feature so that the user can filter and process information from databases 2710. The databases 2710 may include a created garments database, such as garments created using the digital brief tool, and a collection criteria database that is indexed with the created garments database to indicate what collections each garment may belong to. The tool includes a collection generator feature so that one or more items selected by the user can be grouped together in a collection. The tool also includes a collaboration feature so that the device 2705 may communicate with a device 2707 on what items should belong to a particular collection. The collaboration feature may be incorporated with the real-time collaboration tool as discussed above.

FIG. 28 shows a flow for a system including the assortment builder tool. In a step 2801, the system includes providing a garment previewing tool. The garment previewing tool may be the digital brief tool, as described elsewhere in this application. The digital brief may provide various options for a user, such as providing options for the user to select a base garment image. For example, the base garment image may be a jeans base garment. The base garment image may be composed of any material suitable for laser finishing. The user may also select a wear pattern, associated with a laser pattern file that may be processed to create the wear pattern onto a target garment corresponding to the base garment image. The user may also modify the position, the sizing, or a combination, of the wear pattern. For example, as the base garment image is shown, the user may modify the position, the sizing, or the combination, of the wear pattern. In response to, or in near real-time, the system may show to the user the modifications, without needing to first manufacture the target garment.

In a step 2805, the system includes granting access to first and second devices to first and second sessions. The first and second devices are granted, by the access to the first and second sessions, a set of garments created using the garment preview tool.

In a step 2810, the system includes designating a first selected garment to a first collection. The first collection may be any designation useful for marketing or other purposes. The first and second devices may also include

additional designation for garments created using the garment previewing tool to inclusion to the first collection as necessary.

In a step **2815**, the system includes identifying the second session at the second device as a collection collaborator. For example, in response to the designation of the first selected garment to the first collection, the system determines that the second device should receive the information because they are a collaborator. The collaborator may be a coworker, a designer, retailer, or any other person whom may be interested in how garments are to be divided for marketing, manufacturing, or other purposes.

In a step **2820**, the system includes receiving a requested amount for the first collection. For example, the system may receive from the first or second device information regarding how many of garments from the first collection to purchase. If there are more than one garment, the requested amount includes a requested amount for each of the garments.

In a step **2825**, the system includes providing target garments and creating wear patterns on the target garments.

FIG. **29** shows a search using the assortment builder tool. As shown in FIG. **29**, the user can search for products to add to an assortment using data, keyword or text, image search, or other search parameters. The user may search using the same criteria used when designing the garments with the garment previewing tool. For example, search criteria **2901** includes a particular damage pattern used and a listing of garments **2903** that correspond to the search criteria. FIG. **30** shows a zoomed view of the listing of garments **2903**.

The assortment builder tool can search on internal data metrics, keywords, or photo similarities using data distance processes. The internal data metrics can include, for example, product name, product code, season, brand, style, colorway, customer or user comments, or both, color code, fabric contents, availability, brand targets, retail or production prices, or both, last offered, manufacturing lead time, lab metrics, volume availability, stock, environmental score, and estimated product lifetime.

Colorway refers to a color based design aesthetic. In particular, colorway may be an arrangement of colors. This can be used to categorize different colors of the same product and typically can refer to multiple colors. As an example, there can be a product where the design dictates the use of three colors in specific areas; then there might be colorway for that product called "Shamrock" and it would be orange, white, and green, or a colorway called "Patriot" might be red white and blue. Alternatively, colorway can be referred to by other terms such as color palette, design iteration, or color pattern.

Additional assortments may include a common sell-in location (merchandising assortment), projected highest sales within a given region, commonly damaged product, commonly tinted product, product with common specialized features (e.g., pockets, rivets, patches), project with the same finish type, name, aesthetic, or many other assortments.

For the found products, the assortment builder tool shows preview images of products on the screen, and the preview can be generated as described for the digital brief tool. For each product, the assortment builder tool can also show detailed information on each product. This information, which can include the internal data metrics, can be retrieved from a product lifecycle management (PLM) database, which contains all the products available from the apparel manufacturer and each product's details. The product details can help the user decide whether to include a particular

product in an assortment. The user can select one or more found products to add to an assortment, while discarding unwanted found products.

FIG. **31** shows an assortment **1** and its associated detailed product lifecycle management data. FIG. **32** shows a zoomed view of the listing of garments **3103**. There can be multiple assortments, and the user can select which assortment to view. For example, search criteria **3101** specifies assortment **1**, which includes a listing of garments **3103** that correspond to the assortment **1**. A view of the garments that satisfy the search **3105** may also be included. For example, for each assortment, preview images of each product are displayed on the screen, and the user can scroll through these products.

The assortments can be linked to the apparel manufacturer's internal data from other databases (e.g., product lifecycle management database). Assortment images can be swapped out and replaced dynamically by the user as desired. Upon an update to the image the data linked will also be updated.

This description of the invention has been presented for the purposes of illustration and description. It is not intended to be exhaustive or to limit the invention to the precise form described, and many modifications and variations are possible in light of the teaching above. The embodiments were chosen and described in order to best explain the principles of the invention and its practical applications. This description will enable others skilled in the art to best utilize and practice the invention in various embodiments and with various modifications as are suited to a particular use. The scope of the invention is defined by the following claims.

The invention claimed is:

1. A method comprising:

- providing a garment previewing tool that allows previewing on a computer screen of a selected garment base customized by a user with a selected wear pattern to be formed by a laser using a laser input file;
- granting access to a first scene via a first session of the garment previewing tool on a first device, wherein the first scene includes the selected garment base;
- granting access to the first scene via a second session of the garment previewing tool on a second device;
- receiving from the first device the selected wear pattern to apply to the selected garment base;
- in response to the receiving the selected wear pattern, updating the first scene to include the selected garment base and the selected wear pattern;
- in response to the updating the first scene, identifying the second session at the second device as being associated with the first scene;
- in response to the identifying the second session, transmitting information identifying the selected wear pattern and the selected garment base;
- receiving from the first device a modification of a sizing of the selected wear pattern relative to the selected garment base or a position of the selected wear pattern relative to the selected garment base;
- before transmitting information identifying the modification of the selected wear pattern, comparing a first timestamp of the modification of the selected wear pattern from the first device with a second timestamp of another modification of the selected wear pattern from a third device;
- if the first timestamp is after the second timestamp, determining to transfer the modification of the selected wear pattern from the first device;

27

in response to the receiving the modification of the selected wear pattern, updating the first scene to reflect the modification of the selected wear pattern;

in response to the updating the first scene to reflect the modification of the selected wear pattern, identifying the second session at the second device as being associated with the first scene;

in response to the identifying the second session, transmitting information about the modification of the selected wear pattern;

causing a computer screen of the second device to display a preview image comprising the selected garment base and selected wear pattern, with modified sizing or modified positioning, or a combination;

providing a target garment corresponding to the garment base selected by the user; and

based on a laser input file associated with the selected wear pattern with modified sizing or modified positioning, or a combination, using a laser to create the selected wear pattern on an outer surface of the target garment.

2. The method of claim 1 comprising:

granting access to the first scene via a third session of the garment previewing tool on the third device;

in response to the updating the first scene to reflect the selected wear pattern, identifying the third session at the third device as being associated with the first scene; and

in response to the identifying the third session, transmitting information identifying the selected wear pattern and the selected garment base to the third device.

3. The method of claim 1 wherein the first and second sessions are concurrently accessing the garment previewing tool.

4. The method of claim 1 wherein the first and second sessions are asynchronous.

5. The method of claim 1 wherein the garment previewing tool on the first device includes:

providing an option for the user to select a garment base and upon the user's selection, showing a first garment preview image on the computer screen comprising a jeans base image for the selected garment base,

providing an option for the user to select a wear pattern from a menu of wear patterns, wherein each wear pattern is associated with a laser input file to be used by a laser to produce that wear pattern onto a jeans garment,

after the wear pattern is selected, showing a second garment preview image on the computer screen comprising the selected wear pattern in combination with the jeans base image, wherein the second garment preview image replaces the first garment preview image,

in the second garment preview image, allowing the user to modify a sizing of the wear pattern relative to the jeans base image, wherein as the user makes changes, the modified sizing of the wear pattern is displayed to the user in real time,

in the second garment preview image, allowing the user to modify a position of the wear pattern relative to the jeans base image, wherein as the user makes changes, the modified positioning of the wear pattern is displayed to the user in real time, and

showing a third garment preview image on the computer screen comprising the jeans base image and selected wear pattern, with modified sizing or modified positioning, or a combination.

28

6. The method of claim 1 wherein the target garment is made of at least one of a twill material or a cotton twill material.

7. The method of claim 1 comprising:

receiving from the second device a modification of a sizing of the selected wear pattern relative to the selected garment base or a position of the selected wear pattern relative to the selected garment base;

in response to the receiving the modification of the selected wear pattern, updating the first scene to reflect the modification of the selected wear pattern;

in response to the updating the first scene to reflect the modification of the selected wear pattern, identifying the first session at the first device as being associated with the first scene;

in response to the identifying the first session, transmitting information about the modification of the selected wear pattern to the first device; and

causing a computer screen of the first device to display a preview image comprising the selected garment base and selected wear pattern, with modified sizing or modified positioning, or a combination.

8. A method comprising:

providing a garment previewing tool that allows previewing on a computer screen of a selected garment base customized by a user with a selected wear pattern to be formed by a laser using a laser input file;

granting access to a first scene via a first session of the garment previewing tool on a first device, wherein the first scene includes the selected garment base;

granting access to the first scene via a second session of the garment previewing tool on a second device;

receiving from the first device the selected wear pattern to apply to the selected garment base;

in response to the receiving the selected wear pattern, updating the first scene to include the selected garment base and the selected wear pattern;

in response to the updating the first scene, identifying the second session at the second device as being associated with the first scene;

in response to the identifying the second session, transmitting information identifying the selected wear pattern and the selected garment base;

receiving from the first device a modification of a sizing of the selected wear pattern relative to the selected garment base or a position of the selected wear pattern relative to the selected garment base;

before receiving the modification of the selected wear pattern, receiving from the first device that the selected wear pattern has been selected for modification;

in response to the receiving that the selected wear pattern has been selected for modification, updating the first scene to reflect that the selected wear pattern has been selected for modification;

in response to the updating the first scene to reflect that the selected wear pattern has been selected for modification, identifying the second session at the second device as being associated with the first scene;

in response to the identifying the second session, transmitting to the second device instructions to prevent the modification of the selected wear pattern;

in response to the receiving the modification of the selected wear pattern, updating the first scene to reflect the modification of the selected wear pattern;

in response to the updating the first scene to reflect the modification of the selected wear pattern, identifying

29

the second session at the second device as being associated with the first scene;
 in response to the identifying the second session, transmitting information about the modification of the selected wear pattern;
 causing a computer screen of the second device to display a preview image comprising the selected garment base and selected wear pattern, with modified sizing or modified positioning, or a combination;
 providing a target garment corresponding to the garment base selected by the user; and
 based on a laser input file associated with the selected wear pattern with modified sizing or modified positioning, or a combination, using a laser to create the selected wear pattern on an outer surface of the target garment.

9. The method of claim 8 wherein the first and second sessions are concurrently accessing the garment previewing tool.

10. The method of claim 8 wherein the first and second sessions are asynchronous.

11. The method of claim 8 wherein the garment previewing tool on the first device includes:

providing an option for the user to select a garment base and upon the user's selection, showing a first garment preview image on the computer screen comprising a jeans base image for the selected garment base,

providing an option for the user to select a wear pattern from a menu of wear patterns, wherein each wear pattern is associated with a laser input file to be used by a laser to produce that wear pattern onto a jeans garment,

after the wear pattern is selected, showing a second garment preview image on the computer screen comprising the selected wear pattern in combination with the jeans base image, wherein the second garment preview image replaces the first garment preview image,

in the second garment preview image, allowing the user to modify a sizing of the wear pattern relative to the jeans base image, wherein as the user makes changes, the modified sizing of the wear pattern is displayed to the user in real time,

in the second garment preview image, allowing the user to modify a position of the wear pattern relative to the jeans base image, wherein as the user makes changes, the modified positioning of the wear pattern is displayed to the user in real time, and

showing a third garment preview image on the computer screen comprising the jeans base image and selected wear pattern, with modified sizing or modified positioning, or a combination.

12. The method of claim 8 wherein the target garment is made of at least one of a twill material or a cotton twill material.

13. The method of claim 8 comprising:

receiving from the second device a modification of a sizing of the selected wear pattern relative to the selected garment base or a position of the selected wear pattern relative to the selected garment base;

in response to the receiving the modification of the selected wear pattern, updating the first scene to reflect the modification of the selected wear pattern;

in response to the updating the first scene to reflect the modification of the selected wear pattern, identifying the first session at the first device as being associated with the first scene;

30

in response to the identifying the first session, transmitting information about the modification of the selected wear pattern to the first device; and
 causing a computer screen of the first device to display a preview image comprising the selected garment base and selected wear pattern, with modified sizing or modified positioning, or a combination.

14. A method comprising:

providing a garment previewing tool that allows previewing on a computer screen of a selected garment base customized by a user with a selected wear pattern to be formed by a laser using a laser input file;

granting access to a first scene via a first session of the garment previewing tool on a first device, wherein the first scene includes the selected garment base;

granting access to the first scene via a second session of the garment previewing tool on a second device;

receiving from the first device the selected wear pattern to apply to the selected garment base;

in response to the receiving the selected wear pattern, updating the first scene to include the selected garment base and the selected wear pattern;

in response to the updating the first scene, identifying the second session at the second device as being associated with the first scene;

in response to the identifying the second session, transmitting information identifying the selected wear pattern and the selected garment base;

receiving from the second device a modification of a sizing of the selected wear pattern relative to the selected garment base or a position of the selected wear pattern relative to the selected garment base;

before transmitting information identifying the modification of the selected wear pattern, comparing a first timestamp of the modification of the selected wear pattern from the second device with a second timestamp of another modification of the selected wear pattern from a third device;

if the first timestamp is after the second timestamp, determining to transfer the modification of the selected wear pattern from the second device;

in response to the receiving the modification of the selected wear pattern, updating the first scene to reflect the modification of the selected wear pattern;

in response to the updating the first scene to reflect the modification of the selected wear pattern, identifying the first session at the first device as being associated with the first scene;

in response to the identifying the first session, transmitting information about the modification of the selected wear pattern;

causing a computer screen of the first device to display a preview image comprising the selected garment base and selected wear pattern, with modified sizing or modified positioning, or a combination;

providing a target garment corresponding to the garment base selected by the user; and

based on a laser input file associated with the selected wear pattern with modified sizing or modified positioning, or a combination, using a laser to create the selected wear pattern on an outer surface of the target garment.

15. The method of claim 14 comprising:

granting access to the first scene via a third session of the garment previewing tool on the third device;

31

in response to the updating the first scene to reflect the selected wear pattern, identifying the third session at the third device as being associated with the first scene; and

in response to the identifying the third session, transmitting information identifying the selected wear pattern and the selected garment base to the third device.

16. The method of claim 14 wherein the first and second sessions are concurrently accessing the garment previewing tool.

17. The method of claim 14 wherein the first and second sessions are asynchronous.

18. The method of claim 14 wherein the garment previewing tool on the first device includes:

providing an option for the user to select a garment base and upon the user's selection, showing a first garment preview image on the computer screen comprising a jeans base image for the selected garment base,

providing an option for the user to select a wear pattern from a menu of wear patterns, wherein each wear pattern is associated with a laser input file to be used by a laser to produce that wear pattern onto a jeans garment,

after the wear pattern is selected, showing a second garment preview image on the computer screen comprising the selected wear pattern in combination with the jeans base image, wherein the second garment preview image replaces the first garment preview image,

in the second garment preview image, allowing the user to modify a sizing of the wear pattern relative to the jeans base image, wherein as the user makes changes, the modified sizing of the wear pattern is displayed to the user in real time,

in the second garment preview image, allowing the user to modify a position of the wear pattern relative to the jeans base image, wherein as the user makes changes, the modified positioning of the wear pattern is displayed to the user in real time, and

showing a third garment preview image on the computer screen comprising the jeans base image and selected wear pattern, with modified sizing or modified positioning, or a combination.

19. The method of claim 14 wherein the target garment is made of at least one of a twill material or a cotton twill material.

20. The method of claim 14 comprising:

receiving from the first device a modification of a sizing of the selected wear pattern relative to the selected garment base or a position of the selected wear pattern relative to the selected garment base;

in response to the receiving the modification of the selected wear pattern, updating the first scene to reflect the modification of the selected wear pattern;

in response to the updating the first scene to reflect the modification of the selected wear pattern, identifying the second session at the second device as being associated with the first scene;

in response to the identifying the first session, transmitting information about the modification of the selected wear pattern to the second device; and

causing a computer screen of the second device to display a preview image comprising the selected garment base and selected wear pattern, with modified sizing or modified positioning, or a combination.

32

21. A method comprising:

providing a garment previewing tool that allows previewing on a computer screen of a selected garment base customized by a user with a selected wear pattern to be formed by a laser using a laser input file;

granting access to a first scene via a first session of the garment previewing tool on a first device, wherein the first scene includes the selected garment base;

granting access to the first scene via a second session of the garment previewing tool on a second device;

receiving from the first device the selected wear pattern to apply to the selected garment base;

in response to the receiving the selected wear pattern on the first device, updating the first scene, to include the selected garment base and the selected wear pattern;

in response to the updating the first scene, identifying the second session at the second device as being associated with the first scene;

in response to the identifying the second session, transmitting information identifying the selected wear pattern and the selected garment base;

receiving from the second device a modification of a sizing of the selected wear pattern relative to the selected garment base or a position of the selected wear pattern relative to the selected garment base;

before receiving the modification of the selected wear pattern, receiving from the second device that the selected wear pattern has been selected for modification;

in response to the receiving that the selected wear pattern has been selected for modification, updating the first scene to reflect that the selected wear pattern has been selected for modification;

in response to the updating the first scene to reflect that the selected wear pattern has been selected for modification, identifying the first session at the first device as being associated with the first scene;

in response to the identifying the first session, transmitting to the first device instructions to prevent the modification of the wear pattern;

in response to the receiving the modification of the selected wear pattern, updating the first scene to reflect the modification of the selected wear pattern;

in response to the updating the first scene to reflect the modification of the selected wear pattern, identifying the first session at the first device as being associated with the first scene;

in response to the identifying the first session, transmitting information identifying the modification of the selected wear pattern;

causing a computer screen of the first device to display a preview image comprising the selected garment base and selected wear pattern, with modified sizing or modified positioning, or a combination;

providing a target garment corresponding to the garment base selected by the user; and

based on a laser input file associated with the selected wear pattern with modified sizing or modified positioning, or a combination, using a laser to create the selected wear pattern on an outer surface of the target garment.

22. The method of claim 21 wherein the first and second sessions are concurrently accessing the garment previewing tool.

23. The method of claim 21 wherein the first and second sessions are asynchronous.

24. The method of claim 21 wherein the garment previewing tool on the first device includes:

33

providing an option for the user to select a garment base and upon the user's selection, showing a first garment preview image on the computer screen comprising a jeans base image for the selected garment base, providing an option for the user to select a wear pattern from a menu of wear patterns, wherein each wear pattern is associated with a laser input file to be used by a laser to produce that wear pattern onto a jeans garment, after the wear pattern is selected, showing a second garment preview image on the computer screen comprising the selected wear pattern in combination with the jeans base image, wherein the second garment preview image replaces the first garment preview image, in the second garment preview image, allowing the user to modify a sizing of the wear pattern relative to the jeans base image, wherein as the user makes changes, the modified sizing of the wear pattern is displayed to the user in real time, in the second garment preview image, allowing the user to modify a position of the wear pattern relative to the jeans base image, wherein as the user makes changes, the modified positioning of the wear pattern is displayed to the user in real time, and showing a third garment preview image on the computer screen comprising the jeans base image and selected wear pattern, with modified sizing or modified positioning, or a combination.

25. The method of claim **21** wherein the target garment is made of at least one of a twill material or a cotton twill material.

26. The method of claim **21** comprising:
 receiving from the first device a modification of a sizing of the selected wear pattern relative to the selected garment base or a position of the selected wear pattern relative to the selected garment base;
 in response to the receiving the modification of the selected wear pattern, updating the first scene to reflect the modification of the selected wear pattern;
 in response to the updating the first scene to reflect the modification of the selected wear pattern, identifying the second session at the second device as being associated with the first scene;
 in response to the identifying the first session, transmitting information about the modification of the selected wear pattern to the second device; and
 causing a computer screen of the second device to display a preview image comprising the selected garment base and selected wear pattern, with modified sizing or modified positioning, or a combination.

27. A method comprising:
 providing a garment previewing tool that allows previewing on a computer screen of a selected garment base customized by a user with a selected wear pattern to be formed by a laser using a laser input file;
 granting access to a first scene via a first session of the garment previewing tool on a first device, wherein the first scene includes the selected garment base;
 granting access to the first scene via a second session of the garment previewing tool on a second device;
 receiving from the first device the selected wear pattern to apply to the selected garment base;
 in response to the receiving the selected wear pattern, updating the first scene to include the selected garment base and the selected wear pattern;

34

in response to the updating the first scene, identifying the second session at the second device as being associated with the first scene;
 in response to the identifying the second session, transmitting information identifying the selected wear pattern and the selected garment base;
 receiving a text message input at the first device;
 in response to the receiving the text message, identifying the second session at the second device as being associated with the first scene;
 in response to the identifying the second session, transmitting the text message to the second device;
 providing a target garment corresponding to the garment base selected by the user; and
 based on a laser input file associated with the selected wear pattern, using a laser to create the selected wear pattern on an outer surface of the target garment.

28. The method of claim **27** wherein the first and second sessions are concurrently accessing the garment previewing tool.

29. The method of claim **27** wherein the first and second sessions are asynchronous.

30. The method of claim **27** wherein the garment previewing tool on the first device includes:
 providing an option for the user to select a garment base and upon the user's selection, showing a first garment preview image on the computer screen comprising a jeans base image for the selected garment base,
 providing an option for the user to select a wear pattern from a menu of wear patterns, wherein each wear pattern is associated with a laser input file to be used by a laser to produce that wear pattern onto a jeans garment,
 after the wear pattern is selected, showing a second garment preview image on the computer screen comprising the selected wear pattern in combination with the jeans base image, wherein the second garment preview image replaces the first garment preview image,
 in the second garment preview image, allowing the user to modify a sizing of the wear pattern relative to the jeans base image, wherein as the user makes changes, the modified sizing of the wear pattern is displayed to the user in real time,
 in the second garment preview image, allowing the user to modify a position of the wear pattern relative to the jeans base image, wherein as the user makes changes, the modified positioning of the wear pattern is displayed to the user in real time, and
 showing a third garment preview image on the computer screen comprising the jeans base image and selected wear pattern, with modified sizing or modified positioning, or a combination.

31. The method of claim **27** wherein a target garment corresponds to the garment base selected by the user, and the target garment is made of at least one of a twill material, cotton material, cotton twill material, or denim.

32. The method of claim **27** comprising:
 receiving from the second device a modification of a sizing of the selected wear pattern relative to the selected garment base or a position of the selected wear pattern relative to the selected garment base;
 in response to the receiving the modification of the selected wear pattern, updating the first scene to reflect the modification of the selected wear pattern;

35

in response to the updating the first scene to reflect the modification of the selected wear pattern, identifying the first session at the first device as being associated with the first scene;

in response to the identifying the first session, transmitting information about the modification of the selected wear pattern to the first device; and

causing a computer screen of the first device to display a preview image comprising the selected garment base and selected wear pattern, with modified sizing or modified positioning, or a combination.

33. The method of claim **27** comprising:

receiving from the first device a modification of a sizing of the selected wear pattern relative to the selected garment base or a position of the selected wear pattern relative to the selected garment base;

in response to the receiving the modification of the selected wear pattern, updating the first scene to reflect the modification of the selected wear pattern;

in response to the updating the first scene to reflect the modification of the selected wear pattern, identifying the second session at the second device as being associated with the first scene;

in response to the identifying the first session, transmitting information about the modification of the selected wear pattern to the second device; and

causing a computer screen of the second device to display a preview image comprising the selected garment base and selected wear pattern, with modified sizing or modified positioning, or a combination.

34. A method comprising:

providing a garment previewing tool that displays a preview on a computer screen of a selected garment base as customized by a user with a selected finishing pattern, which will be produced on a target garment by a laser using a laser input file;

granting access to a first scene via a first session of the garment previewing tool on a first device, wherein the first scene comprises the selected garment base;

granting access to the first scene via a second session of the garment previewing tool on a second device;

from the first device, receiving the selected finishing pattern to apply to the selected garment base;

after receiving the selected finishing pattern, updating the first scene to include the selected garment base and the selected finishing pattern;

after updating the first scene, identifying the second session at the second device as being associated with the first scene;

after identifying the second session, transmitting information about the selected finishing pattern and the selected garment base to the second device;

receiving a text message input at the first device;

after receiving the text message, identifying the second session at the second device as being associated with the first scene; and

after identifying the second session, transmitting the text message to the second device.

35. The method of claim **34** comprising:

providing a target garment corresponding to the garment base selected by the user; and

based on a laser input file associated with the selected finishing pattern, using a laser to create the finishing pattern on an outer surface of the target garment.

36. The method of claim **35** wherein a target garment corresponds to the garment base selected by the user, and the

36

target garment is made of at least one of a twill material, cotton material, cotton twill material, or denim.

37. The method of claim **34** wherein the first and second sessions are concurrently accessing the garment previewing tool.

38. The method of claim **34** wherein the first and second sessions are asynchronous.

39. The method of claim **34** wherein the garment previewing tool on the first device includes:

providing an option for the user to select a garment base and upon the user's selection, showing a first garment preview image on the computer screen comprising a jeans base image for the selected garment base,

providing an option for the user to select a finishing pattern from a menu of finishing patterns, wherein each finishing pattern is associated with a laser input file to be used by a laser to produce that finishing pattern onto a jeans garment,

after the finishing pattern is selected, showing a second garment preview image on the computer screen comprising the selected finishing pattern in combination with the jeans base image, wherein the second garment preview image replaces the first garment preview image,

in the second garment preview image, allowing the user to modify a sizing of the selected finishing pattern relative to the jeans base image, wherein as the user makes changes, the modified sizing of the selected finishing pattern is displayed to the user in real time,

in the second garment preview image, allowing the user to modify a position of the selected finishing pattern relative to the jeans base image, wherein as the user makes changes, the modified positioning of the selected finishing pattern is displayed to the user in real time, and

showing a third garment preview image on the computer screen comprising the jeans base image and selected finishing pattern, with modified sizing or modified positioning, or a combination.

40. The method of claim **34** comprising:

receiving from the second device a modification of a sizing of the selected finishing pattern relative to the selected garment base or a position of the selected finishing pattern relative to the selected garment base;

after receiving the modification, updating the first scene to reflect the modification of the selected finishing pattern;

after updating the first scene, identifying the first session at the first device as being associated with the first scene;

after identifying the first session, transmitting information about the modification of the selected finishing pattern to the first device; and

causing the first device to show a preview image comprising the selected garment base and selected finishing pattern, with modified sizing or modified positioning, or a combination.

41. The method of claim **34** comprising:

receiving from the first device a modification of a sizing of the selected finishing pattern relative to the selected garment base or a position of the selected finishing pattern relative to the selected garment base;

after receiving the modification, updating the first scene to reflect the modification of the selected finishing pattern;

after updating the first scene, identifying the second session at the second device as being associated with the first scene;

after identifying the second session, transmitting information about the modification of the selected finishing pattern to the second device; and
causing the second device to show a preview image comprising the selected garment base and selected finishing pattern, with modified sizing or modified positioning, or a combination.

* * * * *