



US010574297B2

(12) **United States Patent**
Moore et al.

(10) **Patent No.:** **US 10,574,297 B2**
(45) **Date of Patent:** ***Feb. 25, 2020**

(54) **MULTI-USE WIRELESS POWER AND DATA SYSTEM**

(71) Applicant: **TRIUNE IP, LLC**, Plano, TX (US)

(72) Inventors: **Kenneth E. Moore**, Dallas, TX (US);
Petru Emanuel Stingu, Dallas, TX (US);
Ross E. Teggatz, The Colony, TX (US)

(73) Assignee: **TRIUNE IP, LLC**, Plano, TX (US)

(*) Notice: Subject to any disclaimer, the term of this patent is extended or adjusted under 35 U.S.C. 154(b) by 0 days.

This patent is subject to a terminal disclaimer.

(21) Appl. No.: **15/729,498**

(22) Filed: **Oct. 10, 2017**

(65) **Prior Publication Data**

US 2018/0034506 A1 Feb. 1, 2018

Related U.S. Application Data

(60) Continuation-in-part of application No. 14/988,647, filed on Jan. 5, 2016, now Pat. No. 9,853,441, and a (Continued)

(51) **Int. Cl.**
H04B 5/00 (2006.01)
H01F 38/14 (2006.01)
(Continued)

(52) **U.S. Cl.**
CPC **H04B 5/0031** (2013.01); **H01F 38/14** (2013.01); **H02J 5/005** (2013.01); **H02J 7/025** (2013.01);
(Continued)

(58) **Field of Classification Search**
CPC .. H04B 5/0031; H04B 5/0037; H04B 5/0093; H04B 1/40; H02J 50/12; H02J 50/40;
(Continued)

(56) **References Cited**
U.S. PATENT DOCUMENTS

3,808,545 A 4/1974 Stanley
4,335,321 A 6/1982 Lyons et al.
(Continued)

FOREIGN PATENT DOCUMENTS

WO 2012/019011 2/2012
WO 2013/151831 10/2013
(Continued)

OTHER PUBLICATIONS

International Search Report and Written Opinion for International application No. PCT/US2015/042903, Federal Institute of Industrial Property (Russian Patent Office), dated Dec. 10, 2015.

Primary Examiner — Hal Kaplan

(74) *Attorney, Agent, or Firm* — Jackson Walker LLP; Christopher J. Rourk

(57) **ABSTRACT**

A wireless device is disclosed that includes an antenna system comprising at least one inductive element and two or more capacitive elements. A switching component configured to change a circuit configuration of the capacitive elements. A controller configured to transmit a signal using the antenna system and to receive a response from a first device, to determine a communications protocol associated with the first device and to change a configuration of the antenna system in response to the detected communications protocol by actuating the switching component.

20 Claims, 9 Drawing Sheets

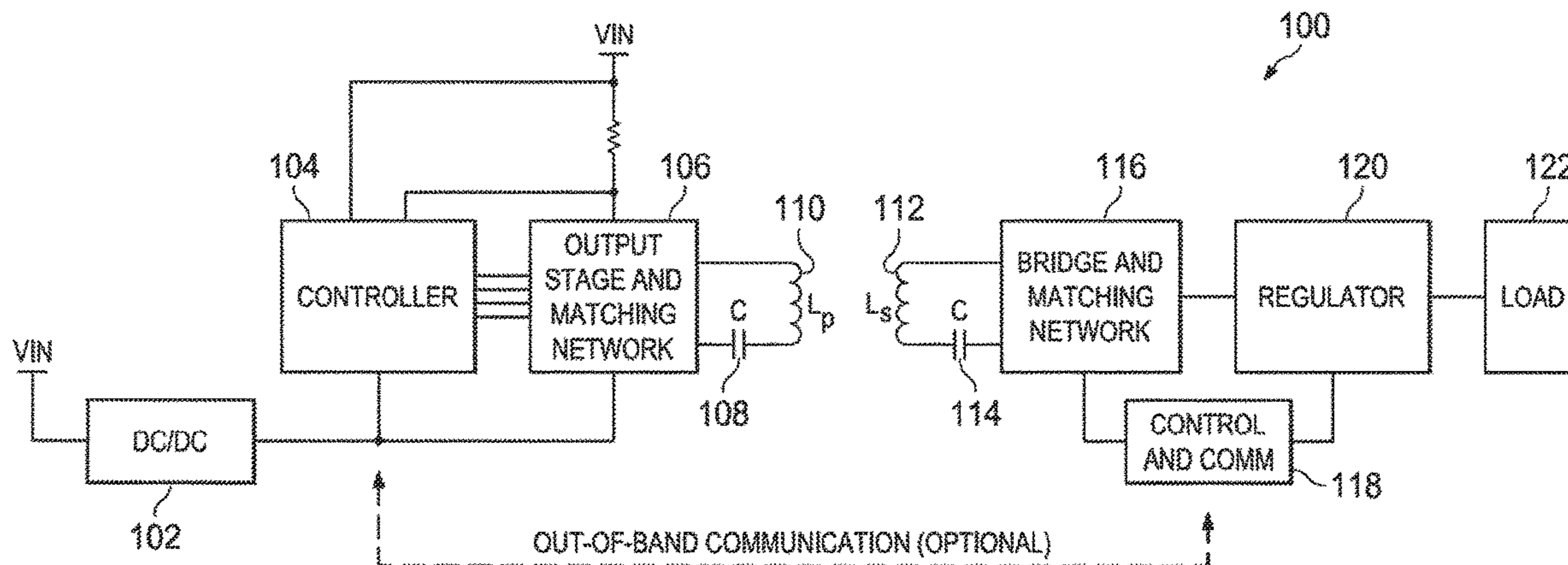

Related U.S. Application Data

continuation-in-part of application No. 14/982,952, filed on Dec. 29, 2015, now Pat. No. 9,843,314, and a continuation-in-part of application No. 14/970,396, filed on Dec. 15, 2015, now Pat. No. 9,793,814, and a continuation-in-part of application No. 14/814,379, filed on Jul. 30, 2015, now Pat. No. 9,787,364, which is a continuation-in-part of application No. 14/798,700, filed on Jul. 14, 2015, now Pat. No. 9,548,796, said application No. 14/970,396 is a continuation of application No. 14/230,645, filed on Mar. 31, 2014, now Pat. No. 9,214,867, said application No. 14/982,952 is a continuation of application No. 13/540,920, filed on Jul. 3, 2012, now Pat. No. 9,225,293, said application No. 14/988,647 is a continuation of application No. 13/540,902, filed on Jul. 3, 2012, now Pat. No. 9,231,400, said application No. 14/798,700 is a continuation of application No. 13/355,416, filed on Jan. 20, 2012, now Pat. No. 9,083,391, said application No. 14/230,645 is a division of application No. 12/954,635, filed on Nov. 25, 2010, now Pat. No. 8,687,385.

(60) Provisional application No. 62/031,027, filed on Jul. 30, 2014, provisional application No. 61/506,135, filed on Jul. 10, 2011, provisional application No. 61/506,118, filed on Jul. 10, 2011, provisional application No. 61/434,622, filed on Jan. 20, 2011, provisional application No. 61/264,644, filed on Nov. 25, 2009.

(51) **Int. Cl.**

H02J 50/80 (2016.01)
H02J 50/12 (2016.01)
H02J 7/02 (2016.01)
H02J 5/00 (2016.01)
H02J 50/60 (2016.01)
H02J 50/40 (2016.01)
H02J 50/50 (2016.01)

(52) **U.S. Cl.**

CPC *H02J 50/12* (2016.02); *H02J 50/40* (2016.02); *H02J 50/50* (2016.02); *H02J 50/60* (2016.02); *H02J 50/80* (2016.02); *H04B 5/0037* (2013.01); *H04B 5/0093* (2013.01)

(58) **Field of Classification Search**

CPC .. H02J 50/50; H02J 50/60; H02J 50/80; H02J 5/005; H02J 7/025; H01F 38/14
 USPC 307/104
 See application file for complete search history.

(56) **References Cited**

U.S. PATENT DOCUMENTS

4,464,739 A 8/1984 Moorcroft
 5,608,350 A 3/1997 Ebukuro
 5,642,076 A 6/1997 Naokawa et al.
 5,686,813 A 11/1997 Huen et al.
 5,796,303 A 8/1998 Vinn et al.
 5,818,707 A 10/1998 Seong et al.
 5,864,227 A 1/1999 Borden et al.
 6,229,273 B1 5/2001 Kelly et al.
 6,246,033 B1 6/2001 Shah
 6,295,217 B1 9/2001 Yang et al.
 6,433,622 B1 8/2002 Anderson et al.
 6,462,437 B1 10/2002 Marmaropoulos et al.
 6,563,342 B1 5/2003 Fulkerson
 6,914,394 B2 7/2005 Weirich

7,215,924 B2 5/2007 Palermo et al.
 7,426,239 B2 9/2008 Taghizadeh-Kaschani
 7,489,532 B2 2/2009 Shih
 7,535,734 B2 5/2009 Li et al.
 7,650,187 B2 1/2010 Gruber et al.
 7,808,127 B2 10/2010 Tegatz et al.
 7,827,334 B2 11/2010 Tegatz et al.
 7,859,911 B2 12/2010 Tegatz et al.
 7,982,492 B2 7/2011 Atrash et al.
 8,035,998 B2 10/2011 Kada et al.
 8,102,713 B2 1/2012 Tegatz et al.
 8,102,718 B2 1/2012 Tegatz et al.
 8,300,375 B2 10/2012 Tegatz et al.
 8,373,436 B2 2/2013 Atrash et al.
 8,408,900 B2 4/2013 Tegatz et al.
 8,441,866 B2 5/2013 Tegatz et al.
 8,461,847 B2 6/2013 Tegatz et al.
 8,552,336 B2 10/2013 Blackall et al.
 8,583,037 B2 11/2013 Atrash et al.
 8,584,961 B2 11/2013 Tegatz et al.
 8,664,745 B2 3/2014 Tegatz et al.
 8,687,385 B2 4/2014 Tegatz et al.
 8,693,261 B2 4/2014 Tegatz et al.
 8,704,450 B2 4/2014 Chen et al.
 8,743,522 B2 6/2014 Tegatz et al.
 8,768,455 B2 7/2014 Tegatz et al.
 8,896,318 B2 11/2014 Tegatz et al.
 8,901,878 B2 12/2014 Prutchi et al.
 8,964,418 B2 2/2015 Atrash et al.
 9,083,391 B2 7/2015 Tegatz et al.
 9,089,029 B2 7/2015 Tegatz et al.
 9,106,221 B2 8/2015 Atrash et al.
 9,118,357 B2 8/2015 Tseng
 9,134,741 B2 9/2015 Atrash et al.
 9,214,867 B2 12/2015 Tegatz et al.
 9,225,199 B2 12/2015 Tegatz et al.
 9,225,293 B2 12/2015 Tegatz et al.
 9,231,400 B2 1/2016 Chen et al.
 9,343,988 B2 5/2016 Tegatz et al.
 9,354,268 B2 5/2016 Tegatz et al.
 9,407,106 B2 8/2016 Redding
 2003/0228024 A1 12/2003 Hayama
 2004/0032752 A1 2/2004 Kim et al.
 2004/0151329 A1 8/2004 Judge et al.
 2004/0223624 A1 11/2004 Inagaki
 2006/0182266 A1 8/2006 Cusinato et al.
 2007/0121961 A1 5/2007 Tsai
 2007/0139103 A1 6/2007 Roeckner et al.
 2007/0154034 A1 7/2007 Mi et al.
 2008/0061876 A1 3/2008 Kaya et al.
 2008/0164961 A1 7/2008 Premerlani et al.
 2008/0252372 A1 10/2008 Williams
 2009/0196435 A1 8/2009 Miao
 2009/0231030 A1 9/2009 Li et al.
 2010/0067152 A1 3/2010 Nakahashi et al.
 2011/0008527 A1 1/2011 Tegatz et al.
 2011/0163794 A1 7/2011 Soma et al.
 2011/0187457 A1 8/2011 Hsu et al.
 2011/0305051 A1 12/2011 Yang et al.
 2011/0316449 A1 12/2011 Imanaka
 2012/0025752 A1 2/2012 Tegatz et al.
 2012/0028845 A1 2/2012 Tegatz et al.
 2012/0139357 A1 6/2012 Tegatz et al.
 2012/0139358 A1 6/2012 Tegatz et al.
 2012/0188673 A1 7/2012 Tegatz et al.
 2012/0242160 A1 9/2012 Tseng
 2012/0242164 A1 9/2012 Tegatz et al.
 2012/0248893 A1 10/2012 Tegatz et al.
 2012/0274838 A1 11/2012 Tegatz et al.
 2013/0028441 A1 1/2013 Chen et al.
 2013/0062967 A1 3/2013 Tegatz et al.
 2013/0175982 A1 7/2013 Tegatz et al.
 2013/0181724 A1 7/2013 Tegatz et al.
 2013/0193771 A1 8/2013 Tegatz
 2013/0224679 A1 8/2013 Tegatz et al.
 2013/0241465 A1 9/2013 Tegatz et al.
 2013/0257171 A1 10/2013 Tegatz et al.
 2013/0257172 A1 10/2013 Tegatz et al.
 2013/0285603 A1 10/2013 Zeinstra et al.

(56)

References Cited

U.S. PATENT DOCUMENTS

2014/0062381	A1	3/2014	Teggatz et al.
2014/0126249	A1	5/2014	Polivka
2014/0152119	A1	6/2014	Endo et al.
2014/0225447	A1	8/2014	Teggatz
2014/0265899	A1	9/2014	Sadwick
2014/0329720	A1	11/2014	Teggatz et al.
2015/0171758	A1	6/2015	Atrash et al.
2015/0236528	A1	8/2015	Kim et al.
2015/0256227	A1	9/2015	Teggatz et al.
2015/0318899	A1	11/2015	Teggatz et al.
2015/0326118	A1	11/2015	Teggatz et al.
2015/0341087	A1	11/2015	Moore et al.
2015/0372676	A1	12/2015	Teggatz et al.
2016/0004267	A1	1/2016	Atrash et al.
2016/0033979	A1	2/2016	Teggatz et al.
2016/0105115	A1	4/2016	Teggatz et al.
2016/0134099	A1	5/2016	Teggatz et al.
2016/0134191	A1	5/2016	Teggatz et al.

FOREIGN PATENT DOCUMENTS

WO	2015/195403	12/2015
WO	2016/019137	2/2016
WO	2016/019139	2/2016

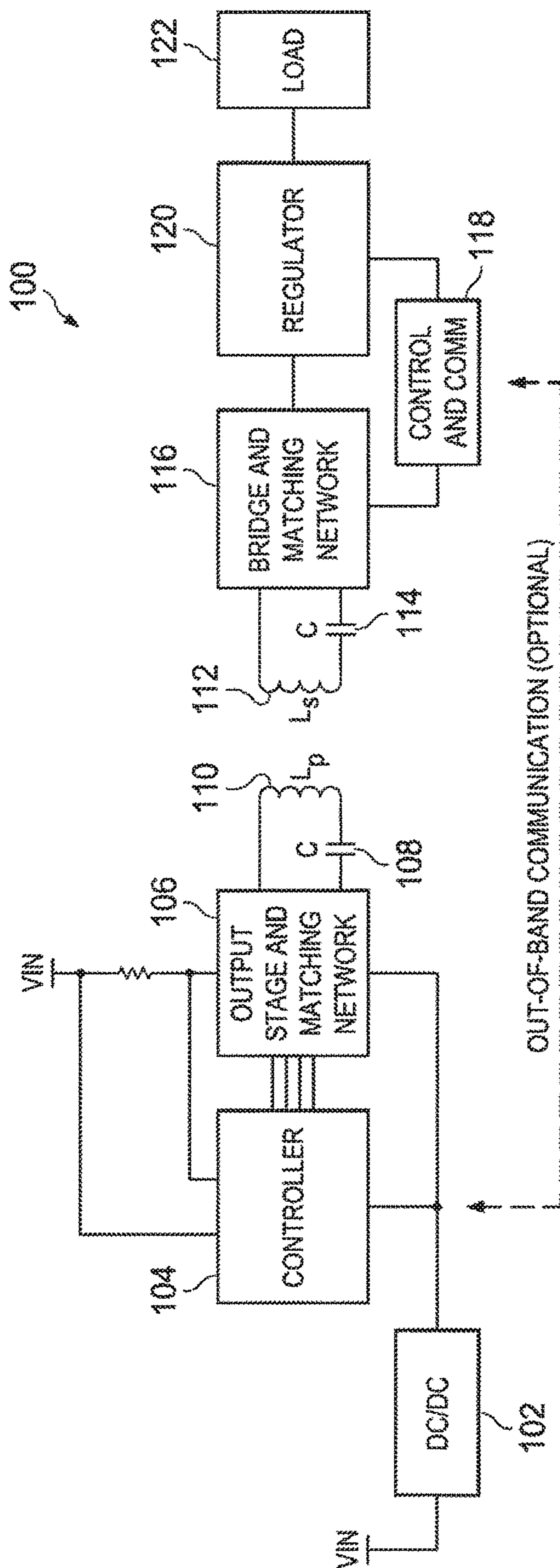

FIG. 1A

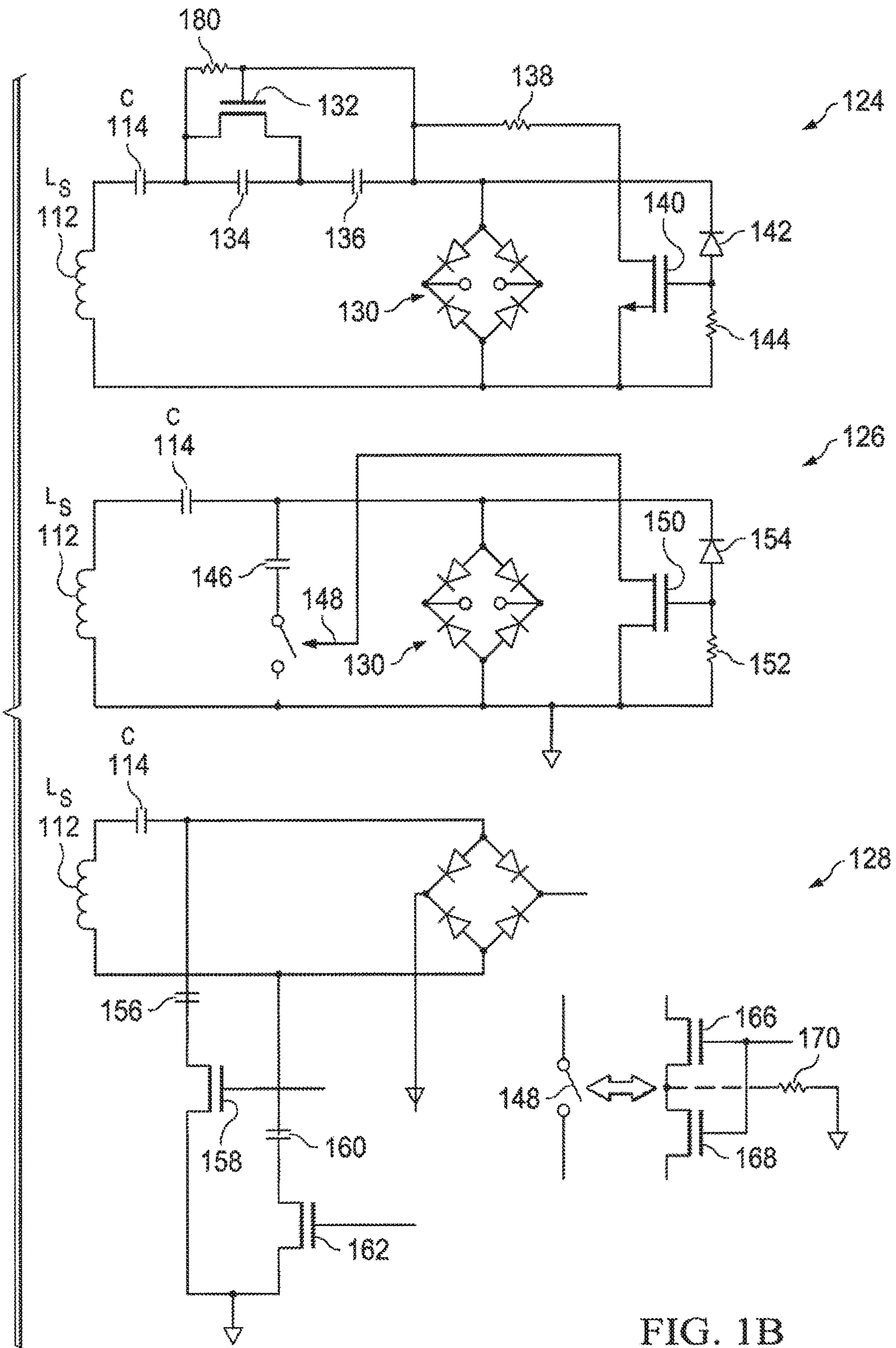
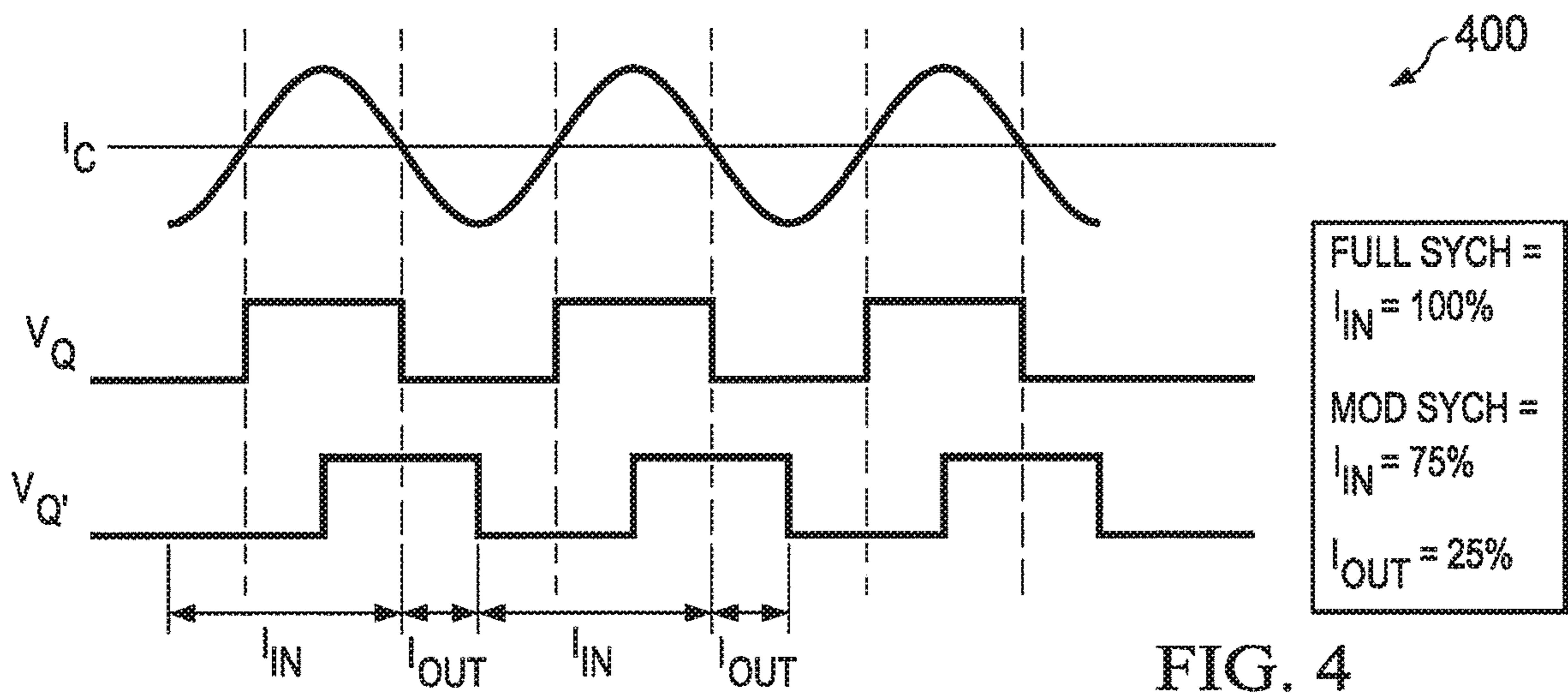
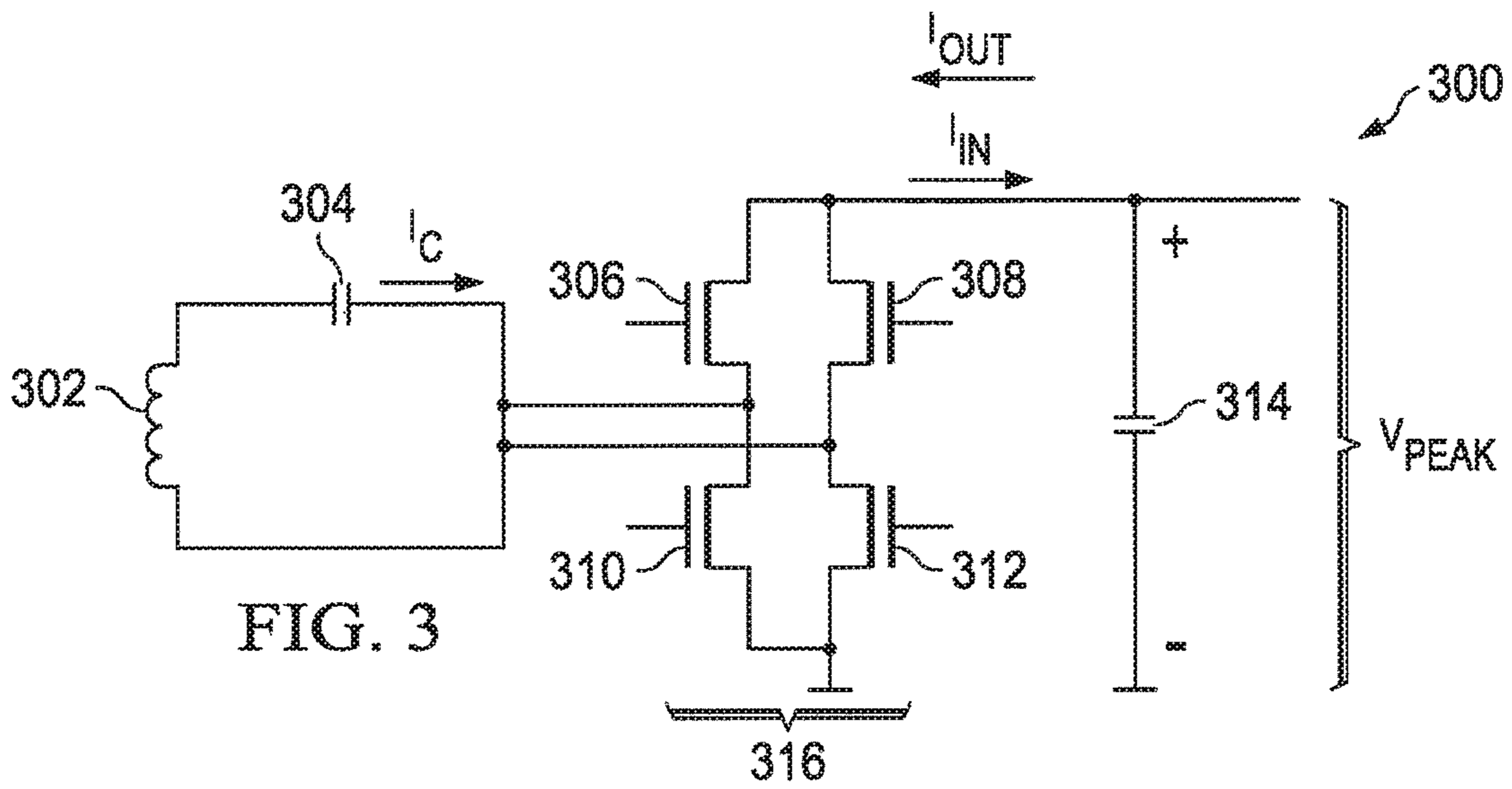
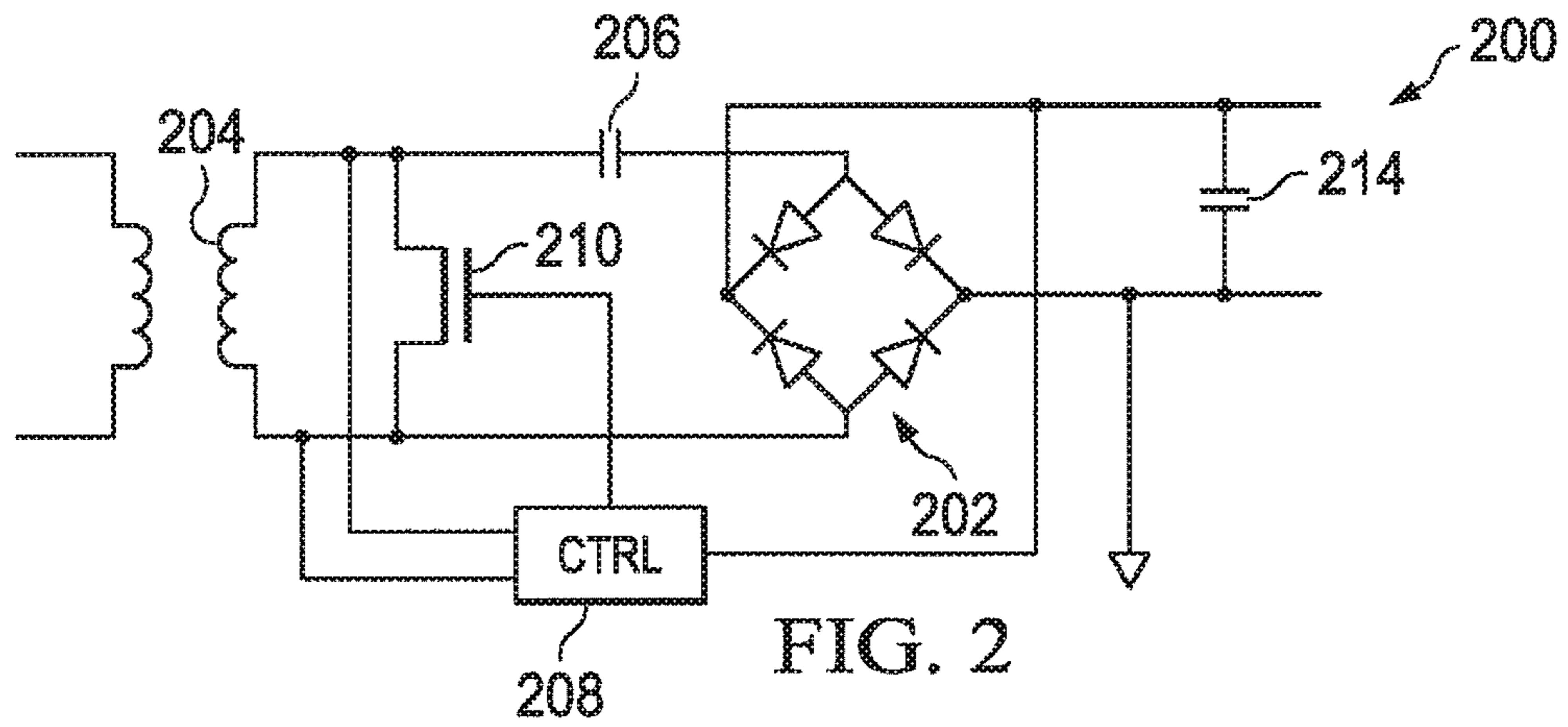

FIG. 1B



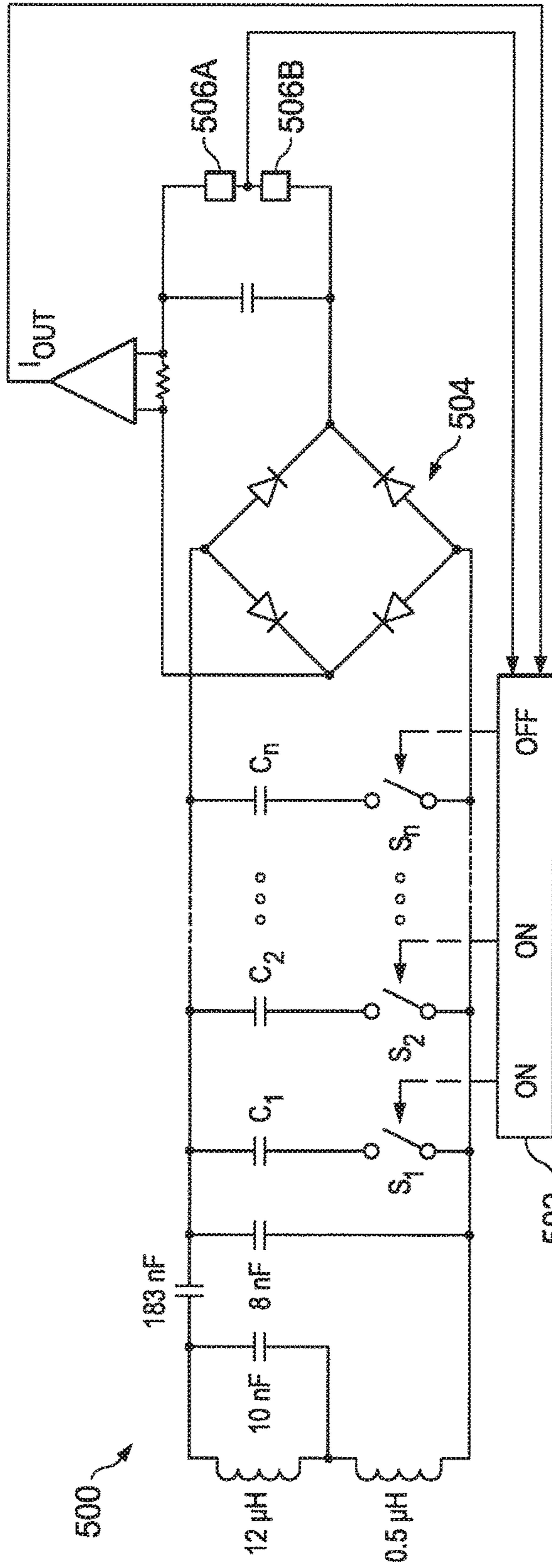

FIG. 5

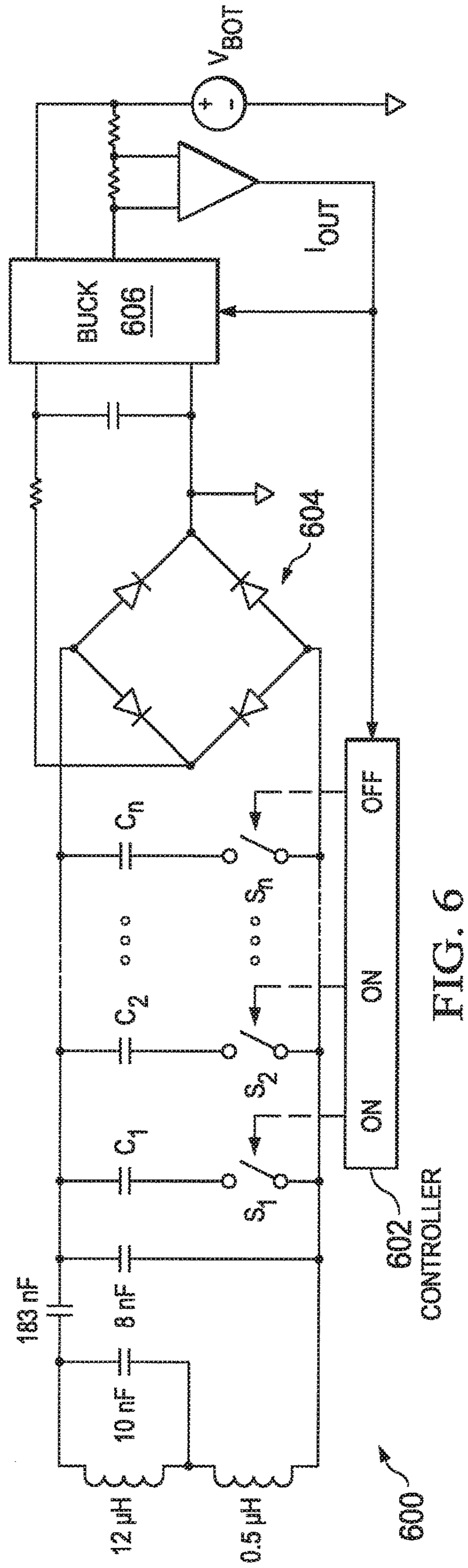

FIG. 6

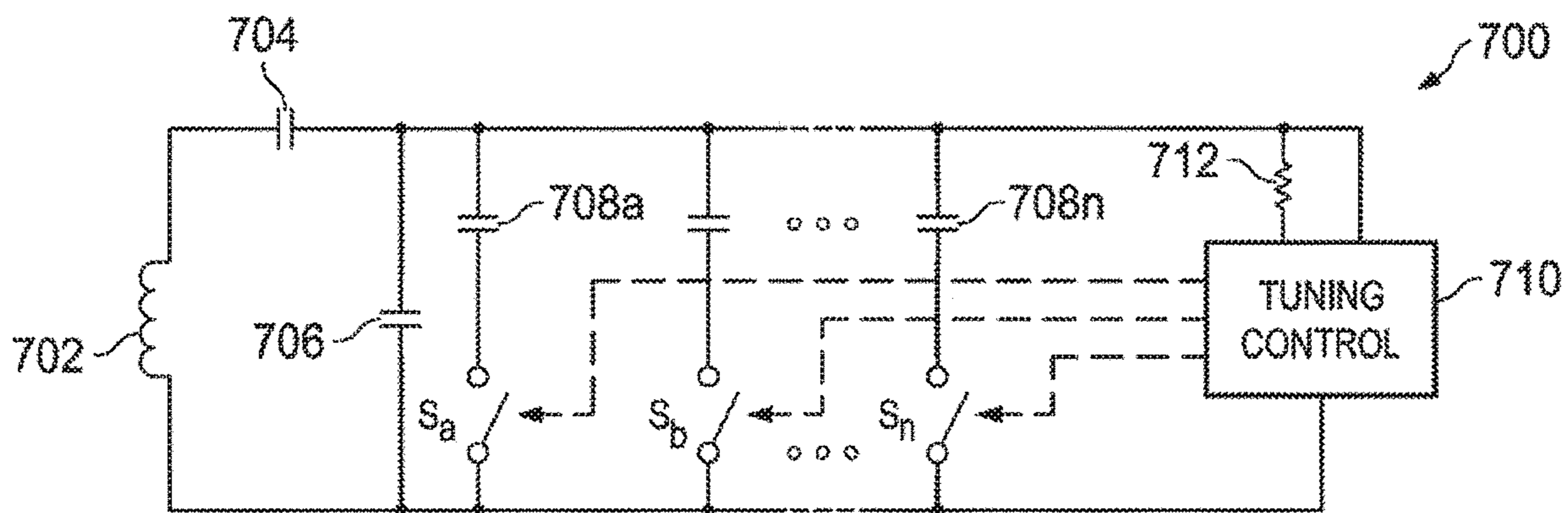

FIG. 7

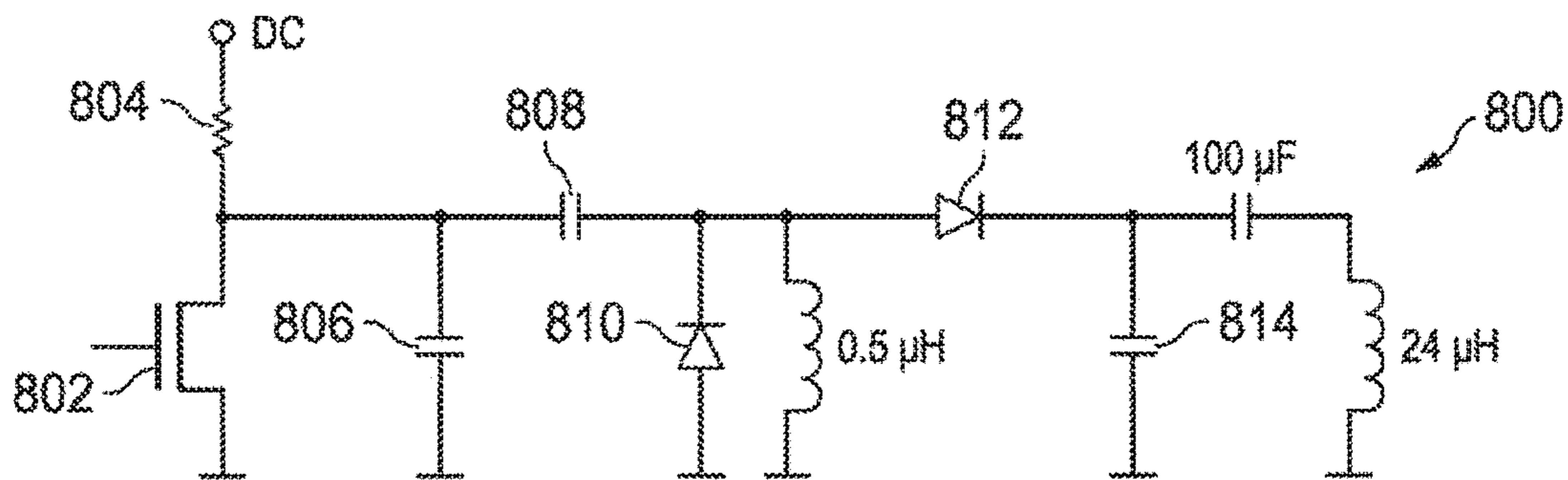

FIG. 8

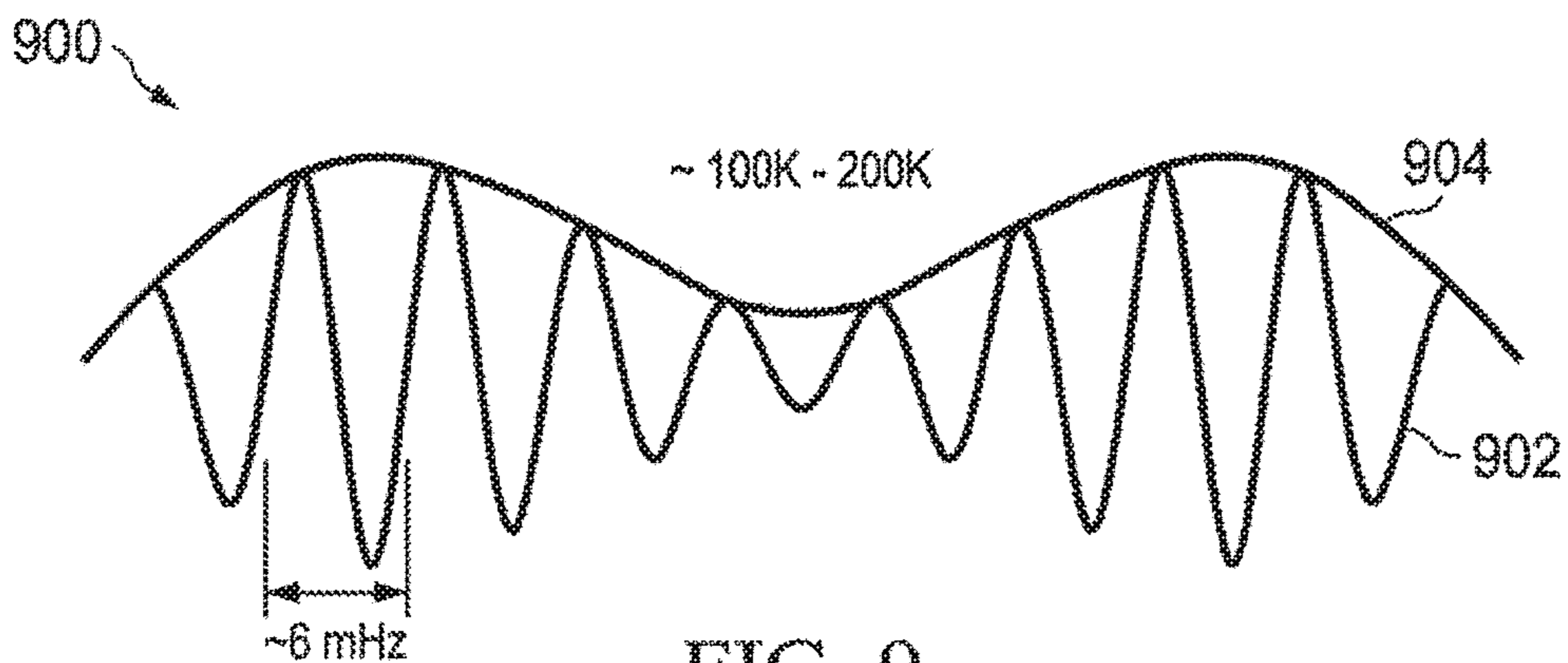

FIG. 9

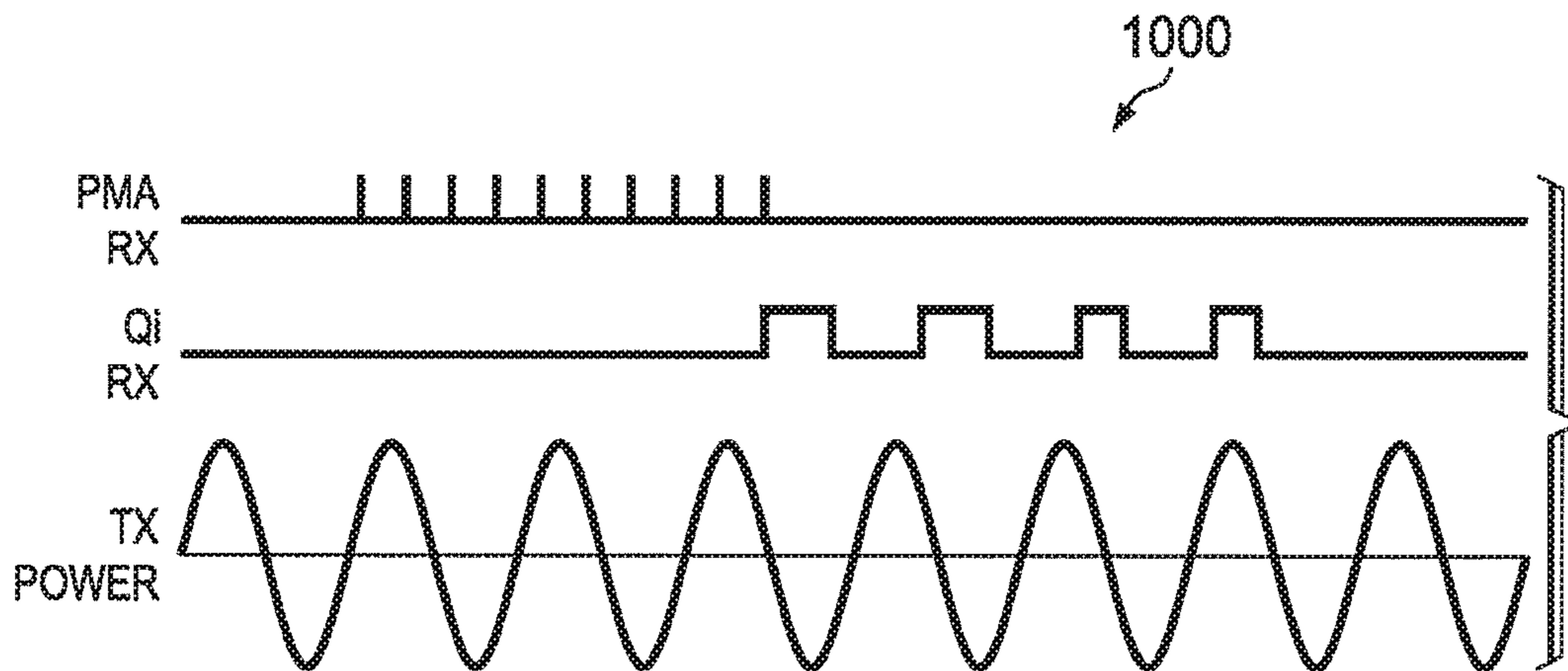

FIG. 10A

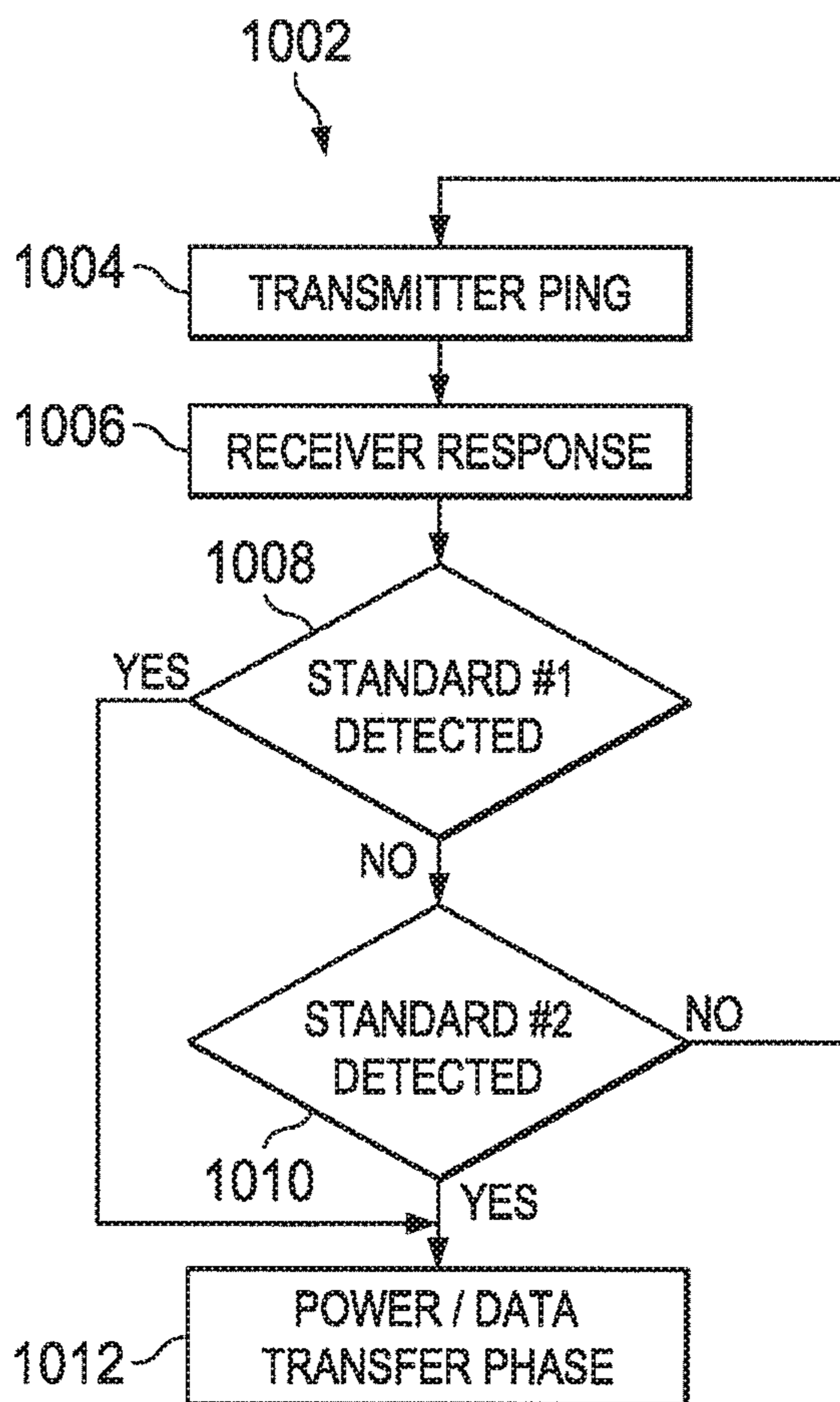

FIG. 10B

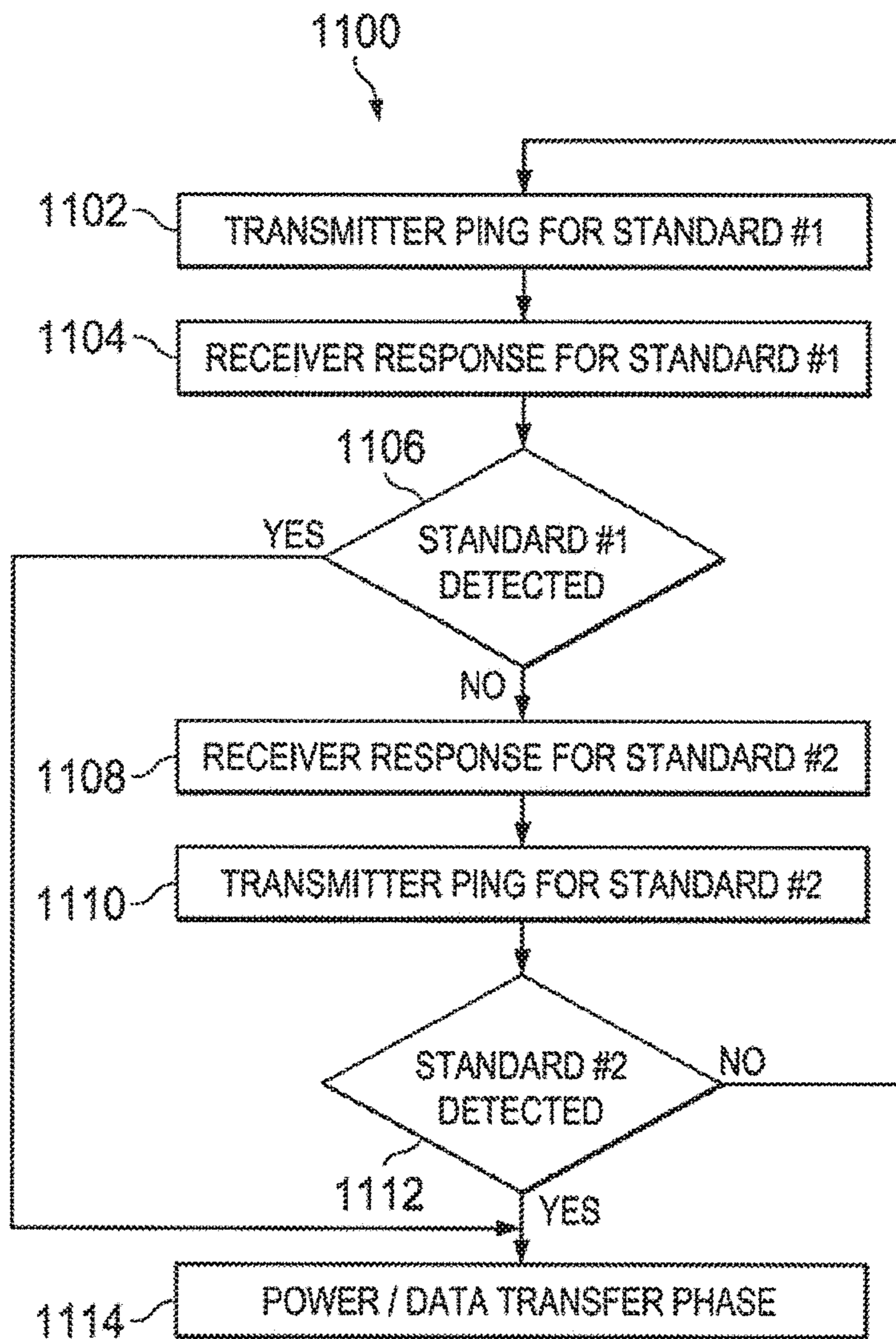

FIG. 11

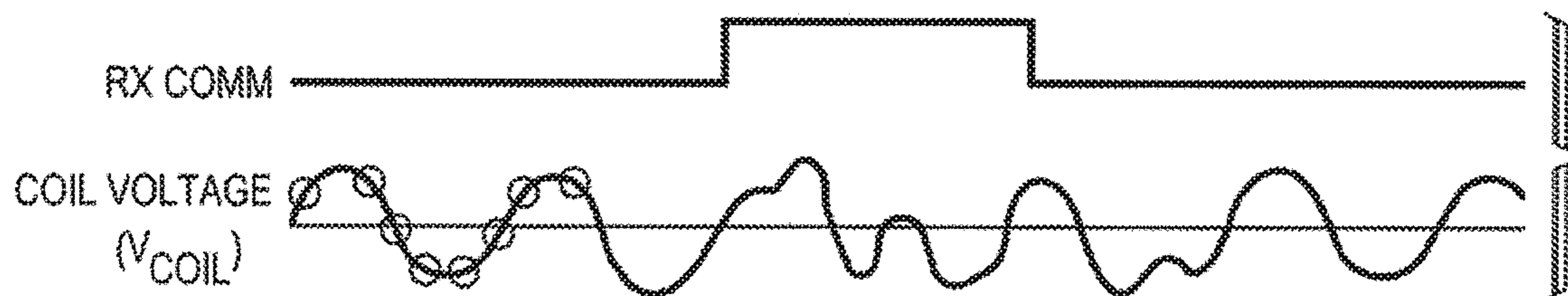

FIG. 12

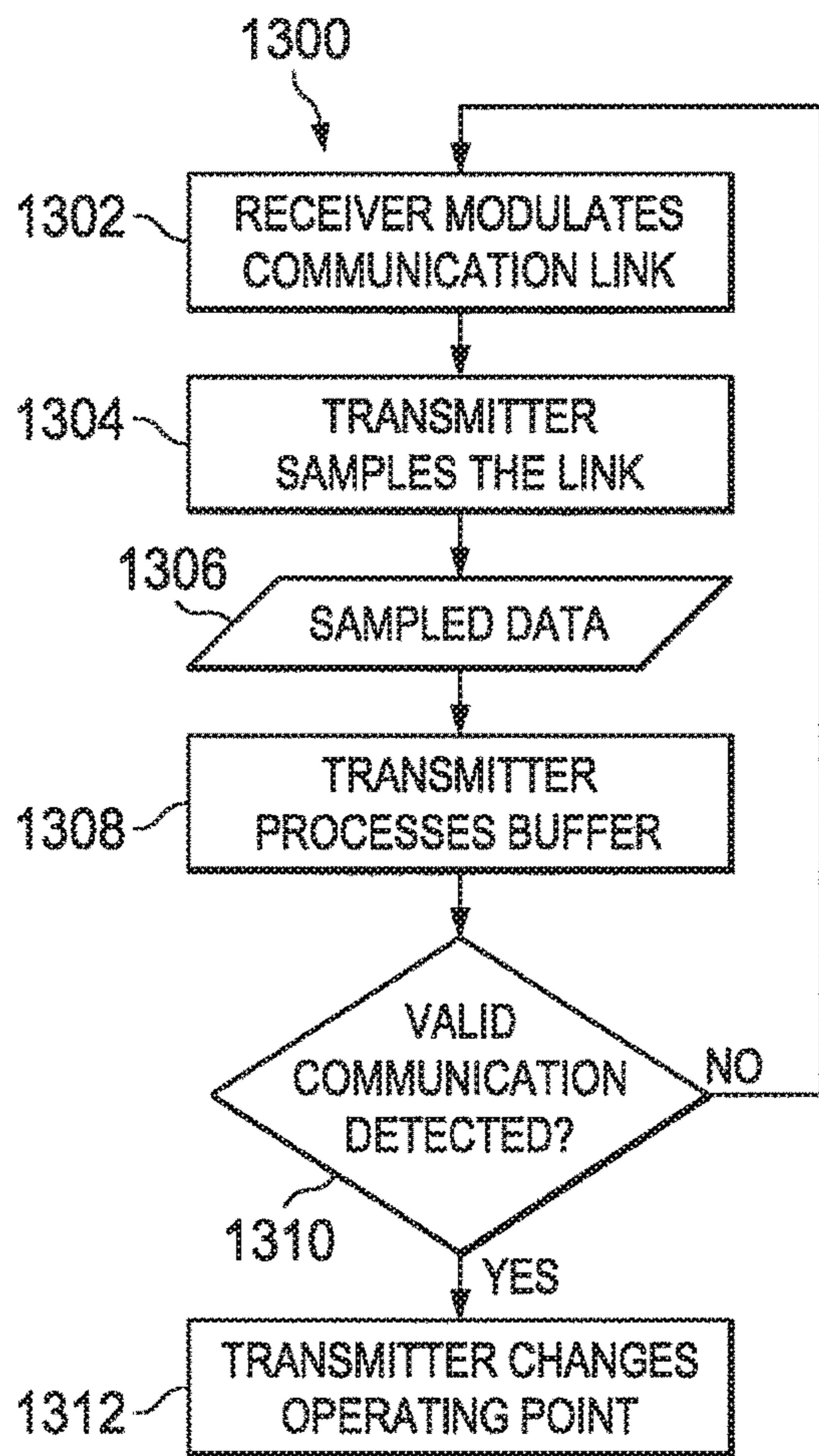

FIG. 13

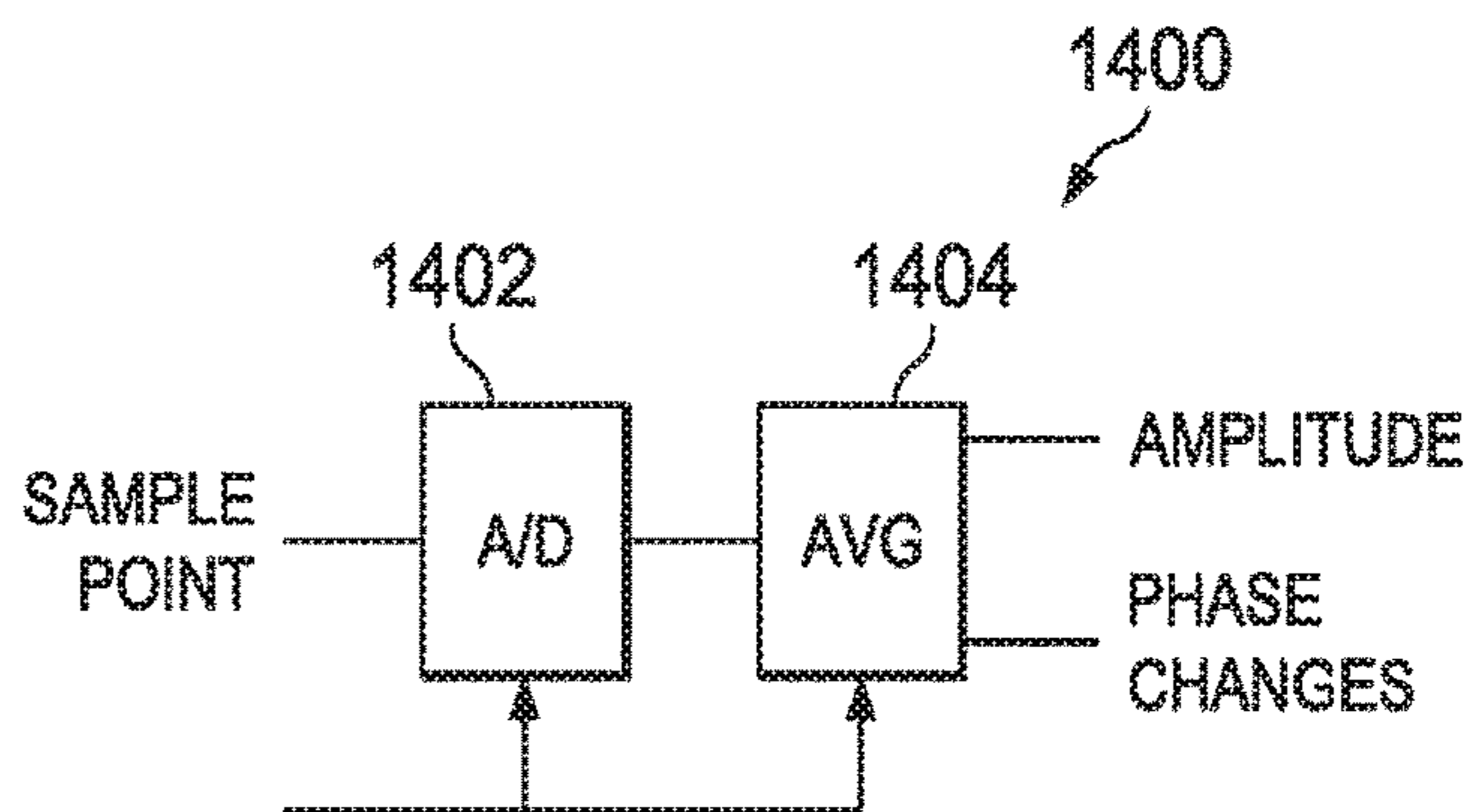
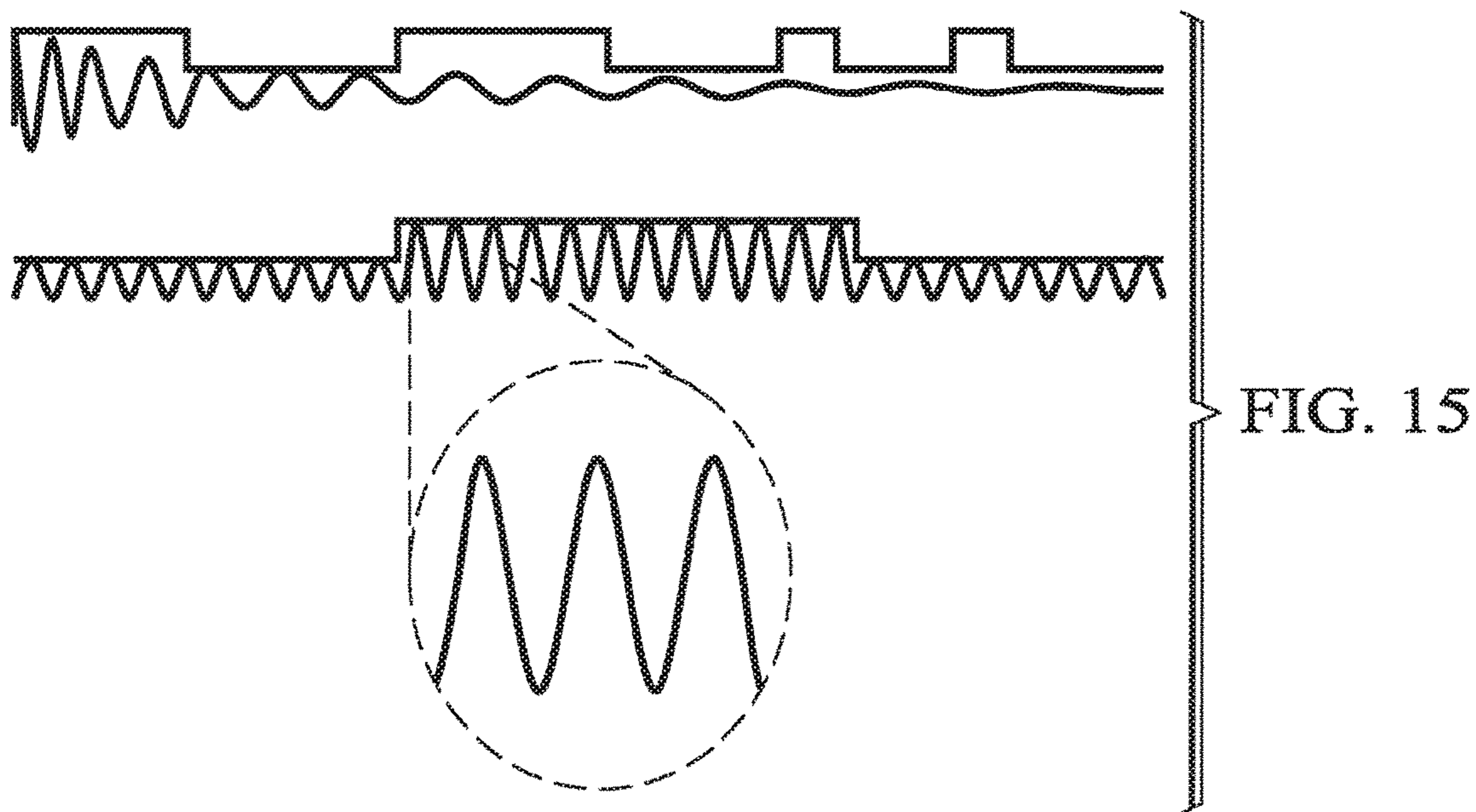

FIG. 14



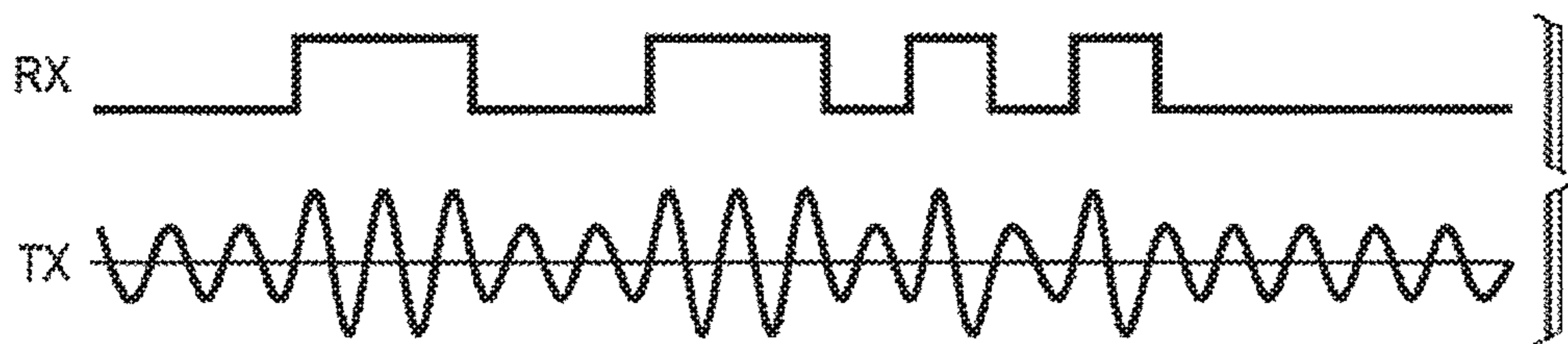

FIG. 16

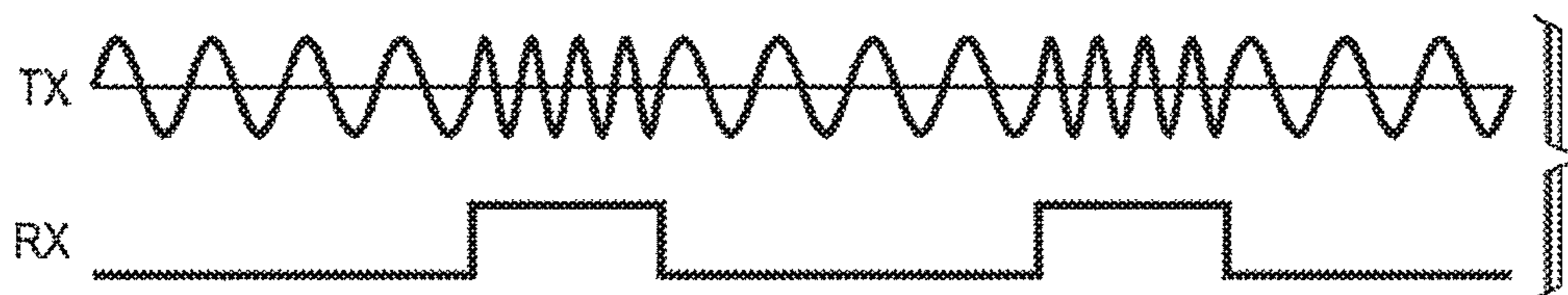

FIG. 17

1800

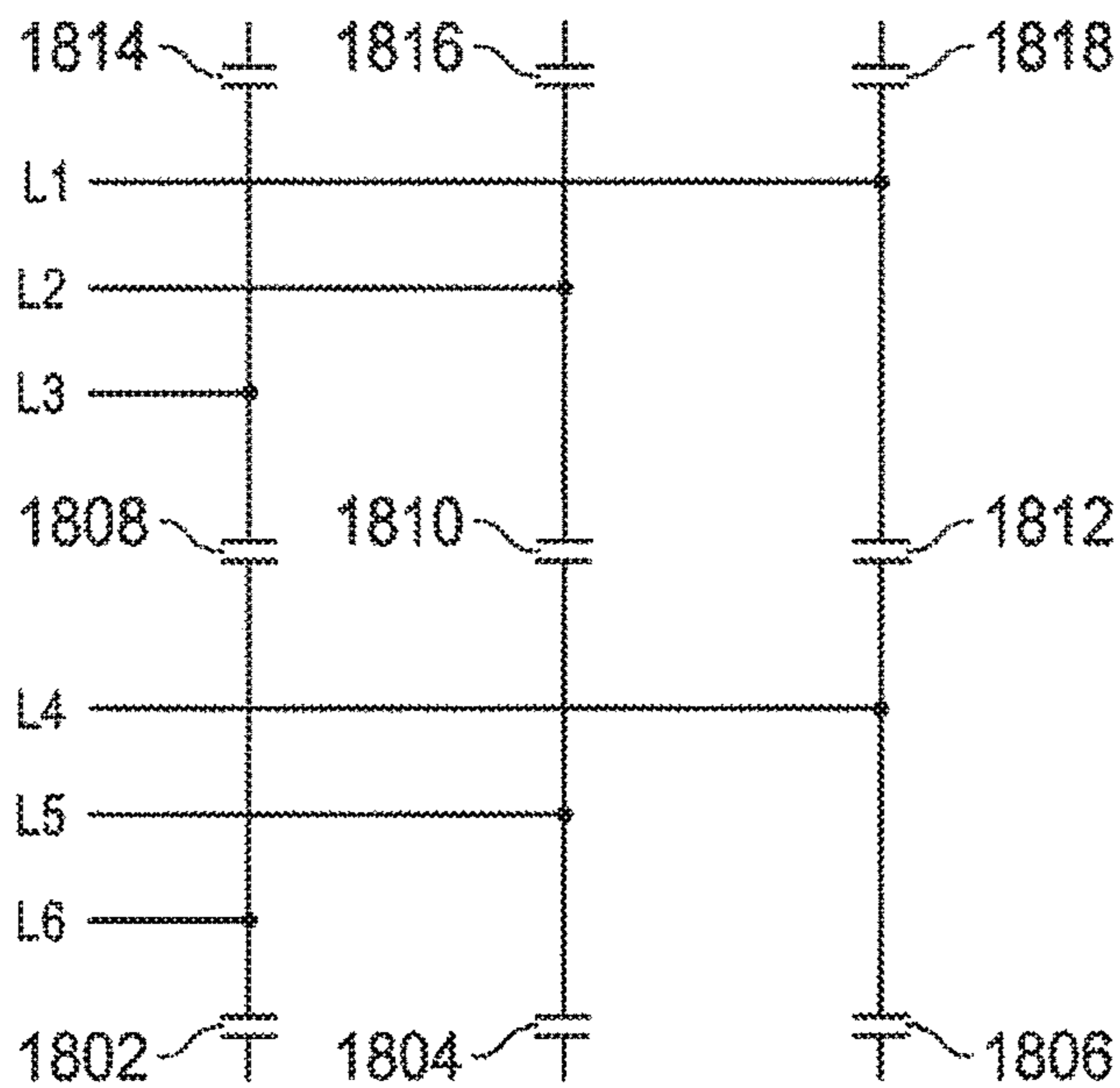

FIG. 18

MULTI-USE WIRELESS POWER AND DATA SYSTEM

RELATED APPLICATIONS

The present application is a continuation-in-part of U.S. patent application Ser. No. 14/814,379, filed Jul. 30, 2015, now U.S. Pat. No. 9,787,364, which is a continuation-in-part of U.S. patent application Ser. No. 14/798,700, filed Jul. 14, 2015, now U.S. Pat. No. 9,548,796, which claims benefit of U.S. Provisional Application Ser. No. 62/031,027, filed Jul. 30, 2014, which is a continuation of U.S. patent application Ser. No. 13/355,416, filed Jan. 20, 2012, now U.S. Pat. No. 9,083,391, which claims benefit of U.S. Provisional Application Ser. No. 61/434,622, filed Jan. 20, 2011; is a continuation-in-part of U.S. patent application Ser. No. 14/970,396, filed Dec. 15, 2015, which is a continuation of U.S. patent application Ser. No. 14/230,645, filed Mar. 31, 2014, now U.S. Pat. No. 9,214,867, which is a divisional of U.S. patent application Ser. No. 12/954,635, filed Nov. 25, 2010, now U.S. Pat. No. 8,687,385, which claims benefit of U.S. Provisional Application Ser. No. 61/264,644, filed Nov. 25, 2009; is a continuation-in-part of U.S. patent application Ser. No. 14/982,952, filed Dec. 29, 2015, which is a continuation of U.S. patent application Ser. No. 13/540,920, filed Jul. 3, 2012, now U.S. Pat. No. 9,225,293, which claims benefit of U.S. Provisional Application Ser. No. 61/506,135, filed Jul. 10, 2011; is a continuation-in-part of U.S. patent application Ser. No. 14/988,647, filed Jan. 5, 2016, which is a continuation of U.S. patent application Ser. No. 13/540,902, filed Jul. 3, 2012, now U.S. Pat. No. 9,231,400, which claims benefit of U.S. Provisional Application Ser. No. 61/506,118, filed Jul. 10, 2011, each of which are hereby incorporated by reference for all purposes as if set forth herein in its entirety.

TECHNICAL FIELD

The present disclosure relates generally to power and data transfer between two devices through a magnetic or radio frequency (RF) interface.

BACKGROUND OF THE INVENTION

Devices that are used for wirelessly transmitting data are typically designed to a predetermined standard for use with other devices that are designed to the same standard. Devices that are built to different standards cannot interact with each other.

SUMMARY OF THE INVENTION

A wireless device is disclosed that includes an antenna system that has at least one inductive element and two or more capacitive elements. A switching component changes a circuit configuration of the capacitive elements. A controller transmits a signal using the antenna system and receives a response from a first device, to determine a communications protocol associated with the first device and to change a configuration of the antenna system in response to the detected communications protocol by actuating the switching component.

Other systems, methods, features, and advantages of the present disclosure will be or become apparent to one with skill in the art upon examination of the following drawings and detailed description. It is intended that all such additional systems, methods, features, and advantages be

included within this description, be within the scope of the present disclosure, and be protected by the accompanying claims.

BRIEF DESCRIPTION OF THE SEVERAL VIEWS OF THE DRAWINGS

Aspects of the disclosure can be better understood with reference to the following drawings. The components in the drawings are not necessarily to scale, emphasis instead being placed upon clearly illustrating the principles of the present disclosure. Moreover, in the drawings, like reference numerals designate corresponding parts throughout the several views, and in which:

FIG. 1A is a diagram of a system for wireless power and data transmission in accordance with an exemplary embodiment of the present disclosure;

FIG. 1B is a diagram of different exemplary topologies for protecting a wireless power receiver from over-voltages using the de-tuning of the resonant circuit to keep the rectified voltage to safe levels;

FIG. 2 is a diagram of an exemplary circuit to protect a resonant wireless power receiver from over-voltages by shorting the coil to keep the rectified voltage to safe levels;

FIG. 3 is a diagram of a system for providing a full-synchronous bridge as a rectifier in wireless power circuits, in accordance with an exemplary embodiment of the present disclosure;

FIG. 4 is a diagram of current and timing waveforms, in accordance with an exemplary embodiment of the present disclosure;

FIG. 5 is a diagram of a system that is configured to resonate at two different frequencies, in accordance with an exemplary embodiment of the present disclosure;

FIG. 6 is a diagram of a system with a step-down DC/DC switching converter, in accordance with an exemplary embodiment of the present disclosure;

FIG. 7 is a diagram of a system with a passive resonator that acts as a repeater in a magnetic resonant power transfer system, in accordance with an exemplary embodiment of the present disclosure;

FIG. 8 is a diagram of class E transmitter, in accordance with an exemplary embodiment of the present disclosure;

FIG. 9 is a diagram of an AC current waveform generated by class E transmitter;

FIG. 10A is a diagram of exemplary waveforms for receiver type detection, in accordance with an exemplary embodiment of the present disclosure;

FIG. 10B is a diagram of a single-ping algorithm for receiver type detection, in accordance with an exemplary embodiment of the present disclosure;

FIG. 11 is a diagram of a multi-ping algorithm for receiver type detection, in accordance with an exemplary embodiment of the present disclosure;

FIG. 12 shows one of the possible types of waveforms of the receive communication and transmit coil voltage during communication;

FIG. 13 is a diagram of a demodulation algorithm, in accordance with an exemplary embodiment of the present disclosure;

FIG. 14 is a diagram of a system for processing data, in accordance with an exemplary embodiment of the present disclosure;

FIG. 15 shows one of the possible types of waveforms of the receive communication and transmit coil voltage during communication;

FIG. 16 is a diagram of amplitude modulation, in accordance with an exemplary embodiment of the present disclosure;

FIG. 17 is a diagram showing frequency modulation, in accordance with an exemplary embodiment of the present disclosure; and

FIG. 18 is a diagram of a circuit for providing a capacitive grid that can be used to detect metallic objects, in accordance with an exemplary embodiment of the present disclosure.

DETAILED DESCRIPTION OF THE INVENTION

In the description that follows, like parts are marked throughout the specification and drawings with the same reference numerals. The drawing figures might not be to scale and certain components can be shown in generalized or schematic form and identified by commercial designations in the interest of clarity and conciseness.

The word “exemplary” is used herein to mean serving as an example, instance, or illustration. Any aspect or design described herein as “exemplary” is not necessarily to be construed as preferred or advantageous over other aspects or designs. Further, for the purposes of this disclosure and unless otherwise specified, “a” or “an” means “one or more”. Still further, the use of “and” or “or” is intended to include “and/or” unless specifically indicated otherwise.

The present disclosure is directed to a device for transferring power and data that can detect and use multiple different data standards and protocols, so as to be usable with different devices from different manufacturers. The disclosed multi-standard device includes a programmable controller that receives and processes data that can be encoded using any of one or more different standards or protocols, and has components that are used to transmit and receive power signals, data signals or a suitable combination of both, using electromagnetic radiation, magnetic flux or a suitable combination of energy sources. The multi-standard device can determine a data or power transmission standard or protocol that is being used by another device through the disclosed algorithmic processes, and can adjust its operating functions to allow it to interact using the detected standards or protocols.

The disclosed system can use multiple protocols to accomplish power or data transfer, where at least one of the devices can operate under multiple uses, such as under different standards, under different power or data protocols, under different distance protocols, under different safety conditions and so forth. In one exemplary embodiment, the device of the present disclosure is configured to interoperate with another device capable of only operating under a single standard, protocol or use mode.

In the description that follows, like parts are marked throughout the specification and drawings with the same reference numerals, respectively. The drawing figures might not be to scale and certain components can be shown in generalized or schematic form and identified by commercial designations in the interest of clarity and conciseness. In addition, the disclosures of each of U.S. patent application Ser. No. 14/814,379, filed Jul. 30, 2015; U.S. patent application Ser. No. 14/970,396, filed Dec. 15, 2015; U.S. patent application Ser. No. 14/982,952, filed Dec. 29, 2015; and U.S. patent application Ser. No. 14/988,647, filed Jan. 5, 2016, are hereby incorporated by reference for all purposes as if set forth herein in its entirety.

FIG. 1A is a diagram of a system 100 for wireless power and data transmission in accordance with an exemplary embodiment of the present disclosure. System 100 includes programmable controller 104, output stage and matching network 106 and bridge and matching network 116 (which form a power stage capable of transmitting power and data across the interface to a load 122), power supply 102, a resonant antenna system that includes capacitors 108 and 114 and inductors L_P 110 and L_S 112, control and communication circuit 118 and regulator 120, which are used to measure voltages and currents in the system. Component values for the circuitry are chosen to provide system operation across predetermined standards and application requirements supported by the device.

In operation, a primary transceiver such as output stage and matching network 106 monitors the region around an antenna, such as using capacitor 108 and inductor L_P 110, to determine when a secondary transceiver such as bridge and matching network 116 is nearby, such as by measuring a change in impedance at a predetermined frequency, induced voltages or other suitable signals. Once the proximity of a secondary transceiver is detected, the primary transceiver transmits a predetermined amount of power to energize the secondary transceiver, which can be referred to herein as the “ping” phase. After the secondary transceiver begins operation, the primary transceiver and secondary transceiver transmit and receive data to in accordance with one or more algorithms to exchange identification and to select a protocol to use for power and data transfer. One method for transmitting and receiving data is by use of bi-directional communication through amplitude load modulation, frequency modulation, RF, infrared or other light-based signaling, or other suitable methods.

The secondary transceiver can be protected from over-voltage by changing a resonant state of a tunable circuit, such as that formed by capacitor 114 and inductor L_S 112, by switching capacitance elements into or out of the tunable circuit. FIG. 1B is a diagram of different exemplary topologies for protecting a wireless power receiver from over-voltages using the de-tuning of the resonant circuit to keep the rectified voltage to safe levels. In one exemplary embodiment, the tunable circuit can include a sensor (such as within bridge and matching network 116, control and communication circuit 118, regulator 120 or other suitable circuits) that senses an AC voltage at an input to a bridge rectifier, such as bridge rectifier 130, and when that voltage reaches a pre-determined level, the sensor and associated control circuitry can connect or disconnect one or more capacitive elements to change the resonant frequency of the tunable circuit from the transmitter frequency of the primary transceiver, thereby reducing the energy in the receiver coil. For example, secondary transceiver 124 can include resistor 180 and transistor 132, which switches capacitor 134 in or out of series with capacitor 136, as a function of the state of transistor 140, which is turned on or off as a function of a voltage drop across resistor 144 driven by diode 142 and a corresponding voltage drop across resistor 138 when transistor 140 is on or off.

In another exemplary embodiment, secondary transceiver 126 can include switch 148, which switches capacitor 146 in and out of series with capacitor 114 as a function of the state of transistor 150, which is controlled by a voltage drop across resistor 152 that is driven by diode 154. An exemplary detail diagram of switch 148 is shown by transistors 166 and 168, which have a common gate and center connection to low voltage through 170.

5

In another exemplary embodiment, secondary transceiver **128** can include capacitors **156** and **160**, which are switched in and out of series with capacitor **114** by transistors **158** and **162**. Likewise, other suitable configurations can also or alternatively be used.

FIG. **2** is a diagram of an exemplary wireless power receiver **200** to protect a resonant wireless power receiver from over-voltages by shorting the coil to keep the rectified voltage to safe levels. Wireless power receiver **200** includes bridge rectifier **202**, a resonant antenna system formed by inductance **204** and capacitance **206**, controller **208**, which is configured to sense a magnitude of an AC input voltage across inductance **204**, and switch **210**, which connects and disconnects a capacitive element **214**. The resonant antenna system can be attenuated by detuning through changing the center frequency of the LC circuit, by reducing the gain, by lowering the resistance value or in other suitable manners. Controller **208** includes a voltage sensing mechanism on the secondary side of the rectifier, and can be configured such that when the sensed voltage reaches a predetermined threshold, a feedback mechanism is enabled to adjust the capacitive value to detune the resonant antenna system, to adjust a capacitor divider which both reduces gain and detunes the output, or which performs other suitable functions. Other implementations of this type of feedback mechanism can be used to adjust gain, alter a resonant frequency, or to implement other suitable functions. Implementations of wireless power receiver **200** can use a suitable feedback mechanism with active components, passive components, capacitive elements, inductive elements, resistive elements or other suitable elements, circuits or systems.

FIG. **3** is a diagram of a system **300** for providing a full-synchronous bridge as a rectifier in wireless power circuits, in accordance with an exemplary embodiment of the present disclosure. The full-synchronous bridge can be used to protect the wireless power receiver from over-voltages by changing the switching angle of the bridge away from the current zero-crossing point without the need for additional components. System **300** changes a switching angle of a switching bridge **316** away from the current zero crossing point. For example, when switching bridge **316** is switching transistors **306**, **308**, **310** and **312** when the current is synchronous with the input AC waveform, 100% of the current I_C generated in the resonant circuit flows into the storage capacitor **314**, increasing its voltage. By moving the switching point away from the zero-crossing of the AC waveform, a portion of the current flows from storage capacitor **314** back into the resonant circuit formed by inductor **302** and capacitor **304**, reducing the capacitor voltage. Shifting the bridge switching point 90 degrees from the current zero crossing point causes an equal amount of current to flow into and out of the storage capacitor **314** as the bridge switches **306**, **308**, **310** and **312**, keeping the capacitor voltage constant. Dynamically moving the bridge switching point allows system **300** to prevent a voltage W_{PEAK} from exceeding a predetermined threshold and to maintain that voltage until the energy in the resonant circuit dissipates to a safe level.

In one exemplary embodiment, a voltage sensing mechanism can be used on a secondary side of the rectifier. Once the sensed voltage reaches a predetermined threshold, a feedback mechanism can be enabled to change the switching point for the synchronous rectifier. When the secondary voltage falls below the threshold, the feedback mechanism can move the switching point to a previous operating point or other suitable points.

6

FIG. **4** is a diagram **400** of current and timing waveforms, in accordance with an exemplary embodiment of the present disclosure. Diagram **400** includes current waveform I_C , which has zero crossing points that correlate to the transition times of a clock signal V_Q . By shifting clock switching times to the waveform shown as V_Q' , it can be seen that a period of time in which I_{IN} switches to I_{OUT} for system **300** is created.

FIG. **5** is a diagram of a system **500** that is configured to resonate at two different frequencies, in accordance with an exemplary embodiment of the present disclosure. System **500** measures the DC voltage and current at the rectifier **504** output, and controller **502** causes switches **S1** through **Sn** to switch capacitive elements **C1** through **Cn** in parallel and series with the exemplary inductances and capacitance as shown, to control the power output of the rectifier to load elements **506A** and **506B**. The number of capacitive elements and corresponding switches can be used to control the tunable range and accuracy of system **500**. Alternatively, other types of passive devices can be used for tuning and gain adjustment such as resistors, inductors, capacitors and others.

In a resonant system, both the transmitting and receiving entities can be tuned so that both sides resonate at the same frequency, thus maximizing power transfer. Tuning can be accomplished by switching capacitive elements into or out of the antenna circuits using high-bandwidth low-loss switches. The DC current of an associated bridge rectifier output can be measured using a current sense amplifier or in other suitable manners, and the current measurement can then be maximized by switching capacitive elements into or out of the resonating circuit, or in other suitable manners.

FIG. **6** is a diagram of a system **600** with a step-down DC/DC switching converter, in accordance with an exemplary embodiment of the present disclosure. Buck DC/DC switching converter **606** regulates the output of rectifier bridge **604** to the load. The measurement of output current I_{OUT} can be performed at the output of buck **606**, rather than at the output of rectifier **604**, and this current measurement can be used in the tuning algorithm that chooses the tuning and gain adjustment elements to switch in to or out of the circuit formed by capacitors **C1** through **Cn** and the other exemplary capacitive and inductive elements as shown. Alternatively, controller **602** can provide step-up control, step-down control, linear control, a combination of switching and linear control or other suitable controls. Switching tuning capacitor elements **C1** through **Cn** or other suitable elements in the resonant circuit of system **600** can also or alternatively be used to increase the transmitter to receiver antenna-to-antenna separation range on a magnetic induction power transfer system by tuning the receiver to a resonance mode, as a function of the transmitter frequency.

FIG. **7** is a diagram of a system **700** with a passive resonator that acts as a repeater in a magnetic resonant power transfer system, in accordance with an exemplary embodiment of the present disclosure. The passive resonator of system **700** is constructed similar to the primary transmitter resonant antenna circuit. System **700** can be located within a magnetic flux field generated by an active transmitter, which can then be excited by that magnetic field to enable power and data transfer over a broader spatial range than in a system with a non-resonant transmitter antenna alone. Tuning controller **710** can be powered by a captive supply, by scavenging energy from the power transfer system or in other suitable manners. System **700** can be tuned to resonate at a frequency of a transmitter by switching capacitive elements **708A** through **708N** as a function of

measured current or power. By maximizing the measured current or power, a tuning algorithm can choose the correct combination of capacitive elements **708A** through **708N** to include in the resonant circuit. For example, a simple search algorithm can be implemented that starts with the lowest capacitance value for the combination of capacitors, and which then increases the capacitance value by the smallest next step, until a peak measured current or power is detected, such as by comparing a current or power measurement from a prior setting to a current or power measurement for a present setting, and stopping the search process when the current or power measurement starts to decrease. In another exemplary embodiment, a binary search algorithm, a linear search algorithm, an asymptotic search algorithm, a geometric search algorithm, or other suitable search algorithms can also or alternatively be utilized. System **700** includes inductor **702**, capacitor **704**, capacitor **706** and resistor **712**.

FIG. **8** is a diagram of class E transmitter **800**, in accordance with an exemplary embodiment of the present disclosure. Class E transmitter **800** can be used to transmit power to a low-frequency magnetic induction receiver, a higher-frequency electro magnetic resonance receiver or other suitable receivers. In this exemplary embodiment, class E transmitter **800** has two different antenna elements—a 0.5 uH inductive element for low frequency signals, and a 24 uH inductive element for high frequency signals, but other suitable circuit elements can also or alternatively be used. System **800** includes transistor **802**, resistor **804**, capacitor **806**, capacitor **808**, diode **810**, diode **812** and capacitor **814**.

FIG. **9** is a diagram **900** of an AC current waveform generated by class E transmitter **800**. A high frequency magnetic resonance carrier **902** is contained in a lower frequency envelope **904** suitable for magnetic inductance. In this exemplary embodiment, the high frequency carrier is 6.7 MHz and is radiated by the 0.5 uH antenna for reception by a magnetic resonant receiver. The low frequency envelope can vary between 110 to 205 kHz and is radiated by the 24 uH antenna for reception by a magnetic induction receiver. A class D receiver, class G receiver, class A receiver, class AB receiver or other suitable configurations can also or alternatively be used to drive the power. A class E transmitter, such as that used in an A4WP configuration, can also be used to perform on-off keying (OOK) modulation, and other suitable modulation types can also or alternatively be used, including but not limited to PSK, FSK, PCM, and QAM modulation.

FIG. **10A** is a diagram **1000** of exemplary waveforms for receiver type detection, in accordance with an exemplary embodiment of the present disclosure. The PMA RX signal is an exemplary communication from a PMA receiver. The Qi receiver signal is an exemplary communication from a Qi receiver. The transmitter power signal is an exemplary presence of wireless power (ping sequence) as a sine wave of a high frequency. In normal operation, only one of the receivers will be sending the signal. The transmitter selects the standard used by the receiver by looking at the communication during the ping sequence.

FIG. **10B** is a diagram of a single-ping algorithm **1002** for receiver type detection, in accordance with an exemplary embodiment of the present disclosure. Algorithm **1002** can be implemented in hardware or a suitable combination of hardware and software.

As used herein, “hardware” can include a combination of discrete components, an integrated circuit, an application-specific integrated circuit, a field programmable gate array, or other suitable hardware. As used herein, “software” can include one or more objects, agents, threads, lines of code,

subroutines, separate software applications, two or more lines of code or other suitable software structures operating in two or more software applications, on one or more processors (where a processor includes a microcomputer or other suitable controller, memory devices, input-output devices, displays, data input devices such as a keyboard or a mouse, peripherals such as printers and speakers, associated drivers, control cards, power sources, network devices, docking station devices, or other suitable devices operating under control of software systems in conjunction with the processor or other devices), or other suitable software structures. In one exemplary embodiment, software can include one or more lines of code or other suitable software structures operating in a general purpose software application, such as an operating system, and one or more lines of code or other suitable software structures operating in a specific purpose software application. As used herein, the term “couple” and its cognate terms, such as “couples” and “coupled,” can include a physical connection (such as a copper conductor), a virtual connection (such as through randomly assigned memory locations of a data memory device), a logical connection (such as through logical gates of a semiconducting device), other suitable connections, or a suitable combination of such connections.

At **1004**, a transmitter broadcasts a ping compatible with multiple protocols, such as the TX POWER waveform. The transmitter can be operated by a suitable controller, such as by using digital controls from a programmable controller, an application-specific integrated circuit, a field programmable gate array or other suitable devices. The algorithm then proceeds to **1006**.

At **1006**, one or more receiver responses are detected, such as the PMA or Qi waveforms of FIG. **10A** or other suitable responses. The responses can be detected by monitoring a voltage detected at a receiver circuit or in other suitable manners. The algorithm then proceeds to **1008**.

At **1008**, it is determined whether a response in accordance with a first standard has been received, such as by comparing a measured voltage to a first voltage waveform stored in memory or in other suitable manners. If a response in accordance with the first standard has been received, the algorithm proceeds to **1012**, where a first power or data transfer phase setting is implemented, such as by selecting a first predetermined switch setting for capacitive element control switches, as discussed herein, or in other suitable manners. Otherwise, the algorithm proceeds to response **1010**.

At **1010**, it is determined whether a response in accordance with a second standard has been received, such as by comparing a measured voltage to a second voltage waveform stored in memory or in other suitable manners. If a response in accordance with the second standard has been received, the algorithm proceeds to **1012**, where a second power or data transfer phase setting is implemented, such as by selecting a second predetermined switch setting for capacitive element control switches, as discussed herein, or in other suitable manners. Otherwise, the algorithm returns to **1004**. Likewise, other suitable detection processes can be used for other suitable standards.

Based on the detected data, the transmitter adjusts its transmission configuration to complement the detected receiver protocol. A true multi-mode wireless power transmitter can be constructed to dynamically change its operating point according to the protocol of the receiver presented. The transmitter can interrogate the receiver by broadcasting a ping and receiving a response that informs the transmitter the type of receiver that is present. A single ping that works

for more than one standard, multiple pings that each correspond to a different standard, or other suitable processes can also or alternatively be used.

FIG. 11 is a diagram of a multi-ping algorithm 1100 for receiver type detection, in accordance with an exemplary embodiment of the present disclosure. Algorithm 1002 can be implemented in hardware or a suitable combination of hardware and software.

Algorithm 1100 begins at 1102, where a transmitter broadcasts a separate ping for a first standard or protocol. In one exemplary embodiment, the transmitter can be connected to a controller using a digital data communications medium, and can receive one or more digital controls that cause associated circuitry to generate a first waveform, or other suitable processes can also or alternatively be used. The algorithm then proceeds to 1104.

At 1104, the controller monitors signals generated by a receiver for a response. In one exemplary embodiment, the controller can be connected to the receiver using a digital data communications medium, and can transmit one or more analog or digital controls that are processed by the controller to detect a response, such as by comparing the received signal to an allowable received signal or in other suitable manners. The algorithm then proceeds to 1106.

At 1106, it is determined whether a correct response was received. If a correct response was not received, the algorithm proceeds to 1108, otherwise the algorithm proceeds to 1114, where a power or data transfer phase is selected to adjust a transmission configuration to complement the receiver requirement.

At 1108, a transmitter broadcasts a separate ping for a second standard or protocol. The algorithm then proceeds to 1110, where the controller monitors signals generated by a receiver for a response. The algorithm then proceeds to 1112.

At 1112, it is determined whether a correct response was received. If a correct response was not received, the algorithm returns to 1102, otherwise the algorithm proceeds to 1114, where a power or data transfer phase is selected to adjust a transmission configuration to complement the receiver requirement.

The single-ping or multi-ping algorithm can be used for both magnetic induction and magnetic resonance systems. Alternatively, the receiver can broadcast data to the transmitter, and upon receiving a response, change its configuration to match the capability of the transmitter. Alternatively, the device may be a transceiver that interrogates through a ping to adjust its configuration to be either a transmitter or receiver, and what type of protocol the complementary device can support. Additionally, other elements can be adjusted, such as power, voltage, foreign object detection characteristics, thermal requirements, data rate, and physical antenna separation.

In order to manage and ensure safe voltages at the receiver-rectified voltage during a transmitter ping phase, the configuration of the transmitter bridge can be switched during an initial ping and receiver wake-up period. For a wireless power protocol or standard that requires higher voltages for receiver wake-up, the transmitter power section can be started in a half-bridge configuration for the initial ping(s). If the half-bridge pings are not sufficient to wake up the receiver, then the bridge can be configured in full-bridge mode at an appropriate duty cycle. This algorithm also allows the half-bridge and full-bridge pings to be performed at the same frequency, in order to comply with standards requirements. This bridge switching behavior allows true multi-standard transmitter operation with a wide variety of

receiver configurations, while simultaneously ensuring safe voltage levels on the receiver to prevent damage.

For demodulating the communication from the receiver to transmitter in a magnetic inductive system, such as one that conforms to the Power Matters Alliance (PMA) standard, the transmit coil voltage waveform is sampled. Multiple samples are taken during a first period and are stored in a buffer. The values of these samples are compared to samples taken at previous periods. If the samples of the current period are different than the previous samples, then a demodulation algorithm can trigger a change in a transmit state, which can direct a control algorithm to measure a pulse between disturbances. The length of this pulse can be used to determine whether to increase or reduce the current into the transmit coil, and therefore the power output of the transmitter.

FIG. 12 shows one of the possible types of waveforms of the receive communication and transmit coil voltage during communication. The periodic waveform of the transmitter coil voltage is disturbed by a communication pulse sent by the receiver. The waveform looks similar to a sine wave before the pulse but gets distorted to a random waveform for a certain period of time after the pulse, after which it slowly recovers and comes back to the sine-like waveform.

FIG. 13 is a diagram of a demodulation algorithm 1300, in accordance with an exemplary embodiment of the present disclosure. Algorithm 1300 can be implemented in hardware or a suitable combination of hardware and software.

Algorithm 1300 can be used for demodulating a communication from a receiver to a transmitter in a magnetic inductive system, such as one that conforms to the Wireless Power Consortium (Qi®) standard, where sub-Nyquist sampling of the transmit AC coil voltage is performed at a particular frequency, and which is then averaged in order to determine amplitude and phase changes on the carrier.

Algorithm 1300 begins at 1302, where a receiver modulates a communication link. In one exemplary embodiment, the receiver can be coupled to a digital controller and can receive one or more digital control signals that cause the communications link to be modulated in accordance with one or more frequency or data parameters. The algorithm then proceeds to 1304.

At 1304, the transmitter samples the communications link, such as by receiving one or more analog samples and by converting the analog samples to digital values, or in other suitable manners. The algorithm then proceeds to 1306.

At 1306, the sampled data is processed, such as by storing the data in a buffer or in other suitable manners. The algorithm then proceeds to 1308.

At 1308, the transmitter processes the buffered data, such as by comparing the buffered data to data from a previous period, to a stored waveform or in other suitable manners. The algorithm then proceeds to 1310.

At 1310, it is determined whether a valid communication has been detected. If a valid communication has not been detected, the algorithm returns to 1302, otherwise the algorithm proceeds to 1312.

At 1312, the transmitter changes an operating point. FIG. 14 is a diagram of a system 1400 for processing data, in accordance with an exemplary embodiment of the present disclosure. System 1400 includes analog to digital converter 1402 and averager 1404. The sampling points input into analog to digital converter 1402 are taken at predetermined points on an input waveform. Because the system continuously samples these known points, it requires less sampling and processing resources to perform the demodulation,

11

which reduces the overall complexity and cost of the system. An averager can generate average value data for determining amplitude or phase changes.

FIG. 15 shows one of the possible types of waveforms of the receive communication and transmit coil voltage during communication.

In a wireless power transfer system, bi-directional communication between a receiver and transmitter can be used for multiple purposes. Data transfer between the receiver and transmitter can be used to communicate system status and capability of each side of the interface, to ensure the transfer is accomplished at the highest efficiency and shortest charging times. Similarly, this communication can be used to aid in the detection of foreign metallic objects within the magnetic field, for receiver and transmitter authentication to ensure that only compatible devices are connected, for financial transactions between receiver and transmitter to enable pay-for-charging in public infrastructure applications, for the transmitter and receiver to negotiate the maximum power to be transferred in the system, to push advertisements to an end user, to transfer application data between a receiver and a transmitter, or for other suitable purposes.

FIG. 16 is a diagram of amplitude modulation, in accordance with an exemplary embodiment of the present disclosure. The frequency of the sine wave can be increased slightly to fit more cycles inside each stable level of the receiver waveform. The frequency is the same, but the amplitude changes based on the receiver level.

FIG. 17 is a diagram of frequency modulation, in accordance with an exemplary embodiment of the present disclosure. As shown in FIG. 17, the amplitude is the same, but the frequency is higher or lower. The receiver demodulates the signal and obtains levels of zero or one. Alternatively, this application can be used for power banks, "Internet of Things" (IoT) appliances, autonomous systems, medical/body monitoring, passive electronic systems such as credit cards or other suitable applications.

In order to regulate the output voltage of the wireless power receiving entity, a periodic communication signal can be asserted on the receiver resonant circuit. This periodic signal can be generated with a simple low-cost analog circuit to save cost and board space. The signal functions as the "heartbeat" of the system, and can signal both the need for the transmitter or receiver to change its operation point or function. Alternatively, the signal can be used for the transmitter to identify both the presence of a receiver and to authenticate a receiver, to control the function of the transmitter from the receiver, to signal to a transmitter when a receiver has an error condition or has been removed, to transfer encoded or unencoded data between two entities, or for other suitable purposes. A combination of amplitude and frequency can be used for this type of "heartbeat" communication, PSK or FSK can be used for this type of "heartbeat" communication, or other suitable data can also or alternatively be used.

FIG. 18 is a diagram of a circuit 1800 for providing a capacitive grid that can be used to detect metallic objects, in accordance with an exemplary embodiment of the present disclosure. Circuit 1800 includes leads L1 through L6, which are each coupled to a pair of capacitors. Other sensing arrays or grids can be used with other passive or active devices. Circuit 1800 includes capacitors 1802 through 1818.

Foreign metallic objects can be detected within the magnetic field of a wireless power transfer system using an array of capacitive sensors placed above or near the transmit

12

antenna. The capacitive sensors can be arranged in an X-Y grid so they can be combined into rows and columns to reduce the number of connections to the control circuitry. When a change is detected in one or more of the capacitive sensors, a foreign object is detected in the field and the transmitter can act appropriately.

Similarly, foreign metallic objects can be detected within the magnetic field of a multi-mode magnetic inductive and magnetic resonant wireless power transfer system using the inactive antenna. If the magnetic inductive interface is active, a change in the impedance of the magnetic resonant antenna would signal that a foreign object has entered the magnetic field and the transmitter can act appropriately. Likewise, the magnetic inductive antenna could be used to sense objects in the magnetic resonant field when active.

The receiver coil and bridge rectifier in a wireless power receiver can also be used to emulate a synchronous step-up (boost) circuit to increase the voltage output of the rectifier. Similarly, the receiver coil and bridge rectifier in a wireless power receiver can also be used to emulate a synchronous step-down (buck) circuit to decrease the voltage output of the rectifier.

It should be emphasized that the above-described embodiments are merely examples of possible implementations. Many variations and modifications may be made to the above-described embodiments without departing from the principles of the present disclosure. All such modifications and variations are intended to be included herein within the scope of this disclosure and protected by the following claims.

What is claimed is:

1. A wireless device comprising:

an antenna system comprising at least one inductive element and two or more capacitive elements;

a switching component configured to change a circuit configuration of the capacitive elements; and

a controller configured to transmit a signal using the antenna system and to receive a response from a first device, to determine a communications protocol associated with the first device and to change a configuration of the antenna system in response to the determined communications protocol by actuating the switching component, wherein the antenna system is configured to transmit a first signal in accordance with a first protocol and to transmit a second signal in accordance with a second protocol if no response is received after a predetermined period of time.

2. The wireless device of claim 1 wherein the controller is configured to detect whether the first device is within proximity to the controller and to transmit the first signal or the second signal in response to the detection.

3. The wireless device of claim 1 wherein the controller is configured to cause the antenna system to transmit the first signal, to wait a predetermined period of time for a response, and then to transmit the second signal if no response is received.

4. The wireless device of claim 1 wherein the controller is configured to cause the antenna system to transmit additional signals in accordance with additional protocols until a response is received.

5. The wireless device of claim 1 wherein the controller is configured to maximize a power transfer or efficiency by tuning a transmitting entity and a receiving entity to each resonate at a frequency.

6. The wireless device of claim 1 wherein the switching component comprises one or more high-bandwidth, low-loss switches, and further comprising a device configured to

13

measure one of a voltage, a current or a power in the first device, and wherein the controller is configured to actuate the switches as a function of the measured voltage, current or power in the first device.

7. The wireless device of claim 1 wherein the controller is configured to transmit a signal that can generate a response in accordance with multiple different protocols.

8. A method comprising:

transmitting a signal to an antenna system comprising at least one inductive element and two or more capacitive elements;

receiving a response from a first device;

determining a communications protocol associated with the first device;

changing a configuration of the antenna system in response to the determined communications protocol by actuating a switching component configured to change a circuit configuration of the capacitive elements;

transmitting a first signal in accordance with a first protocol;

waiting a predetermined period of time for a response; and

transmitting a second signal in accordance with a second protocol if no response is received.

9. The method of claim 8 further comprising:

detecting whether the first device is within proximity to the controller; and

transmitting the first signal or the second signal in response to the detection.

10. The method of claim 8 further comprising:

transmitting a first data signal;

waiting a predetermined period of time for a response; and

transmitting a second data signal if no response is received.

11. The method of claim 8 further comprising transmitting additional signals in accordance with additional protocols until a response is received.

12. The method of claim 8 further comprising maximizing a power transfer or efficiency by tuning a transmitting entity and a receiving entity to each resonate at a frequency.

14

13. The method of claim 8 wherein the switching component comprises one or more high-bandwidth, low-loss switches, and further comprising:

measuring one of a voltage, a current or a power in the first device; and

actuating the switches as a function of the measured voltage, current or power in the first device.

14. The method of claim 8 further comprising transmitting a signal that can cause a response to be generated in accordance with multiple different protocols.

15. A method comprising:

transmitting a signal to an antenna system comprising at least one inductive element and two or more capacitive elements;

receiving a response from a first device as a function of the signal;

determining a communications protocol associated with the first device;

changing a configuration of the antenna system in response to the determined communications protocol by automatically changing a circuit configuration of the antenna system;

transmitting a first signal in accordance with a first protocol;

waiting a predetermined period of time for a response; and

transmitting a second signal in accordance with a second protocol if no response is received.

16. The method of claim 15 further comprising detecting whether the first device is within proximity to the controller.

17. The method of claim 16 further comprising transmitting the first signal or the second signal in response to the detection.

18. The method of claim 15 further comprising transmitting a first data signal.

19. The method of claim 18 further comprising waiting a predetermined period of time for a response to the first data signal.

20. The method of claim 19 further comprising transmitting a second data signal if no response to the first data signal is received.

* * * * *