

US010566336B1

(12) **United States Patent**
Guo et al.

(10) **Patent No.:** **US 10,566,336 B1**
(45) **Date of Patent:** **Feb. 18, 2020**

(54) **THREE-DIMENSIONAL MEMORY DEVICES HAVING THROUGH ARRAY CONTACTS AND METHODS FOR FORMING THE SAME**

(71) Applicant: **YANGTZE MEMORY TECHNOLOGIES CO., LTD.**, Wuhan (CN)

(72) Inventors: **Mei Lan Guo**, Wuhan (CN); **Yushi Hu**, Wuhan (CN); **Ji Xia**, Wuhan (CN); **Hongbin Zhu**, Wuhan (CN)

(73) Assignee: **YANGTZE MEMORY TECHNOLOGIES CO., LTD.**, Wuhan (CN)

(*) Notice: Subject to any disclaimer, the term of this patent is extended or adjusted under 35 U.S.C. 154(b) by 0 days.

(21) Appl. No.: **16/149,103**

(22) Filed: **Oct. 1, 2018**

Related U.S. Application Data

(63) Continuation of application No. PCT/CN2018/101482, filed on Aug. 21, 2018.

(51) **Int. Cl.**
H01L 27/11531 (2017.01)
H01L 27/11524 (2017.01)
(Continued)

(52) **U.S. Cl.**
CPC .. **H01L 27/11531** (2013.01); **H01L 21/76816** (2013.01); **H01L 21/76877** (2013.01);
(Continued)

(58) **Field of Classification Search**
CPC **H01L 27/11531**; **H01L 21/76816**; **H01L 21/76877**; **H01L 23/5226**; **H01L 23/5283**;
(Continued)

(56) **References Cited**

U.S. PATENT DOCUMENTS

2014/0175532 A1 6/2014 Chen
2016/0099255 A1 4/2016 Lai
2017/0125430 A1 5/2017 Nishikawa et al.

FOREIGN PATENT DOCUMENTS

CN 106256005 A 12/2016
CN 106910746 A 6/2017
(Continued)

OTHER PUBLICATIONS

International Search Report issued in corresponding International Application No. PCT/CN2018/101482, dated May 5, 2019, 5 pages.
(Continued)

Primary Examiner — Dzung Tran

(74) *Attorney, Agent, or Firm* — Bayes PLLC

(57) **ABSTRACT**

Embodiments of three-dimensional (3D) memory devices having through array contacts (TACs) and methods for forming the same are disclosed. In an example, a method for forming a 3D memory device is disclosed. A dielectric stack including a plurality of dielectric/sacrificial layer pairs is formed on a substrate. A channel structure extending vertically through the dielectric stack is formed. A first opening extending vertically through the dielectric stack is formed. A spacer is formed on a sidewall of the first opening. A TAC extending vertically through the dielectric stack is formed by depositing a conductor layer in contact with the spacer in the first opening. A slit extending vertically through the dielectric stack is formed after forming the TAC. A memory stack including a plurality of conductor/dielectric layer pairs is formed on the substrate by replacing, through the slit, the sacrificial layers in the dielectric/sacrificial layer pairs with a plurality of conductor layers.

17 Claims, 20 Drawing Sheets

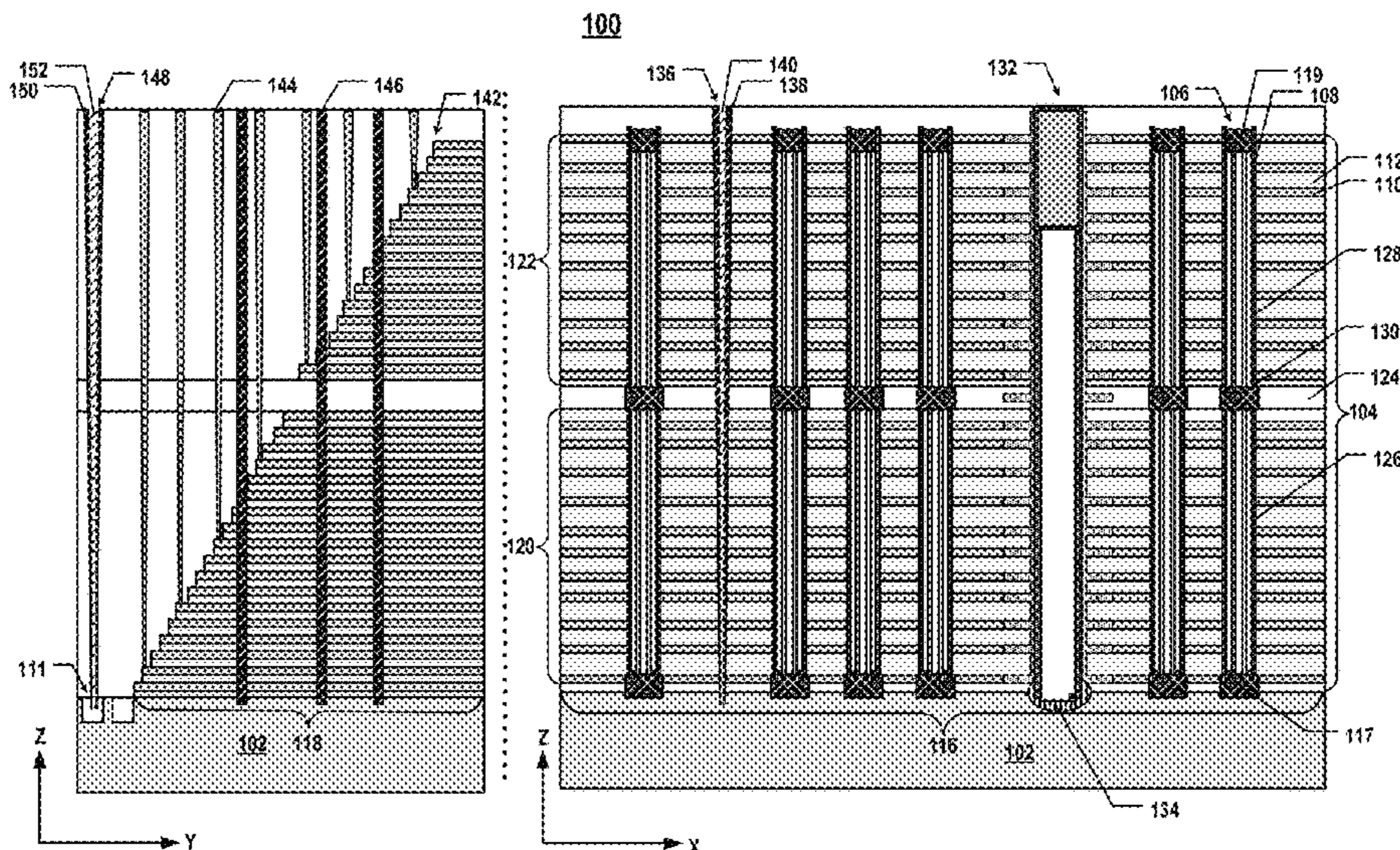

- (51) **Int. Cl.**
H01L 27/11556 (2017.01)
H01L 27/11529 (2017.01)
H01L 27/1157 (2017.01)
H01L 23/522 (2006.01)
H01L 27/11573 (2017.01)
H01L 21/768 (2006.01)
H01L 23/528 (2006.01)
H01L 27/11582 (2017.01)
- (52) **U.S. Cl.**
CPC *H01L 23/5226* (2013.01); *H01L 23/5283*
(2013.01); *H01L 27/1157* (2013.01); *H01L*
27/11524 (2013.01); *H01L 27/11529*
(2013.01); *H01L 27/11556* (2013.01); *H01L*
27/11573 (2013.01); *H01L 27/11582* (2013.01)
- (58) **Field of Classification Search**
CPC H01L 27/11524; H01L 27/11529; H01L
27/11556; H01L 27/1157; H01L
27/11573; H01L 27/11582

USPC 257/314
See application file for complete search history.

(56) **References Cited**

FOREIGN PATENT DOCUMENTS

CN	106920794 A	7/2017
CN	106920796 A	7/2017
CN	107771356 A	3/2018
CN	108140644 A	6/2018
CN	108377660 A	8/2018

OTHER PUBLICATIONS

Written Opinion of the International Searching Authority issued in
corresponding International Application No. PCT/CN2018/101482,
dated May 5, 2019, 4 pages.

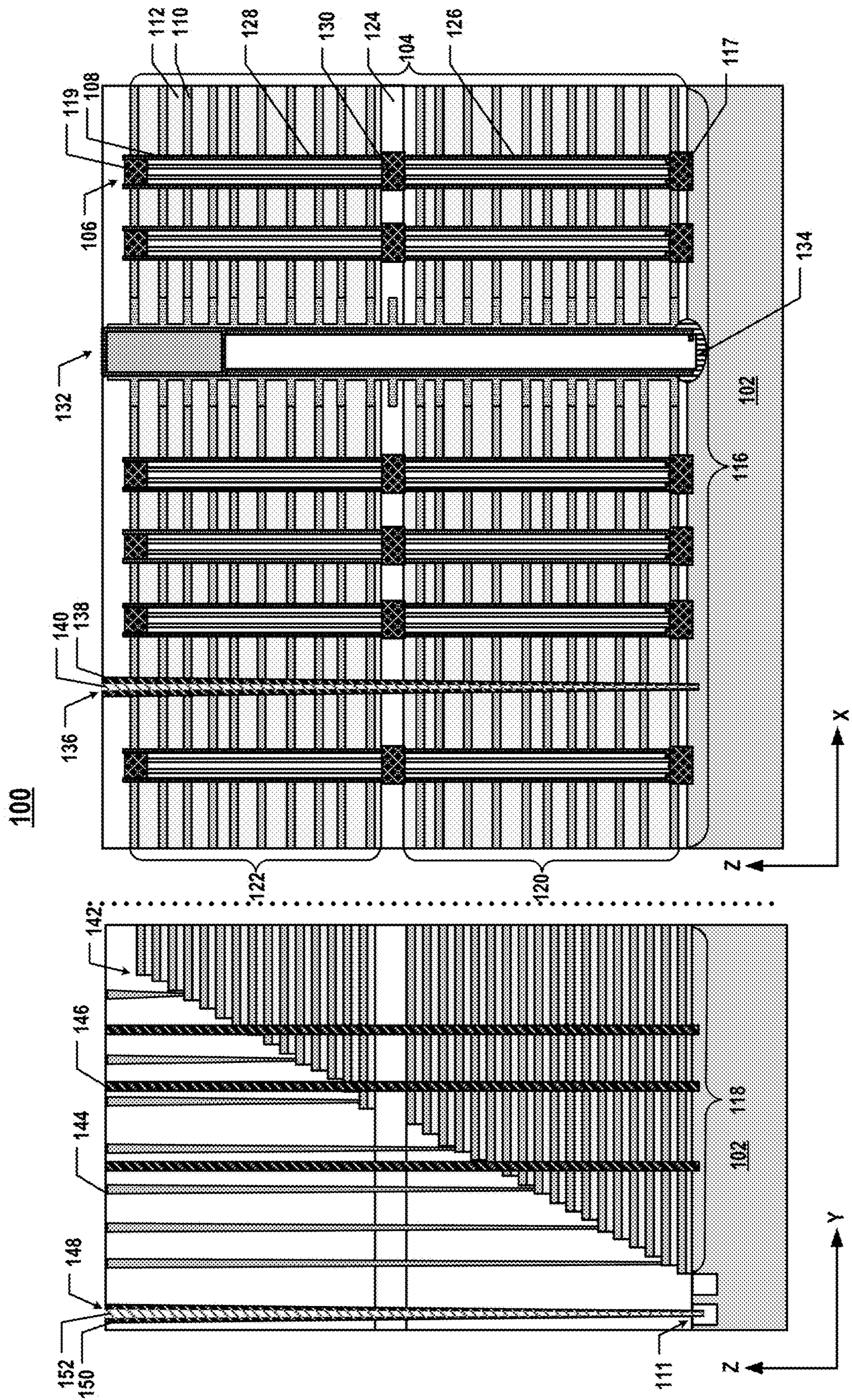

FIG. 1

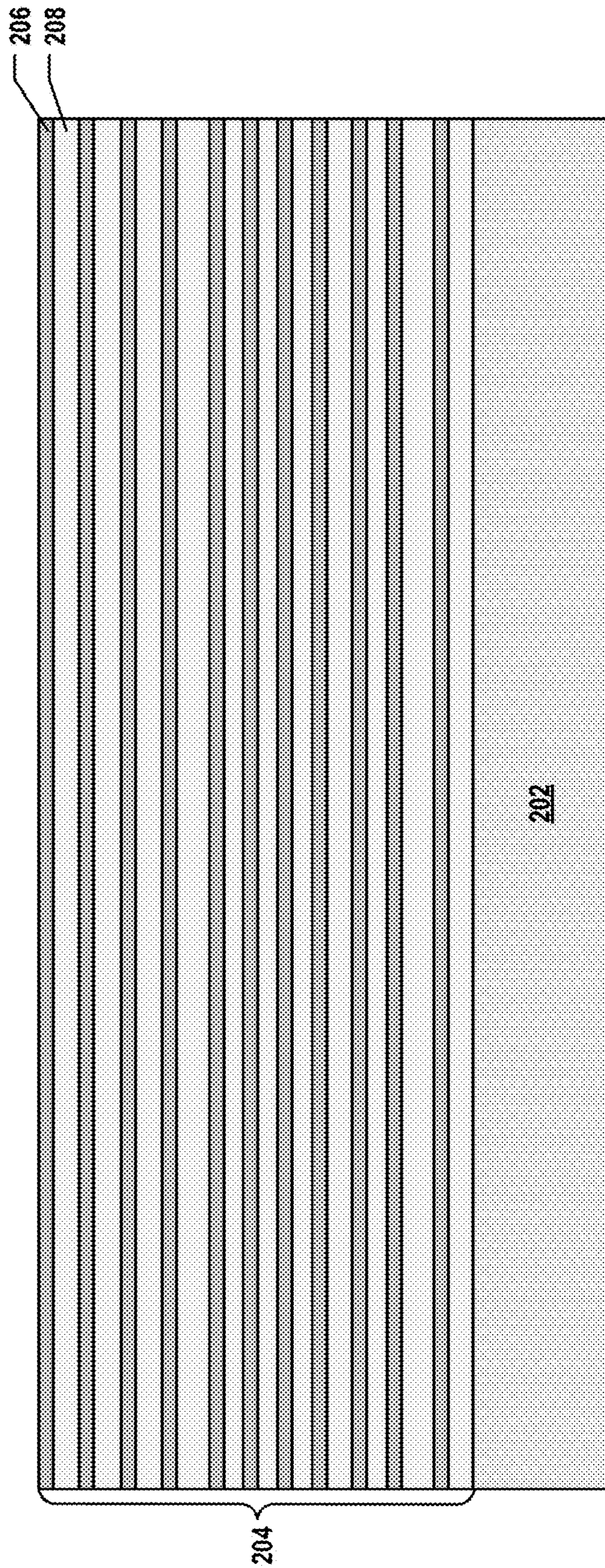

FIG. 2A

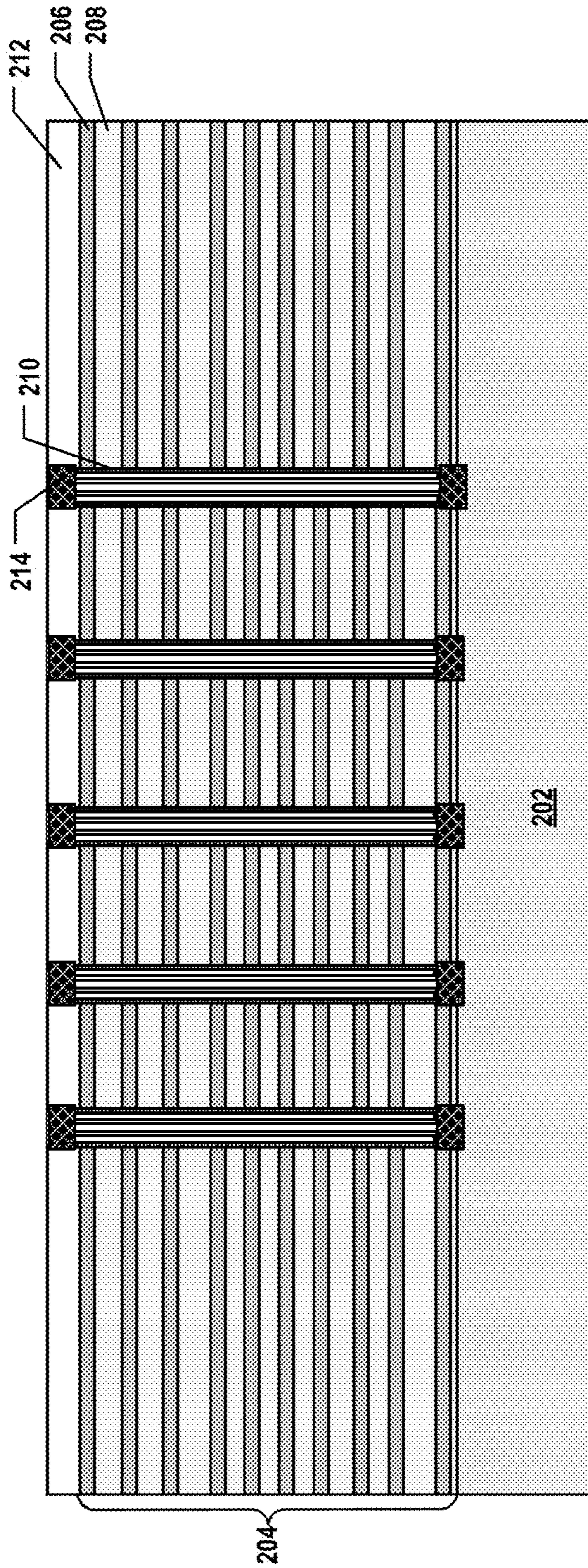

FIG. 2B

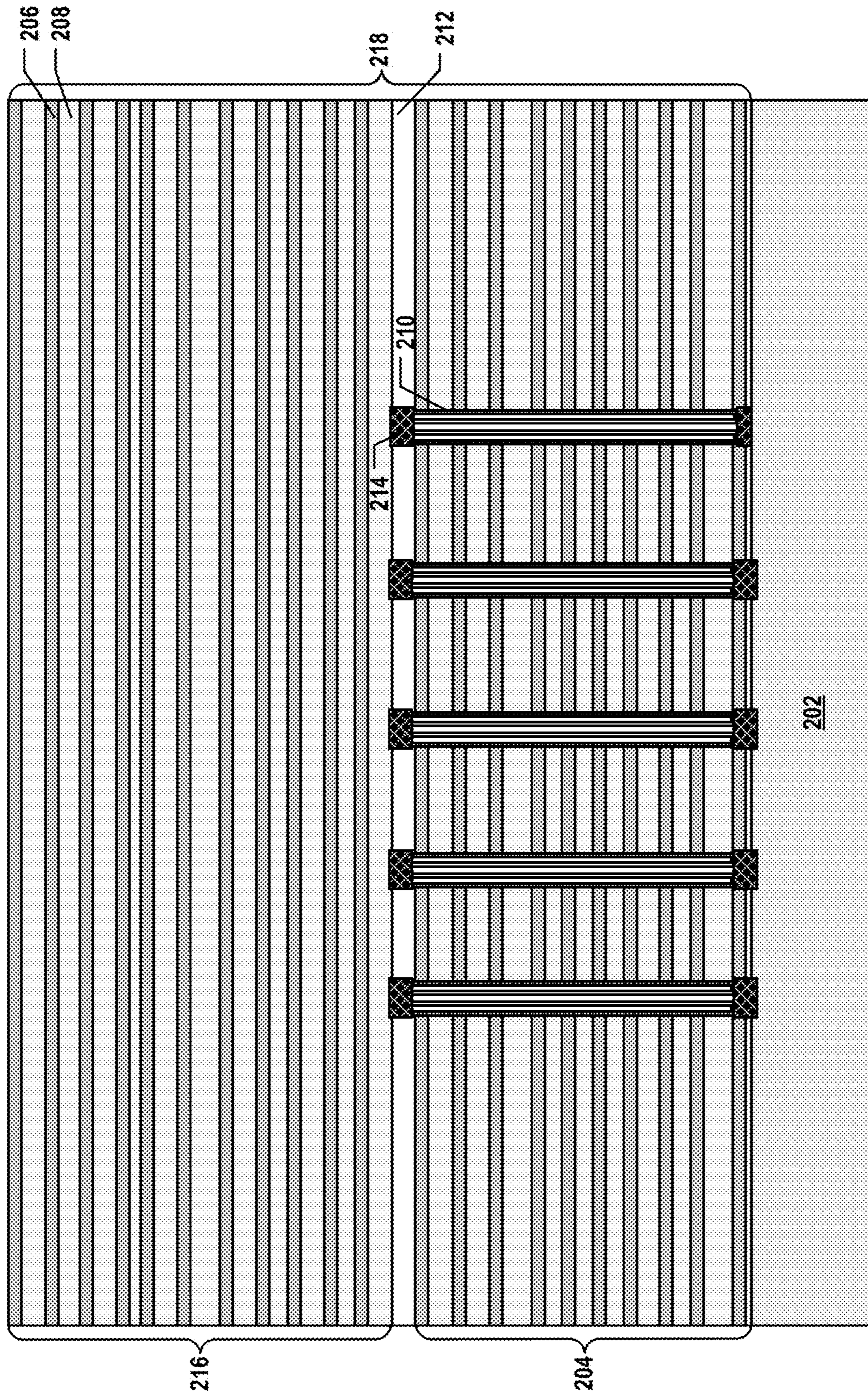

FIG.2C

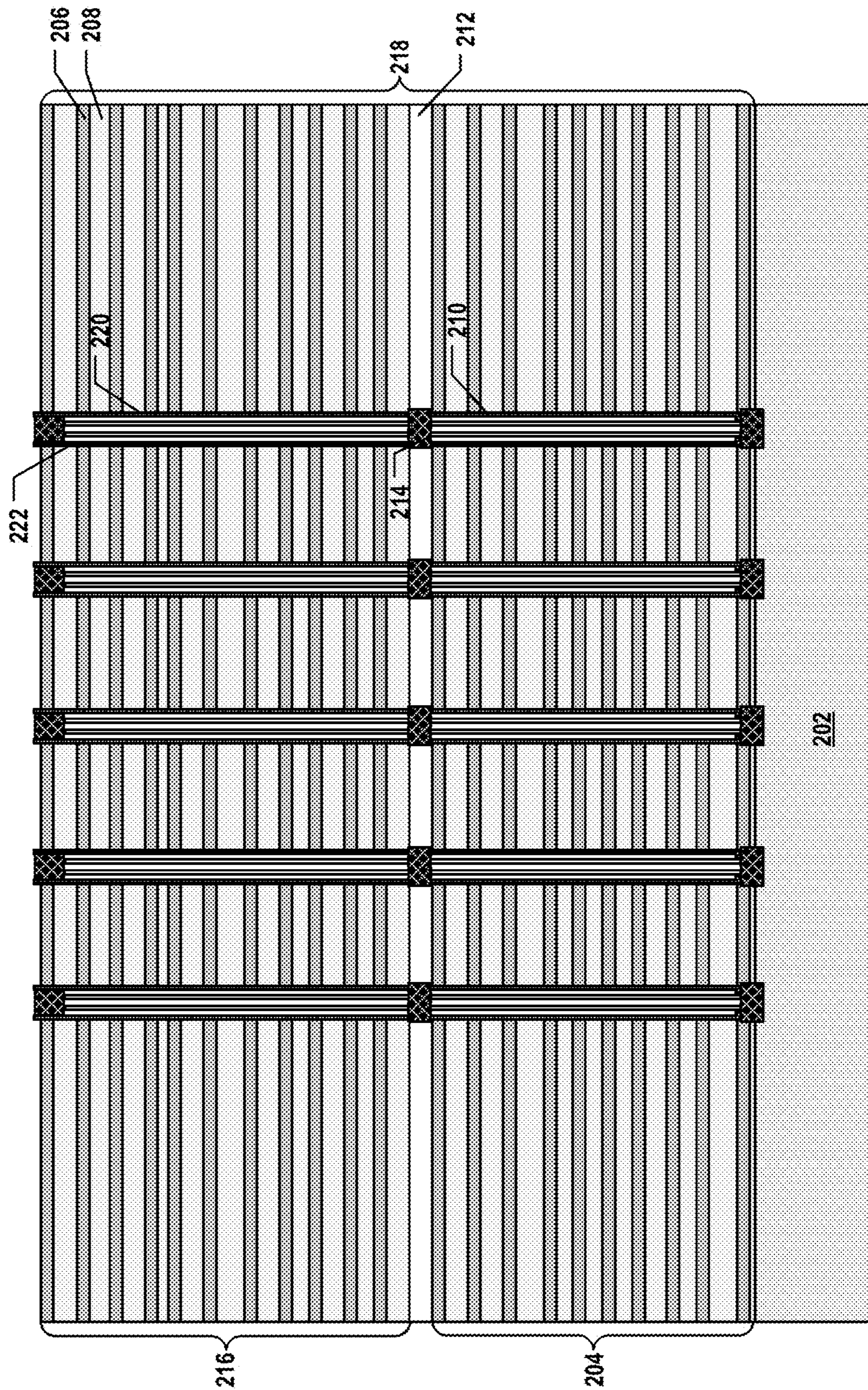

FIG. 2D

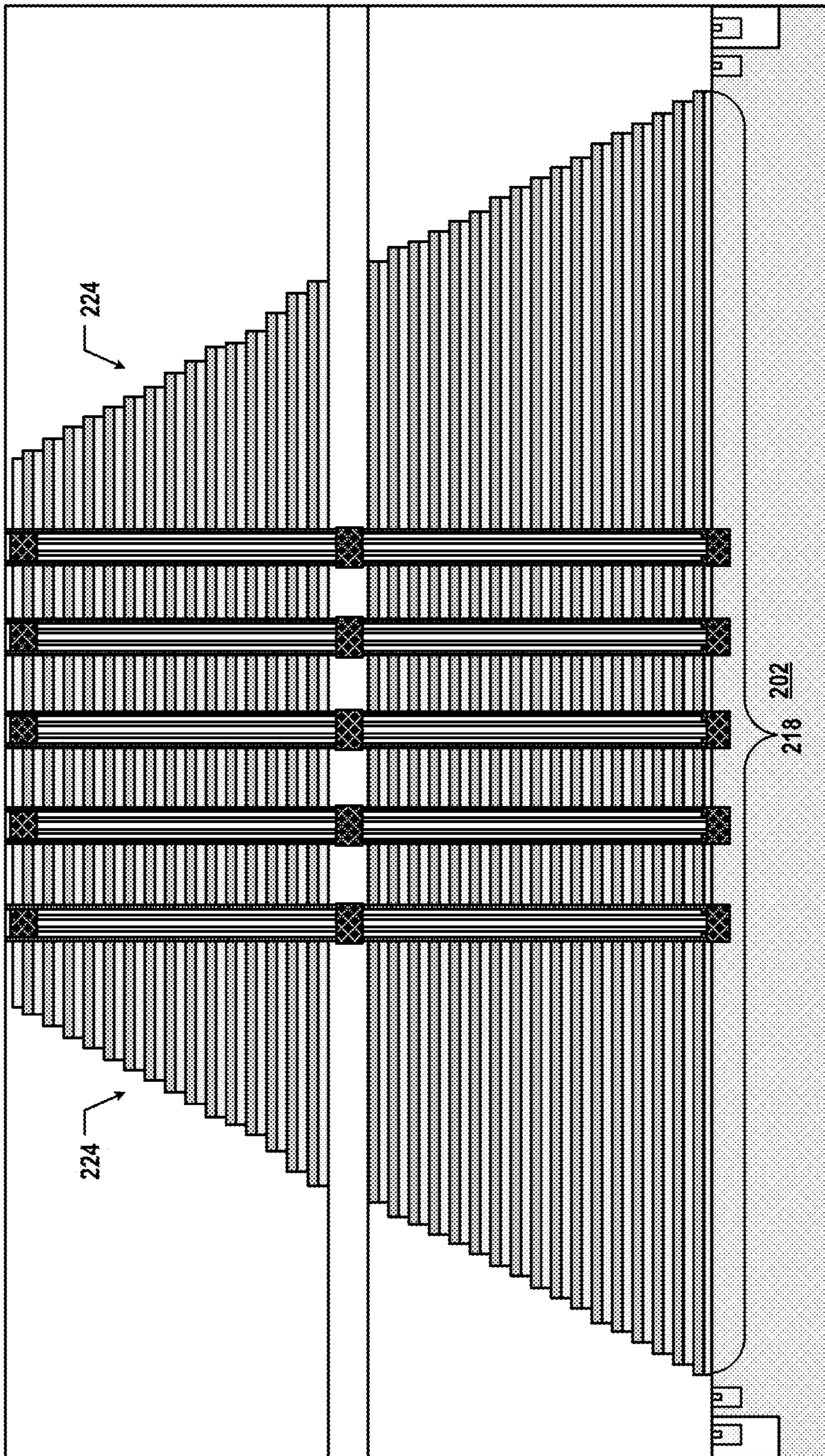

FIG. 2E

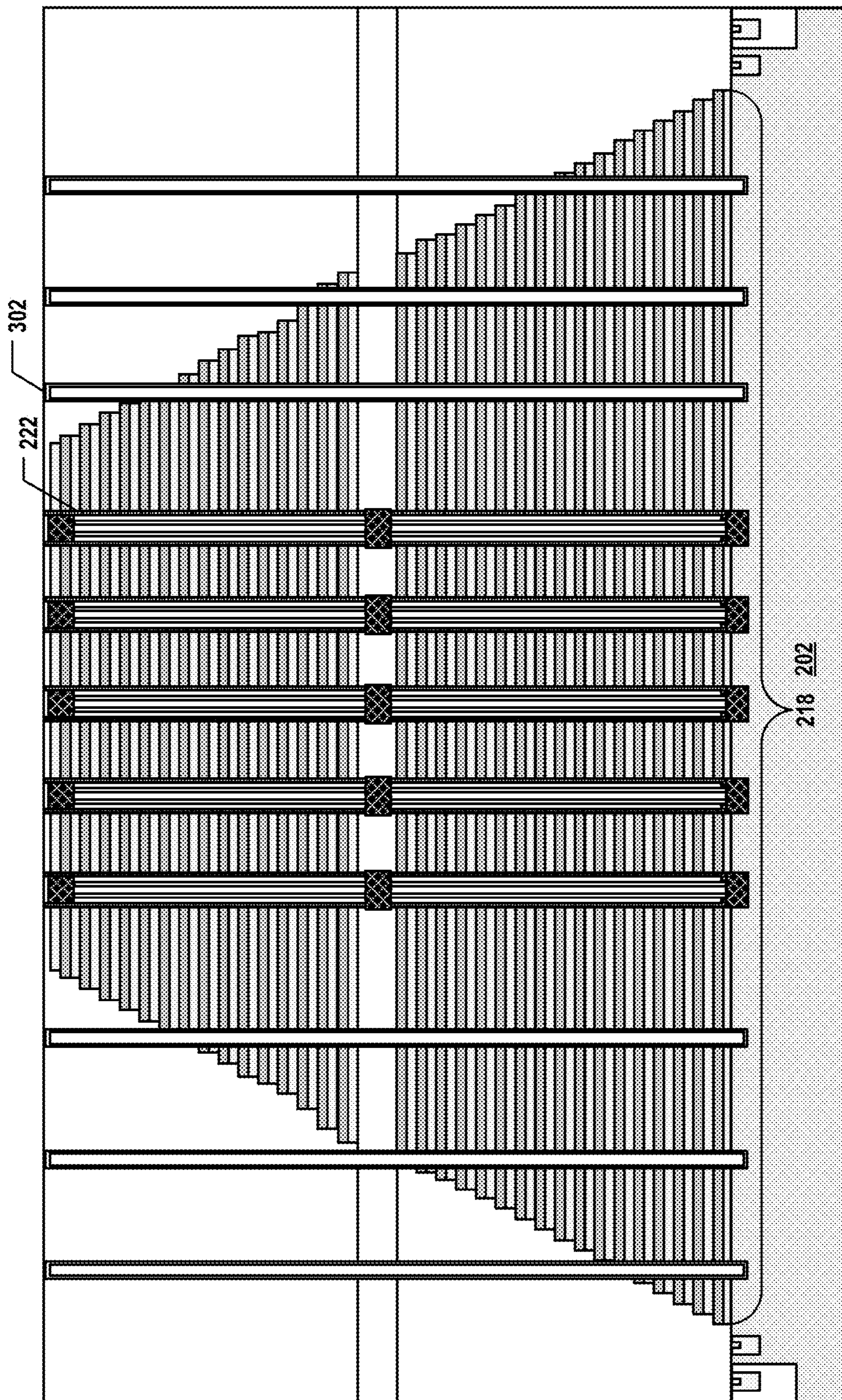

FIG. 3A

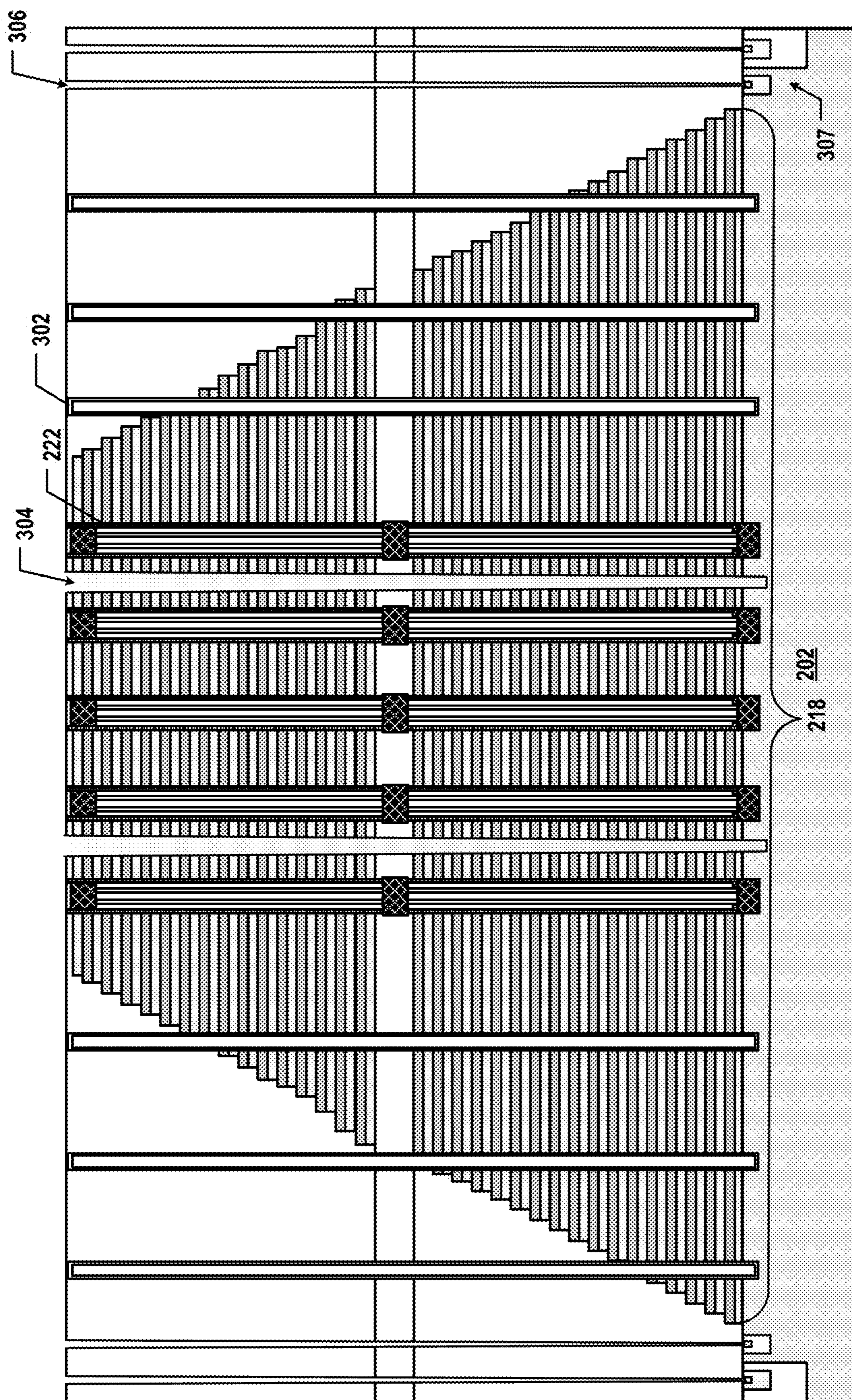

FIG. 3B

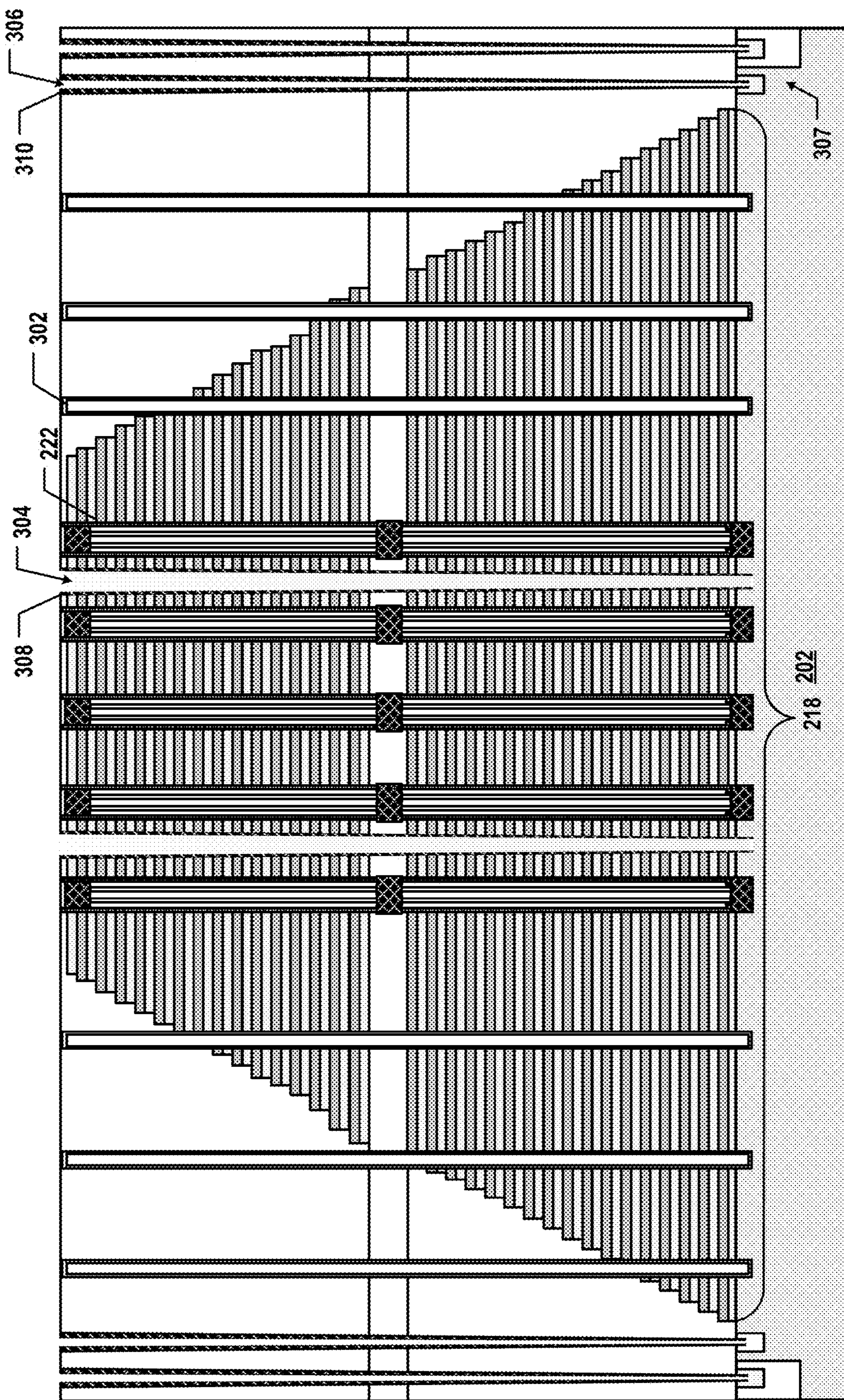

FIG. 3C

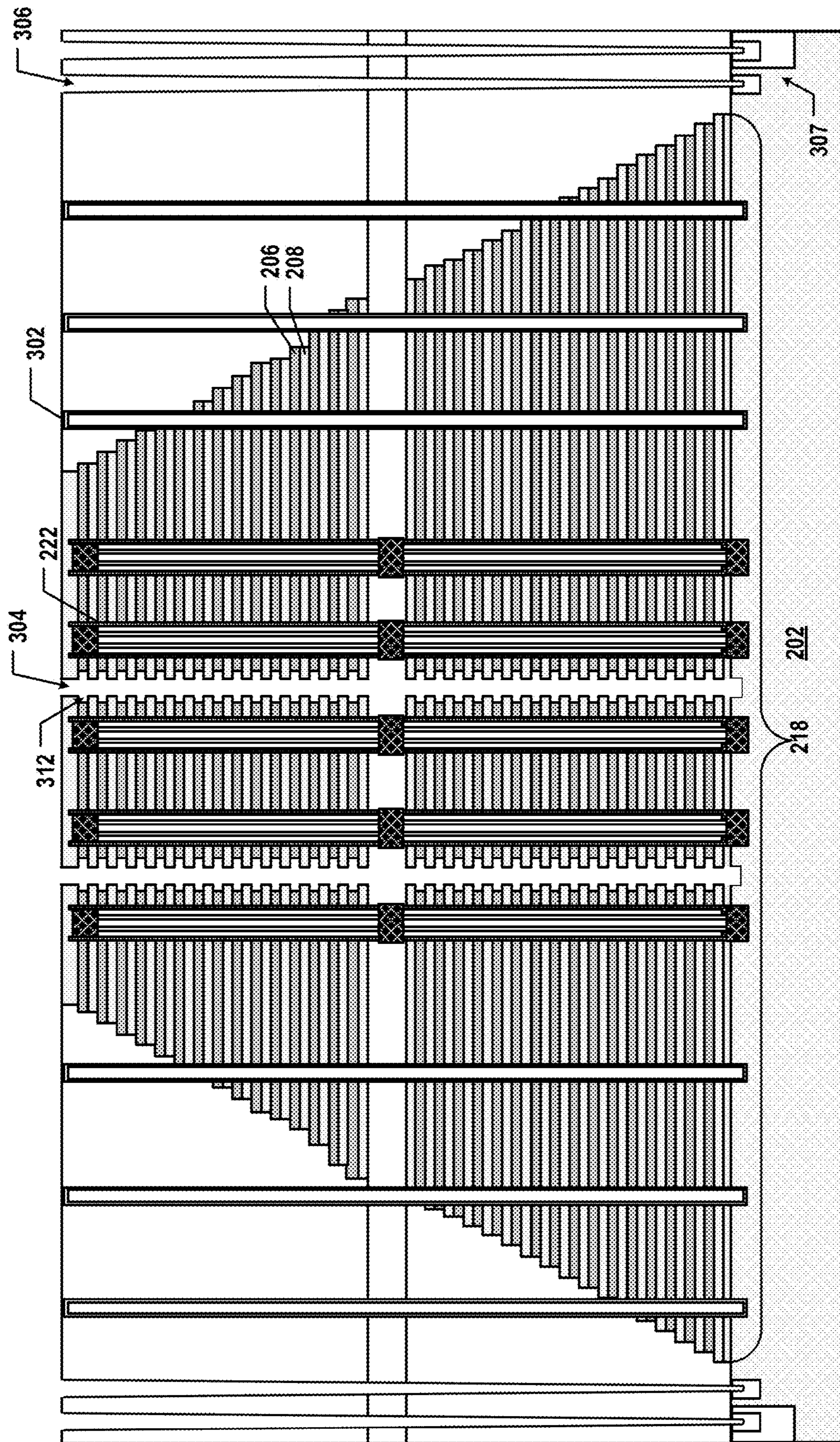

FIG. 3D

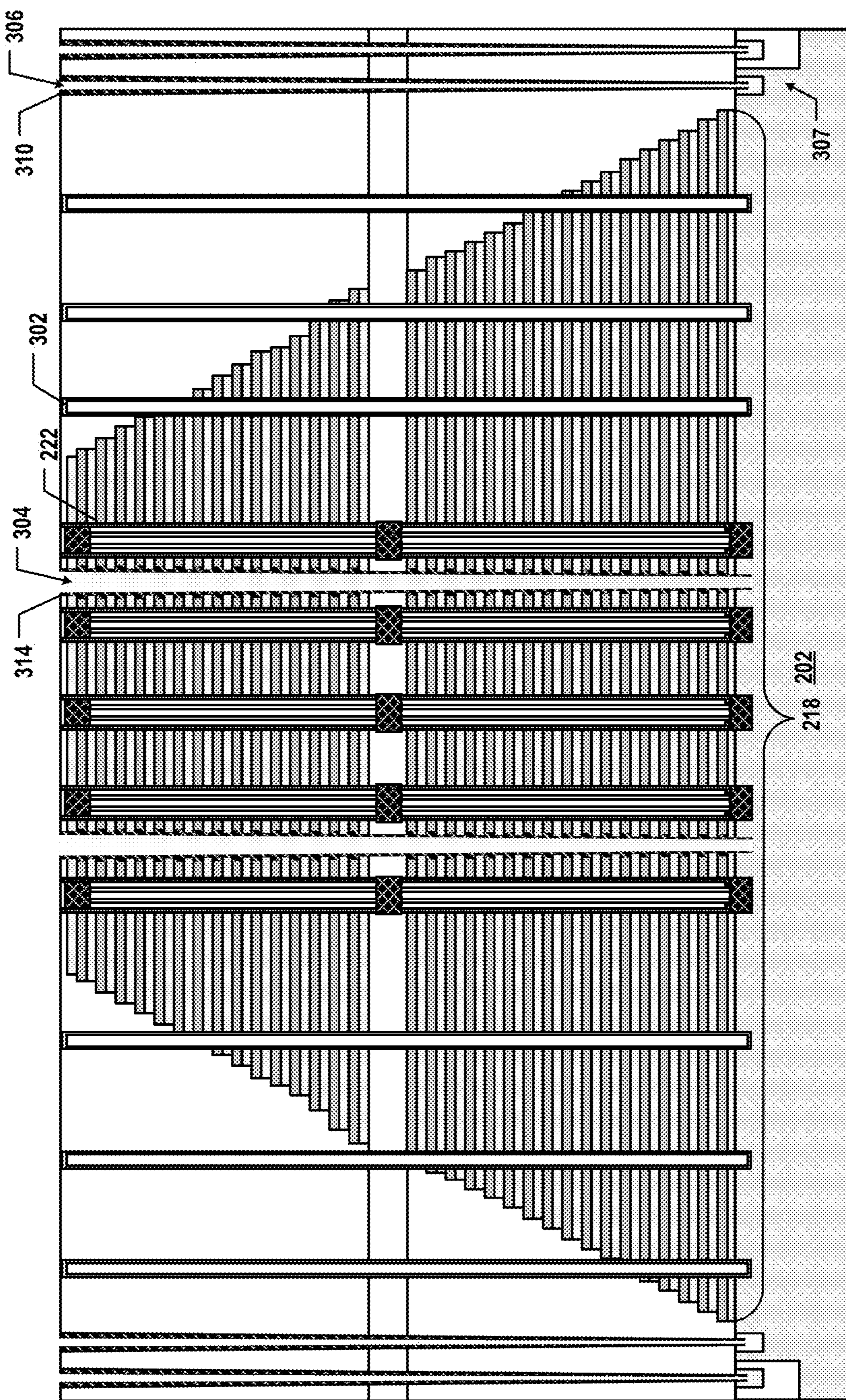

FIG. 3E

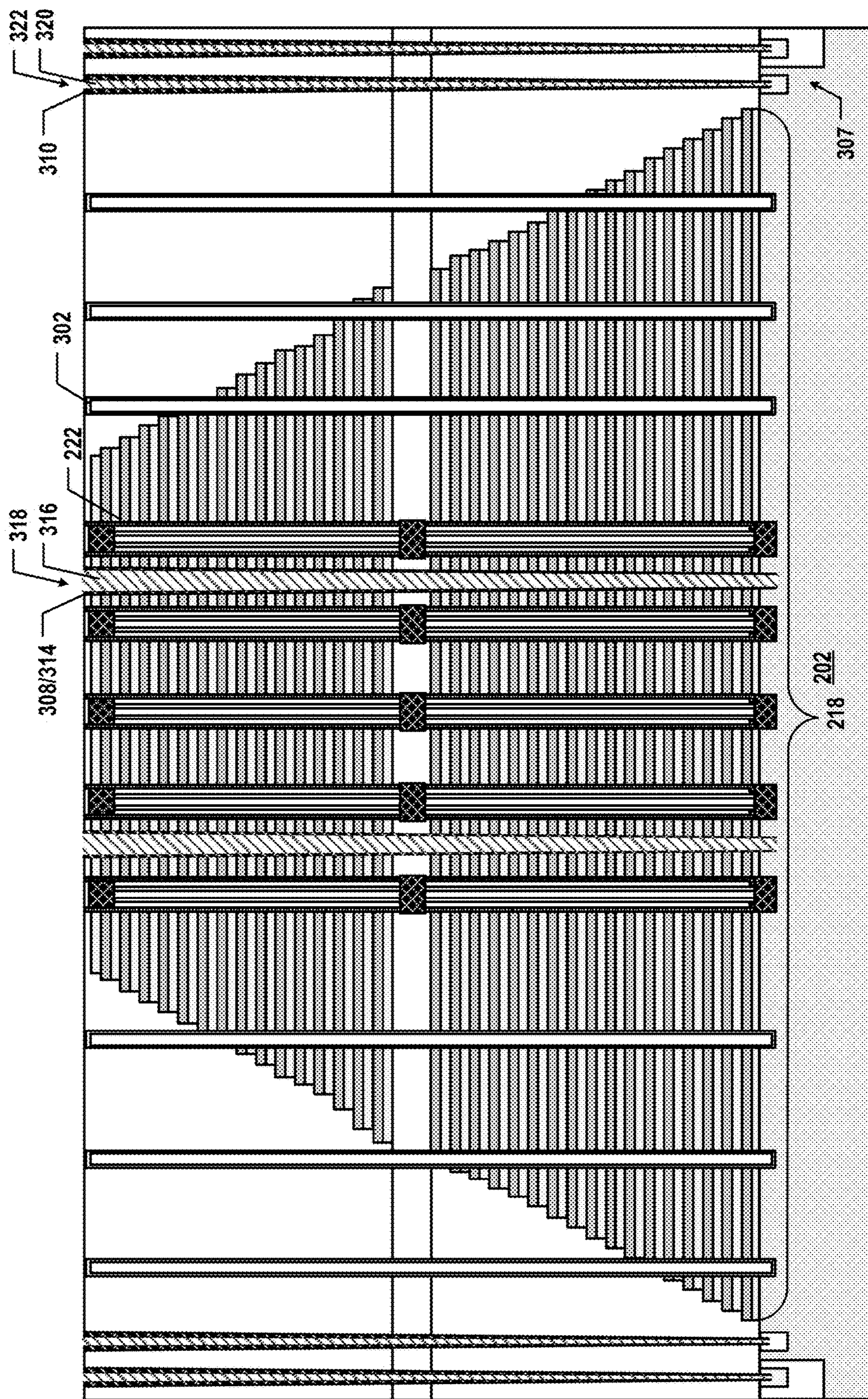

FIG. 3F

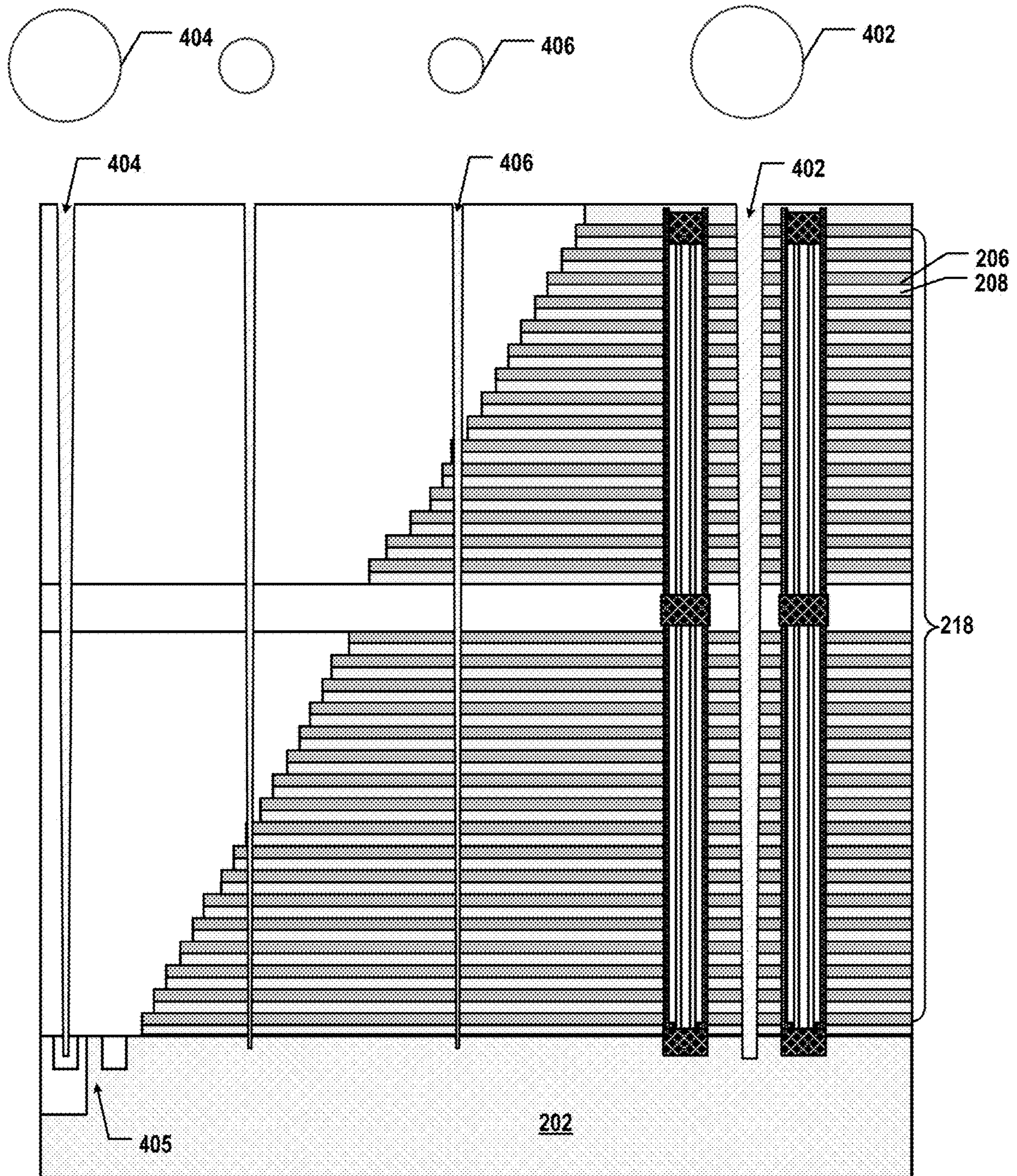

FIG. 4A

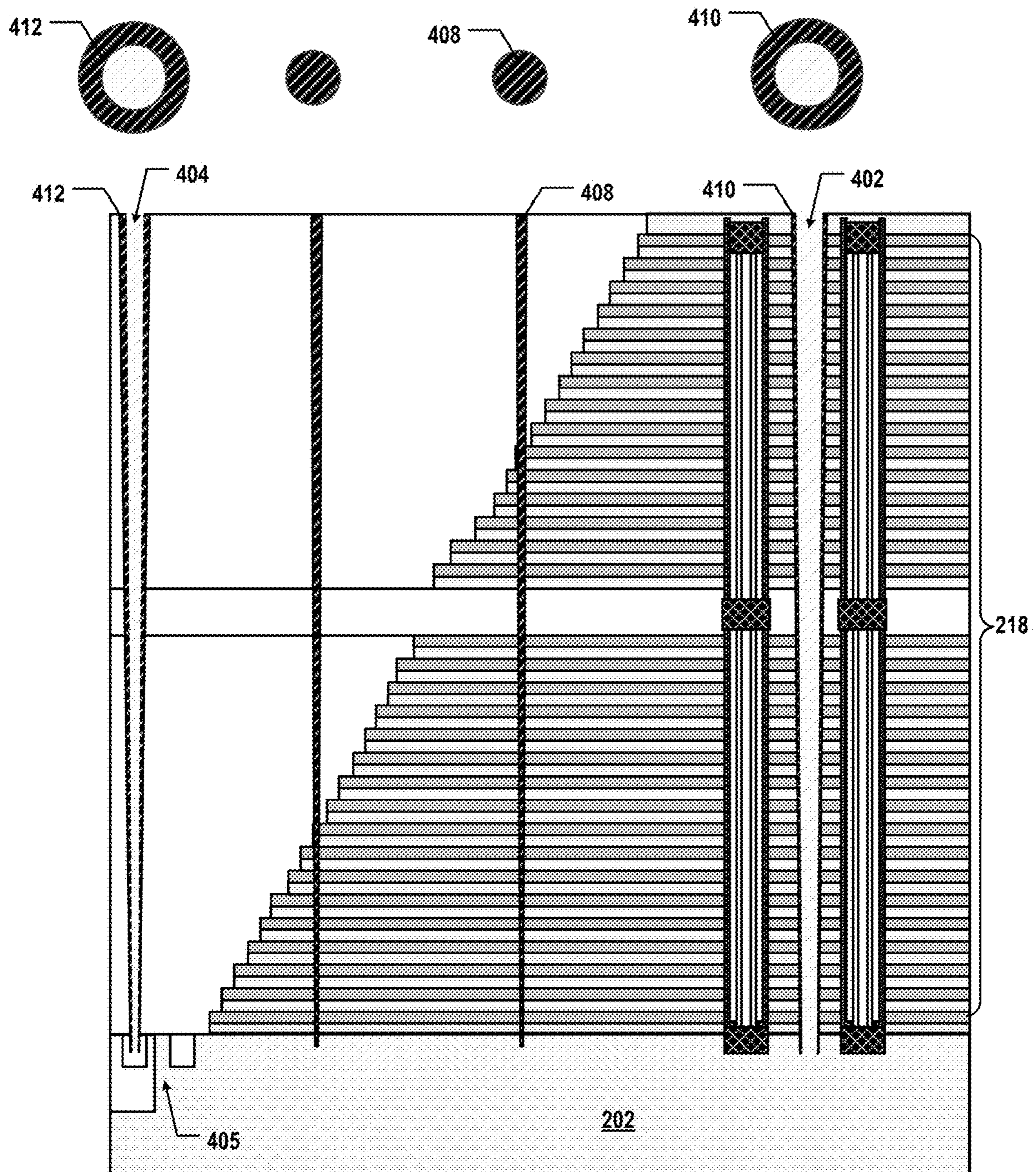

FIG. 4B

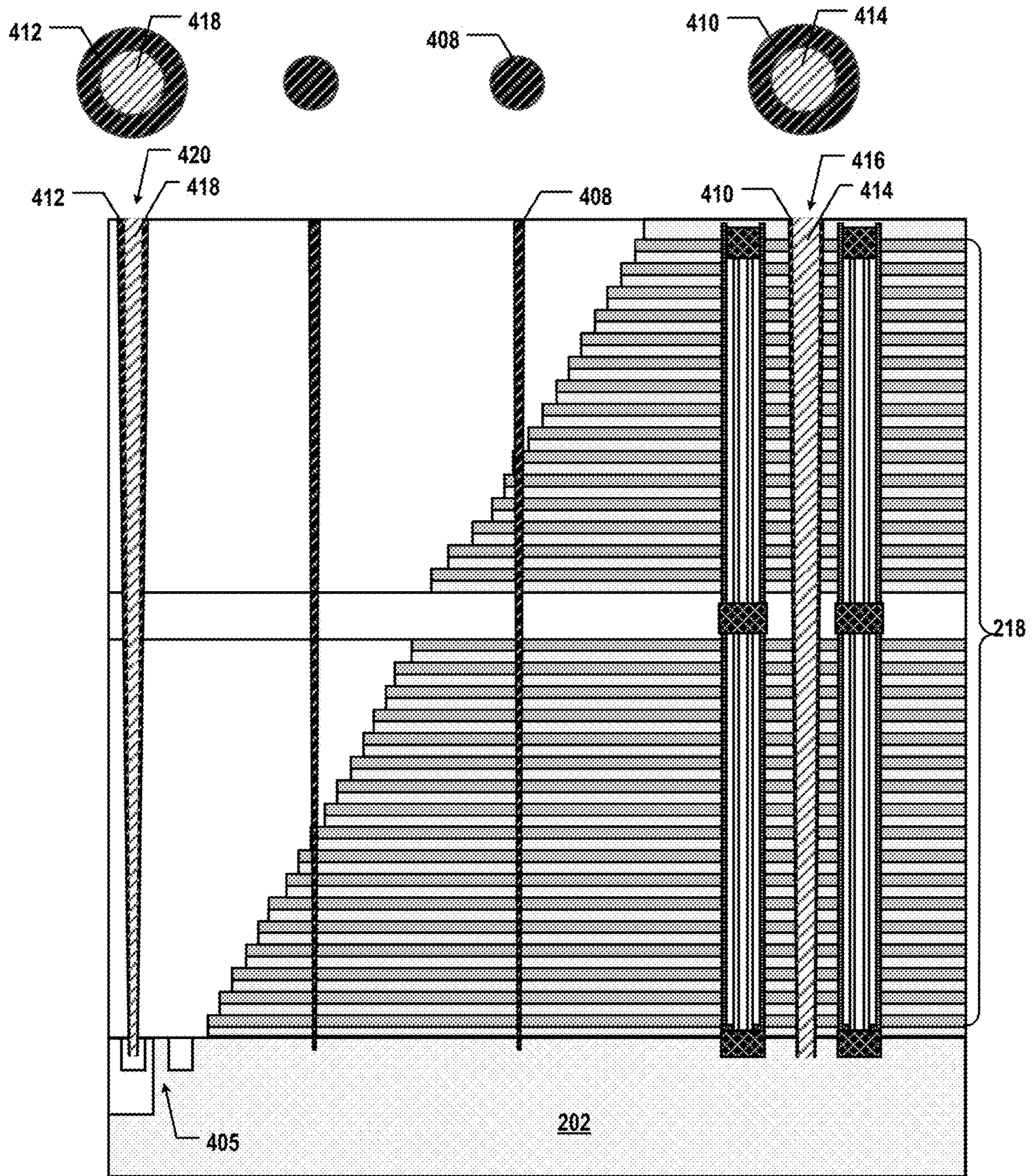

FIG. 4C

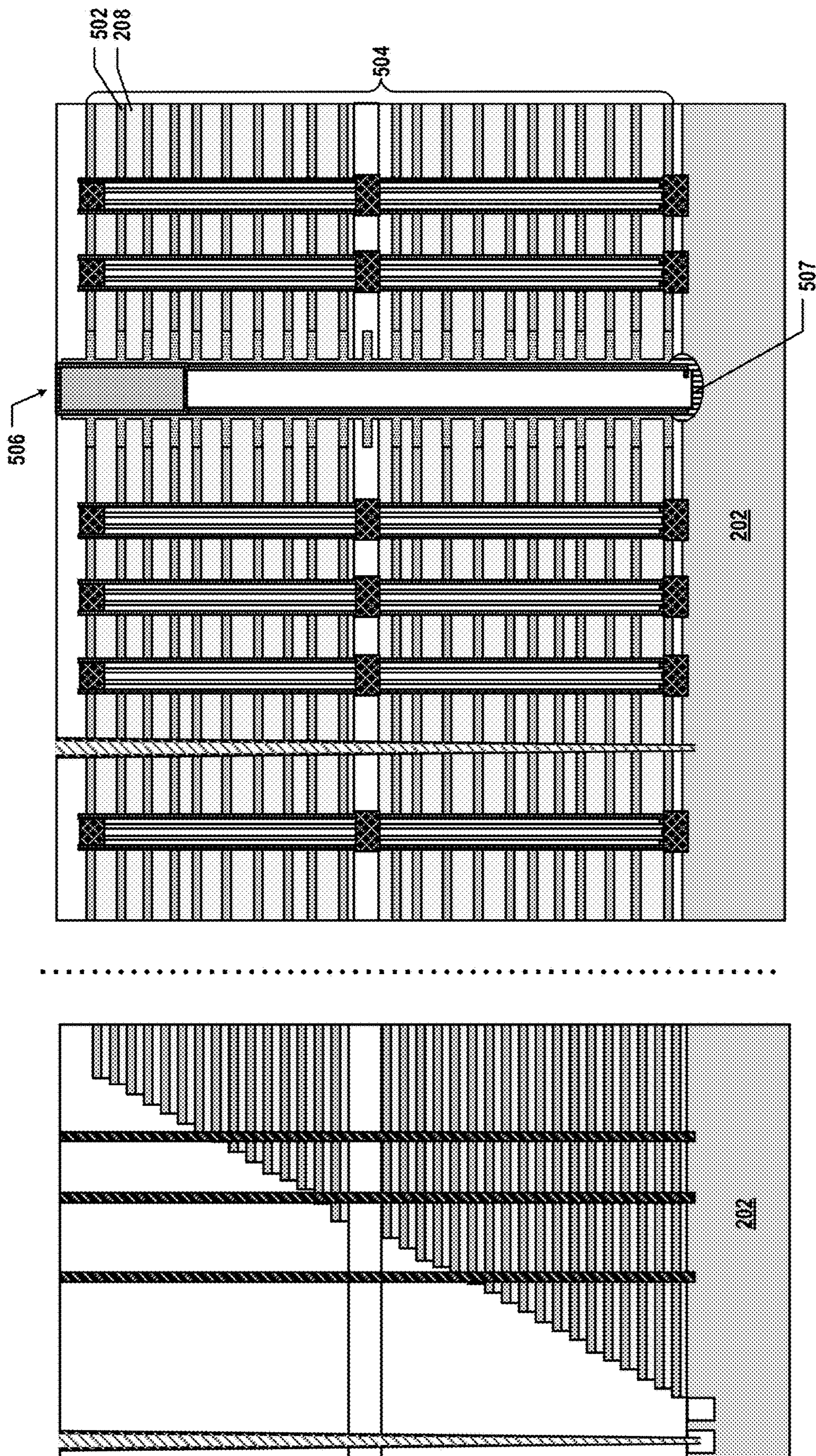

FIG. 5A

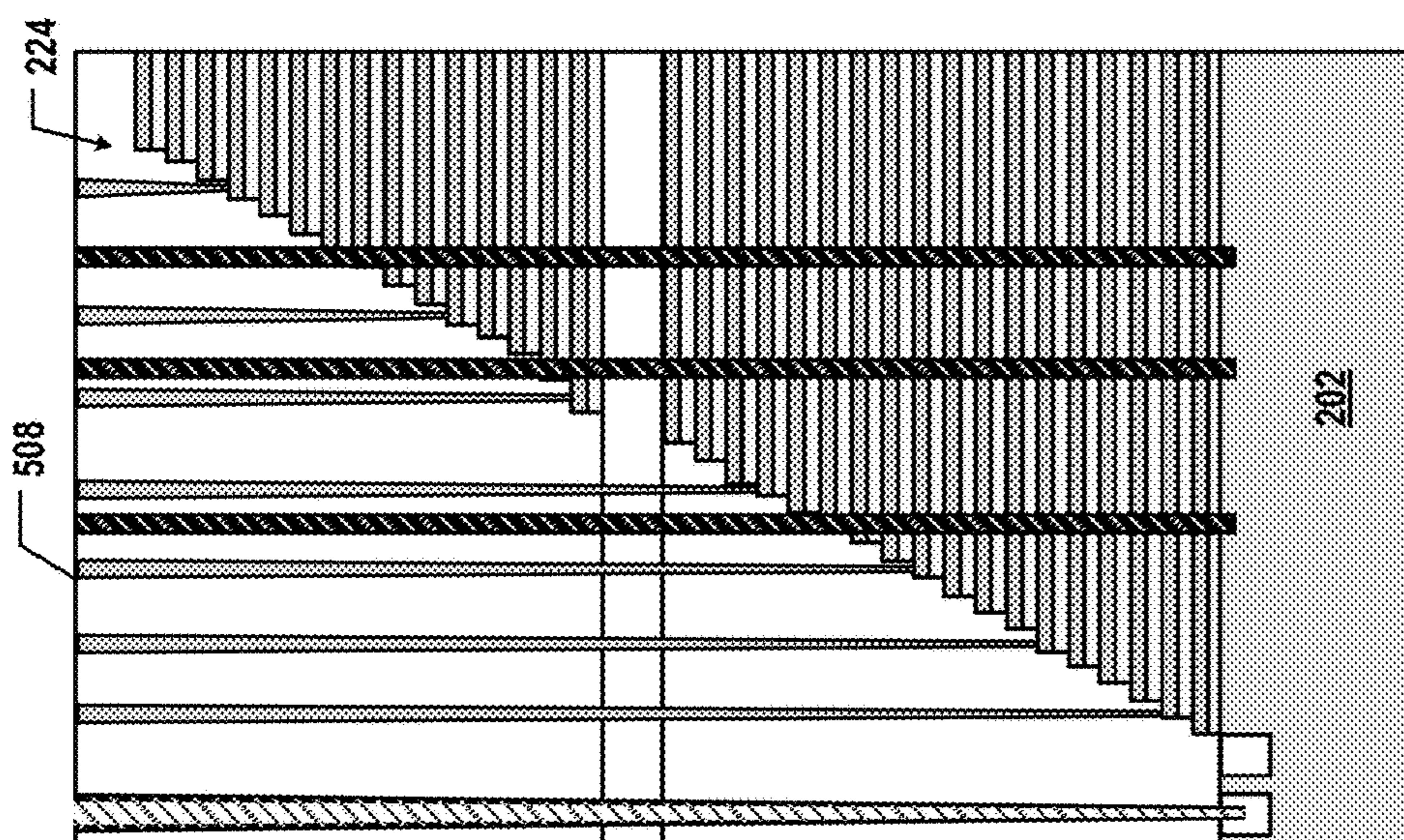
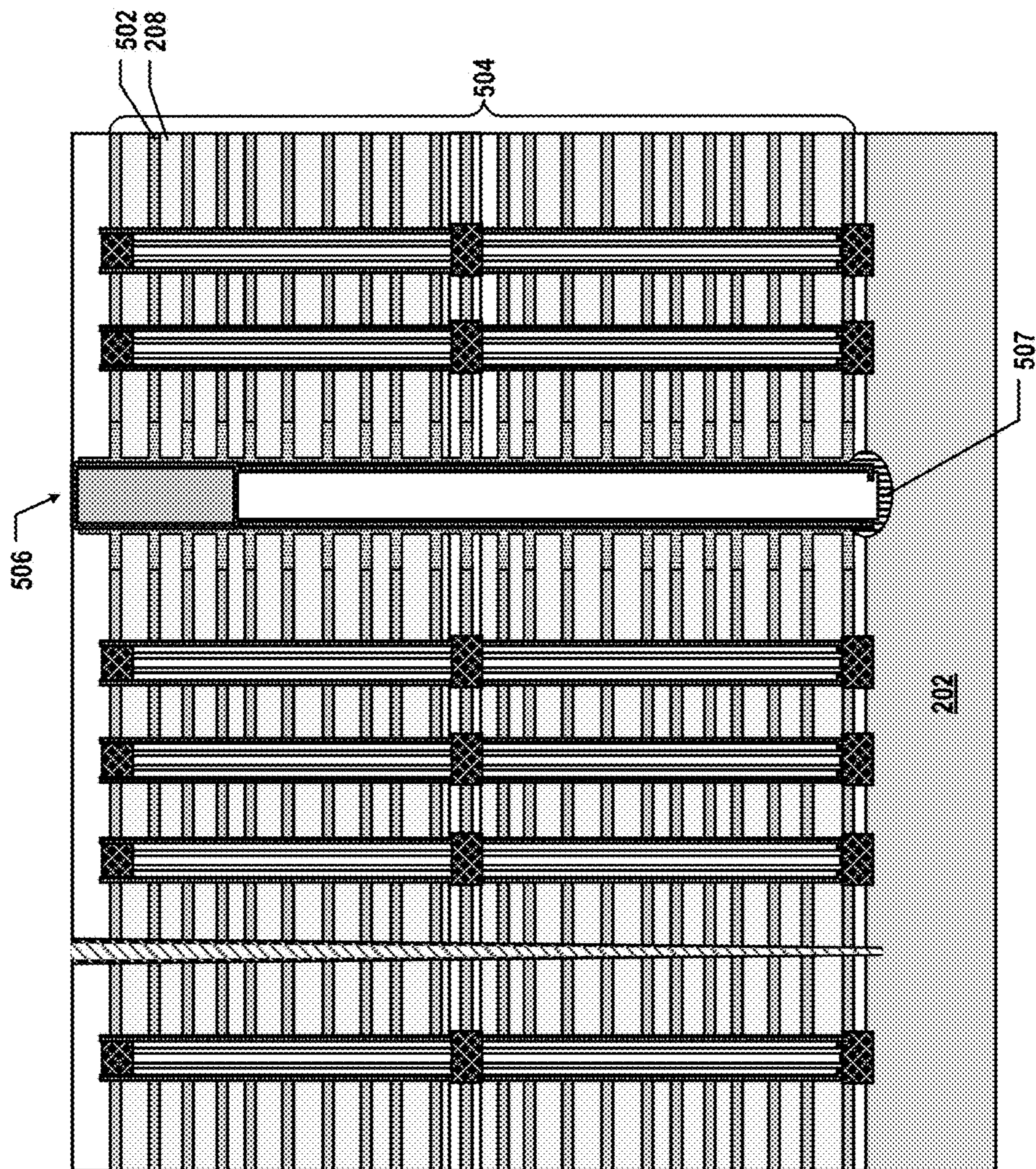

FIG. 5B

600

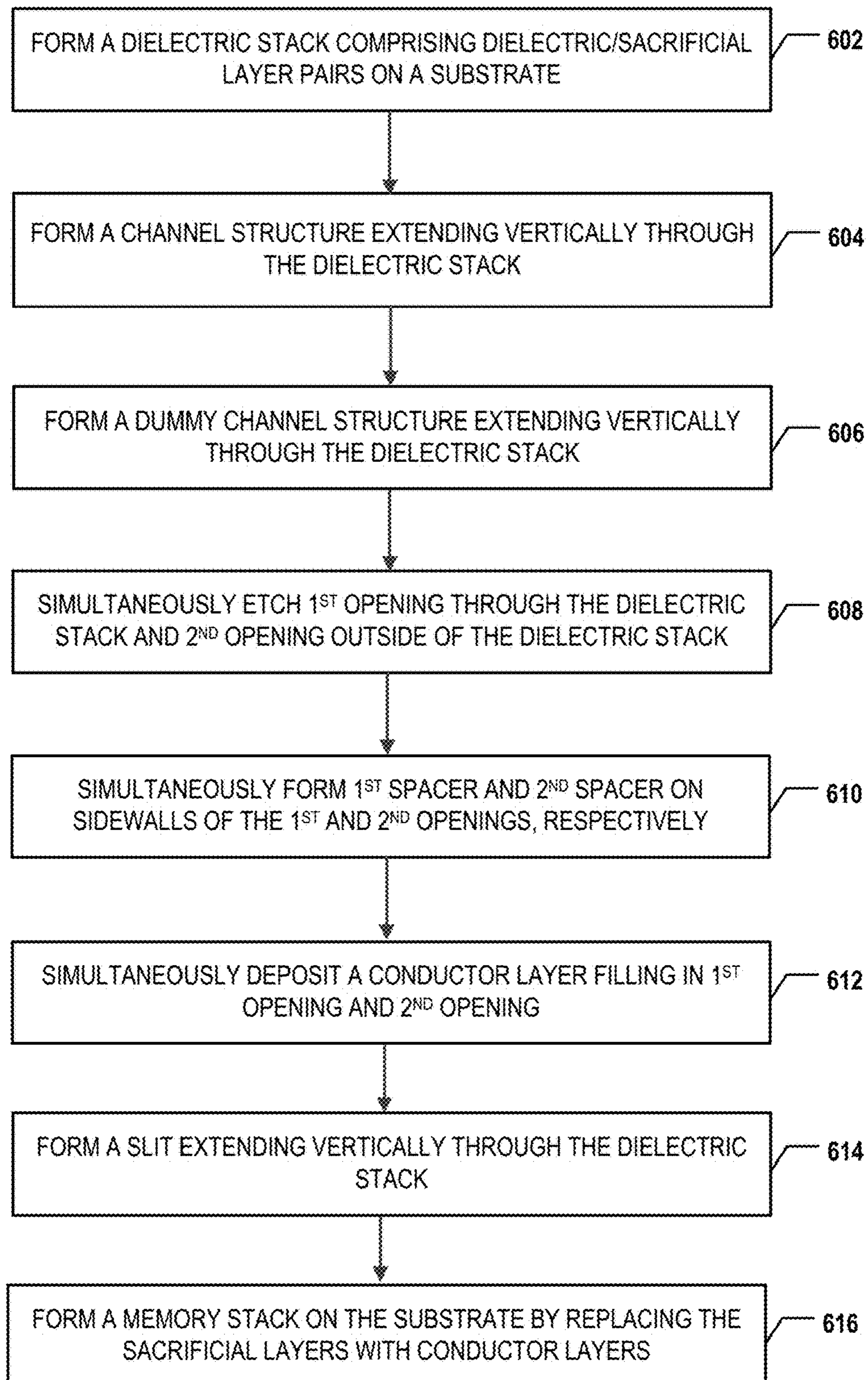

FIG. 6

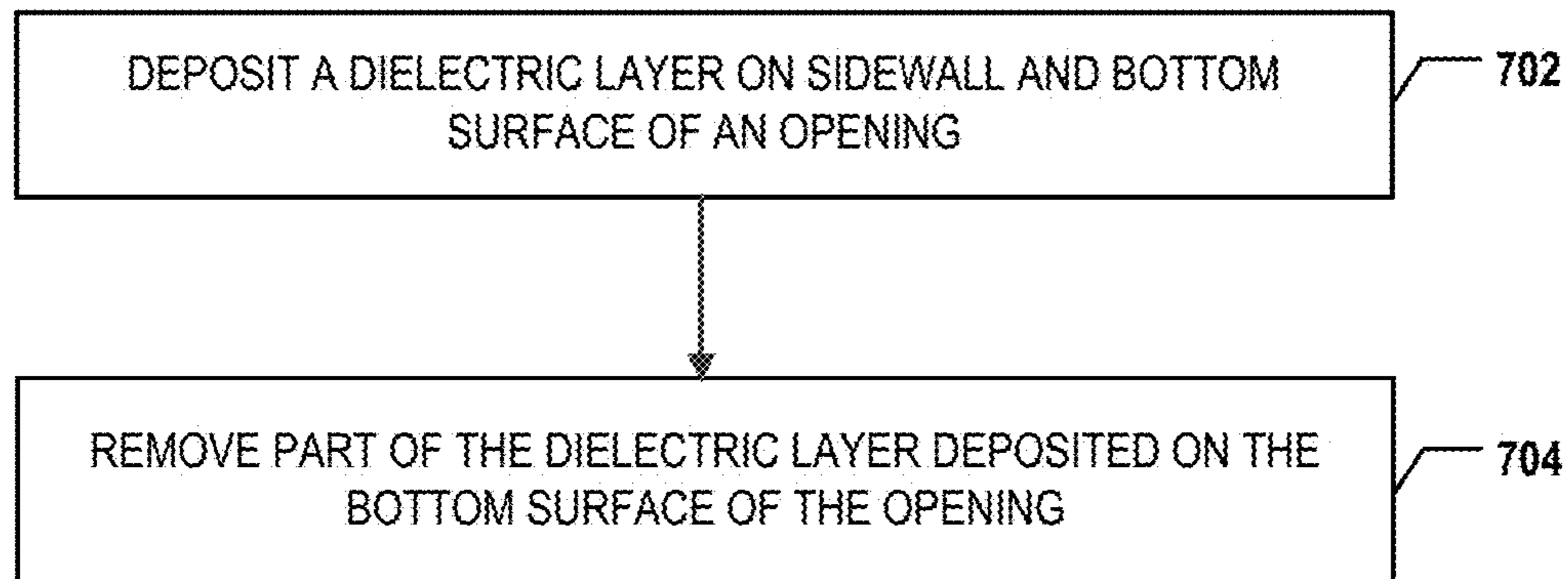

FIG. 7A

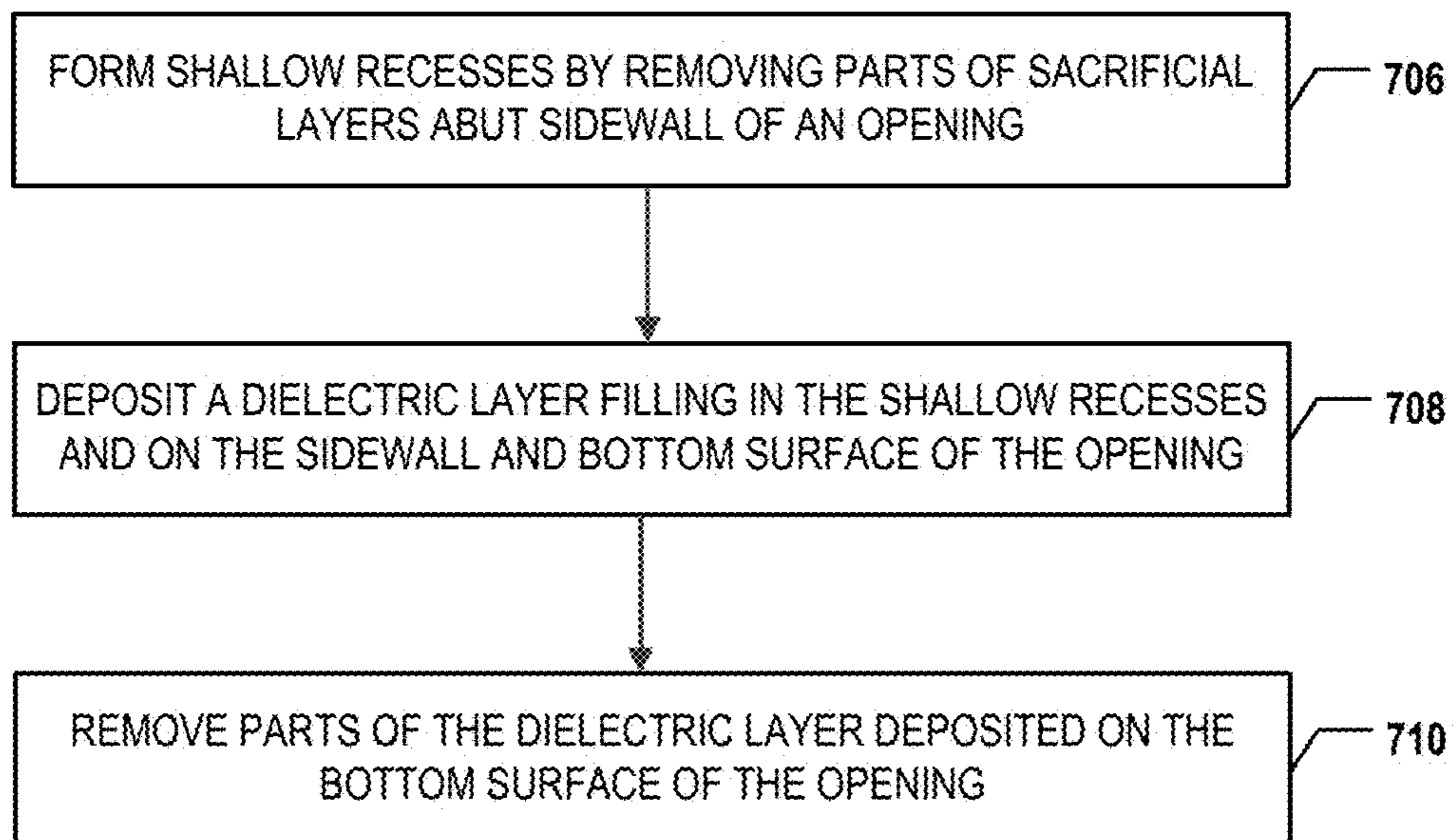

FIG. 7B

800

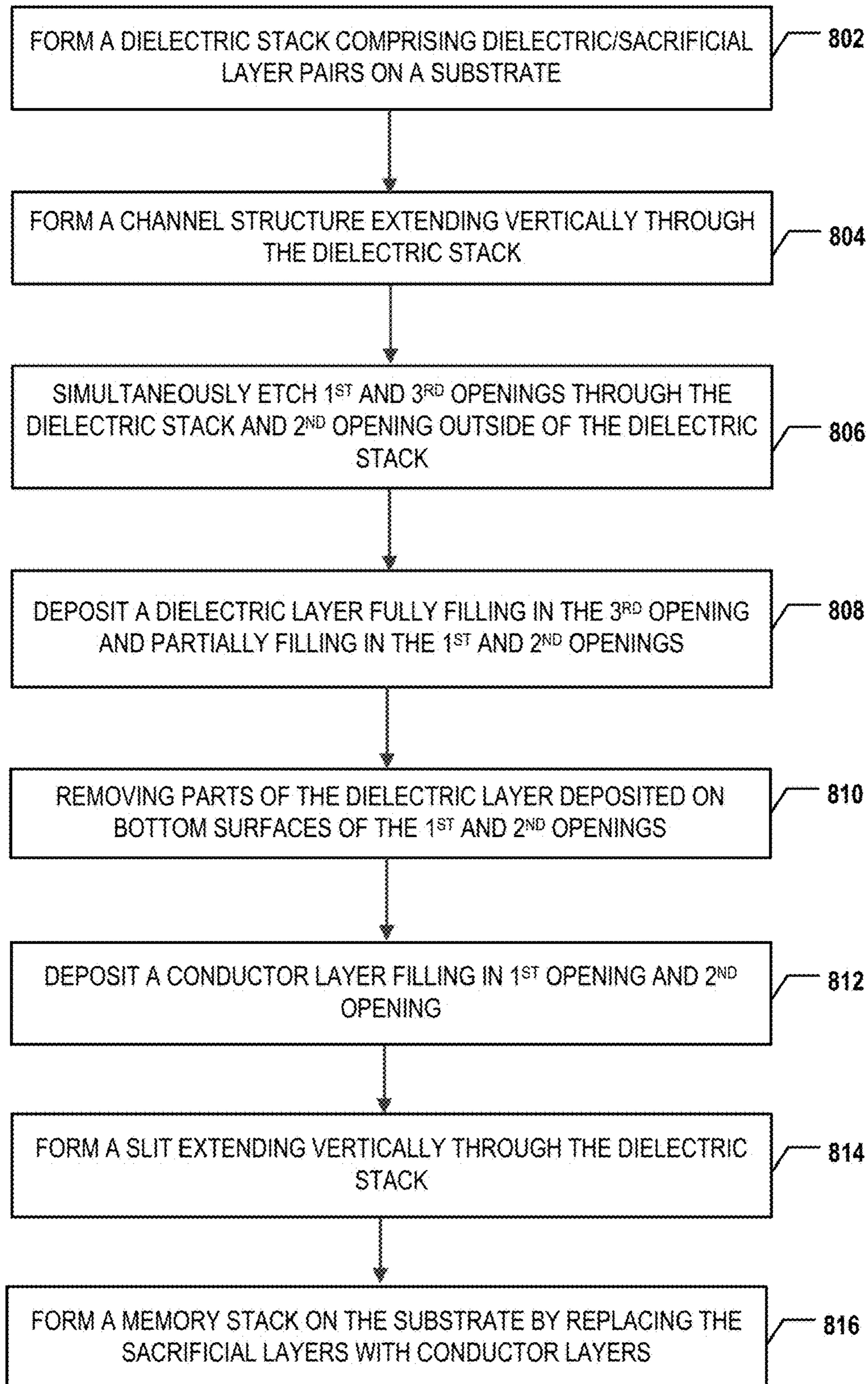

FIG. 8

**THREE-DIMENSIONAL MEMORY DEVICES
HAVING THROUGH ARRAY CONTACTS
AND METHODS FOR FORMING THE SAME**

CROSS REFERENCE TO RELATED
APPLICATION

This application is continuation of International Application No. PCT/CN2018/101482, filed on Aug. 21, 2018, entitled "THREE-DIMENSIONAL MEMORY DEVICES HAVING THROUGH ARRAY CONTACTS AND METHODS FOR FORMING THE SAME," which is hereby incorporated by reference in its entirety.

BACKGROUND

Embodiments of the present disclosure relate to three-dimensional (3D) memory devices and fabrication methods thereof.

Planar memory cells are scaled to smaller sizes by improving process technology, circuit design, programming algorithm, and fabrication process. However, as feature sizes of the memory cells approach a lower limit, planar process and fabrication techniques become challenging and costly. As a result, memory density for planar memory cells approaches an upper limit.

A 3D memory architecture can address the density limitation in planar memory cells. The 3D memory architecture includes a memory array and peripheral devices for controlling signals to and from the memory array.

SUMMARY

Embodiments of 3D memory devices and fabrication methods thereof are disclosed herein.

In one example, a method for forming a 3D memory device is disclosed. A dielectric stack including a plurality of dielectric/sacrificial layer pairs is formed on a substrate. A channel structure extending vertically through the dielectric stack is formed. A first opening extending vertically through the dielectric stack is formed. A spacer is formed on a sidewall of the first opening. A through array contact (TAC) extending vertically through the dielectric stack is formed by depositing a conductor layer in contact with the spacer in the first opening. A slit extending vertically through the dielectric stack is formed after forming the TAC. A memory stack including a plurality of conductor/dielectric layer pairs is formed on the substrate by replacing, through the slit, the sacrificial layers in the dielectric/sacrificial layer pairs with a plurality of conductor layers.

In another example, a method for forming a 3D memory device is disclosed. A dielectric stack including a plurality of dielectric/sacrificial layer pairs is formed on a substrate. A channel structure extending vertically through the dielectric stack is formed. A dummy channel structure extending vertically through the dielectric stack is formed. A first opening through the dielectric stack and a second opening outside of the dielectric stack are simultaneously etched. A first spacer on a sidewall of the first opening and a second spacer on a sidewall of the second opening are simultaneously formed. A conductor layer is deposited (i) filling in the first opening to form a TAC and (ii) filling in the second opening to form a peripheral contact. A slit extending vertically through the dielectric stack is formed after forming the TAC and peripheral device. A memory stack including a plurality of conductor/dielectric layer pairs is formed

on the substrate by replacing, through the slit, the sacrificial layers in the dielectric/sacrificial layer pairs with a plurality of conductor layers.

In still another example, a method for forming a 3D memory device is disclosed. A dielectric stack including a plurality of dielectric/sacrificial layer pairs is formed on a substrate. A channel structure extending vertically through the dielectric stack is formed. A first opening through the dielectric stack, a second opening outside of the dielectric stack, and a third opening through the dielectric stack are simultaneously etched. A lateral dimension of the third opening is smaller than lateral dimensions of the first and second openings. A dielectric layer is deposited (i) fully filling in the third opening to form a dummy channel structure and (ii) partially filling in the first opening and the second opening. Parts of the dielectric layer that are deposited on a bottom surface of the first opening and on a bottom surface of the second opening are removed. A conductor layer is deposited (i) filling in the first opening to form a TAC and (ii) filling in the second opening to form a peripheral contact. A slit extending vertically through the dielectric stack is formed after forming the TAC and peripheral device. A memory stack including a plurality of conductor/dielectric layer pairs is formed on the substrate by replacing, through the slit, the sacrificial layers in the dielectric/sacrificial layer pairs with a plurality of conductor layers.

In a different example, a 3D memory device includes a substrate, a memory stack on the substrate including a plurality of conductor/dielectric layer pairs, a channel structure extending vertically through the conductor/dielectric layer pairs in the memory stack, a TAC extending vertically through the conductor/dielectric layer pairs in the memory stack, and a dummy channel structure fully filled with a dielectric layer and extending vertically through the conductor/dielectric layer pairs in the memory stack.

BRIEF DESCRIPTION OF THE DRAWINGS

The accompanying drawings, which are incorporated herein and form a part of the specification, illustrate embodiments of the present disclosure and, together with the description, further serve to explain the principles of the present disclosure and to enable a person skilled in the pertinent art to make and use the present disclosure.

FIG. 1 illustrates a cross-section of an exemplary 3D memory device, according to some embodiments of the present disclosure.

FIGS. 2A-2E illustrate an exemplary fabrication process for forming channel structures of a 3D memory device, according to some embodiments of the present disclosure.

FIGS. 3A-3F illustrate exemplary fabrication processes for forming TACs, peripheral contacts, and dummy channel structures of a 3D memory device, according to various embodiments of the present disclosure.

FIGS. 4A-4C illustrate another exemplary fabrication process for forming TACs, peripheral contacts, and dummy channel structures of a 3D memory device, according to some embodiments of the present disclosure.

FIGS. 5A-5B illustrate an exemplary fabrication process for forming a slit structure and word line contacts of a 3D memory device, according to some embodiments of the present disclosure.

FIG. 6 is a flowchart of an exemplary method for forming a 3D memory device, according to some embodiments.

FIG. 7A is a flowchart of an exemplary method for forming a spacer on a sidewall of an opening, according to some embodiments of the present disclosure.

FIG. 7B is a flowchart of another exemplary method for forming a spacer on a sidewall of an opening, according to some embodiments of the present disclosure.

FIG. 8 is a flowchart of another exemplary method for forming a 3D memory device, according to some embodiments of the present disclosure.

Embodiments of the present disclosure will be described with reference to the accompanying drawings.

DETAILED DESCRIPTION

Although specific configurations and arrangements are discussed, it should be understood that this is done for illustrative purposes only. A person skilled in the pertinent art will recognize that other configurations and arrangements can be used without departing from the spirit and scope of the present disclosure. It will be apparent to a person skilled in the pertinent art that the present disclosure can also be employed in a variety of other applications.

It is noted that references in the specification to “one embodiment,” “an embodiment,” “an example embodiment,” “some embodiments,” etc., indicate that the embodiment described may include a particular feature, structure, or characteristic, but every embodiment may not necessarily include the particular feature, structure, or characteristic. Moreover, such phrases do not necessarily refer to the same embodiment. Further, when a particular feature, structure or characteristic is described in connection with an embodiment, it would be within the knowledge of a person skilled in the pertinent art to effect such feature, structure or characteristic in connection with other embodiments whether or not explicitly described.

In general, terminology may be understood at least in part from usage in context. For example, the term “one or more” as used herein, depending at least in part upon context, may be used to describe any feature, structure, or characteristic in a singular sense or may be used to describe combinations of features, structures or characteristics in a plural sense. Similarly, terms, such as “a,” “an,” or “the,” again, may be understood to convey a singular usage or to convey a plural usage, depending at least in part upon context. In addition, the term “based on” may be understood as not necessarily intended to convey an exclusive set of factors and may, instead, allow for existence of additional factors not necessarily expressly described, again, depending at least in part on context.

It should be readily understood that the meaning of “on,” “above,” and “over” in the present disclosure should be interpreted in the broadest manner such that “on” not only means “directly on” something but also includes the meaning of “on” something with an intermediate feature or a layer therebetween, and that “above” or “over” not only means the meaning of “above” or “over” something but can also include the meaning it is “above” or “over” something with no intermediate feature or layer therebetween (i.e., directly on something).

Further, spatially relative terms, such as “beneath,” “below,” “lower,” “above,” “upper,” and the like, may be used herein for ease of description to describe one element or feature’s relationship to another element(s) or feature(s) as illustrated in the figures. The spatially relative terms are intended to encompass different orientations of the device in use or operation in addition to the orientation depicted in the figures. The apparatus may be otherwise oriented (rotated 90

degrees or at other orientations) and the spatially relative descriptors used herein may likewise be interpreted accordingly.

As used herein, the term “substrate” refers to a material onto which subsequent material layers are added. The substrate itself can be patterned. Materials added on top of the substrate can be patterned or can remain unpatterned. Furthermore, the substrate can include a wide array of semiconductor materials, such as silicon, germanium, gallium arsenide, indium phosphide, etc. Alternatively, the substrate can be made from an electrically non-conductive material, such as a glass, a plastic, or a sapphire wafer.

As used herein, the term “layer” refers to a material portion including a region with a thickness. A layer can extend over the entirety of an underlying or overlying structure or may have an extent less than the extent of an underlying or overlying structure. Further, a layer can be a region of a homogeneous or inhomogeneous continuous structure that has a thickness less than the thickness of the continuous structure. For example, a layer can be located between any pair of horizontal planes between, or at, a top surface and a bottom surface of the continuous structure. A layer can extend laterally, vertically, and/or along a tapered surface. A substrate can be a layer, can include one or more layers therein, and/or can have one or more layer thereupon, thereabove, and/or therebelow. A layer can include multiple layers. For example, an interconnect layer can include one or more conductor and contact layers (in which interconnect lines and/or via contacts are formed) and one or more dielectric layers.

As used herein, the term “nominal/nominally” refers to a desired, or target, value of a characteristic or parameter for a component or a process operation, set during the design phase of a product or a process, together with a range of values above and/or below the desired value. The range of values can be due to slight variations in manufacturing processes or tolerances. As used herein, the term “about” indicates the value of a given quantity that can vary based on a particular technology node associated with the subject semiconductor device. Based on the particular technology node, the term “about” can indicate a value of a given quantity that varies within, for example, 10-30% of the value (e.g., $\pm 10\%$, $\pm 20\%$, or $\pm 30\%$ of the value).

As used herein, the term “3D memory device” refers to a semiconductor device with vertically oriented strings of memory cell transistors (referred to herein as “memory strings,” such as NAND memory strings) on a laterally-oriented substrate so that the memory strings extend in the vertical direction with respect to the substrate. As used herein, the term “vertical/vertically” means nominally perpendicular to the lateral surface of a substrate.

In some 3D memory devices, interconnects can include through array contacts (TACs) for providing vertical interconnects between the stacked memory array device and peripheral device (e.g., for power bus and metal routing), thereby reducing metal levels and shrinking die size. TACs can be formed within barrier structures, which preserves a dielectric stack region within a memory stack for ease of etching the openings of the TACs. However, the regions enclosed by the barrier structures take up large area in the core array region where memory strings can be formed and also have a negative impact on the resistance of word lines. Moreover, the existing fabrication processes for forming the barrier structures become more challenging for the next-generation 3D memory devices (e.g., having 128 levels or more), which have less process margin.

Various embodiments in accordance with the present disclosure provide a 3D memory device having TACs not enclosed by barrier structures, which resolves the above-noted issues associated with the barrier structures. For example, by removing the barrier structures, the areas for TACs can be reduced while keeping their functions, thereby increasing memory cell density and decreasing process cost. More process margin can also be obtained due to the elimination of etching and alignment steps for making the barrier structures, which enables high process extendibility for both current and future generations of 3D memory devices. Moreover, various embodiments of methods for forming the 3D memory device disclosed herein can allow TACs to be formed in the same fabrication process(es) for making other structures (e.g., peripheral contacts and/or dummy channel structures) and thus, further simplify the fabrication flow and reduce process cost.

FIG. 1 illustrates a cross-section of an exemplary 3D memory device **100**, according to some embodiments of the present disclosure. 3D memory device **100** can include a substrate **102**, which can include silicon (e.g., single crystalline silicon), silicon germanium (SiGe), gallium arsenide (GaAs), germanium (Ge), silicon on insulator (SOI), or any other suitable materials. In some embodiments, substrate **102** is a thinned substrate (e.g., a semiconductor layer), which was thinned from a normal thickness by grinding, wet/dry etching, chemical mechanical polishing (CMP), or any combination thereof.

3D memory device **100** can include a memory stack **104** above substrate **102**. Memory stack **104** can be a stacked storage structure through which memory strings (e.g., NAND memory strings **106**) are formed. In some embodiments, memory stack **104** includes a plurality of conductor/dielectric layer pairs stacked vertically above substrate **102**. Each conductor/dielectric layer pair can include a conductor layer **110** and a dielectric layer **112**. That is, memory stack **104** can include interleaved conductor layers **110** and dielectric layers **112** stacked vertically. As shown in FIG. 1, each NAND memory string **106** extends vertically through interleaved conductor layers **110** and dielectric layers **112** in memory stack **104**. In some embodiments, 3D memory device **100** is a NAND Flash memory device in which memory cells are provided at intersections of NAND memory strings **106** and conductor layers **110** (functioning as word lines) of 3D memory device **100**. The number of conductor/dielectric layer pairs in memory stack **104** (e.g., 32, 64, 96, or 128) can set the number of memory cells in 3D memory device **100**.

Conductor layers **110** can each have the same thickness or have different thicknesses. Similarly, dielectric layers **112** can each have the same thickness or have different thicknesses. Conductor layers **110** can include conductive materials including, but not limited to, tungsten (W), cobalt (Co), copper (Cu), aluminum (Al), polycrystalline silicon (polysilicon), doped silicon, silicides, or any combination thereof. Dielectric layers **112** can include dielectric materials including, but not limited to, silicon oxide, silicon nitride, silicon oxynitride, or any combination thereof. In some embodiments, conductor layers **110** include metals, such as W, and dielectric layers **112** include silicon oxide. It is understood that a silicon oxide film (not shown), such as an in-situ steam generation (ISSG) silicon oxide, is formed between substrate **102** (e.g., a silicon substrate) and memory stack **104**, according to some embodiments.

It is noted that x, y, and z axes are added to FIG. 1 to further illustrate the spatial relationship of the components in 3D memory device **100**. The x-, y-, and z-directions are

perpendicular to one another. Substrate **102** includes two lateral surfaces (e.g., a top surface and a bottom surface) extending laterally in the x-direction and y-direction (the lateral direction) in the x-y plane. As used herein, whether one component (e.g., a layer or a device) is “on,” “above,” or “below” another component (e.g., a layer or a device) of a semiconductor device (e.g., 3D memory device **100**) is determined relative to the substrate (e.g., substrate **102**) of the semiconductor device in the z-direction (the vertical direction) when the substrate is positioned in the lowest plane of the semiconductor device in the z-direction. The same notion for describing spatial relationship is applied throughout the present disclosure.

In some embodiments, 3D memory device **100** is part of a monolithic 3D memory device, in which the components of the monolithic 3D memory device (e.g., memory cells and peripheral devices) are formed on a single substrate (e.g., substrate **102**). Peripheral devices **111**, such as any suitable digital, analog, and/or mixed-signal peripheral circuits used for facilitating the operation of 3D memory device **100**, can be formed on substrate **102** as well, outside of memory stack **104**. Peripheral device **111** can be formed “on” substrate **102**, where the entirety or part of peripheral device **111** is formed in substrate **102** (e.g., below the top surface of substrate **102**) and/or directly on substrate **102**. Peripheral device **111** can include one or more of a page buffer, a decoder (e.g., a row decoder and a column decoder), a sense amplifier, a driver, a charge pump, a current or voltage reference, or any active or passive components of the circuits (e.g., transistors, diodes, resistors, or capacitors). Isolation regions (e.g., shallow trench isolations (STIs)) and doped regions (e.g., source regions and drain regions of the transistors) can be formed in substrate **102** as well, outside of memory stack **104**.

As shown in FIG. 1, memory stack **104** can include an inner region **116** (also known as a “core array region”) and an outer region **118** (also known as a “staircase region”). In some embodiments, inner region **116** is the center region of memory stack **104** where an array of NAND memory strings **106** are formed through the conductor/dielectric layer pairs, and outer region **118** is the remaining region of memory stack **104** surrounding inner region **116** (including the sides and edges) without NAND memory strings **106**.

As shown in FIG. 1, each NAND memory string **106** can include a channel structure **108** extending vertically through the conductor/dielectric layer pairs in inner region **116** of memory stack **104**. Channel structure **108** can include a channel hole filled with semiconductor materials (e.g., forming a semiconductor channel) and dielectric materials (e.g., forming a memory film). In some embodiments, the semiconductor channel includes silicon, such as amorphous silicon, polysilicon, or single crystalline silicon. In some embodiments, the memory film is a composite layer including a tunneling layer, a storage layer (also known as a “charge trap/storage layer”), and a blocking layer. Each NAND memory string **106** can have a cylinder shape (e.g., a pillar shape). The semiconductor channel, tunneling layer, storage layer, and blocking layer are arranged along a direction from the center toward the outer surface of the pillar in this order, according to some embodiments. The tunneling layer can include silicon oxide, silicon oxynitride, or any combination thereof. The storage layer can include silicon nitride, silicon oxynitride, silicon, or any combination thereof. The blocking layer can include silicon oxide, silicon oxynitride, high dielectric constant (high-k) dielectrics, or any combination thereof.

In some embodiments, NAND memory strings **106** include a plurality of control gates (each being part of a word line/conductor layer **110**) for NAND memory strings **106**. Conductor layer **110** in each conductor/dielectric layer pair can function as a control gate for memory cells of NAND memory string **106**. Conductor layer **110** can include multiple control gates for multiple NAND memory strings **106** and can extend laterally as a word line ending in outer region **118** of memory stack **104**.

In some embodiments, NAND memory string **106** includes two plugs **117** and **119** at a respective end in the vertical direction. Each plug **117** or **119** can be in contact with a respective end of channel structure **108**. Plug **117** can include a semiconductor material, such as silicon, that is epitaxially grown from substrate **102**. Plug **117** can function as the channel controlled by a source select gate of NAND memory string **106**. Plug **117** can be at the lower end of NAND memory string **106** and in contact with channel structure **108** (e.g., on the upper end of channel structure **108**). As used herein, the “upper end” of a component (e.g., NAND memory string **106**) is the end farther away from substrate **102** in the z-direction, and the “lower end” of the component (e.g., NAND memory string **106**) is the end closer to substrate **102** in the z-direction when substrate **102** is positioned in the lowest plane of 3D memory device **100**.

Plug **119** can include semiconductor materials (e.g., polysilicon) or conductor materials (e.g., metals). In some embodiments, plug **119** includes an opening filled with titanium/titanium nitride (Ti/TiN as a barrier layer) and tungsten (as a conductor). By covering the upper end of channel structure **108** during the fabrication of 3D memory device **100**, plug **119** can function as an etch stop layer to prevent etching of dielectrics filled in channel structure **108**, such as silicon oxide and silicon nitride. In some embodiments, plug **119** functions as the drain of NAND memory string **106**.

In some embodiments, memory stack **104** includes a lower memory deck **120** disposed on substrate **102** and an upper memory deck **122** disposed above lower memory deck **120**. A joint layer **124** can be disposed vertically between and electrically isolate lower memory deck **120** and upper memory deck **122**. Each of lower and upper memory deck **120** and **122** can have the same or different number of conductor/dielectric layer pairs. Joint layer **124** can include dielectrics, such as silicon oxide. By separating memory stack **104** into lower and upper memory decks **120** and **122**, or even more memory decks in some embodiments, channel structure **108** of NAND memory string **106** can be jointed by multiple channel structures, each of which is separately formed through a respective memory deck, to increase process yield. As shown in FIG. 1, channel structure **108** of NAND memory string **106** includes a lower channel structure **126** extending vertically through lower memory deck **120** and an upper channel structure **128** extending vertically through upper memory deck. In some embodiments, an inter-deck plug **130** is disposed vertically between and in contact with lower channel structure **126** and upper channel structure **128**. Inter-deck plug **130** can include semiconductor materials, such as polysilicon, and joint (e.g., electrically connect) lower and upper channel structures **126** and **128** to form channel structure **108**. That is, NAND memory string **106** can include plug **117**, lower channel structure **126**, inter-deck plug **130**, upper channel structure **128**, and plug **119** from bottom to top in this order.

In some embodiments, 3D memory device **100** further includes slit structures **132**. Each slit structure **132** can extend vertically through the conductor/dielectric layer pairs

in memory stack **104**. Slit structure **132** can also extend laterally (e.g., in the y-direction) to separate memory stack **104** into multiple blocks. Slit structure **132** can include an opening (slit) filled with conductive materials including, but not limited to, tungsten (W), cobalt (Co), copper (Cu), aluminum (Al), silicides, or any combination thereof. Slit structure **132** can further include a spacer having dielectric materials, such as silicon oxide, laterally between the filled conductive materials and memory stack **104** to electrically insulate the filled conductive materials from surrounding conductor layers **110** in memory stack **104**. As a result, slit structures **132** can separate 3D memory device **100** into multiple memory blocks and/or memory fingers.

In some embodiments, slit structure **132** functions as the source contact for NAND memory strings **106** in the same memory block or the same memory finger that share the same array common source. Slit structure **132** can thus be referred to as a “common source contact” of multiple NAND memory strings **106**. In some embodiments, substrate **102** includes a doped region **134** (including p-type or n-type dopants at a desired doping level), and the lower end of slit structure **132** is in contact with doped region **134** of substrate **102**. Slit structure **132** thus can electrically connect to NAND memory strings **106** by doped region **134**.

As shown in FIG. 1, 3D memory device **100** further includes TACs **136** each extending vertically through the conductor/dielectric layer pairs in memory stack **104**. Each TAC **136** can extend vertically through interleaved conductor layers **110** and dielectric layers **112**. In some embodiments, TAC **136** can extend through the entire thickness of memory stack **104**, (e.g., all the conductor/dielectric layer pairs in the vertical direction). In some embodiments, TAC **136** further extends through at least part of substrate **102**. TAC **136** can carry electrical signals from and/or to 3D memory device **100**, such as part of the power bus, with shorten interconnect routing. In some embodiments, TAC **136** can provide electrical connections between 3D memory device **100** and peripheral device **111** and/or between back-end-of-line (BEOL) interconnects (not shown) and peripheral device **111**. TAC **136** can also provide mechanical support to memory stack **104**.

TAC **136** can include a vertical opening through memory stack **104** and that is filled with filling materials. In some embodiments, TAC **136** includes a spacer **138** on a sidewall of the opening and a conductor layer **140** in contact with spacer **138** in the opening. Conductor layer **140** can include conductive materials, including, but not limited to, W, Co, Cu, Al, doped silicon, silicides, or any combination thereof. Spacer **138** can electrically insulate conductor layer **140** of TAC **136** from surrounding conductor layers **110** in memory stack **104**. In some embodiments, TAC **136** has a substantially circular shape in the plan view, and conductor layer **140** and spacer **138** are disposed radially from the center of TAC **136** in this order. Spacer **138** of TAC **136** can include dielectric materials including, but not limited to, silicon oxide, silicon nitride, silicon oxynitride, or any combination thereof.

As shown in FIG. 1, at least on one side in the lateral direction (e.g., in the y-direction), outer region **118** of memory stack **104** can include a staircase structure **142**. In some embodiments, another staircase structure (not shown) is disposed on the opposite side of memory stack **104** in the y-direction. Each “level” of staircase structure **142** can include one or more conductor/dielectric layer pairs, each including conductor layer **110** and dielectric layer **112**. The top layer in each level of staircase structure **142** can be conductor layer **110** for interconnection in the vertical

direction. In some embodiments, each two adjacent levels of staircase structure **142** are offset by a nominally same distance in the vertical direction and a nominally same distance in the lateral direction. For each two adjacent levels of staircase structure **142**, the first level (and conductor layer and dielectric layer therein) that is closer to substrate **102** can extend laterally further than the second level (and conductor layer and dielectric layer therein), thereby forming a “landing area” on the first level for interconnection in the vertical direction.

Staircase structure **142** can be used for landing word line contacts **144** and/or for balancing load in certain processes during fabrication (e.g., etching and chemical mechanical polishing (CMP)) by dummy channel structures **146** there-through. The lower end of each word line contact **144** can be in contact with top conductor layer **110** (word line) in a respective level of staircase structure **142** to individually address a corresponding word line of 3D memory device **100**. Word line contact **144** can include an opening (e.g., a via hole or a trench) extending vertical through one or more dielectric layers and filled with conductive materials including, but not limited to, W, Co, Cu, Al, silicides, or any combination thereof.

Dummy channel structure **146** can extend vertically through memory stack **104** and have a vertical opening filled with the same materials as those in channel structure **108**. Different from channel structures **108**, a contact is not formed on dummy channel structure **146** to provide electrical connections with other components of 3D memory device **100**, according to some embodiments. In some embodiments, dummy channel structure **146** is fully filled with dielectric materials including, but not limited to, silicon oxide, silicon nitride, silicon oxynitride, or any combination thereof. Thus, dummy channel structures **146** cannot be used for forming memory cells in 3D memory device **100**. Instead, dummy channel structures **146** can provide mechanical support to the memory array structures, e.g., memory stack **104**. Although dummy channel structures **146** are disposed in outer region **118** of memory stack **104** as shown in FIG. **1**, it is understood that dummy channel structures **146** can be formed in inner region **116** of memory stack **104** as well. In some embodiments, dummy channel structure **146** is fully filled with a dielectric layer, such as a silicon oxide layer, and extends vertically through the conductor/dielectric layer pairs in memory stack **104**, either in inner region **116** or in outer region **118**.

As shown in FIG. **1**, 3D memory device **100** can further include peripheral contacts **148** extending vertically through one or more dielectric layers and in contact with peripheral devices **111** outside of memory stack **104**. Peripheral contact **148** can provide electrical connections with peripheral devices **111**. Peripheral contact **148** can include a vertical opening filled with filling materials. In some embodiments, similar to TAC **136**, peripheral contact **148** includes a spacer **150** on a sidewall of the opening and a conductor layer **152** in contact with spacer **150** in the opening. Conductor layer **152** can include conductive materials, including, but not limited to, W, Co, Cu, Al, doped silicon, silicides, or any combination thereof. In some embodiments, peripheral contact **148** has a substantially circular shape in the plan view, and conductor layer **152** and spacer **150** are disposed radially from the center of peripheral contact **148** in this order. Spacer **150** of peripheral contact **148** can include dielectric materials including, but not limited to, silicon oxide, silicon nitride, silicon oxynitride, or any combination thereof. In some embodiments, spacer **150** of peripheral contact **148** and spacer **138** of TAC **136** have nominally the same

thickness in the lateral direction (e.g., radial direction). In some embodiments, both spacer **150** of peripheral contact **148** and spacer **138** of TAC **136** include silicon oxide.

It is understood that 3D memory device **100** can include additional components and structures not shown in FIG. **1** including, but not limited to, other local contacts and interconnects in one or more BEOL interconnect layers above memory stack **104** and/or below substrate **102**.

FIGS. **2A-2E** illustrate an exemplary fabrication process for forming channel structures of a 3D memory device, according to some embodiments of the present disclosure. FIGS. **3A-3F** illustrate exemplary fabrication processes for forming TACs, peripheral contacts, and dummy channel structures of a 3D memory device, according to various embodiments of the present disclosure. FIGS. **4A-4C** illustrate another exemplary fabrication process for forming TACs, peripheral contacts, and dummy channel structures of a 3D memory device, according to some embodiments of the present disclosure. FIGS. **5A-5B** illustrate an exemplary fabrication process for forming a slit structure and word line contacts of a 3D memory device, according to some embodiments of the present disclosure. FIG. **6** is a flowchart of an exemplary method **600** for forming a 3D memory device, according to some embodiments. FIG. **8** is a flowchart of another exemplary method **800** for forming a 3D memory device, according to some embodiments of the present disclosure. Examples of the 3D memory device depicted in FIGS. **2-6** and **8** include 3D memory device **100** depicted in FIG. **1**. FIGS. **2-6** and **8** will be described together. It is understood that the operations shown in methods **600** and **800** are not exhaustive and that other operations can be performed as well before, after, or between any of the illustrated operations. Further, some of the operations may be performed simultaneously, or in a different order than shown in FIGS. **6** and **8**.

Referring to FIG. **6**, method **600** starts at operation **602**, in which a dielectric stack including a plurality of dielectric/sacrificial layer pairs is formed on a substrate. The substrate can be a silicon substrate. In some embodiments, a lower dielectric deck is formed first, followed by the formation of a joint layer. An upper dielectric deck can then be formed on the joint layer to form the dielectric stack. Method **600** proceeds to operation **604**, as illustrated in FIG. **6**, in which a channel structure extending vertically through the dielectric stack is formed. In some embodiments, a lower channel structure extending vertically through the lower dielectric deck is formed. An inter-deck plug can then be formed on the lower channel structure in the joint layer. Once the upper dielectric deck is formed, an upper channel structure extending vertically through the upper dielectric deck can be formed and jointed with the lower channel structure by the inter-deck plug, thereby forming the channel structure. In some embodiments, a staircase structure is formed at one side of the dielectric stack.

As illustrated in FIG. **2A**, a lower dielectric deck **204** including a plurality of dielectric/sacrificial layer pairs is formed on a silicon substrate **202**. In some embodiments, sacrificial layers **206** and dielectric layers **208** are alternately deposited by one or more thin film deposition processes including, but not limited to, physical vapor deposition (PVD), chemical vapor deposition (CVD), atomic layer deposition (ALD), or any combination thereof. In some embodiments, sacrificial layers **206** include silicon nitride, and dielectric layers **208** include silicon oxide. It is understood that the sequence of depositing sacrificial layers **206** and dielectric layers **208** is not limited. The deposition can

start with sacrificial layer **206** or dielectric layer **208** and can end with sacrificial layer **206** or dielectric layer **208**.

As illustrated in FIG. 2B, an array of lower channel structures **210** are formed, each of which extends vertically through interleaved sacrificial layers **206** and dielectric layers **208** in lower dielectric deck **204**. In some embodiments, fabrication processes to form lower channel structure **210** include forming a channel hole through interleaved sacrificial layers **206** and dielectric layers **208** in lower dielectric deck **204** using dry etching/and or wet etching, such as deep reactive-ion etching (DRIE), followed by filling the channel hole with a plurality of layers, such as a dielectric layer and a semiconductor layer, using thin film deposition processes. In some embodiments, the dielectric layer is a composite dielectric layer, such as a combination of multiple dielectric layers including, but not limited to, a tunneling layer, a storage layer, and a blocking layer. The tunneling layer can include dielectric materials including, but not limited to, silicon oxide, silicon nitride, silicon oxynitride, or any combination thereof. The storage layer can include materials for storing charge for memory operation. The storage layer materials can include, but not limited to, silicon nitride, silicon oxynitride, a combination of silicon oxide and silicon nitride, or any combination thereof. The blocking layer can include dielectric materials including, but not limited to, silicon oxide or a combination of silicon oxide/silicon oxynitride/silicon oxide (ONO). The blocking layer can further include a high-k dielectric layer, such as an aluminum oxide (Al_2O_3) layer. The semiconductor layer can include polysilicon, serving as a semiconductor channel. The semiconductor layer and dielectric layer can be formed by processes such as ALD, CVD, PVD, or any combination thereof.

As illustrated in FIG. 2B, a joint layer **212** is formed on lower dielectric deck **204** by depositing a dielectric layer, such as a silicon oxide layer, using thin film deposition processes, such as ALD, CVD, PVD, or any combination thereof. An array of inter-deck plugs **214** are formed in joint layer **212** and in contact with array of lower channel structures **210**, respectively. Inter-deck plugs **214** can be formed by patterning and etching openings through joint layer **212**, followed by deposition of semiconductor materials, such as polysilicon, using thin film deposition processes, such as ALD, CVD, PVD, or any combination thereof.

As illustrated in FIG. 2C, an upper dielectric deck **216** is formed on joint layer **212** and above lower dielectric deck **204**. A dielectric stack **218** including lower dielectric deck **204** and upper dielectric deck **216** can thus be formed. The same fabrication processes for forming lower dielectric deck **204** can be used for forming upper dielectric deck **216** and thus, are not repeated again.

As illustrated in FIG. 2D, an array of upper channel structures **220** each extending vertically through upper dielectric deck **216** are formed and in contact with array of inter-deck plugs **214**, respectively. An array of channel structures **222** each including lower channel structure **210** and upper channel structure **220** that are electrically connected by inter-deck plug **214** are thus formed. The same fabrication processes for forming lower channel structures **210** can be used for forming upper channel structures **220** and thus, are not repeated.

As illustrated in FIG. 2E, staircase structures **224** are formed on the sides of dielectric stack **218**. Staircase structure **224** can be formed by the so-called "trim-etch" processes, which, in each cycle, trim (e.g., etching incrementally and inwardly, often from all directions) a patterned

photoresist layer, followed by etching the exposed portions of the dielectric/sacrificial layer pair using the trimmed photoresist layer as an etch mask to form one step of staircase structure **224**.

Method **600** proceeds to operation **606**, as illustrated in FIG. 6, in which a dummy channel structure extending vertically through the dielectric stack is formed. As illustrated in FIG. 3A, an array of dummy channel structures **302** are formed through dielectric layer **218**. Dummy channel structure **302** can be formed by first etching an opening through dielectric stack **218** and/or one or more dielectric layers using wet etching and/or dry etching, such as DRIE. In some embodiments, the opening is then fully filled with a dielectric layer, such as a silicon oxide layer, using one or more thin film deposition processes, such as ALD, CVD, PVD, or any combination thereof. In some embodiments, dummy channel structures **302** are formed simultaneously with channel structures **222** in the same fabrication steps, such that the opening of each dummy channel structure **302** is filled with at least some of the materials filling in channel structures **222**.

Method **600** proceeds to operation **608**, as illustrated in FIG. 6, in which a first opening through the dielectric stack and a second opening outside of the dielectric stack are simultaneously etched. As illustrated in FIG. 3B, first openings (TAC holes) **304** each extending vertically through the dielectric/sacrificial layer pairs in dielectric stack **218** are formed by wet etching and/or drying etching of interleaved dielectric layers **208** and sacrificial layers **206** (e.g., silicon nitride and silicon oxide). In some embodiments, TAC holes **304** are etched using DRIE. Second openings (peripheral contact holes) **306** can be simultaneously formed by the same wet etching and/or drying etching process, such as DRIE, to etch through one or more dielectric layers (e.g., silicon oxide and/or silicon nitride) outside of dielectric stack **218**. The depths of TAC hole **304** and peripheral contact hole **306** in the vertical direction can be nominally the same. The lateral dimensions of TAC hole **304** and peripheral contact hole **306**, such as the diameters, can be nominally the same or different in various embodiments. For example, the diameter of TAC hole **304** is greater than the diameter of peripheral contact hole **306**, according to some embodiments.

As shown in FIG. 3B, TAC hole **304** and peripheral contact hole **306** can reach to silicon substrate **202**, and the lower end of peripheral contact hole **306** can be in contact with a peripheral device **307** formed on silicon substrate **202**. In some embodiments, peripheral device **307** includes transistors, which can be formed by a plurality of processes including, but not limited to, photolithography, dry/wet etch, thin film deposition, thermal growth, implantation, CMP, and any other suitable processes. In some embodiments, doped regions are formed in silicon substrate **202** by ion implantation and/or thermal diffusion, which function, for example, as source regions and/or drain regions of the transistors. In some embodiments, isolation regions (e.g., STIs) are also formed in silicon substrate **202** by wet etching and/or dry etching and thin film deposition processes. The fabrication process for forming peripheral device **307** can occur at any fabrication stage prior to the etching of peripheral contact hole **306**.

Method **600** proceeds to operation **610**, as illustrated in FIG. 6, in which a first spacer and a second spacer are simultaneously formed on sidewalls of the first opening and the second opening, respectively. FIG. 7A is a flowchart of an exemplary method for forming a spacer on a sidewall of an opening, according to some embodiments. Referring to

FIG. 7A, at operation 702, to form the first spacer, a dielectric layer is deposited on the sidewall and bottom surface of the first opening. At operation 704, part of the dielectric layer that is deposited on the bottom surface of the first opening is removed. The deposition of the dielectric layer can include ALD, and the removal of the part of the dielectric layer can include anisotropic etching on the bottom surface of the first opening.

As illustrated in FIG. 3C, a first spacer 308 is formed on the sidewall, but not the bottom surface, of TAC hole 304. A dielectric layer can be first deposited into TAC hole 304 using one or more thin film deposition processes, such as ALD, CVD, PVD, or any combination thereof, which covers the sidewall and bottom surface of TAC hole 304. The part of the dielectric layer deposited on the bottom surface, but not on the sidewall, of TAC hole 304 can then be etched through using "bottom punch" processes. In some embodiments, a silicon oxide layer can be deposited on the sidewall and bottom surface of TAC hole 304 using ALD, and the part of the silicon oxide layer deposited on the bottom surface of TAC hole 304 can be removed using any suitable anisotropic etching directed to the bottom surface of TAC hole 304. In one example, a bias with a sufficient voltage level may be added to DRIE to etch through the silicon oxide layer on the bottom surface, but not through the sidewall, of TAC hole 304. Second spacer 310 can be simultaneously formed on the sidewall, but not the bottom surface, of peripheral contact hole 306, using the same deposition and bottom punch processes. In some embodiments, the thicknesses of first spacer 308 and second spacer 310 are nominally the same in the lateral direction (e.g., radial direction).

FIG. 7B is a flowchart of another exemplary method for forming a spacer on a sidewall of an opening, according to some embodiments. Referring to FIG. 7B, at operation 706, to form the first spacer on the sidewall of the first opening, a plurality of shallow recesses are first formed by removing parts of the sacrificial layers abutting the sidewall of the first opening. At operation 708, a dielectric layer is deposited filling in the shallow recesses and on the sidewall and a bottom surface of the first opening. At operation 710, part of the dielectric layer that is deposited on the bottom surface of the first opening is removed. The removal of the part of the dielectric layer includes isotropic etching on the sidewall and the bottom surface of the first opening, according to some embodiments.

Different from the example illustrated in FIG. 3C in which first spacer 308 is formed by ALD deposition and bottom punch processes, FIGS. 3D-3E illustrate another example in which a first spacer 314 is formed by any deposition process, followed by an etch-back process. As illustrated in FIG. 3D, parts of sacrificial layers 206 in dielectric stack 218 that abut the sidewall of TAC hole 304 are removed by wet etching and/or dry etching, such as using a wet etchant for silicon nitride. A plurality of shallow recesses 312 can then be formed along the sidewall of TAC hole 304. The degree of the etching, i.e., the lateral dimension of shallow recess, can be controlled by the etching rate and/or etching time. The sacrificial layer partial removal process can provide space for a thicker dielectric layer deposition in the next step.

As illustrated in FIG. 3E, a first spacer 314 is formed on the sidewall, but not the bottom surface, of TAC hole 304. A dielectric layer can be first deposited into TAC hole 304 using one or more thin film deposition processes, such as ALD, CVD, PVD, or any combination thereof, which fills in shallow recesses 312 (as shown in FIG. 3D) and covers the sidewall and bottom surface of TAC hole 304. The part of the dielectric layer deposited on the bottom surface of TAC

hole 304 can be then removed using etch-back processes. In some embodiments, isotropic etching can be applied to etch the dielectric layer deposited on both the sidewall and the bottom surface of TAC hole 304. Because the dielectric layer is substantially thicker along the sidewall (filling in shallow recesses 312) than on the bottom surface, when the part of the dielectric layer on the bottom surface has been etched through, the part of the dielectric layer on the sidewall can be partially etched, leaving first spacer 314 covering only the sidewall of TAC hole 304. In other words, the thickened dielectric layer along the sidewall is etched-back, leaving a thinner dielectric layer as first spacer 314, according to some embodiments. The etching rate and/or etching time of any suitable isotropic etching process can be controlled to fully etch through the dielectric layer on the bottom surface of TAC hole 304, but partially etch back the dielectric layer on the sidewall of TAC hole 304.

Method 600 proceeds to operation 612, as illustrated in FIG. 6, in which a conductor layer is deposited in the first opening to form a TAC and in the second opening to form a peripheral contact. In some embodiments, the conductor layer is a composite layer including an adhesion/barrier layer and a conductor. As illustrated in FIG. 3F, a conductor layer 316 is deposited in TAC hole 304 (as shown in FIGS. 3C-3E) to fill the remaining space of TAC hole 304, thereby forming a TAC 318 extending vertically through dielectric stack 218. In some embodiments, an adhesion/barrier layer is first formed along first spacer 308/314 by depositing titanium/titanium nitride (Ti/TiN) or titanium/tantalum nitride (Ta/TaN) using one or more thin film deposition processes, such as ALD, CVD, PVD, electrochemical depositions, or any combination thereof. A conductor can then be formed in the remaining space of TAC hole 304 by depositing metals, such as tungsten, using one or more thin film deposition processes, such as ALD, CVD, PVD, electrochemical depositions, or any combination thereof. A conductor layer 320 can be simultaneously formed in peripheral contact hole 306 (as shown in FIGS. 3C-3E) to form a peripheral contact 322 in contact with peripheral device 307, using the same deposition processes. The excess conductor layer after deposition can be removed by CMP.

Method 600 proceeds to operation 614, as illustrated in FIG. 6, in which a slit extending vertically through the dielectric stack is formed after the formation of the TAC. Method 600 proceeds to operation 616, as illustrated in FIG. 6, in which a memory stack including a plurality of conductor/dielectric layer pairs is formed on the substrate by replacing, through the slit, the sacrificial layers in the dielectric/sacrificial layer pairs with a plurality of conductor layers. In some embodiments, a slit structure is formed by depositing a conductor layer in the slit after the formation of the memory stack. In some embodiments, a plurality of word line contacts each in contact with a respective one of the conductor layers of the conductor/dielectric layer pairs in the staircase structure are formed.

As illustrated in FIG. 5A, an opening (slit) can be etched through the dielectric/sacrificial layer pairs in dielectric stack 218 (as shown in FIGS. 3-4). The slit can be formed by wet etching and/or dry etching of dielectrics (e.g., silicon oxide and silicon nitride). The opening can be used as the pathway for gate replacement processes that replace sacrificial layers 206 in dielectric stack 218 with conductor layers 502 to form a plurality of conductor/dielectric layer pairs. The replacement of sacrificial layers 206 with conductor layers 502 can be performed by wet etching sacrificial layers 206 (e.g., silicon nitride) selective to dielectric layers 208 (e.g., silicon oxide) and filling the structure with conductor

layers **502** (e.g., W). Conductor layers **502** can be deposited by PVD, CVD, ALD, electrochemical depositions, or any combination thereof. Conductor layers **502** can include conductive materials including, but not limited to, W, Co, Cu, Al, polysilicon, silicides, or any combination thereof. As a result, after the gate replacement processes, dielectric stack **218** in FIGS. 3-4 becomes memory stack **504** including the conductor/dielectric layer pairs, i.e., interleaved conductor layers **502** and dielectric layers **208**, on silicon substrate **202**.

As illustrated in FIG. 5A, a slit structure **506** is formed by filling (e.g., depositing) conductive materials into the slit by PVD, CVD, ALD, electrochemical depositions, or any combination thereof. Slit structure **506** can include conductive materials including, but not limited to, W, Co, Cu, Al, polysilicon, silicides, or any combination thereof. In some embodiments, a dielectric layer (e.g., a silicon oxide layer) is formed first between the conductive materials of slit structure **506** and conductor layers **502** surrounding slit structure **506** as a spacer. The lower end of slit structure **506** can be in contact with a doped region **507**, which can be formed in silicon substrate **202** using ion implantation and/or thermal diffusion.

As illustrated in FIG. 5B, each word line contact **508** is in contact with a respective one of conductor layers **502** of the conductor/dielectric layer pairs in staircase structure **224**. Word line contacts **508** are formed through one or more dielectric layers by first etching vertical openings (e.g., by wet etching and/or dry etching), followed by filling the openings with conductive materials using ALD, CVD, PVD, electrochemical depositions, or any combination thereof. In some embodiments, other conductive materials are filled in the openings to function as an adhesion/barrier layer. Etching of dielectric layers to form the openings of word line contacts **508** can be controlled by etch stop at a different material. For example, etching of dielectric layers can be stopped when reaching to conductor layers **502** in staircase structure **224**.

FIG. 8 is a flowchart of another exemplary method **800** for forming a 3D memory device, according to some embodiments of the present disclosure. Operations **802**, **804**, **814**, and **816** are similar to operations **602**, **604**, **614**, and **616**, respectively, and thus are not repeated. Method **800** proceeds to operation **806**, as illustrated in FIG. 8, in which a first opening through the dielectric stack, a second opening outside of the dielectric stack, and a third opening through the dielectric stack are simultaneously etched. In some embodiments, the lateral dimension (e.g., diameter) of the third opening is smaller than lateral dimensions of the first and second openings. Each of the first, second, and third openings has a nominally circular shape in the plan view, according to some embodiments.

As illustrated in FIG. 4A, a first opening (TAC hole) **402**, a second opening (peripheral contact hole) **404**, and a third opening (dummy channel hole) **406** are simultaneously formed, each of which reaches to silicon substrate **202**. The lower end of peripheral contact hole **404** can be in contact with a peripheral device **405** formed on silicon substrate **202**. TAC hole **402** and dummy channel hole **406** can be etched through interleaved sacrificial layers **206** and dielectric layers **208** (e.g., silicon nitride and silicon oxide) in dielectric stack **218** using wet etching and/or dry etching, and peripheral contact hole **404** can be simultaneously etched through one or more dielectric layers (e.g., silicon oxide) using the same wet etching and/or dry etching process. In some embodiments, TAC hole **402**, peripheral contact hole **404**, and dummy channel hole **406** are etched using DRIE at the same time. The depths of TAC hole **402**,

peripheral contact hole **404**, and dummy channel hole **406** in the vertical direction can be nominally the same. In some embodiments, each of TAC hole **402**, peripheral contact hole **404**, and dummy channel hole **406** has a substantially circular shape in the plan view. The lateral dimensions (e.g., diameters) of TAC hole **402**, peripheral contact hole **404**, and dummy channel hole **406** can be controlled by patterning process and/or etching parameters, such as etching rate and etching time. In some embodiments, in the plan view, the diameter of dummy channel hole **406** is smaller than the diameter of TAC hole **402** and the diameter of peripheral contact hole **404**. In some embodiments, the diameter of peripheral contact hole **404** is smaller than the diameter of TAC hole **402** in the plan view.

Method **800** proceeds to operation **808**, as illustrated in FIG. 8, in which a dielectric layer is deposited (i) fully filling in the third opening to form a dummy channel structure and (ii) partially filling in the first opening and the second opening. Method **800** proceeds to operation **810**, as illustrated in FIG. 8, in which parts of the dielectric layer deposited on the bottom surfaces of the first and second openings are removed.

As illustrated in FIG. 4B, a dielectric layer (e.g., silicon oxide) is deposited into TAC hole **402**, peripheral contact hole **404**, and dummy channel hole **406** using one or more thin film deposition processes, such as ALD, CVD, PVD, electrochemical depositions, or any combination thereof. Due to the different lateral dimensions of TAC hole **402**, peripheral contact hole **404**, and dummy channel hole **406**, by controlling the deposition parameters, such as the deposition rate and/or deposition time, the deposited dielectric layer can fully fill in dummy channel hole **406** to form a dummy channel structure **408**, but only partially fill in TAC hole **402** and peripheral contact hole **404** to form a first spacer **410** and a second spacer **412**, respectively, on the sidewalls of TAC hole **402** and peripheral contact hole **404**. Dummy channel structure **408** is thus formed extending vertically through dielectric stack **218**. As described above, parts of the dielectric layer deposited on the bottom surfaces of TAC hole **402** and peripheral contact hole **404** can be removed (i.e., etched through) using the bottom punch process, such as high bias DRIE. As a result, first and second spacers **410** and **412** are formed on the sidewalls, but not the bottom surfaces, of TAC hole **402** and peripheral contact hole **404**, respectively. In some embodiments, the simultaneously formed first and second spacers **410** and **412** have nominally the same thickness in the radial direction in the plan view.

Method **800** proceeds to operation **812**, as illustrated in FIG. 8, in which a conductor layer is deposited (i) filling in the first opening to form a TAC and (ii) filling in the second opening to form a peripheral contact. As illustrated in FIG. 4C, a conductor layer **414** is deposited in TAC hole **402** (as shown in FIG. 4B) to fill the remaining space of TAC hole **402**, thereby forming a TAC **416** extending vertically through dielectric stack **218**. In some embodiments, an adhesion/barrier layer is first formed along first spacer **410** by depositing Ti/TiN or Ta/TaN using one or more thin film deposition processes, such as ALD, CVD, PVD, electrochemical depositions, or any combination thereof. A conductor can then be formed in the remaining space of TAC hole **402** by depositing metals, such as tungsten, using one or more thin film deposition processes, such as ALD, CVD, PVD, electrochemical depositions, or any combination thereof. A conductor layer **418** can be simultaneously formed in peripheral contact hole **404** (as shown in FIG. 4B) to form a peripheral contact **420** in contact with peripheral

device 405, using the same deposition processes. The excess conductor layer after deposition can be removed by CMP.

According to one aspect of the present disclosure, a method for forming a 3D memory device is disclosed. A dielectric stack including a plurality of dielectric/sacrificial layer pairs is formed on a substrate. A channel structure extending vertically through the dielectric stack is formed. A first opening extending vertically through the dielectric stack is formed. A spacer is formed on a sidewall of the first opening. A TAC extending vertically through the dielectric stack is formed by depositing a conductor layer in contact with the spacer in the first opening. A slit extending vertically through the dielectric stack is formed after forming the TAC. A memory stack including a plurality of conductor/dielectric layer pairs is formed on the substrate by replacing, through the slit, the sacrificial layers in the dielectric/sacrificial layer pairs with a plurality of conductor layers.

In some embodiments, a staircase structure is formed at one edge of the dielectric stack prior to forming the first opening. A plurality of word line contacts each in contact with a respective one of the conductor layers of the conductor/dielectric layer pairs in the staircase structure are formed, according to some embodiments.

In some embodiments, a slit structure is formed by depositing a conductor layer in the slit.

In some embodiments, a dummy channel structure extending vertically through the dielectric stack is formed prior to forming the first opening.

In some embodiments, to form the first opening, the first opening through the dielectric stack and a second opening outside of the dielectric stack are simultaneously etched. In some embodiments, to form the TAC, the conductor layer is deposited in the first opening to form the TAC and in the second opening to form a peripheral contact.

In some embodiments, to form the spacer on the sidewall of first opening, a dielectric layer is deposited on the sidewall and a bottom surface of the first opening, and part of the dielectric layer that is deposited on the bottom surface of the first opening is removed. The deposition of the dielectric layer includes ALD, and the removal of the part of the dielectric layer includes anisotropic etching on the bottom surface of the first opening, according to some embodiments.

In some embodiments, to form the spacer on the sidewall of first opening, a plurality of shallow recesses are formed by removing parts of the sacrificial layers abutting the sidewall of the first opening, a dielectric layer is deposited filling in the shallow recesses and on the sidewall and a bottom surface of the first opening, and part of the dielectric layer that is deposited on the bottom surface of the first opening is removed. The removal of the part of the dielectric layer includes isotropic etching on the sidewall and the bottom surface of the first opening, according to some embodiments.

In some embodiments, to form the first opening, the first opening through the dielectric stack, a second opening outside of the dielectric stack, and a third opening through the dielectric stack are simultaneously etched. A lateral dimension of the third opening can be smaller than lateral dimensions of the first and second openings.

In some embodiments, to form the spacer on the sidewall of the first opening, a dielectric layer is deposited (i) fully filling in the third opening to form a dummy channel structure and (2) partially filling in the first opening and the second opening, and parts of the dielectric layer that are deposited on a bottom surface of the first opening and on a bottom surface of the second opening are removed. Each of

the first, second, and third openings can have a nominally circular shape in the plan view.

In some embodiments, the dielectric layers in the dielectric/sacrificial layer pairs include silicon oxide, the sacrificial layers in the dielectric/sacrificial layer pairs include silicon nitride, and the spacer includes silicon oxide.

According to another aspect of the present disclosure, a method for forming a 3D memory device is disclosed. A dielectric stack including a plurality of dielectric/sacrificial layer pairs is formed on a substrate. A channel structure extending vertically through the dielectric stack is formed. A dummy channel structure extending vertically through the dielectric stack is formed. A first opening through the dielectric stack and a second opening outside of the dielectric stack are simultaneously etched. A first spacer on a sidewall of the first opening and a second spacer on a sidewall of the second opening are simultaneously formed. A conductor layer is deposited (i) filling in the first opening to form a TAC and (ii) filling in the second opening to form a peripheral contact. A slit extending vertically through the dielectric stack is formed after forming the TAC and peripheral device. A memory stack including a plurality of conductor/dielectric layer pairs is formed on the substrate by replacing, through the slit, the sacrificial layers in the dielectric/sacrificial layer pairs with a plurality of conductor layers.

In some embodiments, a staircase structure is formed at one edge of the dielectric stack prior to forming the dummy channel structure. A plurality of word line contacts each in contact with a respective one of the conductor layers of the conductor/dielectric layer pairs in the staircase structure are formed, according to some embodiments.

In some embodiments, a slit structure is formed by depositing a conductor layer in the slit.

In some embodiments, to form the first spacer on the sidewall of the first opening, a dielectric layer is deposited on the sidewall and a bottom surface of the first opening, and part of the dielectric layer that is deposited on the bottom surface of the first opening is removed. The deposition of the dielectric layer includes ALD, and the removal of the part of the dielectric layer includes anisotropic etching on the bottom surface of the first opening, according to some embodiments.

In some embodiments, to form the spacer on the sidewall of first opening, a plurality of shallow recesses are formed by removing parts of the sacrificial layers abutting the sidewall of the first opening, a dielectric layer is deposited filling in the shallow recesses and on the sidewall and a bottom surface of the first opening, and part of the dielectric layer that is deposited on the bottom surface of the first opening is removed. The removal of the part of the dielectric layer includes isotropic etching on the sidewall and the bottom surface of the first opening, according to some embodiments.

In some embodiments, the dielectric layers in the dielectric/sacrificial layer pairs include silicon oxide, the sacrificial layers in the dielectric/sacrificial layer pairs include silicon nitride, and the first and second spacers include silicon oxide.

According to still another aspect of the present disclosure, a method for forming a 3D memory device is disclosed. A dielectric stack including a plurality of dielectric/sacrificial layer pairs is formed on a substrate. A channel structure extending vertically through the dielectric stack is formed. A first opening through the dielectric stack, a second opening outside of the dielectric stack, and a third opening through the dielectric stack are simultaneously etched. A lateral

dimension of the third opening is smaller than lateral dimensions of the first and second openings. A dielectric layer is deposited (i) fully filling in the third opening to form a dummy channel structure and (ii) partially filling in the first opening and the second opening. Parts of the dielectric layer that are deposited on a bottom surface of the first opening and on a bottom surface of the second opening are removed. A conductor layer is deposited (i) filling in the first opening to form a TAC and (ii) filling in the second opening to form a peripheral contact. A slit extending vertically through the dielectric stack is formed after forming the TAC and peripheral device. A memory stack including a plurality of conductor/dielectric layer pairs is formed on the substrate by replacing, through the slit, the sacrificial layers in the dielectric/sacrificial layer pairs with a plurality of conductor layers.

In some embodiments, a staircase structure is formed at one edge of the dielectric stack prior to etching the first, second, and third openings. A plurality of word line contacts each in contact with a respective one of the conductor layers of the conductor/dielectric layer pairs in the staircase structure are formed, according to some embodiments.

In some embodiments, a slit structure is formed by depositing a conductor layer in the slit.

In some embodiments, each of the first, second, and third openings has a nominally circular shape in the plan view.

In some embodiments, the dielectric layers in the dielectric/sacrificial layer pairs includes silicon oxide, the sacrificial layers in the dielectric/sacrificial layer pairs includes silicon nitride, and the dielectric layer filling the first, second, and third openings include silicon oxide.

According to yet another aspect of the present disclosure, a 3D memory device includes a substrate, a memory stack on the substrate including a plurality of conductor/dielectric layer pairs, a channel structure extending vertically through the conductor/dielectric layer pairs in the memory stack, a TAC extending vertically through the conductor/dielectric layer pairs in the memory stack, and a dummy channel structure fully filled with a dielectric layer and extending vertically through the conductor/dielectric layer pairs in the memory stack.

In some embodiments, the 3D memory device further includes a peripheral device on the substrate, and a peripheral contact outside of the memory stack and in contact with the peripheral device.

In some embodiments, each of the TAC and peripheral contact includes a spacer with a nominally same thickness. The dielectric layer in the dummy channel structure and the spacers in the TAC and peripheral contact include silicon oxide, according to some embodiments.

In some embodiments, the 3D memory device further includes a lower memory deck on the substrate and an upper memory deck above the lower memory stack. In some embodiments, the channel structure includes a lower channel structure extending vertically through the lower memory deck, an upper channel structure extending vertically through the upper memory deck, and an inter-deck plug disposed vertically between and in contact with the lower channel structure and the upper channel structure.

In some embodiments, the 3D memory device further includes a staircase structure at one edge of the memory stack, and a plurality of word line contacts each in contact with a respective one of the conductor layers of the conductor/dielectric layer pairs in the staircase structure.

The foregoing description of the specific embodiments will so reveal the general nature of the present disclosure that others can, by applying knowledge within the skill of

the art, readily modify and/or adapt for various applications such specific embodiments, without undue experimentation, without departing from the general concept of the present disclosure. Therefore, such adaptations and modifications are intended to be within the meaning and range of equivalents of the disclosed embodiments, based on the teaching and guidance presented herein. It is to be understood that the phraseology or terminology herein is for the purpose of description and not of limitation, such that the terminology or phraseology of the present specification is to be interpreted by the skilled artisan in light of the teachings and guidance.

Embodiments of the present disclosure have been described above with the aid of functional building blocks illustrating the implementation of specified functions and relationships thereof. The boundaries of these functional building blocks have been arbitrarily defined herein for the convenience of the description. Alternate boundaries can be defined so long as the specified functions and relationships thereof are appropriately performed.

The Summary and Abstract sections may set forth one or more but not all exemplary embodiments of the present disclosure as contemplated by the inventor(s), and thus, are not intended to limit the present disclosure and the appended claims in any way.

The breadth and scope of the present disclosure should not be limited by any of the above-described exemplary embodiments, but should be defined only in accordance with the following claims and their equivalents.

What is claimed is:

1. A method for forming a three-dimensional (3D) memory device, comprising:

forming a dielectric stack comprising a plurality of dielectric/sacrificial layer pairs on a substrate;

forming a channel structure extending vertically through the dielectric stack;

forming a first opening extending vertically through the dielectric stack;

forming a spacer on a sidewall of the first opening;

forming a through array contact (TAC) extending vertically through the dielectric stack by depositing a conductor layer in contact with the spacer in the first opening;

after forming the TAC, forming a slit extending vertically through the dielectric stack; and

forming a memory stack comprising a plurality of conductor/dielectric layer pairs on the substrate by replacing, through the slit, the sacrificial layers in the dielectric/sacrificial layer pairs with a plurality of conductor layers.

2. The method of claim 1, further comprising prior to forming the first opening, forming a staircase structure at one side of the dielectric stack.

3. The method of claim 2, further comprising forming a plurality of word line contacts each in contact with a respective one of the conductor layers of the conductor/dielectric layer pairs in the staircase structure.

4. The method of claim 1, further comprising forming a slit structure by depositing a conductor layer in the slit.

5. The method of claim 1, further comprising prior to forming the first opening, forming a dummy channel structure extending vertically through the dielectric stack.

6. The method of claim 1, wherein forming the first opening comprises simultaneously etching the first opening through the dielectric stack and a second opening outside of the dielectric stack.

21

7. The method of claim 6, wherein forming the TAC comprises depositing the conductor layer in the first opening to form the TAC and in the second opening to form a peripheral contact.

8. The method of claim 1, wherein forming the spacer on the sidewall of the first opening comprises:

depositing a dielectric layer on the sidewall and a bottom surface of the first opening; and
removing part of the dielectric layer that is deposited on the bottom surface of the first opening.

9. The method of claim 8, wherein the deposition of the dielectric layer comprises atomic layer deposition (ALD), and the removal of the part of the dielectric layer comprises anisotropic etching on the bottom surface of the first opening.

10. The method of claim 1, wherein forming the spacer on the sidewall of the first opening comprises:

forming a plurality of shallow recesses by removing parts of the sacrificial layers abutting the sidewall of the first opening;

depositing a dielectric layer filling in the shallow recesses and on the sidewall and a bottom surface of the first opening; and

removing part of the dielectric layer that is deposited on the bottom surface of the first opening.

11. The method of claim 10, wherein the removal of the part of the dielectric layer comprises isotropic etching on the sidewall and the bottom surface of the first opening.

12. The method of claim 1, wherein forming the first opening comprises:

simultaneously etching the first opening through the dielectric stack, a second opening outside of the dielectric stack, and a third opening through the dielectric stack,

wherein a lateral dimension of the third opening is smaller than lateral dimensions of the first and second openings.

13. The method of claim 12, wherein forming the spacer on the sidewall of the first opening comprises:

depositing a dielectric layer (i) fully filling in the third opening to form a dummy channel structure and (ii) partially filling in the first opening and the second opening; and

22

removing parts of the dielectric layer that are deposited on a bottom surface of the first opening and on a bottom surface of the second opening.

14. The method of claim 12, wherein each of the first, second, and third openings has a nominally circular shape in the plan view.

15. The method of claim 1, wherein the dielectric layers in the dielectric/sacrificial layer pairs comprise silicon oxide, the sacrificial layers in the dielectric/sacrificial layer pairs comprise silicon nitride, and the spacer comprises silicon oxide.

16. A method for forming a three-dimensional (3D) memory device, comprising:

forming a dielectric stack comprising a plurality of dielectric/sacrificial layer pairs on a substrate;

forming a channel structure extending vertically through the dielectric stack;

simultaneously etching a first opening through the dielectric stack, a second opening outside of the dielectric stack, and a third opening through the dielectric stack, wherein a lateral dimension of the third opening is smaller than lateral dimensions of the first and second openings;

depositing a dielectric layer (i) fully filling in the third opening to form a dummy channel structure and (ii) partially filling in the first opening and the second opening;

removing parts of the dielectric layer that are deposited on a bottom surface of the first opening and on a bottom surface of the second opening;

depositing a conductor layer (i) filling in the first opening to form a through array contact (TAC) and (ii) filling in the second opening to form a peripheral contact;

after forming the TAC and peripheral contact, forming a slit extending vertically through the dielectric stack; and

forming a memory stack comprising a plurality of conductor/dielectric layer pairs on the substrate by replacing, through the slit, the sacrificial layers in the dielectric/sacrificial layer pairs with a plurality of conductor layers.

17. The method of claim 16, wherein each of the first, second and third openings has a nominally circular shape in the plan view.

* * * * *