

(12) **United States Patent**
Goldstein et al.

(10) **Patent No.:** **US 10,419,863 B2**
(45) **Date of Patent:** **Sep. 17, 2019**

(54) **METHOD AND SYSTEM FOR SOUND MONITORING OVER A NETWORK**

(58) **Field of Classification Search**
CPC . G01H 3/14; H04R 1/10; H04R 29/00; H04R 1/1058; H04R 2201/107;

(71) Applicant: **Staton Techiya, LLC**, Delray Beach, FL (US)

(Continued)

(72) Inventors: **Steven Wayne Goldstein**, Delray Beach, FL (US); **Marc Boillot**, Plantation, FL (US); **Jason McIntosh**, Sugar Hill, GA (US); **John P. Keady**, Fairfax Station, VA (US)

(56) **References Cited**

U.S. PATENT DOCUMENTS

4,484,345 A 11/1984 Stearns
6,601,456 B1 8/2003 Davidson et al.
(Continued)

(73) Assignee: **Staton Techiya, LLC**, Delray Beach, FL (US)

FOREIGN PATENT DOCUMENTS

(*) Notice: Subject to any disclaimer, the term of this patent is extended or adjusted under 35 U.S.C. 154(b) by 573 days.

EP 1128693 8/2001
EP 1388823 2/2004
(Continued)

OTHER PUBLICATIONS

(21) Appl. No.: **13/917,079**

Office Action for U.S. Appl. No. 12/555,570, filed Sep. 8, 2009, dated Oct. 31, 2012.

(22) Filed: **Jun. 13, 2013**

(Continued)

(65) **Prior Publication Data**

US 2013/0279703 A1 Oct. 24, 2013

Primary Examiner — Leshui Zhang

Related U.S. Application Data

(74) *Attorney, Agent, or Firm* — Akerman LLP; Peter A. Chiabotti; Mammen (Roy) P. Zachariah, Jr.

(62) Division of application No. 12/555,570, filed on Sep. 8, 2009, now Pat. No. 8,488,799.

(Continued)

(57) **ABSTRACT**

(51) **Int. Cl.**
H04R 29/00 (2006.01)
G10L 19/00 (2013.01)

(Continued)

A mobile communication environment (100) can include a mobile device (160) to measure and send sound pressure level data. The mobile device (160) can initiate the collection of audio information responsive to detecting a trigger event. Mobile device (160) can measure or calculate the sound pressure level from the audio information. Metadata including time information and geographic location information can be captured with the collected audio information. Mobile device (160) can send the sound pressure level data and metadata through a wired or wireless communication path to a database (614).

(52) **U.S. Cl.**
CPC **H04R 29/00** (2013.01); **G01H 3/14** (2013.01); **G10L 19/00** (2013.01);

(Continued)

18 Claims, 17 Drawing Sheets

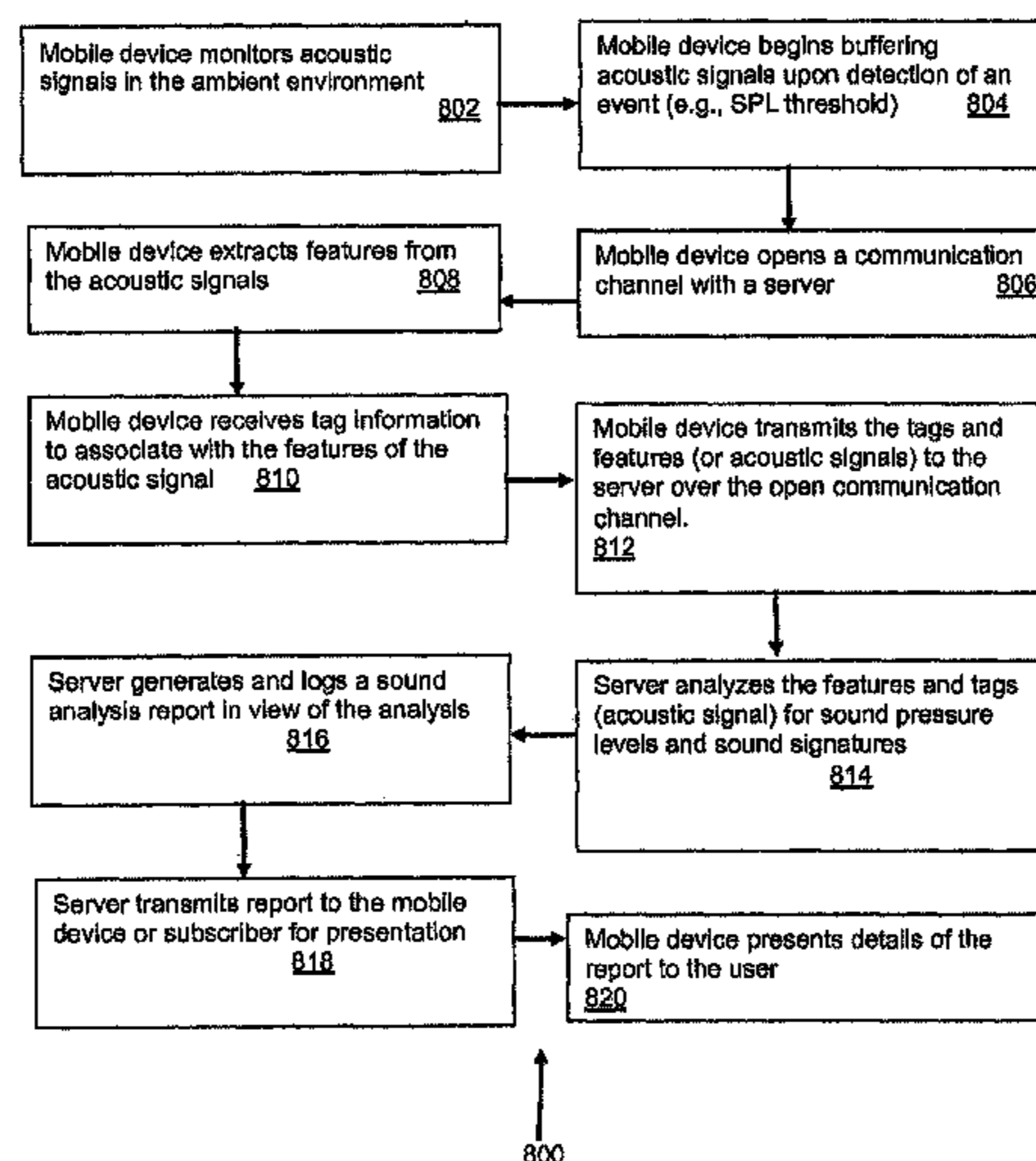

Related U.S. Application Data

- (60) Provisional application No. 61/096,128, filed on Sep. 11, 2008.
- (51) **Int. Cl.**
G01H 3/14 (2006.01)
H04M 1/725 (2006.01)
H04R 3/00 (2006.01)
- (52) **U.S. Cl.**
 CPC *H04M 1/72522* (2013.01); *H04M 2250/10* (2013.01); *H04M 2250/12* (2013.01); *H04R 3/00* (2013.01); *H04R 2499/11* (2013.01)
- (58) **Field of Classification Search**
 CPC H04R 1/28; H04R 1/02; H04R 1/2834; H04R 5/02; H04R 17/00; H04R 27/00; H04R 2205/022; H04R 2227/03; H04R 2217/01; G08B 21/00; G08B 23/00; G08B 13/16; G08B 13/196; G08B 13/1672; G08B 13/19697; H04M 1/00; G01K 1/00; H04S 5/00
 USPC 381/92, 94.7, 95, 122, 120, 317, 318, 381/320, 56-60; 455/67.11, 67.12, 67.13, 455/67.14, 67.15, 67.16, 115.3, 115.4, 455/226.2, 423; 700/94, E19.001, 700/E17.002, 231, 246, 251
 See application file for complete search history.

(56) **References Cited**

U.S. PATENT DOCUMENTS

- 6,654,652 B1 11/2003 Dalton et al.
 2001/0040969 A1* 11/2001 Revit H04R 25/70
 381/60

- 2003/0210184 A1 11/2003 Apostolos
 2004/0064319 A1* 4/2004 Neuhauser G10L 19/018
 704/273
 2005/0052285 A1* 3/2005 Iriyama H04R 29/007
 340/692
 2005/0079880 A1* 4/2005 Donner H04Q 9/00
 455/466
 2005/0244013 A1 11/2005 Battenberg et al.
 2008/0130906 A1 6/2008 Goldstein et al.
 2008/0159547 A1* 7/2008 Schuler G01H 3/14
 381/56

FOREIGN PATENT DOCUMENTS

- JP 2004-133895 4/2004
 JP 2006-092381 4/2006
 JP 2006092381 A * 4/2006
 JP 2008-170415 7/2008

OTHER PUBLICATIONS

- Japanese Office Action for Japanese Appln. No. 2011-526997, dated Jun. 7, 2013 with English Translation.
 Extended European Search Report, European Patent Office, dated Apr. 10, 2014, pp. 1-10.
 Cho et al: "Noise mapping using measured noise and GPS data", Applied Acoustics, Elsevier Publishing, GB, vol. 68, No. 9, May 24, 2007 (May 24, 2007), pp. 1054-1061, XP022095180, ISSN: 0003-682X, DOI:10.1016/J.APACOUST.2006.04.015 * section 2.1-2.3 *.
 Andrzej Czyzewski et al: "Audio Engineering Society 'Convention Paper 6006 Web-Based Acoustic Noise Measurement System", 116th AES Convention, May 1, 2004 (May 1, 2004), XP055111767, Retrieved from the Internet: URL:<http://www.aes.org/tmpFiles/elib/20140403/12724.pdf>.

* cited by examiner

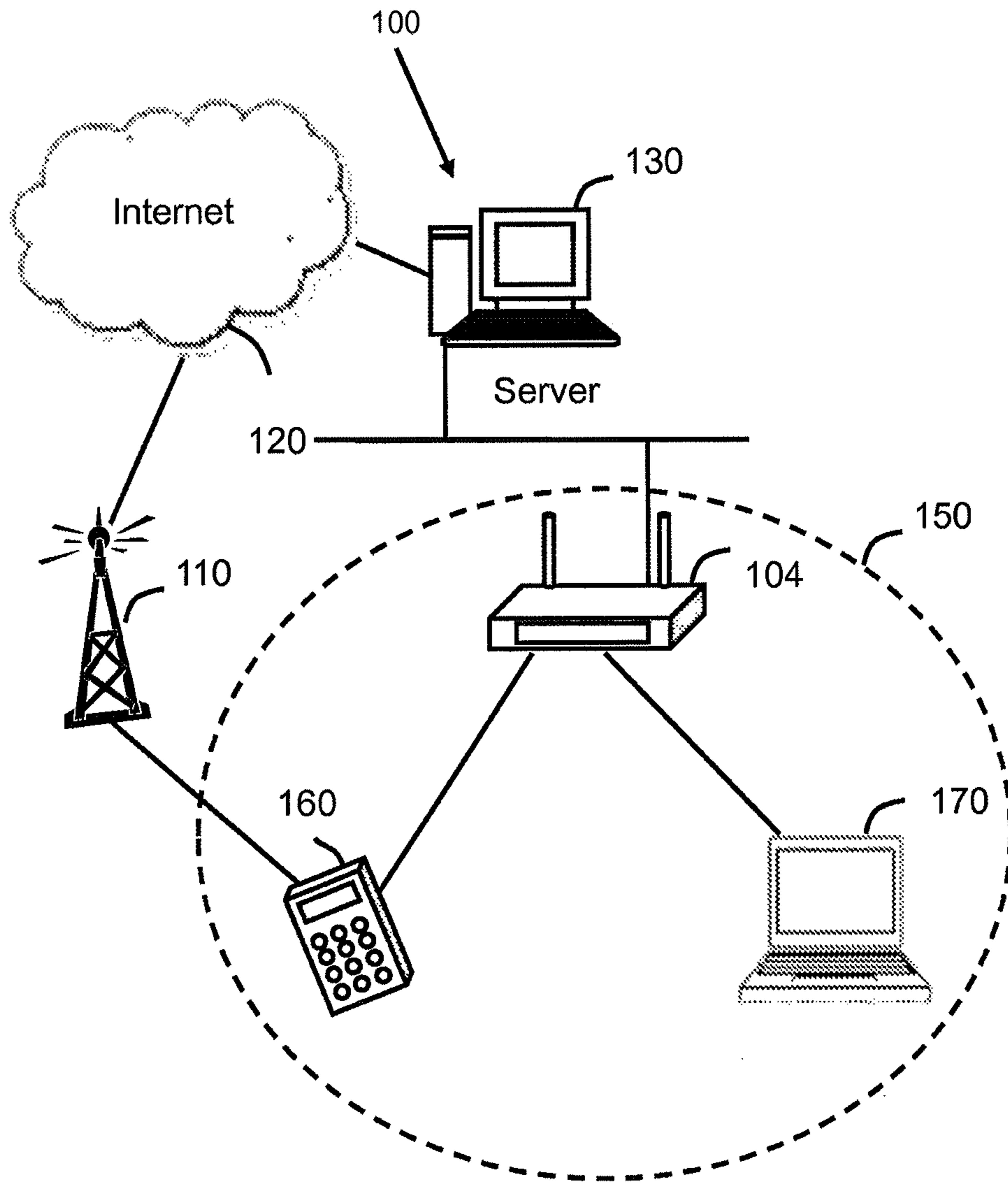

FIG. 1



FIG. 1A

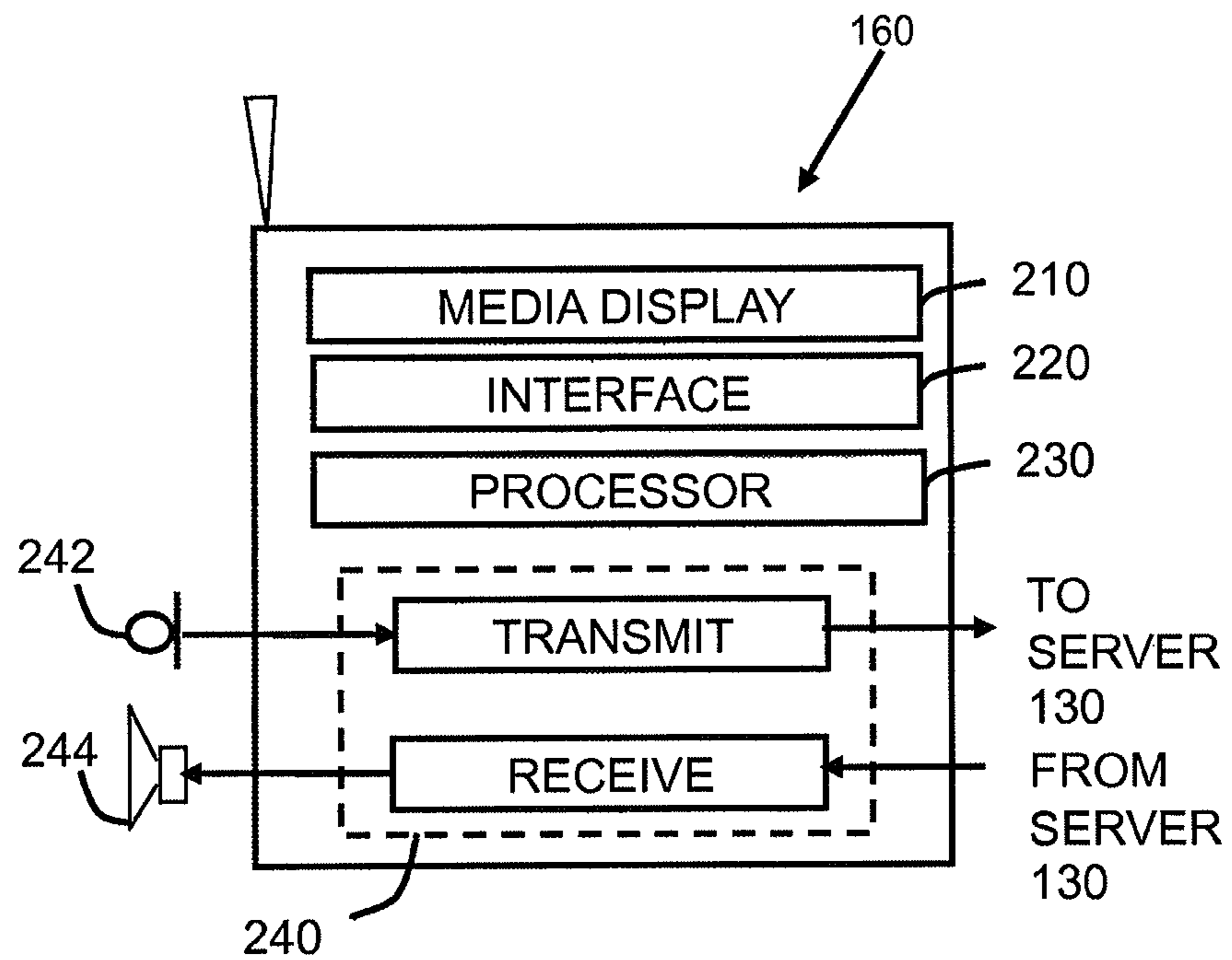

FIG. 2

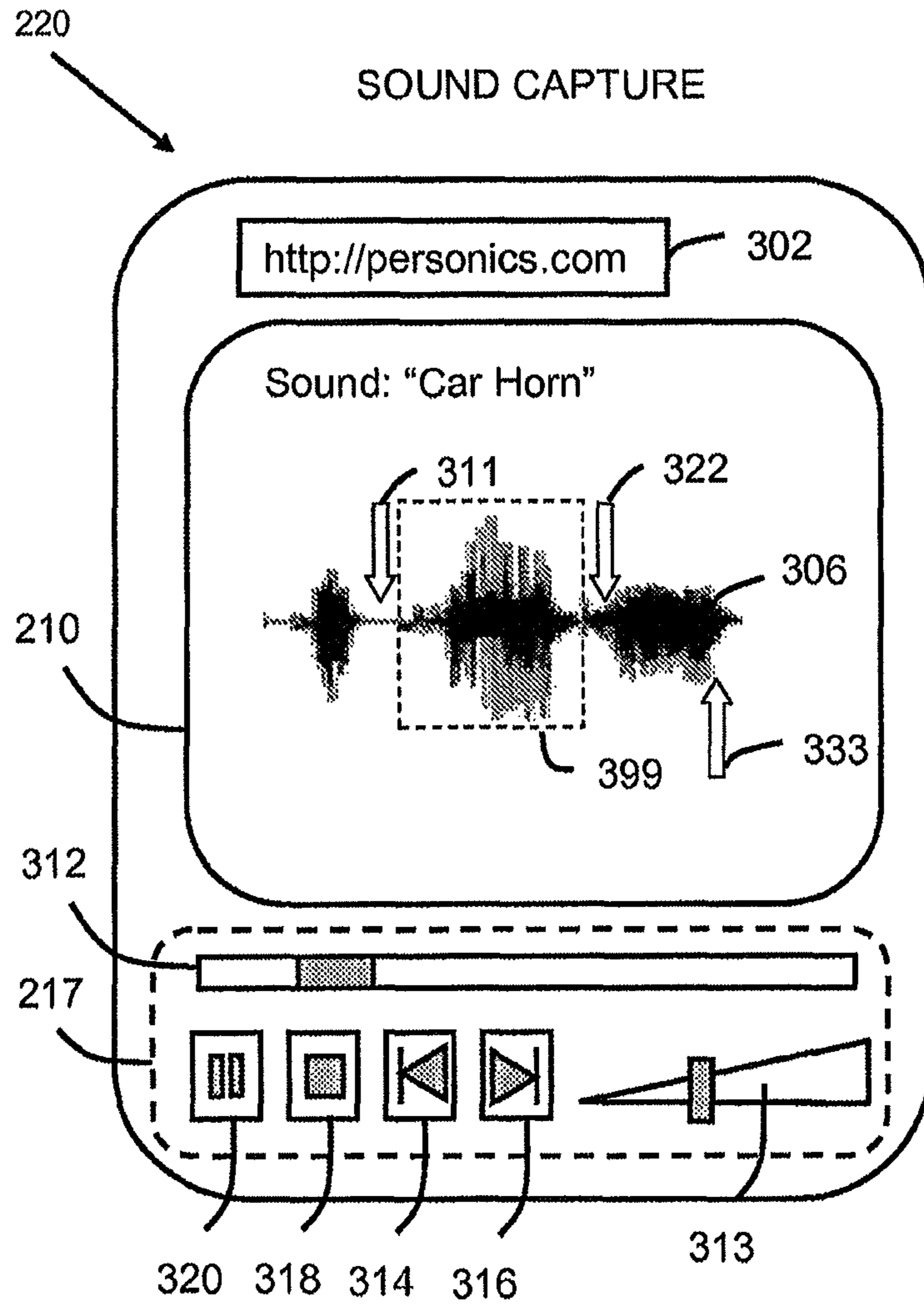

FIG. 3

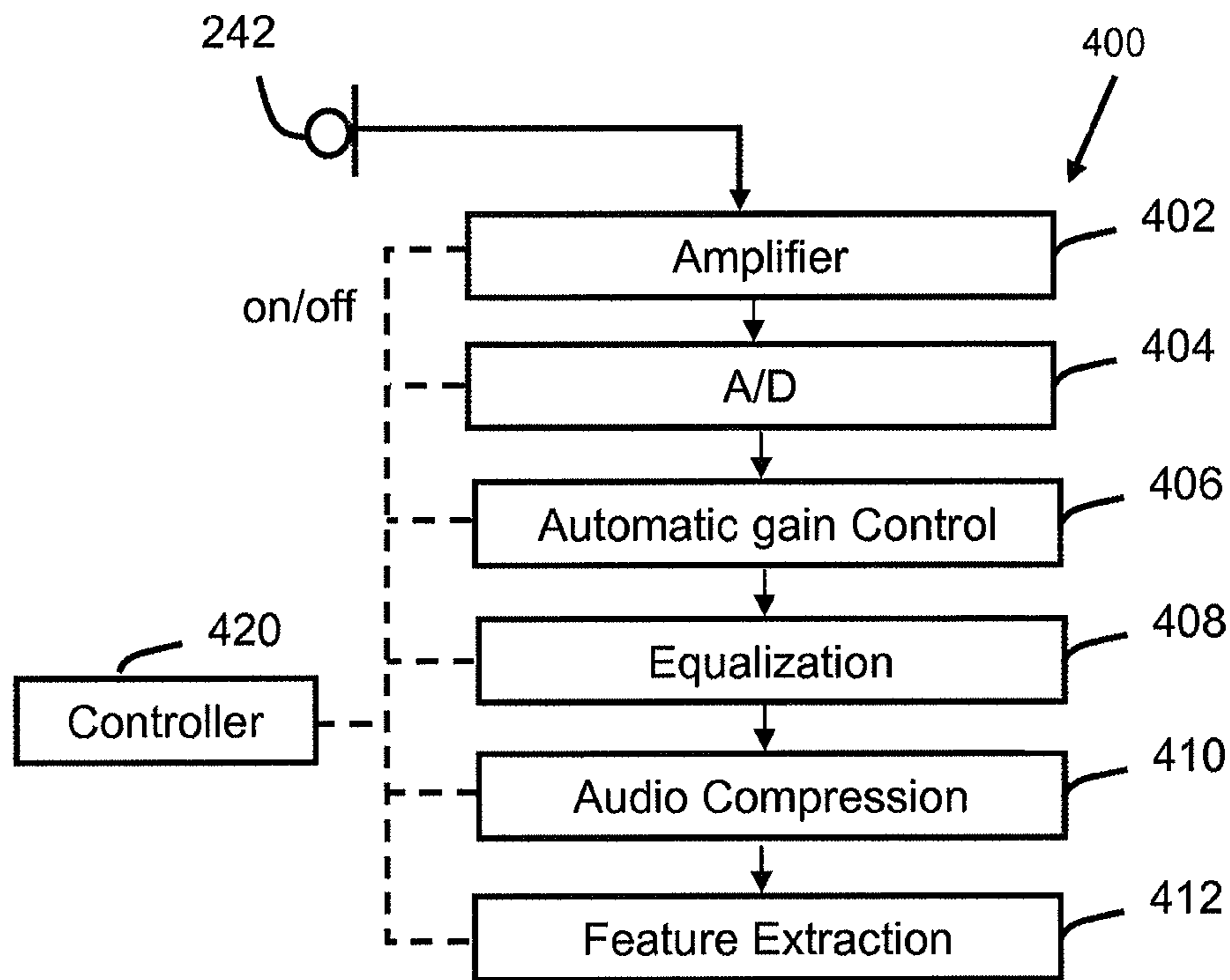

FIG. 4

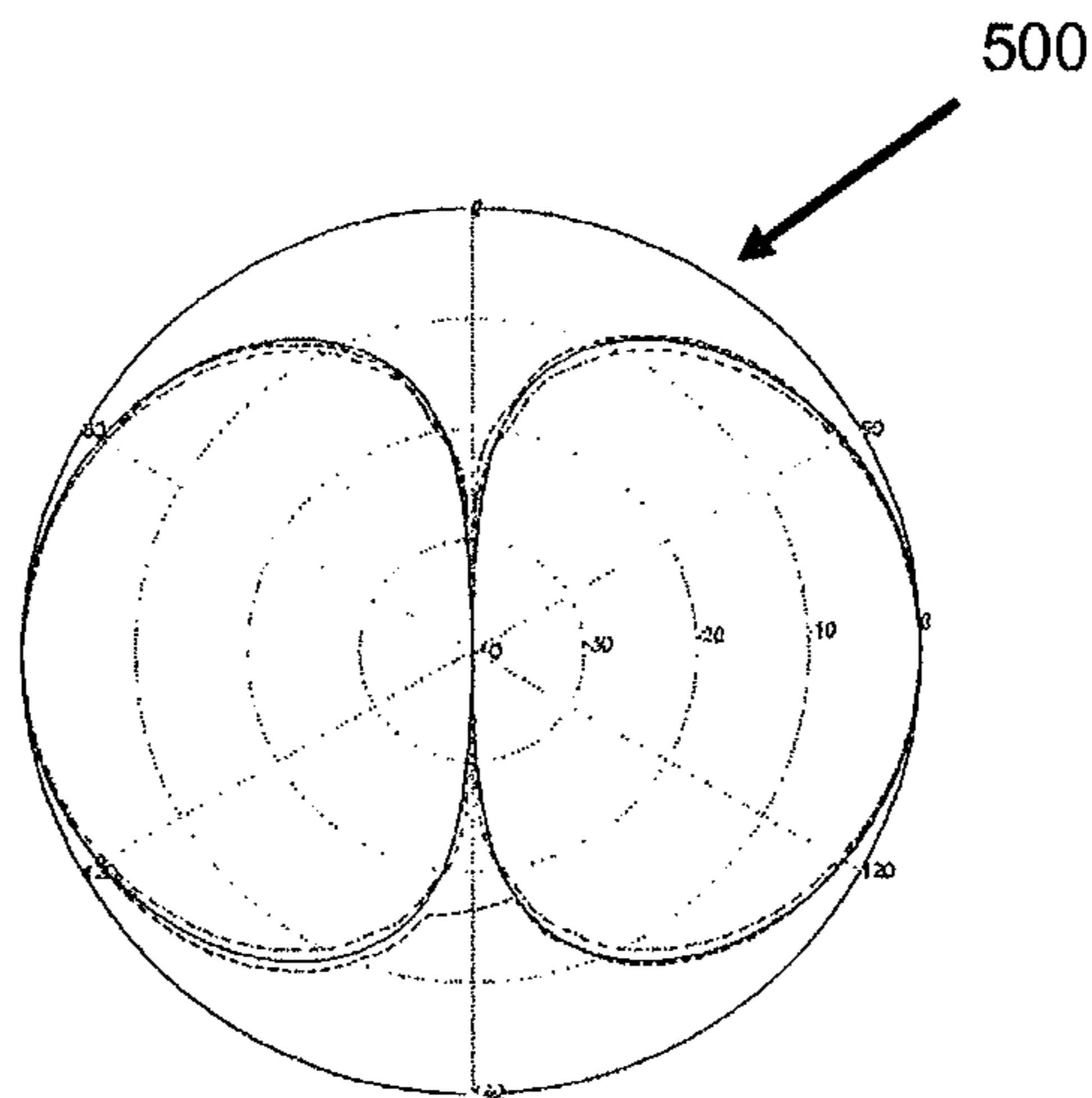

FIG. 5

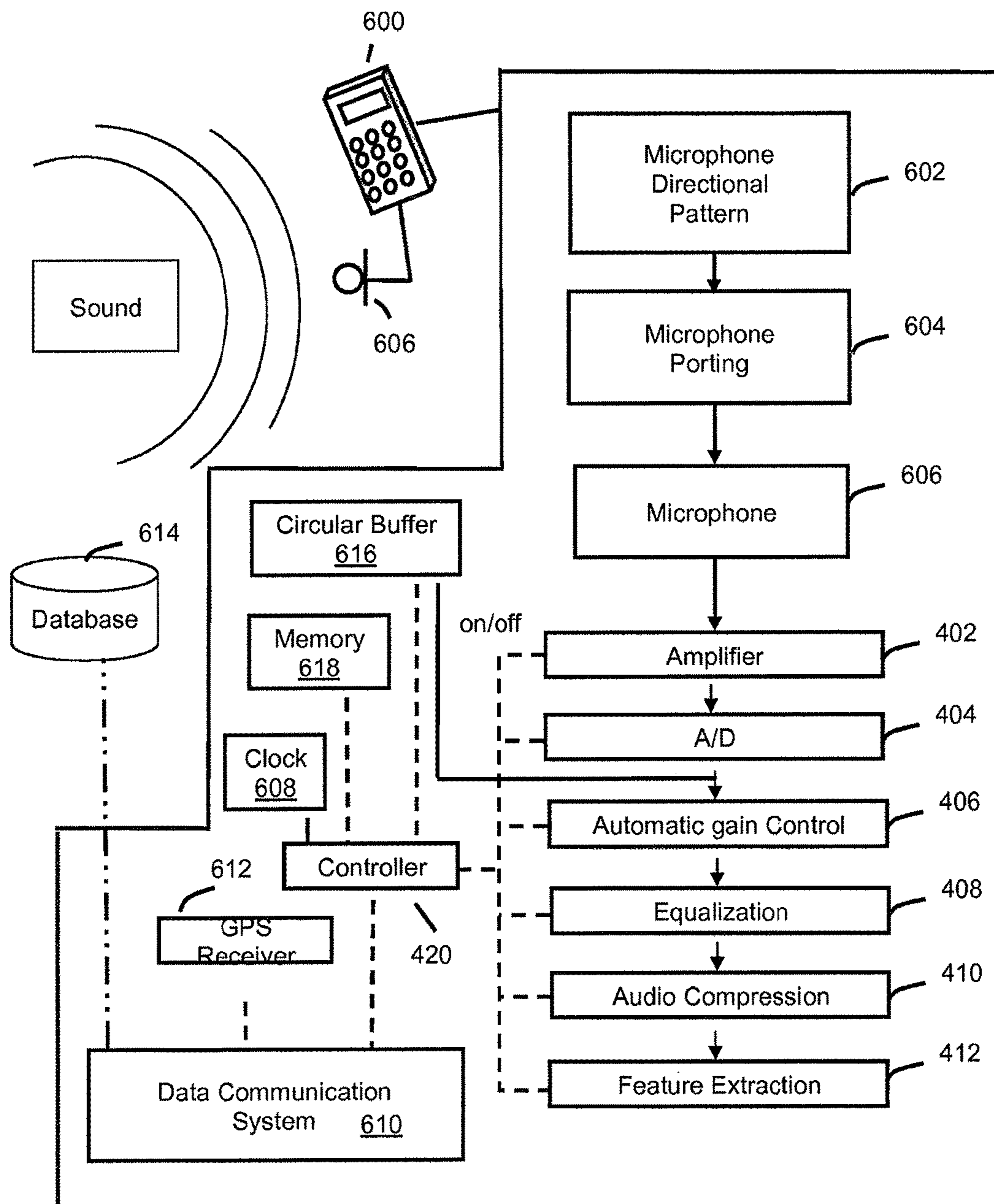
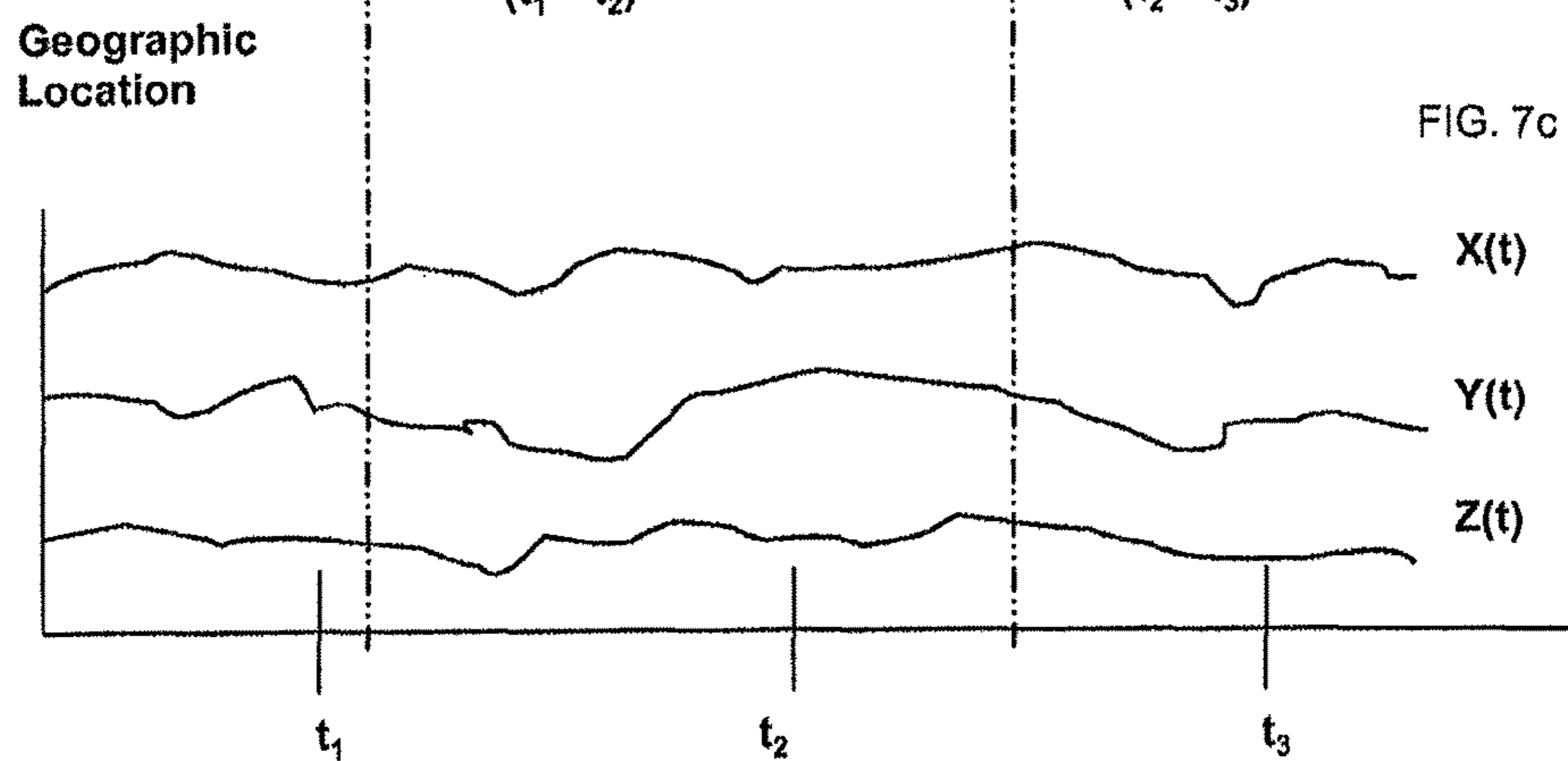
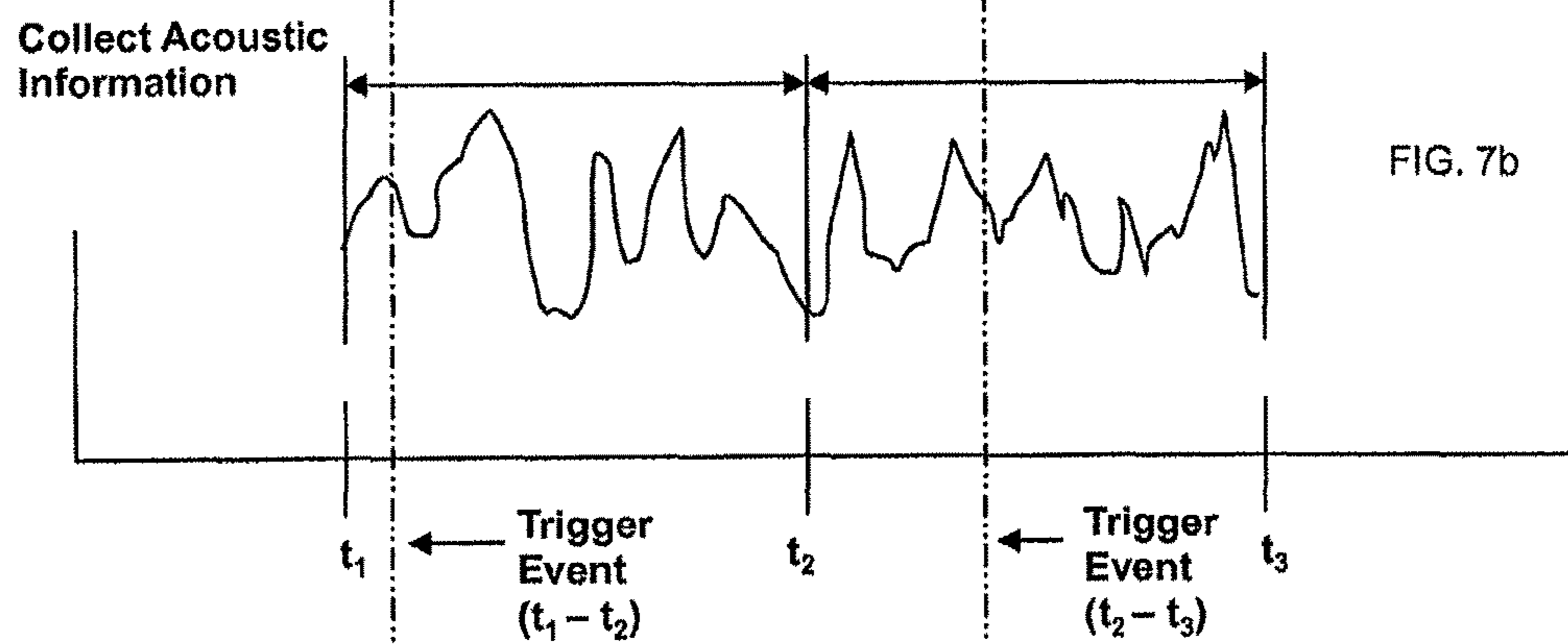
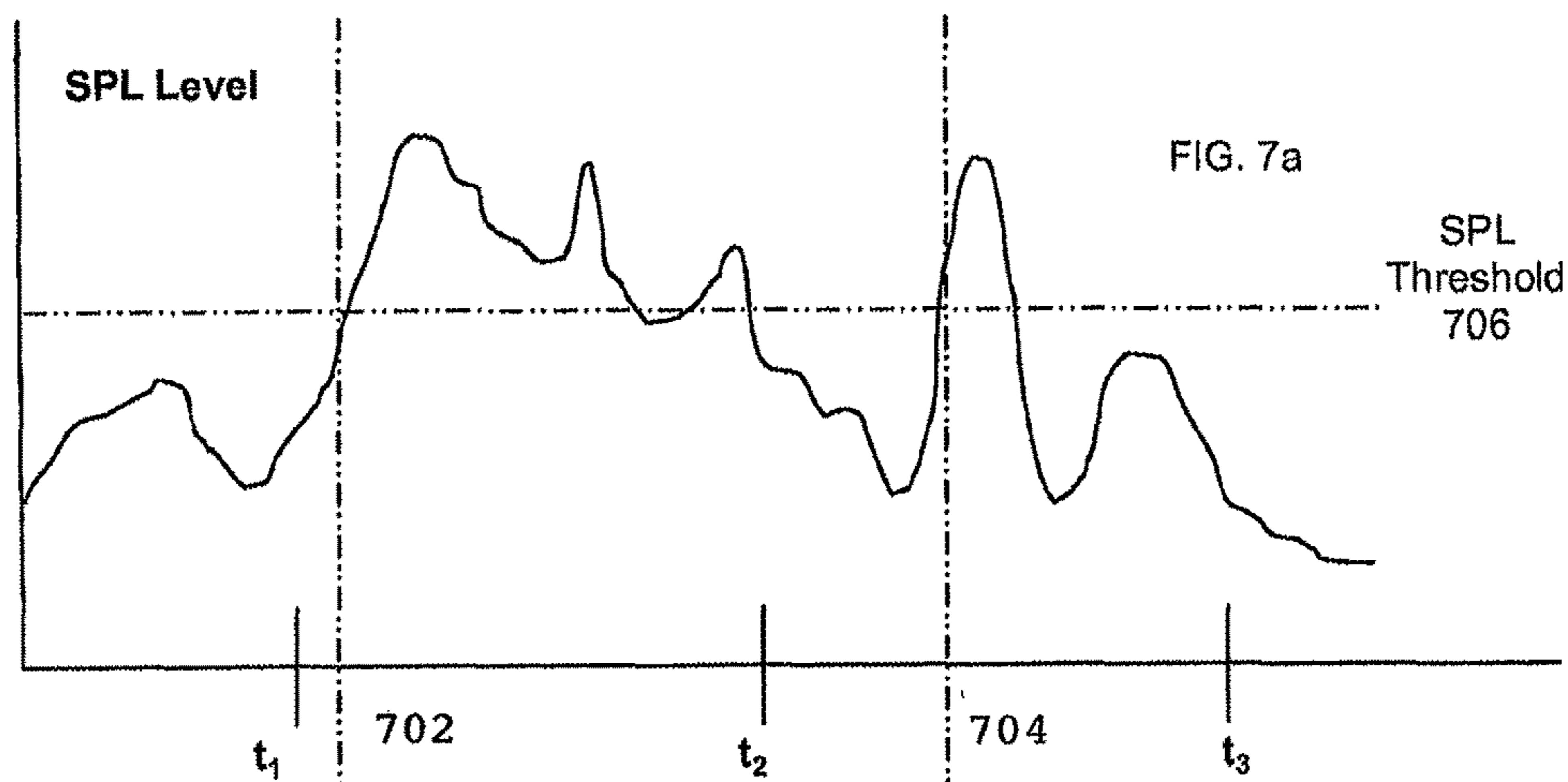

FIG. 6



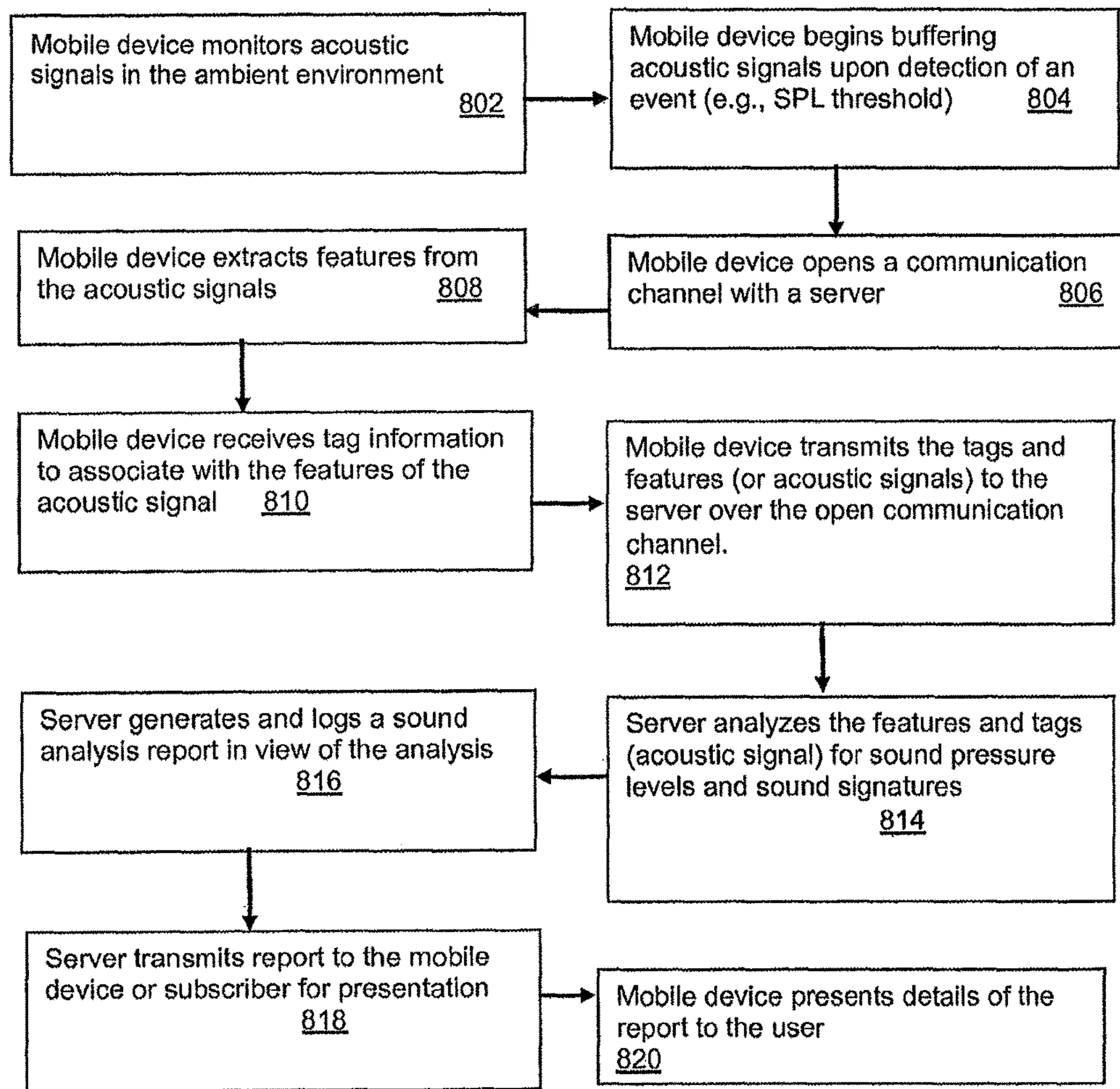
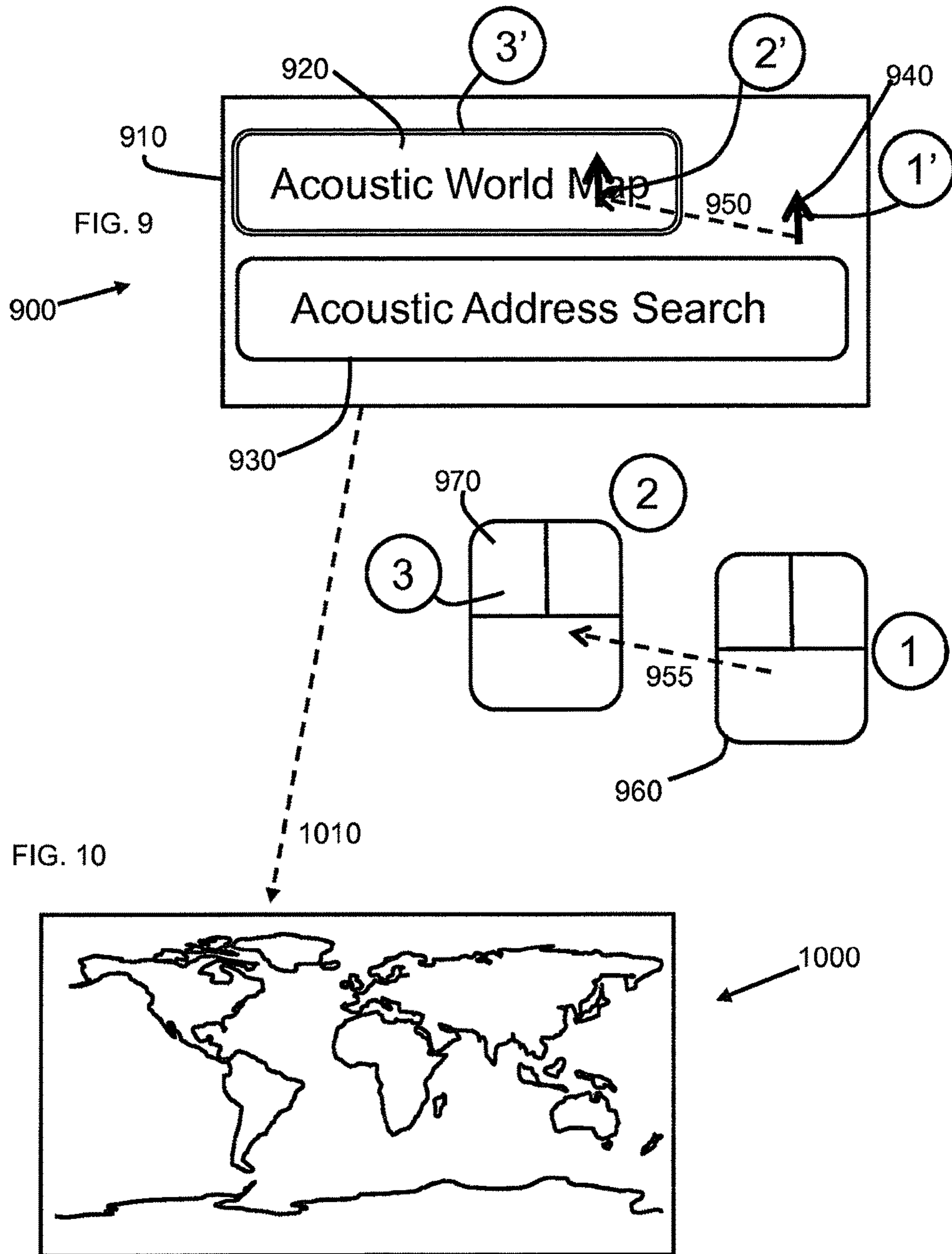

FIG. 8

800



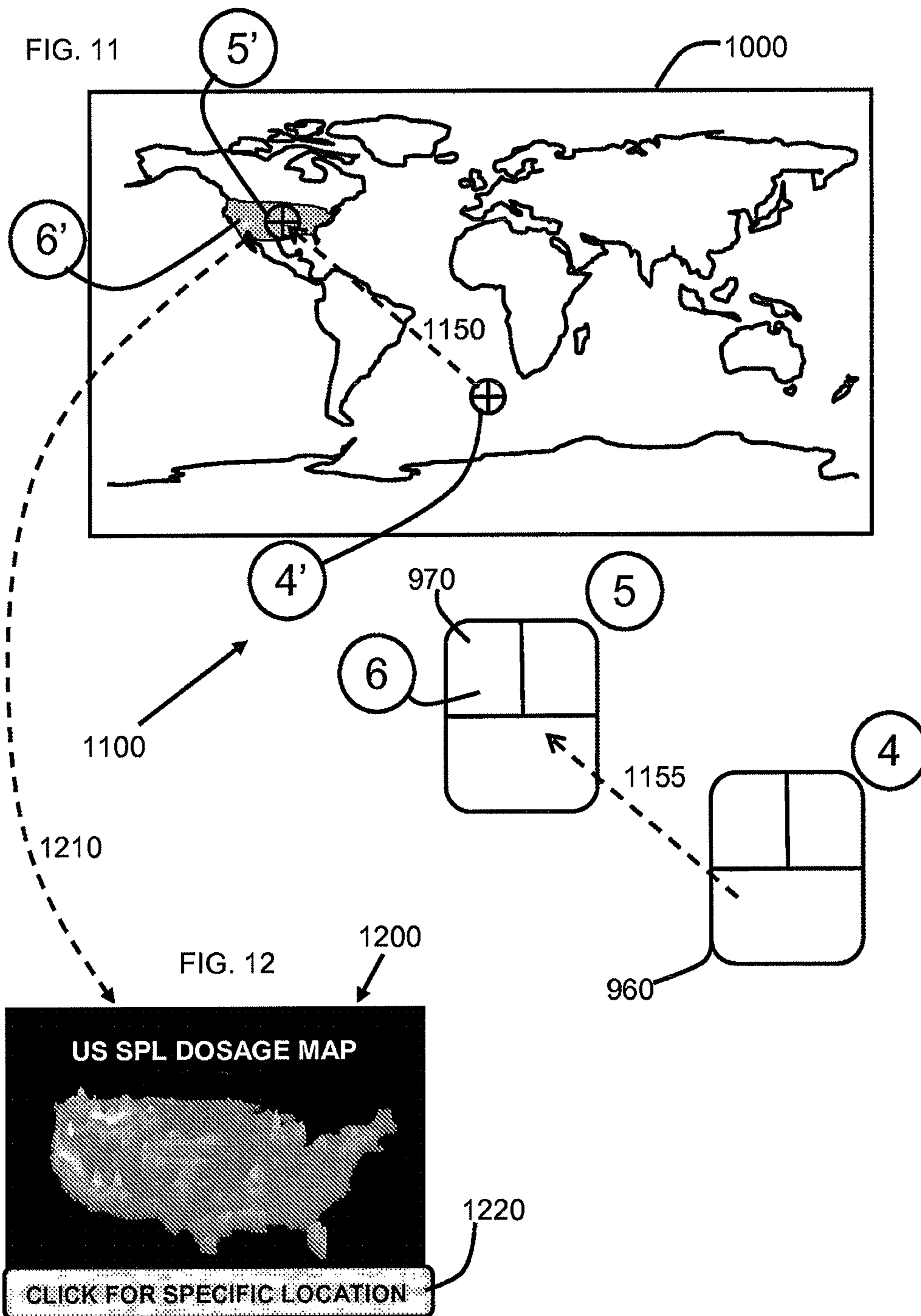

FIG. 12A

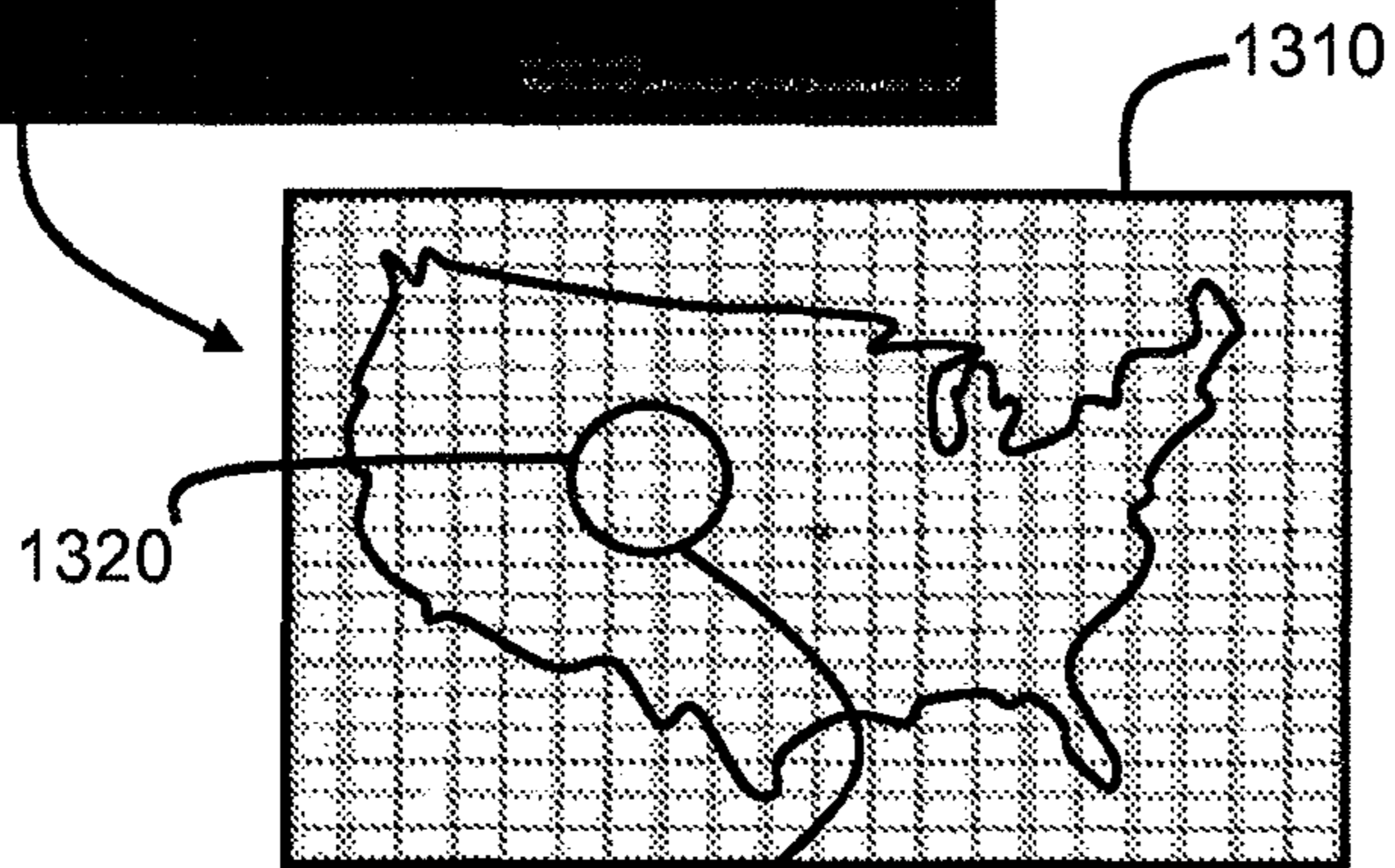
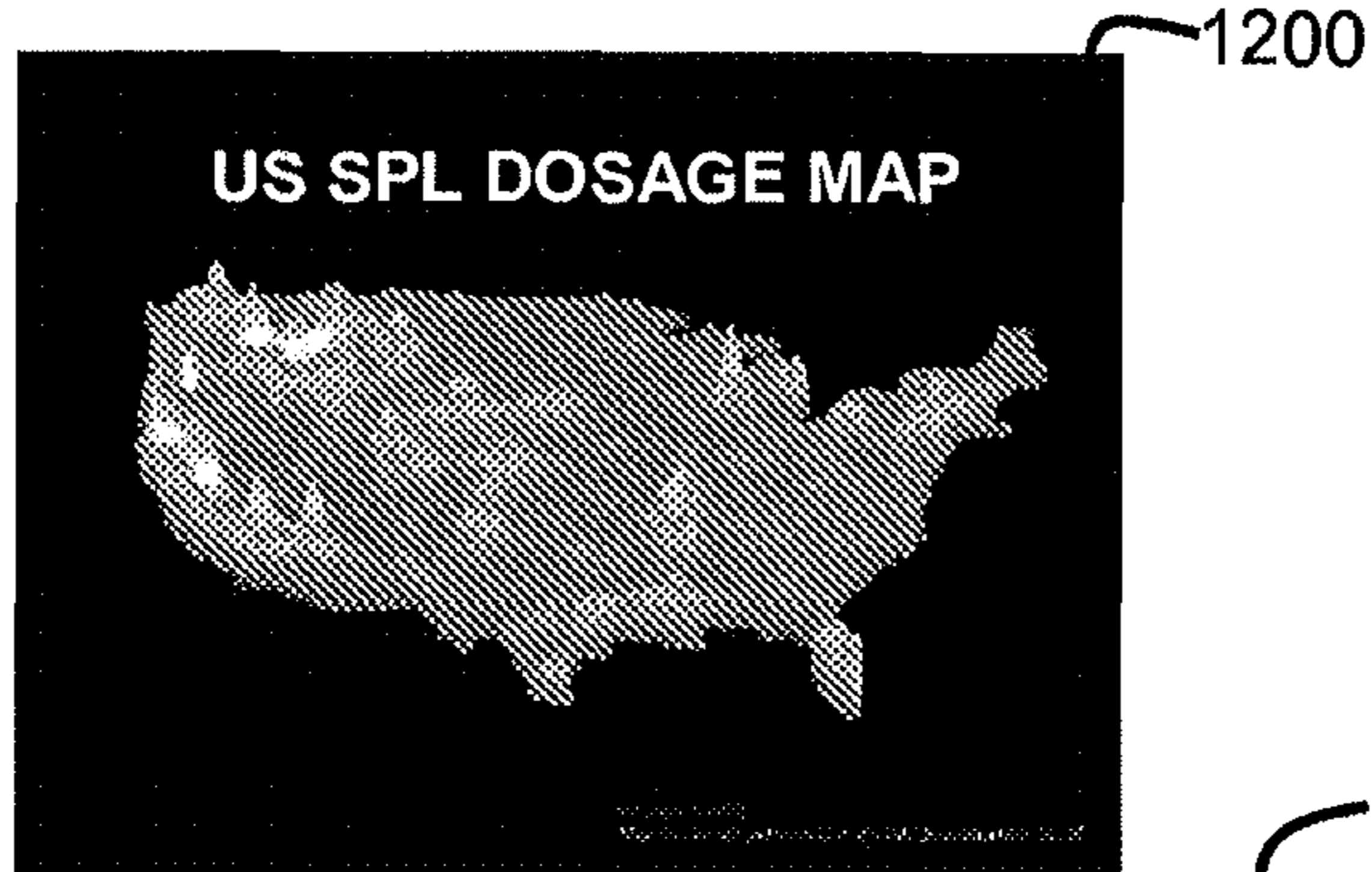

FIG. 12B

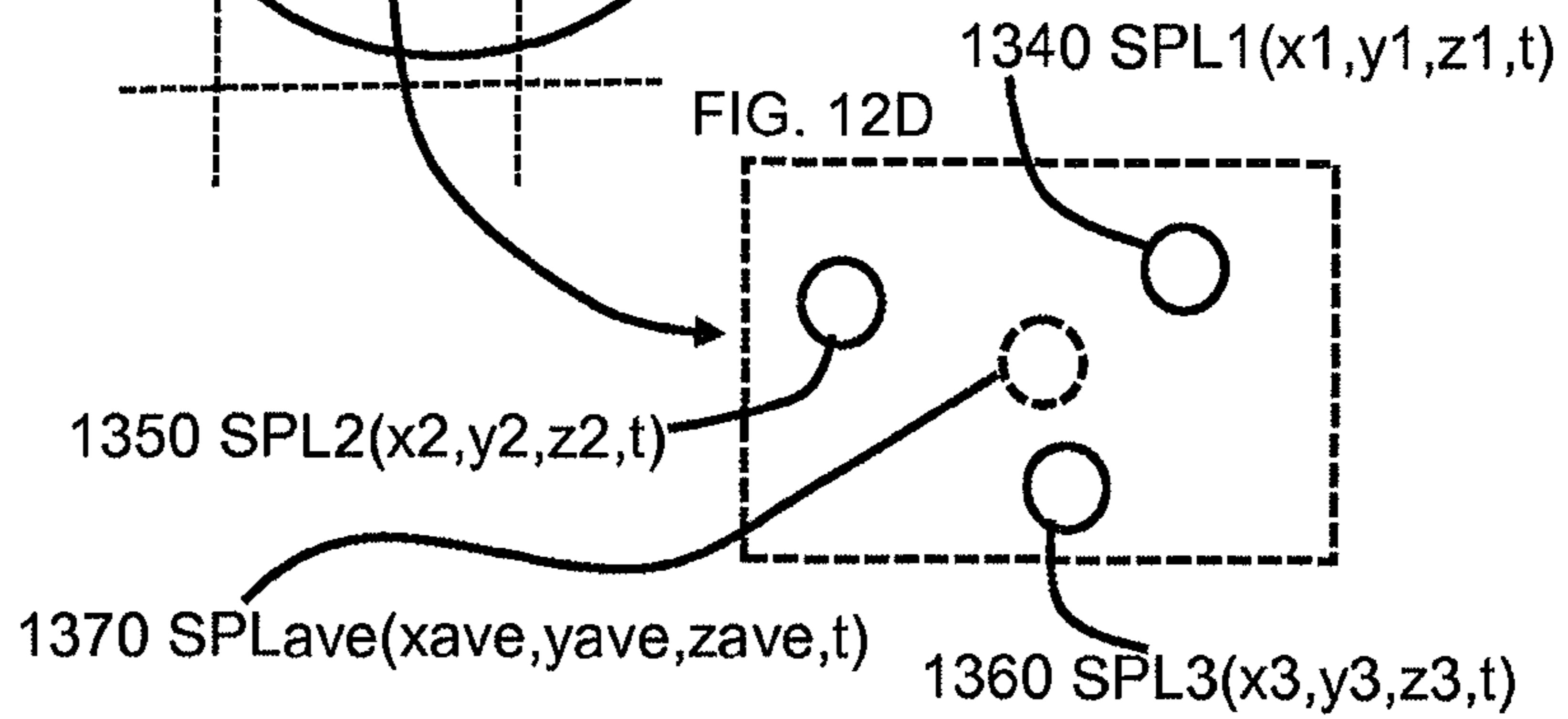
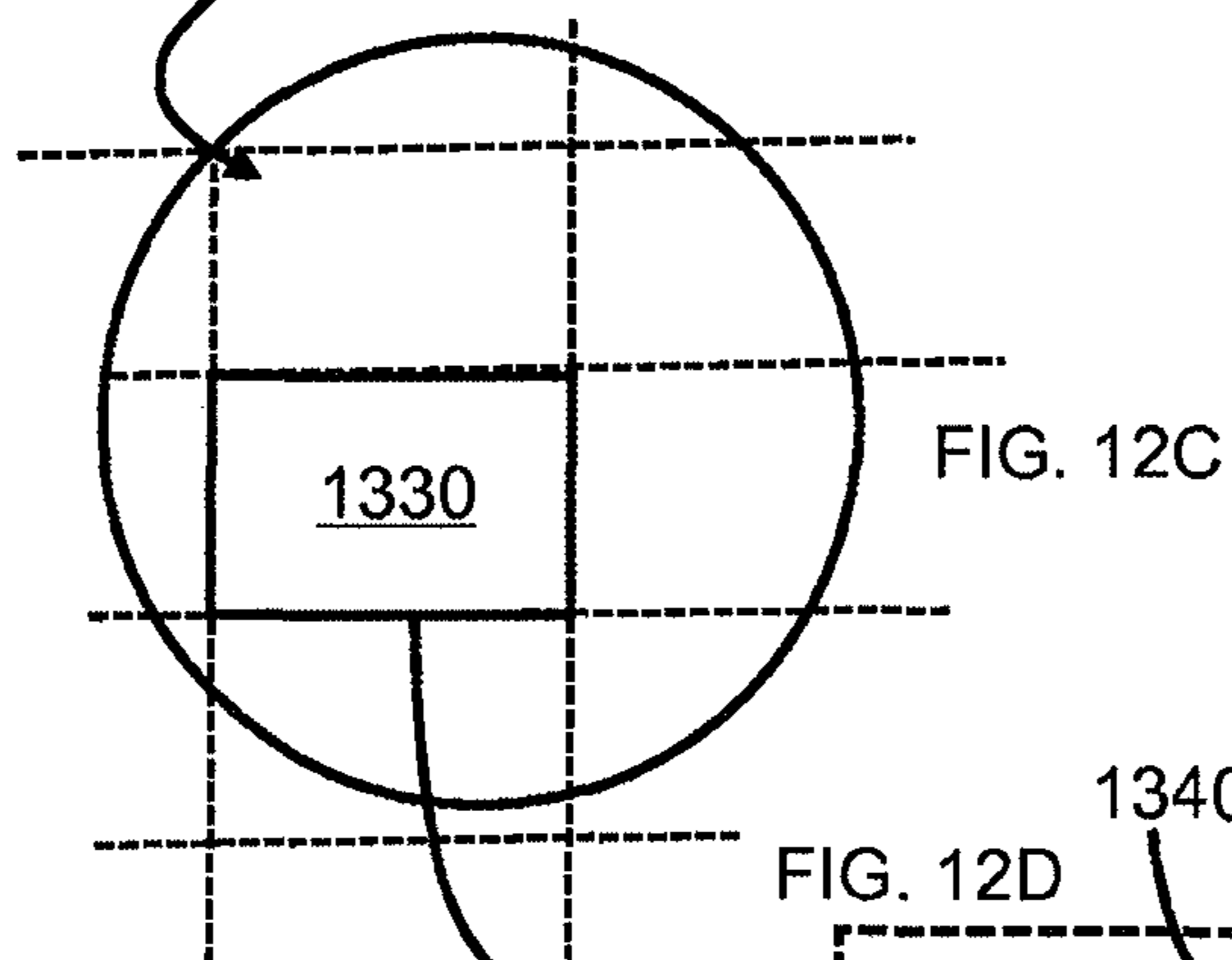

FIG. 13

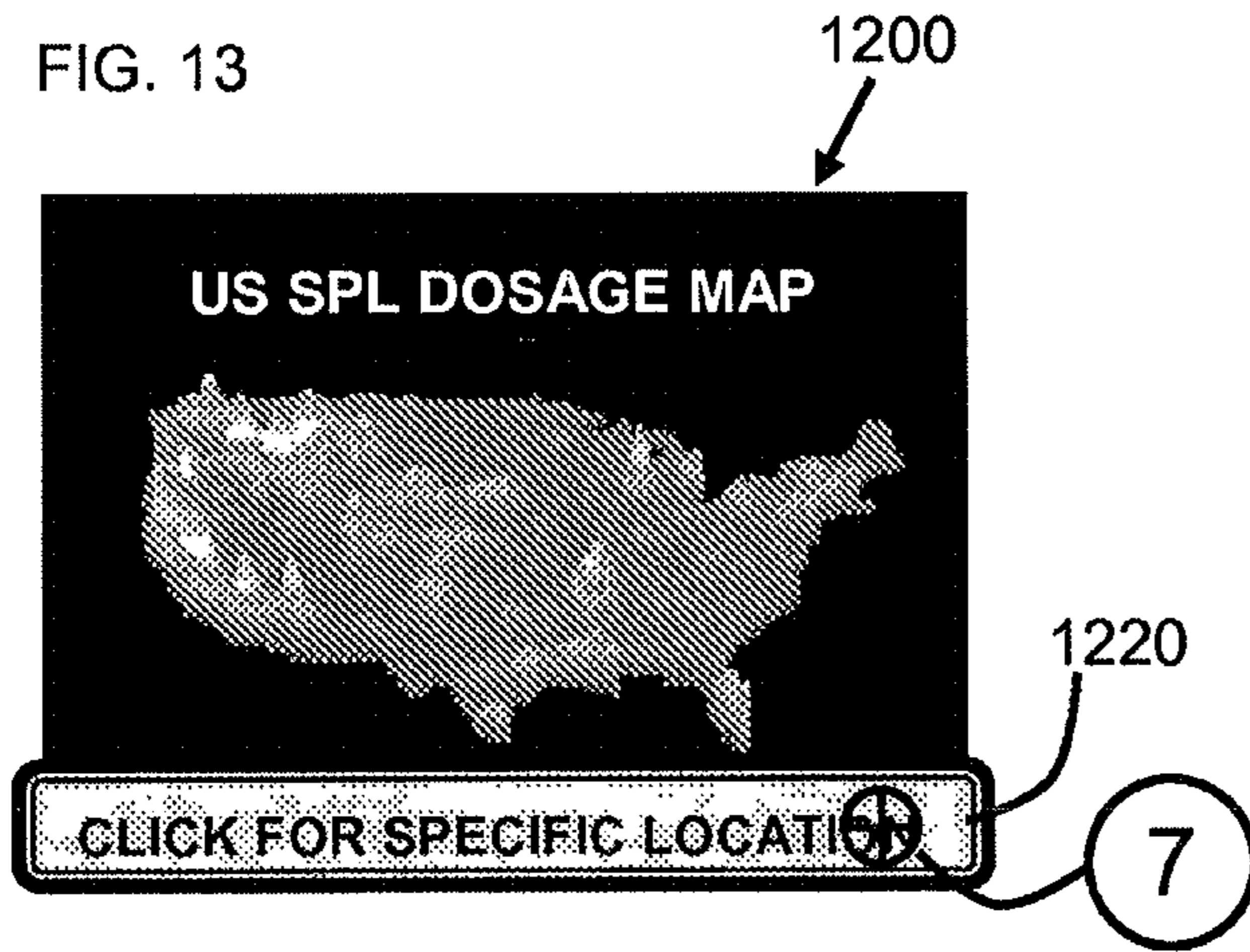

FIG. 14

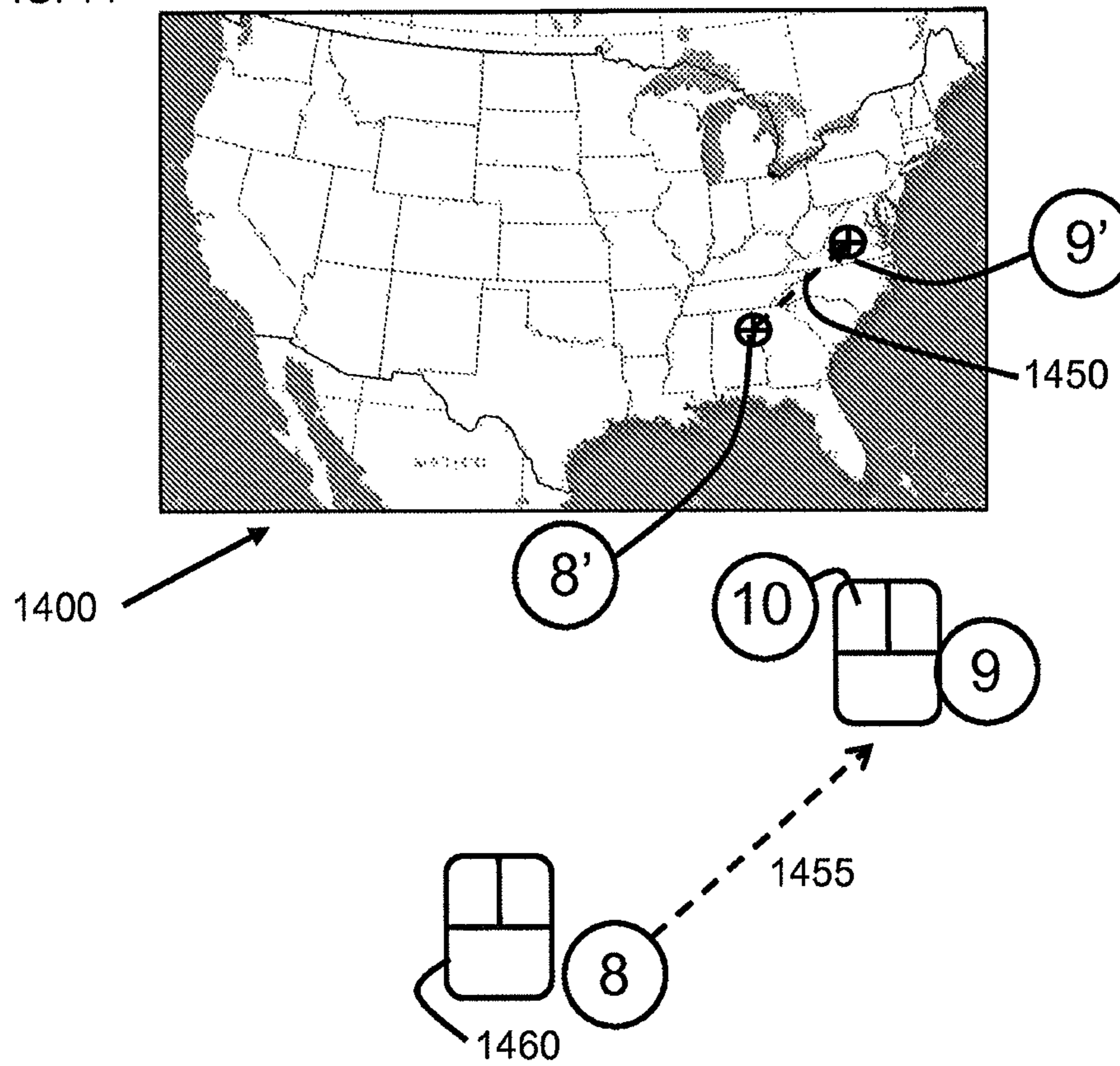

FIG. 15

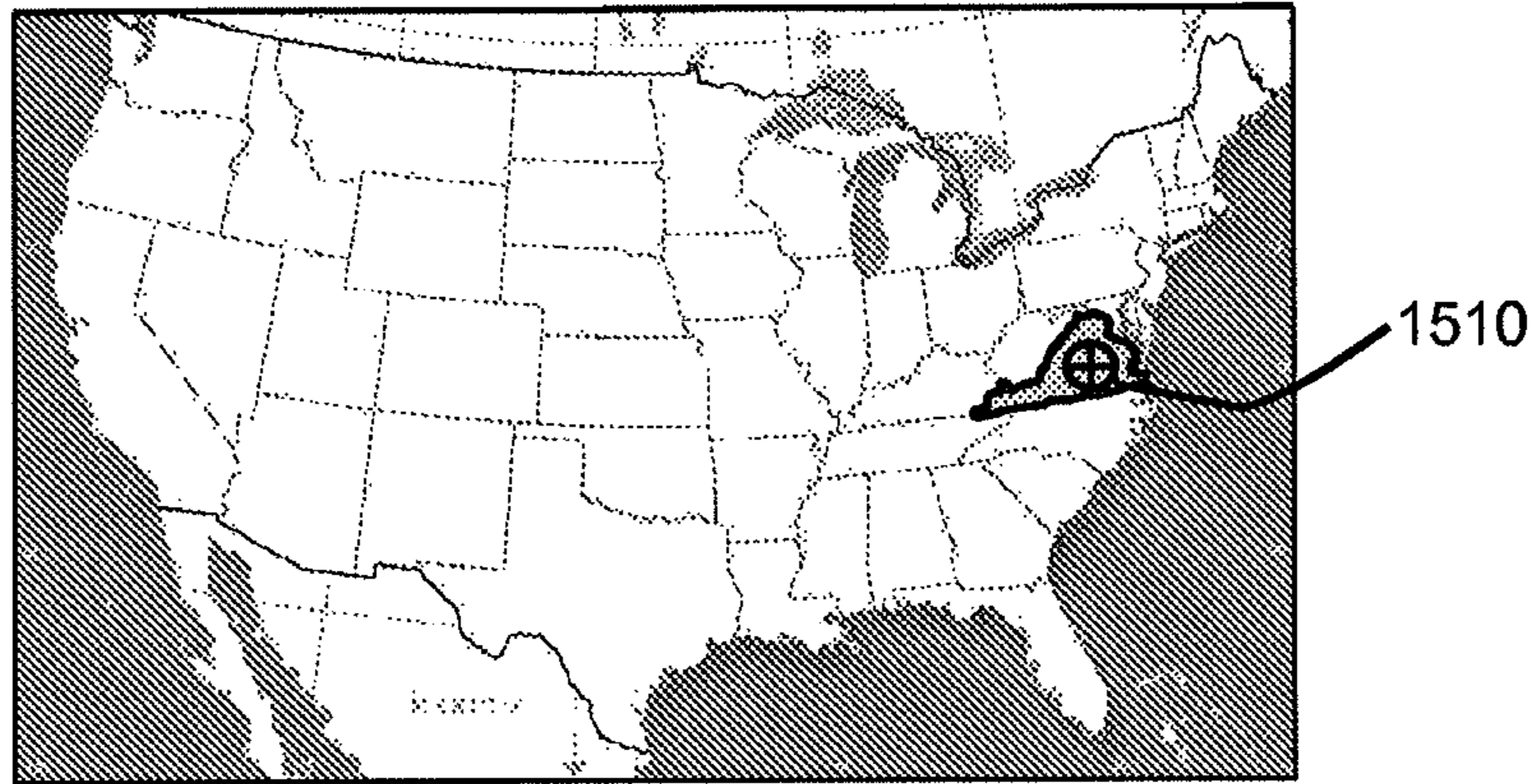

FIG. 16

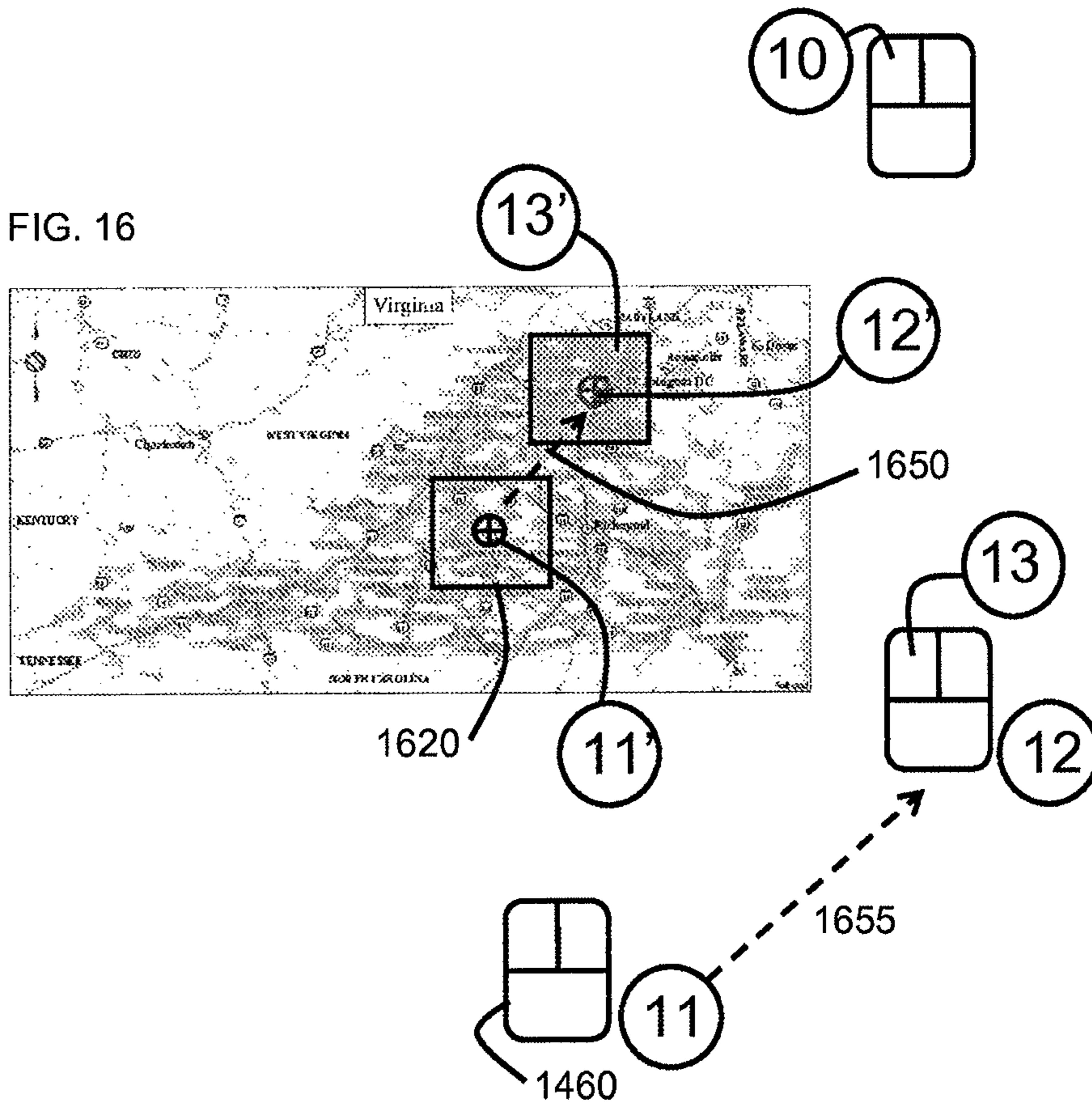

FIG. 17

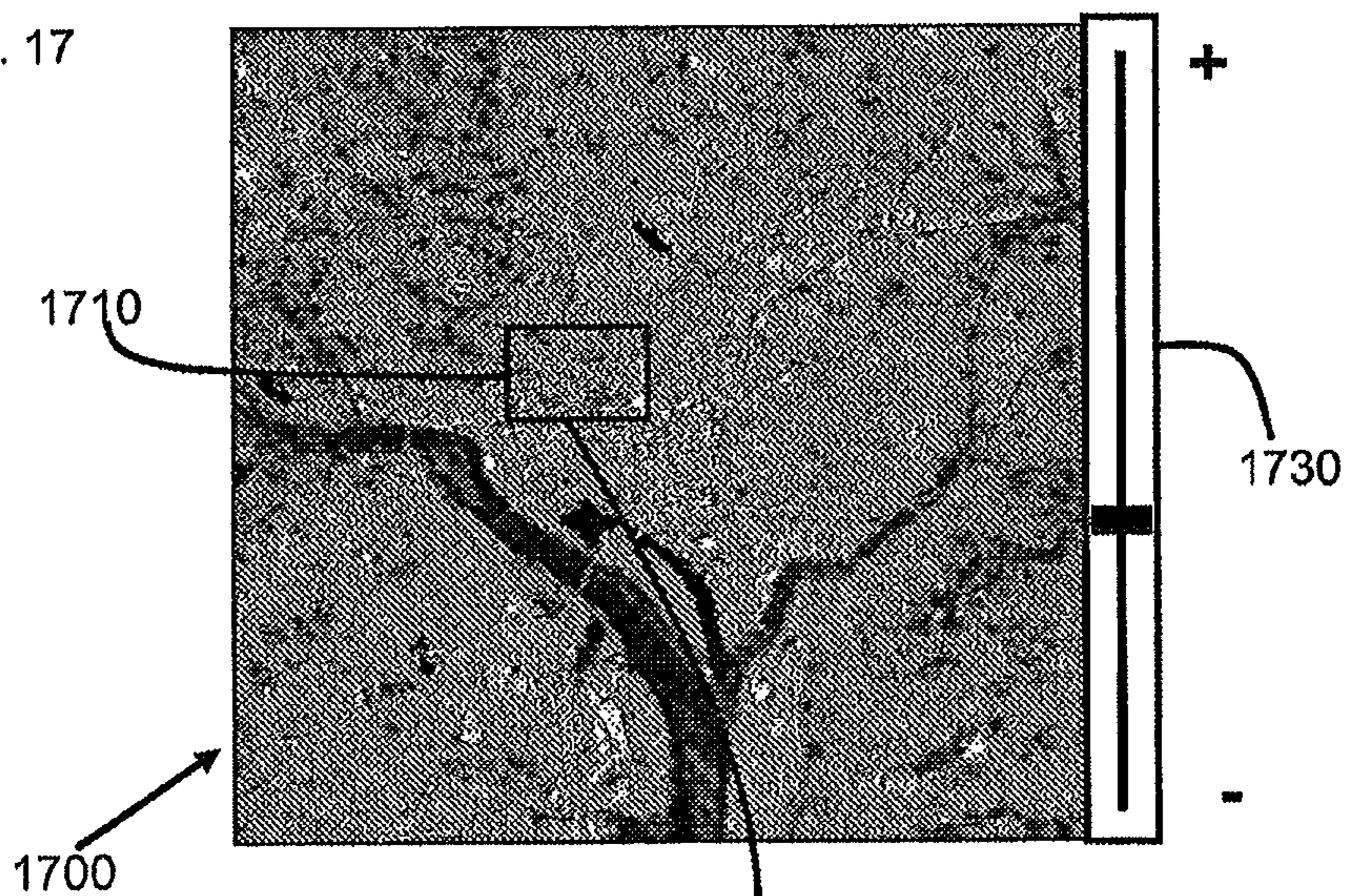

FIG. 18

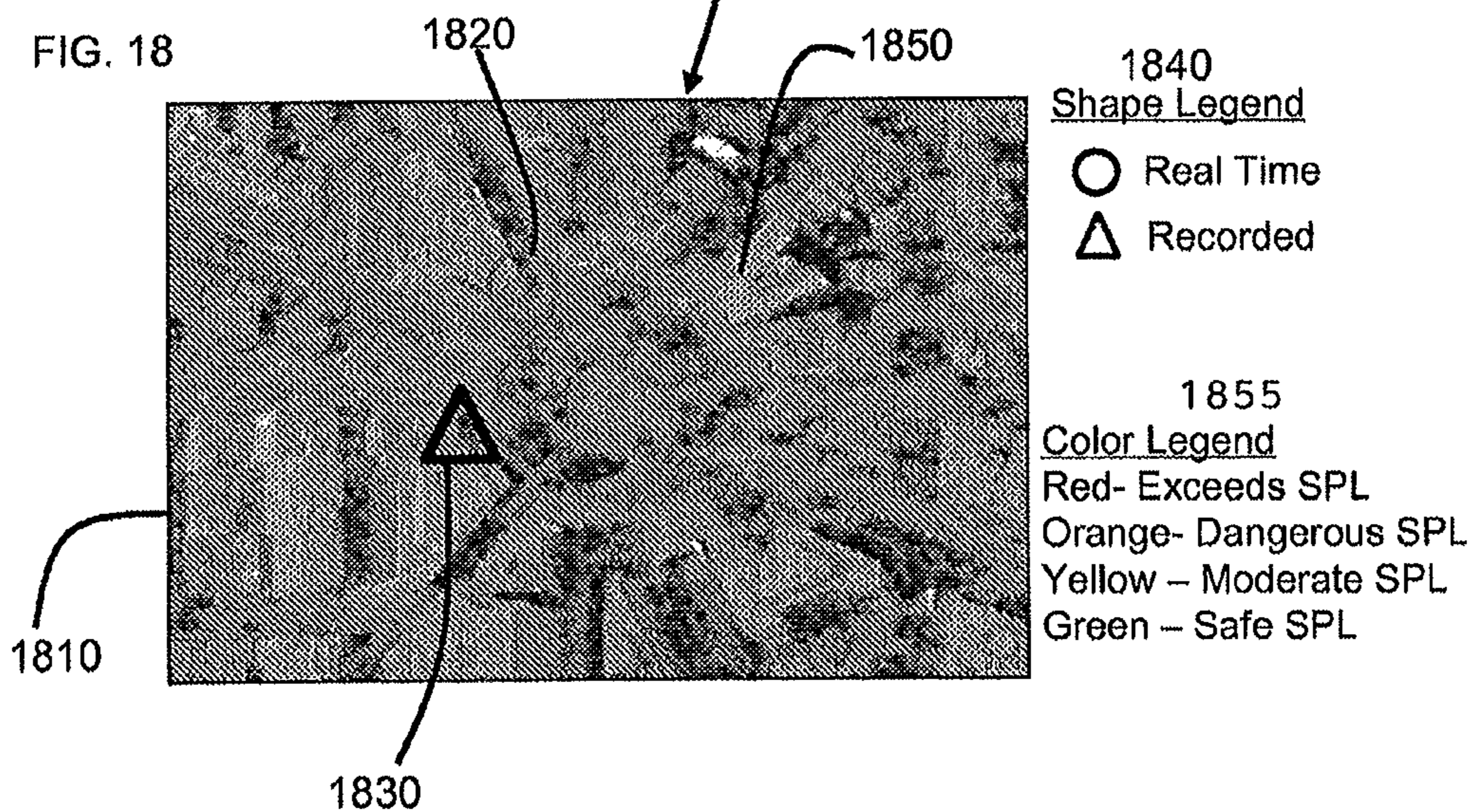

FIG. 19

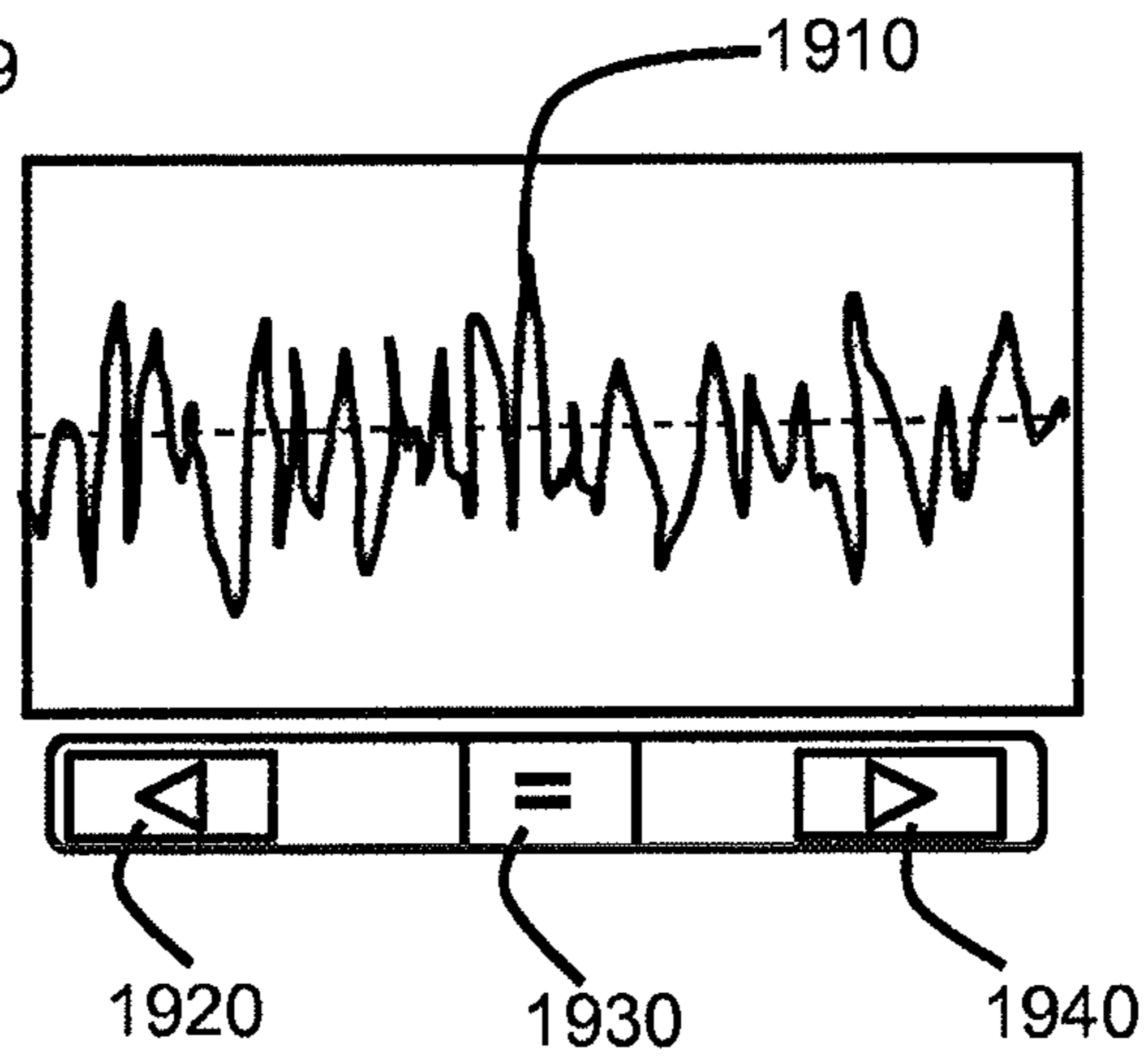
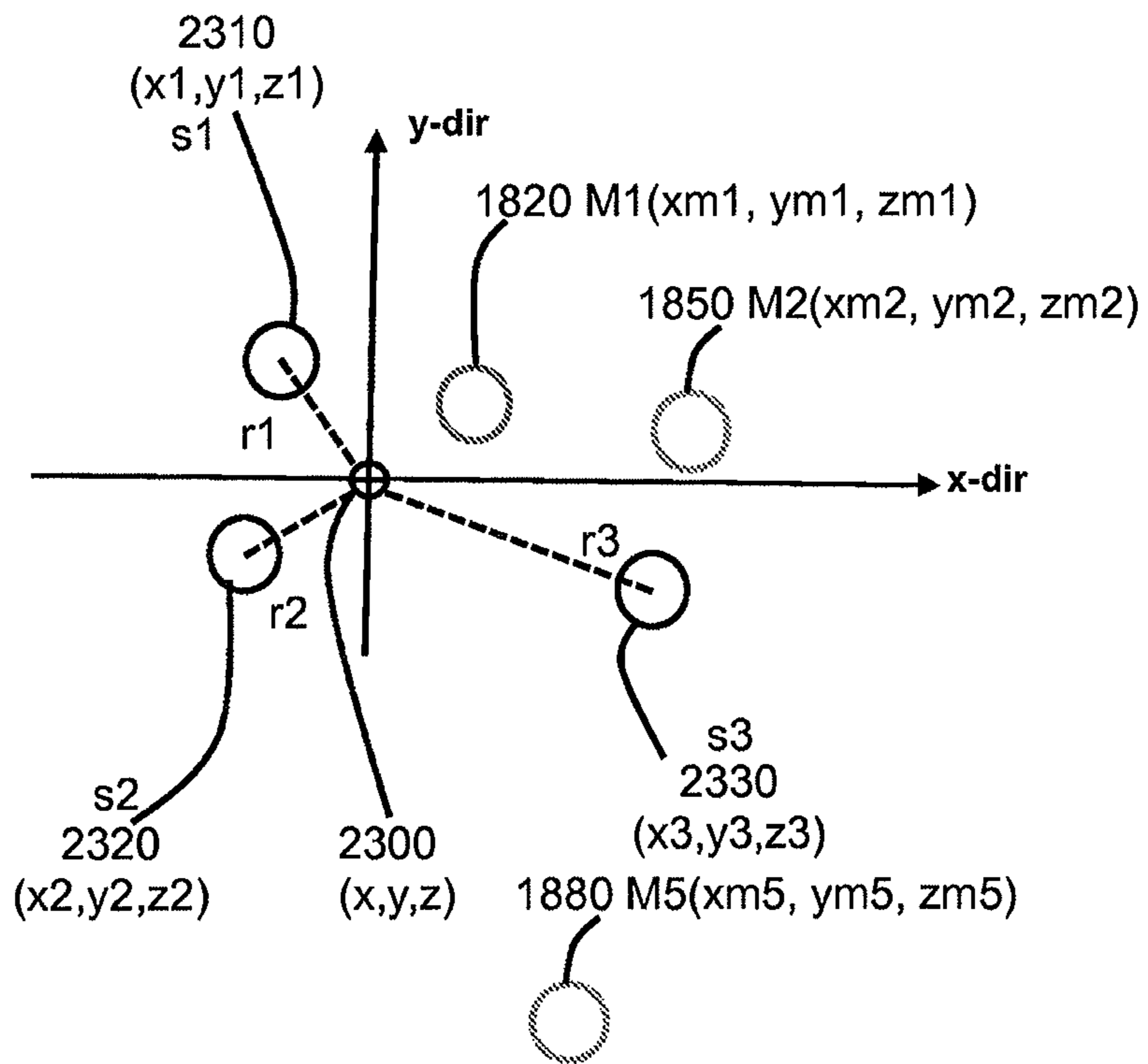

FIG. 20



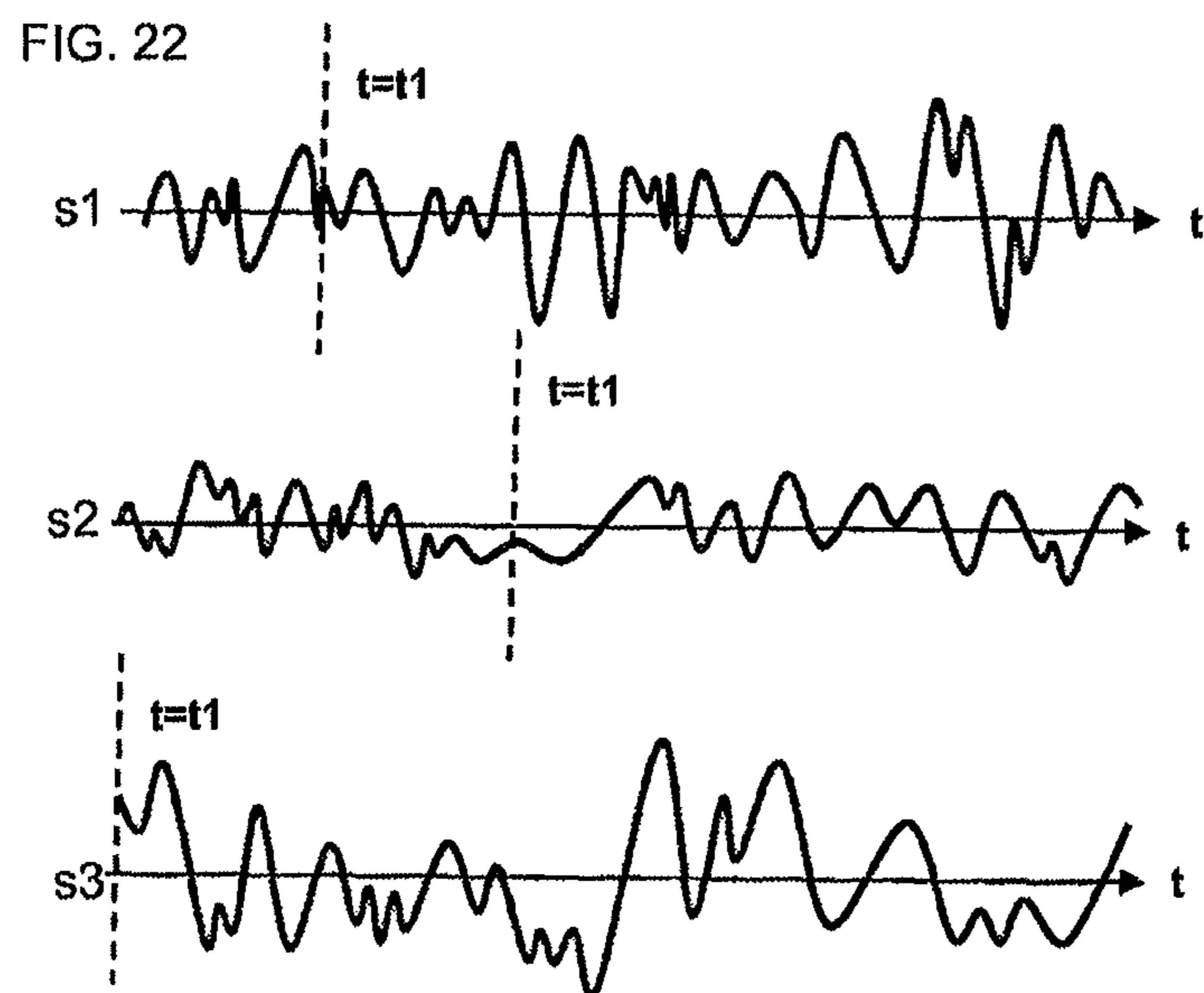
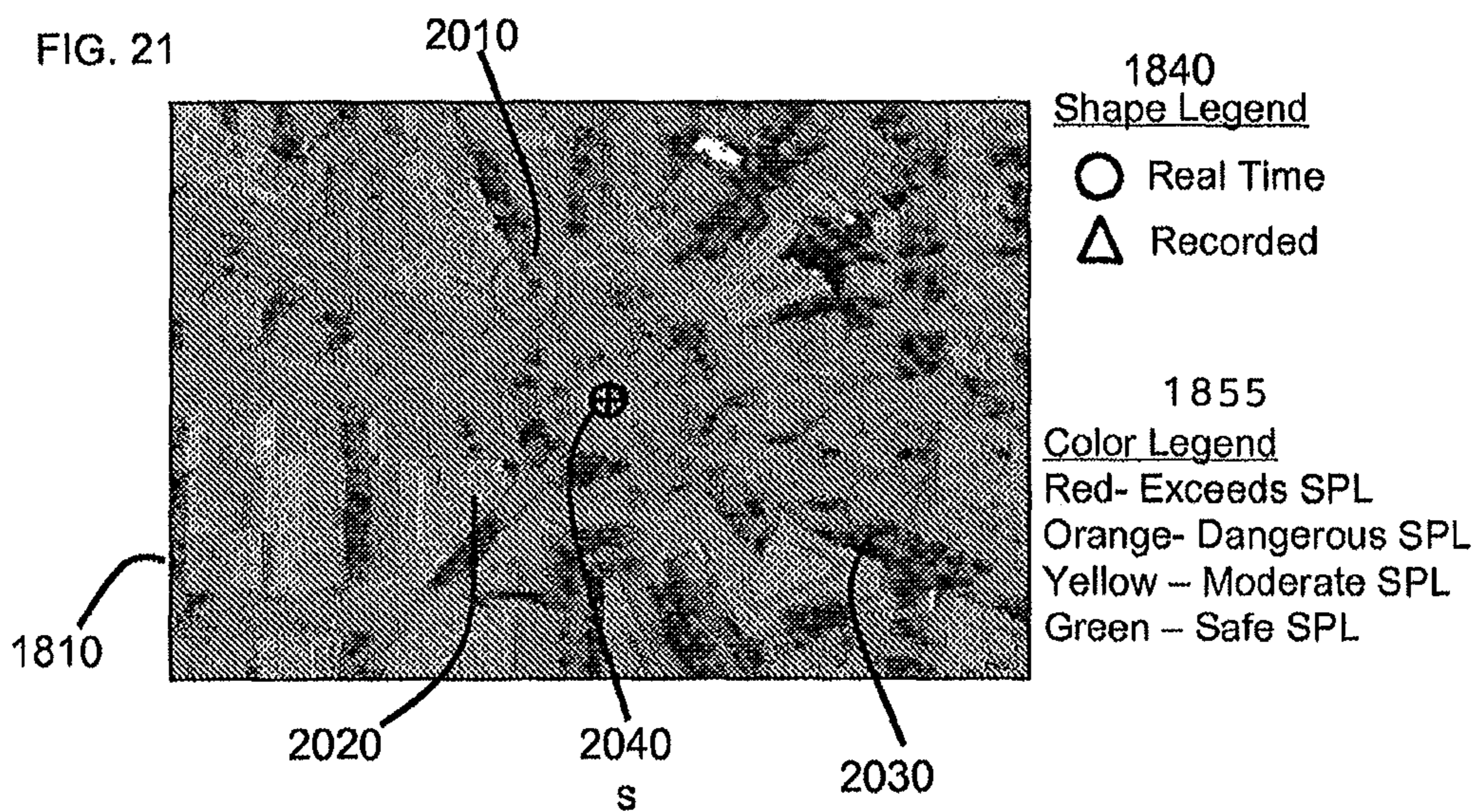

FIG. 23

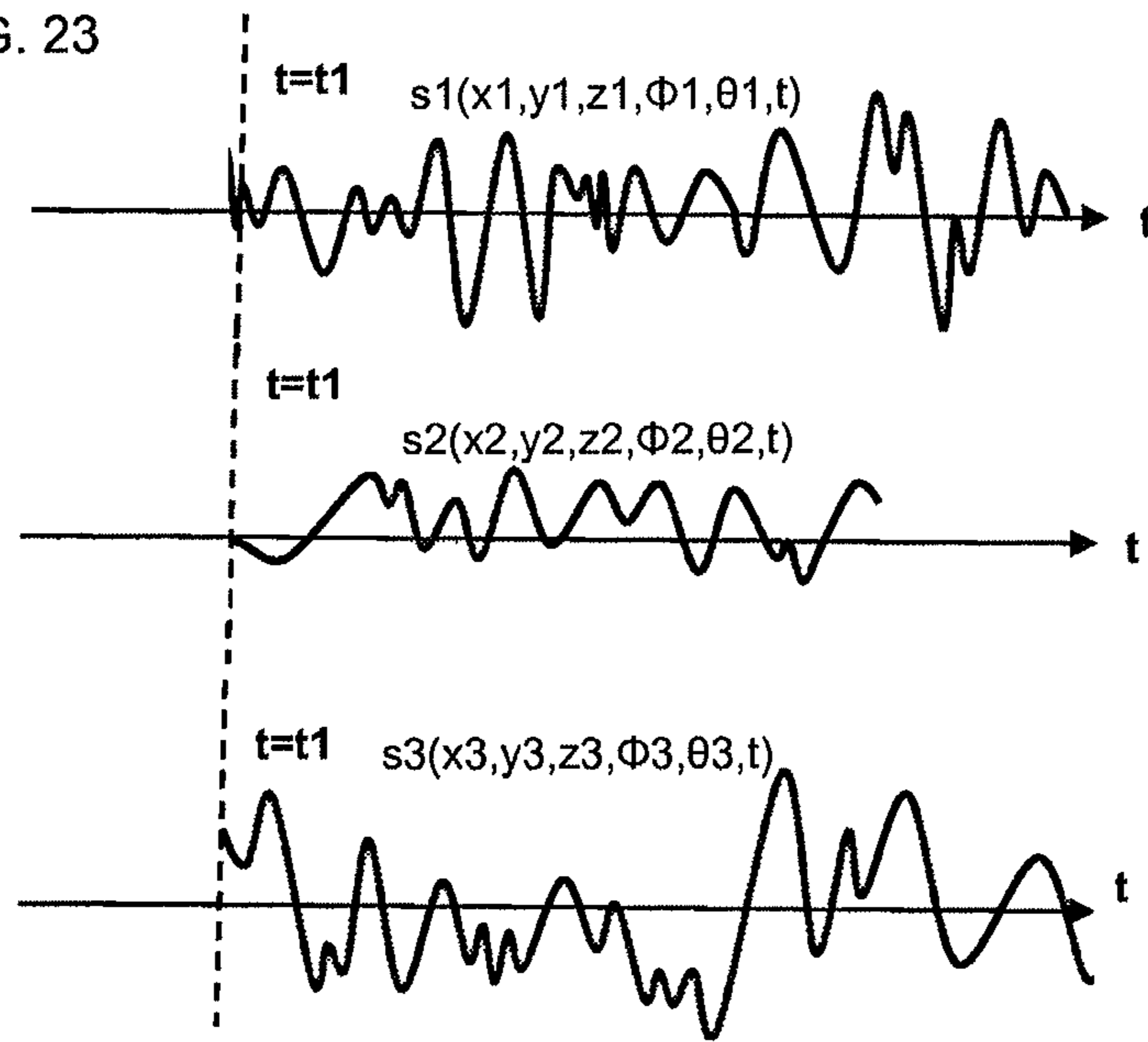
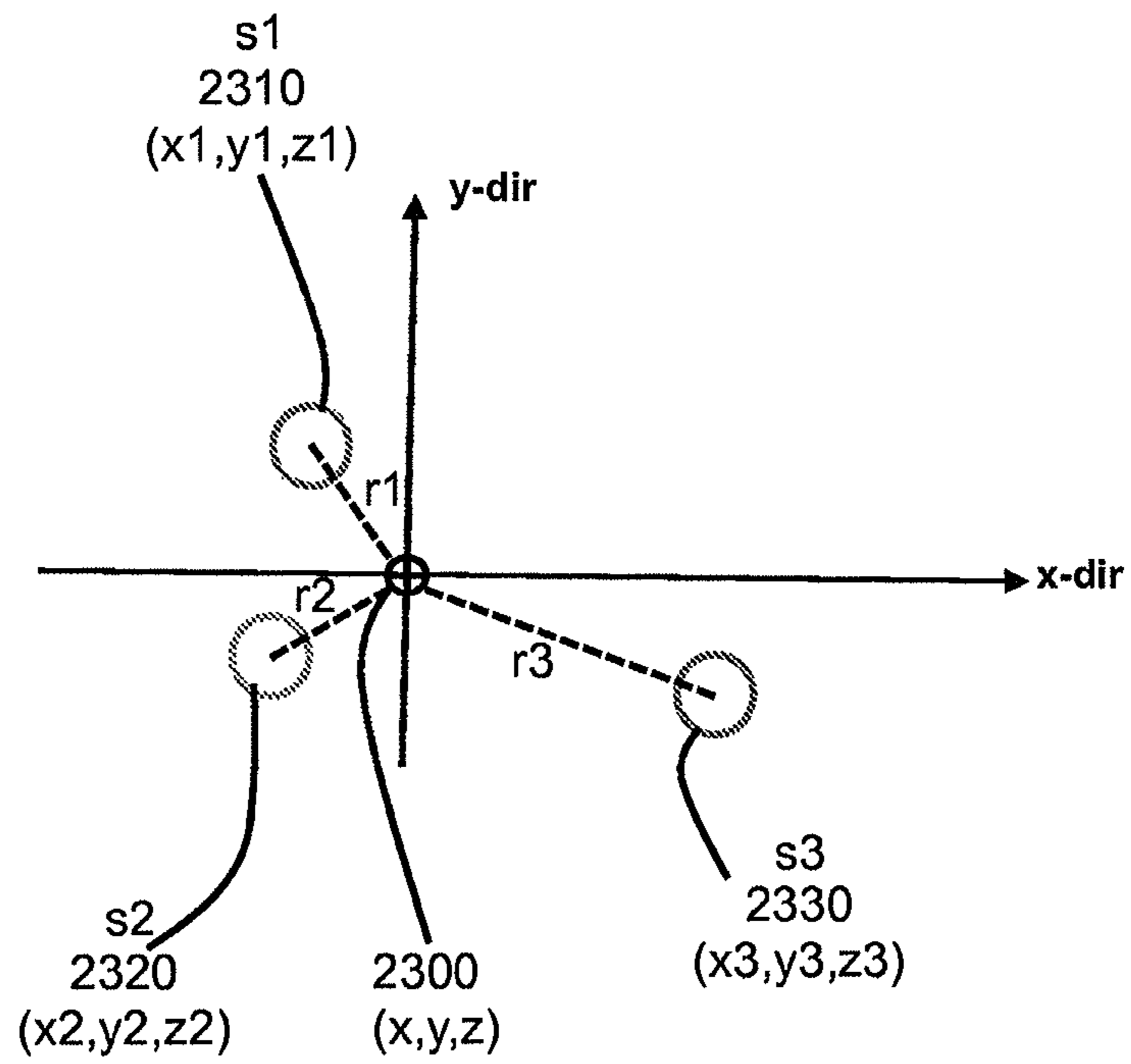
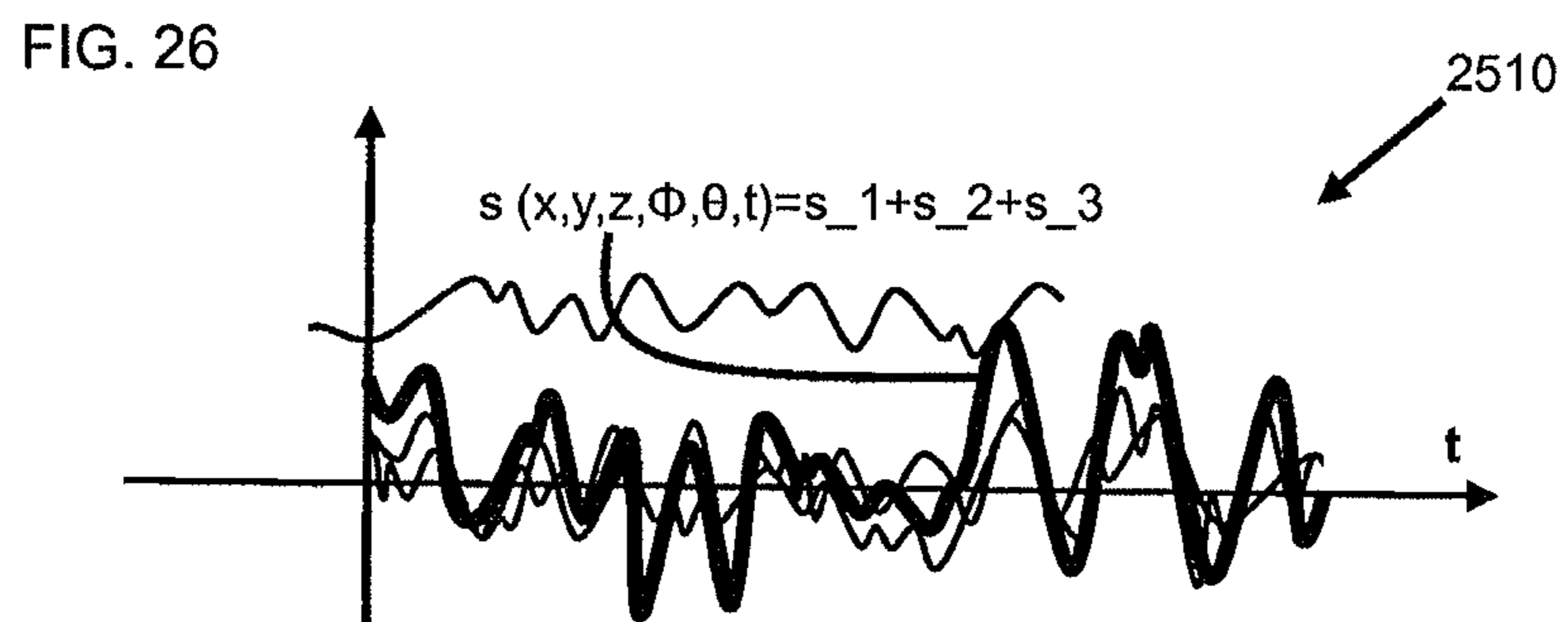
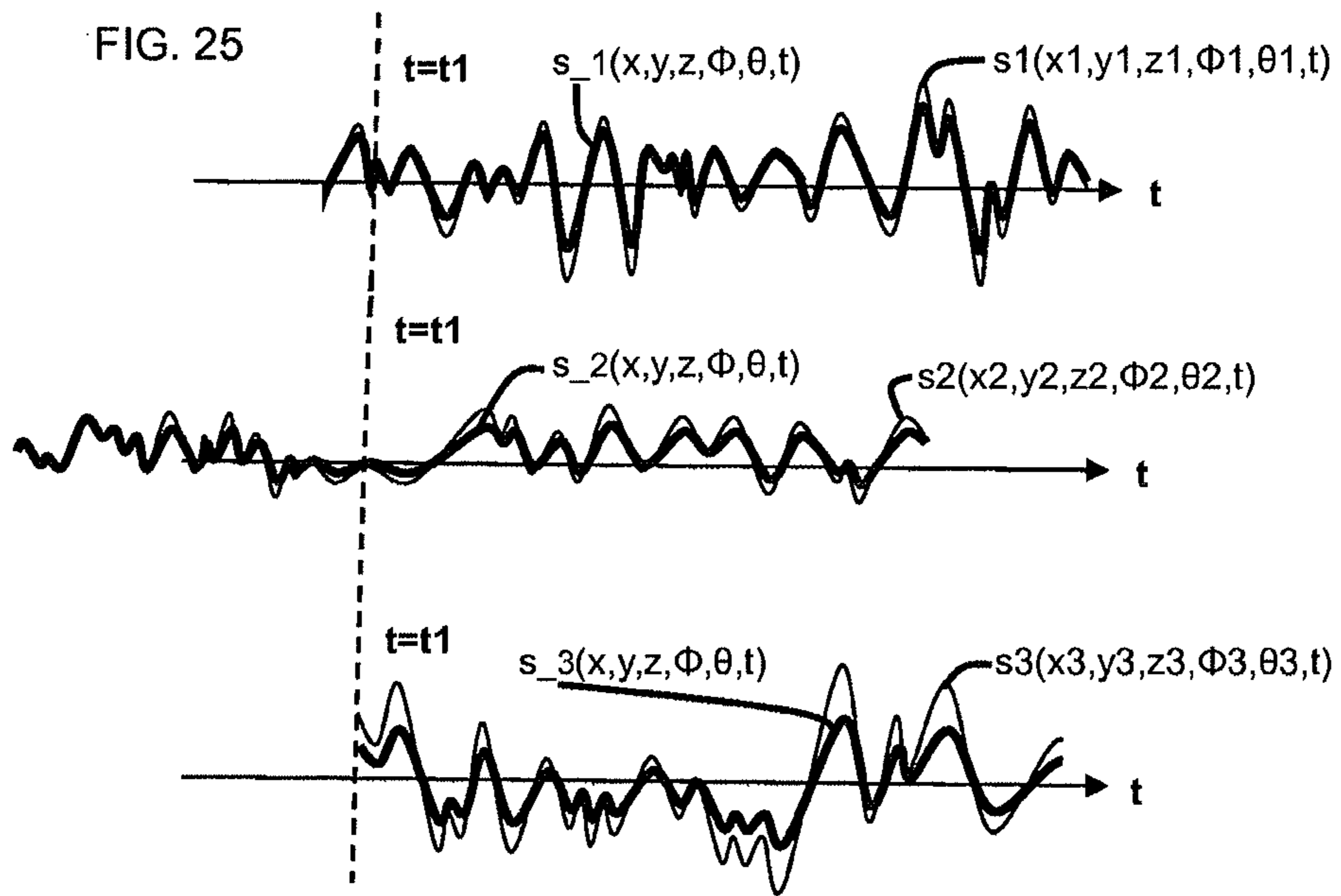

FIG. 24





METHOD AND SYSTEM FOR SOUND MONITORING OVER A NETWORK

CROSS-REFERENCE TO RELATED APPLICATIONS

This application is a Divisional of U.S. application Ser. No. 12/555,570, filed 8 Sep. 2009, which claims the benefit of U.S. provisional patent application No. 61/096,128 filed 11 Sep. 2008. The disclosure of which is incorporated herein by reference in its entirety.

FIELD OF THE INVENTION

The present invention relates to audio content management, and more particularly to sound pressure measurements using mobile devices for creating a database of sounds.

BACKGROUND

The ubiquity of portable electronic devices and mobile communication devices has increased dramatically in recent years. Mobile communication devices such as cell phones, portable media players, personal digital assistants (PDAs) are capable of establishing multimedia communication with other communication devices over landline networks, cellular networks, and, recently, wide local area networks (WLANs). Such devices are capable of distributing various forms of media to a general audience, such as digital multi-media files.

Images of the world have been shared and can be displayed with geographic and temporal tagging. Acoustically however the world has not been likewise mapped. Additionally the sonic toxicity of regions has not been mapped.

SUMMARY

People generally carry their mobile devices around with them everywhere in various environmental settings. In accordance with one embodiment, the mobile device can be used for capturing day to day, significant, or unusual sounds that occur. The various sounds can be collected and stored in a database to provide significant historical, scientific, and social benefit.

At least one exemplary embodiment is directed to a method of using a mobile device comprising the steps of: receiving acoustic information from a microphone of a mobile device; converting a signal from the microphone corresponding to the acoustic information to a digital signal; configuring audio processing of the acoustic information; calculating a sound pressure level from the digital signal; and providing metadata corresponding to the sound pressure level including time information and geographic information for identifying when and where the sound pressure level measurement was taken.

At least one exemplary embodiment is directed to a mobile device for measuring sound pressure levels comprising: a microphone; audio processing circuitry coupled to the microphone; and a processor operatively connected to the audio processing circuitry and microphone where the audio processing circuitry is bypassed when taking a sound pressure level measurement.

Embodiments of the invention are directed to a method and system for sound monitoring, measuring, reporting, and providing over a network using mobile devices. Sound

reports can be generated that associate sound levels with a time and a location. The sound reports can then be shared with other network users.

BRIEF DESCRIPTION OF THE DRAWINGS

Exemplary embodiments of present invention will become more fully understood from the detailed description and the accompanying drawings, wherein:

FIG. 1 illustrates a mobile communication environment; FIG. 1A illustrates an example of a data packet that can be sent via a mobile device in accordance with at least one exemplary embodiment;

FIG. 2 illustrates a multimedia device in accordance with at least one exemplary embodiment;

FIG. 3 illustrates an audio capture interface in accordance with at least one exemplary embodiment;

FIG. 4 illustrates a block diagram of a front end processor configuration in accordance with at least one exemplary embodiment;

FIG. 5 illustrates a directional plot of a microphone pickup in accordance with at least one exemplary embodiment;

FIG. 6 illustrates a block diagram of a mobile communication device in accordance with at least one exemplary embodiment;

FIGS. 7a-c illustrates a trigger event for measuring a sound pressure level in accordance with at least one exemplary embodiment;

FIG. 8 illustrates a method for sound monitoring, measuring, and reporting over a network using mobile devices in accordance with at least one exemplary embodiment;

FIG. 9 illustrates a simplified GUI that one can use to access sonic landscapes;

FIG. 10 illustrates a world map GUI in accordance with at least one exemplary embodiment;

FIG. 11 illustrates a user selecting a country using the world GUI in accordance with at least one exemplary embodiment;

FIG. 12 illustrates an SPL dosage contour map in accordance with at least one exemplary embodiment;

FIGS. 12A-12D illustrate the process of calculating an average sound pressure level (SPL) associated with a geographic region and combining average values to obtain pixel related SPL values in accordance with at least one exemplary embodiment;

FIG. 13 illustrates a user selecting a location option according to at least one exemplary embodiment;

FIG. 14 illustrates a location GUI used to select a map location in accordance with at least one exemplary embodiment;

FIG. 15 illustrates a GUI in accordance with at least one exemplary embodiment;

FIG. 16 illustrates a GUI for refining a location selection in accordance with at least one exemplary embodiment;

FIG. 17 illustrates a GUI for selecting a location in a city in accordance with at least one exemplary embodiment;

FIG. 18 illustrates a GUI illustrating various available acoustic signals in accordance with at least one exemplary embodiment;

FIG. 19 illustrates the selection of an acoustic signal to listen to in accordance with at least one exemplary embodiment;

FIG. 20 illustrates a listening locations relation to sound recordings and estimated source locations in accordance with at least one exemplary embodiment;

FIG. 21 illustrates calculated source signals from the available sound recordings in the listening area in accordance with at least one exemplary embodiment;

FIG. 22 illustrates calculated source signals in accordance with at least one exemplary embodiment;

FIG. 23 illustrates time matching the sound sources;

FIG. 24 illustrates the user selected user location and its relation to the calculated source signals in accordance with at least one exemplary embodiment;

FIG. 25 illustrates the intensity varied source signals based on source distances distance from a chosen listening position; and

FIG. 26 illustrates a source signal for the listening location, which includes the modeled signals from the available source signals in accordance with at least one exemplary embodiment.

DETAILED DESCRIPTION

The following description of exemplary embodiment(s) is merely illustrative in nature and is in no way intended to limit the invention, its application, or uses.

Processes, techniques, apparatus, and materials as known by one of ordinary skill in the art may not be discussed in detail but are intended to be part of the enabling description where appropriate. For example specific computer code may not be listed for achieving each of the steps discussed, however one of ordinary skill would be able, without undo experimentation, to write such code given the enabling disclosure herein. Such code is intended to fall within the scope of at least one exemplary embodiment.

Notice that similar reference numerals and letters refer to similar items in the following figures, and thus once an item is defined in one figure, it may not be discussed or further defined in the following figures.

In all of the examples illustrated and discussed herein, any specific values provided, should be interpreted to be illustrative only and non-limiting. Thus, other examples of the exemplary embodiments could have different values.

Referring to FIG. 1, a mobile communication environment 100 is shown. The mobile communication environment 100 can provide wireless connectivity over a radio frequency (RF) communication network or a Wireless Local Area Network (WLAN) between a number of devices simultaneously. Communication within the communication environment 100 can be established using a wireless, wired, and/or fiber optic connection using any suitable protocol (e.g., TCP/IP, HTTP, etc.). In one arrangement, a mobile device 160 can communicate with a base receiver 110 using a standard communication protocol such as CDMA, GSM, or iDEN. The base receiver 110, in turn, can connect the mobile communication device 160 to the Internet 120 over a packet switched link. The Internet 120 can support application services and service layers for providing media or content to the mobile device 160. The mobile device 160 can also connect to other communication devices through the Internet 120 using a wireless communication channel. The mobile device 160 can establish connections with a server 130 on the network and with other mobile devices 170 for exchanging data and information. The server can host application services directly, or over the Internet 120

The mobile device 160 can also connect to the Internet 120 over a WLAN. A WLAN links two or more communication devices using spread spectrum modulation methods. Wireless Local Access Networks (WLANs) can provide wireless access to the mobile communication environment 100 within a local geographical area. WLANs can also

complement loading on a cellular system, so as to increase capacity. WLANs are typically composed of a cluster of Access Points (APs) 104 also known as base stations. The mobile communication device 160 can communicate with other WLAN stations such as the laptop 170 within the base station area 150. In typical WLAN implementations, the physical layer uses a variety of technologies such as 802.11b or 802.11g WLAN technologies, which can be coupled with repeaters to extend the normal communications range (10 s of meters). The physical layer may use infrared, frequency hopping spread spectrum in the 2.4 GHz Band, or direct sequence spread spectrum in the 2.4 GHz Band. The mobile device 160 can send and receive data to the server 130 or other remote servers on the mobile communication environment 100.

The mobile device 160 can be a cell-phone, a personal digital assistant, a portable music player, a laptop computer, or any other suitable communication device. The mobile device 160 and the laptop 170 can be equipped with a transmitter and receiver for communicating with the AP 104 according to the appropriate wireless communication standard. In one embodiment of the present invention, the mobile device 160 is equipped with an IEEE 802.11 compliant wireless medium access control (MAC) chipset for communicating with the AP 104. IEEE 802.11 specifies a wireless local area network (WLAN) standard developed by the Institute of Electrical and Electronic Engineering (IEEE) committee. The standard does not generally specify technology or implementation but provides specifications for the physical (PHY) layer and Media Access Control (MAC) layer. The standard allows for manufacturers of WLAN radio equipment to build interoperable network equipment.

The mobile device 160 can send and receive media to and from other devices within the mobile communication environment 100 over the WLAN connection or the RF connection. In particular, mobile device 160 is adapted for measuring sound pressure levels, as will be disclosed herein below in greater detail. In at least one exemplary embodiment, mobile device 160 automatically measures sound pressure level and sends the measured sound pressure level to a database. Automating the process of collecting acoustic information will allow a global and time continuous database to be generated for mapping noise levels worldwide.

In one example, the mobile device 160 can connect to the server 130 for receiving or transmitting sound pressure levels to a database associated with server 130. The mobile device 160 can transmit and receive data packets containing audio, text, or video from the server 130 through a website hosted on the server 130. In general, the sound pressure level measurement and associated metadata requires only the transmission of a small amount of data. Sending the information can typically be done with little or no noticeable device performance loss to the user of mobile device 160. Alternately, the information can be provided to the database when mobile device 160 is idle thereby having no impact to the user. The server 130 can send media to the mobile device 160 for downloading audio content and associated information. Similarly, the mobile device 160 can communicate with the laptop 170 over a peer-to-peer network for receiving and transmitting audio content.

In at least one exemplary embodiment, mobile device 160 includes a location receiver that utilizes technology such as a GPS (Global Positioning System) receiver that can intercept satellite signals and therefrom determine a location fix of mobile device 160. In an alternate embodiment, location can be determined from a cell phone network. In either embodiment, mobile device 160 is adapted for providing a

5

geocode or geographical location information corresponding to a location (or location over time) and attaching this information to an event such as a recording of acoustic information or measuring a sound pressure level measurement. Similarly, mobile device **160** has an internal clock for providing a time stamp or time information and attaching this information to the event. FIG. 1A illustrates a data packet containing a header, location information, time information, and SPL information.

Referring to FIG. 2, a mobile device **160** for sound monitoring and reporting is shown. The mobile device **160** can include a media display **210** for presenting one or more sound signatures, an interface **220** for capturing and submitting a segment of a media (including at least audio content) and creating a specification to the media, and a processor **230** for reporting the media in accordance with the specification. The term reporting is defined as any process associated with presenting or submitting an audio content of the media at least in whole or part to a system that analyzes the audio content. Audio content can be acoustic sounds captured within the user's environment or downloaded to the mobile device **160** by way of a wireless or wired connection. The process can include capturing a section of audio content or inserting a reference to a section of audio content. Rendering can include segmenting a sound signature from a captured audio recording, media clip, or video, tagging the sound signature with information (e.g., name of the source generating the sound—car horn, location—GPS coordinate, a date, and a sound capture direction). Alone or in combination, the audio content can also be geo-coded with a GPS location and time stamp.

The mobile device **160** can also include a communications unit **240** having a transmit module and receive module for receiving the media (or capturing live audio content via recording by microphone **242**) and presenting the captured media or audio content to the server. The media or audio content may also be presented by mobile device **160** via speaker **244**. The communication unit **240** can support packet data and establish a communication link to one or more media sources, such as the server **130**, for providing a connection to a Universal Resource Indicator (URI), a hypertext transfer protocol (HTTP) address, or an Internet Protocol (IP) address. The processor **230** can be a micro-processor or DSP with associated memory for storing software code instructions that can perform signal processing functions for processing audio signals.

Referring to FIG. 3, the media display **210** and the interface **220** of the mobile device **160** of FIG. 1 are shown in greater detail for one exemplary embodiment. As illustrated, the interface **220** can include an address bar **302** for entering an address to upload the audio content, and a selector panel **217** for capturing and editing the audio content. The media display **210** can present the captured audio content in an audio format (shown) or video format (not shown). The selector **217** can include one or more compositional tools (**314-320**), or authoring tools, for editing the audio content. For example, the selector **217** can include an audio capture button **314**, an end audio capture button **316**, a save/insert audio content button **318**, and a pause button **320**. The save/insert button **318** can be used to capture an acoustic sound signal in the environment or an audio signal from a media source.

The interface **220** can also include a timer **312** for displaying a time of the audio content in the media. The timer **312** can include options for adjusting the media time resolution. For example, increasing or decreasing the duration of audio content presented on the media display **210**.

6

The timer can provide zooming functionality for adjusting a view of the audio content. For example, audio content **306** can be displayed as a time varying waveform that moves across the media display **210**, as shown. The timer **312** can adjust the length of the audio presented in the media display **210**. The timer **312** can also provide an estimate of a time length of an audio clip or video clip by numerically displaying the time. The selector panel **217** can also include a volume selector **313** for adjusting a volume of the audio content **306**.

The media between the start time **311** and the end time **322** is the segmented audio content **399**. The timer **312** provides a progress function which allows a user to identify a time line of the segmented audio content. The user can begin capture at the start time **311** by depressing the audio capture button **314**, end capture at the end time **322** (prior to time **333**) by depressing the end audio capture button **316**, and save the audio capture segment by depressing the save/insert button **318**. The saved audio segment **399** can be retrieved at a later time for analysis and review; for instance, to determine if the sound corresponds to any known sounds, such as a car horn, siren, vacuum cleaner.

It should also be noted that the mobile device can open up a voice communication channel to a server **130** and stream the captured audio to the server **130**. The entire audio stream can then be analyzed at the server **130** to determine if any recognized sounds are present in the audio stream. The server **130**, by way of manual or automatic intervention, can then send a message back to the mobile device **100** identifying the sounds recognized in the audio stream. For instance, the mobile device display can audibly state the recognized sound ("car horn detected") and/or present a text message for the recognized sound (e.g., car horn identified).

As one example, the user can enter in a Universal Resource Indicator (URI), a hypertext transfer protocol (HTTP) address, or an Internet Protocol (IP) address into the address bar **302** to send the audio content. The audio content can also be audio files, video files, or text clips that are downloaded over the air, instead of being captured in the user's acoustical environment. Embodiments are not limited to capturing audio content or audio content segments from only live recordings, but also other media received by the mobile device **160**. Other media sources can be identified (peer to peer, ad-hoc) for providing audio segments and audio content. For instance, the user may receive a captured audio waveform from another user in their local vicinity by way of a wi-fi system.

Alternately, the entire process of capturing audio content, for example sound pressure level measurements can be automated such that minimal human intervention is required. In general, automating the capture and sending process would be more reliable, provide more diversity of audio content, and could be collected globally at all times of the day. In at least one exemplary embodiment, mobile device **160** includes a cyclical buffer for storing acoustic information received from a microphone **242** of mobile device **160**. The buffer can be continuously over written with new information so it acts as short-term storage of audio content.

A trigger event is an event that initiates the collection of audio content or the measurement of sound pressure level that is sent to server **130** (or an associated database for storage). Examples of trigger events for mobile device **160** to collect audio content are the detection of a sound similar to a sound signature, a time window, geographic location, sound pressure level, and sensor data (biological, acceleration/velocity, odor, chemical detection, visual, etc.) to name

but a few. For example, the duration of a detected signal can be a trigger event if the signal exceeds a predetermined duration.

The trigger event initiates the sending of audio content in the buffer to server **130**. Alternately, the audio content can be moved to longer term storage than the cyclical buffer for sending at a later time. The audio content can undergo further processing in mobile device **160** using a microprocessor or DSP therein. For example, the sound pressure level can be calculated from the captured audio content. The amount of audio content captured around the trigger event can be varied to ensure the capture of the entire sound signal or be of a fixed time period depending on the requirements. The storing of the audio content or sound pressure levels allows mobile device **160** to send the content at an appropriate time when a communication path is opened between the mobile device **160** and server **130**. The audio content can also be compressed to reduce data transmission requirements.

Other means for transmitting and receiving audio content segments over the Internet are herein contemplated, and are not limited to the address scheme provided. For example, the mobile device **160** can receive media from one or more peers or live audio/video recording sessions through communication ports or interfaces. In one aspect, streaming media can be provided through an open communication connection from the server **130** to the mobile device. The communication path can stay open while packets of data are streamed over the connection with the mobile device **160**. For example, the mobile device **160** can open a socket connection to the server **130** for transmitting or receiving streaming media and processing the data as it is received.

Referring to FIG. **4**, an exemplary front end processor configuration **400** is shown. The configuration **400** can correspond to the audio path line up of audio processing modules for capturing and recording audio content. The modules can exist in hardware or software. The entire configuration **400** is not limited to the order shown and can function in a different order if required. For instance, the Automatic Gain Control (AGC) **406** if in hardware, can precede the A/D **404**. It can also follow the A/D **404** if implemented in software.

As illustrated, an acoustic signal can be captured by the microphone **242** and converted to an analog signal. The microphone **242** can have a specific directional pattern. As an example, one directional pattern **500** is shown in the bode plot of FIG. **5**. Notably, the microphone sensitivity can also affect the frequency dependent sound pressure level. The physical shape of the mobile device and its body size can affect the received sound. The microphone directional pattern, the physical shape of the mobile device, microphone sensitivity, microphone porting, and any baffling is compensated for when calculating sound pressure level.

In at least one exemplary embodiment, the microphone **242** is an omni-directional microphone. Although not shown in FIG. **4**, the microphone **242** can also have an extendable boom to keep the microphone **242** away from the body of the mobile device **160** to permit omni-directional pick-up. Alternately, a motor can actively move the microphone **242** from the body of the device **160** when sound pressure level is measured. Extending the microphone **242** from the body of the mobile device **160** can help mitigate the body from the shadowing of acoustic sounds at high frequencies. The microphone **242** can also include a felt covering to keep dirt out that attenuates the sound. The felt can also affect the microphone polarization and should be compensated for in calculating sound pressure level.

The analog signal can be amplified by the amplifier **402** to increase the dynamic range to match the input range of the analog to digital (A/D) converter **404**. In one arrangement, the A/D converter **404** can be a 13-bit ADC with a dynamic range of 66 dB. Alternatively a 24-bit ADC can be used to have a 132 dB dynamic range. The ADC can also support variable sampling rates, for instance, sampling rates of 8, 16, 32 and 44.1 KHz. The ADC can also be configured to adjust the sampling rate during audio acquisition to permit variable sampling rate conversion.

Upon converting to a digital signal, the automatic gain control **406** can further condition the audio signal to control variations in the gain. The AGC **406** can also include noise suppression, gain shaping, compression, or other aspects of gain control. An equalization module **408** (also referred to herein as equalizer **408**) can equalize the audio signal to compensate for any variations in the audio path configuration and/or to condition the frequency response to fall within a predetermined mask. For instance, mobile device manufacturers generally have a SPL frequency dependent mask for a particular product based on the acoustic porting characteristics or audio components of the mobile device. An optional audio compression module **410** can compress the audio signal for purposes of data reduction (e.g. audio coding, audio compression). A feature extraction module **412** (also referred to herein as feature extractor **412**) can extract one or more salient features from the audio signal. For instance, the feature extractor **412** for voice signals, may extract linear prediction coefficients, mel cepstral coefficients, par cor coefficients, Fourier series coefficients.

The controller **420** (microprocessor or DSP) can selectively enable or disable the various modules in the audio configuration path. For instance, upon a user directive, the controller **420** can bypass one or more of the modules so as to prevent the modules from processing the audio signal. The controller **420** can also retrieve module configuration data from the modules for determining how the audio signal is processed by the module. For instance, the AGC **406** can provide an attack time, a decay time, a compression curve, and other parametric information related to processing the audio signal. In such regard, the controller **420** can then pass this information on to the server **130** with the captured audio content to permit the server **130** to evaluate the original characteristics of the acoustic signal. The parameters and associated enable/disable flags can be stored in a code plug managed by the controller **420** that can be shared with other devices. The code plug also permits customization for operation of the audio processing modules (**402-412**) of the mobile device **160**.

FIG. **6** is a block diagram of a mobile device **600** for measuring and sending sound pressure levels in accordance with an exemplary embodiment. In general, mobile device **600** is designed for communication purposes. Mobile device **600** has a microphone **606** and a speaker (not shown) for providing two-way communication. Microphone **606** is often in a fixed location within a housing of mobile device **600**. Microphone porting **604** acoustically couples microphone **606** for receiving sound external to the housing of mobile device **600**. Microphone porting **604** is often an acoustic channel that connects microphone **606** (located internally in the housing) to an external port. A screen or cover may also be employed at the external port to prevent foreign material from entering into microphone porting **604**. In at least one exemplary embodiment, mobile device **600** can have multiple microphones for averaging sound pressure level measurements. Moreover, people do not always keep their phone out in the open but have them on or in holsters

and pockets. Multiple microphones increase the probability when automatically collecting audio content that an unobstructed microphone is available for receiving the information.

Any change in the sound or signal that occurs due to components of mobile device **600** is accounted for thereby maintaining the integrity of the sound pressure level measurement. Ideally, the signal from microphone **606** exactly represents the sound. Even under the best of conditions this does not occur. For example, depending on the location of microphone **606** on mobile device **600** reflections of an acoustic signal off of the housing can increase or decrease the sound pressure level measurement. In at least one exemplary embodiment, mobile device **600** has a boom microphone that can be extended away from the housing to minimize this issue or has a motorized microphone that extends from the housing when a sound pressure level is measured. The characteristics of microphone directional pattern **602**, microphone porting **604**, amplifier **402**, and device housing as it relates to modifying a received acoustic signal are compensated for when measuring or calculating sound pressure level. Periodic calibration of mobile device **600** against a reference would be beneficial to ensure the accuracy of measurements.

Automatic gain control **406**, equalization **408**, audio compression **410**, and feature extraction **412** comprise circuitry for processing an audio signal in mobile device **600**. In at least one exemplary embodiment, audio processing of the audio signal is bypassed to prevent further modification to the signal. Alternately, audio processing of the signal could be compensated for in the measurement or calculation of the sound pressure level. Having controller **420** disable or turn off audio processing circuitry when sound pressure level measurements are being performed is one form of audio bypassing. Also, the audio signal from microphone **606** can be brought out as an analog signal from amplifier **402** or as a digital signal from A/D converter **404** before any audio processing occurs. The coupling of the analog signal or the digital signal can be controlled via a switch under the control of controller **420**. For example, an analog signal from an output of amplifier **402** or microphone **606** is provided to a dedicated circuit for measuring sound pressure level under the control of controller **420**. Controller **420** enables the circuit for measuring a sound pressure level over a predetermined time period and the result stored in memory **618** for sending to database **614** when a communication path to database **614** is opened.

In at least one exemplary embodiment, the digital signal from A/D converter **404** is provided to circular buffer **616**. Audio processing circuitry is bypassed to minimize modification to the audio signal provided by microphone **606**. Circular buffer **616** is under control of controller **420**. Circular buffer **616** continuously stores a converted digital signal corresponding to acoustic information received by microphone **606**. Circular buffer **616** stores a predetermined amount of acoustic information that overwrites the oldest data with the new incoming data. Characteristics of amplifier **402** including gain are taken into account in the measurement or calculation of sound pressure level.

In general, a user of mobile device **600** can manually enable the device for measuring a sound pressure level. Typically, the measurement will occur over a predetermined time period after the device is enabled for measuring. Audio content in circular buffer **616** corresponding to the predetermined time period of the measurement is transferred from buffer **616** to controller **420** or memory **618**. Controller **420** can process the digital signal and calculate the sound pres-

sure level, attach metadata, and store the SPL, digital signal (if desired), and metadata in memory **618**. The user can further add to the metadata such as the type of sound or other relevant information. Alternately, the digital signal can be stored in memory **618** along with corresponding metadata. Controller **420** can then calculate and store the sound pressure level at a later time.

In at least one exemplary embodiment, mobile device **600** automatically collects sound pressure levels and sends the measured sound levels to database **614** with minimal or no human intervention. A trigger event is an event that initiates the measurement of a sound pressure level. A trigger event using sound pressure level will be used to illustrate this process in the next figure. Examples of events that are used to trigger the collection of a sound pressure level are sound pressure level, time, geographic location, sound signature detection, biological data, acceleration/velocity data, temperature, visual/chroma data, odor (smell), atmospheric data (barometric pressure, wind speed, humidity, etc.), chemical detection, to name but a few.

The digital signal of the acoustic information that triggered the collection of the sound pressure level measurement is identified for being processed by controller **420** or moved from buffer **616** to longer-term memory **618**. It should be noted that the window of time of the acoustic information required for SPL measurement can precede and extend beyond the trigger event. The appropriate time span of the digital signal is retrieved from circular buffer **616** and may include more than one complete downloading from buffer **616** to capture all of the acoustic information for measurement. As mentioned previously, controller **420** can process the digital signal as soon as it is received to calculate the sound pressure level or store the digital signal to memory **618** for processing at a later time.

Metadata is attached to the digital signal (if collected) and the sound pressure level measurement to aid in the identification and classification of the acoustic information. Included with the metadata is time information and geographic position information. The time information or time stamp of when the time line of the digital signal is provided by a clock **608** that is operably coupled to controller **420**. The geographic position information or geocode of the location of mobile device **600** during the digital signal is provided by GPS receiver **612** that is configured operably with data communication system **610** and controller **420**.

In at least one exemplary embodiment, measured sound pressure levels and their associated metadata can be stored in memory **618**. In general, SPL data and metadata will use substantially less memory relative to storing acoustic information. Once the SPL data and metadata is available, controller **420** in cooperation with data communication system **610** can open a communication path to database **614** for uploading the information. Alternately, a queue of SPL data, audio content (if needed), and metadata could be stored in memory **618** over time and mobile device **600** opens a communication path to database **614** and uploads the information at a time when it does not interfere with the user of device **600**.

FIGS. **7a-7c** are related diagrams illustrating the use of sound pressure level as a trigger event for collecting acoustic information in accordance with the exemplary embodiment. FIGS. **7a-7c** relate to a trigger event for mobile device **600** of FIG. **6**. Referring to FIG. **6**, a mobile device **600** is receiving audio information through the microphone **606** of the device. In at least one exemplary embodiment, the acoustic information is stored in buffer **616** of mobile device **600** for analysis. The analysis can include looking for a

trigger event such as sound pressure level. The trigger event could also comprise an AND function with one or more other trigger events to initiate collection of audio content or an OR function that initiates collection of audio content when any one of a variety of trigger events is detected.

Referring to FIG. 7a, a graph of sound pressure level versus time is shown that is measured or calculated by mobile device 600 from the audio content in buffer 616. A trigger event occurs when the sound pressure level of the acoustic information exceeds sound pressure level threshold 706. For example, information on high noise areas is being collected. Setting sound pressure level threshold 706 at 70 dB would collect information in areas having a sound pressure level that could produce hearing loss over a sustained period of time. Collecting a large number of data points would allow the mapping of acoustic information over a three dimensional region and over time. This information would have a variety of uses one of which is identifying when and where a person is exposed to potential harmful sound levels in the city.

At trigger event 702, the sound pressure level of the audio content is equal to or greater than a sound pressure level threshold 706. Trigger event 702 occurs during a time period t_1-t_2 as indicated by the dashed line. Once triggered, the acoustic information, as shown in FIG. 7b, during time period t_1-t_2 is collected for sending to a database. The acoustic information can be immediately processed/sent or stored in memory of the communication device in its entirety or converted to a more compact form, modeled, characterized, and provided with metadata depending on the collection needs. Included in the metadata is the time information (t_1-t_2) and geographic position information associated with when and where the acoustic information was captured. Controller 420 can calculate a sound pressure level measurement from the acoustic information (t_1-t_2) based on the collection need. For example, average or peak sound pressure measurements could be calculated over the entire time period or portions of the time period.

Referring to FIG. 7c, the position of the communication device indicated in x, y, and z coordinates versus time is indicated in the graph provided by GPS receiver 612. The GPS information could also be provided periodically. Interpolation (linear, other) could be used to estimate location versus time. A single geographic location could also be used for brevity depending on need. Thus, the position of the mobile device 600 can be static or moving over time and this information is provided with the collected acoustic information.

Similarly, a second trigger event 704 is illustrated in FIG. 7a. The acoustic signal is equal to or greater than sound pressure level 706 at trigger event 704 during time period t_2-t_3 . The acoustic information, as shown in FIG. 7b is similarly collected and sound pressure level calculated as disclosed hereinabove.

In the example, a trigger event occurs anytime the sound pressure level threshold 706 is exceeded. The trigger event could be modified in other ways. For example, the sound pressure level above threshold 706 for a predetermined time period could be a trigger event or a change in sound pressure level above a predetermined amount could also be a trigger event. Furthermore, the acoustic information collected is not limited to the time period in which the trigger event occurs. The amount of acoustic information collected can be varied based on need. For example, collecting only acoustic information that exceeds sound pressure level threshold 706. Conversely, a trigger event could collect the acoustic information from the previous, current, and next time period

depending on the size of buffer 616. As disclosed previously, the sound pressure level, metadata, and other information could be sent immediately by mobile device 600 or later at a more opportune time to database 614.

Referring to FIG. 8, an exemplary method 800 for sound monitoring and reporting over a network using mobile devices is shown. The method 800 can include more or less than the number of steps shown and is not limited to the order of the steps shown. The method 800 can be implemented by the components of the mobile device shown in FIG. 4.

At step 802, the mobile device monitors acoustic signals in the ambient environment. The mobile device microphone can actively analyze acoustic signals in the environment and begin processing of the acoustic signals upon detection of a trigger event. In at least one exemplary embodiment, mobile device 160 begins buffering the acoustic signals in a step 804 when a trigger event occurs. Alternately, the acoustic signals can already be stored on a cyclical buffer. For instance, the processor can monitor changes in the Sound Pressure Level, and upon detection of a significant change in SPL, begin to save the associated audio signals to memory. The event can also be user initiated, for instance, if the user hears a sound in the environment and then hits the record button on the user interface. It should also be noted that in another embodiment the mobile device can prompt the user to begin recording if a sound signature is detected within the acoustic signal. In this case, the mobile device continually monitors and analyzes the acoustic signal for salient information, such as a warning sound of a siren, in the user's environment.

The trigger event initiates the mobile device 160 to proceed to open a communication channel with the server 130 in a step 806. As previously indicated, the connection can be a voice channel, a data channel, a packet data channel, a wi-fi channel, or any other communication link. In one arrangement, the mobile device 160 can send the captured audio signal directly over the voice channel. For instance, the data can be sent in raw PCM format over the voice channel, or a non-lossy compression format to preserve the original signal characteristics. Upon opening the channel, the mobile device 160 can also send the code-plug information (see FIG. 4) identifying the parameter settings of the audio configuration path line-up.

In step 808, mobile device 160 extracts features from the acoustic signals. For instance, as previously described, the processor 230 can extract mel-cepstral coefficients from the audio signal. The feature extraction also serves to reduce the data size required in representing the audio signal. For instance, 10 ms frames sizes at $f_s=8$ KHz translates to 160 samples and the 10 ms frame size can be represented with as few as 10-14 mel-cepstral coefficients. It should be noted however, that the non-lossy compressions can also be performed on the audio signals to lower the data dimensionality but without compromising reconstructed audio signal integrity. Lossy compression can also be performed on the data to further reduce the data representation size.

Alternately, processor 230 bypasses the audio processing circuitry and calculates the sound pressure level using the bypassed signal from the microphone. The calculation includes compensation for aspects of mobile device 160 such as the microphone characteristics, microphone porting, foreign material coverings, amplifiers, and other audio processing circuitry. Alternately, the microphone signal is coupled to a dedicated circuit for measuring sound pressure level and provided to processor 230 for further processing.

Metadata or tag information is generated and automatically attached with the features or acoustic signals. Included

with the metadata are time information and geographic location information identifying when and where the acoustic signals were collected. The process can also include manually attached tags related to the audio content. The tag can include identifying information such as the type of sound (e.g., car horn, siren, whistle, bell, jack hammer, etc), more information related to the location of the capture (e.g., restaurant name, home address, etc.), a direction of the sound (e.g., moving closer, departing, stationary), and any associated description of the sound (e.g., faint sound, very loud, annoying, pleasant, etc.). At step 810, the mobile device receives the tag information and associates it with the features of the acoustic signal, or alternatively the actual captured audio signal.

At step 812, the mobile device transmits the tags and features (or acoustic signals) to the server 130 over the open communication channel. The acoustic signals and tags can be packaged together or sent separately over the network. In a packet network configuration, the packets can be sent over different hops and received at different times from the server. The server 130 can then reorder the packets based on standard reconstruction techniques.

At step 814, the server 130 analyzes the features and tags (acoustic signal) for sound pressure levels (SPLs) and sound signatures. The server 130 also references the received code-plugin information for determining the parameters of the audio modules. For instance, in assessing the SPL levels from the received audio signals or features, the server takes into account any compression or equalization performed during the sound acquisition. The SPL level can then be compensated for based on the front-end processing (e.g., compression, equalization, automatic gain control, filtering). Alternately, if the sound pressure level is calculated by mobile device 160 it can be received by server 130 and stored with the related metadata without further analysis (other than format and other checks to verify data quality). In this example, substantially less information would have to be transmitted.

During the analysis, the server 130 can also scan the audio signals—reconstructed acoustic signals or extracted features—for sound signatures. A sound signature is a specific sound event such as a car horn, a siren, a whistle. Models of sound signatures can be stored in the form of Gaussian Mixture Models (GMMs), Hidden Markov Models (HMMs), or any other statistical based pattern classifiers. Also, the tags can be parsed to determine if the audio signal contains previously learned sound signatures. For instance, the user may textually identify the uploaded acoustic signal as containing a whistle sound. Accordingly, the server 130 can update the sound signature model of the whistle sound with the new audio content. This further strengthens the models ability to recognize a broad range of whistle sounds. Alternatively, if the server 130 does not contain a model of the tagged sound, the server 130 can train a new model to learn the characteristics of the unknown sound. For instance, if the user tags the sound as a ‘jackhammer sound’ and no models for that sound exist, the server 130 can generate a new model for jackhammers.

Upon detection of a sound signature and SPL levels, the server 130 at step 816 can generate and log a sound analysis report in view of the analysis. The sound analysis report can identify the sound signatures detected, their corresponding SPL levels, and other information such as whether the sound is a threat or the type of sound detected. The report can then be shared with service providers that are interested in data mining the audio content. For example, a restaurant can subscribe to receive audio content ratings for customers

having dined in their restaurant. The audio content ratings can include sound level analysis with associated time stamp and any customer related information. This permits the users and owners of the restaurant to assess the sound quality of the restaurant and allows the owners to monitor user feedback related to their experience at the restaurant.

At step 818, the server transmits the report to the mobile device or subscriber by way of the open communication channel, or other means. At step 820 the mobile device presents the details of the report to the user. Aspects of the report can be presented in a visual or audible format, or a combination thereof. For instance, upon automatically capturing a sound pressure level and transmitting the SPL/related information to the server for analysis, the user of the mobile device can then receive a text message warning that the SPL level could be harmful to the user if sustained over a long period of time or that the user should more accurately assess the sound levels of their ambient environment. The mobile device can also audibly present aspects of the report, for example, a threat level of a detected sound signature, and possible instructions for responding. For instance, if a faint fire alarm signal is detected while the user is dining, the mobile device can audibly state a fire alarm was detected and visually present a map for exiting the restaurant, or facility. Understandably, other means of communicating the report can be contemplated in accordance with the teaching of this invention.

FIG. 9 illustrates a simplified GUI 900 that one can use to access sonic landscapes. The GUI can be programmed (e.g., JAVA, C++) to provide options (e.g., map button 920 for map interaction, and address button 930 for address lookup interaction) for acoustic searching based on several parameters (e.g., location, time, topic (e.g., concerts, lectures, cars, boats, airplanes, war zones, historical), and any other identifying topic by which acoustic signals can be tagged and identified). In the non-limiting example illustrated, GUI 900 has a background panel 910 with two buttons, a map button 920 and an address search button 930. A user interface is also illustrated (e.g., mouse 960), that facilitates selection by a user (e.g., movement of cursor 940, over a button 920 or 930, and the pressing (3) of selection button 970) of the available options. For example if a user wishes to search acoustic signals by selecting areas on a map, the user can move 955, the mouse 960 from position (1) to position (2), which respectively moves 950 the cursor 940 from position (1') to position (2'). The user can then select (e.g., highlighted boundary (3')) the map button 920 by pressing (3) on a button 970 built into the mouse 960. For example on the software side, button 920 can have an “onClick” event (e.g., in C++, . . . void_fastcall TForm1::BitBtnClick(TObject*Sender){ }) associated with opening up 1010 (e.g., C++ ChildForm->Show()) a child form (i.e., a separate GUI, 1000), where a user can position the cursor and highlight and/or select a region of interest.

FIG. 10 illustrates a world map GUI 1000 in accordance with at least one exemplary embodiment. This is a non-limiting example of a world map that can be opened to provide a user the ability to position a cursor and select a region (e.g., country) of interest.

FIG. 11 illustrates 1100 a user selecting a country using the world GUI 1000 in accordance with at least one exemplary embodiment. A user can move (1155) the user interface 960 (e.g., a mouse) from position (4) to position (5) to move (1150) a cursor on the world map GUI 1000 from position (4') to position (5'). The user can then select a highlighted region (6') by pressing (6) a selection button 970 on user interface 960. Upon the “onClick” event a child form can

open **1210** displaying various information (e.g., the current SPL dosage across that region, a geographic map from which to further refine location selection).

Illustrated in FIG. **12** is the current SPL dosage of that region **1200** that one would experience in the standard dosage calculation time frame (e.g., 8 hours, 24 hours) at the present and/or projected SPL levels. Further location refinement is facilitated by specific location button **1220**.

FIG. **12** is a non-limiting example only. The SPL Dosage can be calculated by associating pixels in the image with associated geographic extent in the region illustrated. Then the available SPL recordings can be used to calculate an associated SPL average value at the present time and fed into an SPL dosage calculation associated with the geographic regions. For example FIGS. **12A-12D** illustrate the process of calculating an average SPL associated with a geographic region and combining average values to obtain a pixel related SPL average value and a pixel related SPL Dosage value that can be plotted as in FIG. **12**. For example the SPL Dosage values of each pixel of map FIG. **12A** can be calculated by using the available SPL recorded values (e.g., **1340**, **1350**, **1360**) of the geographic regions associated with the pixels. For example FIG. **12B** illustrates the various pixels **1310** (e.g., **1330** FIG. **12C**) associated with the image. A geographic region of the image **1320** can have many pixels (e.g., **1330**). FIG. **12D** illustrates SPL sources (SPL1, SPL2, and SPL3) in pixel **1330**. An average value of the SPL (e.g., SPL_{ave} **1370**) can be calculated from the recorded sources, for example $SPL_{ave} = (SPL1 + SPL2 + SPL3) / 3$. SPL Dosage values can be calculated from SPL average values applied over a selected time frame (e.g., 8 hours). For example equation (A1) can be used to calculate SPL Dosage for this non-limiting example if one makes the assumption that daily noise exposure is SPL Dosage (which it may not be in other examples);

$$D = 100 C / T \quad (A1)$$

where T is the reference duration at a particular SPL average and C is the total length of a work day. For example if C is 16 hours and SPL Average is 85 dBA then D=100%. If C is 8 hours and SPL average is 85 dBA then D=50%. Note if C is about 24 hours, then an SPL average value of about 82 dBA would give D=100%. Various values of D can be color-coded resulting a color image. For example if D=100% the color can be red. If it is 150% it could be white indicating that in that region it exceeds 100%.

FIG. **13** illustrates a user selecting a location option according to at least one exemplary embodiment. A location button **1220**, associated with GUI **1200**, can be selected (7) with a user interface. A more specific location GUI map **1400** can then be displayed FIG. **14**, where a user, can then move **1450** a cursor from location (8') to (9') above the location desired, where the move **1450** is associated with moving **1455** a user interface **1460** from location (8) to (9), where the user can select (10) the location associated with the cursor location on the GUI map **1400**.

FIG. **15** illustrates a GUI in accordance with at least one exemplary embodiment. FIG. **15** illustrates a highlighted region (**1510** e.g., Virginia) that has been selected (10) by a user. Upon selection, a closer map of the selected region can be displayed in an interactive GUI as illustrated in FIG. **16**. To illustrate that various display options fall within the scope of at least one exemplary embodiment, a user centers a sub-regional extent **1620** about the cursor location indicating the next extent of any closer view selection. A user can use the user interface **1460** to move **1650** a cursor from position (11') to position (12') corresponding to movement **1655** of a

user interface from position (11) to position (12). A user can then select (13) the closer view the region about the current position of the cursor, which for example can be indicated by a changing of the color of the surrounding region (13'). Note that other indications of selection can be used and the discussion herein is only for illustrative purposes.

FIG. **17** illustrates a GUI **1700** for selecting a location in a city in accordance with at least one exemplary embodiment. Note that this embodiment illustrates a zoom bar **1730** that a user can use to increase or decrease resolution. For example an increase in resolution can be indicated by a rectangular **1710** extent of the view that would be displayed in a similar size image as the GUI's image. Upon selection of the resolution the image in **1710** can be displayed (e.g., opening **1750** of a child form) such as illustrated in FIG. **18**.

FIG. **18** illustrates a GUI **1810** illustrating various available acoustic signals in accordance with at least one exemplary embodiment. Note that there can be various methods (e.g., symbols, lights, shapes, colors) that can be used to indicate location of the sound recording, type of sound recording (e.g., different shapes for different topics such as vehicles), intensity of the sound signal of the sound recording (e.g., colors, shapes), and indication of whether the recording is real time or old (e.g., symbols such as shown in shape legend **1840**). The non-limiting example illustrated in FIG. **18** indicates circles **1820**, **1850** for real time recordings and triangle **1830** for a recording, where real time can be set to be any recording that has an end time a Dt from the present time. For example any recording within 30 minutes of the present time can be considered a real time recording, note that the time can vary and be as short as fractions of a second to days. Also colors (such as shown in color legend **1855**) are associated with the shape in this non-limiting example to illustrate the sound intensity of the sound recording at the recording location.

At least one exemplary embodiment plays the sound associated with a symbol by passing the cursor on the symbol, at which time the software (e.g., C++ OnEnter event) activates a media player and loads a sound recording associated with the pixel locations associated with the symbol and stop upon movement of the cursor off of the symbol (e.g., C++ OnExit event). Note that the media player can optionally be displayed. Additionally a user can click on the symbol to play (e.g., C++ OnClick event). For example FIG. **19** illustrates a media player set to play the selected sound recording. The sound recording **1910** can be displayed mono or stereo. The user can control the sound recording's play **1940**, reverse **1920** or pause **1930**. Note that other exemplary embodiments can have other media players and exemplary embodiments are not restricted by the type of media player, nor whether the media player is visually displayed or not.

FIG. **20** illustrates the source signals from FIG. **18** and the associated source signals that generated the sound recordings (**1820** and **1850**) (as well as recording **1880**). Note that the sound recorded by microphones at **1820** and **1850** can be from multiple sources (e.g., **2310**, **2320**, and **2330**). Note that the sound recordings do not necessarily indicate source locations. A recording at intensity I at x,y,z can be due to a source of intensity I0 at a radius r. Thus the source location is not uniquely identified. Three recordings or more (e.g., M1, M2, M5), where the source intensity can be separated from microphone recordings can be used to uniquely identify the location of the source signal (e.g., s1 **2310**). Note that the source intensity and location may be needed, presenting four unknowns, for example Isource, xsource, ysource, and zsource. For example a source signal can be

identified in M1, M2, and M5 by looking for frequency dependencies in the sound recordings (e.g., M1, M2, and M5) that have similar coherence. High coherence frequency bands can be used to identify and match frequency intensities due to similar signals. Matched frequency bands can be used based upon intensity of the recordings in those bands and the location of the recordings to convolve the source location and approximate intensity for those bands. Then estimated source signals (e.g., 2310, 2320, 2330) can be composed along with location. The source signals 2310, 2320, and 2330 can then be used to approximate the sound at a user selected location 2300 (x,y,z). Note that the methodology discussed herein is an example of one method of generating the acoustic source at a chosen location. There can be others within the scope of exemplary embodiments.

FIG. 21 illustrates source signals from the available sources in the listening area in accordance with at least one exemplary embodiment. For example sources 2010, 2020, and 2030 have been located on GUI 1810, and can be used to estimate the sound(s) that a user would hear at a selected position 2040.

FIG. 22 illustrates source signals, s1, s2, and s3. A user that has selected a location (x,y,z) and a time t1, can use the sources to compose a sound recording that is associated with x, y, z, and t1. Note that in one exemplary embodiment the method for combination matches the various sources (s1, s2, and s3) at start time t1, FIG. 23.

The source recording associated with the selected position (x,y,z) can be composed by calculating the radial distance (e.g., r1, r2, and r3) (see FIG. 24), used to modify intensities of the sources at x, y, and z and modifying the time delay associated with the sources. For example if source s1 2310 is emitting a sound signal at t1, it will arrive at the selected position 2300 with a time delay based upon the speed of sound. Likewise other sources 2320 and 2330 will have a time delay from t1 to location 2300. Note also that the source signals S1, S2, and S3, can also be identified in M1, M2, and M3 by not only looking for high coherence but also time delays in the temporal recordings to help locate the location of the sources (e.g., via time delay between various microphone measurements). The radial distance can be used to modify the expected intensity of the sound sources at 2300 (FIG. 25).

The modified signals can be combined to create the estimated sound recording 2510 at 2300 (FIG. 26).

Where applicable, the present embodiments of the invention can be realized in hardware, software or a combination of hardware and software. Any kind of computer system or other apparatus adapted for carrying out the methods described herein are suitable. A typical combination of hardware and software can be a mobile communications device with a computer program that, when being loaded and executed, can control the mobile communications device such that it carries out the methods described herein. Portions of the present method and system may also be embedded in a computer program product, which comprises all the features enabling the implementation of the methods described herein and which when loaded in a computer system, is able to carry out these methods.

While the preferred embodiments of the invention have been illustrated and described, it will be clear that the embodiments of the invention are not so limited. Numerous modifications, changes, variations, substitutions and equivalents will occur to those skilled in the art without departing from the spirit and scope of the present embodiments of the invention as defined by the appended claims.

What is claim is:

1. A sound pressure level measurement system comprising:

a mobile device having a microphone used for obtaining a sound pressure level measurement;

wherein the mobile device is configured to transmit the sound pressure level measurement to a remote server with a database via a communication path;

wherein the mobile device collects audio content via the microphone in response to being triggered by the sound pressure level measurement being equal to or greater than a sound pressure level threshold, wherein the remote server determines that the sound pressure level measurement is equal to or greater than a sound pressure level threshold;

wherein the mobile device attaches metadata to the audio content, the metadata regarding time information and geographic information;

wherein the audio content with the metadata regarding time information and geographic information is analyzed via the remote server in response to being triggered by the sound pressure level measurement and detection, via the remote server, of a sound signature of the audio content; and

wherein the sound signature is a sound event from a model of sound signatures stored as a statistical based pattern classifier.

2. The sound pressure level measurement system as recited in claim 1, wherein the mobile device buffers audio content and collects audio content from a period before the sound pressure level measurement being equal to or greater than a sound pressure level threshold, from a period during the sound pressure level measurement being equal to or greater than a sound pressure level threshold and a period after the sound pressure level measurement being equal to or greater than a sound pressure level threshold.

3. The sound pressure level measurement system as recited in claim 1, wherein the communication path comprises a wireless local area network coupling the mobile device to the database for providing the sound pressure level measurements thereto.

4. The sound pressure level measurement system as recited in claim 1, wherein the communication path comprises a wired or fiber optic path coupling the mobile device to the database for providing the sound pressure level measurements thereto.

5. The sound pressure level measurement system as recited in claim 1, wherein the mobile device measures a sound pressure level automatically.

6. The sound pressure level measurement system as recited in claim 5, wherein the mobile device measures and stores sound pressure levels in memory and wherein a queue of sound pressure levels is stored in memory of the mobile device to be uploaded to the database when a communication path is opened.

7. The sound pressure level measurement system as recited in claim 1, wherein the mobile device includes audio processing circuitry which is bypassed when the mobile device is taking the sound pressure level measurement that is sent to the database.

8. The sound pressure level measurement system as recited in claim 1, wherein the analysis identifies a detected sound signature of the audio content and whether the audio content indicates a threat.

9. The sound pressure level measurement system as recited in claim 8, wherein the mobile device is configured to present a report of the analysis, the report includes instructions for responding.

19

10. The sound pressure level measurement system as recited in claim 1, wherein the sound pressure level measurement is compensated based on microphone directional pattern, the physical shape of the mobile device, microphone sensitivity, microphone porting, any baffling, or a combination thereof.

11. The sound pressure level measurement system as recited in claim 1, wherein the microphone obtains the sound pressure level measurement based on a trigger level that is based on a predetermined sound pressure level.

12. The sound pressure level measurement system as recited in claim 1, wherein the mobile device includes a user interface configured to display a map illustrating locations having sound pressure level measurements and indicating whether the sound pressure level measurements are real time measurements.

13. A sound pressure level measurement system comprising:

a mobile device having a microphone used for obtaining a sound pressure level measurement;

wherein the mobile device is configured to transmit the sound pressure level measurement to a remote server with a database via a communication path; and

wherein the mobile device captures live audio content via the microphone in response to being triggered by the sound pressure level measurement being equal to or greater than a sound pressure level threshold, wherein the remote server determines that the sound pressure level measurement is equal to or greater than a sound pressure level threshold;

wherein the mobile device attaches metadata to the live audio content, the metadata regarding time information and geographic information;

wherein the live audio content with the metadata regarding time information and geographic information is analyzed via the remote server in response to being triggered by the sound pressure level measurement and detection, via the remote server, of a sound signature of the audio content; and

wherein the sound signature is a sound event from a model of sound signatures stored as a statistical based pattern classifier.

14. The sound pressure level measurement system as recited in claim 13, wherein the mobile device includes a user interface configured to display a map illustrating loca-

20

tions having sound pressure level measurements and indicating whether the sound pressure level measurements are real time measurements.

15. The sound pressure level measurement system as recited in claim 13, wherein the microphone obtains the sound pressure level measurement based on a trigger level that is based on a predetermined sound pressure level.

16. The sound pressure level measurement system as recited in claim 13, wherein the sound pressure level measured is compensated based on microphone directional pattern, the physical shape of the mobile device, microphone sensitivity, microphone porting, any baffling, or a combination thereof.

17. A sound pressure level measurement system comprising:

a mobile device having a microphone used for obtaining a sound pressure level measurement; and

wherein the mobile device is configured to transmit the sound pressure level measurement to a remote server with a database via a communication path;

wherein the mobile device collects audio content via the microphone in response to being triggered by the sound pressure level measurement being equal to or greater than a sound pressure level threshold, wherein the remote server determines that the sound pressure level measurement is equal to or greater than a sound pressure level threshold;

wherein the mobile device attaches metadata to the audio content, the metadata regarding time information and geographic information;

wherein the audio content with the metadata regarding time information and geographic information is analyzed via the remote server in response to being triggered by the sound pressure level measurement, detection, via the remote server, of a sound signature of the audio content and sensor data from an acceleration sensor; and

wherein the sound signature is a sound event from a model of sound signatures stored as a statistical based pattern classifier.

18. The sound pressure level measurement system as recited in claim 17, wherein the mobile device queues sound pressure level measurements to be transmitted to the database when the communication path is opened.

* * * * *