

US010390036B2

(12) **United States Patent**
Zhang et al.

(10) **Patent No.:** **US 10,390,036 B2**
(45) **Date of Patent:** **Aug. 20, 2019**

(54) **ADAPTIVE AFFINE MOTION COMPENSATION UNIT DETERMING IN VIDEO PICTURE CODING METHOD, VIDEO PICTURE DECODING METHOD, CODING DEVICE, AND DECODING DEVICE**

(58) **Field of Classification Search**
CPC .. H04N 19/119; H04N 19/139; H04N 19/176;
H04N 19/196; H04N 19/521;
(Continued)

(71) Applicant: **Huawei Technologies Co., Ltd.**,
Shenzhen (CN)

(56) **References Cited**
U.S. PATENT DOCUMENTS

(72) Inventors: **Hong Zhang**, Shenzhen (CN); **Haitao Yang**, Shenzhen (CN)

6,084,908 A 7/2000 Chiang et al.
6,775,415 B1 * 8/2004 Clausen H04N 19/96
375/E7.201

(73) Assignee: **HUAWEI TECHNOLOGIES CO., LTD.**, Shenzhen (CN)

(Continued)

(*) Notice: Subject to any disclaimer, the term of this patent is extended or adjusted under 35 U.S.C. 154(b) by 85 days.

FOREIGN PATENT DOCUMENTS

CN 1325220 A 12/2001
CN 1684517 A 10/2005
(Continued)

(21) Appl. No.: **15/812,719**

OTHER PUBLICATIONS

(22) Filed: **Nov. 14, 2017**

Zhang, Na et al., "Motion Vector Derivation of Deformable Block," Image Processing (ICIP), 2012 19th IEEE International Conference. pp. 1549-1552.

(65) **Prior Publication Data**
US 2018/0070102 A1 Mar. 8, 2018

(Continued)

Related U.S. Application Data

Primary Examiner — Dominic D Saltarelli
(74) *Attorney, Agent, or Firm* — Slater Matsil, LLP

(63) Continuation of application No. PCT/CN2016/077784, filed on Mar. 30, 2016.

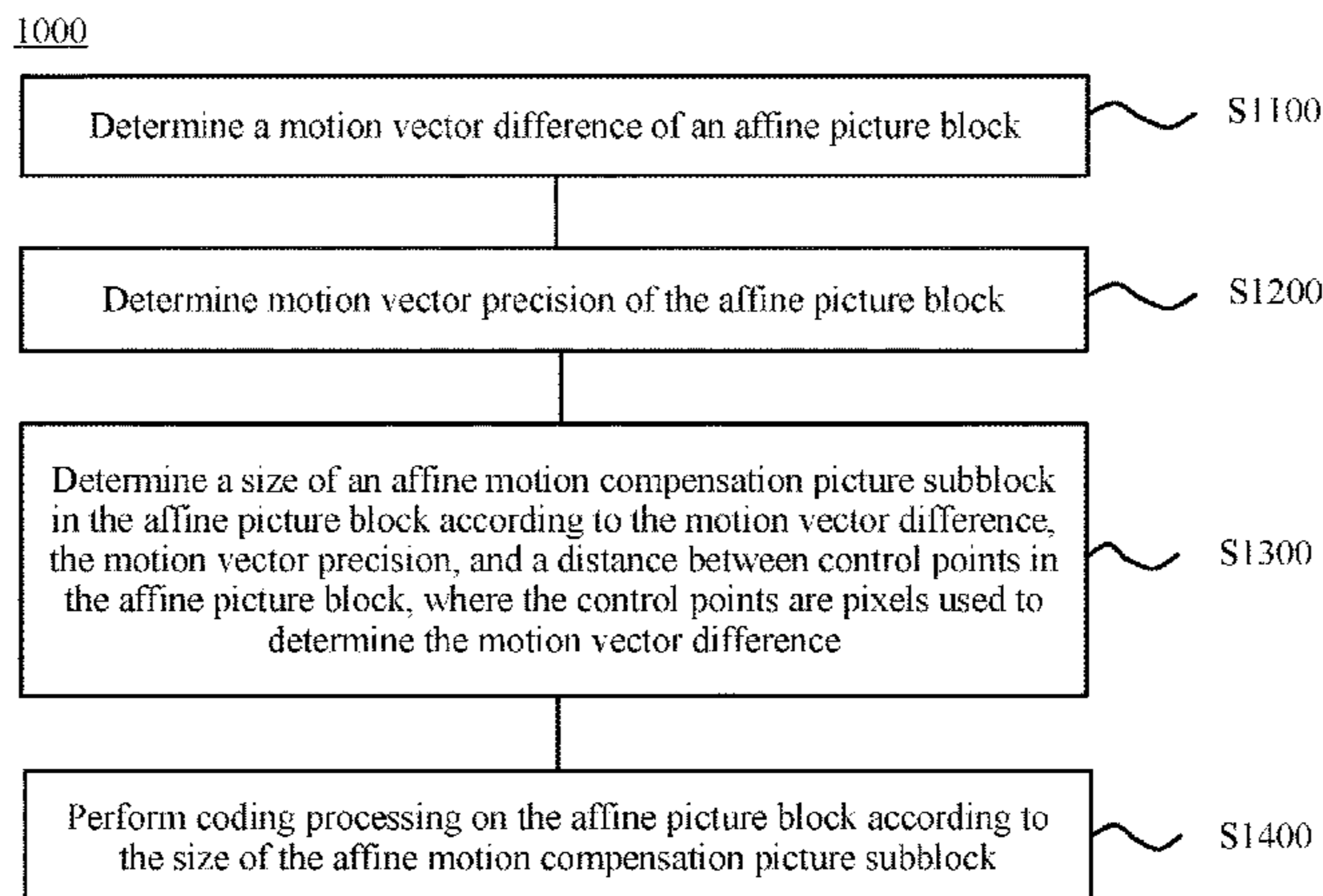
(30) **Foreign Application Priority Data**

May 15, 2015 (CN) 2015 1 0249484

(51) **Int. Cl.**
H04N 19/52 (2014.01)
H04N 19/54 (2014.01)
(Continued)

(57) **ABSTRACT**
The present invention provides a video picture coding method, a video picture decoding method, a coding device, and a decoding device. The method includes: determining a motion vector difference of an affine picture block; determining motion vector precision of the affine picture block; determining a size of an affine motion compensation picture subblock in the affine picture block according to the motion vector difference, the motion vector precision, and a distance between control points in the affine picture block, where the control points are pixels used to determine the motion vector difference; and performing coding processing on the affine picture block according to the size of the affine motion compensation picture subblock. In this way, a picture sub-
(Continued)

(52) **U.S. Cl.**
CPC **H04N 19/521** (2014.11); **H04N 19/119** (2014.11); **H04N 19/139** (2014.11);
(Continued)



block of an appropriate size is selected, so that coding complexity can be reduced, and coding efficiency can be improved.

60 Claims, 11 Drawing Sheets

(51) **Int. Cl.**

H04N 19/57 (2014.01)
H04N 19/513 (2014.01)
H04N 19/573 (2014.01)
H04N 19/139 (2014.01)
H04N 19/176 (2014.01)
H04N 19/119 (2014.01)
H04N 19/196 (2014.01)
H04N 19/53 (2014.01)
H04N 19/82 (2014.01)

(52) **U.S. Cl.**

CPC *H04N 19/176* (2014.11); *H04N 19/196* (2014.11); *H04N 19/52* (2014.11); *H04N 19/53* (2014.11); *H04N 19/54* (2014.11); *H04N 19/57* (2014.11); *H04N 19/573* (2014.11); *H04N 19/82* (2014.11)

(58) **Field of Classification Search**

CPC H04N 19/53; H04N 19/54; H04N 19/57; H04N 19/82

USPC 375/240.16
 See application file for complete search history.

(56) **References Cited**

U.S. PATENT DOCUMENTS

2002/0034250 A1 3/2002 Yoo
 2005/0226335 A1 10/2005 Lee et al.

2005/0265453 A1* 12/2005 Saito G06T 5/50
 375/240.16
 2009/0257498 A1 10/2009 Kurata
 2010/0329347 A1* 12/2010 Kim H04N 19/139
 375/240.16
 2012/0039387 A1 2/2012 Ha et al.
 2013/0301716 A1 11/2013 Zheng et al.
 2013/0329799 A1 12/2013 Lin et al.
 2014/0269923 A1 9/2014 Kwon et al.
 2014/0355684 A1 12/2014 Narroschke et al.
 2017/0188041 A1 6/2017 Li et al.

FOREIGN PATENT DOCUMENTS

| | | | |
|----|------------|----|---------|
| CN | 1961582 | A | 5/2007 |
| CN | 102547261 | A | 7/2012 |
| CN | 102611884 | A | 7/2012 |
| CN | 104053001 | A | 9/2014 |
| CN | 104539966 | A | 4/2015 |
| EP | 1158806 | A1 | 11/2001 |
| EP | 1274254 | A2 | 1/2003 |
| JP | 2000511366 | A | 8/2000 |
| JP | 2006187025 | A | 7/2006 |
| JP | 2014236510 | A | 12/2014 |
| RU | 2533852 | C2 | 11/2014 |
| WO | 9717797 | A2 | 5/1997 |
| WO | 2011070730 | A1 | 6/2011 |
| WO | 2011128366 | A1 | 10/2011 |
| WO | 2013068548 | A2 | 5/2013 |
| WO | 2015006894 | A1 | 1/2015 |

OTHER PUBLICATIONS

Huang, Han et al., "Mine Skip and Direct Modes for Efficient Video Coding," Visual Communications and Image Processing (VCIP), 2012 IEEE, IEEE, Nov. 27, 2012, 6 pages.
 Huang, Han et al., "Control-Point Representation and Differential Coding Affine-Motion Compensation," IEEE Transactions on Circuits and Systems for Video Technology, vol. 23, No. 10, Oct. 31, 2013, 10 pages.

* cited by examiner

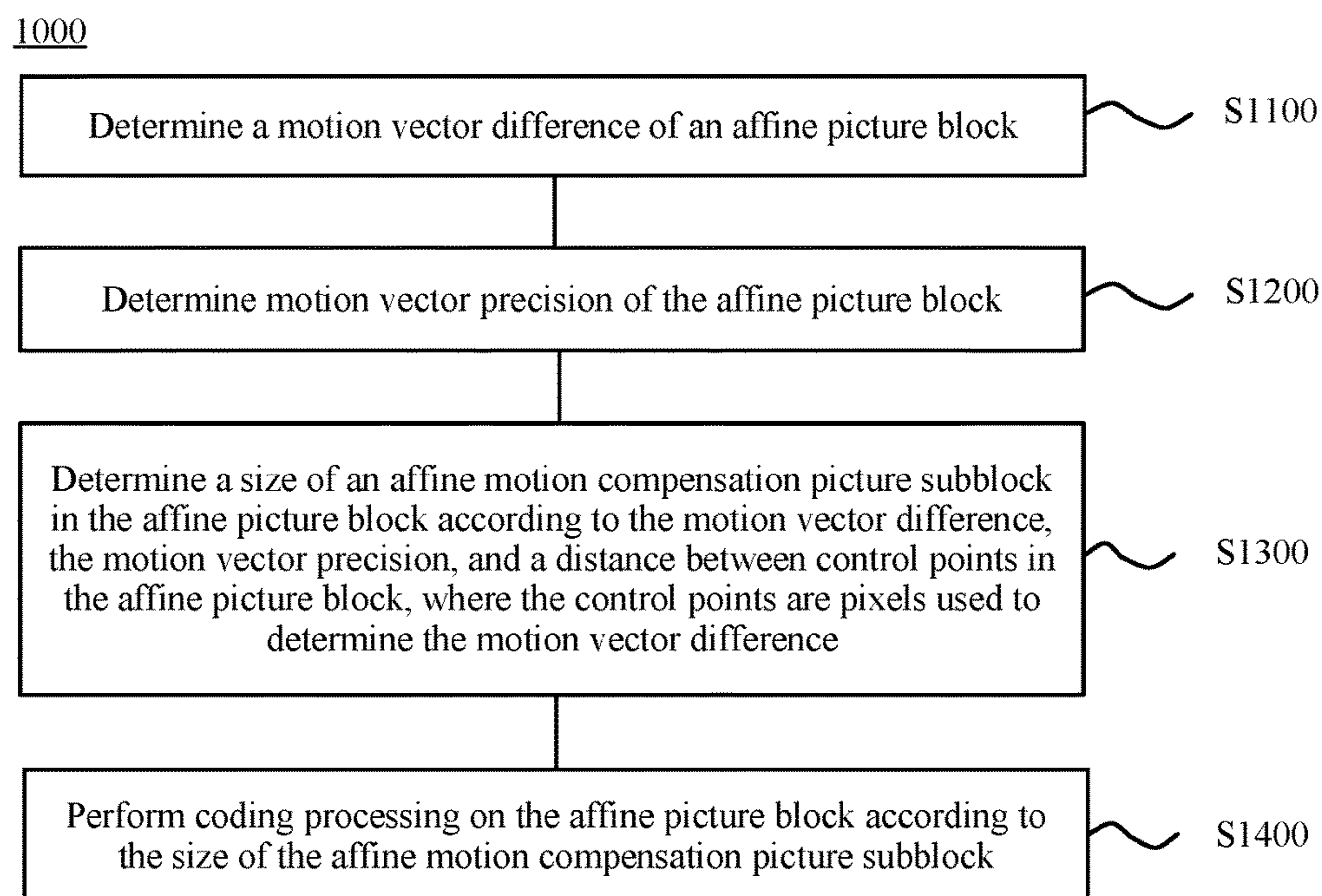


FIG. 1

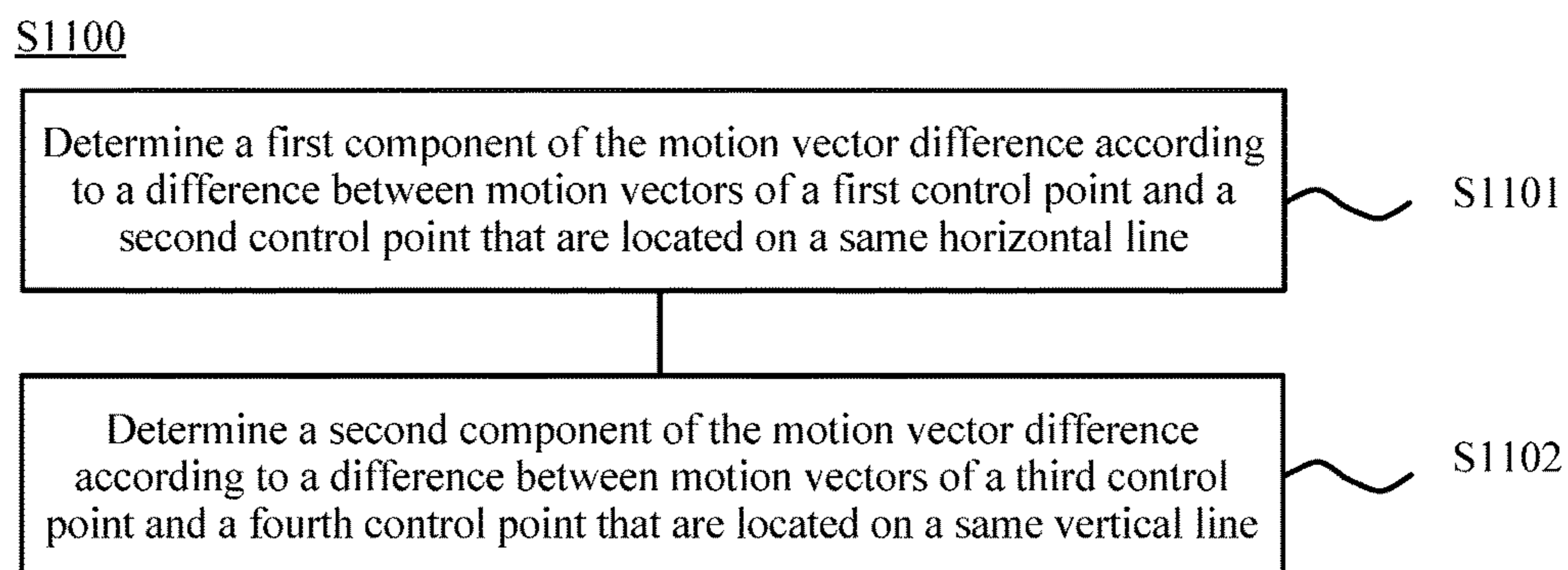


FIG. 2

S1101

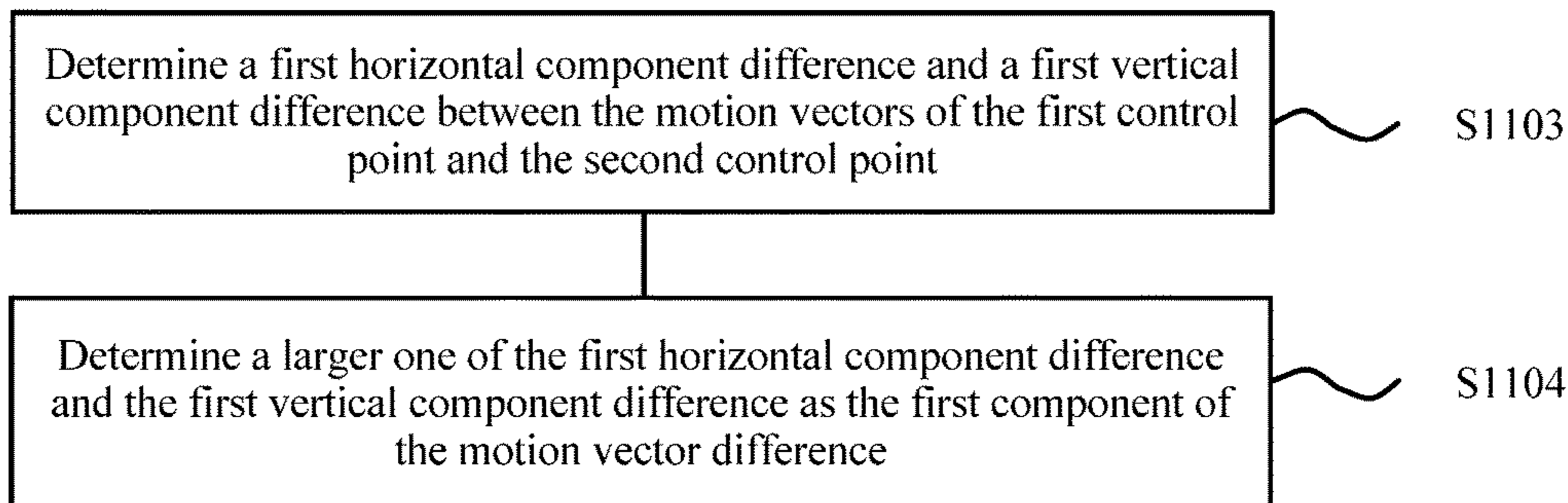


FIG. 3

S1102

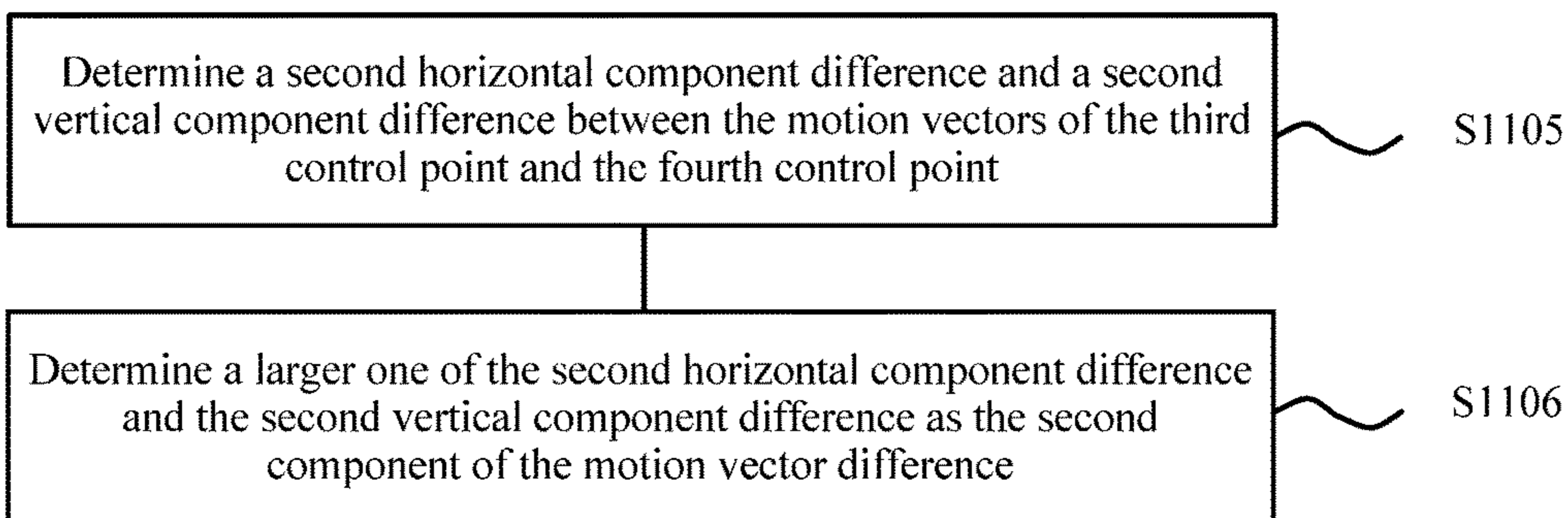


FIG. 4

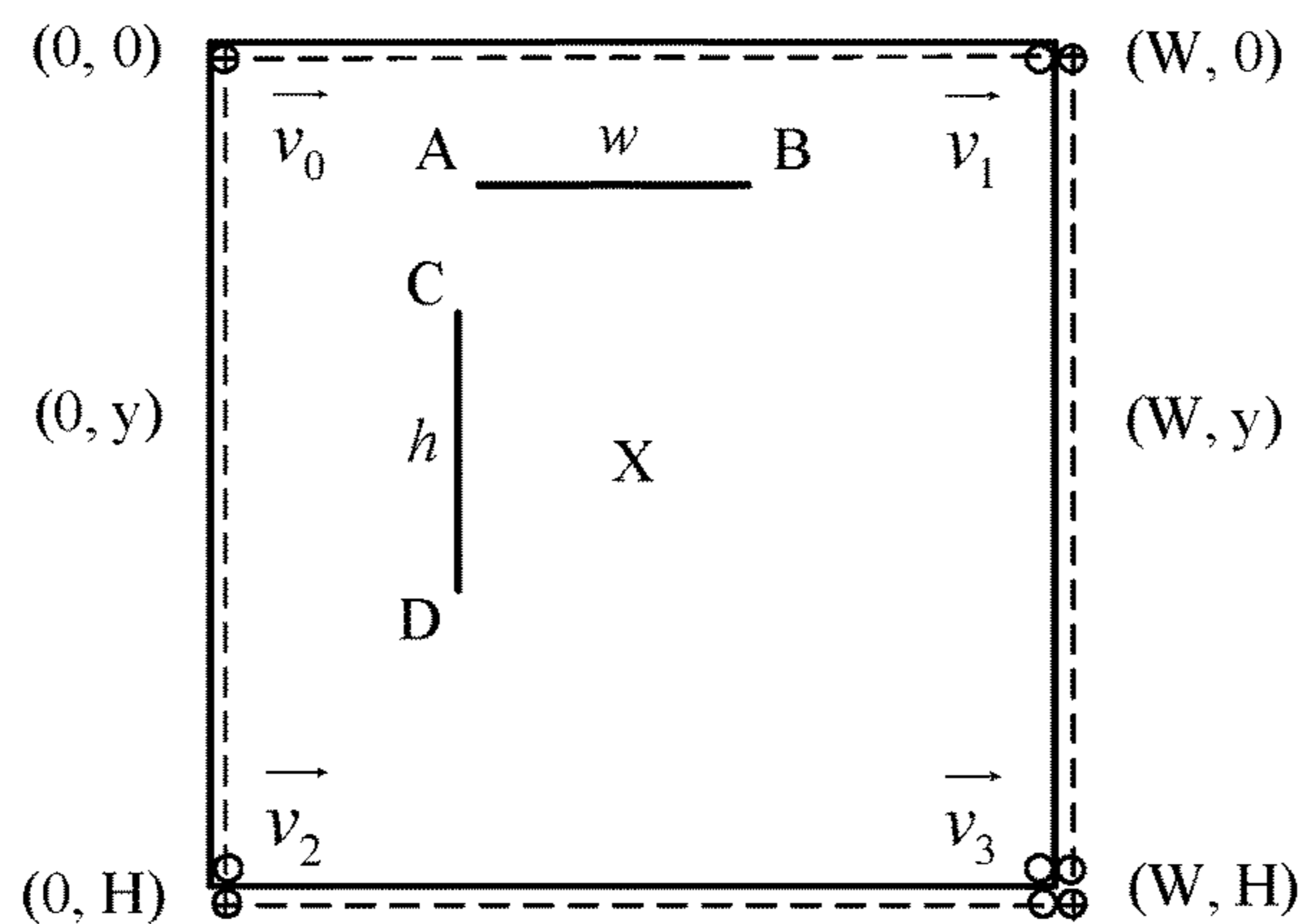


FIG. 5

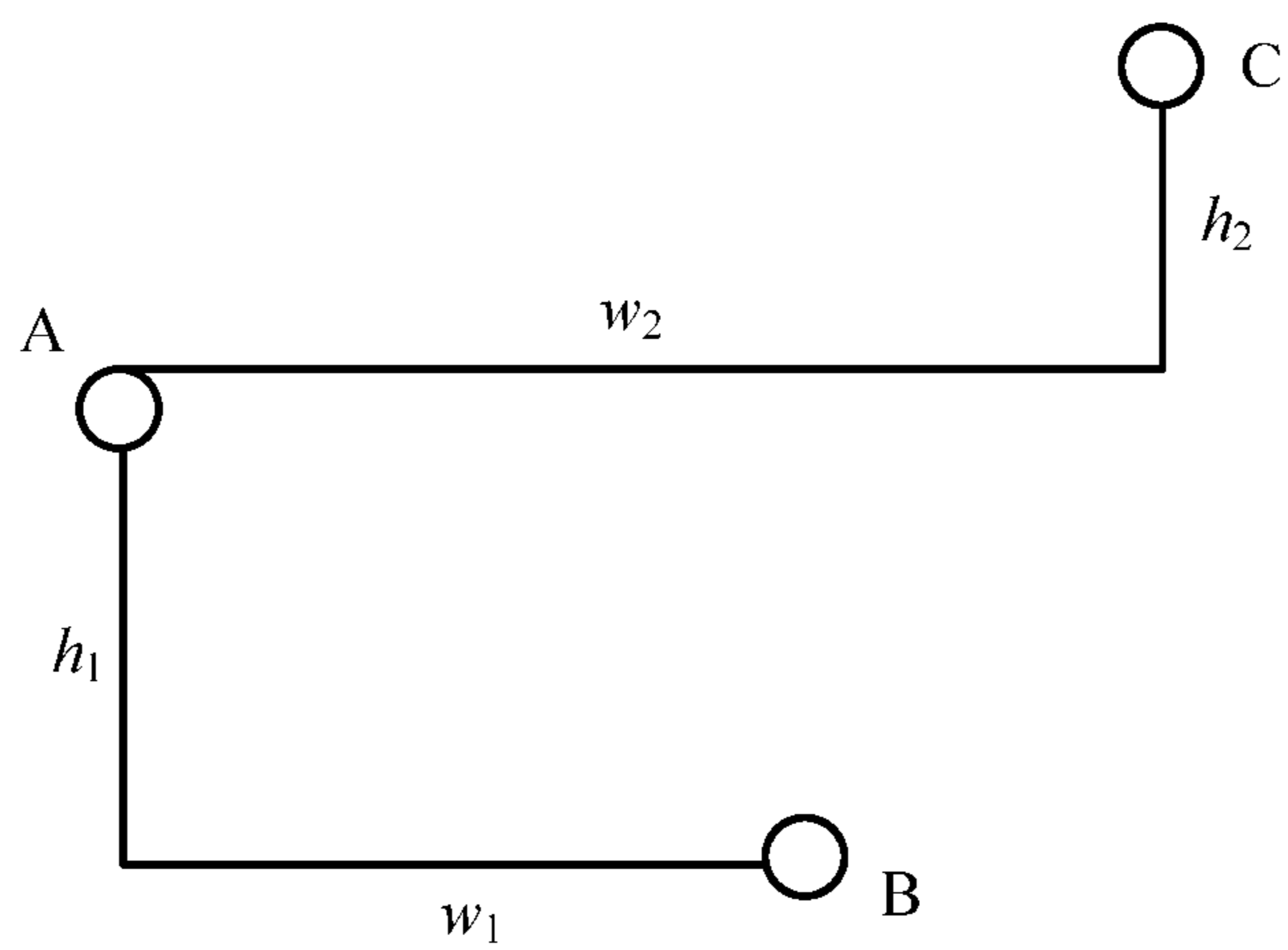


FIG. 6

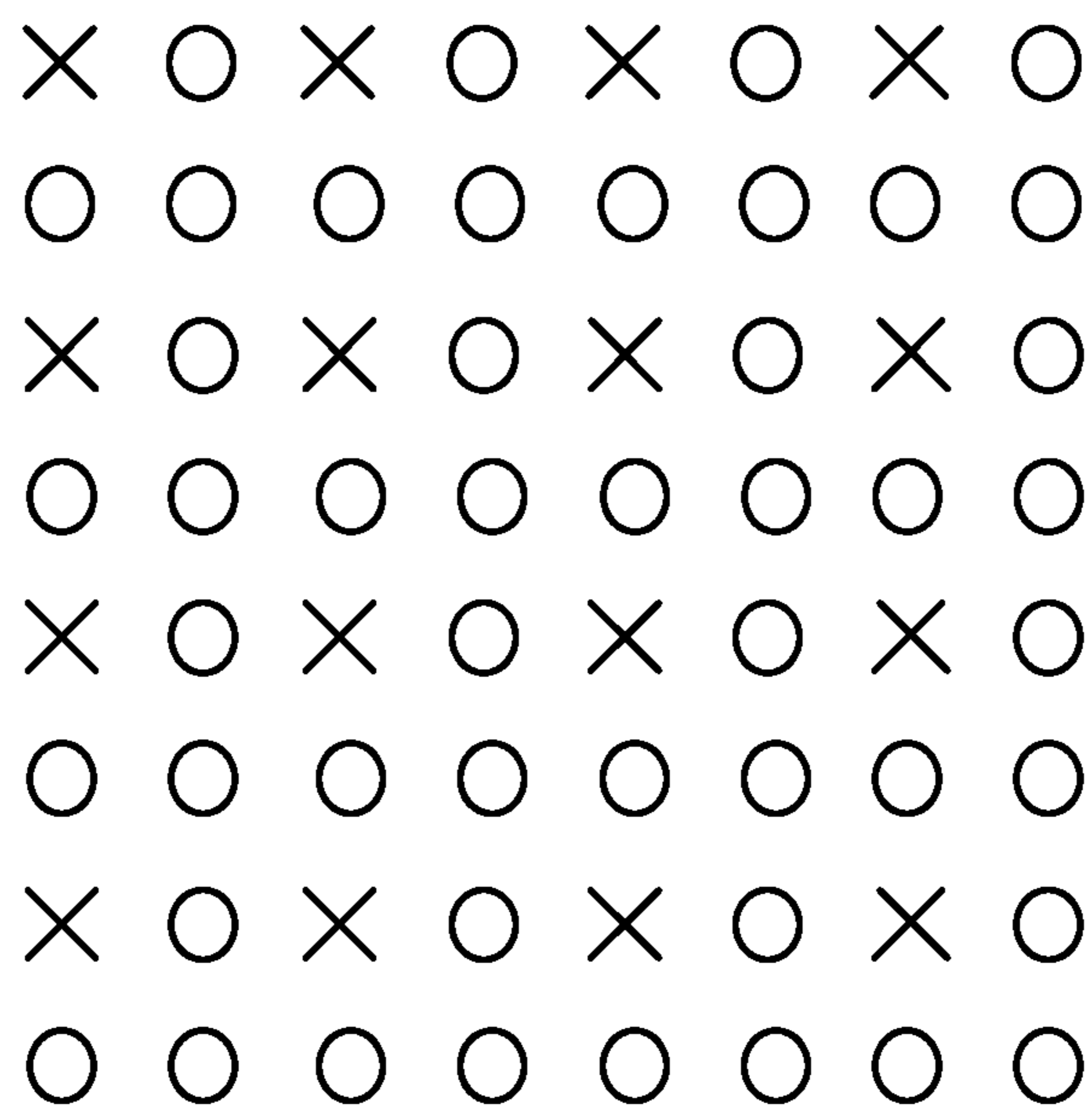


FIG. 7

S1300

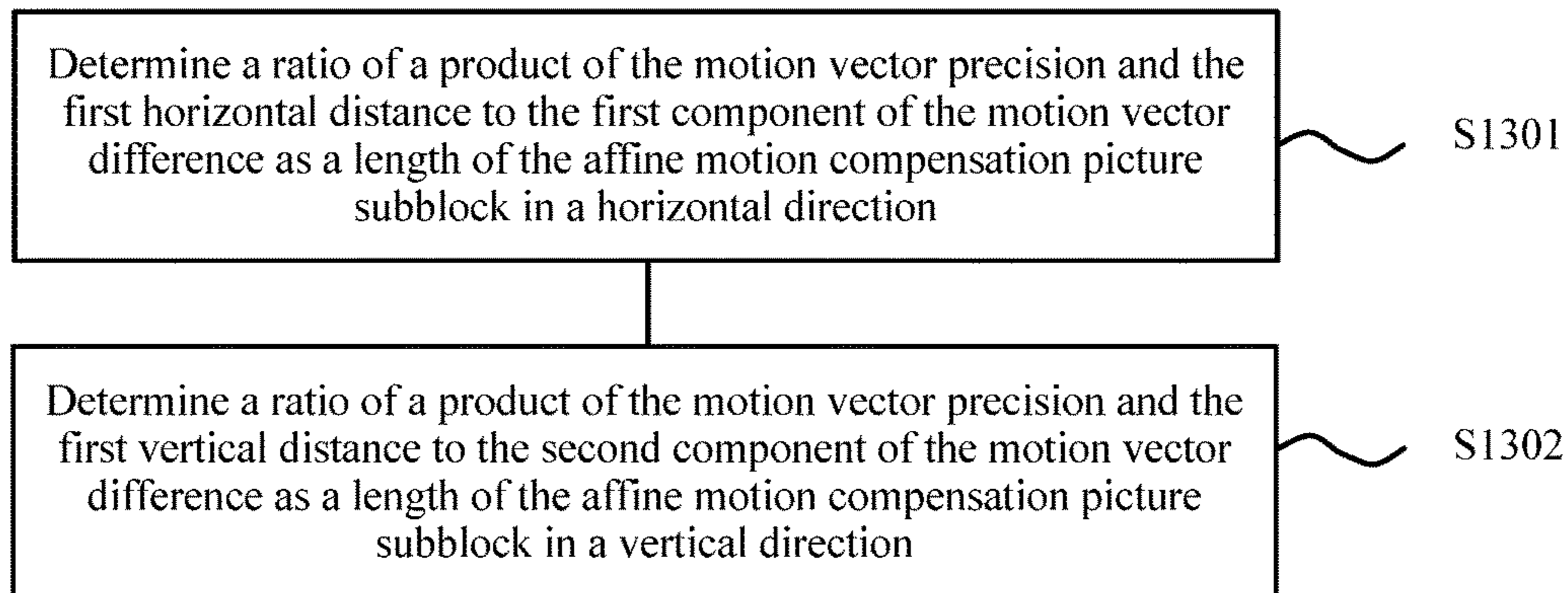


FIG. 8

S1300

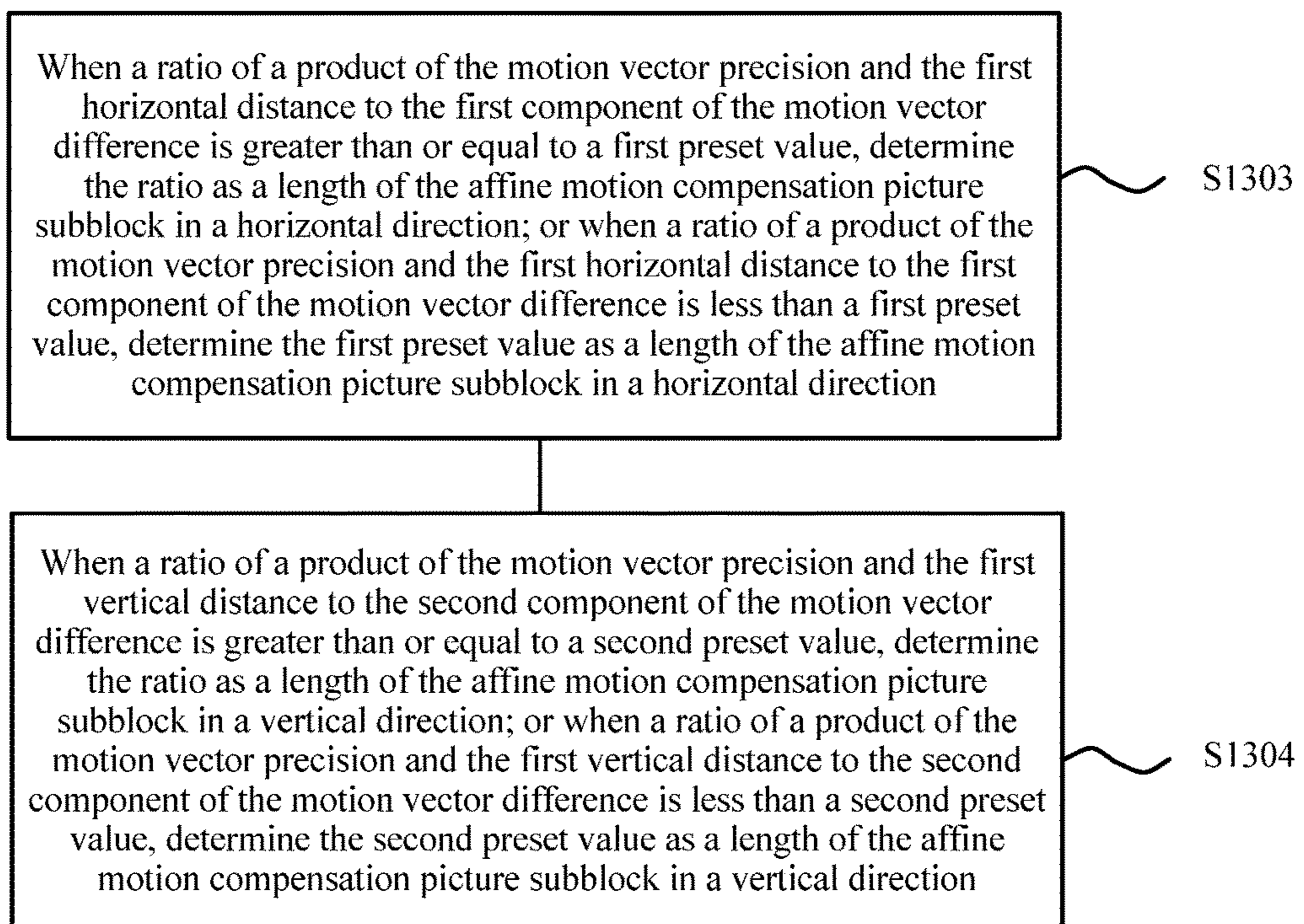


FIG. 9

S1400

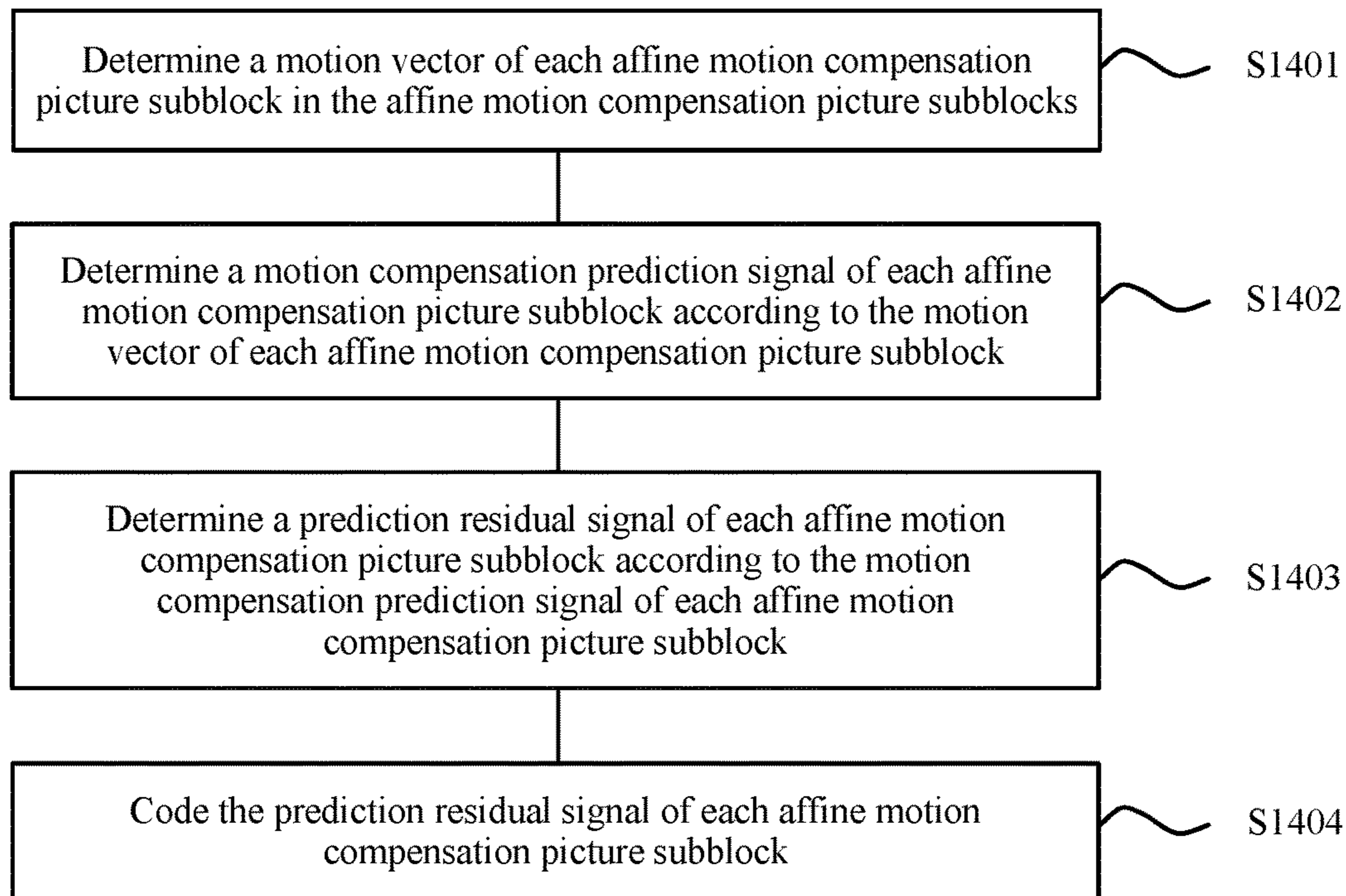


FIG. 10

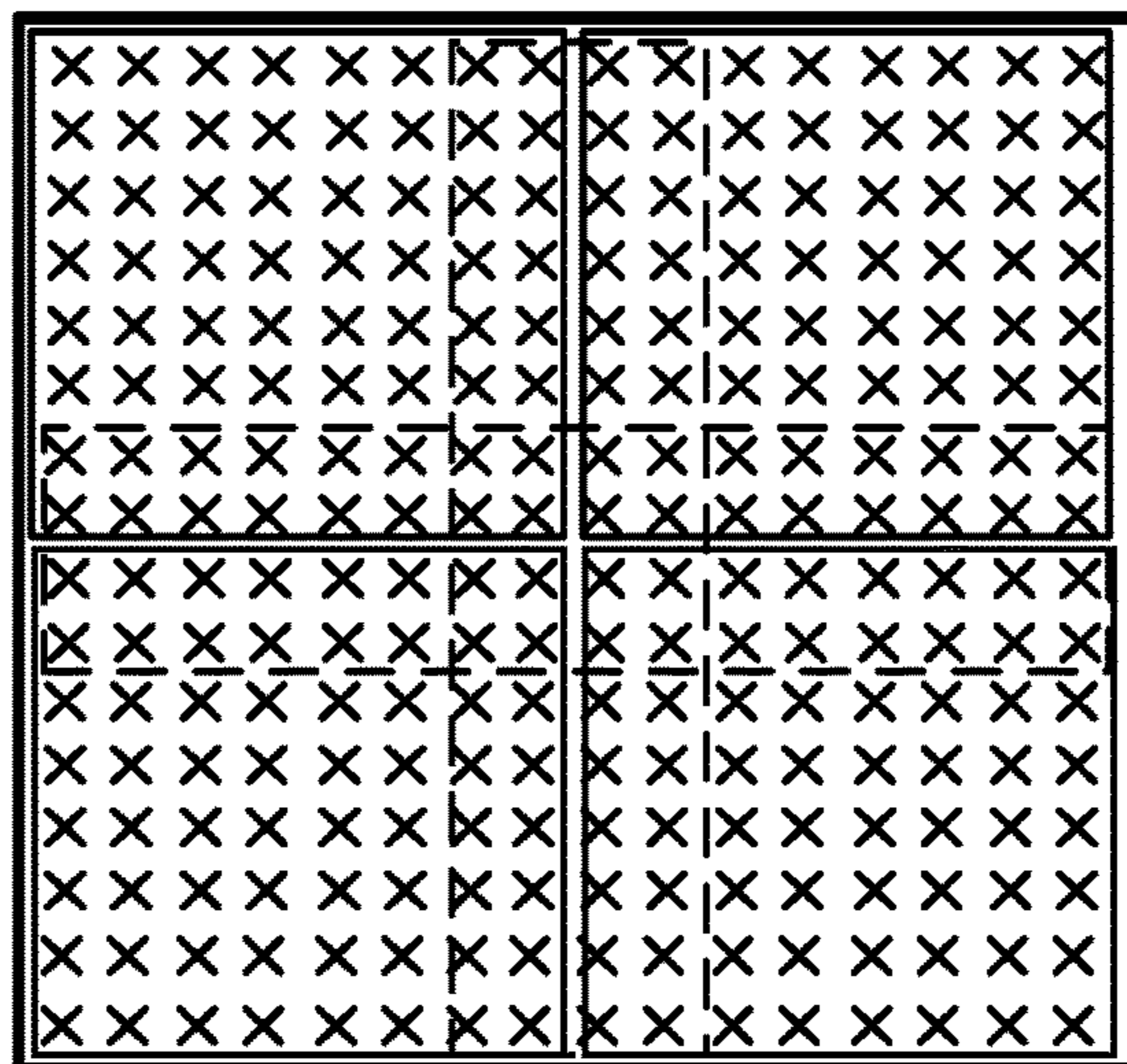


FIG. 11

2000

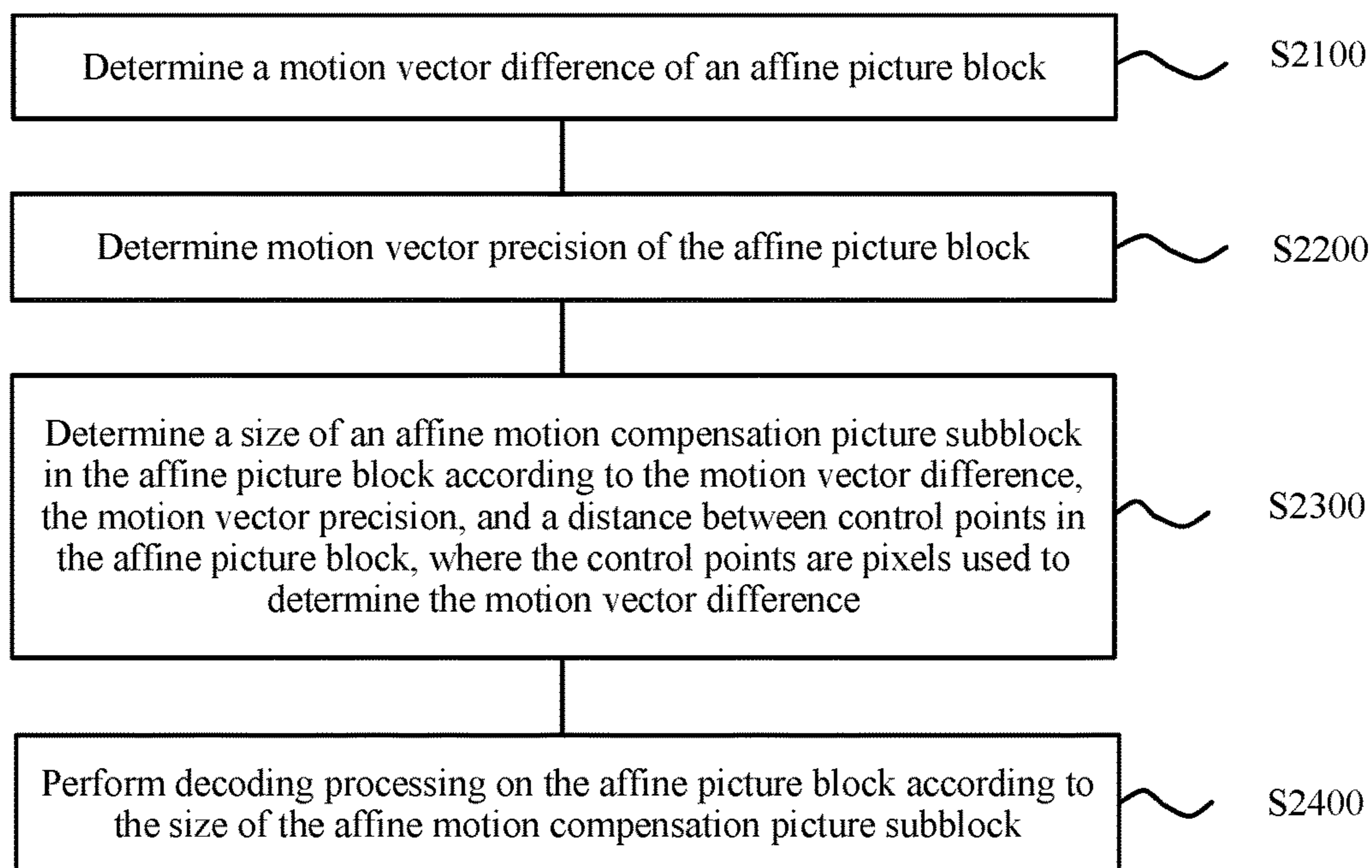


FIG. 12

S2100

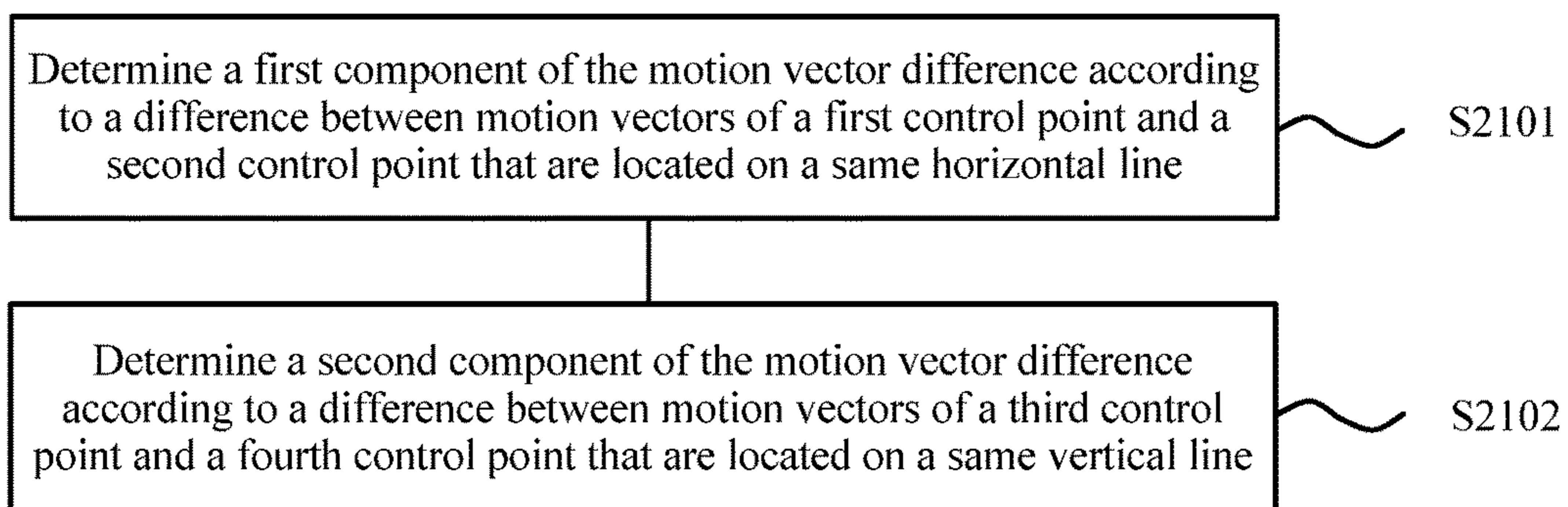


FIG. 13

S2101

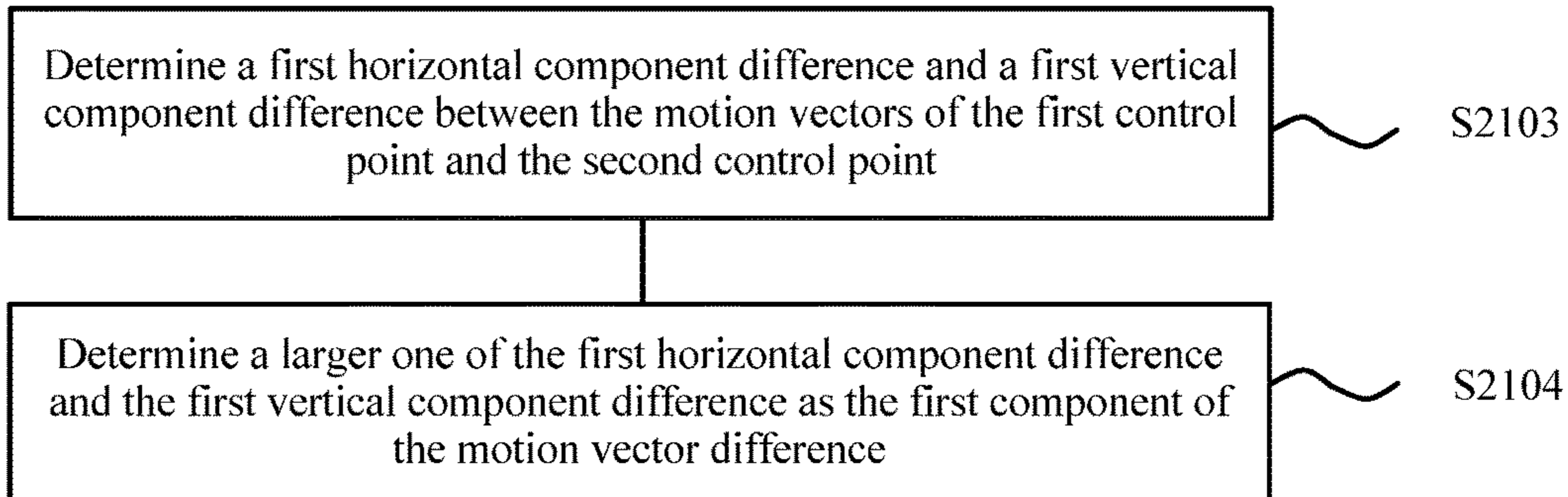


FIG. 14

S2102

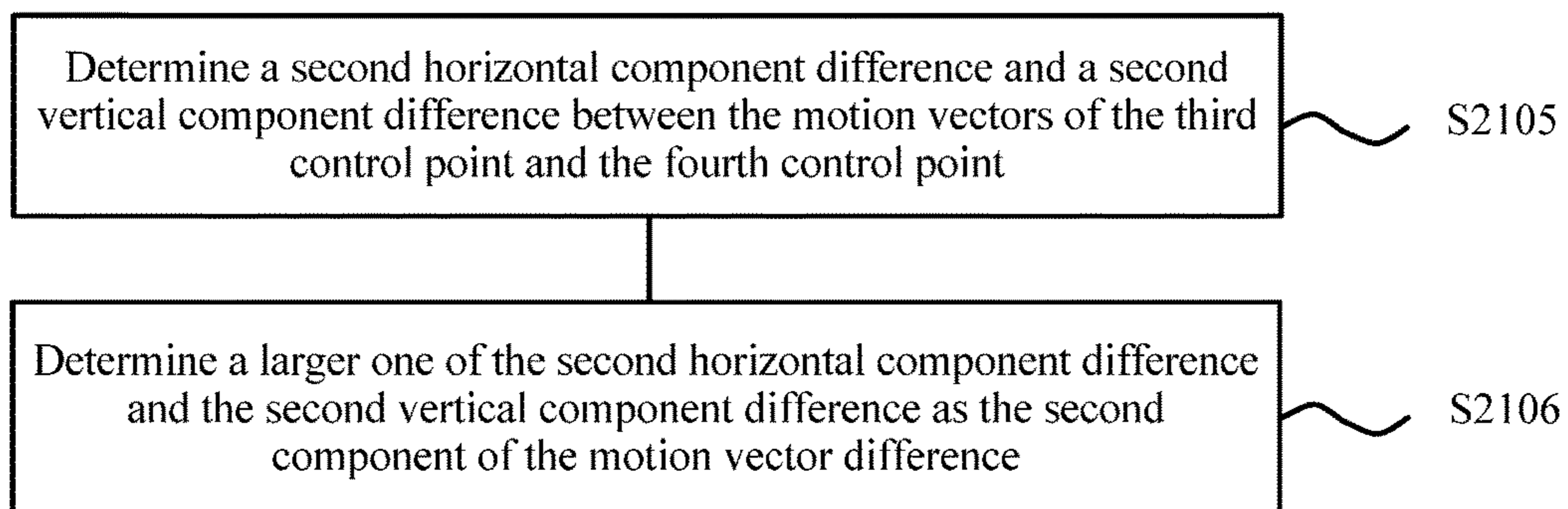


FIG. 15

S2300

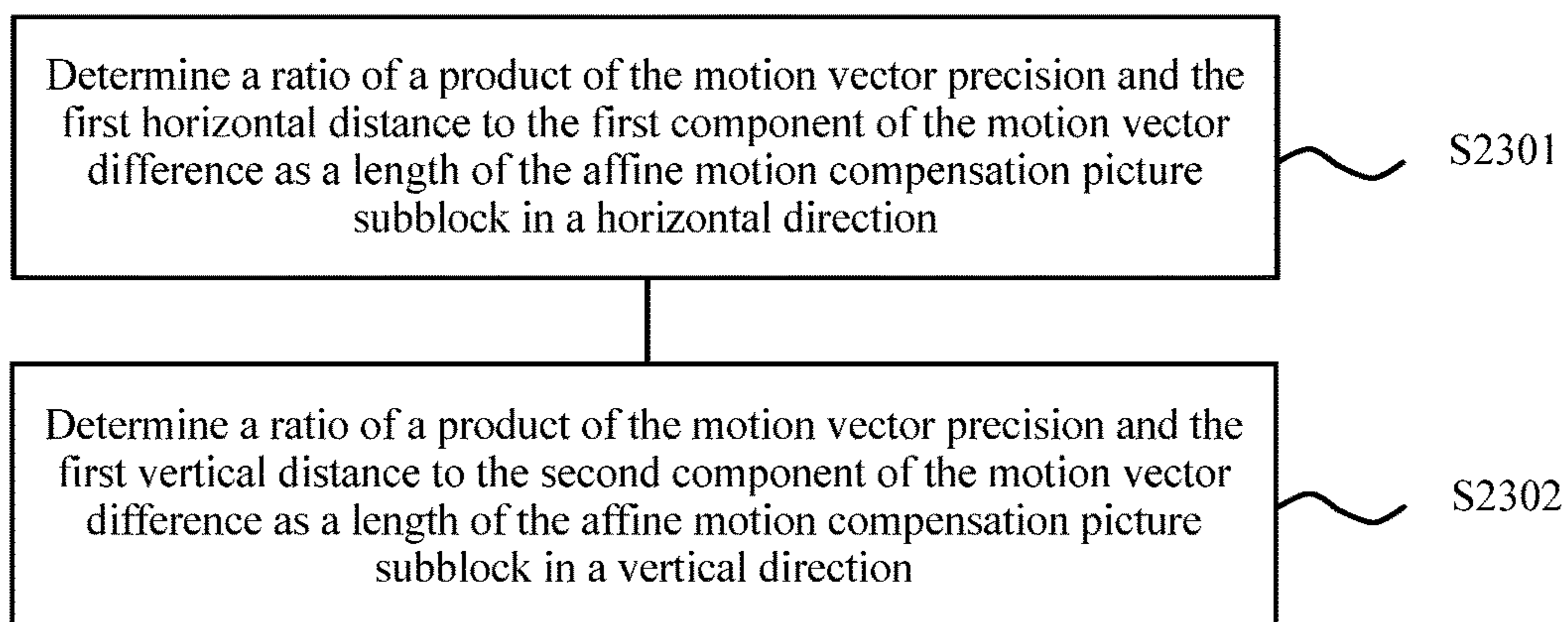


FIG. 16

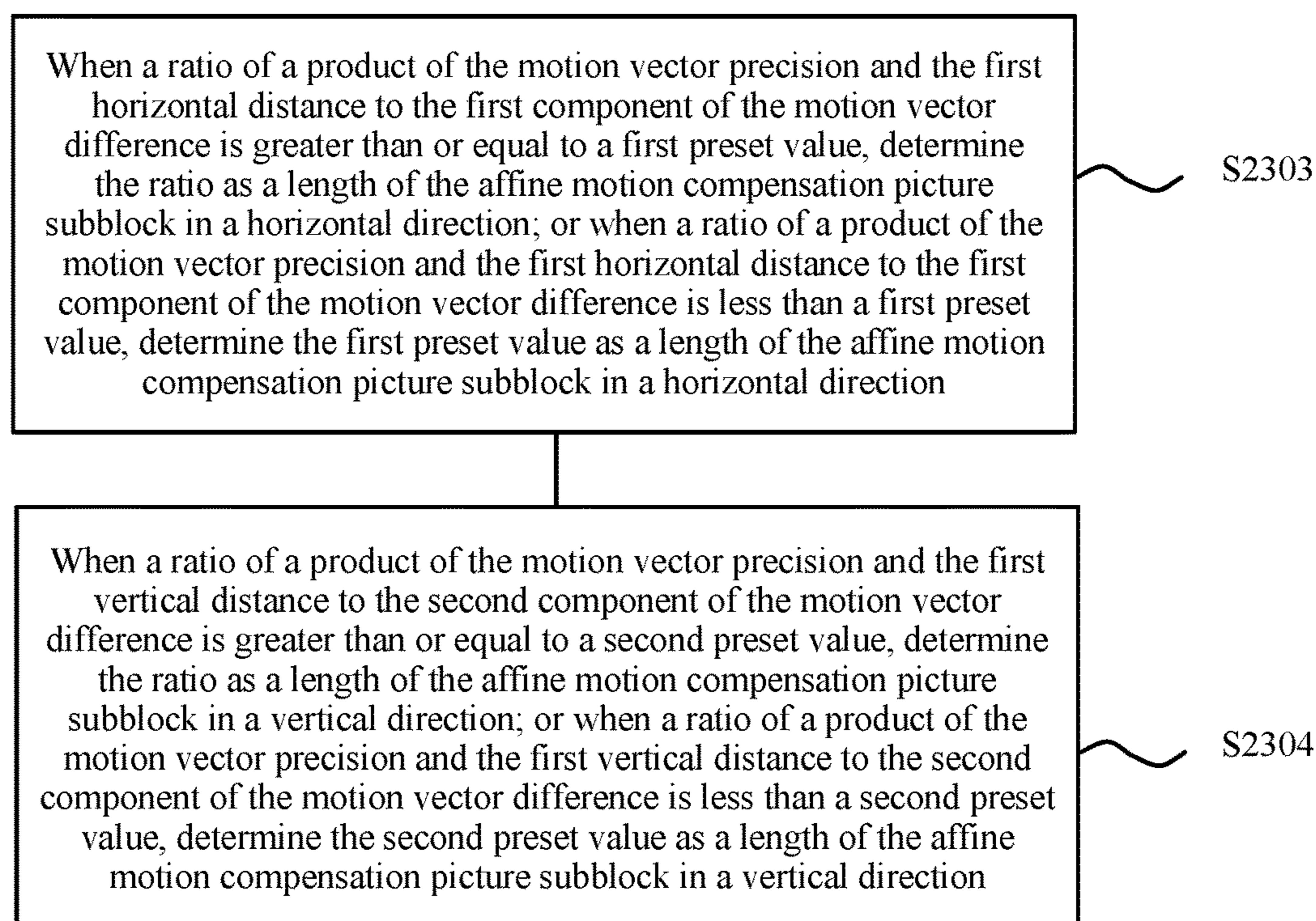
S2300

FIG. 17

S2400

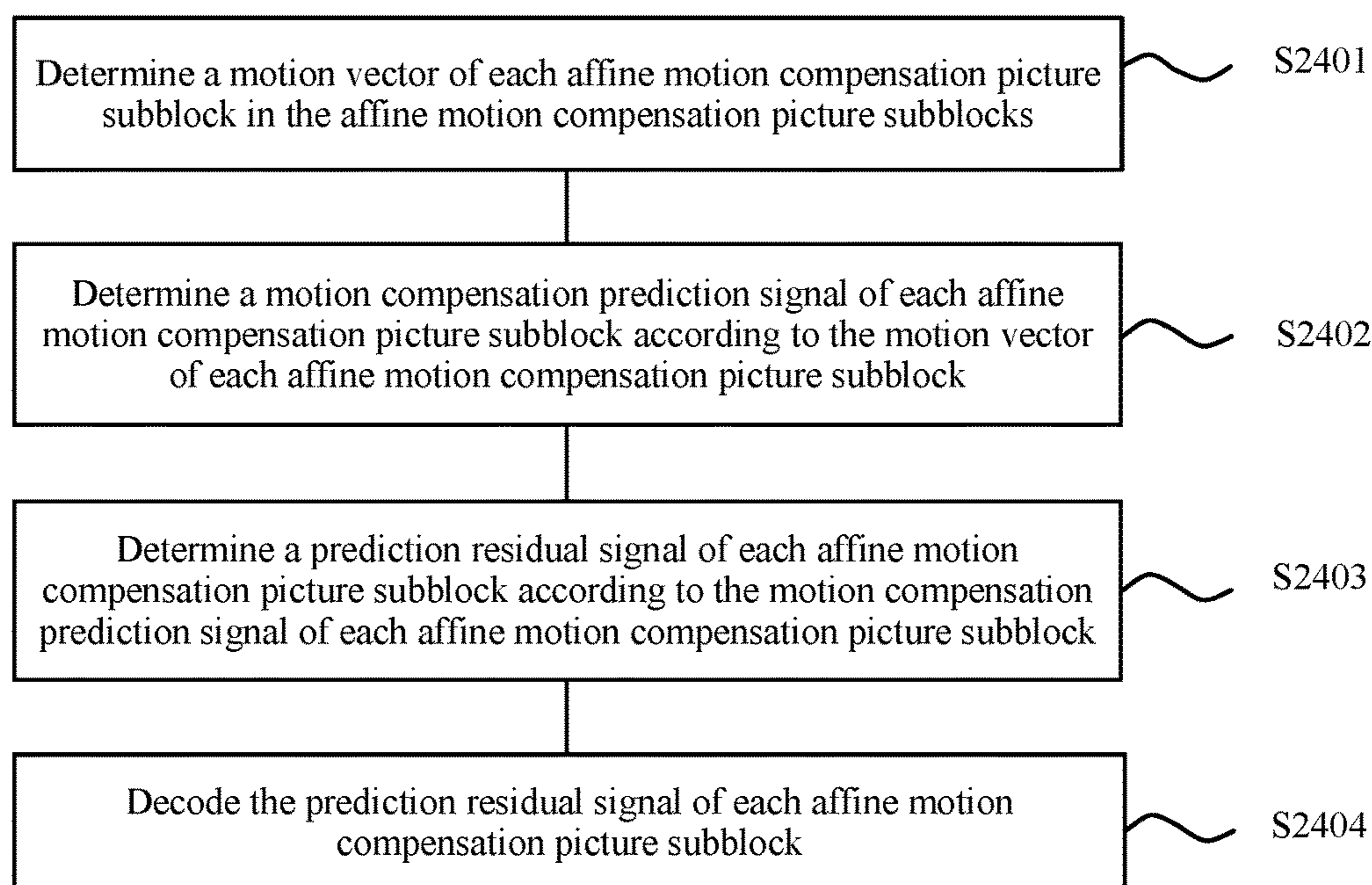


FIG. 18

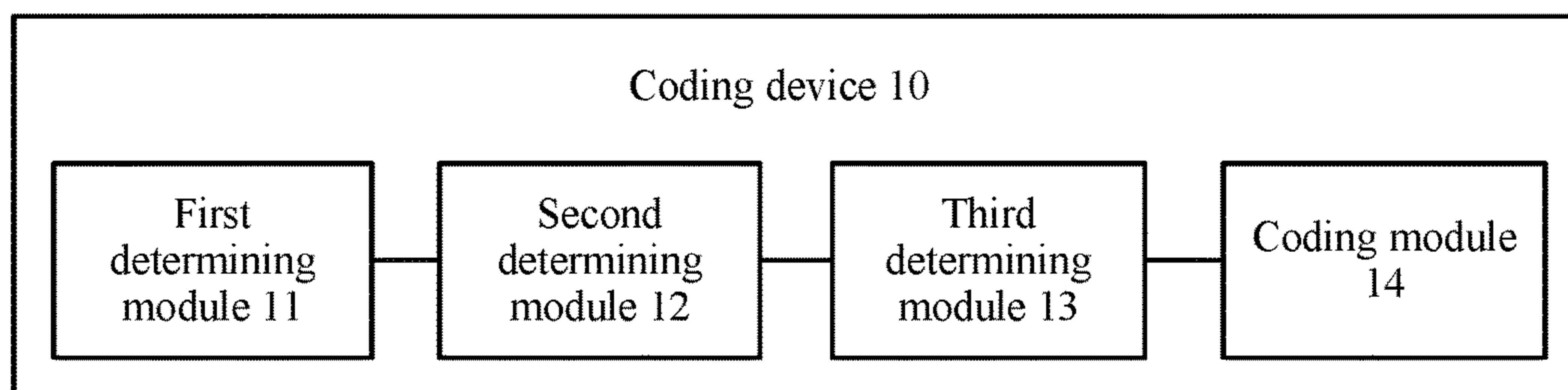


FIG. 19

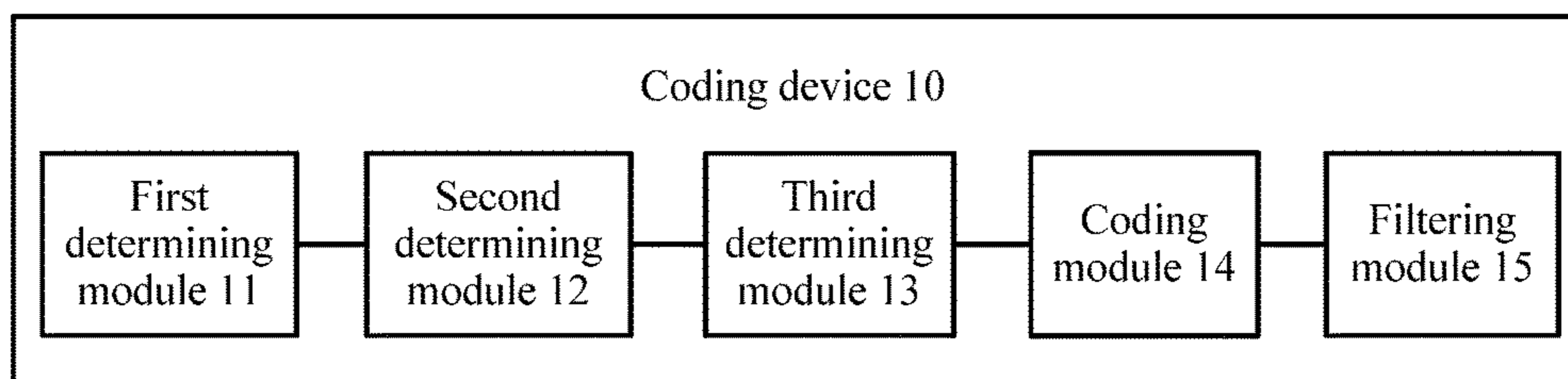


FIG. 20

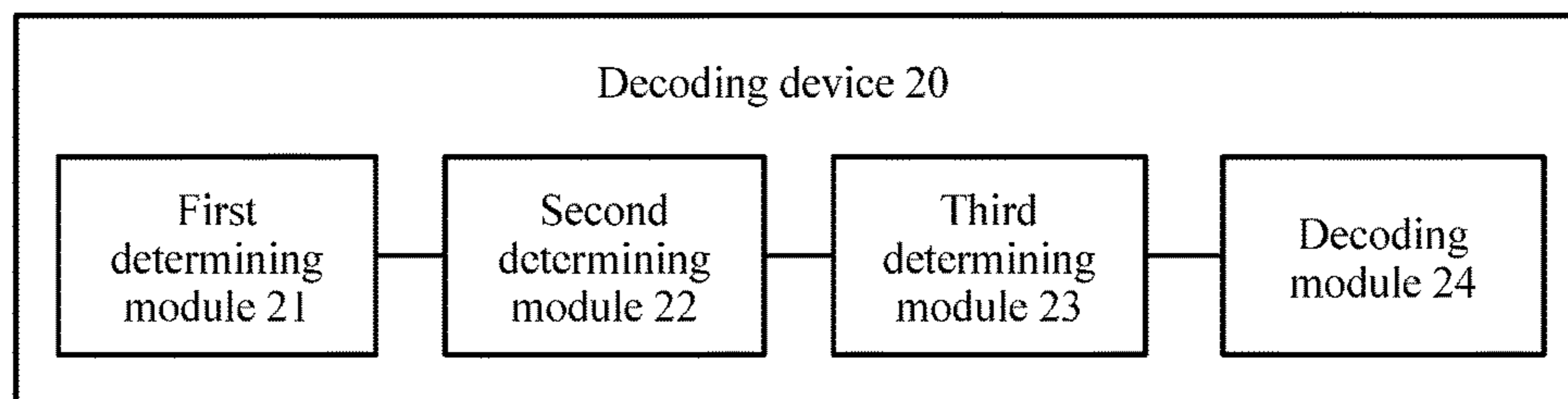


FIG. 21

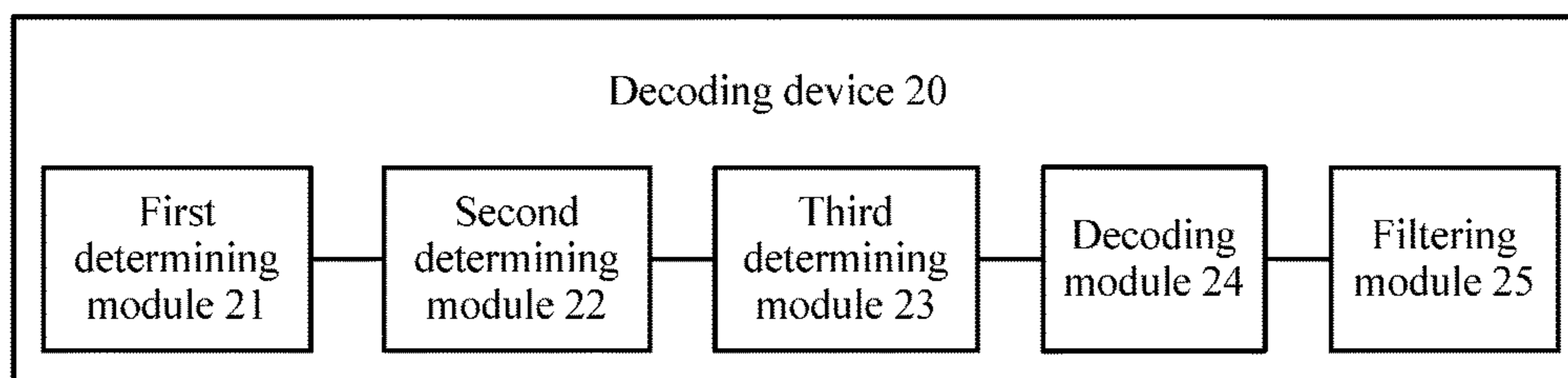


FIG. 22

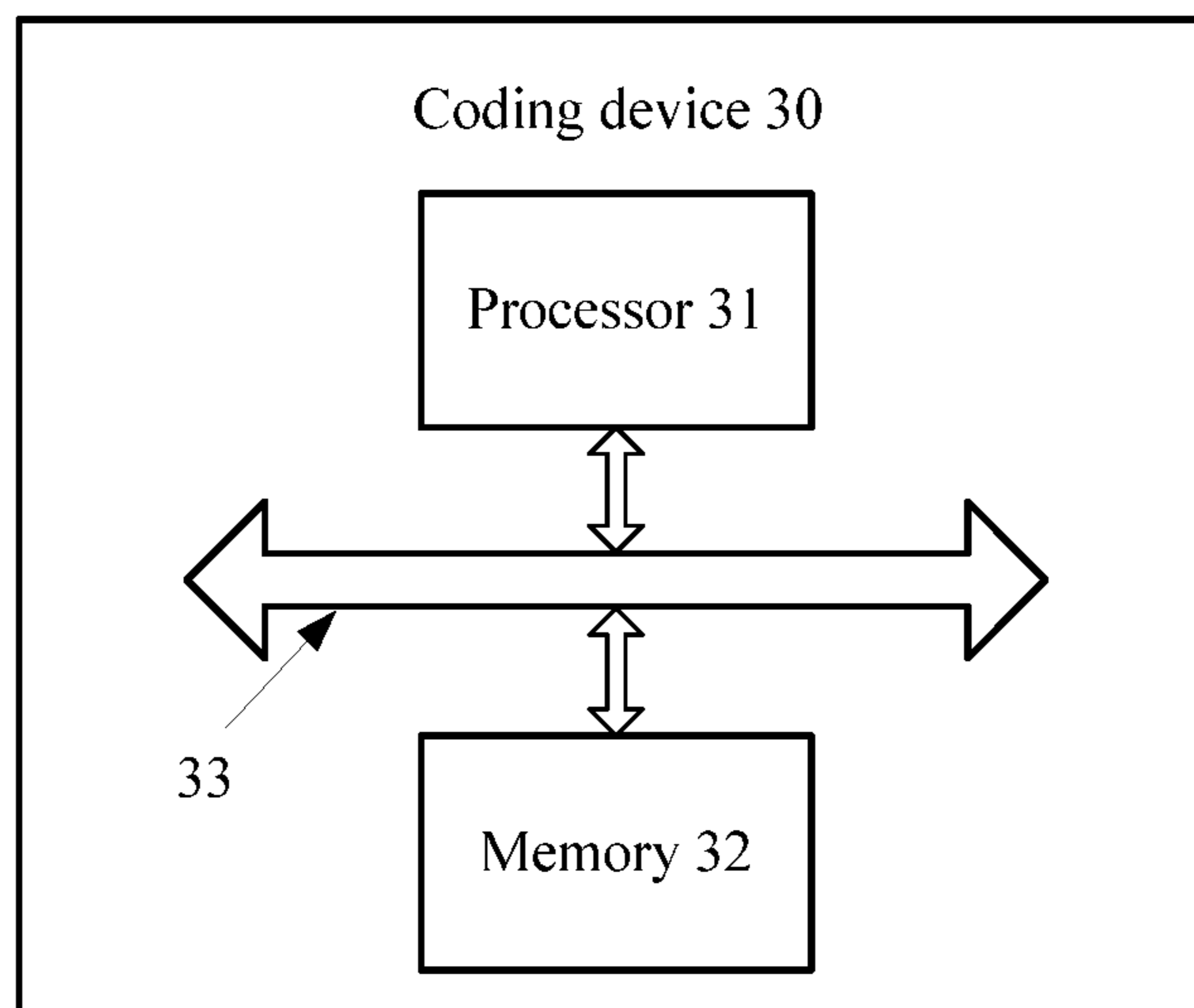


FIG. 23

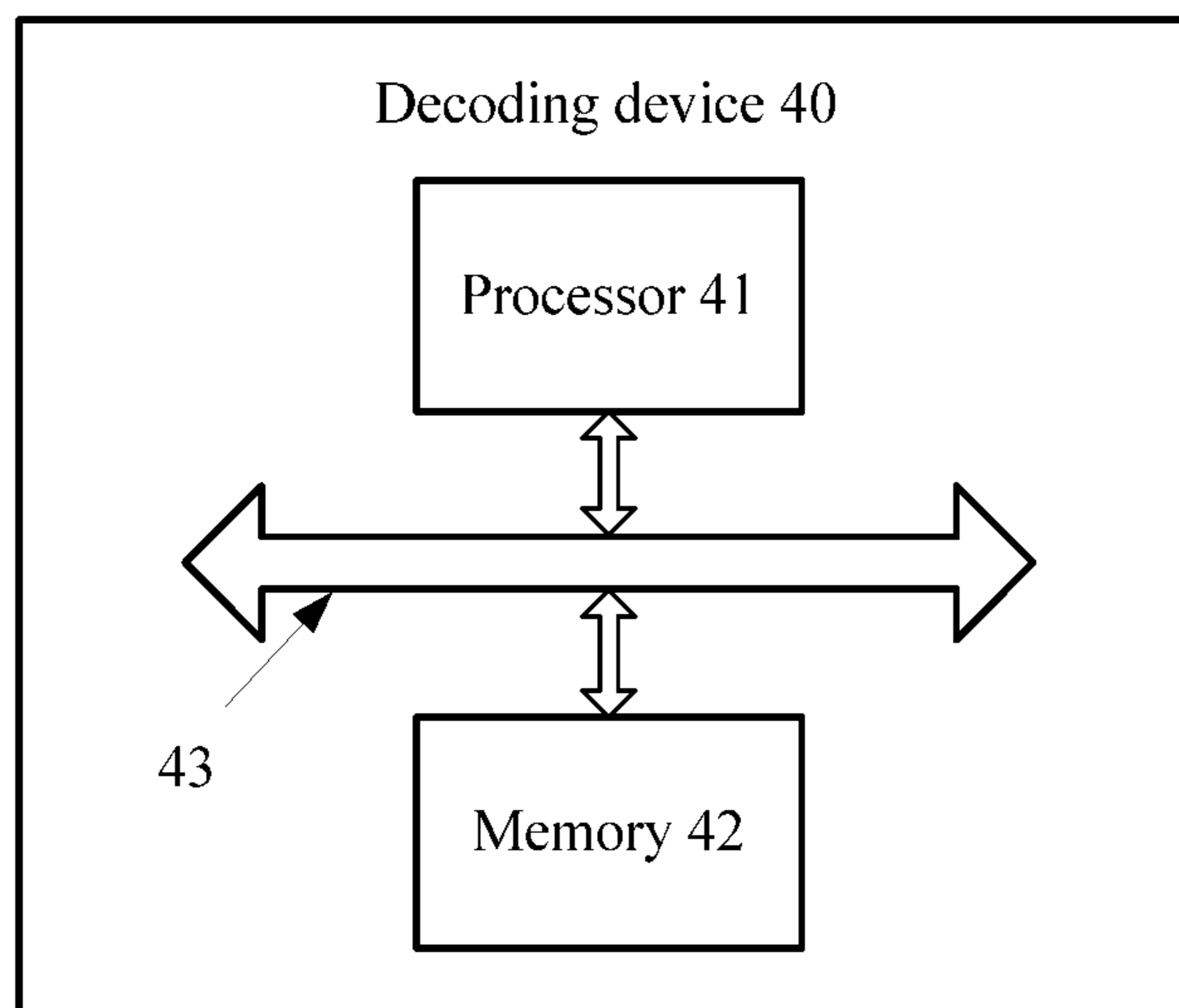


FIG. 24

**ADAPTIVE AFFINE MOTION
COMPENSATION UNIT DETERMINING IN
VIDEO PICTURE CODING METHOD, VIDEO
PICTURE DECODING METHOD, CODING
DEVICE, AND DECODING DEVICE**

CROSS-REFERENCE TO RELATED
APPLICATIONS

This application is a continuation of International Application No. PCT/CN2016/077784, filed on Mar. 30, 2016, which claims priority to Chinese Patent Application No. 201510249484.8, filed on May 15, 2015. The above mentioned applications are hereby incorporated by reference in their entireties.

TECHNICAL FIELD

The present invention relates to the field of video picture processing, and in particular, to a video picture coding method, a video picture decoding method, a coding device, and a decoding device.

BACKGROUND

As Internet technologies develop rapidly and material and spiritual cultures of people become richer, there are more requirements for video applications on the Internet, and in particular, requirements for high-definition video applications. However, a data volume of a high-definition video is huge, and a problem of compression coding of the high-definition video needs to be first resolved, so that the high-definition video can be transmitted on the bandwidth-limited Internet. Currently, two international organizations: the Motion Picture Experts Group (Motion Picture Experts Group, "MPEG" for short) under the International Organization for Standardization (International Organization for Standardization, "ISO" for short)/International Electrotechnical Commission (International Electrotechnical Commission, "IEC" for short) and the Video Coding Experts Group (Video Coding Experts Group, "VCEG" for short) under the International Telecommunication Union-Telecommunication Standardization Sector (International Telecommunication Union-Telecommunication standardization sector, "ITU-T" for short), are dedicated to developing international video coding standards. Established in 1986, the MPEG is dedicated to developing related standards in the multimedia field, where the standards are mainly applied to storage, broadcast and television, streaming media on the Internet or a wireless network, or the like. The ITU-T mainly develops video coding standards oriented to the real-time video communications field, such as videophone and videoconferencing applications.

In the past decades, international video coding standards oriented to various applications have been successfully developed, mainly including: the MPEG-1 standard applied to a video compact disc (Video Compact Disc, "VCD" for short), the MPEG-2 standard applied to a digital versatile disc (Digital Video Disc, "DVD" for short) and digital video broadcasting (Digital Video Broadcasting, "DVB" for short), the H.261 standard, H.263 standard, and H.264 standard applied to videoconferencing, the MPEG-4 standard allowing coding of an object in any form, and the latest High Efficiency Video Coding (High Efficiency Video Coding, "HEVC" for short) standard.

In comparison with the latest video coding standard HEVC, for a sequence including rotational or scaling

motion, a motion compensation prediction technology based on a linearly changing motion vector field can improve coding efficiency significantly. In a conventional motion compensation prediction technology based on affine transformation, after an affine transformation parameter of a picture block is obtained, a motion vector of each pixel in the picture block needs to be computed, motion compensation prediction is performed according to the motion vector of each pixel, and therefore, a motion compensation prediction signal of each pixel is obtained. Because the motion vector of each pixel in the picture block may vary, different operations need to be performed on the pixels according to the motion vectors. Complexity of pixel-based motion compensation prediction is very high. To reduce coding/decoding complexity, a related technology tries further dividing a picture block into picture subblocks, obtaining a motion vector of each picture subblock, and then obtaining a motion compensation prediction signal of each picture subblock.

However, in the related technology, sizes of the picture subblocks are fixed. If the picture subblocks are excessively small, relatively high coding/decoding complexity is caused. If the picture subblocks are excessively large, coding/decoding efficiency is reduced.

SUMMARY

The present invention provides a video picture coding method, a video picture decoding method, a coding device, and a decoding device to reduce coding/decoding complexity and improve coding/decoding efficiency by selecting a picture subblock of an appropriate size.

According to a first aspect, a video picture coding method is provided and includes: determining a motion vector difference of an affine picture block; determining motion vector precision of the affine picture block; determining a size of an affine motion compensation picture subblock in the affine picture block according to the motion vector difference, the motion vector precision, and a distance between control points in the affine picture block, where the control points are pixels used to determine the motion vector difference; and performing coding processing on the affine picture block according to the size of the affine motion compensation picture subblock.

With reference to the first aspect, in a first possible implementation of the first aspect, the determining a motion vector difference of an affine picture block includes: determining a first component of the motion vector difference according to a difference between motion vectors of a first control point and a second control point that are located on a same horizontal line; and determining a second component of the motion vector difference according to a difference between motion vectors of a third control point and a fourth control point that are located on a same vertical line; where a first horizontal distance exists between the first control point and the second control point, and a first vertical distance exists between the third control point and the fourth control point.

With reference to the first possible implementation of the first aspect, in a second possible implementation of the first aspect, the determining a first component of the motion vector difference according to a difference between motion vectors of a first control point and a second control point that are located on a same horizontal line includes: determining a first horizontal component difference and a first vertical component difference between the motion vectors of the first control point and the second control point; and determining a larger one of the first horizontal component difference and

3

the first vertical component difference as the first component of the motion vector difference; and the determining a second component of the motion vector difference according to a difference between motion vectors of a third control point and a fourth control point that are located on a same vertical line includes: determining a second horizontal component difference and a second vertical component difference between the motion vectors of the third control point and the fourth control point; and determining a larger one of the second horizontal component difference and the second vertical component difference as the second component of the motion vector difference.

With reference to the second possible implementation of the first aspect, in a third possible implementation of the first aspect, the method further includes: determining an affine transformation parameter of a pixel in the affine picture block, where pixels in the affine picture block have the same affine transformation parameter; the determining a first horizontal component difference and a first vertical component difference between the motion vectors of the first control point and the second control point includes: determining the first horizontal component difference and the first vertical component difference according to the affine transformation parameter and the first horizontal distance; and the determining a second horizontal component difference and a second vertical component difference between the motion vectors of the third control point and the fourth control point includes: determining the second horizontal component difference and the second vertical component difference according to the affine transformation parameter and the first vertical distance.

With reference to the second possible implementation of the first aspect, in a fourth possible implementation of the first aspect, the method further includes: determining a motion vector of the first control point, a motion vector of the second control point, a motion vector of the third control point, and a motion vector of the fourth control point; the determining a first horizontal component difference and a first vertical component difference between the motion vectors of the first control point and the second control point includes: determining a difference between a horizontal component of the motion vector of the first control point and a horizontal component of the motion vector of the second control point as the first horizontal component difference; and determining a difference between a vertical component of the motion vector of the first control point and a vertical component of the motion vector of the second control point as the first vertical component difference; and the determining a second horizontal component difference and a second vertical component difference between the motion vectors of the third control point and the fourth control point includes: determining a difference between a horizontal component of the motion vector of the third control point and a horizontal component of the motion vector of the fourth control point as the second horizontal component difference; and determining a difference between a vertical component of the motion vector of the third control point and a vertical component of the motion vector of the fourth control point as the second vertical component difference.

With reference to the second possible implementation of the first aspect, in a fifth possible implementation of the first aspect, the first control point and the second control point are two adjacent pixels, and the third control point and the fourth control point are two adjacent pixels; and the determining a first horizontal component difference and a first vertical component difference between the motion vectors of the first control point and the second control point, and the

4

determining a second horizontal component difference and a second vertical component difference between the motion vectors of the third control point and the fourth control point include: determining a motion vector of a first pixel, a motion vector of a second pixel, and a motion vector of a third pixel, where the first pixel, the second pixel, and the third pixel are non-overlapping pixels; determining a second horizontal distance and a second vertical distance between the first pixel and the second pixel; determining a third horizontal distance and a third vertical distance between the first pixel and the third pixel; and determining the first horizontal component difference, the first vertical component difference, the second horizontal component difference, and the second vertical component difference according to the motion vector of the first pixel, the motion vector of the second pixel, the motion vector of the third pixel, the second horizontal distance, the second vertical distance, the third horizontal distance, and the third vertical distance.

With reference to any one of the third to the fifth possible implementations of the first aspect, in a sixth possible implementation of the first aspect, the determining a size of an affine motion compensation picture subblock according to the motion vector difference, the motion vector precision, and a distance between control points in the affine picture block includes: determining a ratio of a product of the motion vector precision and the first horizontal distance to the first component of the motion vector difference as a length of the affine motion compensation picture subblock in a horizontal direction; and determining a ratio of a product of the motion vector precision and the first vertical distance to the second component of the motion vector difference as a length of the affine motion compensation picture subblock in a vertical direction.

With reference to any one of the third to the fifth possible implementations of the first aspect, in a seventh possible implementation of the first aspect, the determining a size of an affine motion compensation picture subblock in the affine picture block according to the motion vector difference, the motion vector precision, and a distance between control points in the affine picture block includes: when a ratio of a product of the motion vector precision and the first horizontal distance to the first component of the motion vector difference is greater than or equal to a first preset value, determining the ratio as a length of the affine motion compensation picture subblock in a horizontal direction; or when a ratio of a product of the motion vector precision and the first horizontal distance to the first component of the motion vector difference is less than the first preset value, determining the first preset value as a length of the affine motion compensation picture subblock in a horizontal direction; and when a ratio of a product of the motion vector precision and the first vertical distance to the second component of the motion vector difference is greater than or equal to a second preset value, determining the ratio as a length of the affine motion compensation picture subblock in a vertical direction; or when a ratio of a product of the motion vector precision and the first vertical distance to the second component of the motion vector difference is less than the second preset value, determining the second preset value as a length of the affine motion compensation picture subblock in a vertical direction.

With reference to any one of the first to the seventh possible implementations of the first aspect, in an eighth possible implementation of the first aspect, the first control point and the third control point are the same pixel.

With reference to any one of the first to the eighth possible implementations of the first aspect, in a ninth possible

5

implementation of the first aspect, the first control point, the second control point, the third control point, and the fourth control point are vertices of the affine picture block.

With reference to the seventh possible implementation of the first aspect, in a tenth possible implementation of the first aspect, the first preset value is 4, and/or the second preset value is 4.

With reference to any one of the first aspect, or the first to the tenth possible implementations of the first aspect, in an eleventh possible implementation of the first aspect, the determining motion vector precision of the affine picture block includes: determining a third preset value as the motion vector precision of the affine picture block; or determining the motion vector precision of the affine picture block according to a feature of a picture block adjacent to the affine picture block, where the adjacent picture block is a picture block spatially and/or temporally adjacent to the affine picture block.

With reference to any one of the first aspect, or the first to the eleventh possible implementations of the first aspect, in a twelfth possible implementation of the first aspect, the performing coding processing on the affine picture block according to the size of the affine motion compensation picture subblock includes: determining a motion vector of each affine motion compensation picture subblock in the affine motion compensation picture subblocks; determining a motion compensation prediction signal of each affine motion compensation picture subblock according to the motion vector of each affine motion compensation picture subblock; determining a prediction residual signal of each affine motion compensation picture subblock according to the motion compensation prediction signal of each affine motion compensation picture subblock; and coding the prediction residual signal of each affine motion compensation picture subblock.

With reference to the twelfth possible implementation of the first aspect, in a thirteenth possible implementation of the first aspect, the method further includes: filtering signals of boundary pixels of each affine motion compensation picture subblock, where the boundary pixels are pixels in one or more rows at a boundary of each affine motion compensation picture subblock.

With reference to the thirteenth possible implementation of the first aspect, in a fourteenth possible implementation of the first aspect, the signal of the boundary pixel includes a motion compensation prediction signal and/or a reconstructed signal, and the reconstructed signal is a sum of the motion compensation prediction signal and a reconstructed residual signal.

According to a second aspect, a video picture decoding method is provided and includes: determining a motion vector difference of an affine picture block; determining motion vector precision of the affine picture block; determining a size of an affine motion compensation picture subblock in the affine picture block according to the motion vector difference, the motion vector precision, and a distance between control points in the affine picture block, where the control points are pixels used to determine the motion vector difference; and performing decoding processing on the affine picture block according to the size of the affine motion compensation picture subblock.

With reference to the second aspect, in a first possible implementation of the second aspect, the determining a motion vector difference of an affine picture block includes: determining a first component of the motion vector difference according to a difference between motion vectors of a first control point and a second control point that are located

6

on a same horizontal line; and determining a second component of the motion vector difference according to a difference between motion vectors of a third control point and a fourth control point that are located on a same vertical line; where a first horizontal distance exists between the first control point and the second control point, and a first vertical distance exists between the third control point and the fourth control point.

With reference to the first possible implementation of the second aspect, in a second possible implementation of the second aspect, the determining a first component of the motion vector difference according to a difference between motion vectors of a first control point and a second control point that are located on a same horizontal line includes: determining a first horizontal component difference and a first vertical component difference between the motion vectors of the first control point and the second control point; and determining a larger one of the first horizontal component difference and the first vertical component difference as the first component of the motion vector difference; and the determining a second component of the motion vector difference according to a difference between motion vectors of a third control point and a fourth control point that are located on a same vertical line includes: determining a second horizontal component difference and a second vertical component difference between the motion vectors of the third control point and the fourth control point; and determining a larger one of the second horizontal component difference and the second vertical component difference as the second component of the motion vector difference.

With reference to the second possible implementation of the second aspect, in a third possible implementation of the second aspect, the method further includes: determining an affine transformation parameter of a pixel in the affine picture block, where pixels in the affine picture block have the same affine transformation parameter; the determining a first horizontal component difference and a first vertical component difference between the motion vectors of the first control point and the second control point includes: determining the first horizontal component difference and the first vertical component difference according to the affine transformation parameter and the first horizontal distance; and the determining a second horizontal component difference and a second vertical component difference between the motion vectors of the third control point and the fourth control point includes: determining the second horizontal component difference and the second vertical component difference according to the affine transformation parameter and the first vertical distance.

With reference to the second possible implementation of the second aspect, in a fourth possible implementation of the second aspect, the method further includes: determining a motion vector of the first control point, a motion vector of the second control point, a motion vector of the third control point, and a motion vector of the fourth control point; the determining a first horizontal component difference and a first vertical component difference between the motion vectors of the first control point and the second control point includes: determining a difference between a horizontal component of the motion vector of the first control point and a horizontal component of the motion vector of the second control point as the first horizontal component difference; and determining a difference between a vertical component of the motion vector of the first control point and a vertical component of the motion vector of the second control point as the first vertical component difference; and the determining a second horizontal component difference and a second

vertical component difference between the motion vectors of the third control point and the fourth control point includes: determining a difference between a horizontal component of the motion vector of the third control point and a horizontal component of the motion vector of the fourth control point as the second horizontal component difference; and determining a difference between a vertical component of the motion vector of the third control point and a vertical component of the motion vector of the fourth control point as the second vertical component difference.

With reference to the second possible implementation of the second aspect, in a fifth possible implementation of the second aspect, the first control point and the second control point are two adjacent pixels, and the third control point and the fourth control point are two adjacent pixels; and the determining a first horizontal component difference and a first vertical component difference between the motion vectors of the first control point and the second control point, and the determining a second horizontal component difference and a second vertical component difference between the motion vectors of the third control point and the fourth control point include: determining a motion vector of a first pixel, a motion vector of a second pixel, and a motion vector of a third pixel, where the first pixel, the second pixel, and the third pixel are non-overlapping pixels; determining a second horizontal distance and a second vertical distance between the first pixel and the second pixel; determining a third horizontal distance and a third vertical distance between the first pixel and the third pixel; and determining the first horizontal component difference, the first vertical component difference, the second horizontal component difference, and the second vertical component difference according to the motion vector of the first pixel, the motion vector of the second pixel, the motion vector of the third pixel, the second horizontal distance, the second vertical distance, the third horizontal distance, and the third vertical distance.

With reference to any one of the third to the fifth possible implementations of the second aspect, in a sixth possible implementation of the second aspect, the determining a size of an affine motion compensation picture subblock according to the motion vector difference, the motion vector precision, and a distance between control points in the affine picture block includes: determining a ratio of a product of the motion vector precision and the first horizontal distance to the first component of the motion vector difference as a length of the affine motion compensation picture subblock in a horizontal direction; and determining a ratio of a product of the motion vector precision and the first vertical distance to the second component of the motion vector difference as a length of the affine motion compensation picture subblock in a vertical direction.

With reference to any one of the third to the fifth possible implementations of the second aspect, in a seventh possible implementation of the second aspect, the determining a size of an affine motion compensation picture subblock in the affine picture block according to the motion vector difference, the motion vector precision, and a distance between control points in the affine picture block includes: when a ratio of a product of the motion vector precision and the first horizontal distance to the first component of the motion vector difference is greater than or equal to a first preset value, determining the ratio as a length of the affine motion compensation picture subblock in a horizontal direction; or when a ratio of a product of the motion vector precision and the first horizontal distance to the first component of the motion vector difference is less than the first preset value,

determining the first preset value as a length of the affine motion compensation picture subblock in a horizontal direction; and when a ratio of a product of the motion vector precision and the first vertical distance to the second component of the motion vector difference is greater than or equal to a second preset value, determining the ratio as a length of the affine motion compensation picture subblock in a vertical direction; or when a ratio of a product of the motion vector precision and the first vertical distance to the second component of the motion vector difference is less than the second preset value, determining the second preset value as a length of the affine motion compensation picture subblock in a vertical direction.

With reference to any one of the first to the seventh possible implementations of the second aspect, in an eighth possible implementation of the second aspect, the first control point and the third control point are the same pixel.

With reference to any one of the first to the eighth possible implementations of the second aspect, in a ninth possible implementation of the second aspect, the first control point, the second control point, the third control point, and the fourth control point are vertices of the affine picture block.

With reference to the seventh possible implementation of the second aspect, in a tenth possible implementation of the second aspect, the first preset value is 4, and/or the second preset value is 4.

With reference to any one of the second aspect, or the first to the tenth possible implementations of the second aspect, in an eleventh possible implementation of the second aspect, the determining motion vector precision of the affine picture block includes: determining a third preset value as the motion vector precision of the affine picture block; or determining the motion vector precision of the affine picture block according to a feature of a picture block adjacent to the affine picture block, where the adjacent picture block is a picture block spatially and/or temporally adjacent to the affine picture block.

With reference to any one of the second aspect, or the first to the eleventh possible implementations of the second aspect, in a twelfth possible implementation of the second aspect, the performing decoding processing on the affine picture block according to the size of the affine motion compensation picture subblock includes: determining a motion vector of each affine motion compensation picture subblock in the affine motion compensation picture subblocks; determining a motion compensation prediction signal of each affine motion compensation picture subblock according to the motion vector of each affine motion compensation picture subblock; determining a prediction residual signal of each affine motion compensation picture subblock according to the motion compensation prediction signal of each affine motion compensation picture subblock; and decoding the prediction residual signal of each affine motion compensation picture subblock.

With reference to the twelfth possible implementation of the second aspect, in a thirteenth possible implementation of the second aspect, the method further includes: filtering signals of boundary pixels of each affine motion compensation picture subblock, where the boundary pixels are pixels in one or more rows at a boundary of each affine motion compensation picture subblock.

With reference to the thirteenth possible implementation of the second aspect, in a fourteenth possible implementation of the second aspect, the signal of the boundary pixel includes a motion compensation prediction signal and/or a

reconstructed signal, and the reconstructed signal is a sum of the motion compensation prediction signal and a reconstructed residual signal.

According to a third aspect, a coding device is provided and includes: a first determining module, configured to determine a motion vector difference of an affine picture block; a second determining module, configured to determine motion vector precision of the affine picture block; a third determining module, configured to determine a size of an affine motion compensation picture subblock in the affine picture block according to the motion vector difference determined by the first determining module, the motion vector precision determined by the second determining module, and a distance between control points in the affine picture block, where the control points are pixels used to determine the motion vector difference; and a coding module, configured to perform coding processing on the affine picture block according to the size of the affine motion compensation picture subblock that is determined by the third determining module.

With reference to the third aspect, in a first possible implementation of the third aspect, the first determining module is specifically configured to: determine a first component of the motion vector difference according to a difference between motion vectors of a first control point and a second control point that are located on a same horizontal line; and determine a second component of the motion vector difference according to a difference between motion vectors of a third control point and a fourth control point that are located on a same vertical line; where a first horizontal distance exists between the first control point and the second control point, and a first vertical distance exists between the third control point and the fourth control point.

With reference to the first possible implementation of the third aspect, in a second possible implementation of the third aspect, the first determining module is specifically configured to: determine a first horizontal component difference and a first vertical component difference between the motion vectors of the first control point and the second control point; determine a larger one of the first horizontal component difference and the first vertical component difference as the first component of the motion vector difference; determine a second horizontal component difference and a second vertical component difference between the motion vectors of the third control point and the fourth control point; and determine a larger one of the second horizontal component difference and the second vertical component difference as the second component of the motion vector difference.

With reference to the second possible implementation of the third aspect, in a third possible implementation of the third aspect, the first determining module is specifically configured to: determine an affine transformation parameter of a pixel in the affine picture block, where pixels in the affine picture block have the same affine transformation parameter; determine the first horizontal component difference and the first vertical component difference according to the affine transformation parameter and the first horizontal distance; and determine the second horizontal component difference and the second vertical component difference according to the affine transformation parameter and the first vertical distance.

With reference to the second possible implementation of the third aspect, in a fourth possible implementation of the third aspect, the first determining module is specifically configured to: determine a motion vector of the first control point, a motion vector of the second control point, a motion vector of the third control point, and a motion vector of the

fourth control point; determine a difference between a horizontal component of the motion vector of the first control point and a horizontal component of the motion vector of the second control point as the first horizontal component difference; determine a difference between a vertical component of the motion vector of the first control point and a vertical component of the motion vector of the second control point as the first vertical component difference; determine a difference between a horizontal component of the motion vector of the third control point and a horizontal component of the motion vector of the fourth control point as the second horizontal component difference; and determine a difference between a vertical component of the motion vector of the third control point and a vertical component of the motion vector of the fourth control point as the second vertical component difference.

With reference to the second possible implementation of the third aspect, in a fifth possible implementation of the third aspect, the first control point and the second control point are two adjacent pixels, and the third control point and the fourth control point are two adjacent pixels; and the first determining module is specifically configured to: determine a motion vector of a first pixel, a motion vector of a second pixel, and a motion vector of a third pixel, where the first pixel, the second pixel, and the third pixel are non-overlapping pixels; determine a second horizontal distance and a second vertical distance between the first pixel and the second pixel; determine a third horizontal distance and a third vertical distance between the first pixel and the third pixel; and determine the first horizontal component difference, the first vertical component difference, the second horizontal component difference, and the second vertical component difference according to the motion vector of the first pixel, the motion vector of the second pixel, the motion vector of the third pixel, the second horizontal distance, the second vertical distance, the third horizontal distance, and the third vertical distance.

With reference to any one of the third to the fifth possible implementations of the third aspect, in a sixth possible implementation of the third aspect, the third determining module is specifically configured to: determine a ratio of a product of the motion vector precision and the first horizontal distance to the first component of the motion vector difference as a length of the affine motion compensation picture subblock in a horizontal direction; and determine a ratio of a product of the motion vector precision and the first vertical distance to the second component of the motion vector difference as a length of the affine motion compensation picture subblock in a vertical direction.

With reference to any one of the third to the fifth possible implementations of the third aspect, in a seventh possible implementation of the third aspect, the third determining module is specifically configured to: when a ratio of a product of the motion vector precision and the first horizontal distance to the first component of the motion vector difference is greater than or equal to a first preset value, determine the ratio as a length of the affine motion compensation picture subblock in a horizontal direction; or when a ratio of a product of the motion vector precision and the first horizontal distance to the first component of the motion vector difference is less than the first preset value, determine the first preset value as a length of the affine motion compensation picture subblock in a horizontal direction; and when a ratio of a product of the motion vector precision and the first vertical distance to the second component of the motion vector difference is greater than or equal to a second preset value, determine the ratio as a length of the affine

motion compensation picture subblock in a vertical direction; or when a ratio of a product of the motion vector precision and the first vertical distance to the second component of the motion vector difference is less than the second preset value, determine the second preset value as a length of the affine motion compensation picture subblock in a vertical direction.

With reference to any one of the first to the seventh possible implementations of the third aspect, in an eighth possible implementation of the third aspect, the first control point and the third control point are the same pixel.

With reference to any one of the first to the eighth possible implementations of the third aspect, in a ninth possible implementation of the third aspect, the first control point, the second control point, the third control point, and the fourth control point are vertices of the affine picture block.

With reference to the seventh possible implementation of the third aspect, in a tenth possible implementation of the third aspect, the first preset value is 4, and/or the second preset value is 4.

With reference to any one of the third aspect, or the first to the tenth possible implementations of the third aspect, in an eleventh possible implementation of the third aspect, the second determining module is specifically configured to: determine a third preset value as the motion vector precision of the affine picture block; or determine the motion vector precision of the affine picture block according to a feature of a picture block adjacent to the affine picture block, where the adjacent picture block is a picture block spatially and/or temporally adjacent to the affine picture block.

With reference to any one of the third aspect, or the first to the eleventh possible implementations of the third aspect, in a twelfth possible implementation of the third aspect, the coding module is specifically configured to: determine a motion vector of each affine motion compensation picture subblock in the affine motion compensation picture subblocks; determine a motion compensation prediction signal of each affine motion compensation picture subblock according to the motion vector of each affine motion compensation picture subblock; determine a prediction residual signal of each affine motion compensation picture subblock according to the motion compensation prediction signal of each affine motion compensation picture subblock; and code the prediction residual signal of each affine motion compensation picture subblock.

With reference to the twelfth possible implementation of the third aspect, in a thirteenth possible implementation of the third aspect, the coding device further includes: a filtering module, configured to filter signals of boundary pixels of each affine motion compensation picture subblock, where the boundary pixels are pixels in one or more rows at a boundary of each affine motion compensation picture subblock.

With reference to the thirteenth possible implementation of the third aspect, in a fourteenth possible implementation of the third aspect, the signal of the boundary pixel includes a motion compensation prediction signal and/or a reconstructed signal, and the reconstructed signal is a sum of the motion compensation prediction signal and a reconstructed residual signal.

According to a fourth aspect, a decoding device is provided and includes: a first determining module, configured to determine a motion vector difference of an affine picture block; a second determining module, configured to determine motion vector precision of the affine picture block; a third determining module, configured to determine a size of an affine motion compensation picture subblock in the affine

picture block according to the motion vector difference determined by the first determining module, the motion vector precision determined by the second determining module, and a distance between control points in the affine picture block, where the control points are pixels used to determine the motion vector difference; and a decoding module, configured to perform decoding processing on the affine picture block according to the size of the affine motion compensation picture subblock that is determined by the third determining module.

With reference to the fourth aspect, in a first possible implementation of the fourth aspect, the first determining module is specifically configured to: determine a first component of the motion vector difference according to a difference between motion vectors of a first control point and a second control point that are located on a same horizontal line; and determine a second component of the motion vector difference according to a difference between motion vectors of a third control point and a fourth control point that are located on a same vertical line; where a first horizontal distance exists between the first control point and the second control point, and a first vertical distance exists between the third control point and the fourth control point.

With reference to the first possible implementation of the fourth aspect, in a second possible implementation of the fourth aspect, the first determining module is specifically configured to: determine a first horizontal component difference and a first vertical component difference between the motion vectors of the first control point and the second control point; determine a larger one of the first horizontal component difference and the first vertical component difference as the first component of the motion vector difference; determine a second horizontal component difference and a second vertical component difference between the motion vectors of the third control point and the fourth control point; and determine a larger one of the second horizontal component difference and the second vertical component difference as the second component of the motion vector difference.

With reference to the second possible implementation of the fourth aspect, in a third possible implementation of the fourth aspect, the first determining module is specifically configured to: determine an affine transformation parameter of a pixel in the affine picture block, where pixels in the affine picture block have the same affine transformation parameter; determine the first horizontal component difference and the first vertical component difference according to the affine transformation parameter and the first horizontal distance; and determine the second horizontal component difference and the second vertical component difference according to the affine transformation parameter and the first vertical distance.

With reference to the second possible implementation of the fourth aspect, in a fourth possible implementation of the fourth aspect, the first determining module is specifically configured to: determine a motion vector of the first control point, a motion vector of the second control point, a motion vector of the third control point, and a motion vector of the fourth control point; determine a difference between a horizontal component of the motion vector of the first control point and a horizontal component of the motion vector of the second control point as the first horizontal component difference; determine a difference between a vertical component of the motion vector of the first control point and a vertical component of the motion vector of the second control point as the first vertical component difference; determine a difference between a horizontal compo-

ment of the motion vector of the third control point and a horizontal component of the motion vector of the fourth control point as the second horizontal component difference; and determine a difference between a vertical component of the motion vector of the third control point and a vertical component of the motion vector of the fourth control point as the second vertical component difference.

With reference to the second possible implementation of the fourth aspect, in a fifth possible implementation of the fourth aspect, the first control point and the second control point are two adjacent pixels, and the third control point and the fourth control point are two adjacent pixels; and the first determining module is specifically configured to: determine a motion vector of a first pixel, a motion vector of a second pixel, and a motion vector of a third pixel, where the first pixel, the second pixel, and the third pixel are non-overlapping pixels; determine a second horizontal distance and a second vertical distance between the first pixel and the second pixel; determine a third horizontal distance and a third vertical distance between the first pixel and the third pixel; and determine the first horizontal component difference, the first vertical component difference, the second horizontal component difference, and the second vertical component difference according to the motion vector of the first pixel, the motion vector of the second pixel, the motion vector of the third pixel, the second horizontal distance, the second vertical distance, the third horizontal distance, and the third vertical distance.

With reference to any one of the third to the fifth possible implementations of the fourth aspect, in a sixth possible implementation of the fourth aspect, the third determining module is specifically configured to: determine a ratio of a product of the motion vector precision and the first horizontal distance to the first component of the motion vector difference as a length of the affine motion compensation picture subblock in a horizontal direction; and determine a ratio of a product of the motion vector precision and the first vertical distance to the second component of the motion vector difference as a length of the affine motion compensation picture subblock in a vertical direction.

With reference to any one of the third to the fifth possible implementations of the fourth aspect, in a seventh possible implementation of the fourth aspect, the third determining module is specifically configured to: when a ratio of a product of the motion vector precision and the first horizontal distance to the first component of the motion vector difference is greater than or equal to a first preset value, determine the ratio as a length of the affine motion compensation picture subblock in a horizontal direction; or when a ratio of a product of the motion vector precision and the first horizontal distance to the first component of the motion vector difference is less than the first preset value, determine the first preset value as a length of the affine motion compensation picture subblock in a horizontal direction; and when a ratio of a product of the motion vector precision and the first vertical distance to the second component of the motion vector difference is greater than or equal to a second preset value, determine the ratio as a length of the affine motion compensation picture subblock in a vertical direction; or when a ratio of a product of the motion vector precision and the first vertical distance to the second component of the motion vector difference is less than the second preset value, determine the second preset value as a length of the affine motion compensation picture subblock in a vertical direction.

With reference to any one of the first to the seventh possible implementations of the fourth aspect, in an eighth

possible implementation of the fourth aspect, the first control point and the third control point are the same pixel.

With reference to any one of the first to the eighth possible implementations of the fourth aspect, in a ninth possible implementation of the fourth aspect, the first control point, the second control point, the third control point, and the fourth control point are vertices of the affine picture block.

With reference to the seventh possible implementation of the fourth aspect, in a tenth possible implementation of the fourth aspect, the first preset value is 4, and/or the second preset value is 4.

With reference to any one of the fourth aspect, or the first to the tenth possible implementations of the fourth aspect, in an eleventh possible implementation of the fourth aspect, the second determining module is specifically configured to: determine a third preset value as the motion vector precision of the affine picture block; or determine the motion vector precision of the affine picture block according to a feature of a picture block adjacent to the affine picture block, where the adjacent picture block is a picture block spatially and/or temporally adjacent to the affine picture block.

With reference to any one of the fourth aspect, or the first to the eleventh possible implementations of the fourth aspect, in a twelfth possible implementation of the fourth aspect, the decoding module is specifically configured to: determine a motion vector of each affine motion compensation picture subblock in the affine motion compensation picture subblocks; determine a motion compensation prediction signal of each affine motion compensation picture subblock according to the motion vector of each affine motion compensation picture subblock; determine a prediction residual signal of each affine motion compensation picture subblock according to the motion compensation prediction signal of each affine motion compensation picture subblock; and decode the prediction residual signal of each affine motion compensation picture subblock.

With reference to the twelfth possible implementation of the fourth aspect, in a thirteenth possible implementation of the fourth aspect, the decoding device further includes: a filtering module, configured to filter signals of boundary pixels of each affine motion compensation picture subblock, where the boundary pixels are pixels in one or more rows at a boundary of each affine motion compensation picture subblock.

With reference to the thirteenth possible implementation of the fourth aspect, in a fourteenth possible implementation of the fourth aspect, the signal of the boundary pixel includes a motion compensation prediction signal and/or a reconstructed signal, and the reconstructed signal is a sum of the motion compensation prediction signal and a reconstructed residual signal.

Based on the foregoing technical solutions, according to the video picture coding method, the video picture decoding method, the coding device, and the decoding device in the embodiments of the present invention, a size of an affine motion compensation picture subblock in an affine picture block is determined according to a motion vector difference of the affine picture block, motion vector precision of the affine picture block, and a distance between control points in the affine picture block. In this way, a picture subblock of an appropriate size is selected in a coding/decoding process, so that coding/decoding complexity can be reduced, and coding/decoding efficiency can be improved.

BRIEF DESCRIPTION OF THE DRAWINGS

To describe the technical solutions in the embodiments of the present invention more clearly, the following briefly

15

describes the accompanying drawings required for describing the embodiments of the present invention. Apparently, the accompanying drawings in the following description show merely some embodiments of the present invention, and a person of ordinary skill in the art may still derive other drawings from these accompanying drawings without creative efforts.

FIG. 1 is a schematic flowchart of a video picture coding method according to an embodiment of the present invention;

FIG. 2 is another schematic flowchart of a video picture coding method according to an embodiment of the present invention;

FIG. 3 is still another schematic flowchart of a video picture coding method according to an embodiment of the present invention;

FIG. 4 is still another schematic flowchart of a video picture coding method according to an embodiment of the present invention;

FIG. 5 is a schematic diagram of an affine picture block and control points according to an embodiment of the present invention;

FIG. 6 is a schematic diagram of three non-overlapping pixels in an affine picture block according to an embodiment of the present invention;

FIG. 7 is another schematic diagram of an affine picture block according to an embodiment of the present invention;

FIG. 8 is still another schematic flowchart of a video picture coding method according to an embodiment of the present invention;

FIG. 9 is still another schematic flowchart of a video picture coding method according to an embodiment of the present invention;

FIG. 10 is still another schematic flowchart of a video picture coding method according to an embodiment of the present invention;

FIG. 11 is still another schematic diagram of an affine picture block according to an embodiment of the present invention;

FIG. 12 is a schematic flowchart of a video picture decoding method according to an embodiment of the present invention;

FIG. 13 is another schematic flowchart of a video picture decoding method according to an embodiment of the present invention;

FIG. 14 is still another schematic flowchart of a video picture decoding method according to an embodiment of the present invention;

FIG. 15 is still another schematic flowchart of a video picture decoding method according to an embodiment of the present invention;

FIG. 16 is still another schematic flowchart of a video picture decoding method according to an embodiment of the present invention;

FIG. 17 is still another schematic flowchart of a video picture decoding method according to an embodiment of the present invention;

FIG. 18 is still another schematic flowchart of a video picture decoding method according to an embodiment of the present invention;

FIG. 19 is a schematic block diagram of a coding device according to an embodiment of the present invention;

FIG. 20 is another schematic block diagram of a coding device according to an embodiment of the present invention;

FIG. 21 is a schematic block diagram of a decoding device according to an embodiment of the present invention;

16

FIG. 22 is another schematic block diagram of a decoding device according to an embodiment of the present invention;

FIG. 23 is a schematic block diagram of a coding device according to another embodiment of the present invention; and

FIG. 24 is a schematic block diagram of a decoding device according to another embodiment of the present invention.

DETAILED DESCRIPTION OF ILLUSTRATIVE EMBODIMENTS

The following clearly describes the technical solutions in the embodiments of the present invention with reference to the accompanying drawings in the embodiments of the present invention. Apparently, the described embodiments are some rather than all of the embodiments of the present invention. All other embodiments obtained by a person of ordinary skill in the art based on the embodiments of the present invention without creative efforts shall fall within the protection scope of the present invention.

FIG. 1 shows a schematic flowchart of a video picture coding method according to an embodiment of the present invention. The method shown in FIG. 1 may be performed by a coding device, for example, an encoder. Specifically, as shown in FIG. 1, the method 1000 includes the following steps.

S1100. Determine a motion vector difference of an affine picture block.

S1200. Determine motion vector precision of the affine picture block.

S1300. Determine a size of an affine motion compensation picture subblock in the affine picture block according to the motion vector difference, the motion vector precision, and a distance between control points in the affine picture block, where the control points are pixels used to determine the motion vector difference.

S1400. Perform coding processing on the affine picture block according to the size of the affine motion compensation picture subblock.

Specifically, the coding device determines the motion vector difference of the affine picture block according to the determined control points, determines the motion vector precision of the affine picture block, determines the size of the affine motion compensation picture subblock in the affine picture block according to the determined motion vector difference, the determined motion vector precision, and the distance between the control points, and performs coding processing on the affine picture block according to the determined size.

Therefore, in the video picture coding method according to this embodiment of the present invention, the coding device determines the size of the affine motion compensation picture subblock according to the determined motion vector difference of the affine picture block, the determined motion vector precision, and the distance between the control points, and performs coding processing on the affine picture block according to the size of the affine motion compensation picture subblock. In this way, a picture subblock of an appropriate size is selected in a coding process, so that coding complexity can be reduced, and coding efficiency can be improved.

It should be understood that, in this embodiment of the present invention, the affine (Affine) picture block is a picture block in which motion vectors of all units comply with same affine models, for example, a same affine model which may be indicated by same parameters, for example, a

same group of parameters. The unit is a group of pixels, for example, may be a pixel, or may be a block structure such as 1×3 or 2×4. This is not limited in the present invention.

It should be understood that, in this embodiment of the present invention, the affine motion compensation (Affine Motion Compensation, “Affine-MC” for short) picture sub-block is a picture subblock that is obtained by dividing the affine picture block and used for performing motion compensation prediction, and affine-MC picture subblocks may have a same size or different sizes. This is not limited in the present invention.

It should also be understood that, in this embodiment of the present invention, any non-overlapping pixels may be selected as control points to determine the motion vector difference of the affine picture block. This is not limited in the present invention.

Preferably, as shown in FIG. 2, S1100 includes the following steps:

S1101. Determine a first component of the motion vector difference according to a difference between motion vectors of a first control point and a second control point that are located on a same horizontal line.

S1102. Determine a second component of the motion vector difference according to a difference between motion vectors of a third control point and a fourth control point that are located on a same vertical line.

A first horizontal distance exists between the first control point and the second control point, and a first vertical distance exists between the third control point and the fourth control point.

It should be understood that, in this embodiment of the present invention, the first component of the motion vector difference is a horizontal component of the motion vector difference, and the second component of the motion vector difference is a vertical component of the motion vector difference.

It should also be understood that, in this embodiment of the present invention, first, second, third, and fourth are only intended to distinguish between pixels and shall not be construed as any limitation to the protection scope of the present invention. For example, the first control point may also be referred to as the second control point, and the second control point may become the first control point.

In this embodiment of the present invention, optionally, the first control point and the third control point are the same pixel. That is, a quantity of selected control points is three, and one of the three control points is located on a same horizontal line as one of the other two control points, and is located on a same vertical line as the other one of the two control points.

In this embodiment of the present invention, optionally, the first control point, the second control point, the third control point, and the fourth control point are vertices of the affine picture block. Assuming that four vertices of one affine picture block are marked as a vertex in an upper left corner, a vertex in a lower left corner, a vertex in an upper right corner, and a vertex in a lower right corner respectively, any three vertices located in two orthogonal directions may be selected to determine a motion vector difference of the affine picture block. For example, the vertex in the upper left corner, the vertex in the lower left corner, and the vertex in the upper right corner may be selected, or the vertex in the upper left corner, the vertex in the upper right corner, and the vertex in the lower right corner may be selected. This is not limited in the present invention.

In this embodiment of the present invention, optionally, a difference between components in either direction, in com-

ponents in two directions of the motion vectors of the first control point and the second control point may be determined as the first component of the motion vector difference of the affine picture block, and a difference between components in either direction, in components in two directions of the motion vectors of the third control point and the fourth control point may be determined as the second component of the motion vector difference of the affine picture block; or according to actual requirements for coding complexity and coding efficiency, a numeric value between two differences of components in two directions of the motion vectors of the first control point and the second control point may be determined as the first component, and a numeric value between two differences of components in two directions of the motion vectors of the third control point and the fourth control point may be determined as the second component. This is not limited in the present invention.

Optionally, as shown in FIG. 3, S1101 specifically includes the following steps:

S1103. Determine a first horizontal component difference and a first vertical component difference between the motion vectors of the first control point and the second control point.

S1104. Determine a larger one of the first horizontal component difference and the first vertical component difference as the first component of the motion vector difference.

Correspondingly, as shown in FIG. 4, S1102 specifically includes the following steps:

S1105. Determine a second horizontal component difference and a second vertical component difference between the motion vectors of the third control point and the fourth control point.

S1106. Determine a larger one of the second horizontal component difference and the second vertical component difference as the second component of the motion vector difference.

That is, if $vx_{(x,y)}$ and $vy_{(x,y)}$ are used to indicate a horizontal component and a vertical component of a motion vector of a pixel in a position (x,y) , the motion vector difference of the affine picture block may be determined according to formulas (1) and (2):

$$\Delta mv_{hor} = \max(vx_{(x+w,y)} - vx_{(x,y)}, vy_{(x+w,y)} - vy_{(x,y)}) \quad (1)$$

$$\Delta mv_{ver} = \max(vx_{(x',y'+h)} - vx_{(x',y')}, vy_{(x',y'+h)} - vy_{(x',y')}) \quad (2)$$

where \max indicates a maximum value, Δmv_{hor} indicates the horizontal component of the motion vector difference of the affine picture block, Δmv_{ver} indicates the vertical component of the motion vector difference of the affine picture block, w indicates the first horizontal distance between the first control point and the second control point, and h indicates the first vertical distance between the third control point and the fourth control point.

In this embodiment of the present invention, optionally, an affine transformation parameter of a pixel in the affine picture block may be determined, and pixels in the affine picture block have the same affine transformation parameter.

Correspondingly, S1103 is specifically: determining the first horizontal component difference and the first vertical component difference according to the affine transformation parameter and the first horizontal distance.

S1105 is specifically: determining the second horizontal component difference and the second vertical component difference according to the affine transformation parameter and the first vertical distance.

It should be understood that, sequence numbers of the foregoing processes do not mean execution sequences. The execution sequences of the processes should be determined according to functions and internal logic of the processes, and should not be construed as any limitation to the implementation processes of the embodiments of the present invention.

In this embodiment of the present invention, optionally, an affine transformation model may be a 6-parameter affine transformation model in the prior art, or may be a 4-parameter or 2-parameter affine transformation model. In the 6-parameter affine transformation model, it is assumed that (x, y) are coordinates of a pixel P in a current picture, and (x', y') are coordinates of a pixel P' that is in a reference picture and matches the pixel P, and a, b, c, d, e, and f are affine transformation parameters. If the affine transformation parameters are known, a position (x', y') of the pixel (x, y) in the reference picture may be obtained, and therefore, a prediction signal of the pixel may be obtained from the reference picture:

$$x' = ax + by + e \quad (3)$$

$$y' = cx + dy + f \quad (4)$$

Generally, the affine transformation parameters may be obtained through computation according to motion vectors of some pixels in the picture block, and a horizontal component and a vertical component of a motion vector may be indicated by formulas (5) and (6) respectively:

$$vx = x - x' \quad (5)$$

$$vy = y - y' \quad (6)$$

The formula (3) is substituted into the formula (5), and the formula (4) is substituted into the formula (6), to obtain a horizontal component and a vertical component of a motion vector of the pixel whose coordinates are (x, y), as shown in formulas (7) and (8) respectively:

$$vx = (1-a)x - by - e \quad (7)$$

$$vy = (1-d)y - cx - f \quad (8)$$

The formula (7) is substituted into the formula (1), and the formula (8) is substituted into the formula (2), so that the formulas (1) and (2) are converted into formulas (9) and (10) respectively:

$$\Delta mv_{hor} = \max((1-a)w, -cw) \quad (9)$$

$$\Delta mv_{ver} = \max(-bh, (1-d)h) \quad (10)$$

By means of determining the affine transformation parameters a, b, c, and d, and the distance between the control points, the first component and the second component of the motion vector difference of the affine picture block may be determined.

It should be understood that, when the 4-parameter affine transformation model or the 2-parameter affine transformation model is used, the method for determining the motion vector difference is essentially the same as the determining method when the 6-parameter affine transformation model is used. For brevity, details are not described again herein.

In this embodiment of the present invention, optionally, in the coding process, the affine transformation parameter may be obtained by computing each parameter iteratively, for example, adding 1 to the parameter a to determine whether a motion compensation prediction signal in the model is optimal. Alternatively, the affine transformation parameter may be obtained through derivation according to an affine

transformation parameter of an adjacent affine picture block. However, the present invention is not limited thereto.

In this embodiment of the present invention, optionally, a motion vector of the first control point, a motion vector of the second control point, a motion vector of the third control point, and a motion vector of the fourth control point may be determined.

Correspondingly, S1103 is specifically: determining a difference between a horizontal component of the motion vector of the first control point and a horizontal component of the motion vector of the second control point as the first horizontal component difference; and determining a difference between a vertical component of the motion vector of the first control point and a vertical component of the motion vector of the second control point as the first vertical component difference.

S1105 is specifically: determining a difference between a horizontal component of the motion vector of the third control point and a horizontal component of the motion vector of the fourth control point as the second horizontal component difference; and determining a difference between a vertical component of the motion vector of the third control point and a vertical component of the motion vector of the fourth control point as the second vertical component difference.

Specifically, the motion vectors of the control points may be directly determined. By means of computing the differences between the components of the motion vectors, the first component and the second component of the motion vector difference of the affine picture block may be directly obtained.

For example, FIG. 5 is a schematic diagram of an affine picture block and control points according to an embodiment of the present invention. Two control points A and B are on a same horizontal line, and have a distance w. Two control points C and D are on a same vertical line, and have a distance h. If motion vectors of the control points A, B, C, and D are known, the first component and the second component of the motion vector difference of the affine picture block may be determined according to formulas (11) and (12):

$$\Delta mv_{hor} = \max(vx_B - vx_A, vy_B - vy_A) \quad (11)$$

$$\Delta mv_{ver} = \max(vx_C - vx_D, vy_C - vy_D) \quad (12)$$

In this embodiment of the present invention, optionally, the control points A and C may be the same pixel.

In this embodiment of the present invention, optionally, the control points A, B, C, and D may be vertices of the affine picture block. In this case, a distance between the control points A and B is a width W of the affine picture block, and a distance between the control points C and D is a height H of the affine picture block.

In this embodiment of the present invention, optionally, the first control point and the second control point are two adjacent pixels, and the third control point and the fourth control point are two adjacent pixels.

S1103 and S1105 are specifically: determining a motion vector of a first pixel, a motion vector of a second pixel, and a motion vector of a third pixel, where the first pixel, the second pixel, and the third pixel are non-overlapping pixels; determining a second horizontal distance and a second vertical distance between the first pixel and the second pixel; determining a third horizontal distance and a third vertical distance between the first pixel and the third pixel; and determining the first horizontal component difference, the first vertical component difference, the second horizontal

component difference, and the second vertical component difference according to the motion vector of the first pixel, the motion vector of the second pixel, the motion vector of the third pixel, the second horizontal distance, the second vertical distance, the third horizontal distance, and the third vertical distance.

Specifically, assuming that A, B, and C are any three non-overlapping pixels in the picture block, positions of the three pixels are shown in FIG. 6, and motion vectors of the three pixels are (vx_A, vy_A) , (vx_B, vy_B) , and (vx_C, vy_C) respectively. A distance between the pixel A and the pixel B in a horizontal direction is w_1 , and a distance in a vertical direction is h_1 . A distance between the pixel A and the pixel C in the horizontal direction is w_2 , and a distance in the vertical direction is h_2 . A distance between the pixel B and the pixel C in the horizontal direction is $w_2 - w_1$, and a distance in the vertical direction is $h_1 + h_2$. It is assumed that horizontal component differences of motion vectors of two adjacent pixels in the horizontal direction are $\Delta mv_{x_{hor}}$ and $\Delta mv_{y_{hor}}$ respectively, and vertical component differences of motion vectors of two adjacent pixels in the vertical direction are $\Delta mv_{x_{ver}}$ and $\Delta mv_{y_{ver}}$ respectively. Because motion vectors in the picture block change linearly, $\Delta mv_{x_{hor}}$, $\Delta mv_{y_{hor}}$, $\Delta mv_{x_{ver}}$, and $\Delta mv_{y_{ver}}$ may be determined by determining motion vectors of the pixels A, B, and C. In this way, motion vector differences of adjacent pixels in the picture block may be determined, and specifically, may be determined according to formulas (13) to (16):

$$vx_B = vx_A + w_1 \cdot \Delta mv_{x_{hor}} + h_1 \cdot \Delta mv_{x_{ver}} \quad (13)$$

$$vy_B = vy_A + w_1 \cdot \Delta mv_{y_{hor}} + h_1 \cdot \Delta mv_{y_{ver}} \quad (14)$$

$$vx_C = vx_A + w_2 \cdot \Delta mv_{x_{hor}} + h_2 \cdot \Delta mv_{x_{ver}} \quad (15)$$

$$vy_C = vy_A + w_2 \cdot \Delta mv_{y_{hor}} + h_2 \cdot \Delta mv_{y_{ver}} \quad (16)$$

or may be determined according to formulas (13) and (14) and formulas (17) and (18):

$$vx_C = vx_B + (w_2 - w_1) \cdot \Delta mv_{x_{hor}} + (h_2 + h_1) \cdot \Delta mv_{x_{ver}} \quad (17)$$

$$vy_C = vy_B + (w_2 - w_1) \cdot \Delta mv_{y_{hor}} + (h_2 + h_1) \cdot \Delta mv_{y_{ver}} \quad (18)$$

In this embodiment of the present invention, optionally, the coding device may obtain motion vectors of all control points by performing a motion estimation search; may obtain motion vectors of all control points from adjacent picture blocks; may compute motion vectors of all control points according to the affine transformation model; may obtain motion vectors of some control points by performing a motion estimation search, and obtain motion vectors of other control points from adjacent picture blocks; may obtain motion vectors of some control points by performing an affine motion estimation search, and obtain motion vectors of other control points through computation according to the affine transformation model; or may obtain motion vectors of some control points from adjacent picture blocks, and compute motion vectors of other control points according to the affine transformation model. However, the present invention is not limited thereto.

Optionally, in S1200, a third preset value may be determined as the motion vector precision of the affine picture block; or the motion vector precision of the affine picture block may be determined according to a feature of a picture block adjacent to the affine picture block, where the adjacent picture block is a picture block spatially and/or temporally adjacent to the affine picture block.

Specifically, a value of a motion vector of the affine picture block may be an integer. In this case, the motion

vector is of integer-pixel precision, that is, the pixel precision is 1. Alternatively, a value of a motion vector may not be an integer. In this case, the motion vector is of sub-pixel precision, including precision such as $\frac{1}{2}$, $\frac{1}{4}$, or $\frac{1}{8}$. FIG. 7 shows a 4x4 picture block, where X indicates a pixel in an integer-pixel position, and a captured picture has only pixels in integer-pixel positions. O indicates a pixel in a $\frac{1}{2}$ precision position, and needs to be obtained by interpolating a pixel in an integer-pixel position. Values of pixels in other precision positions need to be obtained by further interpolating pixels in integer-pixel precision positions or pixels in $\frac{1}{2}$ precision positions. If a motion vector of a current pixel is an integer, the motion vector points to a position of X in the reference picture. If the motion vector of the current pixel is of $\frac{1}{2}$ precision, the motion vector points to a position of O in the reference picture.

The motion vector precision of the affine picture block is highest precision of motion vectors of all pixels in the affine picture block. The motion vector precision of the affine picture block may be preset, for example, integer-pixel precision, or precision such as $\frac{1}{2}$, $\frac{1}{4}$, $\frac{1}{8}$, or $\frac{1}{16}$. Alternatively, the motion vector precision may be determined according to a feature of a picture block adjacent to the affine picture block. For example, if an adjacent picture is relatively smooth, it may be predicted that the current affine picture block is also relatively smooth. Therefore, higher motion vector precision such as $\frac{1}{8}$ or $\frac{1}{16}$ precision may be selected. Otherwise, lower motion vector precision such as integer-pixel precision or $\frac{1}{2}$ precision may be selected. The obtained precision is indicated by MvAc.

S1301. Determine a ratio of a product of the motion vector precision and the first horizontal distance to the first component of the motion vector difference as a length of the affine motion compensation picture subblock in a horizontal direction.

S1302. Determine a ratio of a product of the motion vector precision and the first vertical distance to the second component of the motion vector difference as a length of the affine motion compensation picture subblock in a vertical direction.

Optionally, as shown in FIG. 8, S1300 specifically includes the following steps:

Specifically, generally obtained motion vector differences Δmv_{hor} and Δmv_{ver} are relatively small, indicating that precision of a motion vector of each pixel is excessively high, for example, $\frac{1}{32}$ or $\frac{1}{64}$. Excessively high motion vector precision contributes little to compression efficiency of a video, and causes a huge amount of computation. Therefore, the affine picture block is divided into multiple affine-MC picture subblocks according to previously obtained expected motion vector precision MvAc to ensure that motion vector precision of each affine-MC picture subblock reaches MvAc.

In this embodiment of the present invention, optionally, assuming that the horizontal distance between the first control point and the second control point is w , and that the vertical distance between the third control point and the fourth control point is h , and assuming that a width of the affine-MC picture subblock is $aMcW$ and that a height of the affine-MC picture subblock is $aMcH$, $aMcW$ and $aMcH$ may be determined according to formulas (19):

$$\frac{\Delta mv_{hor}}{w} = \frac{MvAc}{aMcW} \quad \text{and} \quad \frac{\Delta mv_{ver}}{h} = \frac{MvAc}{aMcH} \quad (19)$$

This is equivalent to:

$$aMcW = \frac{MvAc}{\Delta mv_{hor}} \times w \text{ and } aMcH = \frac{MvAc}{\Delta mv_{ver}} \times h.$$

In this embodiment of the present invention, optionally, when the first control point, the second control point, the third control point, and the fourth control point are vertices of the affine picture block, the horizontal distance between the first control point and the second control point is the width W of the affine picture block, and the vertical distance between the third control point and the fourth control point is the height H of the affine picture block. In this case, the width aMcW and the height aMcH of the affine-MC picture subblock may be determined according to formulas (20):

$$\frac{\Delta mv_{hor}}{W} = \frac{MvAc}{aMcW} \text{ and } \frac{\Delta mv_{ver}}{H} = \frac{MvAc}{aMcH} \quad (20)$$

This is equivalent to:

$$aMcW = \frac{MvAc}{\Delta mv_{hor}} \times W \text{ and } aMcH = \frac{MvAc}{\Delta mv_{ver}} \times H.$$

In this embodiment of the present invention, optionally, when the first control point and the second control point are adjacent control points, and the third control point and the fourth control point are adjacent control points, the first horizontal distance between the first control point and the second control point is 1, that is, the first control point is separated from the second control point by an integer quantity of pixels; the first vertical distance between the third control point and the fourth control point is 1, that is, the third control point is separated from the fourth control point by an integer quantity of pixels. In this case, the formulas (19) may be simplified to formulas (21):

$$\Delta mv_{hor} = \frac{MvAc}{aMcW} \text{ and } \Delta mv_{ver} = \frac{MvAc}{aMcH} \quad (21)$$

This is equivalent to:

$$aMcW = \frac{MvAc}{\Delta mv_{hor}} \text{ and } aMcH = \frac{MvAc}{\Delta mv_{ver}}.$$

Therefore, in the video picture coding method according to this embodiment of the present invention, the coding device determines the size of the affine motion compensation picture subblock according to the determined motion vector difference of the affine picture block, the determined motion vector precision, and the distance between the control points, and performs coding processing on the affine picture block according to the size of the affine motion compensation picture subblock. In this way, a picture subblock of an appropriate size is selected in the coding process, so that coding complexity can be reduced and coding efficiency can be improved, while motion compensation prediction efficiency in affine transformation is maintained.

Optionally, as shown in FIG. 9, S1300 includes the following steps.

S1303. When a ratio of a product of the motion vector precision and the first horizontal distance to the first component of the motion vector difference is greater than or equal to a first preset value, determine the ratio as a length of the affine motion compensation picture subblock in a horizontal direction; or when a ratio of a product of the motion vector precision and the first horizontal distance to the first component of the motion vector difference is less than the first preset value, determine the first preset value as a length of the affine motion compensation picture subblock in a horizontal direction.

S1304. When a ratio of a product of the motion vector precision and the first vertical distance to the second component of the motion vector difference is greater than or equal to a second preset value, determine the ratio as a length of the affine motion compensation picture subblock in a vertical direction; or when a ratio of a product of the motion vector precision and the first vertical distance to the second component of the motion vector difference is less than the second preset value, determine the second preset value as a length of the affine motion compensation picture subblock in a vertical direction.

Specifically, for a hardware implementation in the coding process, a lower limit may be set for the width and the height of the affine-MC picture subblock. When the computed width or height is less than the preset lower limit, the preset lower limit is determined as the width or the height of the affine-MC picture subblock. Preferably, the lower limit may be set to 4, but may also be set to another numeric value according to an actual requirement. For example, a lower limit of the width may be set to 2, and a lower value of the height is set to 3; or a lower limit of the width is set to 1, and a lower value of the height is set to 2. This is not limited in the present invention.

Optionally, as shown in FIG. 10, S1400 includes the following steps:

S1401. Determine a motion vector of each affine motion compensation picture subblock in the affine motion compensation picture subblocks.

S1402. Determine a motion compensation prediction signal of each affine motion compensation picture subblock according to the motion vector of each affine motion compensation picture subblock.

S1403. Determine a prediction residual signal of each affine motion compensation picture subblock according to the motion compensation prediction signal of each affine motion compensation picture subblock.

S1404. Code the prediction residual signal of each affine motion compensation picture subblock.

It should be understood that, in this embodiment of the present invention, each affine-MC picture subblock may include multiple pixels, and a motion vector of a pixel needs to be selected from each affine-MC picture subblock as a motion vector of the affine-MC picture subblock.

Optionally, in S1401, a motion vector of a pixel in a central position of the affine-MC picture subblock may be selected as the motion vector of the affine-MC picture subblock; an average value of motion vectors of all pixels in the affine-MC picture subblock may be used as the motion vector of the affine-MC picture subblock; or a motion vector of a pixel in an upper left corner of the affine-MC picture subblock may be selected as the motion vector of the affine-MC picture subblock. However, the present invention is not limited thereto.

In this embodiment of the present invention, optionally, signals of boundary pixels of each affine motion compensation picture subblock are filtered, and the boundary pixels

are pixels in one or more rows at a boundary of each affine motion compensation picture subblock.

In this embodiment of the present invention, optionally, the signal of the boundary pixel includes a motion compensation prediction signal and/or a reconstructed signal, and the reconstructed signal is a sum of the motion compensation prediction signal and a reconstructed residual signal.

Specifically, as shown in FIG. 11, a thick solid line block indicates an affine picture block, a thin solid line block indicates an affine-MC picture subblock, a dashed line block indicates pixels at boundaries of adjacent affine-MC picture subblocks, and a cross indicates a pixel. A region of a dashed line block in FIG. 11 includes pixels of adjacent affine-MC picture subblocks in two rows or two columns at boundaries of the affine-MC picture subblocks, or may include one row or one column, or three rows or three columns at the boundaries of the affine-MC picture subblocks. Because motion vectors of adjacent affine-MC picture subblocks may be different, prediction signals obtained from the reference picture are not adjacent in the reference picture. This causes discontinuity of prediction signals at the boundaries of the adjacent affine-MC picture subblocks, and therefore causes discontinuity of residuals, and affects coding efficiency of the residuals. Therefore, filtering the motion compensation prediction signals at the boundaries of the affine-MC picture subblocks is considered.

A reconstructed signal is generally obtained by adding a reconstructed residual signal to a motion compensation prediction signal. Generally, lossy coding is used for the residual signal. This causes distortion between the reconstructed residual signal and an original residual signal. Distortion directions of pixels at the boundaries of adjacent affine-MC picture subblocks may be inconsistent. For example, a right pixel of a first affine-MC picture subblock becomes larger due to distortion, and a left pixel of a right adjacent affine-MC picture subblock becomes smaller due to distortion. This causes discontinuity of pixel values at boundaries of reconstructed pixels of the affine-MC picture subblocks, and impairs subjective and objective effects. Therefore, the reconstructed signals need to be filtered.

In this embodiment of the present invention, optionally, filtering may be performing by using a low-pass filter, so that pixel values in the boundary region change more smoothly. For example, filtering is performed by using a Gauss filter. However, the present invention is not limited thereto.

In this embodiment of the present invention, optionally, filtering may be performed by using an overlapped block motion compensation (Overlapped block motion compensation, "OBMC" for short) method. Motion compensation prediction is performed on a to-be-filtered pixel by using a motion vector of an affine-MC picture subblock adjacent to the to-be-filtered pixel, and weighted averaging is performed on the obtained motion compensation prediction signal and a motion compensation prediction signal obtained by using a motion vector of the to-be-filtered pixel, to obtain a final motion compensation prediction signal.

To better prove beneficial effects of this embodiment of the present invention relative to the prior art, an LDP test structure is used to test coding complexity and coding efficiency when the method in this embodiment of the present invention and the method in the prior art are used to perform coding. A result is shown in Table 1.

TABLE 1

| Class | Sequence | The method in the present invention relative to the method in the prior art |
|-------|--------------|---|
| 5 | LDP | |
| | Tractor | -0.2% |
| | BlueSky | 0.0% |
| | SpinCalendar | 0.0% |
| | Jets | -0.5% |
| 10 | Enct | 86% |
| | Dect | 78% |

As can be seen from Table 1, using the video picture coding method in this embodiment of the present invention can improve coding efficiency and reduce a coding time.

Therefore, in the video picture coding method according to this embodiment of the present invention, the coding device determines the size of the affine motion compensation picture subblock according to the determined motion vector difference of the affine picture block, the determined motion vector precision, and the distance between the control points, and performs coding processing on the affine picture block according to the size of the affine motion compensation picture subblock. In this way, a picture subblock of an appropriate size is selected in the coding process, so that coding complexity can be reduced, and coding efficiency can be improved.

The video picture coding method according to this embodiment of the present invention is hereinbefore described in detail with reference to FIG. 1 to FIG. 1i. A video picture decoding method according to an embodiment of the present invention is hereinafter described in detail with reference to FIG. 12 to FIG. 18. It should be noted that, related operations of a decoder are essentially consistent with those of an encoder. To avoid repetition, details are not described again herein.

FIG. 12 shows a schematic flowchart of a video picture decoding method according to an embodiment of the present invention. The method shown in FIG. 12 may be performed by a decoding device, for example, a decoder. Specifically, as shown in FIG. 12, the method 2000 includes the following steps.

S2100. Determine a motion vector difference of an affine picture block.

S2200. Determine motion vector precision of the affine picture block.

S2300. Determine a size of an affine motion compensation picture subblock in the affine picture block according to the motion vector difference, the motion vector precision, and a distance between control points in the affine picture block, where the control points are pixels used to determine the motion vector difference.

S2400. Perform decoding processing on the affine picture block according to the size of the affine motion compensation picture subblock.

Specifically, the decoding device determines the motion vector difference of the affine picture block according to the determined control points, determines the motion vector precision of the affine picture block, determines the size of the affine motion compensation picture subblock in the affine picture block according to the determined motion vector difference, the determined motion vector precision, and the distance between the control points, and performs decoding processing on the affine picture block according to the determined size.

Therefore, in the video picture decoding method according to this embodiment of the present invention, the decoding device determines the size of the affine motion compen-

sation picture subblock according to the determined motion vector difference of the affine picture block, the determined motion vector precision, and the distance between the control points, and performs decoding processing on the affine picture block according to the determined size. In this way, a picture subblock of an appropriate size is selected in a decoding process, so that decoding complexity can be reduced, and decoding efficiency can be improved.

Preferably, as shown in FIG. 13, S2100 includes the following steps:

S2101. Determine a first component of the motion vector difference according to a difference between motion vectors of a first control point and a second control point that are located on a same horizontal line.

S2102. Determine a second component of the motion vector difference according to a difference between motion vectors of a third control point and a fourth control point that are located on a same vertical line.

A first horizontal distance exists between the first control point and the second control point, and a first vertical distance exists between the third control point and the fourth control point.

It should be understood that, in this embodiment of the present invention, the first component of the motion vector difference is a horizontal component of the motion vector difference, and the second component of the motion vector difference is a vertical component of the motion vector difference.

Optionally, as shown in FIG. 14, S2101 specifically includes the following steps:

S2103. Determine a first horizontal component difference and a first vertical component difference between the motion vectors of the first control point and the second control point.

S2104. Determine a larger one of the first horizontal component difference and the first vertical component difference as the first component of the motion vector difference.

Correspondingly, as shown in FIG. 15, S2102 specifically includes the following steps:

S2105. Determine a second horizontal component difference and a second vertical component difference between the motion vectors of the third control point and the fourth control point.

S2106. Determine a larger one of the second horizontal component difference and the second vertical component difference as the second component of the motion vector difference.

In this embodiment of the present invention, optionally, an affine transformation parameter of a pixel in the affine picture block may be determined, and pixels in the affine picture block have the same affine transformation parameter.

Correspondingly, S2103 is specifically: determining the first horizontal component difference and the first vertical component difference according to the affine transformation parameter and the first horizontal distance.

S2105 is specifically: determining the second horizontal component difference and the second vertical component difference according to the affine transformation parameter and the first vertical distance.

In this embodiment of the present invention, optionally, a motion vector of the first control point, a motion vector of the second control point, a motion vector of the third control point, and a motion vector of the fourth control point may be determined.

Correspondingly, S2103 is specifically: determining a difference between a horizontal component of the motion vector of the first control point and a horizontal component

of the motion vector of the second control point as the first horizontal component difference; and determining a difference between a vertical component of the motion vector of the first control point and a vertical component of the motion vector of the second control point as the first vertical component difference.

S2105 is specifically: determining a difference between a horizontal component of the motion vector of the third control point and a horizontal component of the motion vector of the fourth control point as the second horizontal component difference; and determining a difference between a vertical component of the motion vector of the third control point and a vertical component of the motion vector of the fourth control point as the second vertical component difference.

In this embodiment of the present invention, optionally, the first control point and the second control point are two adjacent pixels, and the third control point and the fourth control point are two adjacent pixels.

S2103 and S2105 are specifically: determining a motion vector of a first pixel, a motion vector of a second pixel, and a motion vector of a third pixel, where the first pixel, the second pixel, and the third pixel are non-overlapping pixels; determining a second horizontal distance and a second vertical distance between the first pixel and the second pixel; determining a third horizontal distance and a third vertical distance between the first pixel and the third pixel; and determining the first horizontal component difference, the first vertical component difference, the second horizontal component difference, and the second vertical component difference according to the motion vector of the first pixel, the motion vector of the second pixel, the motion vector of the third pixel, the second horizontal distance, the second vertical distance, the third horizontal distance, and the third vertical distance.

In this embodiment of the present invention, optionally, the decoding device may obtain motion vectors of all control points by parsing a bit stream; may obtain motion vectors of all control points from adjacent picture blocks; may compute motion vectors of all control points according to an affine transformation model; may obtain motion vectors of some control points by parsing a bit stream, and obtain motion vectors of other control points from adjacent picture blocks; may obtain motion vectors of some control points by parsing a bit stream, and obtain motion vectors of other control points through computation according to an affine transformation model; or may obtain motion vectors of some control points from adjacent picture blocks, and compute motion vectors of other control points according to an affine transformation model. However, the present invention is not limited thereto.

Optionally, in S2200, a third preset value may be determined as the motion vector precision of the affine picture block; or the motion vector precision of the affine picture block is determined according to a feature of a picture block adjacent to the affine picture block, where the adjacent picture block is a picture block spatially and/or temporally adjacent to the affine picture block.

S2301. Determine a ratio of a product of the motion vector precision and the first horizontal distance to the first component of the motion vector difference as a length of the affine motion compensation picture subblock in a horizontal direction.

Optionally, as shown in FIG. 16, S2300 specifically includes the following steps:

S2302. Determine a ratio of a product of the motion vector precision and the first vertical distance to the second

component of the motion vector difference as a length of the affine motion compensation picture subblock in a vertical direction.

Optionally, as shown in FIG. 17, S2300 includes the following steps:

S2303. When a ratio of a product of the motion vector precision and the first horizontal distance to the first component of the motion vector difference is greater than or equal to a first preset value, determine the ratio as a length of the affine motion compensation picture subblock in a horizontal direction; or when a ratio of a product of the motion vector precision and the first horizontal distance to the horizontal component of the motion vector difference is less than the first preset value, determine the first preset value as a length of the affine motion compensation picture subblock in a horizontal direction.

S2304. When a ratio of a product of the motion vector precision and the first vertical distance to the vertical component of the motion vector difference is greater than or equal to a second preset value, determine the ratio as a length of the affine motion compensation picture subblock in a vertical direction; or when a ratio of a product of the motion vector precision and the first vertical distance to the vertical component of the motion vector difference is less than the second preset value, determine the second preset value as a length of the affine motion compensation picture subblock in a vertical direction.

Optionally, as shown in FIG. 18, S2400 includes the following steps:

S2401. Determine a motion vector of each affine motion compensation picture subblock in the affine motion compensation picture subblocks.

S2402. Determine a motion compensation prediction signal of each affine motion compensation picture subblock according to the motion vector of each affine motion compensation picture subblock.

S2403. Determine a prediction residual signal of each affine motion compensation picture subblock according to the motion compensation prediction signal of each affine motion compensation picture subblock.

S2404. Decode the prediction residual signal of each affine motion compensation picture subblock.

In this embodiment of the present invention, optionally, signals of boundary pixels of each affine motion compensation picture subblock are filtered, and the boundary pixels are pixels in one or more rows at a boundary of each affine motion compensation picture subblock.

In this embodiment of the present invention, optionally, the signal of the boundary pixel includes a motion compensation prediction signal and/or a reconstructed signal, and the reconstructed signal is a sum of the motion compensation prediction signal and a reconstructed residual signal. Therefore, in the video picture decoding method according to this embodiment of the present invention, the decoding device determines the size of the affine motion compensation picture subblock according to the determined motion vector difference of the affine picture block, the motion vector precision, and the distance between the control points, and performs decoding processing on the affine picture block according to the determined size. In this way, a picture subblock of an appropriate size is selected in the decoding process, so that decoding complexity can be reduced, and decoding efficiency can be improved.

Optionally, the decoding method in the present invention may also be: parsing a bit stream to obtain a motion vector difference of an affine picture block and motion vector precision of the affine picture block, where pixels in the

affine picture block have a same affine transformation parameter; determining a size of an affine motion compensation picture subblock in the affine picture block according to the motion vector difference, the motion vector precision, and a distance between control points in the affine picture block, where the control points are pixels used to determine the motion vector difference; and performing decoding processing on the affine picture block according to the size of the affine motion compensation picture subblock.

Alternatively, the decoding method may be: parsing a bit stream to obtain affine picture block information; determining a size of an affine motion compensation picture subblock in the affine picture block according to the affine picture block information; and performing decoding processing on the affine picture block according to the size of the affine motion compensation picture subblock.

In such a manner, the decoder may directly use a parameter sent by an encoder to the decoder to determine the size of the affine motion compensation picture subblock without re-computation, and further reduce computational complexity.

The following describes in detail a coding device according to an embodiment of the present invention with reference to FIG. 19 and FIG. 20. As shown in FIG. 19, the coding device 10 includes: a first determining module 11, configured to determine a motion vector difference of an affine picture block; a second determining module 12, configured to determine motion vector precision of the affine picture block; a third determining module 13, configured to determine a size of an affine motion compensation picture subblock in the affine picture block according to the motion vector difference determined by the first determining module 11, the motion vector precision determined by the second determining module 12, and a distance between control points in the affine picture block, where the control points are pixels used to determine the motion vector difference; and a coding module 14, configured to perform coding processing on the affine picture block according to the size of the affine motion compensation picture subblock that is determined by the third determining module 13.

Specifically, the coding device determines the motion vector difference of the affine picture block according to the determined control points, determines the motion vector precision of the affine picture block, determines the size of the affine motion compensation picture subblock in the affine picture block according to the determined motion vector difference, the determined motion vector precision, and the distance between the control points, and performs coding processing on the affine picture block according to the determined size.

Therefore, the coding device according to this embodiment of the present invention determines the size of the affine motion compensation picture subblock according to the determined motion vector difference of the affine picture block, the determined motion vector precision, and the distance between the control points, and performs coding processing on the affine picture block according to the size of the affine motion compensation picture subblock. In this way, a picture subblock of an appropriate size is selected in a coding process, so that coding complexity can be reduced, and coding efficiency can be improved.

In this embodiment of the present invention, optionally, the first determining module 11 is specifically configured to: determine a first component of the motion vector difference according to a difference between motion vectors of a first control point and a second control point that are located on a same horizontal line; and determine a second component

of the motion vector difference according to a difference between motion vectors of a third control point and a fourth control point that are located on a same vertical line; where a first horizontal distance exists between the first control point and the second control point, and a first vertical distance exists between the third control point and the fourth control point.

In this embodiment of the present invention, optionally, the first determining module **11** is specifically configured to: determine a first horizontal component difference and a first vertical component difference between the motion vectors of the first control point and the second control point; determine a larger one of the first horizontal component difference and the first vertical component difference as the first component of the motion vector difference; determine a second horizontal component difference and a second vertical component difference between the motion vectors of the third control point and the fourth control point; and determine a larger one of the second horizontal component difference and the second vertical component difference as the second component of the motion vector difference.

In this embodiment of the present invention, optionally, the first determining module **11** is specifically configured to: determine an affine transformation parameter of a pixel in the affine picture block, where pixels in the affine picture block have the same affine transformation parameter; determine the first horizontal component difference and the first vertical component difference according to the affine transformation parameter and the first horizontal distance; and determine the second horizontal component difference and the second vertical component difference according to the affine transformation parameter and the first vertical distance.

In this embodiment of the present invention, optionally, the first determining module **11** is specifically configured to: determine a motion vector of the first control point, a motion vector of the second control point, a motion vector of the third control point, and a motion vector of the fourth control point; determine a difference between a horizontal component of the motion vector of the first control point and a horizontal component of the motion vector of the second control point as the first horizontal component difference; determine a difference between a vertical component of the motion vector of the first control point and a vertical component of the motion vector of the second control point as the first vertical component difference; determine a difference between a horizontal component of the motion vector of the third control point and a horizontal component of the motion vector of the fourth control point as the second horizontal component difference; and determine a difference between a vertical component of the motion vector of the third control point and a vertical component of the motion vector of the fourth control point as the second vertical component difference.

In this embodiment of the present invention, optionally, the first control point and the second control point are two adjacent pixels, and the third control point and the fourth control point are two adjacent pixels.

The first determining module **11** is specifically configured to: determine a motion vector of a first pixel, a motion vector of a second pixel, and a motion vector of a third pixel, where the first pixel, the second pixel, and the third pixel are non-overlapping pixels; determine a second horizontal distance and a second vertical distance between the first pixel and the second pixel; determine a third horizontal distance and a third vertical distance between the first pixel and the third pixel; and determine the first horizontal component

difference, the first vertical component difference, the second horizontal component difference, and the second vertical component difference according to the motion vector of the first pixel, the motion vector of the second pixel, the motion vector of the third pixel, the second horizontal distance, the second vertical distance, the third horizontal distance, and the third vertical distance.

In this embodiment of the present invention, optionally, the third determining module **13** is specifically configured to: determine a ratio of a product of the motion vector precision and the first horizontal distance to the first component of the motion vector difference as a length of the affine motion compensation picture subblock in a horizontal direction; and determine a ratio of a product of the motion vector precision and the first vertical distance to the second component of the motion vector difference as a length of the affine motion compensation picture subblock in a vertical direction.

In this embodiment of the present invention, optionally, the third determining module **13** is specifically configured to: when a ratio of a product of the motion vector precision and the first horizontal distance to the first component of the motion vector difference is greater than or equal to a first preset value, determine the ratio as a length of the affine motion compensation picture subblock in a horizontal direction; or when a ratio of a product of the motion vector precision and the first horizontal distance to the first component of the motion vector difference is less than the first preset value, determine the first preset value as a length of the affine motion compensation picture subblock in a horizontal direction; and when a ratio of a product of the motion vector precision and the first vertical distance to the second component of the motion vector difference is greater than or equal to a second preset value, determine the ratio as a length of the affine motion compensation picture subblock in a vertical direction; or when a ratio of a product of the motion vector precision and the first vertical distance to the second component of the motion vector difference is less than the second preset value, determine the second preset value as a length of the affine motion compensation picture subblock in a vertical direction.

In this embodiment of the present invention, optionally, the first control point and the third control point are the same pixel.

In this embodiment of the present invention, optionally, the first control point, the second control point, the third control point, and the fourth control point are vertices of the affine picture block.

In this embodiment of the present invention, optionally, the first preset value is 4, and/or the second preset value is 4.

In this embodiment of the present invention, optionally, the second determining module **12** is specifically configured to: determine a third preset value as the motion vector precision of the affine picture block; or determine the motion vector precision of the affine picture block according to a feature of a picture block adjacent to the affine picture block, where the adjacent picture block is a picture block spatially and/or temporally adjacent to the affine picture block.

In this embodiment of the present invention, optionally, the coding module **14** is specifically configured to: determine a motion vector of each affine motion compensation picture subblock in the affine motion compensation picture subblocks; determine a motion compensation prediction signal of each affine motion compensation picture subblock according to the motion vector of each affine motion compensation picture subblock; determine a prediction residual

signal of each affine motion compensation picture subblock according to the motion compensation prediction signal of each affine motion compensation picture subblock; and code the prediction residual signal of each affine motion compensation picture subblock.

In this embodiment of the present invention, optionally, as shown in FIG. 20, the coding device 10 further includes: a filtering module 15, configured to filter signals of boundary pixels of each affine motion compensation picture subblock, where the boundary pixels are pixels in one or more rows at a boundary of each affine motion compensation picture subblock.

In this embodiment of the present invention, optionally, the signal of the boundary pixel includes a motion compensation prediction signal and/or a reconstructed signal, and the reconstructed signal is a sum of the motion compensation prediction signal and a reconstructed residual signal.

It should be understood that, the coding device 10 according to this embodiment of the present invention may correspondingly perform the video picture coding method 1000 in the embodiments of the present invention, and the foregoing and other operations and/or functions of the modules in the coding device 10 are separately intended to implement the corresponding procedures of the method in FIG. 1 to FIG. 11. For brevity, details are not described again herein.

Therefore, the coding device according to this embodiment of the present invention determines the size of the affine motion compensation picture subblock according to the determined motion vector difference of the affine picture block, the determined motion vector precision, and the distance between the control points, and performs coding processing on the affine picture block according to the size. In this way, a picture subblock of an appropriate size is selected in the coding process, so that coding complexity can be reduced, and coding efficiency can be improved.

The following describes in detail a decoding device according to an embodiment of the present invention with reference to FIG. 21 and FIG. 22. As shown in FIG. 21, the decoding device 20 includes: a first determining module 21, configured to determine a motion vector difference of an affine picture block; a second determining module 22, configured to determine motion vector precision of the affine picture block; a third determining module 23, configured to determine a size of an affine motion compensation picture subblock in the affine picture block according to the motion vector difference determined by the first determining module 21, the motion vector precision determined by the second determining module 22, and a distance between control points in the affine picture block, where the control points are pixels used to determine the motion vector difference; and a decoding module 24, configured to perform decoding processing on the affine picture block according to the size of the affine motion compensation picture subblock that is determined by the third determining module 23.

Specifically, the decoding device determines the motion vector difference of the affine picture block according to the determined control points, determines the motion vector precision of the affine picture block, determines the size of the affine motion compensation picture subblock in the affine picture block according to the determined motion vector difference, the determined motion vector precision, and the distance between the control points, and performs decoding processing on the affine picture block according to the determined size.

Therefore, the decoding device according to this embodiment of the present invention determines the size of the affine motion compensation picture subblock according to

the determined motion vector difference of the affine picture block, the determined motion vector precision, and the distance between the control points, and performs decoding processing on the affine picture block according to the size of the affine motion compensation picture subblock. In this way, a picture subblock of an appropriate size is selected in a decoding process, so that decoding complexity can be reduced, and decoding efficiency can be improved.

In this embodiment of the present invention, optionally, the first determining module 21 is specifically configured to: determine a first component of the motion vector difference according to a difference between motion vectors of a first control point and a second control point that are located on a same horizontal line; and determine a second component of the motion vector difference according to a difference between motion vectors of a third control point and a fourth control point that are located on a same vertical line; where a first horizontal distance exists between the first control point and the second control point, and a first vertical distance exists between the third control point and the fourth control point.

In this embodiment of the present invention, optionally, the first determining module 21 is specifically configured to: determine a first horizontal component difference and a first vertical component difference between the motion vectors of the first control point and the second control point; determine a larger one of the first horizontal component difference and the first vertical component difference as the first component of the motion vector difference; determine a second horizontal component difference and a second vertical component difference between the motion vectors of the third control point and the fourth control point; and determine a larger one of the second horizontal component difference and the second vertical component difference as the second component of the motion vector difference.

In this embodiment of the present invention, optionally, the first determining module 21 is specifically configured to: determine an affine transformation parameter of a pixel in the affine picture block, where pixels in the affine picture block have the same affine transformation parameter; determine the first horizontal component difference and the first vertical component difference according to the affine transformation parameter and the first horizontal distance; and determine the second horizontal component difference and the second vertical component difference according to the affine transformation parameter and the first vertical distance.

In this embodiment of the present invention, optionally, the first determining module 21 is specifically configured to: determine a motion vector of the first control point, a motion vector of the second control point, a motion vector of the third control point, and a motion vector of the fourth control point; determine a difference between a horizontal component of the motion vector of the first control point and a horizontal component of the motion vector of the second control point as the first horizontal component difference; determine a difference between a vertical component of the motion vector of the first control point and a vertical component of the motion vector of the second control point as the first vertical component difference; determine a difference between a horizontal component of the motion vector of the third control point and a horizontal component of the motion vector of the fourth control point as the second horizontal component difference; and determine a difference between a vertical component of the motion vector of the

third control point and a vertical component of the motion vector of the fourth control point as the second vertical component difference.

In this embodiment of the present invention, optionally, the first control point and the second control point are two adjacent pixels, and the third control point and the fourth control point are two adjacent pixels.

The first determining module **21** is specifically configured to: determine a motion vector of a first pixel, a motion vector of a second pixel, and a motion vector of a third pixel, where the first pixel, the second pixel, and the third pixel are non-overlapping pixels; determine a second horizontal distance and a second vertical distance between the first pixel and the second pixel; determine a third horizontal distance and a third vertical distance between the first pixel and the third pixel; and determine the first horizontal component difference, the first vertical component difference, the second horizontal component difference, and the second vertical component difference according to the motion vector of the first pixel, the motion vector of the second pixel, the motion vector of the third pixel, the second horizontal distance, the second vertical distance, the third horizontal distance, and the third vertical distance.

In this embodiment of the present invention, optionally, the third determining module **23** is specifically configured to: determine a ratio of a product of the motion vector precision and the first horizontal distance to the first component of the motion vector difference as a length of the affine motion compensation picture subblock in a horizontal direction; and determine a ratio of a product of the motion vector precision and the first vertical distance to the second component of the motion vector difference as a length of the affine motion compensation picture subblock in a vertical direction.

In this embodiment of the present invention, optionally, the third determining module **23** is specifically configured to: when a ratio of a product of the motion vector precision and the first horizontal distance to the first component of the motion vector difference is greater than or equal to a first preset value, determine the ratio as a length of the affine motion compensation picture subblock in a horizontal direction; or when a ratio of a product of the motion vector precision and the first horizontal distance to the first component of the motion vector difference is less than the first preset value, determine the first preset value as a length of the affine motion compensation picture subblock in a horizontal direction; and when a ratio of a product of the motion vector precision and the first vertical distance to the second component of the motion vector difference is greater than or equal to a second preset value, determine the ratio as a length of the affine motion compensation picture subblock in a vertical direction; or when a ratio of a product of the motion vector precision and the first vertical distance to the second component of the motion vector difference is less than the second preset value, determine the second preset value as a length of the affine motion compensation picture subblock in a vertical direction.

In this embodiment of the present invention, optionally, the first control point and the third control point are the same pixel.

In this embodiment of the present invention, optionally, the first control point, the second control point, the third control point, and the fourth control point are vertices of the affine picture block.

In this embodiment of the present invention, optionally, the first preset value is 4, and/or the second preset value is 4.

In this embodiment of the present invention, optionally, the second determining module **22** is specifically configured to: determine a third preset value as the motion vector precision of the affine picture block; or determine the motion vector precision of the affine picture block according to a feature of a picture block adjacent to the affine picture block, where the adjacent picture block is a picture block spatially and/or temporally adjacent to the affine picture block.

In this embodiment of the present invention, optionally, the decoding module **24** is specifically configured to: determine a motion vector of each affine motion compensation picture subblock in the affine motion compensation picture subblocks; determine a motion compensation prediction signal of each affine motion compensation picture subblock according to the motion vector of each affine motion compensation picture subblock; determine a prediction residual signal of each affine motion compensation picture subblock according to the motion compensation prediction signal of each affine motion compensation picture subblock; and decode the prediction residual signal of each affine motion compensation picture subblock.

In this embodiment of the present invention, optionally, as shown in FIG. **22**, the decoding device **20** further includes: a filtering module **25**, configured to filter signals of boundary pixels of each affine motion compensation picture subblock, where the boundary pixels are pixels in one or more rows at a boundary of each affine motion compensation picture subblock.

In this embodiment of the present invention, optionally, the signal of the boundary pixel includes a motion compensation prediction signal and/or a reconstructed signal, and the reconstructed signal is a sum of the motion compensation prediction signal and a reconstructed residual signal.

It should be understood that, the decoding device **20** according to this embodiment of the present invention may correspondingly perform the video picture decoding method **2000** in the embodiments of the present invention, and the foregoing and other operations and/or functions of the modules in the decoding device **20** are separately intended to implement the corresponding procedures of the method in FIG. **12** to FIG. **18**. For brevity, details are not described again herein.

Therefore, the decoding device according to this embodiment of the present invention determines the size of the affine motion compensation picture subblock according to the determined motion vector difference of the affine picture block, the determined motion vector precision, and the distance between the control points, and performs decoding processing on the affine picture block according to the size. In this way, a picture subblock of an appropriate size is selected in the decoding process, so that decoding complexity can be reduced, and decoding efficiency can be improved.

As shown in FIG. **23**, an embodiment of the present invention further provides a coding device **30**, including a processor **31**, a memory **32**, and a bus system **33**. The processor **31** and the memory **32** are connected by the bus system **33**. The memory **32** is configured to store an instruction. The processor **31** is configured to execute the instruction stored in the memory **32**. The memory **32** of the coding device **30** stores program code, and the processor **31** may invoke the program code stored in the memory **32** to perform the following operations: determining a motion vector difference of an affine picture block; determining motion vector precision of the affine picture block; determining a size of an affine motion compensation picture subblock in the affine picture block according to the motion vector difference, the motion vector precision, and a distance between control

points in the affine picture block, where the control points are pixels used to determine the motion vector difference; and performing coding processing on the affine picture block according to the size of the affine motion compensation picture subblock.

Therefore, the coding device according to this embodiment of the present invention determines the size of the affine motion compensation picture subblock according to the determined motion vector difference of the affine picture block, the determined motion vector precision, and the distance between the control points, and performs coding processing on the affine picture block according to the size of the affine motion compensation picture subblock. In this way, a picture subblock of an appropriate size is selected in a coding process, so that coding complexity can be reduced, and coding efficiency can be improved.

It should be understood that, in this embodiment of the present invention, the processor **31** may be a central processing unit (Central Processing Unit, "CPU" for short), or the processor **31** may be another general purpose processor, a digital signal processor (DSP), an application-specific integrated circuit (ASIC), a field programmable gate array (FPGA), or another programmable logic device, discrete gate or transistor logic device, discrete hardware component, or the like. The general purpose processor may be a micro-processor, or the processor may be any conventional processor, or the like.

The memory **32** may include a read-only memory and a random access memory, and provide an instruction and data to the processor **31**. A part of the memory **32** may further include a non-volatile random access memory. For example, the memory **32** may further store information about a device type.

The bus system **33** may further include a power bus, a control bus, a status signal bus, and the like, in addition to a data bus. However, for clear description, various buses in the figure are marked as the bus system **33**.

In an implementation process, each step of the foregoing method may be completed by using an integrated logic circuit of hardware in the processor **31** or an instruction in a form of software. The steps of the method disclosed with reference to the embodiments of the present invention may be directly performed by a hardware processor, or may be performed by using a combination of hardware in the processor and a software module. The software module may be located in a mature storage medium in the art, such as a random access memory, a flash memory, a read-only memory, a programmable read-only memory, an electrically erasable programmable memory, or a register. The storage medium is located in the memory **32**. The processor **31** reads information in the memory **32** and completes the steps in the foregoing method in combination with the hardware of the processor **31**. To avoid repetition, details are not described again herein.

Optionally, in an embodiment, the processor **31** is specifically configured to: determine a first component of the motion vector difference according to a difference between motion vectors of a first control point and a second control point that are located on a same horizontal line; and determine a second component of the motion vector difference according to a difference between motion vectors of a third control point and a fourth control point that are located on a same vertical line; where a first horizontal distance exists between the first control point and the second control point, and a first vertical distance exists between the third control point and the fourth control point.

Optionally, in an embodiment, the processor **31** is specifically configured to: determine a first horizontal component difference and a first vertical component difference between the motion vectors of the first control point and the second control point; determine a larger one of the first horizontal component difference and the first vertical component difference as the first component of the motion vector difference; determine a second horizontal component difference and a second vertical component difference between the motion vectors of the third control point and the fourth control point; and determine a larger one of the second horizontal component difference and the second vertical component difference as the second component of the motion vector difference.

Optionally, in an embodiment, the processor **31** is specifically configured to: determine an affine transformation parameter of a pixel in the affine picture block, where pixels in the affine picture block have the same affine transformation parameter; determine the first horizontal component difference and the first vertical component difference according to the affine transformation parameter and the first horizontal distance; and determine the second horizontal component difference and the second vertical component difference according to the affine transformation parameter and the first vertical distance.

Optionally, in an embodiment, the processor **31** is specifically configured to: determine a motion vector of the first control point, a motion vector of the second control point, a motion vector of the third control point, and a motion vector of the fourth control point; determine a difference between a horizontal component of the motion vector of the first control point and a horizontal component of the motion vector of the second control point as the first horizontal component difference; determine a difference between a vertical component of the motion vector of the first control point and a vertical component of the motion vector of the second control point as the first vertical component difference; determine a difference between a horizontal component of the motion vector of the third control point and a horizontal component of the motion vector of the fourth control point as the second horizontal component difference; and determine a difference between a vertical component of the motion vector of the third control point and a vertical component of the motion vector of the fourth control point as the second vertical component difference.

Optionally, in an embodiment, the first control point and the second control point are two adjacent pixels, and the third control point and the fourth control point are two adjacent pixels.

The processor **31** is specifically configured to: determine a motion vector of a first pixel, a motion vector of a second pixel, and a motion vector of a third pixel, where the first pixel, the second pixel, and the third pixel are non-overlapping pixels; determine a second horizontal distance and a second vertical distance between the first pixel and the second pixel; determine a third horizontal distance and a third vertical distance between the first pixel and the third pixel; and determine the first horizontal component difference, the first vertical component difference, the second horizontal component difference, and the second vertical component difference according to the motion vector of the first pixel, the motion vector of the second pixel, the motion vector of the third pixel, the second horizontal distance, the second vertical distance, the third horizontal distance, and the third vertical distance.

Optionally, in an embodiment, the processor **31** is specifically configured to: determine a ratio of a product of the

39

motion vector precision and the first horizontal distance to the first component of the motion vector difference as a length of the affine motion compensation picture subblock in a horizontal direction; and determine a ratio of a product of the motion vector precision and the first vertical distance to the second component of the motion vector difference as a length of the affine motion compensation picture subblock in a vertical direction.

Optionally, in an embodiment, the processor **31** is specifically configured to: when a ratio of a product of the motion vector precision and the first horizontal distance to the first component of the motion vector difference is greater than or equal to a first preset value, determine the ratio as a length of the affine motion compensation picture subblock in a horizontal direction; or when a ratio of a product of the motion vector precision and the first horizontal distance to the first component of the motion vector difference is less than the first preset value, determine the first preset value as a length of the affine motion compensation picture subblock in a horizontal direction; and when a ratio of a product of the motion vector precision and the first vertical distance to the second component of the motion vector difference is greater than or equal to a second preset value, determine the ratio as a length of the affine motion compensation picture subblock in a vertical direction; or when a ratio of a product of the motion vector precision and the first vertical distance to the second component of the motion vector difference is less than the second preset value, determine the second preset value as a length of the affine motion compensation picture subblock in a vertical direction.

Optionally, in an embodiment, the first control point and the third control point are the same pixel.

Optionally, in an embodiment, the first control point, the second control point, the third control point, and the fourth control point are vertices of the affine picture block.

Optionally, in an embodiment, the first preset value is 4, and/or the second preset value is 4.

Optionally, in an embodiment, the processor **31** is specifically configured to: determine a third preset value as the motion vector precision of the affine picture block; or determine the motion vector precision of the affine picture block according to a feature of a picture block adjacent to the affine picture block, where the adjacent picture block is a picture block spatially and/or temporally adjacent to the affine picture block.

Optionally, in an embodiment, the processor **31** is specifically configured to: determine a motion vector of each affine motion compensation picture subblock in the affine motion compensation picture subblocks; determine a motion compensation prediction signal of each affine motion compensation picture subblock according to the motion vector of each affine motion compensation picture subblock; determine a prediction residual signal of each affine motion compensation picture subblock according to the motion compensation prediction signal of each affine motion compensation picture subblock; and code the prediction residual signal of each affine motion compensation picture subblock.

Optionally, in an embodiment, the processor **31** is further configured to filter signals of boundary pixels of each affine motion compensation picture subblock, where the boundary pixels are pixels in one or more rows at a boundary of each affine motion compensation picture subblock.

Optionally, in an embodiment, the signal of the boundary pixel includes a motion compensation prediction signal and/or a reconstructed signal, and the reconstructed signal is a sum of the motion compensation prediction signal and a reconstructed residual signal.

40

It should be understood that, the coding device **30** according to this embodiment of the present invention may correspond to the coding device **10** in the embodiments of the present invention, and may correspond to a corresponding entity that performs the method according to the embodiments of the present invention, and the foregoing and other operations and/or functions of the modules in the coding device **30** are separately intended to implement the corresponding procedures of the method in FIG. **1** to FIG. **11**. For brevity, details are not described again herein.

Therefore, the coding device according to this embodiment of the present invention determines the size of the affine motion compensation picture subblock according to the determined motion vector difference of the affine picture block, the determined motion vector precision, and the distance between the control points, and performs coding processing on the affine picture block according to the size of the affine motion compensation picture subblock. In this way, a picture subblock of an appropriate size is selected in the coding process, so that coding complexity can be reduced, and coding efficiency can be improved.

As shown in FIG. **24**, an embodiment of the present invention further provides a decoding device **40**, including a processor **41**, a memory **42**, and a bus system **43**. The processor **41** and the memory **42** are connected by the bus system **43**. The memory **42** is configured to store an instruction. The processor **41** is configured to execute the instruction stored in the memory **42**. The memory **42** of the decoding device **40** stores program code, and the processor **41** may invoke the program code stored in the memory **42** to perform the following operations: determining a motion vector difference of an affine picture block; determining motion vector precision of the affine picture block; determining a size of an affine motion compensation picture subblock in the affine picture block according to the motion vector difference, the motion vector precision, and a distance between control points in the affine picture block, where the control points are pixels used to determine the motion vector difference; and performing decoding processing on the affine picture block according to the size of the affine motion compensation picture subblock.

Therefore, the decoding device according to this embodiment of the present invention determines the size of the affine motion compensation picture subblock according to the determined motion vector difference of the affine picture block, the determined motion vector precision, and the distance between the control points, and performs decoding processing on the affine picture block according to the size. In this way, a picture subblock of an appropriate size is selected in a decoding process, so that decoding complexity can be reduced, and decoding efficiency can be improved.

It should be understood that, in this embodiment of the present invention, the processor **41** may be a central processing unit (Central Processing Unit, "CPU" for short), or the processor **41** may be another general purpose processor, a digital signal processor (DSP), an application-specific integrated circuit (ASIC), a field programmable gate array (FPGA), or another programmable logic device, discrete gate or transistor logic device, discrete hardware component, or the like. The general purpose processor may be a microprocessor, or the processor may be any conventional processor, or the like.

The memory **42** may include a read-only memory and a random access memory, and provide an instruction and data to the processor **41**. A part of the memory **42** may further

41

include a non-volatile random access memory. For example, the memory 42 may further store information about a device type.

The bus system 43 may further include a power bus, a control bus, a status signal bus, and the like, in addition to a data bus. However, for clear description, various buses in the figure are marked as the bus system 43.

In an implementation process, each step of the foregoing method may be completed by using an integrated logic circuit of hardware in the processor 41 or an instruction in a form of software. The steps of the method disclosed with reference to the embodiments of the present invention may be directly performed by a hardware processor, or may be performed by using a combination of hardware in the processor and a software module. The software module may be located in a mature storage medium in the art, such as a random access memory, a flash memory, a read-only memory, a programmable read-only memory, an electrically erasable programmable memory, or a register. The storage medium is located in the memory 42. The processor 41 reads information in the memory 42 and completes the steps in the foregoing method in combination with the hardware of the processor 41. To avoid repetition, details are not described again herein.

Optionally, in an embodiment, the processor 41 is specifically configured to: determine a first component of the motion vector difference according to a difference between motion vectors of a first control point and a second control point that are located on a same horizontal line; and determine a second component of the motion vector difference according to a difference between motion vectors of a third control point and a fourth control point that are located on a same vertical line; where a first horizontal distance exists between the first control point and the second control point, and a first vertical distance exists between the third control point and the fourth control point.

Optionally, in an embodiment, the processor 41 is specifically configured to: determine a first horizontal component difference and a first vertical component difference between the motion vectors of the first control point and the second control point; determine a larger one of the first horizontal component difference and the first vertical component difference as the first component of the motion vector difference; determine a second horizontal component difference and a second vertical component difference between the motion vectors of the third control point and the fourth control point; and determine a larger one of the second horizontal component difference and the second vertical component difference as the second component of the motion vector difference.

Optionally, in an embodiment, the processor 41 is specifically configured to: determine an affine transformation parameter of a pixel in the affine picture block, where pixels in the affine picture block have the same affine transformation parameter; determine the first horizontal component difference and the first vertical component difference according to the affine transformation parameter and the first horizontal distance; and determine the second horizontal component difference and the second vertical component difference according to the affine transformation parameter and the first vertical distance.

Optionally, in an embodiment, the processor 41 is specifically configured to: determine a motion vector of the first control point, a motion vector of the second control point, a motion vector of the third control point, and a motion vector of the fourth control point; determine a difference between a horizontal component of the motion vector of the first

42

control point and a horizontal component of the motion vector of the second control point as the first horizontal component difference; determine a difference between a vertical component of the motion vector of the first control point and a vertical component of the motion vector of the second control point as the first vertical component difference; determine a difference between a horizontal component of the motion vector of the third control point and a horizontal component of the motion vector of the fourth control point as the second horizontal component difference; and determine a difference between a vertical component of the motion vector of the third control point and a vertical component of the motion vector of the fourth control point as the second vertical component difference.

Optionally, in an embodiment, the first control point and the second control point are two adjacent pixels, and the third control point and the fourth control point are two adjacent pixels.

The processor 41 is specifically configured to: determine a motion vector of a first pixel, a motion vector of a second pixel, and a motion vector of a third pixel, where the first pixel, the second pixel, and the third pixel are non-overlapping pixels; determine a second horizontal distance and a second vertical distance between the first pixel and the second pixel; determine a third horizontal distance and a third vertical distance between the first pixel and the third pixel; and determine the first horizontal component difference, the first vertical component difference, the second horizontal component difference, and the second vertical component difference according to the motion vector of the first pixel, the motion vector of the second pixel, the motion vector of the third pixel, the second horizontal distance, the second vertical distance, the third horizontal distance, and the third vertical distance.

Optionally, in an embodiment, the processor 41 is specifically configured to: determine a ratio of a product of the motion vector precision and the first horizontal distance to the first component of the motion vector difference as a length of the affine motion compensation picture subblock in a horizontal direction; and determine a ratio of a product of the motion vector precision and the first vertical distance to the second component of the motion vector difference as a length of the affine motion compensation picture subblock in a vertical direction.

Optionally, in an embodiment, the processor 41 is specifically configured to: when a ratio of a product of the motion vector precision and the first horizontal distance to the first component of the motion vector difference is greater than or equal to a first preset value, determine the ratio as a length of the affine motion compensation picture subblock in a horizontal direction; or when a ratio of a product of the motion vector precision and the first horizontal distance to the first component of the motion vector difference is less than the first preset value, determine the first preset value as a length of the affine motion compensation picture subblock in a horizontal direction; and when a ratio of a product of the motion vector precision and the first vertical distance to the second component of the motion vector difference is greater than or equal to a second preset value, determine the ratio as a length of the affine motion compensation picture subblock in a vertical direction; or when a ratio of a product of the motion vector precision and the first vertical distance to the second component of the motion vector difference is less than the second preset value, determine the second preset value as a length of the affine motion compensation picture subblock in a vertical direction.

Optionally, in an embodiment, the first control point and the third control point are the same pixel.

Optionally, in an embodiment, the first control point, the second control point, the third control point, and the fourth control point are vertices of the affine picture block.

Optionally, in an embodiment, the first preset value is 4, and/or the second preset value is 4.

Optionally, in an embodiment, the processor **41** is specifically configured to: determine a third preset value as the motion vector precision of the affine picture block; or determine the motion vector precision of the affine picture block according to a feature of a picture block adjacent to the affine picture block, where the adjacent picture block is a picture block spatially and/or temporally adjacent to the affine picture block.

Optionally, in an embodiment, the processor **41** is specifically configured to: determine a motion vector of each affine motion compensation picture subblock in the affine motion compensation picture subblocks; determine a motion compensation prediction signal of each affine motion compensation picture subblock according to the motion vector of each affine motion compensation picture subblock; determine a prediction residual signal of each affine motion compensation picture subblock according to the motion compensation prediction signal of each affine motion compensation picture subblock; and decode the prediction residual signal of each affine motion compensation picture subblock.

Optionally, in an embodiment, the processor **41** is further configured to filter signals of boundary pixels of each affine motion compensation picture subblock, where the boundary pixels are pixels in one or more rows at a boundary of each affine motion compensation picture subblock.

Optionally, in an embodiment, the signal of the boundary pixel includes a motion compensation prediction signal and/or a reconstructed signal, and the reconstructed signal is a sum of the motion compensation prediction signal and a reconstructed residual signal.

It should be understood that, the decoding device **40** according to this embodiment of the present invention may correspond to the decoding device **20** in the embodiments of the present invention, and may correspond to a corresponding entity that performs the method **2000** according to the embodiments of the present invention, and the foregoing and other operations and/or functions of the modules in the decoding device **40** are separately intended to implement the corresponding procedures of the method in FIG. **12** to FIG. **18**. For brevity, details are not described again herein.

Therefore, the decoding device according to this embodiment of the present invention determines the size of the affine motion compensation picture subblock according to the determined motion vector difference of the affine picture block, the motion vector precision, and the distance between the control points, and performs decoding processing on the affine picture block according to the size. In this way, a picture subblock of an appropriate size is selected in the decoding process, so that decoding complexity can be reduced, and decoding efficiency can be improved.

It should be understood that, “an embodiment” or “an embodiment” mentioned in the whole specification does not mean that particular features, structures, or characteristics related to the embodiment are included in at least one embodiment of the present invention. Therefore, “in an embodiment” or “in an embodiment” appearing throughout the specification does not refer to a same embodiment. In addition, these particular features, structures, or character-

istics may be combined in one or more embodiments by using any appropriate manner.

It should be understood that, sequence numbers of the foregoing processes do not mean execution sequences in various embodiments of the present invention. The execution sequences of the processes should be determined according to functions and internal logic of the processes, and should not be construed as any limitation to the implementation processes of the embodiments of the present invention.

In addition, the terms “system” and “network” may be used interchangeably in this specification. The term “and/or” in this specification describes only an association relationship for describing associated objects and represents that three relationships may exist. For example, A and/or B may represent the following three cases: Only A exists, both A and B exist, and only B exists. In addition, unless otherwise specified, the character “/” in this specification generally indicates an “or” relationship between the associated objects.

It should be understood that, in the embodiments of this application, “B corresponding to A” indicates that B is associated with A, and B may be determined according to A. However, it should also be understood that, determining A according to B does not mean that B is determined according to A only; that is, B may also be determined according to A and/or other information.

A person of ordinary skill in the art may be aware that, in combination with the examples described in the embodiments disclosed in this specification, units and algorithm steps may be implemented by electronic hardware, computer software, or a combination thereof. To clearly describe the interchangeability between the hardware and the software, the foregoing has generally described compositions and steps of each example according to functions. Whether the functions are performed by hardware or software depends on particular applications and design constraint conditions of the technical solutions. A person skilled in the art may use different methods to implement the described functions for each particular application, but it should not be considered that the implementation goes beyond the scope of the present invention.

It may be clearly understood by a person skilled in the art that, for the purpose of convenient and brief description, for a detailed working process of the foregoing system, apparatus, and unit, reference may be made to a corresponding process in the foregoing method embodiments, and details are not described herein again.

In the several embodiments provided in this application, it should be understood that the disclosed system, apparatus, and method may be implemented in other manners. For example, the described apparatus embodiment is merely an example. For example, the unit division is merely logical function division and may be other division in actual implementation. For example, a plurality of units or components may be combined or integrated into another system, or some features may be ignored or not performed. In addition, the displayed or discussed mutual couplings or direct couplings or communication connections may be implemented by using some interfaces. The indirect couplings or communication connections between the apparatuses or units may be implemented in electronic, mechanical, or other forms.

The units described as separate parts may or may not be physically separate, and parts displayed as units may or may not be physical units, may be located in one position, or may be distributed on a plurality of network units. Some or all of

the units may be selected according to actual requirements to achieve the objectives of the solutions of the embodiments.

In addition, functional units in the embodiments of the present invention may be integrated into one processing unit, or each of the units may exist alone physically, or two or more units are integrated into one unit.

When the integrated unit is implemented in the form of a software functional unit and sold or used as an independent product, the integrated unit may be stored in a computer-readable storage medium. Based on such an understanding, the technical solutions of the present invention essentially, or the part contributing to the prior art, or some of the technical solutions may be implemented in a form of a software product. The software product is stored in a storage medium, and includes several instructions for instructing a computer device (which may be a personal computer, a server, or a network device) to perform all or some of the steps of the methods described in the embodiments of the present invention. The foregoing storage medium includes: any medium that can store program code, such as a USB flash drive, a removable hard disk, a read-only memory (Read-Only Memory, ROM for short), a random access memory (Random Access Memory, RAM for short), a magnetic disk, or an optical disc.

The foregoing descriptions are merely specific implementations of the present invention, but are not intended to limit the protection scope of the present invention. Any variation or replacement readily figured out by a person skilled in the art within the technical scope disclosed in the present invention shall fall within the protection scope of the present invention. Therefore, the protection scope of the present invention shall be subject to the protection scope of the claims.

What is claimed is:

1. A video picture coding method, the method comprising:
 - determining a motion vector difference of an affine picture block;
 - determining motion vector precision of the affine picture block;
 - determining a size of an affine motion compensation picture subblock in the affine picture block according to the motion vector difference, the motion vector precision, and a distance between control points in the affine picture block, wherein the control points are pixels used to determine the motion vector difference; and
 - performing coding processing on the affine picture block according to the size of the affine motion compensation picture subblock.
2. The method according to claim 1, wherein the determining a motion vector difference of an affine picture block comprises:
 - determining a first component of the motion vector difference according to a difference between motion vectors of a first control point and a second control point that are located on a same horizontal line; and
 - determining a second component of the motion vector difference according to a difference between motion vectors of a third control point and a fourth control point that are located on a same vertical line; wherein a first horizontal distance exists between the first control point and the second control point, and a first vertical distance exists between the third control point and the fourth control point.
3. The method according to claim 2, wherein the determining a first component of the motion vector difference according to a difference between motion vectors of a first

control point and a second control point that are located on a same horizontal line comprises:

- determining a first horizontal component difference and a first vertical component difference between the motion vectors of the first control point and the second control point; and
- determining a larger one of the first horizontal component difference and the first vertical component difference as the first component of the motion vector difference; and
- the determining a second component of the motion vector difference according to a difference between motion vectors of a third control point and a fourth control point that are located on a same vertical line comprises:
 - determining a second horizontal component difference and a second vertical component difference between the motion vectors of the third control point and the fourth control point; and
 - determining a larger one of the second horizontal component difference and the second vertical component difference as the second component of the motion vector difference.
4. The method according to claim 3, wherein the method further comprises:
 - determining an affine transformation parameter of a pixel in the affine picture block, wherein pixels in the affine picture block have the same affine transformation parameter;
 - the determining a first horizontal component difference and a first vertical component difference between the motion vectors of the first control point and the second control point comprises:
 - determining the first horizontal component difference and the first vertical component difference according to the affine transformation parameter and the first horizontal distance; and
 - the determining a second horizontal component difference and a second vertical component difference between the motion vectors of the third control point and the fourth control point comprises:
 - determining the second horizontal component difference and the second vertical component difference according to the affine transformation parameter and the first vertical distance.
 5. The method according to claim 4, wherein the determining a size of an affine motion compensation picture subblock according to the motion vector difference, the motion vector precision, and a distance between control points in the affine picture block comprises:
 - determining a ratio of a product of the motion vector precision and the first horizontal distance to the first component of the motion vector difference as a length of the affine motion compensation picture subblock in a horizontal direction; and
 - determining a ratio of a product of the motion vector precision and the first vertical distance to the second component of the motion vector difference as a length of the affine motion compensation picture subblock in a vertical direction.
 6. The method according to claim 4, wherein the determining a size of an affine motion compensation picture subblock in the affine picture block according to the motion vector difference, the motion vector precision, and a distance between control points in the affine picture block comprises:
 - when a ratio of a product of the motion vector precision and the first horizontal distance to the first component of the motion vector difference is greater than or equal

47

to a first preset value, determining the ratio as a length of the affine motion compensation picture subblock in a horizontal direction; or
 when a ratio of a product of the motion vector precision and the first horizontal distance to the first component of the motion vector difference is less than the first preset value, determining the first preset value as a length of the affine motion compensation picture subblock in a horizontal direction; and
 when a ratio of a product of the motion vector precision and the first vertical distance to the second component of the motion vector difference is greater than or equal to a second preset value, determining the ratio as a length of the affine motion compensation picture subblock in a vertical direction; or
 when a ratio of a product of the motion vector precision and the first vertical distance to the second component of the motion vector difference is less than the second preset value, determining the second preset value as a length of the affine motion compensation picture subblock in a vertical direction.

7. The method according to claim 6, wherein at least one of the first preset value and the second preset value is 4.

8. The method according to claim 3, wherein the method further comprises:
 determining a motion vector of the first control point, a motion vector of the second control point, a motion vector of the third control point, and a motion vector of the fourth control point;
 the determining a first horizontal component difference and a first vertical component difference between the motion vectors of the first control point and the second control point comprises:
 determining a difference between a horizontal component of the motion vector of the first control point and a horizontal component of the motion vector of the second control point as the first horizontal component difference; and
 determining a difference between a vertical component of the motion vector of the first control point and a vertical component of the motion vector of the second control point as the first vertical component difference; and
 the determining a second horizontal component difference and a second vertical component difference between the motion vectors of the third control point and the fourth control point comprises:
 determining a difference between a horizontal component of the motion vector of the third control point and a horizontal component of the motion vector of the fourth control point as the second horizontal component difference; and
 determining a difference between a vertical component of the motion vector of the third control point and a vertical component of the motion vector of the fourth control point as the second vertical component difference.

9. The method according to claim 3, wherein the first control point and the second control point are two adjacent pixels, and the third control point and the fourth control point are two adjacent pixels; and
 the determining a first horizontal component difference and a first vertical component difference between the motion vectors of the first control point and the second control point, and the determining a second horizontal component difference and a second vertical component difference between the motion vectors of the third control point and the fourth control point comprise:

48

determining a motion vector of a first pixel, a motion vector of a second pixel, and a motion vector of a third pixel, wherein the first pixel, the second pixel, and the third pixel are non-overlapping pixels;
 determining a second horizontal distance and a second vertical distance between the first pixel and the second pixel;
 determining a third horizontal distance and a third vertical distance between the first pixel and the third pixel; and
 determining the first horizontal component difference, the first vertical component difference, the second horizontal component difference, and the second vertical component difference according to the motion vector of the first pixel, the motion vector of the second pixel, the motion vector of the third pixel, the second horizontal distance, the second vertical distance, the third horizontal distance, and the third vertical distance.

10. The method according to claim 2, wherein the first control point and the third control point are the same pixel.

11. The method according to claim 2, wherein the first control point, the second control point, the third control point, and the fourth control point are vertices of the affine picture block, and the affine picture block is rectangular.

12. The method according to claim 1, wherein determining the motion vector precision of the affine picture block comprises:
 determining a third preset value as the motion vector precision of the affine picture block; or
 determining the motion vector precision of the affine picture block according to a feature of a picture block adjacent to the affine picture block, wherein the adjacent picture block is a picture block spatially or temporally adjacent to the affine picture block.

13. The method according to claim 1, wherein the performing coding processing on the affine picture block according to the size of the affine motion compensation picture subblock comprises:
 determining a motion vector of each affine motion compensation picture subblock in the affine motion compensation picture subblocks;
 determining a motion compensation prediction signal of each affine motion compensation picture subblock according to the motion vector of each affine motion compensation picture subblock;
 determining a prediction residual signal of each affine motion compensation picture subblock according to the motion compensation prediction signal of each affine motion compensation picture subblock; and
 coding the prediction residual signal of each affine motion compensation picture subblock.

14. The method according to claim 13, wherein the method further comprises:
 filtering signals of boundary pixels of each affine motion compensation picture subblock, wherein the boundary pixels are pixels in one or more rows at a boundary of each affine motion compensation picture subblock.

15. The method according to claim 14, wherein the signal of the boundary pixel comprises a motion compensation prediction signal or a reconstructed signal, and the reconstructed signal is a sum of the motion compensation prediction signal and a reconstructed residual signal.

16. A video picture decoding method, the method comprising:
 determining a motion vector difference of an affine picture block;
 determining motion vector precision of the affine picture block;

49

determining a size of an affine motion compensation picture subblock in the affine picture block according to the motion vector difference, the motion vector precision, and a distance between control points in the affine picture block, wherein the control points are pixels used to determine the motion vector difference; and performing decoding processing on the affine picture block according to the size of the affine motion compensation picture subblock.

17. The method according to claim 16, wherein the determining a motion vector difference of an affine picture block comprises:

determining a first component of the motion vector difference according to a difference between motion vectors of a first control point and a second control point that are located on a same horizontal line; and

determining a second component of the motion vector difference according to a difference between motion vectors of a third control point and a fourth control point that are located on a same vertical line; wherein a first horizontal distance exists between the first control point and the second control point, and a first vertical distance exists between the third control point and the fourth control point.

18. The method according to claim 17, wherein the determining a first component of the motion vector difference according to a difference between motion vectors of a first control point and a second control point that are located on a same horizontal line comprises:

determining a first horizontal component difference and a first vertical component difference between the motion vectors of the first control point and the second control point; and

determining a larger one of the first horizontal component difference and the first vertical component difference as the first component of the motion vector difference; and the determining a second component of the motion vector difference according to a difference between motion vectors of a third control point and a fourth control point that are located on a same vertical line comprises:

determining a second horizontal component difference and a second vertical component difference between the motion vectors of the third control point and the fourth control point; and

determining a larger one of the second horizontal component difference and the second vertical component difference as the second component of the motion vector difference.

19. The method according to claim 18, wherein the method further comprises:

determining an affine transformation parameter of a pixel in the affine picture block, wherein pixels in the affine picture block have the same affine transformation parameter;

the determining a first horizontal component difference and a first vertical component difference between the motion vectors of the first control point and the second control point comprises:

determining the first horizontal component difference and the first vertical component difference according to the affine transformation parameter and the first horizontal distance; and

the determining a second horizontal component difference and a second vertical component difference between the motion vectors of the third control point and the fourth control point comprises:

50

determining the second horizontal component difference and the second vertical component difference according to the affine transformation parameter and the first vertical distance.

20. The method according to claim 19, wherein the determining a size of an affine motion compensation picture subblock according to the motion vector difference, the motion vector precision, and a distance between control points in the affine picture block comprises:

determining a ratio of a product of the motion vector precision and the first horizontal distance to the first component of the motion vector difference as a length of the affine motion compensation picture subblock in a horizontal direction; and

determining a ratio of a product of the motion vector precision and the first vertical distance to the second component of the motion vector difference as a length of the affine motion compensation picture subblock in a vertical direction.

21. The method according to claim 19, wherein the determining a size of an affine motion compensation picture subblock in the affine picture block according to the motion vector difference, the motion vector precision, and a distance between control points in the affine picture block comprises:

when a ratio of a product of the motion vector precision and the first horizontal distance to the first component of the motion vector difference is greater than or equal to a first preset value, determining the ratio as a length of the affine motion compensation picture subblock in a horizontal direction; or

when a ratio of a product of the motion vector precision and the first horizontal distance to the first component of the motion vector difference is less than the first preset value, determining the first preset value as a length of the affine motion compensation picture subblock in a horizontal direction; and

when a ratio of a product of the motion vector precision and the first vertical distance to the second component of the motion vector difference is greater than or equal to a second preset value, determining the ratio as a length of the affine motion compensation picture subblock in a vertical direction; or

when a ratio of a product of the motion vector precision and the first vertical distance to the second component of the motion vector difference is less than the second preset value, determining the second preset value as a length of the affine motion compensation picture subblock in a vertical direction.

22. The method according to claim 21, wherein at least one of the first preset value and the second preset value is 4.

23. The method according to claim 18, wherein the method further comprises:

determining a motion vector of the first control point, a motion vector of the second control point, a motion vector of the third control point, and a motion vector of the fourth control point;

the determining a first horizontal component difference and a first vertical component difference between the motion vectors of the first control point and the second control point comprises:

determining a difference between a horizontal component of the motion vector of the first control point and a horizontal component of the motion vector of the second control point as the first horizontal component difference; and

determining a difference between a vertical component of the motion vector of the first control point and a vertical

51

component of the motion vector of the second control point as the first vertical component difference; and the determining a second horizontal component difference and a second vertical component difference between the motion vectors of the third control point and the fourth control point comprises:

5 determining a difference between a horizontal component of the motion vector of the third control point and a horizontal component of the motion vector of the fourth control point as the second horizontal component difference; and

10 determining a difference between a vertical component of the motion vector of the third control point and a vertical component of the motion vector of the fourth control point as the second vertical component difference.

24. The method according to claim 18, wherein the first control point and the second control point are two adjacent pixels, and the third control point and the fourth control point are two adjacent pixels; and

25 the determining a first horizontal component difference and a first vertical component difference between the motion vectors of the first control point and the second control point, and the determining a second horizontal component difference and a second vertical component difference between the motion vectors of the third control point and the fourth control point comprise:

30 determining a motion vector of a first pixel, a motion vector of a second pixel, and a motion vector of a third pixel, wherein the first pixel, the second pixel, and the third pixel are non-overlapping pixels;

determining a second horizontal distance and a second vertical distance between the first pixel and the second pixel;

35 determining a third horizontal distance and a third vertical distance between the first pixel and the third pixel; and

determining the first horizontal component difference, the first vertical component difference, the second horizontal component difference, and the second vertical component difference according to the motion vector of the first pixel, the motion vector of the second pixel, the motion vector of the third pixel, the second horizontal distance, the second vertical distance, the third horizontal distance, and the third vertical distance.

45 25. The method according to claim 17, wherein the first control point and the third control point are the same pixel.

26. The method according to claim 17, wherein the first control point, the second control point, the third control point, and the fourth control point are vertices of the affine picture block, and the affine picture block is rectangular.

50 27. The method according to claim 16, wherein determining the motion vector precision of the affine picture block comprises:

determining a third preset value as the motion vector precision of the affine picture block; or

55 determining the motion vector precision of the affine picture block according to a feature of a picture block adjacent to the affine picture block, wherein the adjacent picture block is a picture block spatially or temporally adjacent to the affine picture block.

28. The method according to claim 16, wherein the performing decoding processing on the affine picture block according to the size of the affine motion compensation picture subblock comprises:

65 determining a motion vector of each affine motion compensation picture subblock in the affine motion compensation picture subblocks;

52

determining a motion compensation prediction signal of each affine motion compensation picture subblock according to the motion vector of each affine motion compensation picture subblock;

determining a prediction residual signal of each affine motion compensation picture subblock according to the motion compensation prediction signal of each affine motion compensation picture subblock; and

decoding the prediction residual signal of each affine motion compensation picture subblock.

29. The method according to claim 28, wherein the method further comprises:

filtering signals of boundary pixels of each affine motion compensation picture subblock, wherein the boundary pixels are pixels in one or more rows at a boundary of each affine motion compensation picture subblock.

30. The method according to claim 29, wherein the signal of the boundary pixel comprises a motion compensation prediction signal or a reconstructed signal, and the reconstructed signal is a sum of the motion compensation prediction signal and a reconstructed residual signal.

31. A coding device comprising:

a processor;

a memory storing a program to be executed in the processor, the program comprising a plurality of modules of instruction, the plurality of modules comprising:

a first determining module, configured to determine a motion vector difference of an affine picture block;

a second determining module, configured to determine motion vector precision of the affine picture block;

a third determining module, configured to determine a size of an affine motion compensation picture subblock in the affine picture block according to the motion vector difference determined by the first determining module, the motion vector precision determined by the second determining module, and a distance between control points in the affine picture block, wherein the control points are pixels used to determine the motion vector difference; and

a coding module, configured to perform coding processing on the affine picture block according to the size of the affine motion compensation picture subblock that is determined by the third determining module.

32. The coding device according to claim 31, wherein the first determining module comprises instructions for:

determining a first component of the motion vector difference according to a difference between motion vectors of a first control point and a second control point that are located on a same horizontal line; and

determining a second component of the motion vector difference according to a difference between motion vectors of a third control point and a fourth control point that are located on a same vertical line; wherein a first horizontal distance exists between the first control point and the second control point, and a first vertical distance exists between the third control point and the fourth control point.

33. The coding device according to claim 32, wherein the first determining module comprises instructions for:

determining a first horizontal component difference and a first vertical component difference between the motion vectors of the first control point and the second control point;

65 determining a larger one of the first horizontal component difference and the first vertical component difference as the first component of the motion vector difference;

53

determining a second horizontal component difference and a second vertical component difference between the motion vectors of the third control point and the fourth control point; and
 determining a larger one of the second horizontal component difference and the second vertical component difference as the second component of the motion vector difference.

34. The coding device according to claim **33**, wherein the first determining module comprises instructions for:

determining an affine transformation parameter of a pixel in the affine picture block, wherein pixels in the affine picture block have the same affine transformation parameter;

determining the first horizontal component difference and the first vertical component difference according to the affine transformation parameter and the first horizontal distance; and

determining the second horizontal component difference and the second vertical component difference according to the affine transformation parameter and the first vertical distance.

35. The coding device according to claim **34**, wherein the third determining module comprises instructions for:

determining a ratio of a product of the motion vector precision and the first horizontal distance to the first component of the motion vector difference as a length of the affine motion compensation picture subblock in a horizontal direction; and

determining a ratio of a product of the motion vector precision and the first vertical distance to the second component of the motion vector difference as a length of the affine motion compensation picture subblock in a vertical direction.

36. The coding device according to claim **34**, wherein the third determining module comprises instructions for:

when a ratio of a product of the motion vector precision and the first horizontal distance to the first component of the motion vector difference is greater than or equal to a first preset value, determining the ratio as a length of the affine motion compensation picture subblock in a horizontal direction; or

when a ratio of a product of the motion vector precision and the first horizontal distance to the first component of the motion vector difference is less than the first preset value, determining the first preset value as a length of the affine motion compensation picture subblock in a horizontal direction; and

when a ratio of a product of the motion vector precision and the first vertical distance to the second component of the motion vector difference is greater than or equal to a second preset value, determining the ratio as a length of the affine motion compensation picture subblock in a vertical direction; or

when a ratio of a product of the motion vector precision and the first vertical distance to the second component of the motion vector difference is less than the second preset value, determining the second preset value as a length of the affine motion compensation picture subblock in a vertical direction.

37. The coding device according to claim **36**, wherein at least one of the first preset value and the second preset value is 4.

38. The coding device according to claim **33**, wherein the first determining module comprises instructions for:

54

determining a motion vector of the first control point, a motion vector of the second control point, a motion vector of the third control point, and a motion vector of the fourth control point;

determining a difference between a horizontal component of the motion vector of the first control point and a horizontal component of the motion vector of the second control point as the first horizontal component difference;

determining a difference between a vertical component of the motion vector of the first control point and a vertical component of the motion vector of the second control point as the first vertical component difference;

determining a difference between a horizontal component of the motion vector of the third control point and a horizontal component of the motion vector of the fourth control point as the second horizontal component difference; and

determining a difference between a vertical component of the motion vector of the third control point and a vertical component of the motion vector of the fourth control point as the second vertical component difference.

39. The coding device according to claim **33**, wherein the first control point and the second control point are two adjacent pixels, and the third control point and the fourth control point are two adjacent pixels; and

the first determining module comprises instructions for:

determining a motion vector of a first pixel, a motion vector of a second pixel, and a motion vector of a third pixel, wherein the first pixel, the second pixel, and the third pixel are non-overlapping pixels;

determining a second horizontal distance and a second vertical distance between the first pixel and the second pixel;

determining a third horizontal distance and a third vertical distance between the first pixel and the third pixel; and

determining the first horizontal component difference, the first vertical component difference, the second horizontal component difference, and the second vertical component difference according to the motion vector of the first pixel, the motion vector of the second pixel, the motion vector of the third pixel, the second horizontal distance, the second vertical distance, the third horizontal distance, and the third vertical distance.

40. The coding device according to claim **32**, wherein the first control point and the third control point are the same pixel.

41. The coding device according to claim **32**, wherein the first control point, the second control point, the third control point, and the fourth control point are vertices of the affine picture block, and the affine picture block is rectangular.

42. The coding device according to claim **31**, wherein the second determining module comprises instructions for:

determining a third preset value as the motion vector precision of the affine picture block; or

determining the motion vector precision of the affine picture block according to a feature of a picture block adjacent to the affine picture block, wherein the adjacent picture block is a picture block spatially or temporally adjacent to the affine picture block.

43. The coding device according to claim **31**, wherein the coding module comprises instructions for:

determining a motion vector of each affine motion compensation picture subblock in the affine motion compensation picture subblocks;

55

determining a motion compensation prediction signal of each affine motion compensation picture subblock according to the motion vector of each affine motion compensation picture subblock;

determining a prediction residual signal of each affine motion compensation picture subblock according to the motion compensation prediction signal of each affine motion compensation picture subblock; and

code the prediction residual signal of each affine motion compensation picture subblock.

44. The coding device according to claim 43, wherein the plurality of modules further comprises:

- a filtering module, configured to filter signals of boundary pixels of each affine motion compensation picture subblock, wherein the boundary pixels are pixels in one or more rows at a boundary of each affine motion compensation picture subblock.

45. The coding device according to claim 44, wherein the signal of the boundary pixel comprises a motion compensation prediction signal or a reconstructed signal, and the reconstructed signal is a sum of the motion compensation prediction signal and a reconstructed residual signal.

46. A decoding device comprising:

- a processor;
- a memory storing a program to be executed in the processor, the program comprising a plurality of modules of instruction, the plurality of modules comprising:
 - a first determining module, configured to determine a motion vector difference of an affine picture block;
 - a second determining module, configured to determine motion vector precision of the affine picture block;
 - a third determining module, configured to determine a size of an affine motion compensation picture subblock in the affine picture block according to the motion vector difference determined by the first determining module, the motion vector precision determined by the second determining module, and a distance between control points in the affine picture block, wherein the control points are pixels used to determining the motion vector difference; and
- a decoding module, configured to perform decoding processing on the affine picture block according to the size of the affine motion compensation picture subblock that is determined by the third determining module.

47. The decoding device according to claim 46, wherein the first determining module comprises instructions for:

- determining a first component of the motion vector difference according to a difference between motion vectors of a first control point and a second control point that are located on a same horizontal line; and
- determining a second component of the motion vector difference according to a difference between motion vectors of a third control point and a fourth control point that are located on a same vertical line; wherein a first horizontal distance exists between the first control point and the second control point, and a first vertical distance exists between the third control point and the fourth control point.

48. The decoding device according to claim 47, wherein the first determining module comprises instructions for:

- determining a first horizontal component difference and a first vertical component difference between the motion vectors of the first control point and the second control point;
- determining a larger one of the first horizontal component difference and the first vertical component difference as the first component of the motion vector difference;

56

determining a second horizontal component difference and a second vertical component difference between the motion vectors of the third control point and the fourth control point; and

determining a larger one of the second horizontal component difference and the second vertical component difference as the second component of the motion vector difference.

49. The decoding device according to claim 48, wherein the first determining module comprises instructions for:

- determining an affine transformation parameter of a pixel in the affine picture block, wherein pixels in the affine picture block have the same affine transformation parameter;
- determining the first horizontal component difference and the first vertical component difference according to the affine transformation parameter and the first horizontal distance; and
- determining the second horizontal component difference and the second vertical component difference according to the affine transformation parameter and the first vertical distance.

50. The decoding device according to claim 49, wherein the third determining module comprises instructions for:

- determining a ratio of a product of the motion vector precision and the first horizontal distance to the first component of the motion vector difference as a length of the affine motion compensation picture subblock in a horizontal direction; and
- determining a ratio of a product of the motion vector precision and the first vertical distance to the second component of the motion vector difference as a length of the affine motion compensation picture subblock in a vertical direction.

51. The decoding device according to claim 49, wherein the third determining module comprises instructions for:

- when a ratio of a product of the motion vector precision and the first horizontal distance to the first component of the motion vector difference is greater than or equal to a first preset value, determining the ratio as a length of the affine motion compensation picture subblock in a horizontal direction; or
- when a ratio of a product of the motion vector precision and the first horizontal distance to the first component of the motion vector difference is less than the first preset value, determining the first preset value as a length of the affine motion compensation picture subblock in a horizontal direction; and
- when a ratio of a product of the motion vector precision and the first vertical distance to the second component of the motion vector difference is greater than or equal to a second preset value, determining the ratio as a length of the affine motion compensation picture subblock in a vertical direction; or
- when a ratio of a product of the motion vector precision and the first vertical distance to the second component of the motion vector difference is less than the second preset value, determining the second preset value as a length of the affine motion compensation picture subblock in a vertical direction.

52. The decoding device according to claim 51, wherein at least one of the first preset value and the second preset value is 4.

53. The decoding device according to claim 48, wherein the first determining module comprises instructions for:

57

determining a motion vector of the first control point, a motion vector of the second control point, a motion vector of the third control point, and a motion vector of the fourth control point;

determining a difference between a horizontal component of the motion vector of the first control point and a horizontal component of the motion vector of the second control point as the first horizontal component difference;

determining a difference between a vertical component of the motion vector of the first control point and a vertical component of the motion vector of the second control point as the first vertical component difference;

determining a difference between a horizontal component of the motion vector of the third control point and a horizontal component of the motion vector of the fourth control point as the second horizontal component difference; and

determining a difference between a vertical component of the motion vector of the third control point and a vertical component of the motion vector of the fourth control point as the second vertical component difference.

54. The decoding device according to claim **48**, wherein the first control point and the second control point are two adjacent pixels, and the third control point and the fourth control point are two adjacent pixels; and

the first determining module comprises instructions for:

determining a motion vector of a first pixel, a motion vector of a second pixel, and a motion vector of a third pixel, wherein the first pixel, the second pixel, and the third pixel are non-overlapping pixels;

determining a second horizontal distance and a second vertical distance between the first pixel and the second pixel;

determining a third horizontal distance and a third vertical distance between the first pixel and the third pixel; and

determining the first horizontal component difference, the first vertical component difference, the second horizontal component difference, and the second vertical component difference according to the motion vector of the first pixel, the motion vector of the second pixel, the motion vector of the third pixel, the second horizontal distance, the second vertical distance, the third horizontal distance, and the third vertical distance.

58

55. The decoding device according to claim **47**, wherein the first control point and the third control point are the same pixel.

56. The decoding device according to claim **47**, wherein the first control point, the second control point, the third control point, and the fourth control point are vertices of the affine picture block, and the affine picture block is rectangular.

57. The decoding device according to claim **46**, wherein the second determining module comprises instructions for:

determining a third preset value as the motion vector precision of the affine picture block; or

determining the motion vector precision of the affine picture block according to a feature of a picture block adjacent to the affine picture block, wherein the adjacent picture block is a picture block spatially or temporally adjacent to the affine picture block.

58. The decoding device according to claim **46**, wherein the decoding module comprises instructions for:

determining a motion vector of each affine motion compensation picture subblock in the affine motion compensation picture subblocks;

determining a motion compensation prediction signal of each affine motion compensation picture subblock according to the motion vector of each affine motion compensation picture subblock;

determining a prediction residual signal of each affine motion compensation picture subblock according to the motion compensation prediction signal of each affine motion compensation picture subblock; and

decode the prediction residual signal of each affine motion compensation picture subblock.

59. The decoding device according to claim **58**, wherein the plurality of modules further comprises:

a filtering module, configured to filter signals of boundary pixels of each affine motion compensation picture subblock, wherein the boundary pixels are pixels in one or more rows at a boundary of each affine motion compensation picture subblock.

60. The decoding device according to claim **59**, wherein the signal of the boundary pixel comprises a motion compensation prediction signal or a reconstructed signal, and the reconstructed signal is a sum of the motion compensation prediction signal and a reconstructed residual signal.

* * * * *