



US010337592B2

(12) **United States Patent**  
**Foster et al.**

(10) **Patent No.:** **US 10,337,592 B2**  
(45) **Date of Patent:** **Jul. 2, 2019**

(54) **MULTI-SPEED TRANSMISSION**

USPC ..... 475/275-291, 330  
See application file for complete search history.

(71) Applicant: **ALLISON TRANSMISSION, INC.**,  
Indianapolis, IN (US)

(56) **References Cited**

(72) Inventors: **Michael Foster**, Carmel, IN (US);  
**Brian Schoolcraft**, Crawfordsville, IN (US)

U.S. PATENT DOCUMENTS

(73) Assignee: **ALLISON TRANSMISSION, INC.**,  
Indianapolis, IN (US)

6,176,803	B1	1/2001	Meyer et al.
6,910,985	B2	6/2005	Ishimaru et al.
6,955,627	B2	10/2005	Thomas et al.
6,984,187	B2	1/2006	Biermann
7,101,305	B2	9/2006	Tabata et al.
7,226,381	B2	6/2007	Klemen
7,429,230	B2	9/2008	Ziemer
7,549,942	B2	6/2009	Gumpoltsberger
7,556,582	B2	7/2009	Gumpoltsberger
7,566,283	B2	7/2009	Gumpoltsberger
7,575,533	B2	8/2009	Gumpoltsberger
7,632,206	B2	12/2009	Gumpoltsberger
7,651,431	B2	1/2010	Phillips et al.
7,674,200	B2	3/2010	Shim
7,686,730	B2	3/2010	Baldwin
7,691,022	B2	4/2010	Phillips et al.

(\*) Notice: Subject to any disclaimer, the term of this patent is extended or adjusted under 35 U.S.C. 154(b) by 0 days.

(21) Appl. No.: **15/942,794**

(22) Filed: **Apr. 2, 2018**

(65) **Prior Publication Data**

US 2018/0223966 A1 Aug. 9, 2018

**Related U.S. Application Data**

(62) Division of application No. 15/498,770, filed on Apr. 27, 2017, now Pat. No. 9,982,756, which is a division of application No. 14/695,143, filed on Apr. 24, 2015, now Pat. No. 9,689,467.

(51) **Int. Cl.**  
**F16H 3/66** (2006.01)

(52) **U.S. Cl.**  
CPC ..... **F16H 3/66** (2013.01); **F16H 3/666** (2013.01); **F16H 2200/006** (2013.01); **F16H 2200/2012** (2013.01); **F16H 2200/2015** (2013.01); **F16H 2200/2043** (2013.01)

(58) **Field of Classification Search**  
CPC .... **F16H 3/66**; **F16H 3/666**; **F16H 2200/2043**; **F16H 2200/2012**; **F16H 2200/006**

(Continued)

*Primary Examiner* — Roger L Pang

(74) *Attorney, Agent, or Firm* — Taft Stettinius & Hollister LLP; Stephen F. Rost

(57) **ABSTRACT**

The present disclosure provides a multiple speed transmission having an input member, an output member, a plurality of planetary gearsets, a plurality of interconnecting members and a plurality of torque-transmitting mechanisms. The plurality of planetary gear sets includes first, second and ring gears. The input member is continuously interconnected with at least one member of one of the plurality of planetary gear sets, and the output member is continuously interconnected with another member of one of the plurality of planetary gear sets. At least eight forward speeds and one reverse speed are achieved by the selective engagement of the five torque-transmitting mechanisms.

**20 Claims, 12 Drawing Sheets**

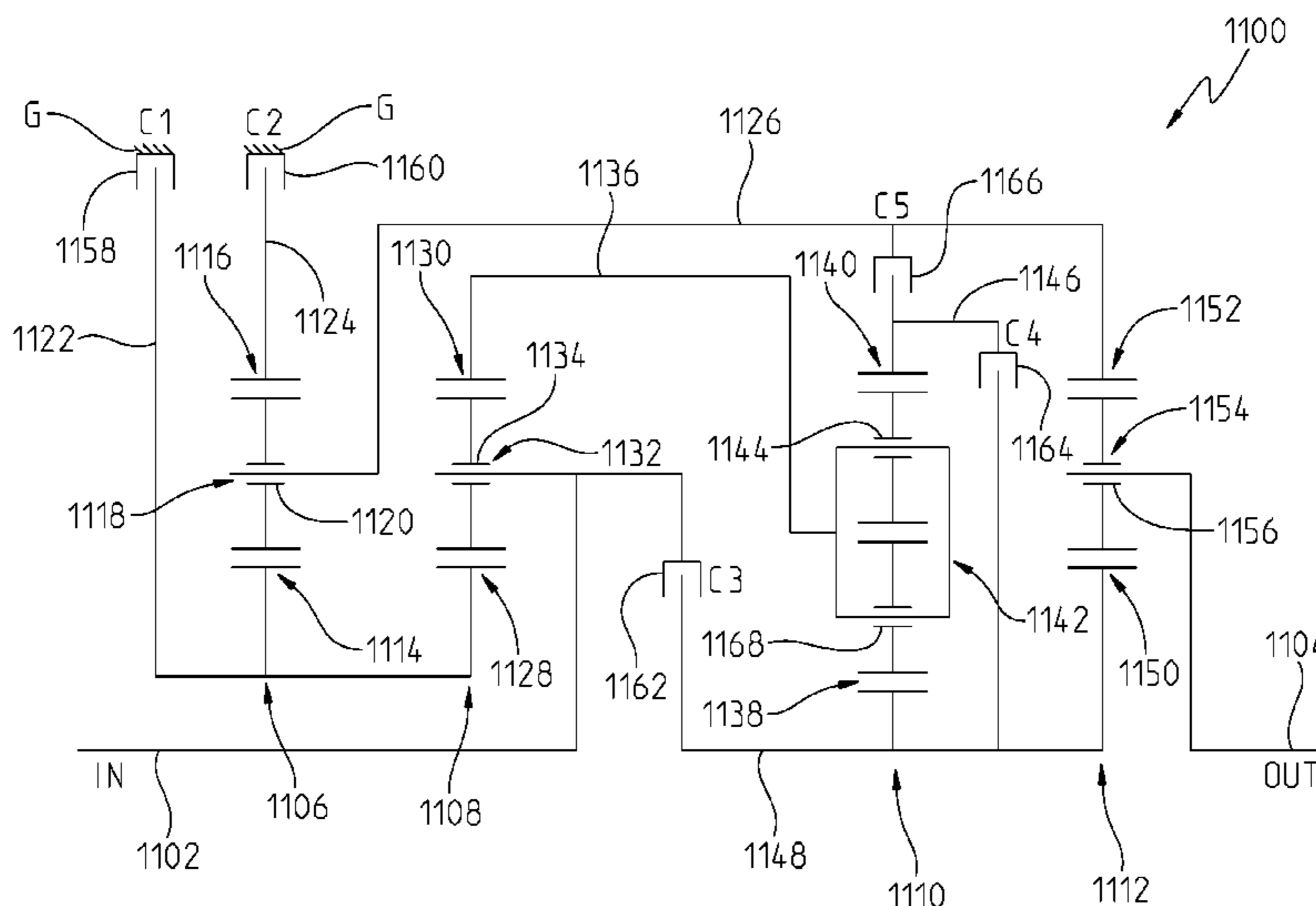

(56)

## References Cited

## U.S. PATENT DOCUMENTS

7,691,024 B2	4/2010	Phillips et al.	8,303,453 B2	11/2012	Wittkopp et al.
7,695,398 B2	4/2010	Phillips et al.	8,303,455 B2	11/2012	Gumpoltsberger et al.
7,704,181 B2	4/2010	Phillips et al.	8,303,456 B2	11/2012	Kim
7,722,496 B2	5/2010	Phillips et al.	8,328,678 B2	12/2012	Seo et al.
7,727,104 B2	6/2010	Shim	8,328,679 B2	12/2012	Jang et al.
7,731,625 B2	6/2010	Phillips et al.	8,333,676 B2 *	12/2012	Kim ..... F16H 3/666 475/277
7,736,263 B2	6/2010	Phillips et al.	8,343,005 B2	1/2013	Hart et al.
7,753,820 B2	7/2010	Phillips et al.	8,366,580 B2	2/2013	Wittkopp et al.
7,771,306 B2	8/2010	Phillips et al.	8,371,982 B2	2/2013	Lee et al.
7,828,690 B2	11/2010	Wittkopp et al.	8,376,893 B2	2/2013	Wittkopp et al.
7,841,960 B2	11/2010	Baldwin	8,376,895 B2	2/2013	Saitoh et al.
7,846,057 B2	12/2010	Shim	8,382,634 B2	2/2013	Beck et al.
7,846,058 B2	12/2010	Shim	8,398,522 B2	3/2013	Bauknecht et al.
7,850,568 B2	12/2010	Shim	8,403,803 B2	3/2013	Gumpoltsberger et al.
7,850,569 B2	12/2010	Seo et al.	8,409,047 B2	4/2013	Borgerson et al.
7,887,454 B2	2/2011	Phillips et al.	8,414,445 B2	4/2013	Carey et al.
7,909,729 B2	3/2011	Tanaka et al.	8,414,446 B2	4/2013	Beck et al.
7,914,414 B2	3/2011	Phillips et al.	8,419,587 B2	4/2013	Gumpoltsberger et al.
7,946,948 B2	5/2011	Phillips et al.	8,425,367 B2	4/2013	Phillips et al.
7,980,988 B2	7/2011	Phillips et al.	8,425,368 B2	4/2013	Phillips et al.
7,985,159 B2	7/2011	Phillips et al.	8,425,369 B2	4/2013	Wittkopp et al.
7,988,586 B2	8/2011	Phillips et al.	8,425,370 B2	4/2013	Leesch et al.
7,993,235 B2	8/2011	Wittkopp et al.	8,430,784 B2	4/2013	Hart et al.
7,993,237 B2	8/2011	Wittkopp et al.	8,430,785 B2	4/2013	Beck et al.
7,993,238 B2	8/2011	Phillips et al.	8,435,153 B2	5/2013	Phillips et al.
7,998,013 B2	8/2011	Phillips et al.	8,444,524 B2	5/2013	Gumpoltsberger et al.
8,001,662 B1	8/2011	Guber	8,444,525 B2	5/2013	Gumpoltsberger et al.
8,002,662 B2	8/2011	Phillips et al.	8,460,151 B2	6/2013	Wittkopp et al.
8,007,394 B2	8/2011	Phillips et al.	8,465,390 B2 *	6/2013	Brehmer ..... F16H 3/66 475/282
8,007,395 B2	8/2011	Wittkopp et al.	8,480,533 B2	7/2013	Meyer et al.
8,007,398 B2	8/2011	Phillips et al.	8,485,934 B2	7/2013	Gumpoltsberger et al.
8,016,713 B2	9/2011	Phillips et al.	8,496,558 B2	7/2013	Wittkopp et al.
8,033,948 B2	10/2011	Phillips et al.	8,506,442 B2	8/2013	Mellet et al.
8,038,565 B2	10/2011	Phillips et al.	8,512,196 B2	8/2013	Mellet et al.
8,038,566 B2	10/2011	Phillips et al.	8,523,729 B2	9/2013	Hart et al.
8,043,189 B2	10/2011	Phillips et al.	8,529,394 B2	9/2013	Gumpoltsberger et al.
8,043,192 B2	10/2011	Wittkopp et al.	8,529,395 B2	9/2013	Wittkopp et al.
8,047,950 B2	11/2011	Wittkopp et al.	8,529,396 B1	9/2013	Vernon et al.
8,047,951 B2	11/2011	Wittkopp et al.	8,545,362 B1	10/2013	Goleski et al.
8,047,954 B2	11/2011	Phillips et al.	8,556,766 B2	10/2013	Mellet et al.
8,052,566 B2	11/2011	Wittkopp et al.	8,556,768 B2	10/2013	Park et al.
8,052,567 B2	11/2011	Hart et al.	8,574,113 B1 *	11/2013	Goleski ..... F16H 3/66 475/282
8,057,349 B2	11/2011	Phillips et al.	8,574,114 B2	11/2013	Brehmer et al.
8,070,646 B2	12/2011	Hart et al.	8,591,364 B2	11/2013	Hart
8,079,932 B2	12/2011	Phillips et al.	8,591,377 B1	11/2013	Hoffman et al.
8,088,032 B2	1/2012	Gumpoltsberger et al.	8,597,152 B2	12/2013	Seo et al.
8,096,915 B2	1/2012	Wittkopp et al.	8,597,153 B2	12/2013	Saitoh et al.
8,100,808 B2	1/2012	Wittkopp et al.	8,602,934 B2	12/2013	Mellet et al.
8,105,198 B2	1/2012	Hart et al.	8,608,612 B2	12/2013	Park et al.
8,128,527 B2	3/2012	Hart et al.	8,617,022 B1	12/2013	Vernon et al.
8,142,324 B2	3/2012	Phillips et al.	8,636,617 B2	1/2014	Singh
8,142,325 B2	3/2012	Phillips et al.	8,636,618 B2	1/2014	Hart et al.
8,152,681 B2	4/2012	Seo et al.	8,647,227 B2	2/2014	Park et al.
8,157,697 B2	4/2012	Hart et al.	8,663,053 B2	3/2014	Beck et al.
8,167,765 B2	5/2012	Phillips et al.	8,663,055 B2 *	3/2014	Brehmer ..... F16H 3/66 475/282
8,167,766 B2	5/2012	Phillips et al.	8,663,056 B2	3/2014	Gumpoltsberger et al.
8,187,130 B1	5/2012	Mellet et al.	8,678,972 B2	3/2014	Wittkopp et al.
8,187,137 B2	5/2012	Carey et al.	8,702,554 B2	4/2014	Gumpoltsberger et al.
8,197,376 B2	6/2012	Gumpoltsberger et al.	8,702,555 B1	4/2014	Hart et al.
8,202,190 B2	6/2012	Phillips et al.	8,708,862 B2	4/2014	Park
8,206,257 B2	6/2012	Gumpoltsberger et al.	8,721,488 B2	5/2014	Mellet et al.
8,210,981 B2	7/2012	Bauknecht et al.	8,721,492 B2	5/2014	Fellmann et al.
8,210,982 B2	7/2012	Gumpoltsberger et al.	8,727,929 B2	5/2014	Beck et al.
8,210,983 B2	7/2012	Gumpoltsberger et al.	8,734,285 B2	5/2014	Wilton et al.
8,231,495 B2	7/2012	Gumpoltsberger et al.	8,734,286 B2	5/2014	Coffey et al.
8,231,496 B2	7/2012	Gumpoltsberger et al.	8,758,187 B2	6/2014	Mellet et al.
8,231,501 B2	7/2012	Gumpoltsberger et al.	8,758,189 B2	6/2014	Hart et al.
8,241,170 B2	8/2012	Gumpoltsberger et al.	8,777,797 B2	7/2014	Mellet et al.
8,241,171 B2	8/2012	Gumpoltsberger et al.	8,777,798 B2 *	7/2014	Borgerson ..... F16H 3/66 475/275
8,246,504 B2	8/2012	Gumpoltsberger et al.	8,801,563 B2	8/2014	Ohnemus et al.
8,251,856 B2	8/2012	Phillips et al.	8,801,565 B2	8/2014	Hart et al.
8,251,857 B1	8/2012	Mellet et al.	8,821,336 B2	9/2014	Wilton et al.
8,251,859 B2	8/2012	Gumpoltsberger et al.	8,858,387 B2	10/2014	Haupt et al.
8,277,355 B2	10/2012	Hart et al.	8,864,618 B1	10/2014	Noh et al.
8,287,420 B2	10/2012	Gumpoltsberger et al.			

(56)

References Cited

U.S. PATENT DOCUMENTS

8,888,648 B2	11/2014	Mellet et al.	2010/0331136 A1	12/2010	Jang et al.
8,894,535 B2	11/2014	Mellet et al.	2011/0009229 A1	1/2011	Bauknecht et al.
8,915,819 B2	12/2014	Coffey et al.	2011/0045936 A1	2/2011	Gumpoltsberger et al.
8,920,281 B2	12/2014	Mellet et al.	2011/0045937 A1	2/2011	Gumpoltsberger et al.
8,939,863 B2	1/2015	Hart et al.	2011/0045938 A1	2/2011	Gumpoltsberger et al.
8,951,160 B2	2/2015	Vernon et al.	2011/0045939 A1	2/2011	Gumpoltsberger et al.
8,961,355 B2	2/2015	Hart et al.	2011/0045940 A1	2/2011	Gumpoltsberger et al.
8,961,356 B2	2/2015	Bockenstette et al.	2011/0045942 A1	2/2011	Gumpoltsberger et al.
8,968,142 B2	3/2015	Lippert	2011/0045943 A1	2/2011	Gumpoltsberger et al.
8,968,144 B2	3/2015	Janson et al.	2011/0124462 A1	5/2011	Meyer et al.
9,664,259 B1 *	5/2017	Kook ..... F16H 3/66	2011/0136615 A1	6/2011	Phillips et al.
2006/0205556 A1	9/2006	Klemen	2011/0183807 A1	7/2011	Gumpoltsberger et al.
2006/0223666 A1	10/2006	Gumpoltsberger	2011/0212806 A1	9/2011	Phillips et al.
2007/0207891 A1	9/2007	Gumpoltsberger	2011/0245013 A1	10/2011	Kim
2007/0213168 A1	9/2007	Gumpoltsberger	2011/0245026 A1	10/2011	Phillips et al.
2008/0070740 A1	3/2008	Gumpoltsberger	2011/0251014 A1	10/2011	Leesch et al.
2008/0125269 A1	5/2008	Gumpoltsberger	2011/0275472 A1	11/2011	Phillips et al.
2008/0300092 A1	12/2008	Phillips et al.	2011/0294617 A1	12/2011	Seo et al.
2009/0011891 A1	1/2009	Phillips et al.	2012/0004066 A1	1/2012	Seo et al.
2009/0017964 A1	1/2009	Phillips et al.	2012/0053004 A1	3/2012	Beck et al.
2009/0017965 A1	1/2009	Phillips et al.	2012/0053005 A1	3/2012	Beck et al.
2009/0017966 A1	1/2009	Phillips et al.	2012/0053008 A1	3/2012	Beck et al.
2009/0017971 A1	1/2009	Phillips et al.	2012/0058856 A1	3/2012	Phillips et al.
2009/0017976 A1	1/2009	Phillips et al.	2012/0065019 A1	3/2012	Hart et al.
2009/0017977 A1	1/2009	Phillips et al.	2012/0108382 A1	5/2012	Saitoh et al.
2009/0017979 A1	1/2009	Phillips et al.	2012/0108383 A1	5/2012	Saitoh et al.
2009/0017980 A1	1/2009	Phillips et al.	2012/0115671 A1	5/2012	Gumpoltsberger et al.
2009/0036253 A1	2/2009	Phillips et al.	2012/0115672 A1	5/2012	Gumpoltsberger et al.
2009/0048059 A1	2/2009	Phillips et al.	2012/0122626 A1	5/2012	Gumpoltsberger et al.
2009/0048062 A1	2/2009	Seo et al.	2012/0122627 A1	5/2012	Gumpoltsberger et al.
2009/0054196 A1	2/2009	Phillips et al.	2012/0135834 A1	5/2012	Gumpoltsberger et al.
2009/0118059 A1	5/2009	Phillips et al.	2012/0135835 A1	5/2012	Gumpoltsberger et al.
2009/0118062 A1	5/2009	Phillips et al.	2012/0149525 A1	6/2012	Gumpoltsberger et al.
2009/0124448 A1	5/2009	Wittkopp et al.	2012/0149526 A1	6/2012	Gumpoltsberger et al.
2009/0192009 A1	7/2009	Phillips et al.	2012/0149527 A1	6/2012	Gumpoltsberger et al.
2009/0192010 A1	7/2009	Wittkopp et al.	2012/0172172 A1	7/2012	Gumpoltsberger et al.
2009/0192011 A1	7/2009	Phillips et al.	2012/0178564 A1	7/2012	Vahabzadeh et al.
2009/0192012 A1	7/2009	Phillips et al.	2012/0178572 A1	7/2012	Hart
2009/0197733 A1	8/2009	Phillips et al.	2012/0178579 A1	7/2012	Wittkopp et al.
2009/0197734 A1	8/2009	Phillips et al.	2012/0178580 A1	7/2012	Wittkopp et al.
2009/0209387 A1	8/2009	Phillips et al.	2012/0178581 A1	7/2012	Wittkopp et al.
2009/0209389 A1	8/2009	Phillips et al.	2012/0178582 A1	7/2012	Wittkopp et al.
2009/0215580 A1	8/2009	Hart et al.	2012/0196718 A1	8/2012	Hart et al.
2009/0280947 A1	11/2009	Seo et al.	2012/0214632 A1	8/2012	Mellet et al.
2010/0041508 A1	2/2010	Gumpoltsberger et al.	2012/0214633 A1	8/2012	Mellet et al.
2010/0041509 A1	2/2010	Gumpoltsberger et al.	2012/0214636 A1	8/2012	Hart et al.
2010/0069195 A1	3/2010	Baldwin	2012/0214637 A1	8/2012	Hart et al.
2010/0190600 A1	7/2010	Phillips et al.	2012/0214638 A1	8/2012	Hart et al.
2010/0210392 A1	8/2010	Hart et al.	2012/0231917 A1	9/2012	Phillips et al.
2010/0210393 A1	8/2010	Phillips et al.	2012/0231920 A1	9/2012	Wittkopp et al.
2010/0210394 A1	8/2010	Phillips et al.	2012/0295754 A1	11/2012	Hart et al.
2010/0210395 A1	8/2010	Phillips et al.	2012/0329600 A1	12/2012	Park et al.
2010/0210396 A1	8/2010	Wittkopp et al.	2013/0029799 A1	1/2013	Park et al.
2010/0210397 A1	8/2010	Wittkopp et al.	2013/0040776 A1	2/2013	Mellet et al.
2010/0210398 A1	8/2010	Hart et al.	2013/0085031 A1	4/2013	Bassi et al.
2010/0210400 A1	8/2010	Phillips et al.	2013/0085032 A1	4/2013	Mellet et al.
2010/0210401 A1	8/2010	Phillips et al.	2013/0085033 A1	4/2013	Wittkopp et al.
2010/0210402 A1	8/2010	Phillips et al.	2013/0150203 A1	6/2013	Park et al.
2010/0210403 A1	8/2010	Wittkopp et al.	2013/0150204 A1	6/2013	Park et al.
2010/0210404 A1	8/2010	Phillips et al.	2013/0187796 A1	7/2013	Kim et al.
2010/0210405 A1	8/2010	Phillips et al.	2013/0203549 A1	8/2013	Mellet et al.
2010/0210406 A1	8/2010	Phillips et al.	2013/0237365 A1	9/2013	Coffey et al.
2010/0216589 A1	8/2010	Hart et al.	2013/0252780 A1	9/2013	Ohnemus et al.
2010/0216590 A1	8/2010	Phillips et al.	2013/0310211 A1	11/2013	Wilton et al.
2010/0216591 A1	8/2010	Wittkopp et al.	2016/0356345 A1	12/2016	Ji et al.
2010/0227729 A1	9/2010	Wittkopp et al.	2016/0363188 A1	12/2016	Kook et al.
2010/0279814 A1	11/2010	Brehmer et al.	2017/0074363 A1	3/2017	Park et al.
			2017/0074368 A1	3/2017	Park et al.
			2017/0074370 A1	3/2017	Kwon et al.

\* cited by examiner

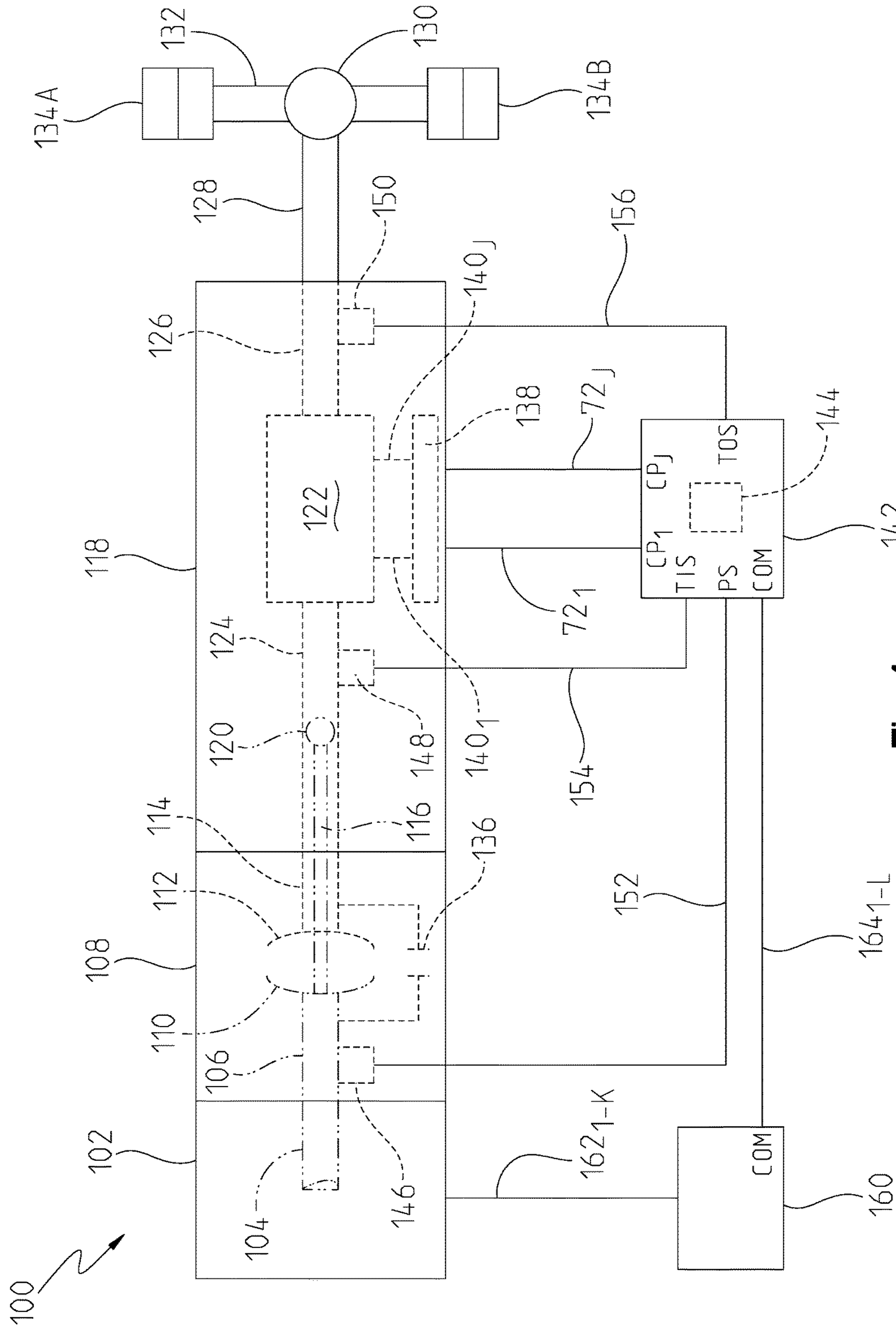

Fig. 1

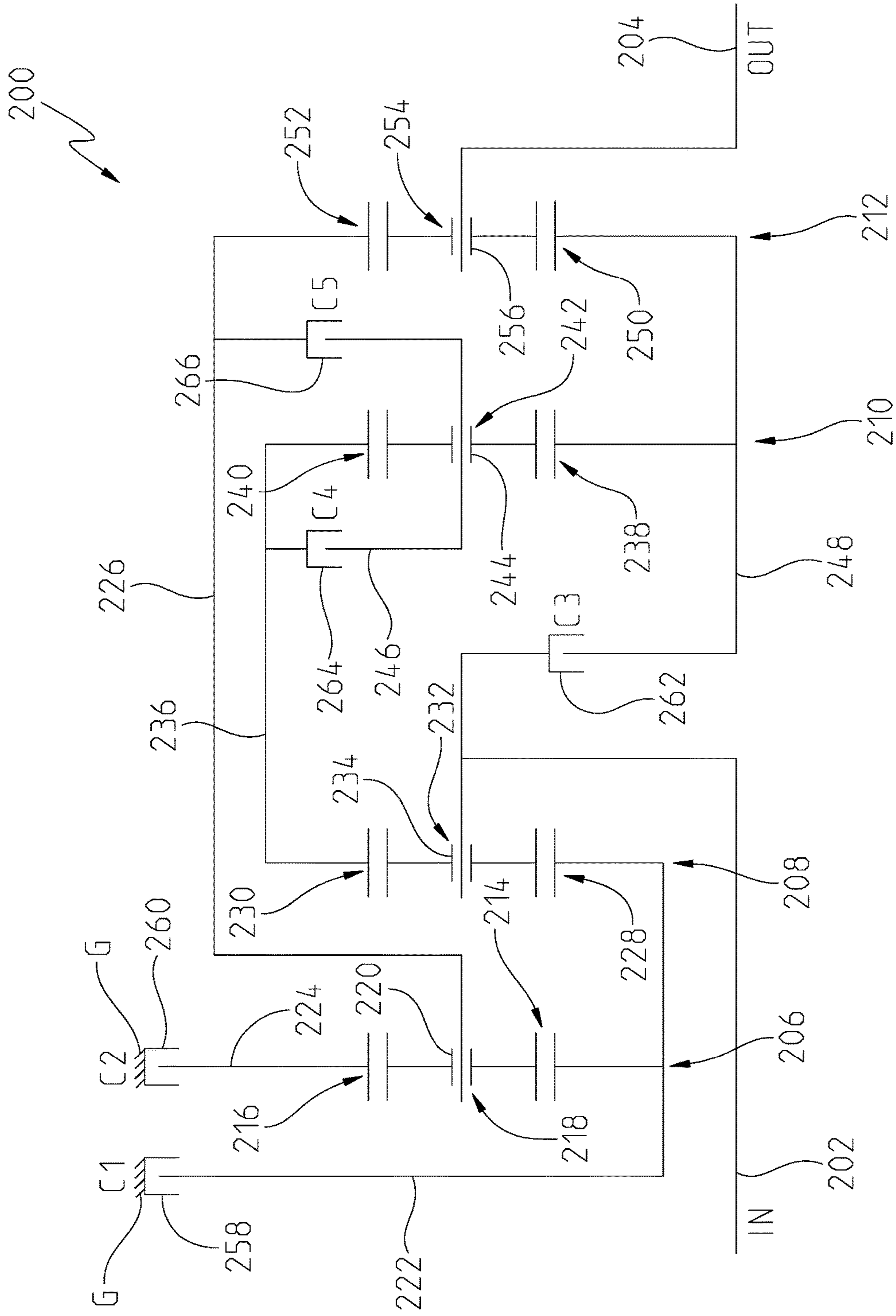

Fig. 2

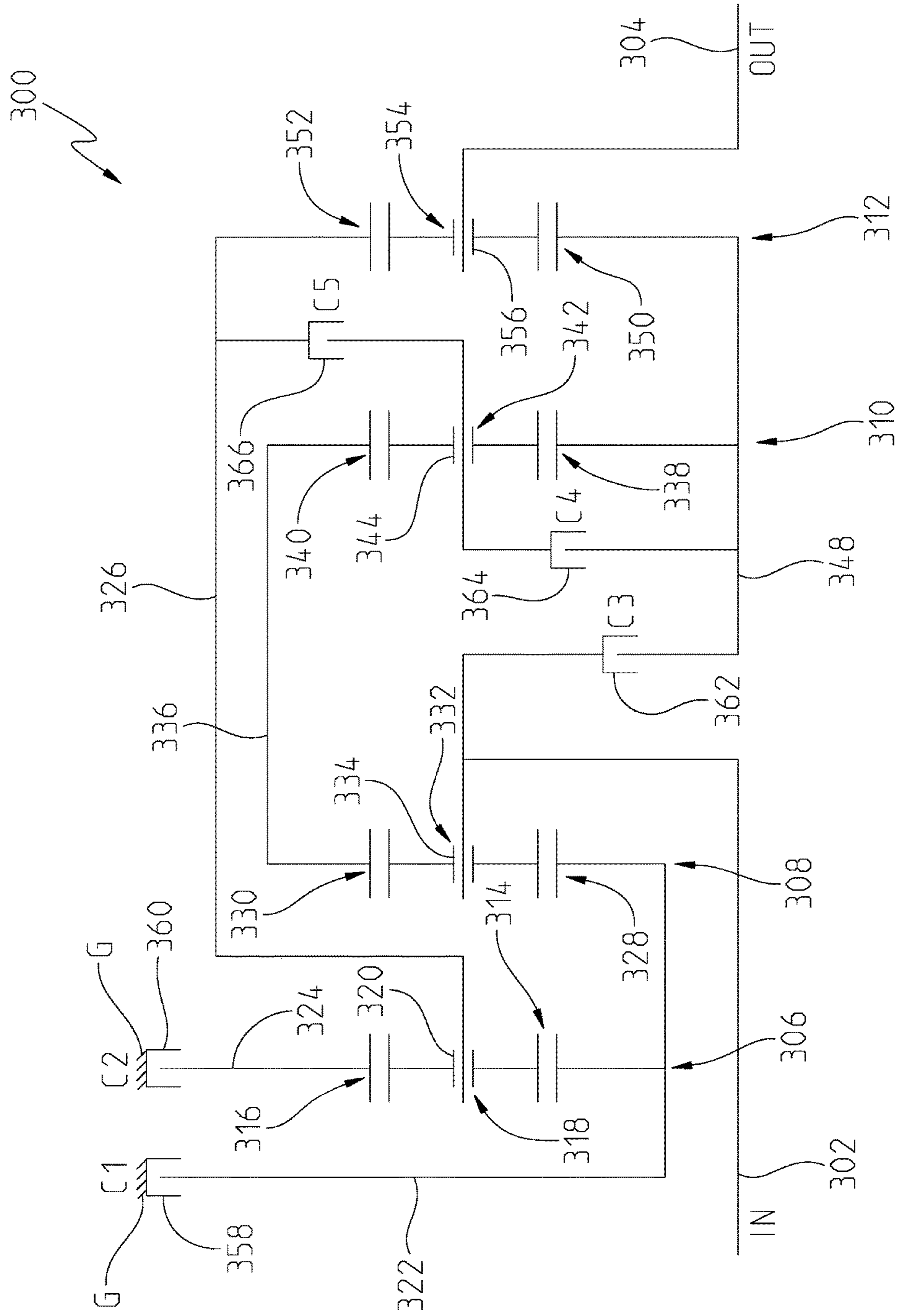

Fig. 3

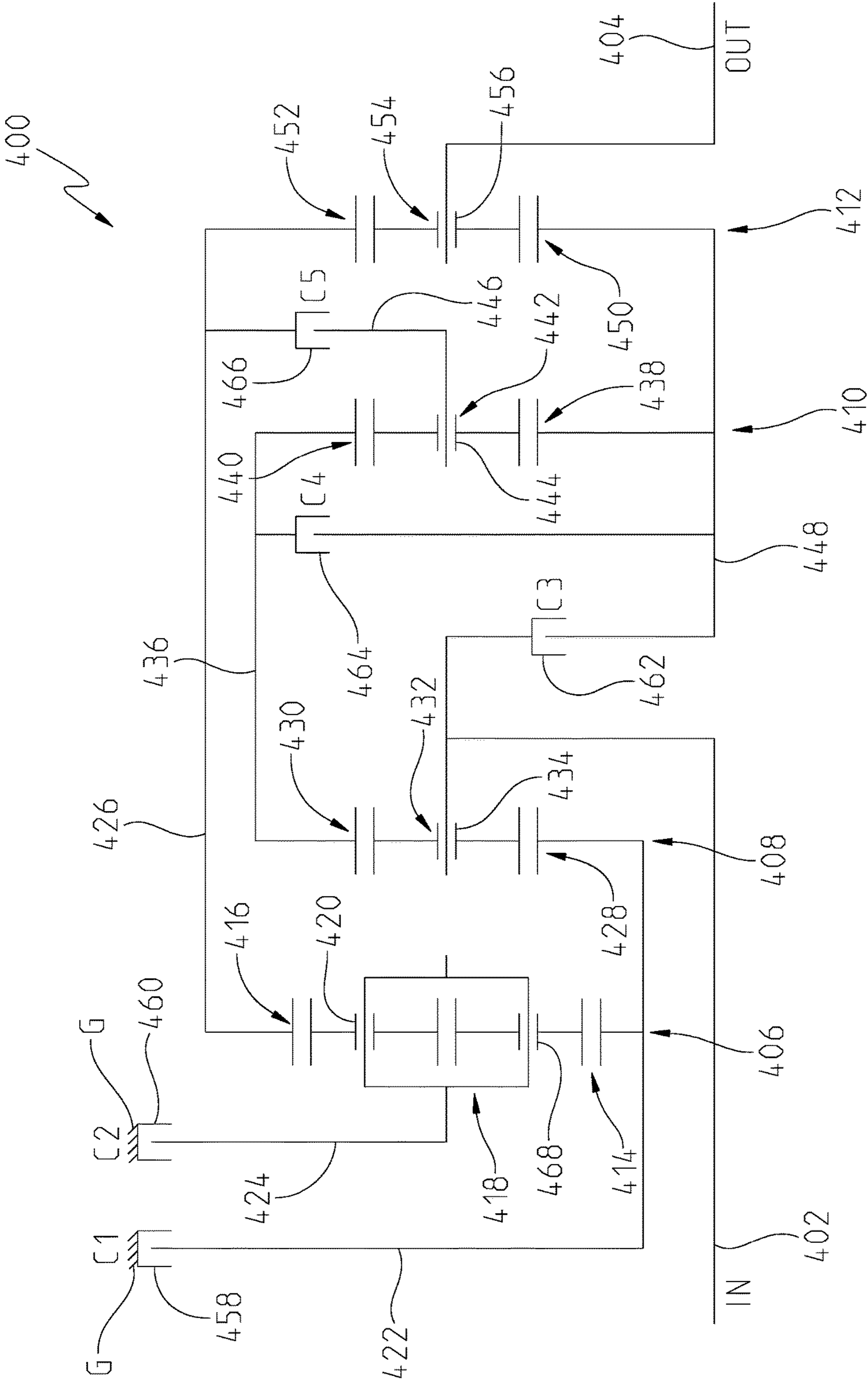

Fig. 4

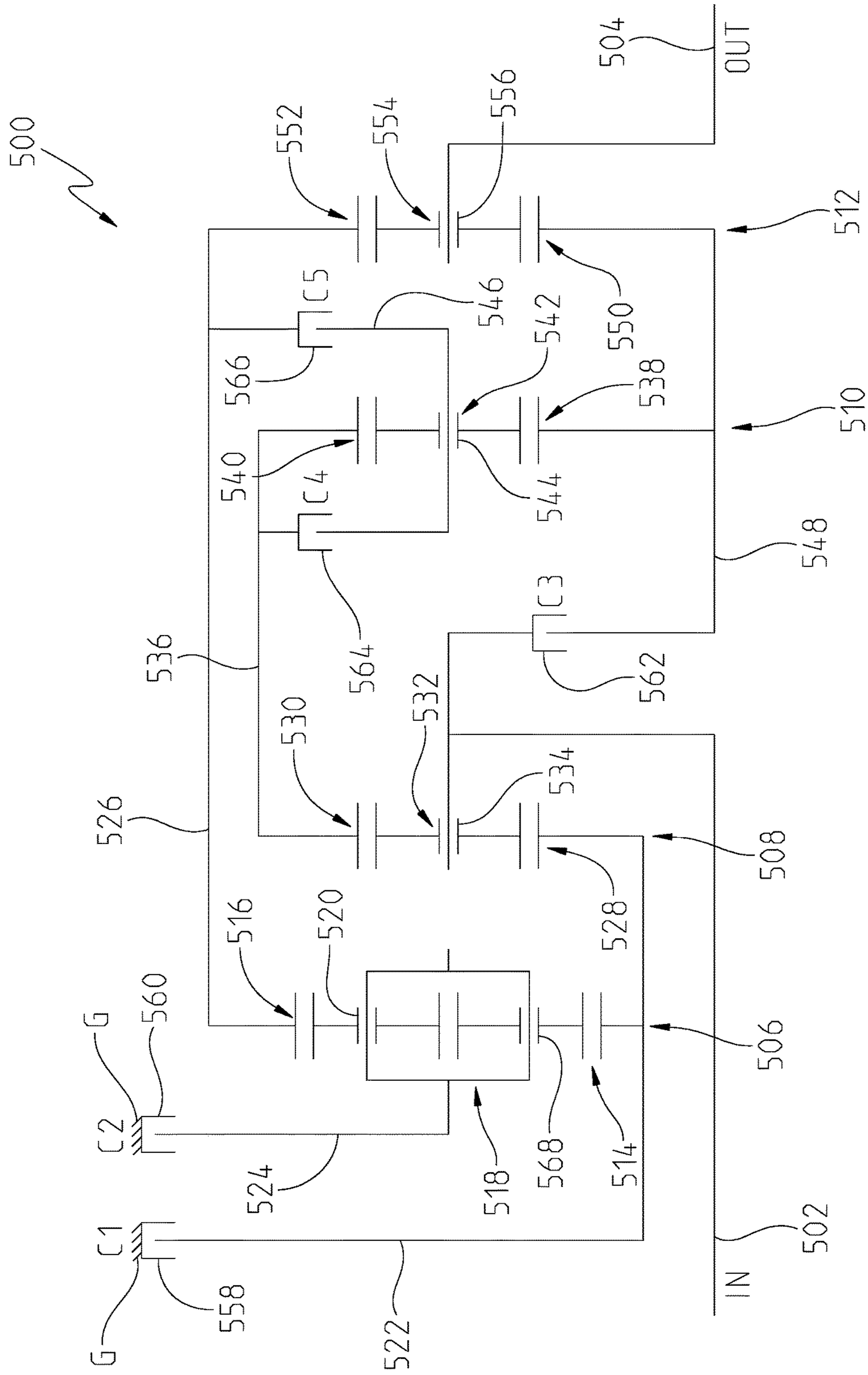

Fig. 5



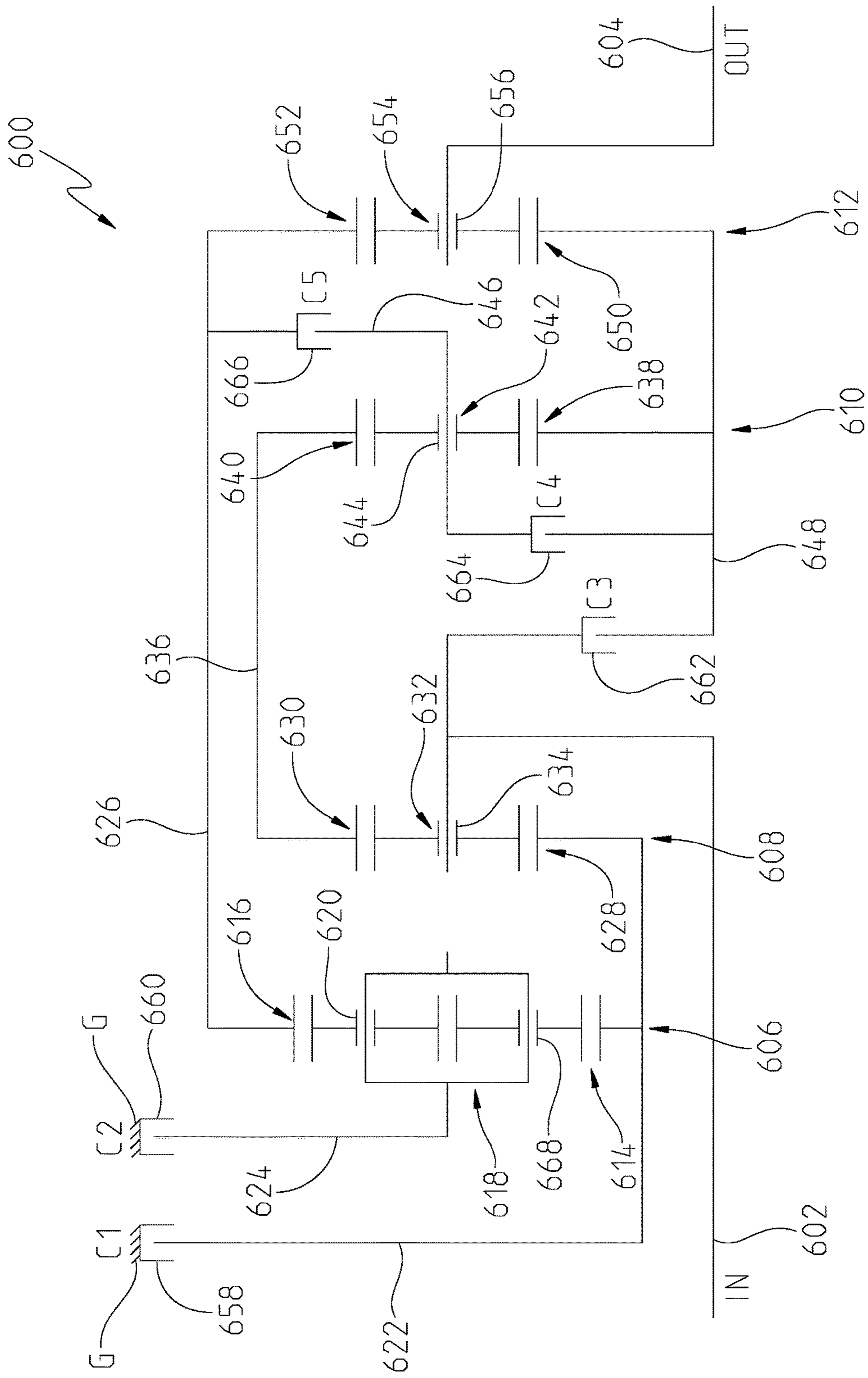

Fig. 6

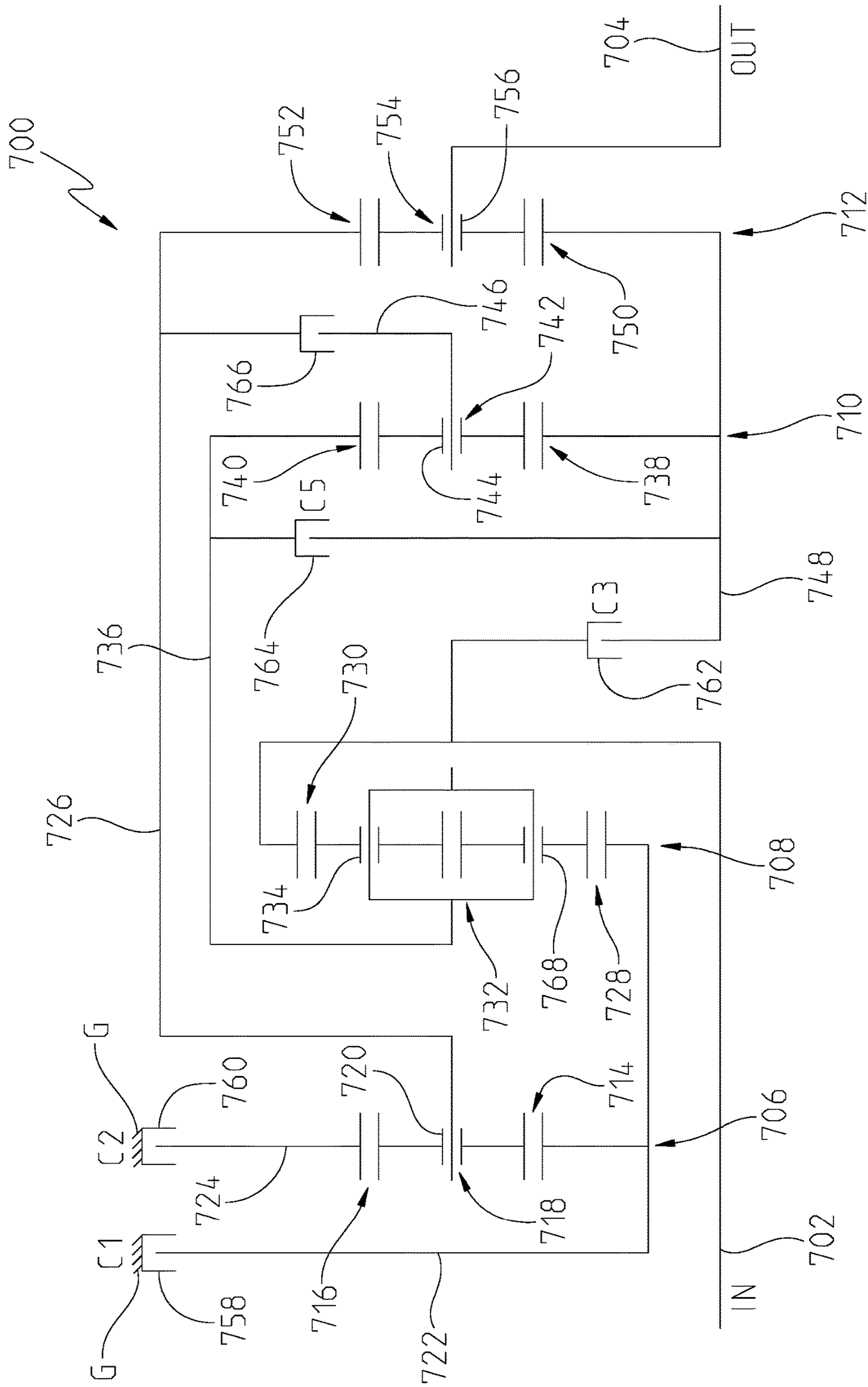

Fig. 7

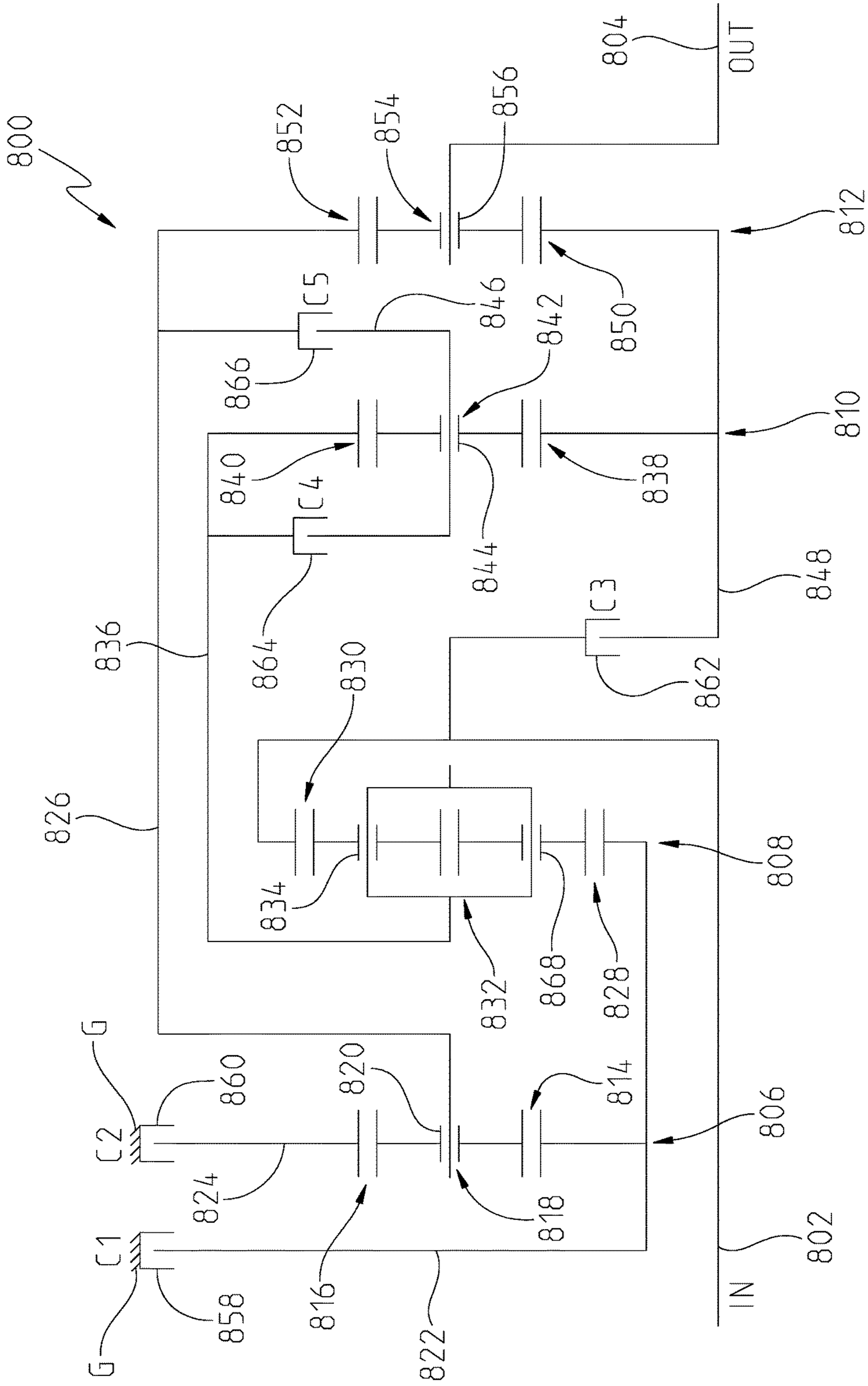

Fig. 8

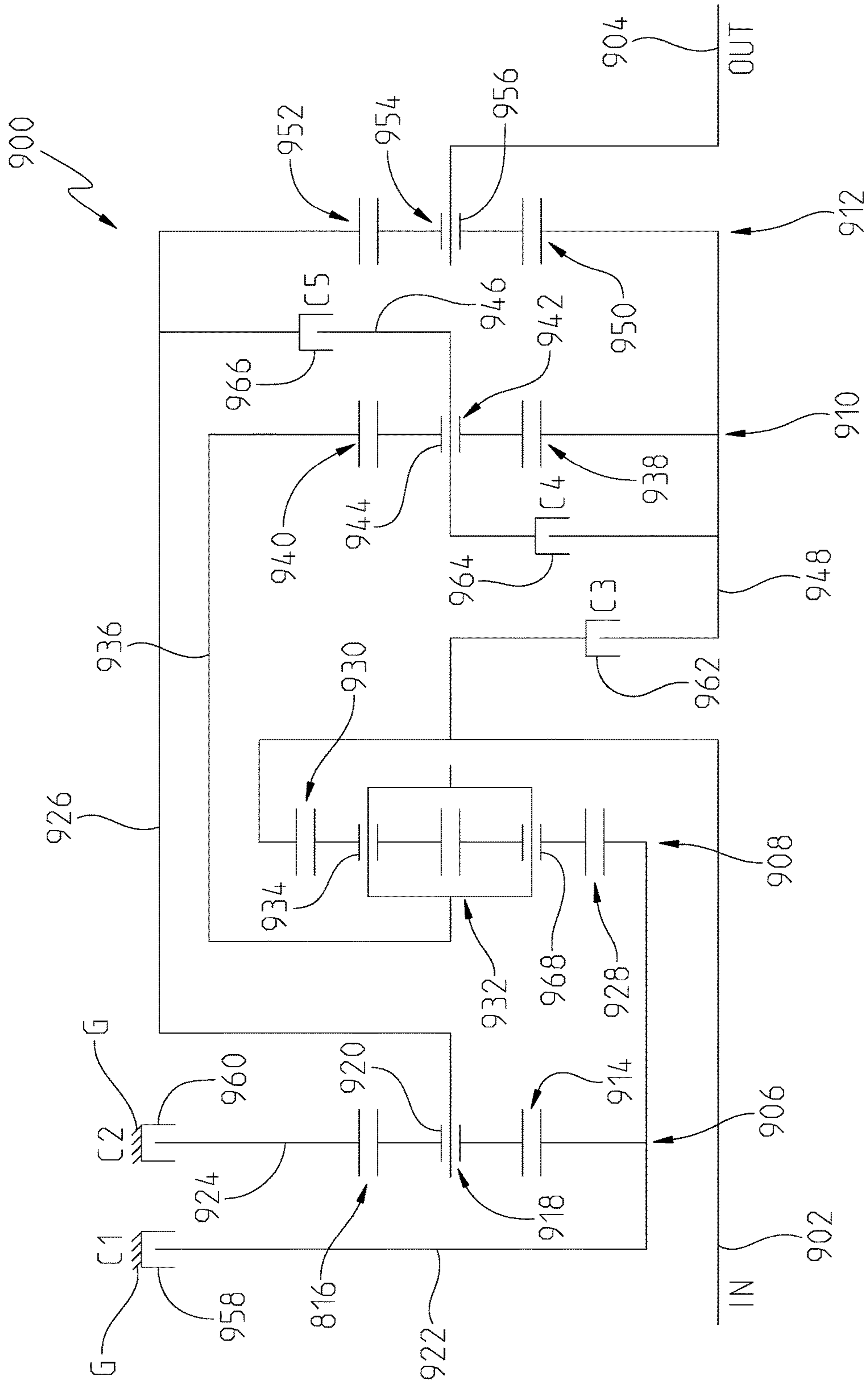

Fig. 9

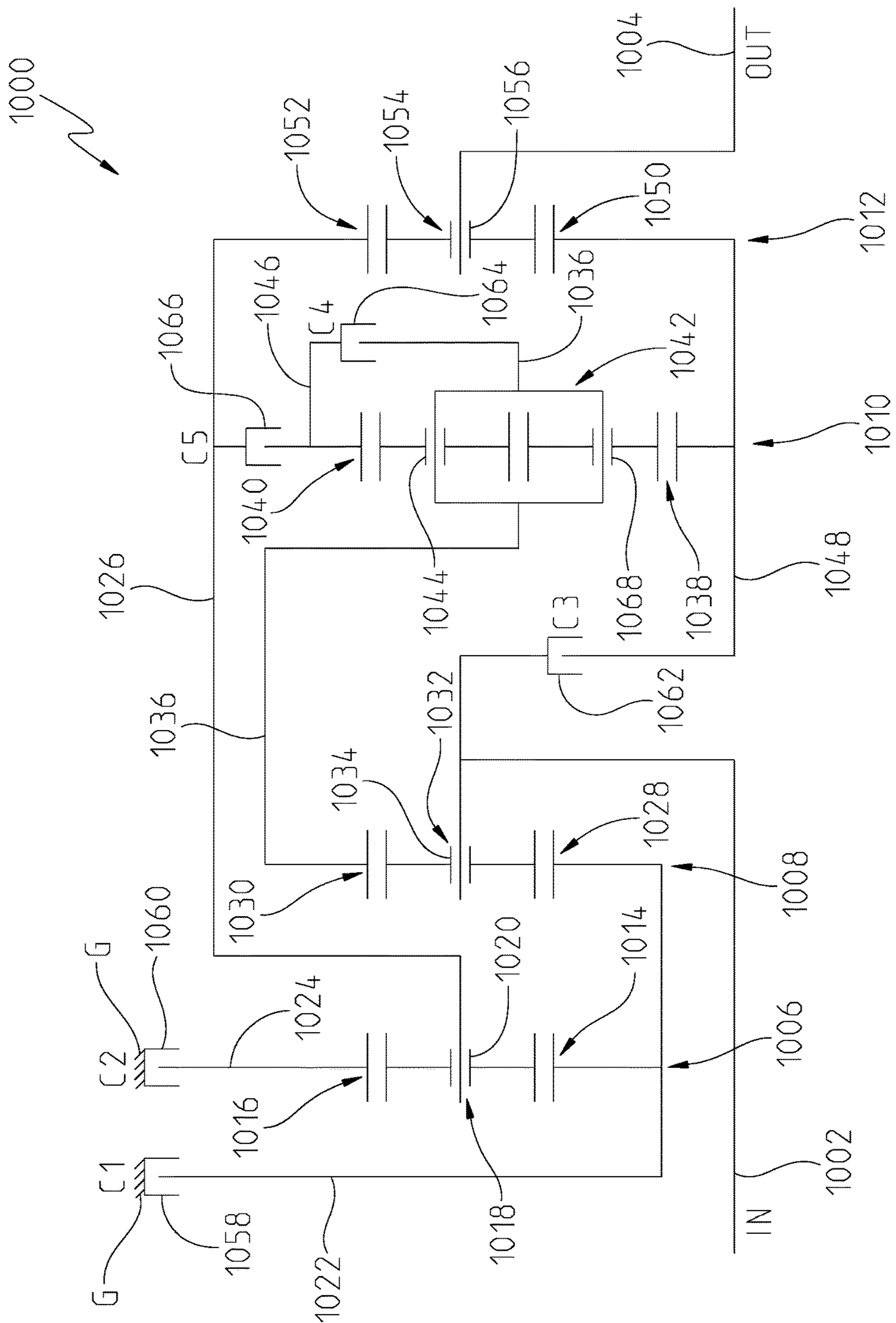

Fig. 10

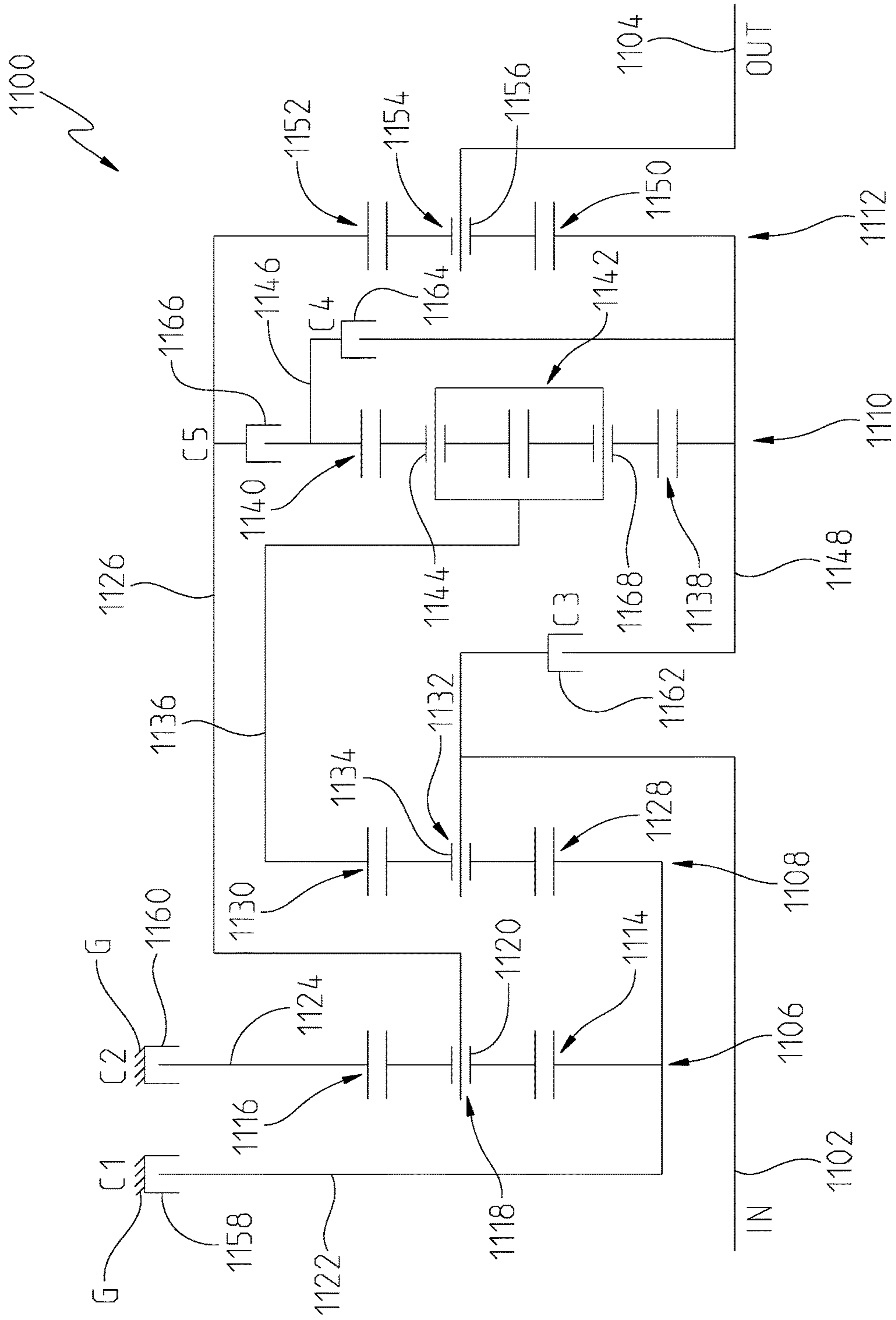
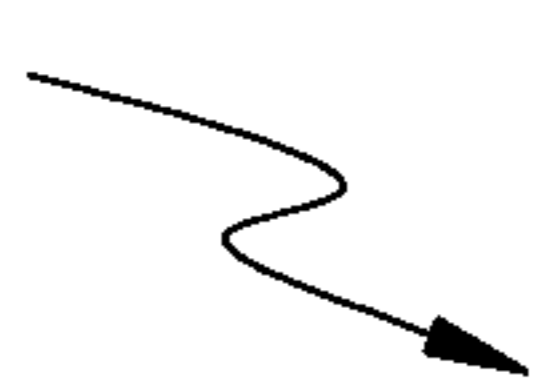

Fig. 11

1200 

	B1	B2	C3	C4	C5
1st	X	X	X		
2nd	X	X		X	
3rd		X	X	X	
4th		X		X	X
5th		X	X		X
6th			X	X	X
7th	X		X		X
8th	X			X	X
Rev	X	X			X

Fig. 12

**MULTI-SPEED TRANSMISSION**

## RELATED DISCLOSURES

This application is a divisional application of U.S. patent application Ser. No. 15/498,770, filed Apr. 27, 2017, which is a divisional application of U.S. patent application Ser. No. 14/695,143, filed Apr. 24, 2015, now U.S. Pat. No. 9,689,467, both of which are hereby incorporated by reference in their entirety.

## FIELD OF THE DISCLOSURE

The present disclosure relates to a multiple speed transmission, and in particular to a multiple speed transmission capable of achieving eight or more speeds.

## BACKGROUND

Multiple speed transmissions use a number of friction clutches or brakes, planetary gearsets, shafts, and other elements to achieve a plurality of gear or speed ratios. The architecture, i.e., packaging or layout of the aforementioned elements, is determined based on cost, size, packaging constraints, and desired ratios. There is a need for new architectural designs of multiple speed transmissions for achieving different ratios with improved performance, cost, efficiency, responsiveness, and packaging.

## SUMMARY

In a first embodiment of the present disclosure, a multiple speed transmission includes an input member; an output member; first, second, third and fourth planetary gearsets each having first, second and third members; a plurality of interconnecting members each connected between at least one of the first, second, third, and fourth planetary gearsets and at least another of the first, second, third, and fourth planetary gearsets; a first torque-transmitting mechanism selectively engageable to interconnect the first member of the first planetary gearset and the first member of the second planetary gearset with a stationary member; a second torque-transmitting mechanism selectively engageable to interconnect the third member of the first planetary gearset with the stationary member; a third torque-transmitting mechanism selectively engageable to interconnect the second member of the second planetary gearset with the first member of the fourth planetary gearset and the first member of the third planetary gearset; a fourth torque-transmitting mechanism selectively engageable to interconnect the third member of the second planetary gearset and the third member of the third planetary gearset with the second member of the third planetary gearset; and a fifth torque-transmitting mechanism selectively engageable to interconnect the second member of the first planetary gearset with the second member of the third planetary gearset; wherein the torque transmitting mechanisms are selectively engageable in combinations of at least three to establish at least eight forward speed ratios and at least one reverse speed ratio between the input member and the output member.

In a second embodiment, a multiple speed transmission includes an input member; an output member; first, second, third and fourth planetary gearsets each having first, second and third members; a plurality of interconnecting members each connected between at least one of the first, second, third, and fourth planetary gearsets and at least another of the first, second, third, and fourth planetary gearsets; a first

torque-transmitting mechanism selectively engageable to interconnect the first member of the first planetary gearset and the first member of the second planetary gearset with a stationary member; a second torque-transmitting mechanism selectively engageable to interconnect the third member of the first planetary gearset with the stationary member; a third torque-transmitting mechanism selectively engageable to interconnect the second member of the second planetary gearset with the first member of the fourth planetary gearset and the first member of the third planetary gearset; a fourth torque-transmitting mechanism selectively engageable to interconnect the second member of the third planetary gearset with the first member of the third planetary gearset and the first member of the fourth planetary gearset; and a fifth torque-transmitting mechanism selectively engageable to interconnect the second member of the first planetary gearset and the third member of the fourth planetary gearset with the second member of the third planetary gearset; wherein the torque transmitting mechanisms are selectively engageable in combinations of at least three to establish at least eight forward speed ratios and at least one reverse speed ratio between the input member and the output member.

In a third embodiment of the present disclosure, a multiple speed transmission includes an input member; an output member; first, second, third and fourth planetary gearsets each having first, second and third members; a plurality of interconnecting members each connected between at least one of the first, second, third, and fourth planetary gearsets and at least another of the first, second, third, and fourth planetary gearsets; a first torque-transmitting mechanism selectively engageable to interconnect the first member of the first planetary gearset and the first member of the second planetary gearset with a stationary member; a second torque-transmitting mechanism selectively engageable to interconnect the second member of the first planetary gearset with the stationary member; a third torque-transmitting mechanism selectively engageable to interconnect the second member of the second planetary gearset with the first member of the third planetary gearset and the first member of the fourth planetary gearset; a fourth torque-transmitting mechanism selectively engageable to interconnect the third member of the second planetary gearset and the third member of the third planetary gearset with the first member of the fourth planetary gearset; and a fifth torque-transmitting mechanism selectively engageable to interconnect the third member of the first planetary gearset and the third member of the fourth planetary gearset with the second member of the third planetary gearset; wherein the torque transmitting mechanisms are selectively engageable in combinations of at least three to establish at least eight forward speed ratios and at least one reverse speed ratio between the input member and the output member.

In a fourth embodiment, a multiple speed transmission includes an input member; an output member; first, second, third and fourth planetary gearsets each having first, second and third members; a plurality of interconnecting members each connected between at least one of the first, second, third, and fourth planetary gearsets and at least another of the first, second, third, and fourth planetary gearsets; a first torque-transmitting mechanism selectively engageable to interconnect the first member of the first planetary gearset and the first member of the second planetary gearset with a stationary member; a second torque-transmitting mechanism selectively engageable to interconnect the second member of the first planetary gearset with the stationary member; a third





## 5

least eight forward speed ratios and at least one reverse speed ratio between the input member and the output member.

In a ninth embodiment, a multiple speed transmission includes an input member; an output member; first, second, third and fourth planetary gearsets each having first, second and third members; a plurality of interconnecting members each connected between at least one of the first, second, third, and fourth planetary gearsets and at least another of the first, second, third, and fourth planetary gearsets; a first torque-transmitting mechanism selectively engageable to interconnect the first member of the first planetary gearset and the first member of the second planetary gearset with a stationary member; a second torque-transmitting mechanism selectively engageable to interconnect the third member of the first planetary gearset with the stationary member; a third torque-transmitting mechanism selectively engageable to interconnect the second member of the second planetary gearset with the first member of the third planetary gearset and the first member of the fourth planetary gearset; a fourth torque-transmitting mechanism selectively engageable to interconnect the second member of the third planetary gearset with the third member of the third planetary gearset; and a fifth torque-transmitting mechanism selectively engageable to interconnect the second member of the first planetary gearset and the third member of the fourth planetary gearset with the third member of the third planetary gearset; wherein the torque transmitting mechanisms are selectively engageable in combinations of at least three to establish at least eight forward speed ratios and at least one reverse speed ratio between the input member and the output member.

In a tenth embodiment of the present disclosure, a multiple speed transmission includes an input member; an output member; first, second, third and fourth planetary gearsets each having first, second and third members; a plurality of interconnecting members each connected between at least one of the first, second, third, and fourth planetary gearsets and at least another of the first, second, third, and fourth planetary gearsets; a first torque-transmitting mechanism selectively engageable to interconnect the first member of the first planetary gearset and the first member of the second planetary gearset with a stationary member; a second torque-transmitting mechanism selectively engageable to interconnect the third member of the first planetary gearset with the stationary member; a third torque-transmitting mechanism selectively engageable to interconnect the second member of the second planetary gearset with the first member of the third planetary gearset and the first member of the fourth planetary gearset; a fourth torque-transmitting mechanism selectively engageable to interconnect the third member of the third planetary gearset with the first member of the third planetary gearset and the first member of the fourth planetary gearset; and a fifth torque-transmitting mechanism selectively engageable to interconnect the second member of the first planetary gearset and the third member of the fourth planetary gearset with the third member of the third planetary gearset; wherein the torque transmitting mechanisms are selectively engageable in combinations of at least three to establish at least eight forward speed ratios and at least one reverse speed ratio between the input member and the output member.

In one or more examples of the embodiments described herein, when shifting from one forward speed ratio of a multiple speed transmission into one of a successive higher and a successive lower forward speed ratio causes a single one of the first, the second, the third, the fourth, and the fifth

## 6

torque transmitting mechanisms to disengage and a single one of the first, the second, the third, the fourth, and the fifth torque transmitting mechanisms to engage. In another example, the first member of each planetary gearset is a sun gear, the second member of each planetary gearset is a carrier member, and the third member of each planetary gearset is a ring gear.

## BRIEF DESCRIPTION OF THE DRAWINGS

The above-mentioned aspects of the present disclosure and the manner of obtaining them will become more apparent and the disclosure itself will be better understood by reference to the following description of the embodiments of the disclosure, taken in conjunction with the accompanying drawings, wherein:

FIG. 1 is an exemplary block diagram and schematic view of one illustrative embodiment of a powered vehicular system;

FIG. 2 is a diagrammatic view of a first embodiment of a multiple speed transmission;

FIG. 3 is a diagrammatic view of a second embodiment of a multiple speed transmission;

FIG. 4 is a diagrammatic view of a third embodiment of a multiple speed transmission;

FIG. 5 is a diagrammatic view of a fourth embodiment of a multiple speed transmission;

FIG. 6 is a diagrammatic view of a fifth embodiment of a multiple speed transmission;

FIG. 7 is a diagrammatic view of a sixth embodiment of a multiple speed transmission;

FIG. 8 is a diagrammatic view of a seventh embodiment of a multiple speed transmission;

FIG. 9 is a diagrammatic view of an eighth embodiment of a multiple speed transmission;

FIG. 10 is a diagrammatic view of a ninth embodiment of a multiple speed transmission;

FIG. 11 is a diagrammatic view of a tenth embodiment of a multiple speed transmission; and

FIG. 12 is a truth table presenting an example of a state of engagement of various torque transmitting mechanisms in each of the available forward and reverse speeds or gear ratios of the transmissions illustrated in FIGS. 2-11.

Corresponding reference numerals are used to indicate corresponding parts throughout the several views.

## DETAILED DESCRIPTION

The embodiments of the present disclosure described below are not intended to be exhaustive or to limit the disclosure to the precise forms disclosed in the following detailed description. Rather, the embodiments are chosen and described so that others skilled in the art may appreciate and understand the principles and practices of the present disclosure.

Referring now to FIG. 1, a block diagram and schematic view of one illustrative embodiment of a vehicular system 100 having a drive unit 102 and transmission 118 is shown. In the illustrated embodiment, the drive unit 102 may include an internal combustion engine, diesel engine, electric motor, or other power-generating device. The drive unit 102 is configured to rotatably drive an output shaft 104 that is coupled to an input or pump shaft 106 of a conventional torque converter 108. The input or pump shaft 106 is coupled to an impeller or pump 110 that is rotatably driven by the output shaft 104 of the drive unit 102. The torque converter 108 further includes a turbine 112 that is coupled

to a turbine shaft **114**, and the turbine shaft **114** is coupled to, or integral with, a rotatable input shaft **124** of the transmission **118**. The transmission **118** can also include an internal pump **120** for building pressure within different flow circuits (e.g., main circuit, lube circuit, etc.) of the transmission **118**. The pump **120** can be driven by a shaft **116** that is coupled to the output shaft **104** of the drive unit **102**. In this arrangement, the drive unit **102** can deliver torque to the shaft **116** for driving the pump **120** and building pressure within the different circuits of the transmission **118**.

The transmission **118** can include a planetary gear system **122** having a number of automatically selected gears. An output shaft **126** of the transmission **118** is coupled to or integral with, and rotatably drives, a propeller shaft **128** that is coupled to a conventional universal joint **130**. The universal joint **130** is coupled to, and rotatably drives, an axle **132** having wheels **134A** and **134B** mounted thereto at each end. The output shaft **126** of the transmission **118** drives the wheels **134A** and **134B** in a conventional manner via the propeller shaft **128**, universal joint **130** and axle **132**.

A conventional lockup clutch **136** is connected between the pump **110** and the turbine **112** of the torque converter **108**. The operation of the torque converter **108** is conventional in that the torque converter **108** is operable in a so-called "torque converter" mode during certain operating conditions such as vehicle launch, low speed and certain gear shifting conditions. In the torque converter mode, the lockup clutch **136** is disengaged and the pump **110** rotates at the rotational speed of the drive unit output shaft **104** while the turbine **112** is rotatably actuated by the pump **110** through a fluid (not shown) interposed between the pump **110** and the turbine **112**. In this operational mode, torque multiplication occurs through the fluid coupling such that the turbine shaft **114** is exposed to drive more torque than is being supplied by the drive unit **102**, as is known in the art. The torque converter **108** is alternatively operable in a so-called "lockup" mode during other operating conditions, such as when certain gears of the planetary gear system **122** of the transmission **118** are engaged. In the lockup mode, the lockup clutch **136** is engaged and the pump **110** is thereby secured directly to the turbine **112** so that the drive unit output shaft **104** is directly coupled to the input shaft **124** of the transmission **118**, as is also known in the art.

The transmission **118** further includes an electro-hydraulic system **138** that is fluidly coupled to the planetary gear system **122** via a number,  $J$ , of fluid paths,  $140_1-140_J$ , where  $J$  may be any positive integer. The electro-hydraulic system **138** is responsive to control signals to selectively cause fluid to flow through one or more of the fluid paths,  $140_1-140_J$ , to thereby control operation, i.e., engagement and disengagement, of a plurality of corresponding friction devices in the planetary gear system **122**. The plurality of friction devices may include, but are not limited to, one or more conventional brake devices, one or more torque transmitting devices, and the like. Generally, the operation, i.e., engagement and disengagement, of the plurality of friction devices is controlled by selectively controlling the friction applied by each of the plurality of friction devices, such as by controlling fluid pressure to each of the friction devices. In one example embodiment, which is not intended to be limiting in any way, the plurality of friction devices include a plurality of brake and torque transmitting devices in the form of conventional clutches that may each be controllably engaged and disengaged via fluid pressure supplied by the electro-hydraulic system **138**. In any case, changing or shifting between the various gears of the transmission **118** is accomplished in a conventional manner by selectively con-

trolling the plurality of friction devices via control of fluid pressure within the number of fluid paths  $140_1-140_J$ .

The system **100** further includes a transmission control circuit **142** that can include a memory unit **144**. The transmission control circuit **142** is illustratively microprocessor-based, and the memory unit **144** generally includes instructions stored therein that are executable by a processor of the transmission control circuit **142** to control operation of the torque converter **108** and operation of the transmission **118**, i.e., shifting between the various gears of the planetary gear system **122**. It will be understood, however, that this disclosure contemplates other embodiments in which the transmission control circuit **142** is not microprocessor-based, but is configured to control operation of the torque converter **108** and/or transmission **118** based on one or more sets of hardwired instructions and/or software instructions stored in the memory unit **144**.

In the system **100** illustrated in FIG. 1, the torque converter **108** and the transmission **118** include a number of sensors configured to produce sensor signals that are indicative of one or more operating states of the torque converter **108** and transmission **118**, respectively. For example, the torque converter **108** illustratively includes a conventional speed sensor **146** that is positioned and configured to produce a speed signal corresponding to the rotational speed of the pump shaft **106**, which is the same rotational speed of the output shaft **104** of the drive unit **102**. The speed sensor **146** is electrically connected to a pump speed input, PS, of the transmission control circuit **142** via a signal path **152**, and the transmission control circuit **142** is operable to process the speed signal produced by the speed sensor **146** in a conventional manner to determine the rotational speed of the pump shaft **106**/drive unit output shaft **104**.

The transmission **118** illustratively includes another conventional speed sensor **148** that is positioned and configured to produce a speed signal corresponding to the rotational speed of the transmission input shaft **124**, which is the same rotational speed as the turbine shaft **114**. The input shaft **124** of the transmission **118** is directly coupled to, or integral with, the turbine shaft **114**, and the speed sensor **148** may alternatively be positioned and configured to produce a speed signal corresponding to the rotational speed of the turbine shaft **114**. In any case, the speed sensor **148** is electrically connected to a transmission input shaft speed input, TIS, of the transmission control circuit **142** via a signal path **154**, and the transmission control circuit **142** is operable to process the speed signal produced by the speed sensor **148** in a conventional manner to determine the rotational speed of the turbine shaft **114**/transmission input shaft **124**.

The transmission **118** further includes yet another speed sensor **150** that is positioned and configured to produce a speed signal corresponding to the rotational speed of the output shaft **126** of the transmission **118**. The speed sensor **150** may be conventional, and is electrically connected to a transmission output shaft speed input, TOS, of the transmission control circuit **142** via a signal path **156**. The transmission control circuit **142** is configured to process the speed signal produced by the speed sensor **150** in a conventional manner to determine the rotational speed of the transmission output shaft **126**.

In the illustrated embodiment, the transmission **118** further includes one or more actuators configured to control various operations within the transmission **118**. For example, the electro-hydraulic system **138** described herein illustratively includes a number of actuators, e.g., conventional solenoids or other conventional actuators, that are

electrically connected to a number, J, of control outputs, CP<sub>1</sub>-CP<sub>J</sub>, of the transmission control circuit 142 via a corresponding number of signal paths 72<sub>1</sub>-72<sub>J</sub>, where J may be any positive integer as described above. The actuators within the electro-hydraulic system 138 are each responsive to a corresponding one of the control signals, CP<sub>1</sub>-CP<sub>J</sub>, produced by the transmission control circuit 142 on one of the corresponding signal paths 72<sub>1</sub>-72<sub>J</sub> to control the friction applied by each of the plurality of friction devices by controlling the pressure of fluid within one or more corresponding fluid passageway 140<sub>1</sub>-140<sub>J</sub>, and thus control the operation, i.e., engaging and disengaging, of one or more corresponding friction devices, based on information provided by the various speed sensors 146, 148, and/or 150.

The friction devices of the planetary gear system 122 are illustratively controlled by hydraulic fluid which is distributed by the electro-hydraulic system in a conventional manner. For example, the electro-hydraulic system 138 illustratively includes a conventional hydraulic positive displacement pump (not shown) which distributes fluid to the one or more friction devices via control of the one or more actuators within the electro-hydraulic system 138. In this embodiment, the control signals, CP<sub>1</sub>-CP<sub>J</sub>, are illustratively analog friction device pressure commands to which the one or more actuators are responsive to control the hydraulic pressure to the one or more frictions devices. It will be understood, however, that the friction applied by each of the plurality of friction devices may alternatively be controlled in accordance with other conventional friction device control structures and techniques, and such other conventional friction device control structures and techniques are contemplated by this disclosure. In any case, however, the analog operation of each of the friction devices is controlled by the control circuit 142 in accordance with instructions stored in the memory unit 144.

In the illustrated embodiment, the system 100 further includes a drive unit control circuit 160 having an input/output port (I/O) that is electrically coupled to the drive unit 102 via a number, K, of signal paths 162, wherein K may be any positive integer. The drive unit control circuit 160 may be conventional, and is operable to control and manage the overall operation of the drive unit 102. The drive unit control circuit 160 further includes a communication port, COM, which is electrically connected to a similar communication port, COM, of the transmission control circuit 142 via a number, L, of signal paths 164, wherein L may be any positive integer. The one or more signal paths 164 are typically referred to collectively as a data link. Generally, the drive unit control circuit 160 and the transmission control circuit 142 are operable to share information via the one or more signal paths 164 in a conventional manner. In one embodiment, for example, the drive unit control circuit 160 and transmission control circuit 142 are operable to share information via the one or more signal paths 164 in the form of one or more messages in accordance with a society of automotive engineers (SAE) J-1939 communications protocol, although this disclosure contemplates other embodiments in which the drive unit control circuit 160 and the transmission control circuit 142 are operable to share information via the one or more signal paths 164 in accordance with one or more other conventional communication protocols (e.g., from a conventional databus such as J1587 data bus, J1939 data bus, IESCAN data bus, GMLAN, Mercedes PT-CAN).

Referring to FIG. 2, a schematic representation or stick diagram illustrates one embodiment of a multi-speed transmission 200 according to the present disclosure. The trans-

mission 200 includes an input shaft 202 and an output shaft 204. The input shaft 202 and output shaft 204 can be disposed along the same axis or centerline of the transmission 200. In another aspect, the different shafts can be disposed along different axes or centerlines. In a further aspect, the different shafts can be disposed parallel to one another, but along different axes or centerlines. Other aspect can be appreciated by one skilled in the art.

The transmission 200 can also include a plurality of planetary gearsets. In the illustrated embodiment of FIG. 2, the transmission 200 includes a first planetary gearset 206, a second planetary gearset 208, a third planetary gearset 210, and a fourth planetary gearset 212. Each planetary gearset can be referred to as a simple or compound planetary gearset. For example, in some aspects, one or more of the plurality of planetary gearsets can be formed as an idler planetary gearset. In FIG. 2, however, each of the planetary gearsets is formed as a simple planetary gearset.

One or more of the plurality of planetary gearsets can be arranged in different locations within the transmission 200, but for sake of simplicity and in this particular example only, the planetary gearsets are aligned in an axial direction consecutively in sequence (i.e., first, second, third, and fourth between the input and output shafts).

The transmission 200 may also include a plurality of torque-transmitting or gearshifting mechanisms. For example, one or more of these mechanisms can include a clutch or brake. In one aspect, each of the plurality of mechanisms is disposed within an outer housing of the transmission 200. In another aspect, however, one or more of the mechanisms may be disposed outside of the housing. Each of the plurality of mechanisms can be coupled to one or more of the plurality of planetary gearsets, which will be described further below.

In the embodiment of FIG. 2, the transmission 200 can include a first torque-transmitting mechanism 258 and a second torque-transmitting mechanism 260 that are configured to function as brakes (e.g., the torque-transmitting mechanism is fixedly coupled to the outer housing of the transmission 200). Each brake can be configured as a shiftable-friction-locked disk brake, shiftable friction-locked band brake, shiftable form-locking claw or conical brake, or any other type of known brake. The transmission 200 can include a third torque-transmitting mechanism 262, a fourth torque-transmitting mechanism 264, and a fifth torque-transmitting mechanism 266 that are configured to function as clutches. These can be shiftable friction-locked multi-disk clutches, shiftable form-locking claw or conical clutches, wet clutches, or any other known form of a clutch. With these five torque-transmitting mechanisms, selective shifting of at least eight forward gears and at least one reverse gear is possible.

The transmission 200 of FIG. 2 may also include up to eight different shafts, which is inclusive of the input shaft 202 and output shaft 204. Each of these shafts, designated as a first shaft 222, a second shaft 224, a third shaft 226, a fourth shaft 236, a fifth shaft 246, and a sixth shaft 248, are configured to be connected to one or more of the plurality of planetary gearsets or plurality of torque-transmitting mechanism between the input shaft 202 and output shaft 204.

In FIG. 2, the first planetary gearset 206 can include a first sun gear 214, a first ring gear 216, and a first carrier member 218 that rotatably supports a set of pinion gears 220. The second planetary gearset 208 can include a second sun gear 228, a second ring gear 230, and a second carrier member 232 that rotatably supports a set of pinion gears 234. The third planetary gearset 210 can include a third sun gear 238,

a third ring gear **240**, and a third carrier member **242** that rotatably supports a set of pinion gears **244**. The fourth planetary gearset **212** can include a fourth sun gear **250**, a fourth ring gear **252**, and a fourth carrier member **254** that rotatably supports a set of pinion gears **256**.

The transmission **200** is capable of transferring torque from the input shaft **202** to the output shaft **204** in at least eight forward gears or ratios and at least one reverse gear or ratio. Each of the forward torque ratios and the reverse torque ratios can be attained by the selective engagement of one or more of the torque-transmitting mechanisms (i.e., torque-transmitting mechanisms **258**, **260**, **262**, **264**, and **266**). Those skilled in the art will readily understand that a different speed ratio is associated with each torque ratio. Thus, at least eight forward speed ratios and at least one reverse speed ratio may be attained by transmission **200**.

As for the transmission **200**, kinematic coupling of the first planetary gearset **206** is shown in FIG. **2**. The first sun gear **214** is coupled to the first shaft **222** for common rotation therewith. The first carrier member **218** is coupled to the third shaft **226** for common rotation therewith. First ring gear **216** is coupled for common rotation with the second shaft **224**.

With respect to the second planetary gearset **208**, the second sun gear **228** is coupled to the first shaft **222** and first sun gear **214** for common rotation therewith. The second ring gear **230** is coupled to the third shaft **236** for common rotation therewith. Second pinion gears **234** are configured to intermesh with the second sun gear **228** and second ring gear **230**, and the second carrier member **232** is coupled for common rotation with the input shaft **202**.

The third sun gear **238** of the third planetary gearset **210** is coupled to the sixth shaft **248** for common rotation therewith. The third ring gear **240** is coupled to the fourth shaft **236**, which is also coupled to the second ring gear **230**, for common rotation therewith. Third pinion gears **244** are configured to intermesh with the third sun gear **238** and third ring gear **240**, respectively. The third carrier member **242** is coupled for common rotation with the fifth shaft **246**.

The kinematic relationship of the fourth planetary gearset **212** is such that the fourth sun gear **250** is coupled to the sixth shaft **248**, which is also coupled to the third sun gear **238** for common rotation therewith. The fourth ring gear **252** is coupled to the third shaft **226** and first carrier member **218** for common rotation therewith. The fourth pinion gears **256** are configured to intermesh with the fourth sun gear **250** and the fourth ring gear **252**. The fourth carrier member **254** is coupled to the output shaft **204** for common rotation therewith.

With regards to the kinematic coupling of the five torque-transmitting mechanisms to the previously described shafts, the multiple speed transmission **200** of FIG. **2** provides that the first torque-transmitting mechanism **258** is arranged within the power flow between the first shaft **222** and a housing **G** of the transmission **200**. In this manner, the first torque-transmitting mechanism **258** is configured to act as a brake. The second torque-transmitting mechanism **260** is arranged within the power flow between the second shaft **224** and the housing **G** of the transmission **200**. In this manner, the second torque-transmitting mechanism **260** is configured to act as a brake. In this embodiment of the transmission **200** therefore two of the five torque-transmitting mechanisms are configured to act as a brake and the other three torque-transmitting mechanisms are configured to act as clutches.

The third torque-transmitting mechanism **262**, for example, is arranged within the power flow between the

input shaft **202** and the sixth shaft **248**. The fourth torque-transmitting mechanism **264** is arranged within the power flow between the fourth shaft **236** and the fifth shaft **246**. Moreover, the fifth torque-transmitting mechanism **266** is arranged within the power flow between the third shaft **226** and the fifth shaft **246**.

The kinematic couplings of the embodiment in FIG. **2** can further be described with respect to the selective engagement of the torque-transmitting mechanisms with respect to one or more components of the plurality of planetary gearsets. For example, in the transmission **200**, the first torque-transmitting mechanism **258** is selectively engageable to couple the first sun gear **214**, the second sun gear **228**, and the first shaft **222** to the housing **G** of the transmission **200**. The second torque-transmitting mechanism **260** is selectively engageable to couple the first ring gear **216** and the second shaft **224** to the housing **G** of the transmission **200**. Moreover, the third torque-transmitting mechanism **262** is selectively engageable to couple input shaft **202** and the second carrier member **232** to the sixth shaft **248**, third sun gear **238** and fourth sun gear **250**. The fourth torque-transmitting mechanism **264** is selectively engageable to couple fourth shaft **236**, the second ring gear **230**, and the third ring gear **240** to the third carrier member **242** and the fifth shaft **246**. Lastly, the fifth torque-transmitting mechanism **266** is selectively engageable to couple the third shaft **226**, the first carrier member **218**, and fourth ring gear **252** to the fifth shaft **246** and the third carrier member **242**.

Referring to FIG. **3**, a schematic representation or stick diagram illustrates one embodiment of a multi-speed transmission **300** according to the present disclosure. The transmission **300** includes an input shaft **302** and an output shaft **304**. The input shaft **302** and output shaft **304** can be disposed along the same axis or centerline of the transmission **300**. In another aspect, the different shafts can be disposed along different axes or centerlines. In a further aspect, the different shafts can be disposed parallel to one another, but along different axes or centerlines. Other aspect can be appreciated by one skilled in the art.

The transmission **300** can also include a plurality of planetary gearsets. In the illustrated embodiment of FIG. **3**, the transmission **300** includes a first planetary gearset **306**, a second planetary gearset **308**, a third planetary gearset **310**, and a fourth planetary gearset **312**. Each planetary gearset can be referred to as a simple or compound planetary gearset. For example, in some aspects, one or more of the plurality of planetary gearsets can be formed as an idler planetary gearset. In FIG. **3**, each planetary gearset is a simple planetary gearset.

One or more of the plurality of planetary gearsets can be arranged in different locations within the transmission **300**, but for sake of simplicity and in this particular example only, the planetary gearsets are aligned in an axial direction consecutively in sequence (i.e., first, second, third, and fourth between the input and output shafts).

The transmission **300** may also include a plurality of torque-transmitting or gearshifting mechanisms. For example, one or more of these mechanisms can include a clutch or brake. In one aspect, each of the plurality of mechanisms is disposed within an outer housing of the transmission **300**. In another aspect, however, one or more of the mechanisms may be disposed outside of the housing. Each of the plurality of mechanisms can be coupled to one or more of the plurality of planetary gearsets, which will be described further below.

In the embodiment of FIG. **3**, the transmission **300** can include a first torque-transmitting mechanism **358** and a

second torque-transmitting mechanism **360** that are configured to function as brakes (e.g., the torque-transmitting mechanism is fixedly coupled to the outer housing of the transmission **300**). Each brake can be configured as a shiftable-friction-locked disk brake, shiftable friction-locked band brake, shiftable form-locking claw or conical brake, or any other type of known brake. The transmission **300** can include a third torque-transmitting mechanism **362**, a fourth torque-transmitting mechanism **364**, and a fifth torque-transmitting mechanism **366** that are configured to function as clutches. These can be shiftable friction-locked multi-disk clutches, shiftable form-locking claw or conical clutches, wet clutches, or any other known form of a clutch. With these five torque-transmitting mechanisms, selective shifting of at least eight forward gears and at least one reverse gear is possible.

The transmission **300** of FIG. **3** may also include up to eight different shafts, which is inclusive of the input shaft **302** and output shaft **304**. Each of these shafts, designated as a first shaft **322**, a second shaft **324**, a third shaft **326**, a fourth shaft **336**, a fifth shaft **346**, and a sixth shaft **348**, are configured to be connected to one or more of the plurality of planetary gearsets or plurality of torque-transmitting mechanism between the input shaft **302** and output shaft **304**.

In FIG. **3**, the first planetary gearset **306** can include a first sun gear **314**, a first ring gear **316**, and a first carrier member **318** that rotatably supports a set of pinion gears **320**. The second planetary gearset **308** can include a second sun gear **328**, a second ring gear **330**, and a second carrier member **332** that rotatably supports a set of pinion gears **334**. The third planetary gearset **310** can include a third sun gear **338**, a third ring gear **340**, and a third carrier member **342** that rotatably supports a set of pinion gears **344**. The fourth planetary gearset **312** can include a fourth sun gear **350**, a fourth ring gear **352**, and a fourth carrier member **354** that rotatably supports a set of pinion gears **356**.

The transmission **300** is capable of transferring torque from the input shaft **302** to the output shaft **304** in at least eight forward gears or ratios and at least one reverse gear or ratio. Each of the forward torque ratios and the reverse torque ratios can be attained by the selective engagement of one or more of the torque-transmitting mechanisms (i.e., torque-transmitting mechanisms **358**, **360**, **362**, **364**, and **366**). Those skilled in the art will readily understand that a different speed ratio is associated with each torque ratio. Thus, at least eight forward speed ratios and at least one reverse speed ratio may be attained by transmission **300**.

As for the transmission **300**, kinematic coupling of the first planetary gearset **306** is shown in FIG. **3**. The first sun gear **314** is coupled to the first shaft **322** for common rotation therewith. The first carrier member **318** is coupled to the third shaft **326** for common rotation therewith. First ring gear **316** is coupled for common rotation with the second shaft **324**.

With respect to the second planetary gearset **308**, the second sun gear **328** is coupled to the first shaft **322** and first sun gear **314** for common rotation therewith. The second ring gear **330** is coupled to the fourth shaft **336** for common rotation therewith. The second carrier member **332** is coupled for common rotation with the input shaft **302**.

The third sun gear **338** of the third planetary gearset **310** is coupled to the sixth shaft **348** for common rotation therewith. The third ring gear **340** is coupled to the fourth shaft **336** for common rotation therewith. Third pinion gears **344** are configured to intermesh with the third sun gear **338**

and third ring gear **340**, respectively. The third carrier member **342** is coupled for common rotation with the fifth shaft **346**.

The kinematic relationship of the fourth planetary gearset **312** is such that the fourth sun gear **350** is coupled to the sixth shaft **348** for common rotation therewith. The fourth ring gear **352** is coupled to the third shaft **326** for common rotation therewith. The fourth pinion gears **356** are configured to intermesh with the fourth sun gear **350** and the fourth ring gear **352**. The fourth carrier member **354** is coupled to the output shaft **304** for common rotation therewith.

With regards to the kinematic coupling of the five torque-transmitting mechanisms to the previously described shafts, the multiple speed transmission **300** of FIG. **3** provides that the first torque-transmitting mechanism **358** is arranged within the power flow between the first shaft **322** and a housing **G** of the transmission **300**. In this manner, the first torque-transmitting mechanism **358** is configured to act as a brake. The second torque-transmitting mechanism **360** is arranged within the power flow between the second shaft **324** and the housing **G** of the transmission **300**. In this manner, the second torque-transmitting mechanism **360** is configured to act as a brake. In this embodiment of the transmission **300** therefore two of the five torque-transmitting mechanisms are configured to act as a brake and the other three torque-transmitting mechanisms are configured to act as clutches.

The third torque-transmitting mechanism **362**, for example, is arranged within the power flow between the input shaft **302** and the sixth shaft **348**. The fourth torque-transmitting mechanism **364** is arranged within the power flow between the fifth shaft **346** and the sixth shaft **348**. Moreover, the fifth torque-transmitting mechanism **366** is arranged within the power flow between the third shaft **326** and the fifth shaft **346**.

The kinematic couplings of the embodiment in FIG. **3** can further be described with respect to the selective engagement of the torque-transmitting mechanisms with respect to one or more components of the plurality of planetary gearsets. For example, in the transmission **300**, the first torque-transmitting mechanism **358** is selectively engageable to couple the first sun gear **314**, the second sun gear **328**, and the first shaft **322** to the housing **G** of the transmission **300**. The second torque-transmitting mechanism **360** is selectively engageable to couple the first ring gear **316** and the second shaft **324** to the housing **G** of the transmission **300**. Moreover, the third torque-transmitting mechanism **362** is selectively engageable to couple input shaft **302** and the second carrier member **332** to the sixth shaft **348**, the third sun gear **338**, and fourth sun gear **350**. The fourth torque-transmitting mechanism **364** is selectively engageable to couple fifth shaft **346** and the third carrier member **342** to the third sun gear **338**, fourth sun gear **350**, and the sixth shaft **348**. Lastly, the fifth torque-transmitting mechanism **366** is selectively engageable to couple the second carrier member **318**, the fourth ring gear **352** and the third shaft **326** to the fifth shaft **346** and third carrier member **342**.

Referring to FIG. **4**, a schematic representation or stick diagram illustrates one embodiment of a multi-speed transmission **400** according to the present disclosure. The transmission **400** includes an input shaft **402** and an output shaft **404**. The input shaft **402** and output shaft **404** can be disposed along the same axis or centerline of the transmission **400**. In another aspect, the different shafts can be disposed along different axes or centerlines. In a further aspect, the different shafts can be disposed parallel to one

another, but along different axes or centerlines. Other aspect can be appreciated by one skilled in the art.

The transmission **400** can also include a plurality of planetary gearsets. In the illustrated embodiment of FIG. **4**, the transmission **400** includes a first planetary gearset **406**, a second planetary gearset **408**, a third planetary gearset **410**, and a fourth planetary gearset **412**. Each planetary gearset can be referred to as a simple or compound planetary gearset. For example, in some aspects, one or more of the plurality of planetary gearsets can be formed as an idler planetary gearset. In FIG. **4**, for instance, the first planetary gearset **406** is structurally set forth as an idler planetary gearset. In this example, an idler planet planetary gearset can include a sun gear, a ring gear, a carrier, and two sets of pinion gears. One set of pinion gears can be rotationally coupled with the sun gear and the other set of pinion gears can be rotationally coupled to the ring gear. Both sets of pinion gears are coupled to one another such that one pinion gear of the first set is rotationally coupled to one pinion gear of the second set. In this manner, power can be transferred through the sun or ring gear via each of the sets of pinion gears.

One or more of the plurality of planetary gearsets can be arranged in different locations within the transmission **400**, but for sake of simplicity and in this particular example only, the planetary gearsets are aligned in an axial direction consecutively in sequence (i.e., first, second, third, and fourth between the input and output shafts).

The transmission **400** may also include a plurality of torque-transmitting or gearshifting mechanisms. For example, one or more of these mechanisms can include a clutch or brake. In one aspect, each of the plurality of mechanisms is disposed within an outer housing of the transmission **400**. In another aspect, however, one or more of the mechanisms may be disposed outside of the housing. Each of the plurality of mechanisms can be coupled to one or more of the plurality of planetary gearsets, which will be described further below.

In the embodiment of FIG. **4**, the transmission **400** can include a first torque-transmitting mechanism **458** and a second torque-transmitting mechanism **460** that are configured to function as brakes (e.g., the torque-transmitting mechanism is fixedly coupled to the outer housing of the transmission **400**). Each brake can be configured as a shiftable-friction-locked disk brake, shiftable friction-locked band brake, shiftable form-locking claw or conical brake, or any other type of known brake. The transmission **400** can include a third torque-transmitting mechanism **462**, a fourth torque-transmitting mechanism **464**, and a fifth torque-transmitting mechanism **466** that are configured to function as clutches. These can be shiftable friction-locked multi-disk clutches, shiftable form-locking claw or conical clutches, wet clutches, or any other known form of a clutch. With these five torque-transmitting mechanisms, selective shifting of at least eight forward gears and at least one reverse gear is possible.

The transmission **400** of FIG. **4** may also include up to eight different shafts, which is inclusive of the input shaft **402** and output shaft **404**. Each of these shafts, designated as a first shaft **422**, a second shaft **424**, a third shaft **426**, a fourth shaft **436**, a fifth shaft **446**, and a sixth shaft **448**, are configured to be connected to one or more of the plurality of planetary gearsets or plurality of torque-transmitting mechanism between the input shaft **402** and output shaft **404**.

In FIG. **4**, the first planetary gearset **406**, i.e., the idler planetary gearset, can include a first sun gear **414**, a first ring gear **416**, and a first carrier member **418** that rotatably

supports two sets of pinion gears **420**, **468**. One set of pinion gears **468** is rotationally coupled to the sun gear **414** and the other set of pinion gears **420** is rotationally coupled to the ring gear **416**. The pinion gears **420**, **468** are also rotationally coupled to one another, as is the case in each architecture described herein that includes an idler planetary gearset. The second planetary gearset **408** can include a second sun gear **428**, a second ring gear **430**, and a second carrier member **432** that rotatably supports a set of pinion gears **434**. The third planetary gearset **410** can include a third sun gear **438**, a third ring gear **440**, and a third carrier member **442** that rotatably supports a set of pinion gears **444**. The fourth planetary gearset **412** can include a fourth sun gear **450**, a fourth ring gear **452**, and a fourth carrier member **454** that rotatably supports a set of pinion gears **456**.

The transmission **400** is capable of transferring torque from the input shaft **402** to the output shaft **404** in at least eight forward gears or ratios and at least one reverse gear or ratio. Each of the forward torque ratios and the reverse torque ratios can be attained by the selective engagement of one or more of the torque-transmitting mechanisms (i.e., torque-transmitting mechanisms **458**, **460**, **462**, **464**, and **466**). Those skilled in the art will readily understand that a different speed ratio is associated with each torque ratio. Thus, at least eight forward speed ratios and at least one reverse speed ratio may be attained by transmission **400**.

As for the transmission **400**, kinematic coupling of the first planetary gearset **406** is shown in FIG. **4**. The first sun gear **414** is coupled to the first shaft **422** for common rotation therewith. The first carrier member **418** is coupled to the second shaft **424** for common rotation therewith. First ring gear **416** is coupled for common rotation with the third shaft **426**.

With respect to the second planetary gearset **408**, the second sun gear **428** is coupled to the first shaft **422** and first sun gear **414** for common rotation therewith. The second ring gear **430** is coupled to the fourth shaft **436** for common rotation therewith. The second carrier member **432** is coupled for common rotation with the input shaft **402**.

The third sun gear **438** of the third planetary gearset **410** is coupled to the sixth shaft **448** for common rotation therewith. The third ring gear **440** is coupled to the fourth shaft **436** for common rotation therewith. Third pinion gears **444** are configured to intermesh with the third sun gear **438** and third ring gear **440**, respectively. The third carrier member **442** is coupled for common rotation with the fifth shaft **446**.

The kinematic relationship of the fourth planetary gearset **412** is such that the fourth sun gear **450** is coupled to the sixth shaft **448** for common rotation therewith. The fourth ring gear **452** is coupled to the third shaft **426** for common rotation therewith. The fourth pinion gears **456** are configured to intermesh with the fourth sun gear **450** and the fourth ring gear **452**. The fourth carrier member **454** is coupled to the output shaft **404** for common rotation therewith.

With regards to the kinematic coupling of the five torque-transmitting mechanisms to the previously described shafts, the multiple speed transmission **400** of FIG. **4** provides that the first torque-transmitting mechanism **458** is arranged within the power flow between the first shaft **422** and a housing **G** of the transmission **400**. In this manner, the first torque-transmitting mechanism **458** is configured to act as a brake. The second torque-transmitting mechanism **460** is arranged within the power flow between the second shaft **424** and the housing **G** of the transmission **400**. In this manner, the second torque-transmitting mechanism **460** is configured to act as a brake. In this embodiment of the

transmission 400 therefore two of the five torque-transmitting mechanisms are configured to act as a brake and the other three torque-transmitting mechanisms are configured to act as clutches.

The third torque-transmitting mechanism 462, for example, is arranged within the power flow between the input shaft 402 and the sixth shaft 448. The fourth torque-transmitting mechanism 464 is arranged within the power flow between the fourth shaft 436 and the sixth shaft 448. Moreover, the fifth torque-transmitting mechanism 466 is

arranged within the power flow between the third shaft 426 and the fifth shaft 446.

The kinematic couplings of the embodiment in FIG. 4 can further be described with respect to the selective engagement of the torque-transmitting mechanisms with respect to one or more components of the plurality of planetary gearsets. For example, in the transmission 400, the first torque-transmitting mechanism 458 is selectively engageable to couple the first sun gear 414, the second sun gear 428, and the first shaft 422 to the housing G of the transmission 400. The second torque-transmitting mechanism 460 is selectively engageable to couple the first carrier member 418 and the second shaft 424 to the housing G of the transmission 400. Moreover, the third torque-transmitting mechanism 462 is selectively engageable to couple input shaft 402 and the second carrier member 432 to the sixth shaft 448, the third sun gear 438, and fourth sun gear 450. The fourth torque-transmitting mechanism 464 is selectively engageable to couple fourth shaft 436, the second ring gear 430, and third ring gear 440 to the third sun gear 438, fourth sun gear 450 and the sixth shaft 448. Lastly, the fifth torque-transmitting mechanism 466 is selectively engageable to couple the first ring gear 416, the fourth ring gear 452, and the third shaft 426 to the fifth shaft 446 and the third carrier member 442.

Referring to FIG. 5, a schematic representation or stick diagram illustrates one embodiment of a multi-speed transmission 500 according to the present disclosure. The transmission 500 includes an input shaft 502 and an output shaft 504. The input shaft 502 and output shaft 504 can be disposed along the same axis or centerline of the transmission 500. In another aspect, the different shafts can be disposed along different axes or centerlines. In a further aspect, the different shafts can be disposed parallel to one another, but along different axes or centerlines. Other aspect can be appreciated by one skilled in the art.

The transmission 500 can also include a plurality of planetary gearsets. In the illustrated embodiment of FIG. 5, the transmission 500 includes a first planetary gearset 506, a second planetary gearset 508, a third planetary gearset 510, and a fourth planetary gearset 512. Each planetary gearset can be referred to as a simple or compound planetary gearset. For example, in some aspects, one or more of the plurality of planetary gearsets can be formed as an idler planetary gearset. In FIG. 5, for instance, the first planetary gearset 506 is structurally set forth as an idler planetary gearset. In this example, an idler planet planetary gearset can include a sun gear, a ring gear, a carrier, and two sets of pinion gears. One set of pinion gears can be rotationally coupled with the sun gear and the other set of pinion gears can be rotationally coupled to the ring gear. Both sets of pinion gears are coupled to one another such that one pinion gear of the first set is rotationally coupled to one pinion gear of the second set. In this manner, power can be transferred through the sun or ring gear via each of the sets of pinion gears.

One or more of the plurality of planetary gearsets can be arranged in different locations within the transmission 500,

but for sake of simplicity and in this particular example only, the planetary gearsets are aligned in an axial direction consecutively in sequence (i.e., first, second, third, and fourth between the input and output shafts).

The transmission 500 may also include a plurality of torque-transmitting or gearshifting mechanisms. For example, one or more of these mechanisms can include a clutch or brake. In one aspect, each of the plurality of mechanisms is disposed within an outer housing of the transmission 500. In another aspect, however, one or more of the mechanisms may be disposed outside of the housing. Each of the plurality of mechanisms can be coupled to one or more of the plurality of planetary gearsets, which will be described further below.

In the embodiment of FIG. 5, the transmission 500 can include a first torque-transmitting mechanism 558 and a second torque-transmitting mechanism 560 that are configured to function as brakes (e.g., the torque-transmitting mechanism is fixedly coupled to the outer housing of the transmission 500). Each brake can be configured as a shiftable-friction-locked disk brake, shiftable friction-locked band brake, shiftable form-locking claw or conical brake, or any other type of known brake. The transmission 500 can include a third torque-transmitting mechanism 562, a fourth torque-transmitting mechanism 564, and a fifth torque-transmitting mechanism 566 that are configured to function as clutches. These can be shiftable friction-locked multi-disk clutches, shiftable form-locking claw or conical clutches, wet clutches, or any other known form of a clutch. With these five torque-transmitting mechanisms, selective shifting of at least eight forward gears and at least one reverse gear is possible.

The transmission 500 of FIG. 5 may also include up to eight different shafts, which is inclusive of the input shaft 502 and output shaft 504. Each of these shafts, designated as a first shaft 522, a second shaft 524, a third shaft 526, a fourth shaft 536, a fifth shaft 546, and a sixth shaft 548, are configured to be connected to one or more of the plurality of planetary gearsets or plurality of torque-transmitting mechanism between the input shaft 502 and output shaft 504.

In FIG. 5, the first planetary gearset 506, i.e., the idler planetary gearset, can include a first sun gear 514, a first ring gear 516, and a first carrier member 518 that rotatably supports two sets of pinion gears 520, 568. One set of pinion gears 568 is rotationally coupled to the sun gear 514 and the other set of pinion gears 520 is rotationally coupled to the ring gear 516. The second planetary gearset 508 can include a second sun gear 528, a second ring gear 530, and a second carrier member 532 that rotatably supports a set of pinion gears 534. The third planetary gearset 510 can include a third sun gear 538, a third ring gear 540, and a third carrier member 542 that rotatably supports a set of pinion gears 544. The fourth planetary gearset 512 can include a fourth sun gear 550, a fourth ring gear 552, and a fourth carrier member 554 that rotatably supports a set of pinion gears 556.

The transmission 500 is capable of transferring torque from the input shaft 502 to the output shaft 504 in at least eight forward gears or ratios and at least one reverse gear or ratio. Each of the forward torque ratios and the reverse torque ratios can be attained by the selective engagement of one or more of the torque-transmitting mechanisms (i.e., torque-transmitting mechanisms 558, 560, 562, 564, and 566). Those skilled in the art will readily understand that a different speed ratio is associated with each torque ratio. Thus, at least eight forward speed ratios and at least one reverse speed ratio may be attained by transmission 500.



As for the transmission **500**, kinematic coupling of the first planetary gearset **506** is shown in FIG. **5**. The first sun gear **514** is coupled to the first shaft **522** for common rotation therewith. The first carrier member **518** is coupled to the second shaft **524** for common rotation therewith. First ring gear **516** is coupled for common rotation with the third shaft **526**.

With respect to the second planetary gearset **508**, the second sun gear **528** is coupled to the first shaft **522** and first sun gear **514** for common rotation therewith. The second ring gear **530** is coupled to the fourth shaft **536** for common rotation therewith. The second carrier member **532** is coupled for common rotation with the input shaft **502**.

The third sun gear **538** of the third planetary gearset **510** is coupled to the sixth shaft **548** for common rotation therewith. The third ring gear **540** is coupled to the fourth shaft **536** for common rotation therewith. Third pinion gears **544** are configured to intermesh with the third sun gear **538** and third ring gear **540**, respectively. The third carrier member **542** is coupled for common rotation with the fifth shaft **546**.

The kinematic relationship of the fourth planetary gearset **512** is such that the fourth sun gear **550** is coupled to the sixth shaft **548** for common rotation therewith. The fourth ring gear **552** is coupled to the third shaft **526** for common rotation therewith. The fourth pinion gears **556** are configured to intermesh with the fourth sun gear **550** and the fourth ring gear **552**. The fourth carrier member **554** is coupled to the output shaft **504** for common rotation therewith.

With regards to the kinematic coupling of the five torque-transmitting mechanisms to the previously described shafts, the multiple speed transmission **500** of FIG. **5** provides that the first torque-transmitting mechanism **558** is arranged within the power flow between the first shaft **522** and a housing **G** of the transmission **500**. In this manner, the first torque-transmitting mechanism **558** is configured to act as a brake. The second torque-transmitting mechanism **560** is arranged within the power flow between the second shaft **524** and the housing **G** of the transmission **500**. In this manner, the second torque-transmitting mechanism **560** is configured to act as a brake. In this embodiment of the transmission **500** therefore two of the five torque-transmitting mechanisms are configured to act as a brake and the other three torque-transmitting mechanisms are configured to act as clutches.

The third torque-transmitting mechanism **562**, for example, is arranged within the power flow between the input shaft **502** and the sixth shaft **548**. The fourth torque-transmitting mechanism **564** is arranged within the power flow between the fourth shaft **536** and the fifth shaft **546**. Moreover, the fifth torque-transmitting mechanism **566** is arranged within the power flow between the third shaft **526** and the fifth shaft **546**.

The kinematic couplings of the embodiment in FIG. **5** can further be described with respect to the selective engagement of the torque-transmitting mechanisms with respect to one or more components of the plurality of planetary gearsets. For example, in the transmission **500**, the first torque-transmitting mechanism **558** is selectively engageable to couple the first sun gear **514**, the second sun gear **528**, and the first shaft **522** to the housing **G** of the transmission **500**. The second torque-transmitting mechanism **560** is selectively engageable to couple the first carrier member **518** and the second shaft **522** to the housing **G** of the transmission **500**. Moreover, the third torque-transmitting mechanism **562** is selectively engageable to couple input shaft **502** and the second carrier member **532** to the sixth shaft **548**, the third

sun gear **538**, and fourth sun gear **550**. The fourth torque-transmitting mechanism **564** is selectively engageable to couple fourth shaft **536**, the second ring gear **530**, and third ring gear **540** to the third carrier member **542** and the fifth shaft **546**. Lastly, the fifth torque-transmitting mechanism **566** is selectively engageable to couple the first ring gear **516**, fourth ring gear **552**, and the third shaft **526** to the fifth shaft **546** and third carrier member **542**.

Referring to FIG. **6**, a schematic representation or stick diagram illustrates one embodiment of a multi-speed transmission **600** according to the present disclosure. The transmission **600** includes an input shaft **602** and an output shaft **604**. The input shaft **602** and output shaft **604** can be disposed along the same axis or centerline of the transmission **600**. In another aspect, the different shafts can be disposed along different axes or centerlines. In a further aspect, the different shafts can be disposed parallel to one another, but along different axes or centerlines. Other aspect can be appreciated by one skilled in the art.

The transmission **600** can also include a plurality of planetary gearsets. In the illustrated embodiment of FIG. **6**, the transmission **600** includes a first planetary gearset **606**, a second planetary gearset **608**, a third planetary gearset **610**, and a fourth planetary gearset **612**. Each planetary gearset can be referred to as a simple or compound planetary gearset. For example, in some aspects, one or more of the plurality of planetary gearsets can be formed as an idler planetary gearset. In FIG. **6**, for instance, the first planetary gearset **606** is structurally set forth as an idler planetary gearset. In this example, an idler planet planetary gearset can include a sun gear, a ring gear, a carrier, and two sets of pinion gears. One set of pinion gears can be rotationally coupled with the sun gear and the other set of pinion gears can be rotationally coupled to the ring gear. Both sets of pinion gears are coupled to one another such that one pinion gear of the first set is rotationally coupled to one pinion gear of the second set. In this manner, power can be transferred through the sun or ring gear via each of the sets of pinion gears.

One or more of the plurality of planetary gearsets can be arranged in different locations within the transmission **600**, but for sake of simplicity and in this particular example only, the planetary gearsets are aligned in an axial direction consecutively in sequence (i.e., first, second, third, and fourth between the input and output shafts).

The transmission **600** may also include a plurality of torque-transmitting or gearshifting mechanisms. For example, one or more of these mechanisms can include a clutch or brake. In one aspect, each of the plurality of mechanisms is disposed within an outer housing of the transmission **600**. In another aspect, however, one or more of the mechanisms may be disposed outside of the housing. Each of the plurality of mechanisms can be coupled to one or more of the plurality of planetary gearsets, which will be described further below.

In the embodiment of FIG. **6**, the transmission **600** can include a first torque-transmitting mechanism **658** and a second torque-transmitting mechanism **660** that are configured to function as brakes (e.g., the torque-transmitting mechanism is fixedly coupled to the outer housing of the transmission **600**). Each brake can be configured as a shiftable-friction-locked disk brake, shiftable friction-locked band brake, shiftable form-locking claw or conical brake, or any other type of known brake. The transmission **600** can include a third torque-transmitting mechanism **662**, a fourth torque-transmitting mechanism **664**, and a fifth torque-transmitting mechanism **666** that are configured to

function as clutches. These can be shiftable friction-locked multi-disk clutches, shiftable form-locking claw or conical clutches, wet clutches, or any other known form of a clutch. With these five torque-transmitting mechanisms, selective shifting of at least eight forward gears and at least one reverse gear is possible.

The transmission 600 of FIG. 6 may also include up to eight different shafts, which is inclusive of the input shaft 602 and output shaft 604. Each of these shafts, designated as a first shaft 622, a second shaft 624, a third shaft 626, a fourth shaft 636, a fifth shaft 646, and a sixth shaft 648, are configured to be connected to one or more of the plurality of planetary gearsets or plurality of torque-transmitting mechanism between the input shaft 602 and output shaft 604.

In FIG. 6, the first planetary gearset 606 i.e., the idler planetary gearset, can include a first sun gear 614, a first ring gear 616, and a first carrier member 618 that rotatably supports two sets of pinion gears. One set of pinion gears 668 is rotationally coupled to the sun gear 614 and the other set of pinion gears 620 is rotationally coupled to the ring gear 616. The second planetary gearset 608 can include a second sun gear 628, a second ring gear 630, and a second carrier member 632 that rotatably supports a set of pinion gears 634. The third planetary gearset 610 can include a third sun gear 638, a third ring gear 640, and a third carrier member 642 that rotatably supports a set of pinion gears 644. The fourth planetary gearset 612 can include a fourth sun gear 650, a fourth ring gear 652, and a fourth carrier member 654 that rotatably supports a set of pinion gears 656.

The transmission 600 is capable of transferring torque from the input shaft 602 to the output shaft 604 in at least eight forward gears or ratios and at least one reverse gear or ratio. Each of the forward torque ratios and the reverse torque ratios can be attained by the selective engagement of one or more of the torque-transmitting mechanisms (i.e., torque-transmitting mechanisms 658, 660, 662, 664, and 666). Those skilled in the art will readily understand that a different speed ratio is associated with each torque ratio. Thus, at least eight forward speed ratios and at least one reverse speed ratio may be attained by transmission 600.

As for the transmission 600, kinematic coupling of the first planetary gearset 606 is shown in FIG. 6. The first sun gear 614 is coupled to the first shaft 622 for common rotation therewith. The first carrier member 618 is coupled to the second shaft 624 for common rotation therewith. First ring gear 616 is coupled for common rotation with the third shaft 626.

With respect to the second planetary gearset 608, the second sun gear 628 is coupled to the first shaft 622 and first sun gear 614 for common rotation therewith. The second ring gear 630 is coupled to the fourth shaft 636 for common rotation therewith. The second carrier member 632 is coupled for common rotation with the input shaft 602.

The third sun gear 638 of the third planetary gearset 610 is coupled to the sixth shaft 648 for common rotation therewith. The third ring gear 640 is coupled to the fourth shaft 636 for common rotation therewith. Third pinion gears 644 are configured to intermesh with the third sun gear 638 and third ring gear 640, respectively. The third carrier member 642 is coupled for common rotation with the fifth shaft 646.

The kinematic relationship of the fourth planetary gearset 612 is such that the fourth sun gear 650 is coupled to the sixth shaft 648 for common rotation therewith. The fourth ring gear 652 is coupled to the third shaft 626 for common rotation therewith. The fourth pinion gears 656 are config-

ured to intermesh with the fourth sun gear 650 and the fourth ring gear 652. The fourth carrier member 654 is coupled to the output shaft 604 for common rotation therewith.

With regards to the kinematic coupling of the five torque-transmitting mechanisms to the previously described shafts, the multiple speed transmission 600 of FIG. 6 provides that the first torque-transmitting mechanism 658 is arranged within the power flow between the first shaft 622 and a housing G of the transmission 600. In this manner, the first torque-transmitting mechanism 658 is configured to act as a brake. The second torque-transmitting mechanism 660 is arranged within the power flow between the second shaft 624 and the housing G of the transmission 600. In this manner, the second torque-transmitting mechanism 660 is configured to act as a brake. In this embodiment of the transmission 600 therefore two of the five torque-transmitting mechanisms are configured to act as a brake and the other three torque-transmitting mechanisms are configured to act as clutches.

The third torque-transmitting mechanism 662, for example, is arranged within the power flow between the input shaft 602 and the sixth shaft 648. The fourth torque-transmitting mechanism 664 is arranged within the power flow between the fifth shaft 646 and the sixth shaft 648. Moreover, the fifth torque-transmitting mechanism 666 is arranged within the power flow between the third shaft 626 and the fifth shaft 646.

The kinematic couplings of the embodiment in FIG. 6 can further be described with respect to the selective engagement of the torque-transmitting mechanisms with respect to one or more components of the plurality of planetary gearsets. For example, in the transmission 600, the first torque-transmitting mechanism 658 is selectively engageable to couple the first sun gear 614, the second sun gear 628, and the first shaft 622 to the housing G of the transmission 600. The second torque-transmitting mechanism 660 is selectively engageable to couple the first carrier member 618 and the second shaft 624 to the housing G of the transmission 600. Moreover, the third torque-transmitting mechanism 662 is selectively engageable to couple input shaft 602 and the second carrier member 632 to the sixth shaft 648, the third sun gear 638, and fourth sun gear 650. The fourth torque-transmitting mechanism 664 is selectively engageable to couple fifth shaft 646 and the third carrier member 642 to the third sun gear 638, fourth sun gear 650, and the sixth shaft 648. Lastly, the fifth torque-transmitting mechanism 666 is selectively engageable to couple the third shaft 626, the first ring gear 616, and the fourth ring gear 652 to the fifth shaft 646 and the third carrier member 642.

Referring to FIG. 7, a schematic representation or stick diagram illustrates one embodiment of a multi-speed transmission 700 according to the present disclosure. The transmission 700 includes an input shaft 702 and an output shaft 704. The input shaft 702 and output shaft 704 can be disposed along the same axis or centerline of the transmission 700. In another aspect, the different shafts can be disposed along different axes or centerlines. In a further aspect, the different shafts can be disposed parallel to one another, but along different axes or centerlines. Other aspect can be appreciated by one skilled in the art.

The transmission 700 can also include a plurality of planetary gearsets. In the illustrated embodiment of FIG. 7, the transmission 700 includes a first planetary gearset 706, a second planetary gearset 708, a third planetary gearset 710, and a fourth planetary gearset 712. Each planetary gearset can be referred to as a simple or compound planetary gearset. For example, in some aspects, one or more of the

plurality of planetary gearsets can be formed as an idler planetary gearset. In FIG. 7, for instance, the second planetary gearset **708** is structurally set forth as an idler planetary gearset. In this example, an idler planet planetary gearset can include a sun gear, a ring gear, a carrier, and two sets of pinion gears. One set of pinion gears can be rotationally coupled with the sun gear and the other set of pinion gears can be rotationally coupled to the ring gear. Both sets of pinion gears are coupled to one another such that one pinion gear of the first set is rotationally coupled to one pinion gear of the second set. In this manner, power can be transferred through the sun or ring gear via each of the sets of pinion gears.

One or more of the plurality of planetary gearsets can be arranged in different locations within the transmission **700**, but for sake of simplicity and in this particular example only, the planetary gearsets are aligned in an axial direction consecutively in sequence (i.e., first, second, third, and fourth between the input and output shafts).

The transmission **700** may also include a plurality of torque-transmitting or gearshifting mechanisms. For example, one or more of these mechanisms can include a clutch or brake. In one aspect, each of the plurality of mechanisms is disposed within an outer housing of the transmission **700**. In another aspect, however, one or more of the mechanisms may be disposed outside of the housing. Each of the plurality of mechanisms can be coupled to one or more of the plurality of planetary gearsets, which will be described further below.

In the embodiment of FIG. 7, the transmission **700** can include a first torque-transmitting mechanism **758** and a second torque-transmitting mechanism **760** that are configured to function as brakes (e.g., the torque-transmitting mechanism is fixedly coupled to the outer housing of the transmission **700**). Each brake can be configured as a shiftable-friction-locked disk brake, shiftable friction-locked band brake, shiftable form-locking claw or conical brake, or any other type of known brake. The transmission **700** can include a third torque-transmitting mechanism **762**, a fourth torque-transmitting mechanism **764**, and a fifth torque-transmitting mechanism **766** that are configured to function as clutches. These can be shiftable friction-locked multi-disk clutches, shiftable form-locking claw or conical clutches, wet clutches, or any other known form of a clutch. With these five torque-transmitting mechanisms, selective shifting of at least eight forward gears and at least one reverse gear is possible.

The transmission **700** of FIG. 7 may also include up to eight different shafts, which is inclusive of the input shaft **702** and output shaft **704**. Each of these shafts, designated as a first shaft **722**, a second shaft **724**, a third shaft **726**, a fourth shaft **736**, a fifth shaft **746**, and a sixth shaft **748**, are configured to be connected to one or more of the plurality of planetary gearsets or plurality of torque-transmitting mechanism between the input shaft **702** and output shaft **704**.

In FIG. 7, the first planetary gearset **706** can include a first sun gear **714**, a first ring gear **716**, and a first carrier member **718** that rotatably supports a set of pinion gears **720**. The second planetary gearset **708**, i.e., the idler planetary gearset, can include a second sun gear **728**, a second ring gear **730**, and a second carrier member **732** that rotatably supports two sets of pinion gears. One set of pinion gears **768** is rotationally coupled to the sun gear **728** and the other set of pinion gears **734** is rotationally coupled to the ring gear **730**. The third planetary gearset **710** can include a third sun gear **738**, a third ring gear **740**, and a third carrier member **742** that rotatably supports a set of pinion gears **744**. The fourth

planetary gearset **712** can include a fourth sun gear **750**, a fourth ring gear **752**, and a fourth carrier member **754** that rotatably supports a set of pinion gears **756**.

The transmission **700** is capable of transferring torque from the input shaft **702** to the output shaft **704** in at least eight forward gears or ratios and at least one reverse gear or ratio. Each of the forward torque ratios and the reverse torque ratios can be attained by the selective engagement of one or more of the torque-transmitting mechanisms (i.e., torque-transmitting mechanisms **758**, **760**, **762**, **764**, and **766**). Those skilled in the art will readily understand that a different speed ratio is associated with each torque ratio. Thus, at least eight forward speed ratios and at least one reverse speed ratio may be attained by transmission **700**.

As for the transmission **700**, kinematic coupling of the first planetary gearset **706** is shown in FIG. 7. The first sun gear **714** is coupled to the first shaft **722** for common rotation therewith. The first carrier member **718** is coupled to the third shaft **726** for common rotation therewith. First ring gear **716** is coupled for common rotation with the second shaft **724**.

With respect to the second planetary gearset **708**, the second sun gear **728** is coupled to the first shaft **722** and first sun gear **714** for common rotation therewith. The second ring gear **730** is coupled to the input shaft **702** for common rotation therewith. The second carrier member **732** is coupled for common rotation with the fourth shaft **736**.

The third sun gear **738** of the third planetary gearset **710** is coupled to the sixth shaft **748** for common rotation therewith. The third ring gear **740** is coupled to the fourth shaft **736** for common rotation therewith. Third pinion gears **744** are configured to intermesh with the third sun gear **738** and third ring gear **740**, respectively. The third carrier member **742** is coupled for common rotation with the fifth shaft **746**.

The kinematic relationship of the fourth planetary gearset **712** is such that the fourth sun gear **750** is coupled to the sixth shaft **748** for common rotation therewith. The fourth ring gear **752** is coupled to the third shaft **726** for common rotation therewith. The fourth pinion gears **756** are configured to intermesh with the fourth sun gear **750** and the fourth ring gear **752**. The fourth carrier member **754** is coupled to the output shaft **704** for common rotation therewith.

With regards to the kinematic coupling of the five torque-transmitting mechanisms to the previously described shafts, the multiple speed transmission **700** of FIG. 7 provides that the first torque-transmitting mechanism **758** is arranged within the power flow between the first shaft **722** and a housing **G** of the transmission **700**. In this manner, the first torque-transmitting mechanism **758** is configured to act as a brake. The second torque-transmitting mechanism **760** is arranged within the power flow between the second shaft **724** and the housing **G** of the transmission **700**. In this manner, the second torque-transmitting mechanism **760** is configured to act as a brake. In this embodiment of the transmission **700** therefore two of the five torque-transmitting mechanisms are configured to act as a brake and the other three torque-transmitting mechanisms are configured to act as clutches.

The third torque-transmitting mechanism **762**, for example, is arranged within the power flow between the input shaft **702** and the sixth shaft **748**. The fourth torque-transmitting mechanism **764** is arranged within the power flow between the fourth shaft **736** and the sixth shaft **748**. Moreover, the fifth torque-transmitting mechanism **766** is arranged within the power flow between the third shaft **726** and the fifth shaft **746**.

The kinematic couplings of the embodiment in FIG. 7 can further be described with respect to the selective engagement of the torque-transmitting mechanisms with respect to one or more components of the plurality of planetary gearsets. For example, in the transmission 700, the first torque-transmitting mechanism 758 is selectively engageable to couple the first sun gear 714, the second sun gear 728, and the first shaft 722 to the housing G of the transmission 700. The second torque-transmitting mechanism 760 is selectively engageable to couple the first ring gear 716 and the second shaft 724 to the housing G of the transmission 700. Moreover, the third torque-transmitting mechanism 762 is selectively engageable to couple input shaft 702 and the second ring gear 730 to the sixth shaft 748, third sun gear 738, and the fourth sun gear 750. The fourth torque-transmitting mechanism 764 is selectively engageable to couple the third sun gear 738, the fourth sun gear 750, and the sixth shaft 748 to the fourth shaft 736, the second carrier member 732, and the third ring gear 740. Lastly, the fifth torque-transmitting mechanism 766 is selectively engageable to couple the first carrier member 718, the fourth ring gear 752, and the third shaft 726 to the fifth shaft 746 and the third carrier member 742.

Referring to FIG. 8, a schematic representation or stick diagram illustrates one embodiment of a multi-speed transmission 800 according to the present disclosure. The transmission 800 includes an input shaft 802 and an output shaft 804. The input shaft 802 and output shaft 804 can be disposed along the same axis or centerline of the transmission 800. In another aspect, the different shafts can be disposed along different axes or centerlines. In a further aspect, the different shafts can be disposed parallel to one another, but along different axes or centerlines. Other aspect can be appreciated by one skilled in the art.

The transmission 800 can also include a plurality of planetary gearsets. In the illustrated embodiment of FIG. 8, the transmission 800 includes a first planetary gearset 806, a second planetary gearset 808, a third planetary gearset 810, and a fourth planetary gearset 812. Each planetary gearset can be referred to as a simple or compound planetary gearset. For example, in some aspects, one or more of the plurality of planetary gearsets can be formed as an idler planetary gearset. In FIG. 8, for instance, the second planetary gearset 808 is structurally set forth as an idler planetary gearset. In this example, an idler planet planetary gearset can include a sun gear, a ring gear, a carrier, and two sets of pinion gears. One set of pinion gears can be rotationally coupled with the sun gear and the other set of pinion gears can be rotationally coupled to the ring gear. Both sets of pinion gears are coupled to one another such that one pinion gear of the first set is rotationally coupled to one pinion gear of the second set. In this manner, power can be transferred through the sun or ring gear via each of the sets of pinion gears.

One or more of the plurality of planetary gearsets can be arranged in different locations within the transmission 800, but for sake of simplicity and in this particular example only, the planetary gearsets are aligned in an axial direction consecutively in sequence (i.e., first, second, third, and fourth between the input and output shafts).

The transmission 800 may also include a plurality of torque-transmitting or gearshifting mechanisms. For example, one or more of these mechanisms can include a clutch or brake. In one aspect, each of the plurality of mechanisms is disposed within an outer housing of the transmission 800. In another aspect, however, one or more of the mechanisms may be disposed outside of the housing.

Each of the plurality of mechanisms can be coupled to one or more of the plurality of planetary gearsets, which will be described further below.

In the embodiment of FIG. 8, the transmission 800 can include a first torque-transmitting mechanism 858 and a second torque-transmitting mechanism 860 that are configured to function as brakes (e.g., the torque-transmitting mechanism is fixedly coupled to the outer housing of the transmission 800). Each brake can be configured as a shiftable-friction-locked disk brake, shiftable friction-locked band brake, shiftable form-locking claw or conical brake, or any other type of known brake. The transmission 800 can include a third torque-transmitting mechanism 862, a fourth torque-transmitting mechanism 864, and a fifth torque-transmitting mechanism 866 that are configured to function as clutches. These can be shiftable friction-locked multi-disk clutches, shiftable form-locking claw or conical clutches, wet clutches, or any other known form of a clutch. With these five torque-transmitting mechanisms, selective shifting of at least eight forward gears and at least one reverse gear is possible.

The transmission 800 of FIG. 8 may also include up to eight different shafts, which is inclusive of the input shaft 802 and output shaft 804. Each of these shafts, designated as a first shaft 822, a second shaft 824, a third shaft 826, a fourth shaft 836, a fifth shaft 846, and a sixth shaft 848, are configured to be connected to one or more of the plurality of planetary gearsets or plurality of torque-transmitting mechanism between the input shaft 802 and output shaft 804.

In FIG. 8, the first planetary gearset 806 can include a first sun gear 814, a first ring gear 816, and a first carrier member 818 that rotatably supports a set of pinion gears 820. The second planetary gearset 808, i.e., the idler planetary gearset, can include a second sun gear 828, a second ring gear 830, and a second carrier member 832 that rotatably supports two sets of pinion gears. One set of pinion gears 868 is rotationally coupled to the sun gear 828 and the other set of pinion gears 834 is rotationally coupled to the ring gear 830. The third planetary gearset 810 can include a third sun gear 838, a third ring gear 840, and a third carrier member 842 that rotatably supports a set of pinion gears 844. The fourth planetary gearset 812 can include a fourth sun gear 850, a fourth ring gear 852, and a fourth carrier member 854 that rotatably supports a set of pinion gears 856.

The transmission 800 is capable of transferring torque from the input shaft 802 to the output shaft 804 in at least eight forward gears or ratios and at least one reverse gear or ratio. Each of the forward torque ratios and the reverse torque ratios can be attained by the selective engagement of one or more of the torque-transmitting mechanisms (i.e., torque-transmitting mechanisms 858, 860, 862, 864, and 866). Those skilled in the art will readily understand that a different speed ratio is associated with each torque ratio. Thus, at least eight forward speed ratios and at least one reverse speed ratio may be attained by transmission 800.

As for the transmission 800, kinematic coupling of the first planetary gearset 806 is shown in FIG. 8. The first sun gear 814 is coupled to the first shaft 822 for common rotation therewith. The first carrier member 818 is coupled to the third shaft 826 for common rotation therewith. First ring gear 816 is coupled for common rotation with the second shaft 824.

With respect to the second planetary gearset 808, the second sun gear 828 is coupled to the first shaft 822 and first sun gear 814 for common rotation therewith. The second ring gear 830 is coupled to the input shaft 802 for common

rotation therewith. The second carrier member **832** is coupled for common rotation with the fourth shaft **836**.

The third sun gear **838** of the third planetary gearset **810** is coupled to the sixth shaft **848** for common rotation therewith. The third ring gear **840** is coupled to the fourth shaft **836** for common rotation therewith. Third pinion gears **844** are configured to intermesh with the third sun gear **838** and third ring gear **840**, respectively. The third carrier member **842** is coupled for common rotation with the fifth shaft **846**.

The kinematic relationship of the fourth planetary gearset **812** is such that the fourth sun gear **850** is coupled to the sixth shaft **848** for common rotation therewith. The fourth ring gear **852** is coupled to the third shaft **826** for common rotation therewith. The fourth pinion gears **856** are configured to intermesh with the fourth sun gear **850** and the fourth ring gear **852**. The fourth carrier member **854** is coupled to the output shaft **804** for common rotation therewith.

With regards to the kinematic coupling of the five torque-transmitting mechanisms to the previously described shafts, the multiple speed transmission **800** of FIG. **8** provides that the first torque-transmitting mechanism **858** is arranged within the power flow between the first shaft **822** and a housing **G** of the transmission **800**. In this manner, the first torque-transmitting mechanism **858** is configured to act as a brake. The second torque-transmitting mechanism **860** is arranged within the power flow between the second shaft **824** and the housing **G** of the transmission **800**. In this manner, the second torque-transmitting mechanism **860** is configured to act as a brake. In this embodiment of the transmission **800** therefore two of the five torque-transmitting mechanisms are configured to act as a brake and the other three torque-transmitting mechanisms are configured to act as clutches.

The third torque-transmitting mechanism **862**, for example, is arranged within the power flow between the input shaft **802** and the sixth shaft **848**. The fourth torque-transmitting mechanism **864** is arranged within the power flow between the fourth shaft **836** and the fifth shaft **846**. Moreover, the fifth torque-transmitting mechanism **866** is arranged within the power flow between the third shaft **826** and the fifth shaft **846**.

The kinematic couplings of the embodiment in FIG. **8** can further be described with respect to the selective engagement of the torque-transmitting mechanisms with respect to one or more components of the plurality of planetary gearsets. For example, in the transmission **800**, the first torque-transmitting mechanism **858** is selectively engageable to couple the first sun gear **814**, the second sun gear **828**, and the first shaft **822** to the housing **G** of the transmission **800**. The second torque-transmitting mechanism **860** is selectively engageable to couple the first ring gear **816** and the second shaft **824** to the housing **G** of the transmission **800**. Moreover, the third torque-transmitting mechanism **862** is selectively engageable to couple input shaft **802** and the second ring gear **830** to the sixth shaft **848**, the third sun gear **838**, and fourth sun gear **850**. The fourth torque-transmitting mechanism **864** is selectively engageable to couple the second carrier member **832**, the third ring gear **840**, and the fourth shaft **836** to the fifth shaft **846** and third carrier member **842**. Lastly, the fifth torque-transmitting mechanism **866** is selectively engageable to couple the first carrier member **818**, the fourth ring gear **852**, and the third shaft **826** to the fifth shaft **846** and third carrier member **842**.

Referring to FIG. **9**, a schematic representation or stick diagram illustrates another embodiment of a multi-speed transmission **900** according to the present disclosure. The

transmission **900** includes an input shaft **902** and an output shaft **904**. The input shaft **902** and output shaft **904** can be disposed along the same axis or centerline of the transmission **900**. In another aspect, the different shafts can be disposed along different axes or centerlines. In a further aspect, the different shafts can be disposed parallel to one another, but along different axes or centerlines. Other aspect can be appreciated by one skilled in the art.

The transmission **900** can also include a plurality of planetary gearsets. In the illustrated embodiment of FIG. **9**, the transmission **900** includes a first planetary gearset **906**, a second planetary gearset **908**, a third planetary gearset **910**, and a fourth planetary gearset **912**. Each planetary gearset can be referred to as a simple or compound planetary gearset. For example, in some aspects, one or more of the plurality of planetary gearsets can be formed as an idler planetary gearset. In FIG. **9**, for instance, the second planetary gearset **908** is structurally set forth as an idler planetary gearset. In this example, an idler planet planetary gearset can include a sun gear, a ring gear, a carrier, and two sets of pinion gears. One set of pinion gears can be rotationally coupled with the sun gear and the other set of pinion gears can be rotationally coupled to the ring gear. Both sets of pinion gears are coupled to one another such that one pinion gear of the first set is rotationally coupled to one pinion gear of the second set. In this manner, power can be transferred through the sun or ring gear via each of the sets of pinion gears.

One or more of the plurality of planetary gearsets can be arranged in different locations within the transmission **900**, but for sake of simplicity and in this particular example only, the planetary gearsets are aligned in an axial direction consecutively in sequence (i.e., first, second, third, and fourth between the input and output shafts).

The transmission **900** may also include a plurality of torque-transmitting or gearshifting mechanisms. For example, one or more of these mechanisms can include a clutch or brake. In one aspect, each of the plurality of mechanisms is disposed within an outer housing of the transmission **900**. In another aspect, however, one or more of the mechanisms may be disposed outside of the housing. Each of the plurality of mechanisms can be coupled to one or more of the plurality of planetary gearsets, which will be described further below.

In the embodiment of FIG. **9**, the transmission **900** can include a first torque-transmitting mechanism **958** and a second torque-transmitting mechanism **960** that are configured to function as brakes (e.g., the torque-transmitting mechanism is fixedly coupled to the outer housing of the transmission **900**). Each brake can be configured as a shiftable-friction-locked disk brake, shiftable friction-locked band brake, shiftable form-locking claw or conical brake, or any other type of known brake. The transmission **900** can include a third torque-transmitting mechanism **962**, a fourth torque-transmitting mechanism **964**, and a fifth torque-transmitting mechanism **966** that are configured to function as clutches. These can be shiftable friction-locked multi-disk clutches, shiftable form-locking claw or conical clutches, wet clutches, or any other known form of a clutch. With these five torque-transmitting mechanisms, selective shifting of at least eight forward gears and at least one reverse gear is possible.

The transmission **900** of FIG. **9** may also include up to eight different shafts, which is inclusive of the input shaft **902** and output shaft **904**. Each of these shafts, designated as a first shaft **922**, a second shaft **924**, a third shaft **926**, a fourth shaft **936**, a fifth shaft **946**, and a sixth shaft **948**, are

configured to be connected to one or more of the plurality of planetary gearsets or plurality of torque-transmitting mechanism between the input shaft 902 and output shaft 904.

In FIG. 9, the first planetary gearset 906 can include a first sun gear 914, a first ring gear 916, and a first carrier member 918 that rotatably supports a set of pinion gears 920. The second planetary gearset 908, i.e., the idler planetary gearset, can include a second sun gear 928, a second ring gear 930, and a second carrier member 932 that rotatably supports two sets of pinion gears. One set of pinion gears 968 is rotationally coupled to the sun gear 928 and the other set of pinion gears 934 is rotationally coupled to the ring gear 930. The third planetary gearset 910 can include a third sun gear 938, a third ring gear 940, and a third carrier member 942 that rotatably supports a set of pinion gears 944. The fourth planetary gearset 912 can include a fourth sun gear 950, a fourth ring gear 952, and a fourth carrier member 954 that rotatably supports a set of pinion gears 956.

The transmission 900 is capable of transferring torque from the input shaft 902 to the output shaft 904 in at least eight forward gears or ratios and at least one reverse gear or ratio. Each of the forward torque ratios and the reverse torque ratios can be attained by the selective engagement of one or more of the torque-transmitting mechanisms (i.e., torque-transmitting mechanisms 958, 960, 962, 964, and 966). Those skilled in the art will readily understand that a different speed ratio is associated with each torque ratio. Thus, at least eight forward speed ratios and at least one reverse speed ratio may be attained by transmission 900.

As for the transmission 900, kinematic coupling of the first planetary gearset 906 is shown in FIG. 9. The first sun gear 914 is coupled to the first shaft 922 for common rotation therewith. The first carrier member 918 is coupled to the third shaft 926 for common rotation therewith. First ring gear 916 is coupled for common rotation with the second shaft 924.

With respect to the second planetary gearset 908, the second sun gear 928 is coupled to the first shaft 922 and first sun gear 914 for common rotation therewith. The second ring gear 930 is coupled to the input shaft 902 for common rotation therewith. The second carrier member 932 is coupled for common rotation with the fourth shaft 936.

The third sun gear 938 of the third planetary gearset 910 is coupled to the sixth shaft 948 for common rotation therewith. The third ring gear 940 is coupled to the fourth shaft 936 for common rotation therewith. Third pinion gears 944 are configured to intermesh with the third sun gear 938 and third ring gear 940, respectively. The third carrier member 942 is coupled for common rotation with the fifth shaft 946.

The kinematic relationship of the fourth planetary gearset 912 is such that the fourth sun gear 950 is coupled to the sixth shaft 948 and third sun gear 938 for common rotation therewith. The fourth ring gear 952 is coupled to the third shaft 926 and first carrier member 918 for common rotation therewith. The fourth pinion gears 956 are configured to intermesh with the fourth sun gear 950 and the fourth ring gear 952. The fourth carrier member 954 is coupled to the output shaft 904 for common rotation therewith.

With regards to the kinematic coupling of the five torque-transmitting mechanisms to the previously described shafts, the multiple speed transmission 900 of FIG. 9 provides that the first torque-transmitting mechanism 958 is arranged within the power flow between the first shaft 922 and a housing G of the transmission 900. In this manner, the first torque-transmitting mechanism 958 is configured to act as a brake. The second torque-transmitting mechanism 960 is

arranged within the power flow between the second shaft 924 and the housing G of the transmission 900. In this manner, the second torque-transmitting mechanism 960 is configured to act as a brake. In this embodiment of the transmission 900 therefore two of the five torque-transmitting mechanisms are configured to act as a brake and the other three torque-transmitting mechanisms are configured to act as clutches.

The third torque-transmitting mechanism 962, for example, is arranged within the power flow between the input shaft 902 and the sixth shaft 948. The fourth torque-transmitting mechanism 964 is arranged within the power flow between the fifth shaft 946 and the sixth shaft 948. Moreover, the fifth torque-transmitting mechanism 966 is arranged within the power flow between the third shaft 926 and the fifth shaft 946.

The kinematic couplings of the embodiment in FIG. 9 can further be described with respect to the selective engagement of the torque-transmitting mechanisms with respect to one or more components of the plurality of planetary gearsets. For example, in the transmission 900, the first torque-transmitting mechanism 958 is selectively engageable to couple the first sun gear 914, the second sun gear 928, and the first shaft 922 to the housing G of the transmission 900. The second torque-transmitting mechanism 960 is selectively engageable to couple the first ring gear 916 and the second shaft 924 to the housing G of the transmission 900. Moreover, the third torque-transmitting mechanism 962 is selectively engageable to couple input shaft 902 and the second ring gear 930 to the sixth shaft 948, the third sun gear 938, and fourth sun gear 950. The fourth torque-transmitting mechanism 964 is selectively engageable to couple the third carrier member 942 and the fifth shaft 946 to the sixth shaft 948, the third sun gear 938, and fourth sun gear 950. Lastly, the fifth torque-transmitting mechanism 966 is selectively engageable to couple the first carrier member 918, the fourth ring gear 952, and the third shaft 926 to the fifth shaft 946 and the third carrier member 942.

Referring to FIG. 10, a schematic representation or stick diagram illustrates a different embodiment of a multi-speed transmission 1000 according to the present disclosure. The transmission 1000 includes an input shaft 1002 and an output shaft 1004. The input shaft 1002 and output shaft 1004 can be disposed along the same axis or centerline of the transmission 1000. In another aspect, the different shafts can be disposed along different axes or centerlines. In a further aspect, the different shafts can be disposed parallel to one another, but along different axes or centerlines. Other aspect can be appreciated by one skilled in the art.

The transmission 1000 can also include a plurality of planetary gearsets. In the illustrated embodiment of FIG. 10, the transmission 1000 includes a first planetary gearset 1006, a second planetary gearset 1008, a third planetary gearset 1010, and a fourth planetary gearset 1012. Each planetary gearset can be referred to as a simple or compound planetary gearset. For example, in some aspects, one or more of the plurality of planetary gearsets can be formed as an idler planetary gearset. In FIG. 10, for instance, the third planetary gearset 1010 is structurally set forth as an idler planetary gearset. In this example, an idler planet planetary gearset can include a sun gear, a ring gear, a carrier, and two sets of pinion gears. One set of pinion gears can be rotationally coupled with the sun gear and the other set of pinion gears can be rotationally coupled to the ring gear. Both sets of pinion gears are coupled to one another such that one pinion gear of the first set is rotationally coupled to one

pinion gear of the second set. In this manner, power can be transferred through the sun or ring gear via each of the sets of pinion gears.

One or more of the plurality of planetary gearsets can be arranged in different locations within the transmission **1000**, but for sake of simplicity and in this particular example only, the planetary gearsets are aligned in an axial direction consecutively in sequence (i.e., first, second, third, and fourth between the input and output shafts).

The transmission **1000** may also include a plurality of torque-transmitting or gearshifting mechanisms. For example, one or more of these mechanisms can include a clutch or brake. In one aspect, each of the plurality of mechanisms is disposed within an outer housing of the transmission **1000**. In another aspect, however, one or more of the mechanisms may be disposed outside of the housing. Each of the plurality of mechanisms can be coupled to one or more of the plurality of planetary gearsets, which will be described further below.

In the embodiment of FIG. **10**, the transmission **1000** can include a first torque-transmitting mechanism **1058** and a second torque-transmitting mechanism **1060** that are configured to function as brakes (e.g., the torque-transmitting mechanism is fixedly coupled to the outer housing of the transmission **1000**). Each brake can be configured as a shiftable-friction-locked disk brake, shiftable friction-locked band brake, shiftable form-locking claw or conical brake, or any other type of known brake. The transmission **1000** can include a third torque-transmitting mechanism **1062**, a fourth torque-transmitting mechanism **1064**, and a fifth torque-transmitting mechanism **1066** that are configured to function as clutches. These can be shiftable friction-locked multi-disk clutches, shiftable form-locking claw or conical clutches, wet clutches, or any other known form of a clutch. With these five torque-transmitting mechanisms, selective shifting of at least eight forward gears and at least one reverse gear is possible.

The transmission **1000** of FIG. **10** may also include up to eight different shafts, which is inclusive of the input shaft **1002** and output shaft **1004**. Each of these shafts, designated as a first shaft **1022**, a second shaft **1024**, a third shaft **1026**, a fourth shaft **1036**, a fifth shaft **1046**, and a sixth shaft **1048**, are configured to be connected to one or more of the plurality of planetary gearsets or plurality of torque-transmitting mechanism between the input shaft **1002** and output shaft **1004**.

In FIG. **10**, the first planetary gearset **1006** can include a first sun gear **1014**, a first ring gear **1016**, and a first carrier member **1018** that rotatably supports a set of pinion gears **1020**. The second planetary gearset **1008** can include a second sun gear **1028**, a second ring gear **1030**, and a second carrier member **1032** that rotatably supports a set of pinion gears **1034**. The third planetary gearset **1010**, i.e., the idler planetary gearset, can include a third sun gear **1038**, a third ring gear **1040**, and a third carrier member **1042** that rotatably supports two sets of pinion gears. One set of pinion gears **1068** is rotationally coupled to the sun gear **1038** and the other set of pinion gears **1044** is rotationally coupled to the ring gear **1040**. The fourth planetary gearset **1012** can include a fourth sun gear **1050**, a fourth ring gear **1052**, and a fourth carrier member **1054** that rotatably supports a set of pinion gears **1056**.

The transmission **1000** is capable of transferring torque from the input shaft **1002** to the output shaft **1004** in at least eight forward gears or ratios and at least one reverse gear or ratio. Each of the forward torque ratios and the reverse torque ratios can be attained by the selective engagement of

one or more of the torque-transmitting mechanisms (i.e., torque-transmitting mechanisms **1058**, **1060**, **1062**, **1064**, and **1066**). Those skilled in the art will readily understand that a different speed ratio is associated with each torque ratio. Thus, at least eight forward speed ratios and at least one reverse speed ratio may be attained by transmission **1000**.

As for the transmission **1000**, kinematic coupling of the first planetary gearset **1006** is shown in FIG. **10**. The first sun gear **1014** is coupled to the first shaft **1022** for common rotation therewith. The first carrier member **1018** is coupled to the third shaft **1026** for common rotation therewith. First ring gear **1016** is coupled for common rotation with the second shaft **1024**.

With respect to the second planetary gearset **1008**, the second sun gear **1028** is coupled to the first shaft **1022** and first sun gear **1014** for common rotation therewith. The second ring gear **1030** is coupled to the fourth shaft **1036** for common rotation therewith. The second carrier member **1032** is coupled for common rotation with the input shaft **1002**.

The third sun gear **1038** of the third planetary gearset **1010** is coupled to the sixth shaft **1048** for common rotation therewith. The third ring gear **1040** is coupled to the fifth shaft **1046** for common rotation therewith. The third carrier member **1042** is coupled for common rotation with the fourth shaft **1036**.

The kinematic relationship of the fourth planetary gearset **1012** is such that the fourth sun gear **1050** is coupled to the sixth shaft **1048** for common rotation therewith. The fourth ring gear **1052** is coupled to the third shaft **1026** and the first carrier member **1018** for common rotation therewith. The fourth pinion gears **1056** are configured to intermesh with the fourth sun gear **1050** and the fourth ring gear **1052**. The fourth carrier member **1054** is coupled to the output shaft **1004** for common rotation therewith.

With regards to the kinematic coupling of the five torque-transmitting mechanisms to the previously described shafts, the multiple speed transmission **1000** of FIG. **10** provides that the first torque-transmitting mechanism **1058** is arranged within the power flow between the first shaft **1022** and a housing G of the transmission **1000**. In this manner, the first torque-transmitting mechanism **1058** is configured to act as a brake. The second torque-transmitting mechanism **1060** is arranged within the power flow between the second shaft **1024** and the housing G of the transmission **1000**. In this manner, the second torque-transmitting mechanism **1060** is configured to act as a brake. In this embodiment of the transmission **1000** therefore two of the five torque-transmitting mechanisms are configured to act as a brake and the other three torque-transmitting mechanisms are configured to act as clutches.

The third torque-transmitting mechanism **1062**, for example, is arranged within the power flow between the input shaft **1002** and the sixth shaft **1048**. The fourth torque-transmitting mechanism **1064** is arranged within the power flow between the fourth shaft **1036** and the fifth shaft **1046**. Moreover, the fifth torque-transmitting mechanism **1066** is arranged within the power flow between the third shaft **1026** and the fifth shaft **1046**.

The kinematic couplings of the embodiment in FIG. **10** can further be described with respect to the selective engagement of the torque-transmitting mechanisms with respect to one or more components of the plurality of planetary gearsets. For example, in the transmission **1000**, the first torque-transmitting mechanism **1058** is selectively engageable to couple the first sun gear **1014**, the second sun gear **1028**, and

the first shaft **1022** to the housing **G** of the transmission **1000**. The second torque-transmitting mechanism **1060** is selectively engageable to couple the first ring gear **1016** and the second shaft **1024** to the housing **G** of the transmission **1000**. Moreover, the third torque-transmitting mechanism **1062** is selectively engageable to couple input shaft **1002** and the second carrier member **1032** to the sixth shaft **1048**, the third sun gear **1038**, and fourth sun gear **1050**. The fourth torque-transmitting mechanism **1064** is selectively engageable to couple the third ring gear **1040** and the fifth shaft **1046** to the fourth shaft **1036** and third carrier member **1042**. Lastly, the fifth torque-transmitting mechanism **1066** is selectively engageable to couple the first carrier member **1018**, the fourth ring gear **1052**, and the third shaft **1026** to the fifth shaft **1046** and third ring gear **1040**.

Referring to FIG. **11**, a schematic representation or stick diagram illustrates a further embodiment of a multi-speed transmission **1100** according to the present disclosure. The transmission **1100** includes an input shaft **1102** and an output shaft **1104**. The input shaft **1102** and output shaft **1104** can be disposed along the same axis or centerline of the transmission **1100**. In another aspect, the different shafts can be disposed along different axes or centerlines. In a further aspect, the different shafts can be disposed parallel to one another, but along different axes or centerlines. Other aspect can be appreciated by one skilled in the art.

The transmission **1100** can also include a plurality of planetary gearsets. In the illustrated embodiment of FIG. **11**, the transmission **1100** includes a first planetary gearset **1106**, a second planetary gearset **1108**, a third planetary gearset **1110**, and a fourth planetary gearset **1112**. Each planetary gearset can be referred to as a simple or compound planetary gearset. For example, in some aspects, one or more of the plurality of planetary gearsets can be formed as an idler planetary gearset. In FIG. **11**, for instance, the third planetary gearset **1110** is structurally set forth as an idler planetary gearset. In this example, an idler planet planetary gearset can include a sun gear, a ring gear, a carrier, and two sets of pinion gears. One set of pinion gears can be rotationally coupled with the sun gear and the other set of pinion gears can be rotationally coupled to the ring gear. Both sets of pinion gears are coupled to one another such that one pinion gear of the first set is rotationally coupled to one pinion gear of the second set. In this manner, power can be transferred through the sun or ring gear via each of the sets of pinion gears.

One or more of the plurality of planetary gearsets can be arranged in different locations within the transmission **1100**, but for sake of simplicity and in this particular example only, the planetary gearsets are aligned in an axial direction consecutively in sequence (i.e., first, second, third, and fourth between the input and output shafts).

The transmission **1100** may also include a plurality of torque-transmitting or gearshifting mechanisms. For example, one or more of these mechanisms can include a clutch or brake. In one aspect, each of the plurality of mechanisms is disposed within an outer housing of the transmission **1100**. In another aspect, however, one or more of the mechanisms may be disposed outside of the housing. Each of the plurality of mechanisms can be coupled to one or more of the plurality of planetary gearsets, which will be described further below.

In the embodiment of FIG. **11**, the transmission **1100** can include a first torque-transmitting mechanism **1158** and a second torque-transmitting mechanism **1160** that are configured to function as brakes (e.g., the torque-transmitting mechanism is fixedly coupled to the outer housing of the

transmission **1100**). Each brake can be configured as a shiftable-friction-locked disk brake, shiftable friction-locked band brake, shiftable form-locking claw or conical brake, or any other type of known brake. The transmission **1100** can include a third torque-transmitting mechanism **1162**, a fourth torque-transmitting mechanism **1164**, and a fifth torque-transmitting mechanism **1166** that are configured to function as clutches. These can be shiftable friction-locked multi-disk clutches, shiftable form-locking claw or conical clutches, wet clutches, or any other known form of a clutch. With these five torque-transmitting mechanisms, selective shifting of at least eight forward gears and at least one reverse gear is possible.

The transmission **1100** of FIG. **11** may also include up to eight different shafts, which is inclusive of the input shaft **1102** and output shaft **1104**. Each of these shafts, designated as a first shaft **1122**, a second shaft **1124**, a third shaft **1126**, a fourth shaft **1136**, a fifth shaft **1146**, and a sixth shaft **1148**, are configured to be connected to one or more of the plurality of planetary gearsets or plurality of torque-transmitting mechanism between the input shaft **1102** and output shaft **1104**.

In FIG. **11**, the first planetary gearset **1106** can include a first sun gear **1114**, a first ring gear **1116**, and a first carrier member **1118** that rotatably supports a set of pinion gears **1120**. The second planetary gearset **1108** can include a second sun gear **1128**, a second ring gear **1130**, and a second carrier member **1132** that rotatably supports a set of pinion gears **1134**. The third planetary gearset **1110**, i.e., the idler planetary gearset, can include a third sun gear **1138**, a third ring gear **1140**, and a third carrier member **1142** that rotatably supports two sets of pinion gears. One set of pinion gears **1168** is rotationally coupled to the sun gear **1138** and the other set of pinion gears **1144** is rotationally coupled to the ring gear **1140**. The fourth planetary gearset **1112** can include a fourth sun gear **1150**, a fourth ring gear **1152**, and a fourth carrier member **1154** that rotatably supports a set of pinion gears **1156**.

The transmission **1100** is capable of transferring torque from the input shaft **1102** to the output shaft **1104** in at least eight forward gears or ratios and at least one reverse gear or ratio. Each of the forward torque ratios and the reverse torque ratios can be attained by the selective engagement of one or more of the torque-transmitting mechanisms (i.e., torque-transmitting mechanisms **1158**, **1160**, **1162**, **1164**, and **1166**). Those skilled in the art will readily understand that a different speed ratio is associated with each torque ratio. Thus, at least eight forward speed ratios and at least one reverse speed ratio may be attained by transmission **1100**.

As for the transmission **1100**, kinematic coupling of the first planetary gearset **1106** is shown in FIG. **11**. The first sun gear **1114** is coupled to the first shaft **1122** for common rotation therewith. The first carrier member **1118** is coupled to the third shaft **1126** for common rotation therewith. First ring gear **1116** is coupled for common rotation with the second shaft **1124**.

With respect to the second planetary gearset **1108**, the second sun gear **1128** is coupled to the first shaft **1122** and first sun gear **1114** for common rotation therewith. The second ring gear **1130** is coupled to the fourth shaft **1136** for common rotation therewith. The second carrier member **1132** is coupled for common rotation with the input shaft **1102**.

The third sun gear **1138** of the third planetary gearset **1110** is coupled to the sixth shaft **1148** for common rotation therewith. The third ring gear **1140** is coupled to the fifth



shaft **1146** for common rotation therewith. The third carrier member **1142** is coupled for common rotation with the fourth shaft **1136**.

The kinematic relationship of the fourth planetary gearset **1112** is such that the fourth sun gear **1150** is coupled to the sixth shaft **1148** for common rotation therewith. The fourth ring gear **1152** is coupled to the third shaft **1126** and the first carrier member **1118** for common rotation therewith. The fourth pinion gears **1156** are configured to intermesh with the fourth sun gear **1150** and the fourth ring gear **1152**. The fourth carrier member **1154** is coupled to the output shaft **1104** for common rotation therewith.

With regards to the kinematic coupling of the five torque-transmitting mechanisms to the previously described shafts, the multiple speed transmission **1100** of FIG. **11** provides that the first torque-transmitting mechanism **1158** is arranged within the power flow between the first shaft **1122** and a housing **G** of the transmission **1100**. In this manner, the first torque-transmitting mechanism **1158** is configured to act as a brake. The second torque-transmitting mechanism **1160** is arranged within the power flow between the second shaft **1124** and the housing **G** of the transmission **1100**. In this manner, the second torque-transmitting mechanism **1160** is configured to act as a brake. In this embodiment of the transmission **1100** therefore two of the five torque-transmitting mechanisms are configured to act as a brake and the other three torque-transmitting mechanisms are configured to act as clutches.

The third torque-transmitting mechanism **1162**, for example, is arranged within the power flow between the input shaft **1102** and the sixth shaft **1148**. The fourth torque-transmitting mechanism **1164** is arranged within the power flow between the fifth shaft **1146** and the sixth shaft **1148**. Moreover, the fifth torque-transmitting mechanism **1166** is arranged within the power flow between the third shaft **1126** and the fifth shaft **1146**.

The kinematic couplings of the embodiment in FIG. **11** can further be described with respect to the selective engagement of the torque-transmitting mechanisms with respect to one or more components of the plurality of planetary gearsets. For example, in the transmission **1100**, the first torque-transmitting mechanism **1158** is selectively engageable to couple the first sun gear **1114**, the second sun gear **1128**, and the first shaft **1122** to the housing **G** of the transmission **1100**. The second torque-transmitting mechanism **1160** is selectively engageable to couple the first ring gear **1116** and the second shaft **1124** to the housing **G** of the transmission **1100**. Moreover, the third torque-transmitting mechanism **1162** is selectively engageable to couple input shaft **1102** and the second carrier member **1132** to the sixth shaft **1148**, the third sun gear **1138**, and fourth sun gear **1150**. The fourth torque-transmitting mechanism **1164** is selectively engageable to couple the third ring gear **1140** and the fifth shaft **1146** to the sixth shaft **1148**, the third sun gear **1138**, and fourth sun gear **1150**. Lastly, the fifth torque-transmitting mechanism **1166** is selectively engageable to couple the first carrier member **1118**, the fourth ring gear **1152**, and the third shaft **1126** to the fifth shaft **1146** and third ring gear **1140**.

As previously described, the aforementioned embodiment is capable of transmitting torque from a respective input shaft to a respective output shaft in at least eight forward torque ratios and one reverse torque ratio. Referring to FIG. **12**, one example of a truth table is shown representing a state of engagement of various torque transmitting mechanisms in each of the available forward and reverse speeds or gear ratios of the transmissions illustrated in FIGS. **2-11**. It is to be understood that FIG. **12** is only one example of any

number of truth tables possible for achieving at least eight forward ratios and one reverse ratio, and one skilled in the art is capable of configuring diameters, gear tooth counts, and gear configurations to achieve other ratios.

In the example of FIG. **12**, the reverse ratio (rev) can be achieved by the selective engagement of the torque-transmitting mechanisms as set forth in the table. As shown, the first torque transmitting mechanism (B1), second torque-transmitting mechanism (B2), and fifth torque-transmitting mechanism (C5) are selectively engaged to establish the reverse ratio. Thus, in transmission **200** of FIG. **2**, the selective engagement of mechanisms **258**, **260**, and **266** can establish the reverse ratio.

In neutral (Neu), none of the torque-transmitting mechanisms carry torque. One or more of the torque-transmitting mechanisms, however, may be engaged in neutral but not carrying torque. For example, the first and fourth torque-transmitting mechanisms can be engaged in neutral, thereby resulting in the fifth torque-transmitting mechanism being disengaged between a shift between the one reverse ratio and neutral.

A first forward ratio (shown as 1st) in the table of FIG. **12** is achieved by engaging both brakes and one of the clutches. In FIG. **2**, for example, the first torque-transmitting mechanism **258**, the second torque-transmitting mechanism **260**, and the third torque-transmitting mechanism **262** are engaged. Thus, when transitioning between neutral and the first forward range, the first and second torque-transmitting mechanisms may already be engaged, and the third torque-transmitting mechanism is selectively engaged.

In a second or subsequent forward ratio, indicated as 2nd in FIG. **12**, the first torque-transmitting mechanism, the second torque-transmitting mechanism, and the fourth torque-transmitting mechanism are selectively engaged. Therefore, when transitioning between the first forward ratio and the second forward ratio, the third torque-transmitting mechanism is released and the fourth torque-transmitting mechanism is engaged.

In a third or subsequent forward ratio, indicated as 3rd forward ratio in FIG. **12**, the second torque-transmitting mechanism, third torque-transmitting mechanism, and fourth torque-transmitting mechanism are engaged. To transition from the second forward ratio to the third forward ratio, for example, the first torque-transmitting mechanism is released and the third torque-transmitting mechanism is engaged.

In a fourth or the next subsequent forward ratio, indicated as 4th in FIG. **12**, the second torque-transmitting mechanism, fourth torque-transmitting mechanism, and fifth torque-transmitting mechanism are engaged. Thus, to transition from the third forward ratio and upshift to the fourth forward ratio, the third torque-transmitting mechanism is released and the fifth torque-transmitting mechanism is engaged.

In a fifth or the next subsequent forward ratio, indicated as 5th in FIG. **12**, the second torque-transmitting mechanism, third torque-transmitting mechanism, and fifth torque-transmitting mechanism are engaged. Thus, to transition from the fourth forward ratio and upshift to the fifth forward ratio, the fourth torque-transmitting mechanism is released and the third torque-transmitting mechanism is engaged.

In a sixth or the next subsequent forward ratio, indicated as 6th in FIG. **12**, the third torque-transmitting mechanism, fourth torque-transmitting mechanism, and fifth torque-transmitting mechanism are engaged. Thus, to transition from the fifth forward ratio and upshift to the sixth forward

ratio, the second torque-transmitting mechanism is released and the fourth torque-transmitting mechanism is engaged.

In a seventh or the next subsequent forward ratio, indicated as 7th in FIG. 12, the first torque-transmitting mechanism, third torque-transmitting mechanism, and fifth torque-transmitting mechanism are engaged. Thus, to transition from the sixth forward ratio and upshift to the seventh forward ratio, the fourth torque-transmitting mechanism is released and the first torque-transmitting mechanism is engaged.

In an eighth or the next subsequent forward ratio, indicated as 8th in FIG. 12, the first torque-transmitting mechanism, fourth torque-transmitting mechanism, and fifth torque-transmitting mechanism are engaged. Thus, to transition from the seventh forward ratio and upshift to the eighth forward ratio, the third torque-transmitting mechanism is released and the fourth torque-transmitting mechanism is engaged.

The present disclosure contemplates that downshifts follow the reverse sequence of the corresponding upshift (as described above), and several power-on skip-shifts that are single-transition are possible (e.g. from 1st to 3rd or 3rd to 1st).

While exemplary embodiments incorporating the principles of the present disclosure have been disclosed hereinabove, the present disclosure is not limited to the disclosed embodiments. Instead, this application is intended to cover any variations, uses, or adaptations of the disclosure using its general principles. Further, this application is intended to cover such departures from the present disclosure as come within known or customary practice in the art to which this disclosure pertains and which fall within the limits of the appended claims.

The invention claimed is:

**1.** A multiple speed transmission, comprising:

an input member;

an output member;

first, second, third and fourth planetary gearsets each

having first, second and third members;

a plurality of interconnecting members each connected between at least one of the first, second, third, and fourth planetary gearsets and at least another of the first, second, third, and fourth planetary gearsets;

a first torque-transmitting mechanism selectively engageable to interconnect the first member of the first planetary gearset and the first member of the second planetary gearset with a stationary member;

a second torque-transmitting mechanism selectively engageable to interconnect the third member of the first planetary gearset with the stationary member;

a third torque-transmitting mechanism selectively engageable to interconnect the second member of the second planetary gearset with the first member of the third planetary gearset and the first member of the fourth planetary gearset;

a fourth torque-transmitting mechanism selectively engageable to interconnect the third member of the third planetary gearset with the first member of the third planetary gearset and the first member of the fourth planetary gearset; and

a fifth torque-transmitting mechanism selectively engageable to interconnect the second member of the first planetary gearset and the third member of the fourth planetary gearset with the third member of the third planetary gearset;

wherein, the third planetary gearset comprises an idler planetary gearset;

wherein the torque transmitting mechanisms are selectively engageable in combinations of at least three to establish at least eight forward speed ratios and at least one reverse speed ratio between the input member and the output member.

**2.** The multiple speed transmission of claim 1, wherein the input member is continuously interconnected with the second member of the second planetary gearset.

**3.** The multiple speed transmission of claim 1, wherein the output member is continuously interconnected with the second member of the fourth planetary gearset.

**4.** The multiple speed transmission of claim 1, wherein the plurality of interconnecting members includes a first interconnecting member continuously interconnecting the first member of the first planetary gearset with the first member of the second planetary gearset.

**5.** The multiple speed transmission of claim 1, wherein the plurality of interconnecting members includes a second interconnecting member directly connected to the third member of the first planetary gearset.

**6.** The multiple speed transmission of claim 1, wherein the plurality of interconnecting members includes a third interconnecting member continuously interconnecting the second member of the first planetary gearset with the third member of the fourth planetary gearset.

**7.** The multiple speed transmission of claim 1, wherein the plurality of interconnecting members includes a fourth interconnecting member continuously interconnecting the third member of the second planetary gearset with the second member of the third planetary gearset.

**8.** The multiple speed transmission of claim 1, wherein the plurality of interconnecting members includes a fifth interconnecting member directly connected to the third member of the third planetary gearset.

**9.** The multiple speed transmission of claim 1, wherein the plurality of interconnecting members includes a sixth interconnecting member continuously interconnecting the first member of the third planetary gearset with the first member of the fourth planetary gearset.

**10.** A multiple speed transmission, comprising:

an input member;

an output member;

first, second, third and fourth planetary gearsets each having a sun gear, a ring gear, and a carrier member;

a plurality of interconnecting members each connected between at least one of the first, second, third, and fourth planetary gearsets and at least another of the first, second, third, and fourth planetary gearsets;

a first torque-transmitting mechanism selectively engageable to interconnect the sun gear of the first planetary gearset and the sun gear of the second planetary gearset with a stationary member;

a second torque-transmitting mechanism selectively engageable to interconnect the ring gear of the first planetary gearset with the stationary member;

a third torque-transmitting mechanism selectively engageable to interconnect the carrier member of the second planetary gearset with the sun gear of the third planetary gearset and the sun gear of the fourth planetary gearset;

a fourth torque-transmitting mechanism selectively engageable to interconnect the ring gear of the third planetary gearset with the sun gear of the third planetary gearset and the sun gear of the fourth planetary gearset; and

a fifth torque-transmitting mechanism selectively engageable to interconnect the carrier member of the first

39

planetary gearset and the ring gear of the fourth planetary gearset with the ring gear of the third planetary gearset;

wherein the torque transmitting mechanisms are selectively engageable in combinations of at least three to establish at least eight forward speed ratios and at least one reverse speed ratio between the input member and the output member.

11. The multiple speed transmission of claim 10, wherein the input member is continuously interconnected with the carrier member of the second planetary gearset.

12. The multiple speed transmission of claim 10, wherein the output member is continuously interconnected with the carrier member of the fourth planetary gearset.

13. The multiple speed transmission of claim 10, wherein the plurality of interconnecting members includes a first interconnecting member continuously interconnecting the sun gear of the first planetary gearset with the sun gear of the second planetary gearset.

14. The multiple speed transmission of claim 10, wherein the plurality of interconnecting members includes a second interconnecting member directly connected to the ring gear of the first planetary gearset.

15. The multiple speed transmission of claim 10, wherein the plurality of interconnecting members includes a third interconnecting member continuously interconnecting the carrier member of the first planetary gearset with the ring gear of the fourth planetary gearset.

16. The multiple speed transmission of claim 10, wherein the plurality of interconnecting members includes a fourth interconnecting member continuously interconnecting the ring gear of the second planetary gearset with the carrier member of the third planetary gearset.

17. The multiple speed transmission of claim 10, wherein the plurality of interconnecting members includes a fifth interconnecting member directly connected to the ring gear of the third planetary gearset.

18. The multiple speed transmission of claim 10, wherein the plurality of interconnecting members includes a sixth interconnecting member continuously interconnecting the sun gear of the third planetary gearset with the sun gear of the fourth planetary gearset.

19. A multiple speed transmission, comprising:

an input member;

an output member;

first, second, third and fourth planetary gearsets each having a sun gear, a ring gear, and a carrier member;

a plurality of interconnecting members each connected between at least one of the first, second, third, and fourth planetary gearsets and at least another of the first, second, third, and fourth planetary gearsets;

40

a first torque-transmitting mechanism selectively engageable to interconnect the sun gear of the first planetary gearset and the sun gear of the second planetary gearset with a stationary member;

a second torque-transmitting mechanism selectively engageable to interconnect the ring gear of the first planetary gearset with the stationary member;

a third torque-transmitting mechanism selectively engageable to interconnect the carrier member of the second planetary gearset with the sun gear of the third planetary gearset and the sun gear of the fourth planetary gearset;

a fourth torque-transmitting mechanism selectively engageable to interconnect the ring gear of the third planetary gearset with the sun gear of the third planetary gearset and the sun gear of the fourth planetary gearset;

a fifth torque-transmitting mechanism selectively engageable to interconnect the carrier member of the first planetary gearset and the ring gear of the fourth planetary gearset with the ring gear of the third planetary gearset;

a first interconnecting member continuously interconnecting the sun gear of the first planetary gearset with the sun gear of the second planetary gearset;

a second interconnecting member directly connected to the ring gear of the first planetary gearset;

a third interconnecting member continuously interconnecting the carrier member of the first planetary gearset with the ring gear of the fourth planetary gearset;

a fourth interconnecting member continuously interconnecting the ring gear of the second planetary gearset with the carrier member of the third planetary gearset;

a fifth interconnecting member directly connected to the ring gear of the third planetary gearset; and

a sixth interconnecting member continuously interconnecting the sun gear of the third planetary gearset with the sun gear of the fourth planetary gearset;

wherein the torque transmitting mechanisms are selectively engageable in combinations of at least three to establish at least eight forward speed ratios and at least one reverse speed ratio between the input member and the output member.

20. The multiple speed transmission of claim 19, wherein the input member is continuously interconnected with the carrier member of the second planetary gearset, and the output member is continuously interconnected with the carrier member of the fourth planetary gearset.

\* \* \* \* \*