



US010278176B2

(12) **United States Patent**
Vrzic et al.

(10) **Patent No.:** **US 10,278,176 B2**
(45) **Date of Patent:** **Apr. 30, 2019**

(54) **UPLINK CONTROL IN A WIRELESS COMMUNICATION NETWORK**

FOREIGN PATENT DOCUMENTS

(71) Applicant: **Apple Inc.**, Cupertino, CA (US)
(72) Inventors: **Sophie Vrzic**, Nepean (CA); **Jun Yuan**, Ottawa (CA); **Mo-Han Fong**, Sunnyvale, CA (US); **Robert Novak**, Ottawa (CA); **Dong-Sheng Yu**, Ottawa (CA); **Jianglei Ma**, Kanata (CA)

CN 101155163 A 4/2008
KR 1020050029112 3/2005

(Continued)

(73) Assignee: **Apple Inc.**, Cupertino, CA (US)
(*) Notice: Subject to any disclaimer, the term of this patent is extended or adjusted under 35 U.S.C. 154(b) by 0 days.

OTHER PUBLICATIONS

Supplementary Search Report, European Application No. 09735501, dated Jul. 24, 2015, 19 pages.

(Continued)

(21) Appl. No.: **15/723,310**
(22) Filed: **Oct. 3, 2017**

Primary Examiner — Paul H Masur

(74) *Attorney, Agent, or Firm* — Meyertons, Hood, Kivlin, Kowert & Goetzl, P.C.

(65) **Prior Publication Data**

US 2018/0027558 A1 Jan. 25, 2018

Related U.S. Application Data

(63) Continuation of application No. 15/055,793, filed on Feb. 29, 2016, now Pat. No. 9,794,938, which is a (Continued)

(51) **Int. Cl.**
H04W 72/04 (2009.01)
H04W 74/00 (2009.01)

(Continued)

(52) **U.S. Cl.**
CPC **H04W 72/0446** (2013.01); **H04J 11/00** (2013.01); **H04L 5/005** (2013.01); (Continued)

(58) **Field of Classification Search**
CPC H04W 74/004; H04W 74/0833; H04W 74/0866; H04W 72/004; H04W 72/0413; (Continued)

(57) **ABSTRACT**

A method and system are provided having an uplink control structure and a pilot signal having minimal signal overhead for providing channel estimation and data demodulation in a wireless communication network. The uplink control structures enable mobile terminals to communicate with corresponding base stations to perform various functions including obtaining initial system access, submitting a bandwidth request, triggering a continuation of negotiated service, or providing a proposed allocation re-configuration header. A dedicated random access channel is provided to communicatively couple the base station and the mobile terminal so that the mobile terminal can select a random access signaling identification. A resource request is received at the base station to uplink resource information from the mobile terminal and an initial access information request is received from the mobile terminal to configure the base station connection. Pilot signals with varying density configurations are provided to include low density symbol patterns for multiple contiguous resource blocks and high density symbol patterns for single resource blocks.

(56) **References Cited**

U.S. PATENT DOCUMENTS

6,850,504 B1 2/2005 Cao et al.
7,340,256 B2 3/2008 Speight
(Continued)

20 Claims, 7 Drawing Sheets

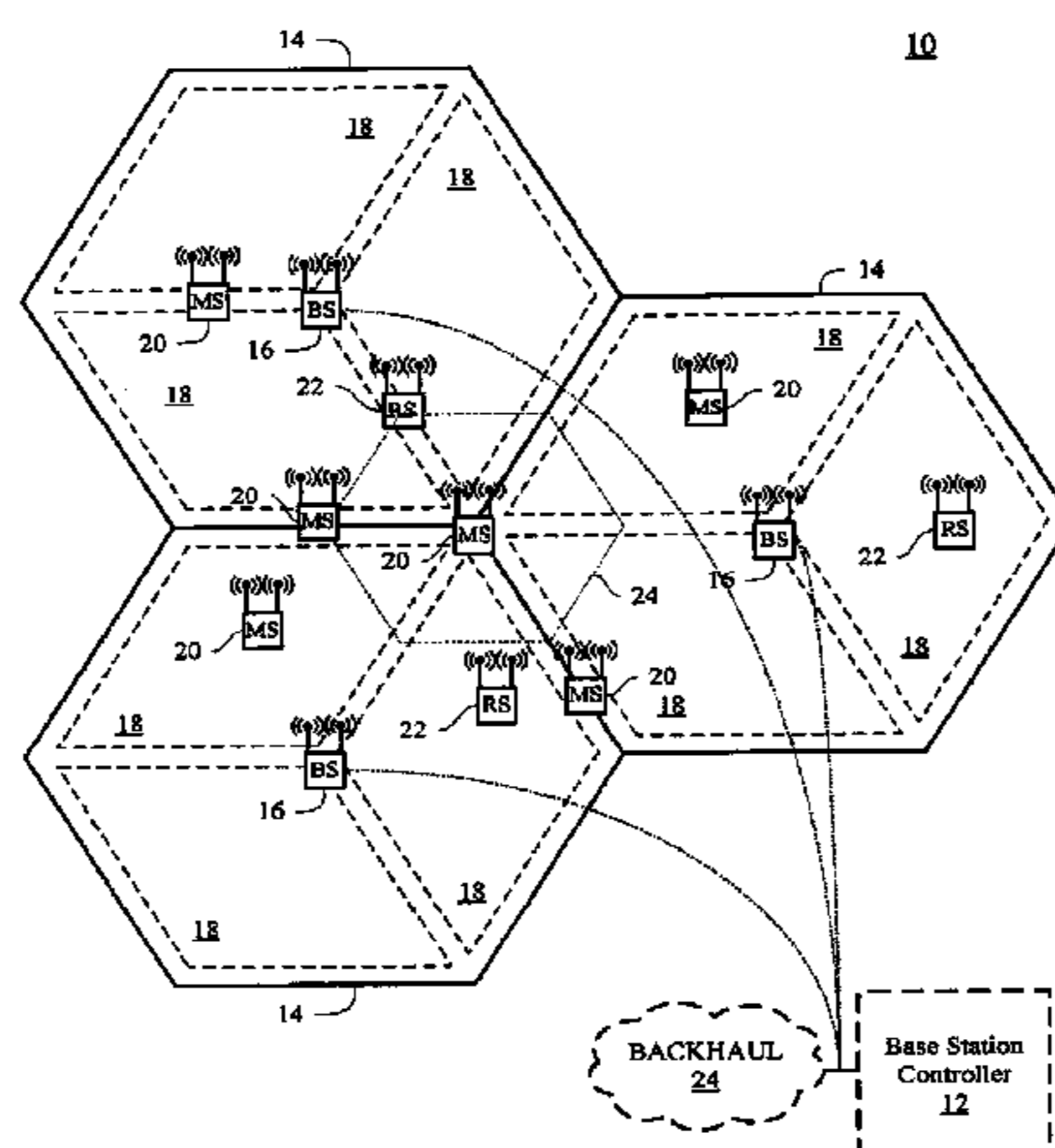

Related U.S. Application Data

continuation of application No. 14/618,558, filed on Feb. 10, 2015, now Pat. No. 9,277,569, which is a continuation of application No. 14/177,716, filed on Feb. 11, 2014, now Pat. No. 8,989,148, which is a continuation of application No. 12/989,044, filed as application No. PCT/CA2009/000523 on Apr. 21, 2009, now Pat. No. 8,761,115.

(60) Provisional application No. 61/050,303, filed on May 5, 2008, provisional application No. 61/046,596, filed on Apr. 21, 2008.

(51) **Int. Cl.**

H04W 74/08 (2009.01)
H04L 5/00 (2006.01)
H04L 27/26 (2006.01)
H04J 11/00 (2006.01)
H04W 84/12 (2009.01)
H04W 88/08 (2009.01)
H04W 88/12 (2009.01)

(52) **U.S. Cl.**

CPC *H04L 5/0053* (2013.01); *H04L 5/0055* (2013.01); *H04L 27/2602* (2013.01); *H04W 72/042* (2013.01); *H04W 72/0413* (2013.01); *H04W 74/004* (2013.01); *H04W 74/0833* (2013.01); *H04W 74/0866* (2013.01); *H04W 84/12* (2013.01); *H04W 88/085* (2013.01); *H04W 88/12* (2013.01)

(58) **Field of Classification Search**

CPC H04W 72/0446; H04W 72/042; H04L

5/005; H04L 5/0053; H04L 5/0055; H04L 27/2602; H04J 11/00

See application file for complete search history.

(56)

References Cited

U.S. PATENT DOCUMENTS

8,761,115	B2	6/2014	Vrzic et al.
8,989,148	B2	3/2015	Vrzic et al.
2005/0058058	A1	3/2005	Cho et al.
2005/0063330	A1	3/2005	Lee et al.
2006/0105772	A1	5/2006	Khawand et al.
2007/0189205	A1	8/2007	Terry et al.
2008/0056193	A1	3/2008	Bourlas et al.
2008/0070610	A1	3/2008	Nishio
2008/0095185	A1	4/2008	DiGirolamo et al.
2008/0113684	A1	5/2008	Jung et al.
2008/0233992	A1	9/2008	Oteri et al.
2012/0063409	A1	3/2012	Novak et al.

FOREIGN PATENT DOCUMENTS

KR	1020070106435	A	11/2007
KR	1020070117928	A	12/2007
WO	1997038502	A2	10/1997
WO	2007091811	A1	8/2007

OTHER PUBLICATIONS

Notice of Allowance from Korean Application No. 10-2010-7025932, dated Apr. 7, 2015, Korean version, pp. 1-2.

Partial Search Report from European Application No. 09735501.0, dated Feb. 20, 2015, pp. 1-9.

“RACH Design for EUTRA”, Motorola, 3GPP TSG RAN1#43, Jan. 2006, pp. 1-11.

U.S. Appl. No. 12/989,044, filed Jun. 21, 2011, Sophie Vrzic.

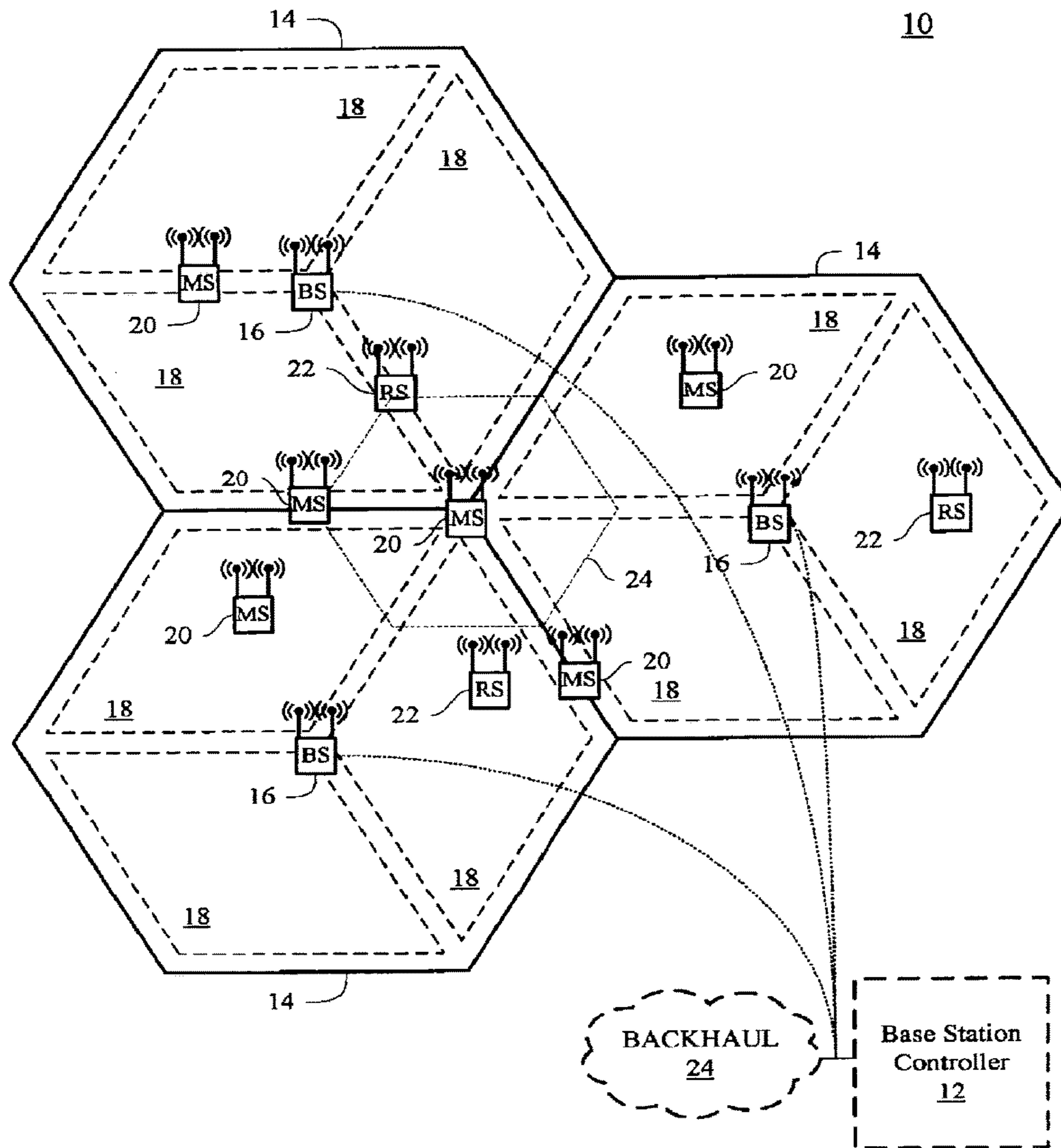
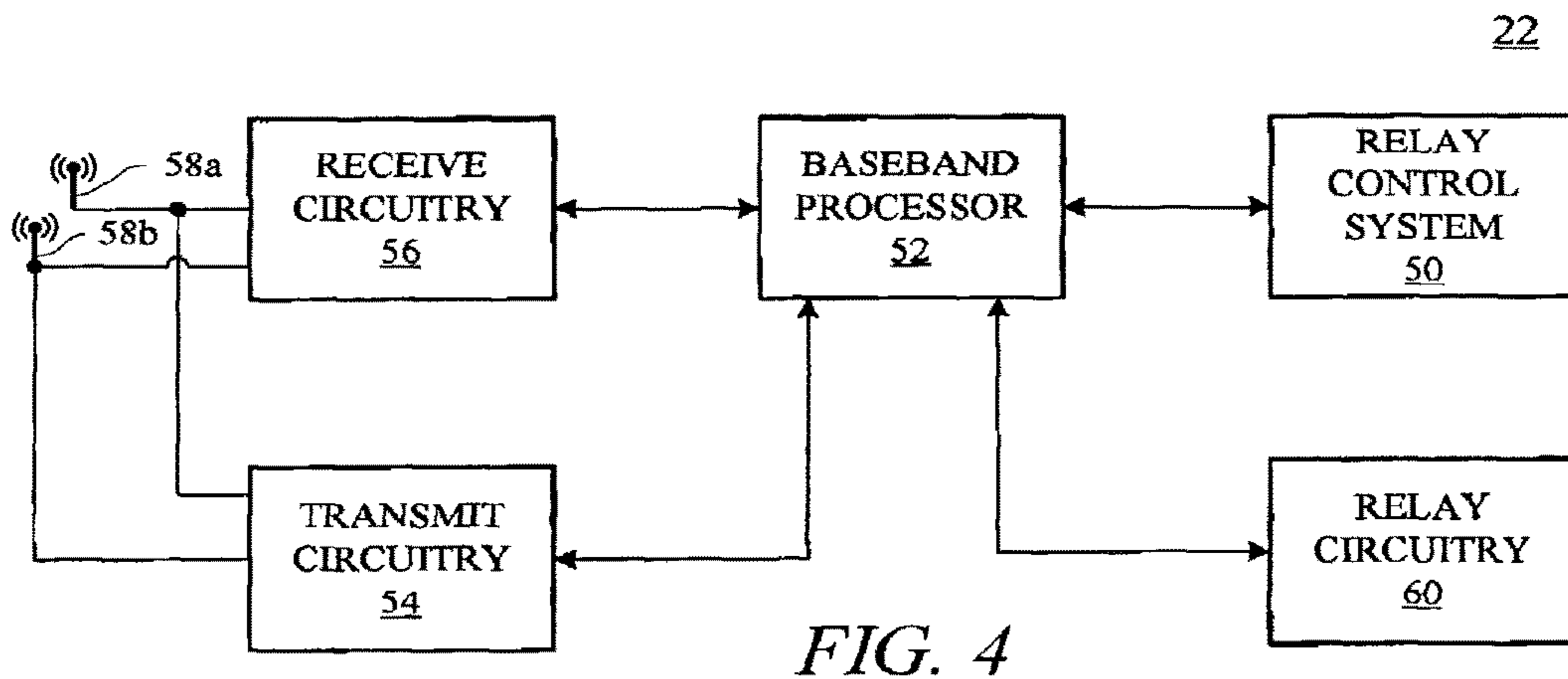
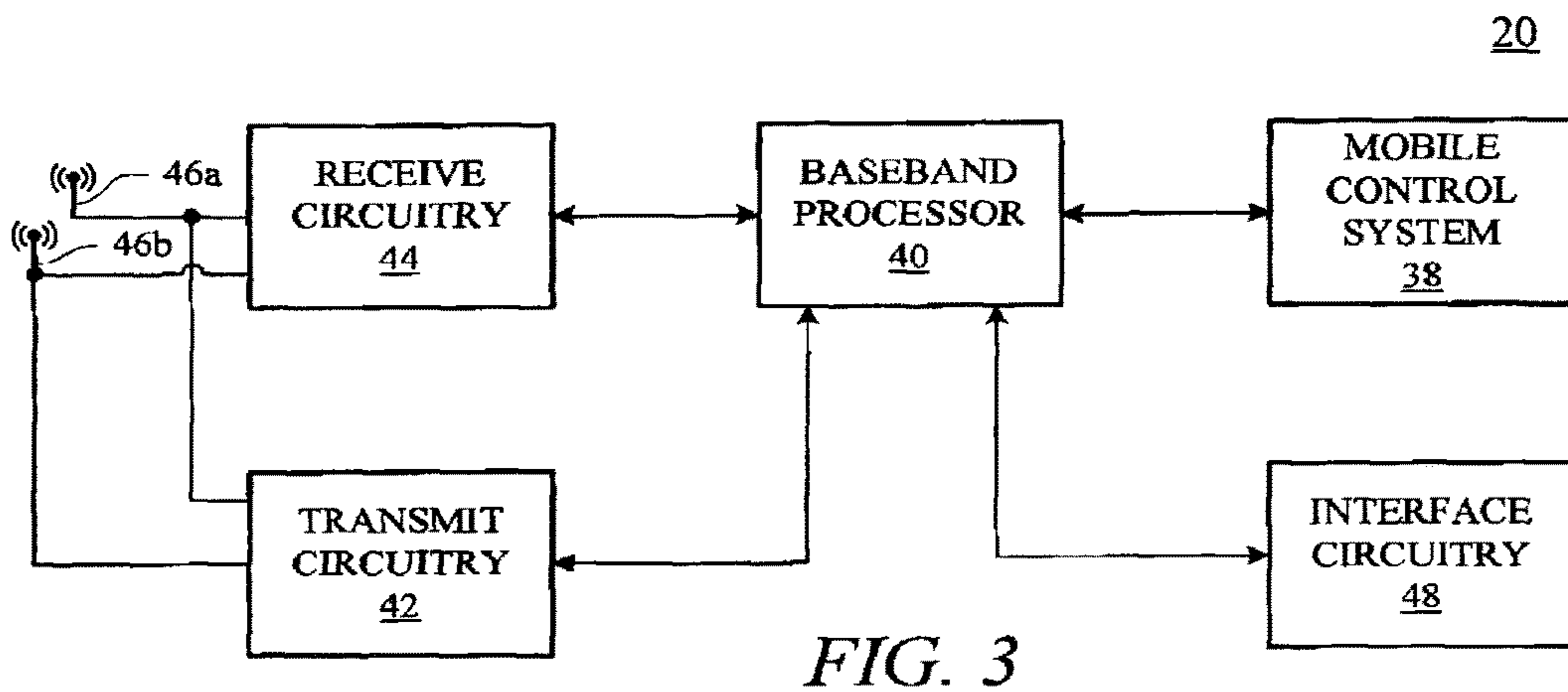
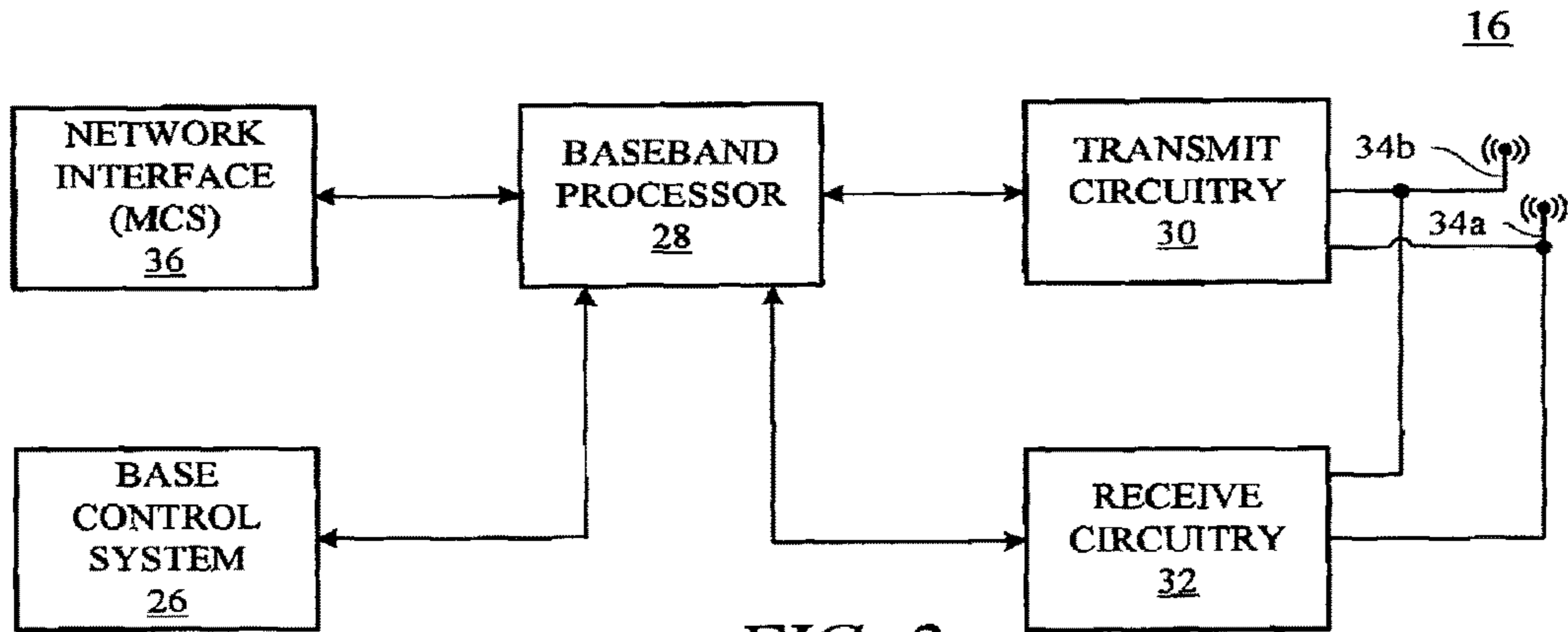

FIG. 1



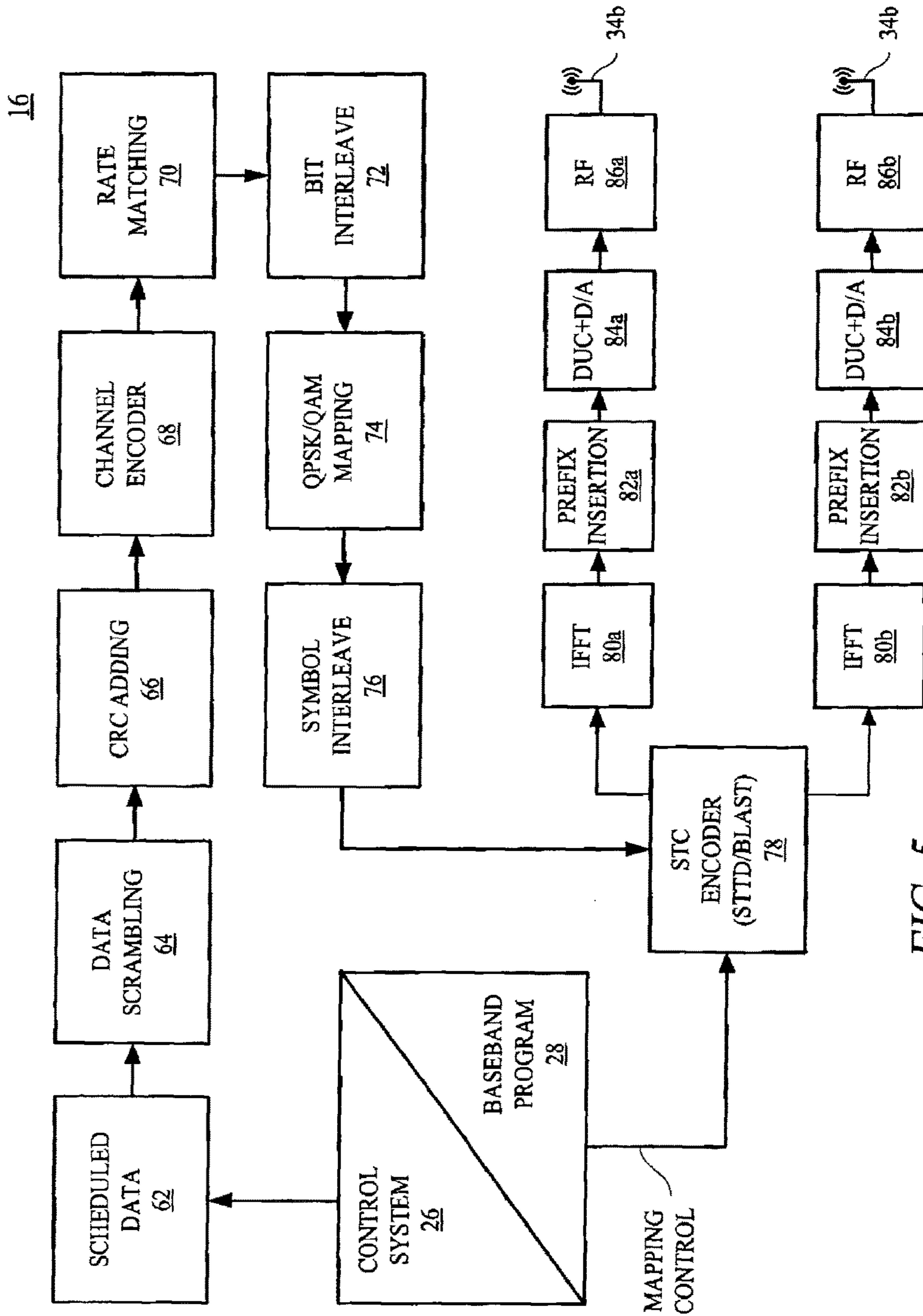

FIG. 5

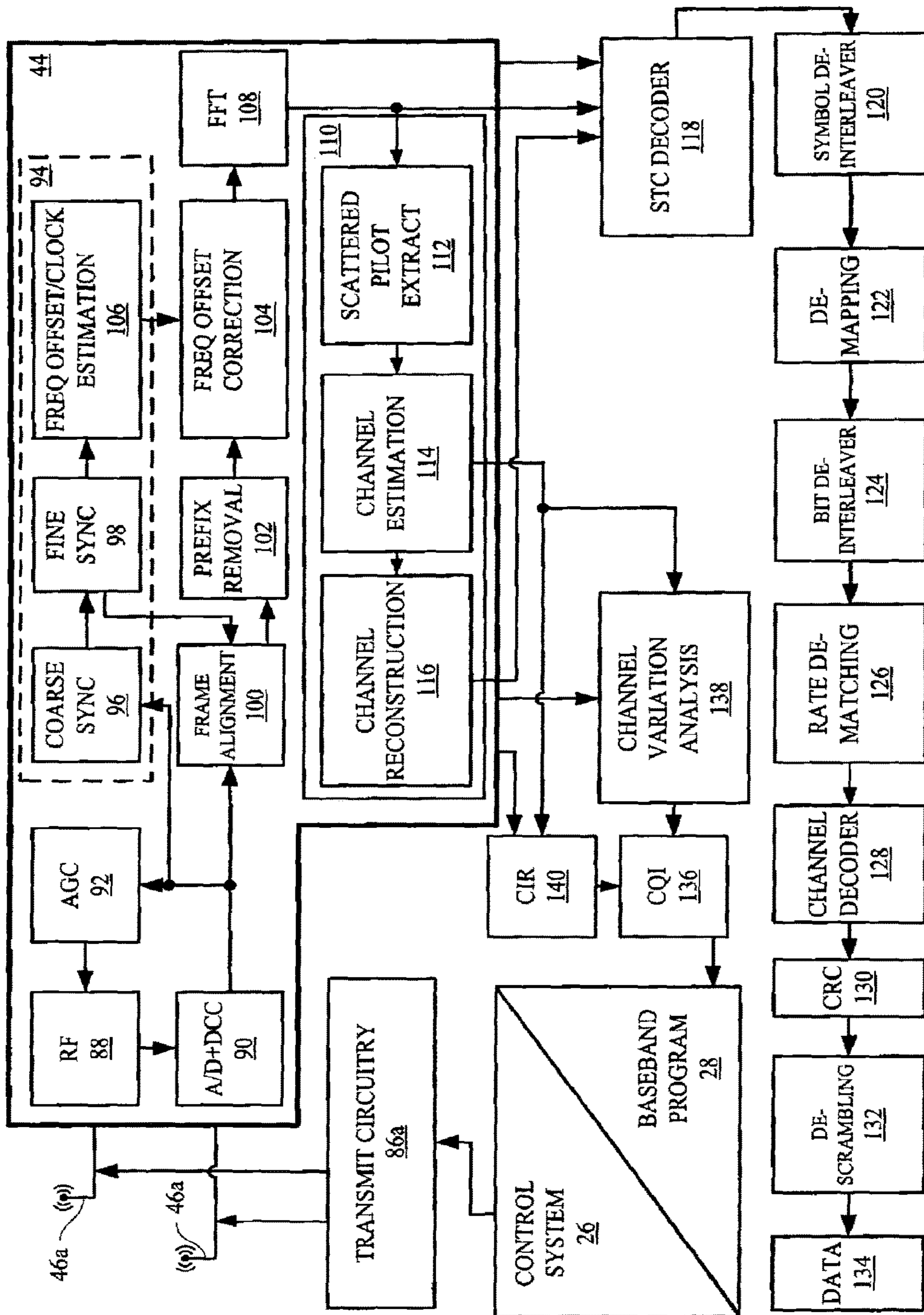

Fig. 6

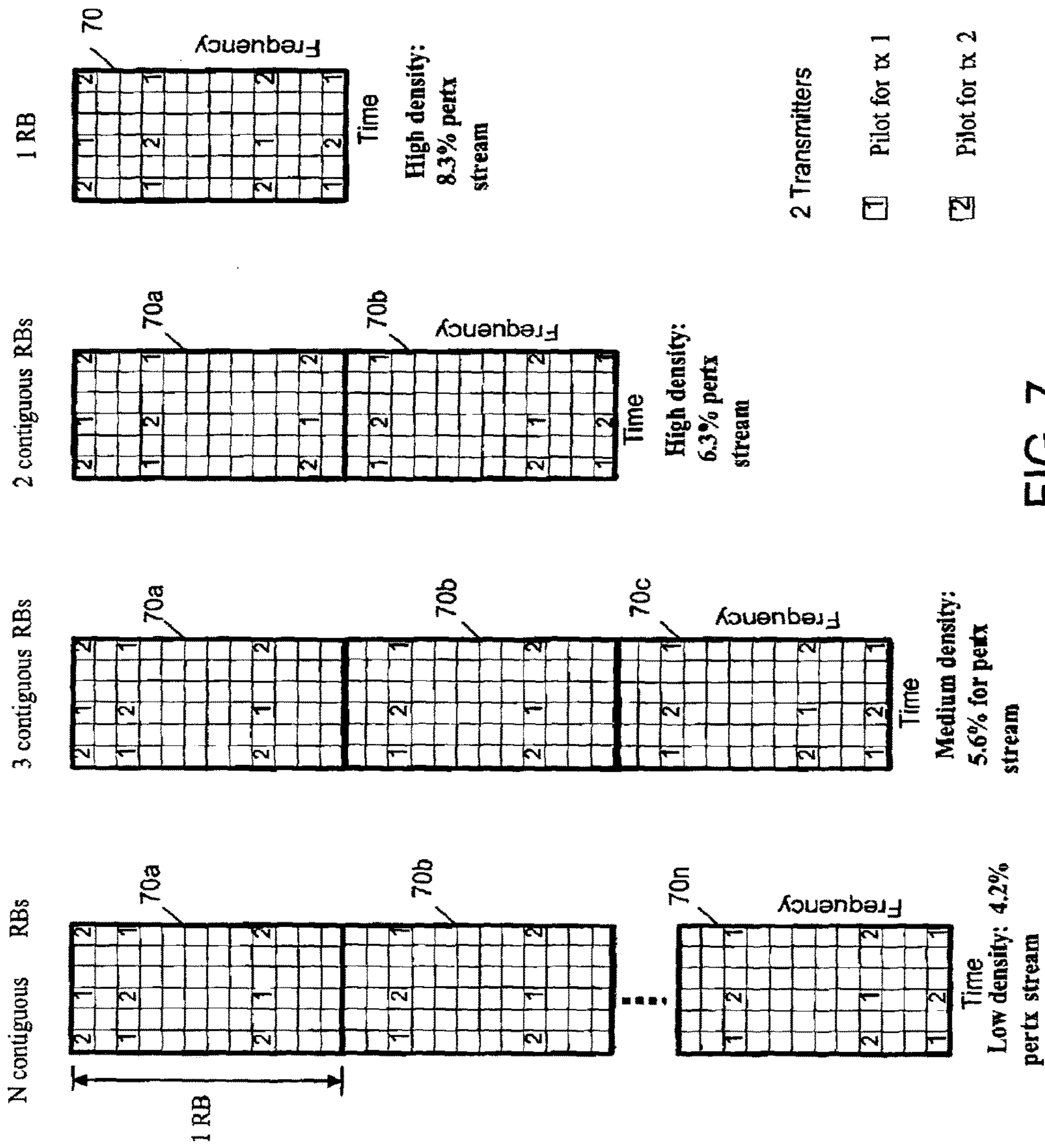
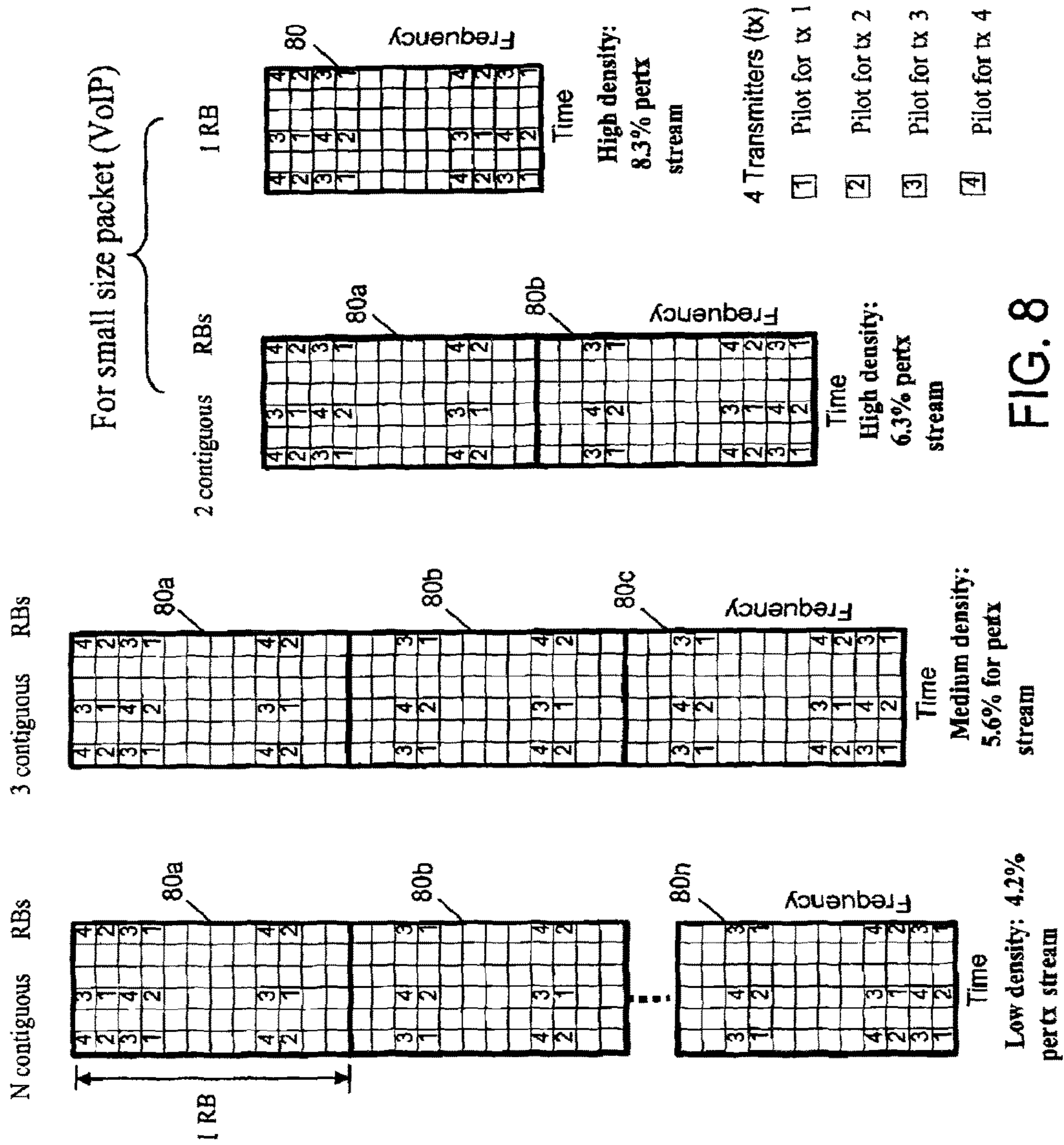

FIG. 7



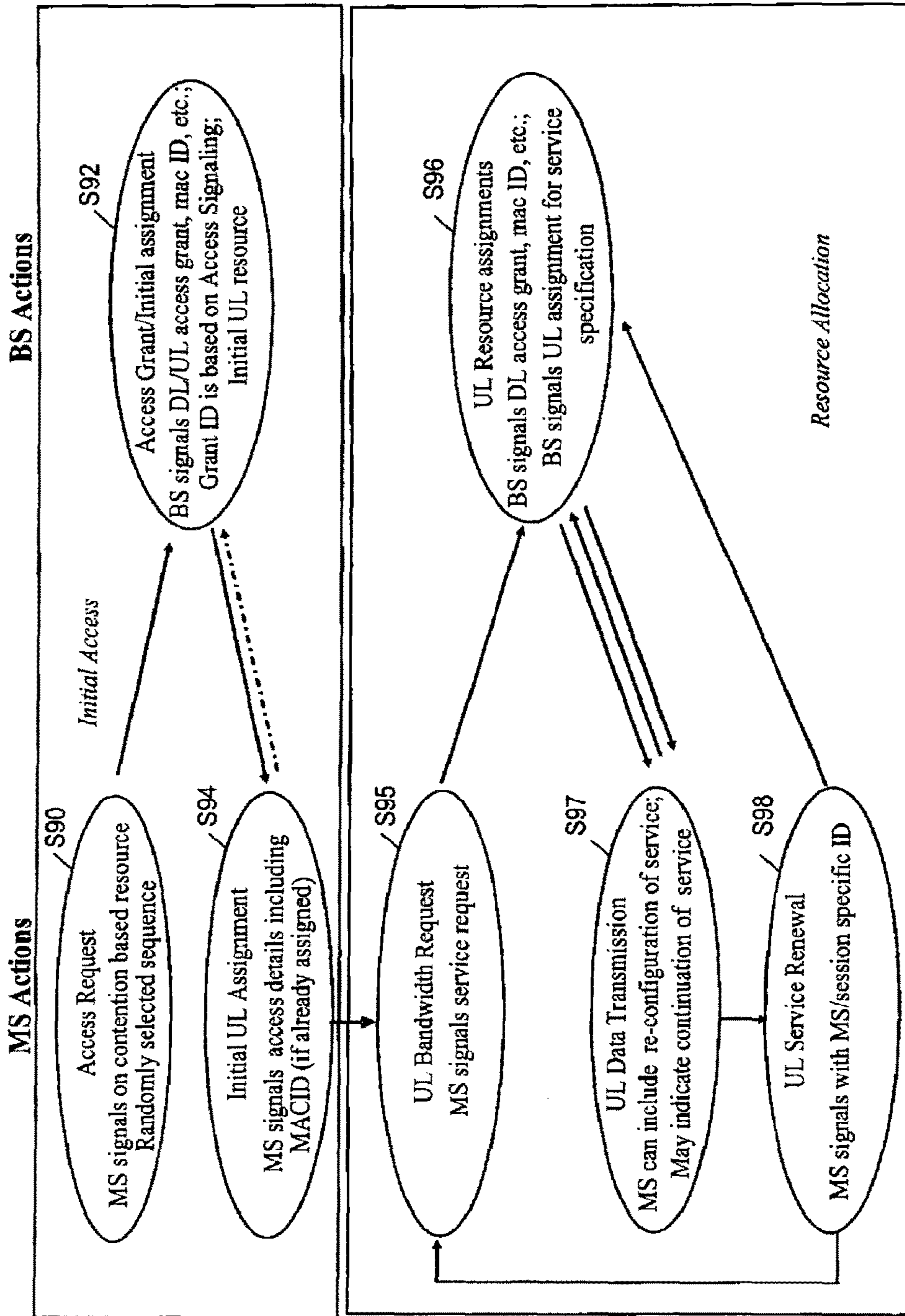

FIG. 9

UPLINK CONTROL IN A WIRELESS COMMUNICATION NETWORK

CROSS-REFERENCE TO RELATED APPLICATION

This invention is a continuation application of U.S. patent application Ser. No. 15/055,793, entitled "Uplink Control in a Wireless Communication Network", filed Feb. 29, 2016, issuing as U.S. Pat. No. 9,794,938 on Oct. 17, 2017, which is a continuation application of U.S. patent application Ser. No. 14/618,558, entitled "Uplink Control in a Wireless Communication Network", filed Feb. 10, 2015, now U.S. Pat. No. 9,277,569, which is a continuation of U.S. patent application Ser. No. 14/177,716, entitled "Method and System for Providing an Uplink Structure and Minimizing Pilot Signal Overhead in a Wireless Communication Network", filed Feb. 11, 2014, now U.S. Pat. No. 8,989,148, which is a continuation application of U.S. patent application Ser. No. 12/989,044, entitled "Method and System for Providing an Uplink Structure and Minimizing Pilot Signal Overhead in a Wireless Communication Network", filed Jun. 21, 2011, now U.S. Pat. No. 8,761,115, which is a submission under 35 U.S.C. 371 for U.S. National Stage Patent Application of International Application Number PCT/CA2009/000523, filed Apr. 21, 2009, which claims priority to U.S. Provisional Application No. 61/046,596, filed Apr. 21, 2008 and U.S. Provisional Application No. 61/050,303, filed May 5, 2008. All of the above-named applications are hereby incorporated by reference in their entireties as though fully and completely set forth herein.

The claims in the instant application are different than those of the parent application or other related applications. The Applicant therefore rescinds any disclaimer of claim scope made in the parent application or any predecessor application in relation to the instant application. The Examiner is therefore advised that any such previous disclaimer and the cited references that it was made to avoid, may need to be revisited. Further, any disclaimer made in the instant application should not be read into or against the parent application or other related applications.

FIELD OF THE INVENTION

The present invention relates to the field of wireless communications and more particularly to a method and system for providing an uplink control structure and a pilot signal that utilizes minimum overhead to provide channel estimation and data demodulation in the wireless communication network.

BACKGROUND OF THE INVENTION

Wireless communication networks, such as cellular networks, operate by sharing resources among the mobile terminals operating in the communication network. As part of the sharing process, one or more controlling devices allocate system resources relating to channels, codes, among other resources. Certain types of wireless communication networks, e.g., orthogonal frequency division multiplexed ("OFDM") networks, are used to support cell-based high speed services such as those under the IEEE 802.16 standards. The IEEE 802.16 standards are often referred to as WiMAX or less commonly as WirelessMAN or the Air Interface Standard.

OFDM technology uses a channelized approach and divides a wireless communication channel into many sub-

channels which can be used by multiple mobile terminals at the same time. These sub-channels can be subject to interference, which may cause data loss.

A system and method are needed for providing an uplink control structure and a pilot signal for obtaining channel information during uplink operations from the mobile terminals to the base station using minimum signal overhead. Existing systems do not employ uplink control structures. To the extent that pilot symbols are provided, the pilot symbols are arranged in a fixed pattern that is predefined for preselected resource block sizes. A system and method are proposed below that provide an uplink control structure and an efficient pilot signal having adaptive density and allocation design and which are scalable for different size resource blocks.

SUMMARY OF THE INVENTION

The invention advantageously provides a method and system for providing an uplink control structure and a pilot signal that utilizes minimum overhead to provide channel estimation and data demodulation in the wireless communication network.

A method is provided for uplink control in a wireless communication network, wherein the wireless communication network includes at least one base station that is communicatively coupled to at least one mobile terminal. A dedicated random access channel is provided to communicatively couple the base station and the mobile terminal so that the mobile terminal can select a random access signaling identification. A resource request is received at the base station to uplink resource information from the mobile terminal and an initial access information request is received from the mobile terminal to configure the base station connection.

The invention also provides a method of generating a low density pilot symbol pattern. A first resource block is provided having a first axis that defines a time domain and a second axis that defines a frequency domain, the first resource block having a predefined pilot symbol pattern, including boundary pilot symbols. A second resource block is provided having a third axis that defines a time domain and a fourth axis that defines a frequency domain; replicating the predefined pilot symbol pattern from the first resource block to the second resource block. The first resource block and the second resource block are concatenated to establish a first boundary line between the first resource block and the second resource block. Boundary pilot symbols are maintained in a first area of the first resource block, wherein the first area is positioned along the first axis at an end opposite to the first boundary line. The boundary pilot symbols are maintained in a second area of the second resource block, wherein the second area is positioned along the fourth axis at an end opposite to the first boundary line. Pilot symbols are deleted at the boundary between the first resource block and the second resource block adjacent to the first boundary line and spacing of the remaining pilot symbols is adjusted between the first area and the second area to provide uniform spreading of the pilot symbols.

The invention also provides a method of generating a high density pilot symbol pattern. A concatenated structure is provided that includes a first resource block having a first axis that defines a time domain and a second axis that defines a frequency domain, a second resource block having a third axis that defines a time domain and a fourth axis that defines a frequency domain, and a third resource block having a fifth

axis that defines a time domain and a sixth axis that defines a frequency domain, wherein a first boundary line is established between the first resource block and the second resource block and a second boundary line is established between the second resource block and the third resource block. A predefined pilot symbol pattern is provided within the concatenated structure, the predefined pilot symbol pattern includes first boundary pilot symbols provided in a first area of the first resource block that is positioned along the first axis at an end opposite to the first boundary line and second boundary pilot symbols provided in a second area of the third resource block that is positioned along the fifth axis at an end opposite to the second boundary line. The third resource block is deleted. Third boundary pilot symbols are provided in a third area of the second resource block that is positioned along the third axis at an end opposite the first boundary line and spacing of the pilot symbols is adjusted between the first area and the third area to provide uniform spreading of the pilot symbols.

BRIEF DESCRIPTION OF THE DRAWINGS

A more complete understanding of the present invention, and the attendant advantages and features thereof, will be more readily understood by reference to the following detailed description when considered in conjunction with the accompanying drawings wherein:

FIG. 1 is a block diagram of an exemplary cellular communication system constructed in accordance with the principles of the present invention;

FIG. 2 is a block diagram of an exemplary base station constructed in accordance with the principles of the present invention;

FIG. 3 is a block diagram of an exemplary mobile terminal constructed in accordance with the principles of the present invention;

FIG. 4 is a block diagram of an exemplary relay station constructed in accordance with the principles of the present invention;

FIG. 5 is a block diagram of a logical breakdown of an exemplary OFDM transmitter architecture constructed in accordance with the principles of the present invention;

FIG. 6 is a block diagram of a logical breakdown of an exemplary OFDM receiver architecture constructed in accordance with the principles of the present invention;

FIG. 7 illustrates resource blocks having uplink pilot designs for two transmitter systems in accordance with the principles of the present invention;

FIG. 8 illustrates resource blocks having uplink pilot designs for four transmitter systems in accordance with the principles of the present invention;

FIG. 9 illustrates a flow diagram of the mobile terminal access and uplink resource allocation in accordance with the principles of the present invention.

DETAILED DESCRIPTION OF THE INVENTION

As an initial matter, while certain embodiments are discussed in the context of wireless networks operating in accordance with the IEEE 802.16 broadband wireless standard, which is hereby incorporated by reference, the invention is not limited in this regard and may be applicable to other broadband networks including those operating in accordance with other OFDM orthogonal frequency division (“OFDM”)-based systems, including the 3rd Generation Partnership Project (“3GPP”) and 3GPP2 evolutions. Simi-

larly, the present invention is not limited solely to OFDM-based systems and can be implemented in accordance with other system technologies, e.g., CDMA.

Referring now to the drawing figures in which like reference designators refer to like elements, there is shown in FIG. 1, an exemplary communication system 10 is provided in accordance with the principles of the present invention. Communication system 10 includes a base station controller (“BSC”) 12 which controls wireless communications within multiple cells 14, which cells are served by corresponding base stations (“BS”) 16. In some configurations, each cell is further divided into multiple sectors 18 or zones (not shown). In general, each base station 16 facilitates communications using orthogonal frequency division multiplexing (“OFDM”) with mobile and/or mobile terminals 20, which are within the cell 14 associated with the corresponding base station 16. The movement of the mobile terminals 20 in relation to the base stations 16 results in significant fluctuation in channel conditions. As illustrated, the base stations 16 and mobile terminals 20 may include multiple antennas to provide spatial diversity for communications. In some configurations, relay stations 22 may assist in communications between base stations 16 and mobile terminals 20. Mobile terminals 20 can be handed off from any cell 14, sector 18, zone (not shown), base station 16 or relay 22 to another cell 14, sector 18, zone (not shown), base station 16 or relay 22. In some configurations, base stations 16 communicate with each other and with another network (such as a core network or the internet, both not shown) over a backhaul network 24. In some configurations, a base station controller 12 is not needed.

With reference to FIG. 2, an example of a base station 16 is illustrated. The base station 16 generally includes a base control system 26, e.g., a CPU, a baseband processor 28, transmit circuitry 30, receive circuitry 32, multiple antennas 34a, 34b and a network interface 36. The receive circuitry 32 receives radio frequency signals bearing information through a receive antenna 34a from one or more remote transmitters provided by mobile terminals 20 (illustrated in FIG. 3) and relay stations 22 (illustrated in FIG. 4). A low noise amplifier and a filter (not shown) may cooperate to amplify and remove broadband interference from the signal for processing. Down-conversion and digitization circuitry (not shown) down-convert the filtered, received signal to an intermediate or baseband frequency, signal, which is digitized into one or more digital streams.

The baseband processor 28 processes the digitized received signal to extract the information or data bits conveyed in the received signal. This processing typically comprises demodulation, decoding, and error correction operations. As such, the baseband processor 28 is generally implemented in one or more digital signal processors (“DSPs”) and/or application-specific integrated circuits (“ASICs”). The received information is sent across a wireless network via the network interface 36 or transmitted to another mobile terminal 20 serviced by the base station 16, either directly or with the assistance of a relay 22.

On the transmit side, the baseband processor 28 receives digitized data, which may represent voice, data, or control information, from the network interface 36 under the control of the base control system 26, and encodes the data for transmission. The encoded data is output to the transmit circuitry 30, where it is modulated by one or more carrier signals having a desired transmit frequency or frequencies. A power amplifier (not shown) amplifies the modulated carrier signals to a level appropriate for transmission, and delivers the modulated carrier signals to the transmit anten-

nas **34b** through a matching network (not shown). Modulation and processing details are described in greater detail below.

With reference to FIG. 3, an example of a mobile terminal **20** is illustrated. Similarly to the base station **16**, the mobile terminal **20** includes a mobile control system **38**, e.g. a CPU, a baseband processor **40**, transmit circuitry **42**, receive circuitry **44**, multiple antennas **46a**, **46b** and user interface circuitry **48**. The receive circuitry **44** receives radio frequency signals bearing information through a receive antenna **46a** from one or more base stations **16** and relays **22**. A low noise amplifier and a filter (not shown) may cooperate to amplify and remove broadband interference from the signal for processing. Down-conversion and digitization circuitry (not shown) down-convert the filtered, received signal to an intermediate or baseband frequency signal, which is digitized into one or more digital streams.

The baseband processor **40** processes the digitized received signal to extract the information or data bits conveyed in the received signal. This processing typically comprises demodulation, decoding, and error correction operations. The baseband processor **40** is generally implemented in one or more DSPs and/or ASICs.

For transmission, the baseband processor **40** receives digitized data, which may represent voice, video, data, or control information, from the mobile control system **38**, which it encodes for transmission. The encoded data is output to the transmit circuitry **42**, where it is used by a modulator to modulate one or more carrier signals at a desired transmit frequency or frequencies. A power amplifier (not shown) amplifies the modulated carrier signals to a level appropriate for transmission, and delivers the modulated carrier signal to the transmit antennas **46b** through a matching network (not shown). Various modulation and processing techniques available to those skilled in the art are used for signal transmission between the mobile terminal and the base station, either directly or via the relay station.

In OFDM modulation, the transmission band is divided into multiple, orthogonal carrier waves. Each carrier wave is modulated according to the digital data to be transmitted. Because OFDM divides the transmission band into multiple carriers, the bandwidth per carrier decreases and the modulation time per carrier increases. Since the multiple carriers are transmitted in parallel, the transmission rate for the digital data, or symbols, on any given carrier is lower than when a single carrier is used.

OFDM modulation utilizes the performance of an Inverse Fast Fourier Transform (“IFFT”) on the information to be transmitted. For demodulation, the performance of a Fast Fourier Transform (“FTT”) on the received signal recovers the transmitted information. In practice, the IFFT and FFT are provided by digital signal processing carrying out an Inverse Discrete Fourier Transform (“IDFT”) and Discrete Fourier Transform (“DFT”), respectively. Accordingly, the characterizing feature of OFDM modulation is that orthogonal carrier waves are generated for multiple bands within a transmission channel. The modulated signals are digital signals having a relatively low transmission rate and capable of staying within their respective bands. The individual carrier waves are not modulated directly by the digital signals. Instead, all carrier waves are modulated at once by IFFT processing.

In operation, OFDM is preferably used for at least downlink transmission from the base stations **16** to the mobile terminals **20**. Each base station **16** is equipped with “n” transmit antennas **34b** ($n \geq 1$), and each mobile terminal **20** is equipped with “m” receive antennas **46a** ($m \geq 1$). Notably,

the respective antennas can be used for reception and transmission using appropriate duplexers or switches and are so labeled only for clarity.

When relay stations **22** are used, OFDM is preferably used for downlink transmission from the base stations **16** to the relays **22** and from relay stations **22** to the mobile terminals **20**.

With reference to FIG. 4, an example of a relay station **22** is illustrated. Similarly to the base station **16**, and the mobile terminal **20**, the relay station **22** includes a relay control system **50**, e.g. a CPU, a baseband processor **52**, transmit circuitry **54**, receive circuitry **56**, multiple antennas **58a**, **58b** and relay circuitry **60**. The relay circuitry **60** enables the relay **22** to assist in communications between a base station **16** and mobile terminals **20**. The receive circuitry **56** receives radio frequency signals bearing information through a receive antenna **58a** from one or more base stations **16** and mobile terminals **20**. A low noise amplifier and a filter (not shown) may cooperate to amplify and remove broadband interference from the signal for processing. Down-conversion and digitization circuitry (not shown) down-convert the filtered, received signal to an intermediate or baseband frequency signal, which is digitized into one or more digital streams.

The baseband processor **52** processes the digitized received signal to extract the information or data bits conveyed in the received signal. This processing typically comprises demodulation, decoding, and error correction operations. The baseband processor **52** is generally implemented in one or more DSPs and/or ASICs.

For transmission, the baseband processor **52** receives digitized data, which may represent voice, video, data, or control information, from the relay control system **50**, which it encodes for transmission. The encoded data is output to the transmit circuitry **54**, where it is used by a modulator to modulate one or more carrier signals that is at a desired transmit frequency or frequencies. A power amplifier (not shown) will amplify the modulated carrier signals to a level appropriate for transmission, and deliver the modulated carrier signal to the transmit antenna **58b** through a matching network (not shown). Various modulation and processing techniques available to those skilled in the art are used for signal transmission between the mobile terminal **20** and the base station **16**, either directly or indirectly via a relay station **22**, as described above.

With reference to FIG. 5, a logical OFDM transmission architecture is provided. Initially, the base station controller **12** (See FIG. 1) sends data destined for transmission to various mobile terminals **20** to the base station **16**, either directly or with the assistance of the relay station **22**. The base station **16** may use channel quality indicators (“CQIs”) associated with the mobile terminals **20** to schedule the data for transmission as well as select appropriate coding and modulation for transmitting the scheduled data. The CQIs may be obtained directly from the mobile terminals **20** or may be determined at the base station **16** using information provided by the mobile terminals **20**. In either case, the CQI for each mobile terminal **20** is a function of the degree to which the channel amplitude (or response) varies across the OFDM frequency band.

The scheduled data **62**, which is a stream of bits, is scrambled in a manner that reduces the peak-to-average power ratio associated with the data using data scrambling logic **64**. A cyclic redundancy check (“CRC”) for the scrambled data is determined and appended to the scrambled data using CRC adding logic **66**. Channel coding is performed using channel encoder logic **68** to effectively add

redundancy to the data to facilitate recovery and error correction at the mobile terminal **20**. Again, the channel coding for a particular mobile terminal **20** is based on the CQI. In some implementations, the channel encoder logic **68** uses known Turbo encoding techniques. The encoded data is processed by rate matching logic **70** to compensate for the data expansion associated with encoding.

The hit interleaver logic **72** systematically reorders the bits in the encoded data to minimize the loss of consecutive data bits. The resultant data bits are systematically mapped into corresponding symbols depending on the chosen base-band modulation by mapping logic **74**. Preferably, Quadrature Amplitude Modulation (“QAM”) or Quadrature Phase Shift Key (“QPSK”) modulation is used. The degree of modulation is preferably chosen based on the CQI for the particular mobile terminal **20**. The symbols may be systematically reordered to further bolster the immunity of the transmitted signal to periodic data loss caused by frequency selective fading using symbol interleaver logic **76**.

At this point, groups of bits are mapped into symbols representing locations in an amplitude and phase constellation. When spatial diversity is desired, blocks of symbols are processed by space-time block code (“STC”) encoder logic **78**, which modifies the symbols in a fashion making the transmitted signals more resistant to interference and more readily decoded at the mobile terminal **20**. The STC encoder logic **78** processes the incoming symbols and provide “n” outputs corresponding to the number of transmit antennas **34b** for the base station **16**. The base control system **26** and/or baseband processor **28**, as described above with respect to FIG. **2**, provide a mapping control signal to control SIC encoding. At this point, assume the symbols for the “n” outputs are representative of the data to be transmitted and are capable of being recovered by the mobile terminal **20**.

For the present example, assume the base station **16** has two transmit antennas **32b** ($n=2$) and the SIC encoder logic **78** provides two output streams of symbols. Accordingly, each of the symbol streams that are output by the SIC encoder logic **78** is sent to a corresponding IFFT processor **80a**, **80b** (referred to collectively herein as IFFT **80**), illustrated separately for ease of understanding. Those skilled in the art will recognize that one or more processors may be used to provide such digital signal processing, alone or in combination with other processing described herein. The IFFT processors **80** preferably operate on the respective symbols to provide an inverse Fourier Transform. The output of the IFFT processors **80** provides symbols in the time domain. The time domain symbols are grouped into frames, which are associated with a prefix-by-prefix insertion logic **82a**, **82b** (referred to collectively herein as prefix insertion **82**). Each of the resultant signals is up-converted in the digital domain to an intermediate frequency and converted to an analog signal via the corresponding digital up-conversion (“MX”) and digital-to-analog (“D/A”) conversion circuitry **84a**, **84b** (referred to collectively herein as DUC+D/A **84**). The resultant (analog) signals are simultaneously modulated at the desired RE frequency, amplified, and transmitted via the RF circuitry **86a**, **86b** (referred to collectively herein as RF circuitry **86**) and antennas **34b**. Notably, pilot signals known by the intended mobile terminal **16** are scattered among the sub-carriers. The mobile terminal **16**, which is discussed in detail below, uses the pilot signals for channel estimation.

Reference is now made to FIG. **6** to illustrate reception of the transmitted signals by a mobile terminal **20**, either directly from base station **16** or with the assistance of relay

22. Upon arrival of the transmitted signals at each of the antennas **46a** of the mobile terminal **20**, the respective signals are demodulated and amplified by corresponding RF circuitry **88**. For the sake of conciseness and clarity, only one of the two receive paths is described and illustrated in detail. Analog-to-digital (A/D) converter and down-conversion circuitry **90** digitizes and down-converts the analog signal for digital processing. The resultant digitized signal may be used by automatic gain control circuitry (AGC) **92** to control the gain of the amplifiers in the RF circuitry **88** based on the received signal level.

Initially, the digitized signal is provided to synchronization logic **94**, which includes coarse synchronization logic **96**, which buffers several OFDM symbols and calculates an auto-correlation between the two successive OFDM symbols. A resultant time index corresponding to the maximum of the correlation result determines a fine synchronization search window, which is used by fine synchronization logic **98** to determine a precise framing starting position based on the headers. The output of the fine synchronization logic **98** facilitates frame acquisition by frame alignment logic **100**. Proper framing alignment is important so that subsequent FFT processing provides an accurate conversion from the time domain to the frequency domain. The fine synchronization algorithm is based on the correlation between the received pilot signals carried by the headers and a local copy of the known pilot data. Once frame alignment acquisition occurs, the prefix of the OFDM symbol is removed with prefix removal logic **102** and resultant samples are sent to frequency offset correction logic **104**, which compensates for the system frequency offset caused by the unmatched local oscillators in the transmitter and the receiver. Preferably, the synchronization logic **94** includes frequency offset and clock estimation logic **106**, which is based on the headers to help estimate such effects on the transmitted signal and provide those estimations to the correction logic **104** to properly process OFDM symbols.

At this point, the OFDM symbols in the time domain are ready for conversion to the frequency domain using HT processing logic **108**. The results are frequency domain symbols, which are sent to processing logic **110**. The processing logic **110** extracts the scattered pilot signal using scattered pilot extraction logic **112**, determines a channel estimate based on the extracted pilot signal using channel estimation logic **114**, and provides channel responses for all sub-carriers using channel reconstruction logic **116**. In order to determine a channel response for each of the sub-carriers, the pilot signal is essentially multiple pilot symbols that are scattered among the data symbols throughout the OFDM sub-carriers in a known pattern in both time and frequency.

FIGS. **7** and **8** illustrate resource blocks (“RBs”) **70**, **70a-70n**, **80**, **80a-80n** (hereinafter “RB **70,80**”) having uplink pilot designs. The RB **70,80** include pilot symbols arranged in patterns according to embodiments of the invention. An RB is defined as a smallest unit for channelization and is used mostly for small packet transmission (VoIP). The RB may be configured in various sizes such as 12×6 , 18×6 , and 6×4 , among other sizes. A basic channel unit (BCU) is the smallest unit of assignment for channelization. The pilot symbol patterns are arranged in the RB **70,80** to include a boundary pilot pattern and an adaptive density and allocation pattern. The RB **70,80** includes a horizontal axis that represents time and a vertical axis that represents frequency. The pilot symbol patterns are employed for channel estimation, data demodulation, and sounding, among other purposes. The pilot symbol patterns for a contiguous resource

region may include a scattered pilot symbol pattern and pilot symbols allocated at boundaries of the resource region.

FIGS. 7 and 8 illustrate multiple RB configurations having pilot symbol patterns with different density configurations for a two transmitter system and a four transmitter system, respectively. The pilot symbol density and pilot symbol pattern may be configured in time and frequency to accommodate different contiguous resource sizes. The pilot symbol for the first transmitter is identified by "1," the pilot symbol for the second transmitter is identified by "2," the pilot symbol for the third transmitter is identified by "3," the pilot symbol for the fourth transmitter is identified by "4." The RB 70,80 includes areas for pilot symbols and areas for data signals. The invention seeks to reduce RB 70,80 overhead by maximizing area (e.g., resources) for data signals and reducing area for pilot symbols. Additionally, the uplink pilot design for a diversity zone and a localized zone may be unified by designing pilot structures based on adaptive density and allocation. Pilot symbol patterns having different density values may be generated for different numbers of contiguous RBs 70,80. The pilot symbol pattern and density value may be chosen based on the size of the contiguous resource and a multi-antenna transmission and reception (MIMO) mode.

According to embodiments illustrated in FIGS. 7 and 8, pilot symbol patterns may be generated with different density values for multiple contiguous RBs 70,80. A stand alone RB 70,80 having a high density pilot symbol pattern may be coupled with other RBs 70,80 to provide a low density pilot symbol pattern. The pilot symbol pattern for a stand alone RB 70,80 may include pilot symbols allocated on the boundary to form a highest density pilot symbol pattern. The stand alone RB pilot pattern may be extended to a pilot pattern for two RBs 70,80, which provides a lower density pilot symbol pattern. The two stand alone RBs 70,80 may be concatenated, either in frequency or in time. In order to reduce pilot symbol pattern density, redundant pilot symbols may be eliminated at the boundary between two RBs 70,80. The spacing of the pilot symbols may be adjusted in frequency and/or in time to provide uniform spreading of pilot symbols. This method may be used to extend pilot symbol patterns to multiple RBs 70,80. As the number of contiguous RBs 70,80 increase, the pilot symbol density pattern for the RBs 70,80 may change from a high density pattern to a low density pattern. The total pilot symbol spacing may be adjusted in the frequency and time directions to remain smaller than pre-defined maximum values.

According to an alternative embodiment, a number of contiguous RBs 70,80 may be provided that collectively include a low density pilot symbol pattern. In this case, the contiguous RBs 70,80 may be transformed to a stand alone RB 70,80 having a high density pilot symbol pattern. Pilot symbols may be uniformly allocated in frequency and time, with maximum pilot spacing provided for N RBs (usually $N > 3$). Boundary pilot symbols may be allocated in time and frequency to minimize extrapolation. The N RBs 70,80 may be reduced to $N-1$ RBs 70,80 by maintaining a pilot symbol pattern having boundary pilot symbols. Pilot symbol spacing may be adjusted to uniformly spread the pilot symbols in the time and frequency directions. In this case, the pilot symbol density for the RBs 70,80 may change from low density pattern to a high density pattern. This process may continue until single RB 70,80 remains having a high pilot symbol density.

FIGS. 7 and 8 illustrate several pilot symbol density patterns. A low density pilot symbol pattern ($3.1\% < \text{density} < 5.3\%$ for one transmitter) may be realized for more than

one contiguous BCU, more than 3 contiguous RBs, or for more than one sub frame. A medium density pilot symbol pattern (density 5.6% for one transmitter) may be realized for one BCU or 3 contiguous RBs. A high density pilot symbol pattern ($6.3\% < \text{density} < 8.3\%$) may be realized for less than 3 RBs. The high density pilot symbol pattern may be used, for example, for VoIP transmission. The invention enables the pilot symbol pattern to adjust in time and frequency based on the size of contiguous RBs 70,80.

Referring again to FIG. 6, the processing logic 110 compares the received pilot symbols with the expected pilot symbols in certain sub-carriers at certain times to determine a channel response for the sub carriers in which pilot symbols were transmitted. The results may be interpolated to estimate a channel response for the remaining sub-carriers for which pilot symbols are not provided. The actual and interpolated channel responses may be used to estimate an overall channel response, which includes the channel responses for the sub-carriers in the OFDM channel.

The frequency domain symbols and channel reconstruction information, which are derived from the channel responses for each receive path are provided to an STC decoder 118, which provides STC decoding on both received paths to recover the transmitted symbols. The channel reconstruction information provides equalization information to the STC decoder 118 sufficient to remove the effects of the transmission channel when processing the respective frequency domain symbols.

The recovered symbols are placed back in order using symbol de-interleaver logic 120, which corresponds to the symbol interleaves logic 76 of the base station 16 transmitter. The de-interleaved symbols are then demodulated or de-mapped to a corresponding bit stream using de-mapping logic 122. The bits are then de-interleaved using bit de-interleaver logic 124, which corresponds to the bit interleaver logic 72 of the base station 16 transmitter architecture. The de-interleaved bits are then processed by rate de-matching logic 126 and presented to channel decoder logic 128 to recover the initially scrambled data and the CRC checksum. Accordingly, the CRC logic 130 removes the CRC checksum, checks the scrambled data in traditional fashion, and provides it to the de-scrambling logic 132 for descrambling using the known base station de-scrambling code to recover the originally transmitted data 134.

While recovering the data 134, a CQI 136 or at least information sufficient to create a CQI at the base station 16 is determined by channel variation analysis logic 138 and transmitted to the base station 16. As noted above, the CQI 134 may be a function of the carrier-to-interference ratio ("CIR") 140, as well as the degree to which the channel response varies across the various sub-carriers in the OFDM frequency band. For this embodiment, the channel gain for each sub-carrier in the OFDM frequency band used to transmit information is compared relative to one another to determine the degree to which the channel gain varies across the OFDM frequency band. Although numerous techniques are available to measure the degree of variation, one technique is to calculate the standard deviation of the channel gain for each sub-carrier throughout the OFDM frequency band being used to transmit data.

According to one embodiment, the invention provides an uplink control structure for OFDM systems that enables mobile terminals 20 to communicate with the base stations 16. The control structure includes an uplink acknowledge (UL ACK) channel and a dedicated control channel that feeds information back, such as channel quality indicator (CQI) information, pre-coding matrix index (PMI) informa-

tion and rank information, among other information. According to one embodiment, the mobile terminals **20** may employ the UL ACK channel for initial access to the OFDM system, for bandwidth requests, to trigger continuation of negotiated service, and for proposed allocation of a re-configuration header, among other purposes.

A fixed number of resources may be allocated for the UL ACK channels. A set of ACK channels is defined for all unicast assignments and a separate set of ACK channels is defined for group assignments. The ACK channels that are used for a given packet transmission are determined by the partition number and the layer. The ACK signals are transmitted over several ACK tiles, where an ACK tile is defined as a group of contiguous tones or sub-carriers. The value of the ACK signals may be determined by either non-coherent detection or coherent detection. An orthogonal spreading code may be used to multiplex multiple ACK signals onto the same ACK tile.

An uplink (“UL”) control channel structure supports ACK channels for both unicast assignments and group assignments. The UL control channel structure also supports multiple ACKs for different packets that are transmitted on the same resources, as in multi-codeword MIMO (“MCW-MIMO”) or multi-user MIMO (“MU-MIMO”). The UL control channel also provides feedback for frequency selective scheduling and pre-coding, including for simple diversity assignments.

A fixed number of resources may be allocated for the UL dedicated control channel. The resources are divided into UL control tiles, wherein the number of tiles allocated to a user depends on the amount of feedback requested. The allocated tiles may be spread over the band to obtain frequency diversity. The UL control information is CRC protected and is scrambled by the user ID. The content of the information can change each feedback instance to accommodate event driven control information such as a bandwidth request.

A UL random access (“RA”) channel may be provided to enable the user to initially gain access to the system through one of several physical control structures. According to one embodiment, the UL random access channel is a designated resource. The UL random access channel may be a contention based channel for multiple mobile terminals **20** to request access/bandwidth. A designated resource may be allocated for these access requests. The access request may be spread or repeated across the resources that are used exclusively for random access and bandwidth requests. The mobile station **20** may randomly select from one sequence and location if multiple possibilities are available.

According to one embodiment, the mobile terminal **20** may randomly select from one of L sequences, which spans N RBs **70,80**. Alternatively, the sequence length L may be chosen to confine a full sequence within an RB **70,80**. By confining the spreading sequence to one RB **70,80**, the spreading sequences maintain orthogonality as the RB **70,80** is virtually frequency flat as the RB contains physical contiguous tones. The spreading sequences may be repeated in each RB **70,80** to gain diversity.

If many resources are assigned for uplink control, the resources may be divided into M time-frequency blocks for random access. In this case, the number of distinct codes/resource per sub frame is LM , where the value of M may be dynamically specified by the base station **16**. In some embodiments, a sub-frame within a superframe (or otherwise specified as set of F frames) is also randomly selected, wherein the number of distinct codes/resource/sub frames per superframe is defined as LMF .

Another physical control structure includes overlaying the random access requests with UL control signals. The access request may be spread or repeated across the resources used for uplink control, such as CQI, among other uplink control. The mobile terminal **20** may randomly select from one sequence and location if multiple possibilities are available. For example, the mobile terminal **20** may randomly select from one of L sequences, where L is less than or equal to the RB size. By confining the spreading sequence to one RB **70,80**, the spreading sequences maintain orthogonality as the RB **70,80** is virtually frequency flat as the RB **70,80** includes physical contiguous tones or sub-carriers. The length- L sequence is completely repeated on each of the N RBs **70,80**. Coherent combining of each sequence repetition may improve detection at the base station **16**.

While overlaying the RA request and UL signals, the resources may be divided into M time-frequency blocks for random access if many resources are assigned for uplink control. A number of distinct codes or resources per frame is LM . The values of N and M may be dynamically specified by the base station **16**. In some embodiments, a sub-frame within the superframe (or otherwise specified as a set of F frames) is also randomly selected. In some embodiments, the sequences span the N RBs **70,80**. The sequence length in these cases is LN and the number of distinct codes or resource per sub frame is $LN M$.

In some embodiments, the L sequences are an orthogonal set of spreading sequences, wherein the L -sequences may be divided into two types of indications. A first type includes a system access request without a previously assigned mobile terminal ID and a second type includes a system access request with an assigned mobile terminal ID. If a mobile terminal **20** is provided access to the system, a down link (DL) control segment access grant may be scrambled by the sequence/resource block ID. The base station **16** may attempt interference cancellation to remove the RA channel from UL control.

Another physical control structure includes overlaying the RA channel over the wideband UL resources. The request is spread or repeated across the UL channel, possibly across the entire bandwidth. The random access operation for users may be assigned to one length L sequence and one location, if multiple possibilities are available.

A random access channel may be assigned one length L sequence for use by all users. The total resources NT may be divided into M time-frequency blocks for random access. The access sequence, through spreading and repetition, may span $NT/M=N$ RB's (e.g. $N=3$). The mobile terminal **20** randomly selects one of the M , wherein the number of distinction resource per sub frame is M . The sub frame for a request is also randomly selected.

The sequences for random access may be an orthogonal set of spreading sequences. Two sequences may be defined for two types of indications. A first type includes a system access request without a previously assigned mobile terminal ID and a second type includes a system access request with an assigned mobile terminal ID. If a mobile terminal **20** is provided access to the system, a down link (DL) control segment access grant may be scrambled by the sequence/resource block ID. The base station **16** may attempt interference cancellation to remove the RA channel from UL control. The base station **16** may try decoding UL control and traffic transmissions with and without an assumption that an RA was sent.

Once a mobile terminal **20** accesses the system, the mobile terminal **20** may request resources on the UL to transmit information to the base station **16**. The invention

provides the mobile terminal **20** with several options for performing the UL resource request. Parameters for a first transmission may be specified by a bandwidth request, the parameters may be set to default based on capability negotiation, the parameters may be set to a previous configuration based on renewal, or the parameters may be set in some other manner. The mobile terminal **20** may change the assignment parameters by including an additional re-configuration message encoded with data that takes effect at the start of the next packet transmission. This takes advantage of HARQ for the control message.

According to one embodiment, a field may be appended to a data packet prior to encoding. After the data packet is decoded at the base station **16**, the header is located to determine if an additional re-configuration message has been added to the packet with re-configuration information. Header operations may include a 2-bit header field that indicates the presence and type of service re-configuration message. For example, '00' may indicate no change to a configuration and no re-configuration message; '01' may indicate no change to a configuration, no re-configuration message, and extend service for another packet; '10' may indicate that a re-configuration message of Type 1 is attached; and '11' may indicate that a re-configuration message of Type 2 is attached.

A re-configuration message may include changes to an existing assignment or to future assignments, including mobile power header room, update of capabilities, request for different MIMO mode, request for different MCS Indication of mobile data backlog size, indication to continue assigning UL resources until data backlog is emptied, resource size specification, delay requirement, quality of service ("QoS"), and requests of an additional service/resources, among other transmission parameters.

The mobile terminal **20** may randomly select an RA signaling ID. A signaling ID may be a specific spreading sequence, a time-frequency location, a time slot, an interlace, or other signaling ID. The set of signaling ID options are known to users and also the index associated with each signaling ID option.

In response to a random access channel signal, the base station **16** may assign one or more of a user ID to the user, an initial UL resource for the mobile to provide information, user equipment capabilities, a DL resource assignment requesting information from the mobile terminal and additional details, such as group assignment, base station procedures, among other parameters. The assignment message may carry user ID information.

A message sent to the mobile terminal **20** from the base station **16** may identify the base station **16** using a randomly selected signaling ID option that is selected by the user for the RA. For example, if the control channels are generally scrambled in some manner by the user ID in response to a RA, the base station **16** will send a control message scrambled by the index of the randomly selected signaling ID, such as sequence index, sequence location, etc.

In another embodiment, some signaling IDs may be reserved for users that have been assigned user IDs. For example, a user may be in a hand-off operation and may be accessing a new serving sector. A user may select from a set of random access signaling IDs if an assigned user ID is not provided. Alternatively, a user may select from a different subset of signaling options if the user does have a user ID. In response, the base station **16** may send a control message that is scrambled by the RA signal index and includes a user ID if the mobile terminal **20** has sent a signaling option indicating a user ID is not provided. Alternatively, if the

mobile has sent a signaling option indicating it does have a user ID, then the base station **16** may send a control message that is scrambled by the RA signal index without a user ID. The mobile terminal **20** may indicate the user ID in the next UL transmission for user equipment capabilities, etc.

According to one embodiment, the header and optionally a message body may be added to a first packet transmission. Alternatively, the header and optionally a message body may be added to a first packet transmission and every Nth packet afterwards, where N can be from 1 to infinity. The base station **16** may provide the mobile terminal **20** with a ACK/NAK of packet transmission to indicate that a re-configuration message was correctly received.

During an assignment of the mobile terminal **20**, users may embed a header on a data packet transmission that provides details on configuration or re-configuration. The request by the mobile terminal **20** for resources may be made on dedicated resources within UL control tiles. These resource sizes may be different for different frames according to a pre-determined pattern. The sizes may be known at the mobile terminal **20** and the base station **16**, so signaling is not needed after configuration.

According to one embodiment, the resource request may occupy a field that is reserved for another message (CQI, ACK/NAK, precoder index, etc.) The presence of a request may be specified by the UL control message type. The mobile terminal **20** may set this type to a message configuration that includes space for a resource assignment. As a result, the size of the message may not be changed from the specified size for that sub frame. The presence of the request field may be dynamic, but may not affect the pre-determined size of the user's UL control. A resource request may be encoded with other lit control data so that resource requests may be reliably received.

The request may have multiple forms for a given system. In a first embodiment, the resource request may be a single "on/off" indication. Details of an assignment may be given in a re-configuration message or may be known from previous or default configurations. Alternatively, the resource request may be a message, where details of assignments are indicated, such as delay constraints, QoS, packet backlog, and resource size, among other assignments. Details of an assignment may be given in a re-configuration message or may be known from previous or default configurations. For example, resources may be specified by a secondary broadcast channel, UL resources may be allocated across distributed RB blocks, bandwidth requests may be 4-10 bits indicating QoS and a first transmission spectral efficiency or a mobile terminal **20** buffer size, a bandwidth request may occupy a field otherwise assigned for another purpose, such as DL CQI feedback, or UL resources may be encoded with other UL control data for users so that a bandwidth request may be reliably received.

According to an alternative embodiment, users may be assigned one of the random access signaling IDs (e.g., channel sequences or location) after accessing a system. A resource request may use the same sequence or channel configurations. As with the RA Channel, users also may be assigned specific sub frames for resource request opportunities. The assigned signaling may be a unique identifier for a user's resource request. In a first example, a set of signaling IDs may be reserved for resource requests and may not be used for RA requests. The assigned sequence or location may be a unique identifier for a user's resource request. A user may be assigned signaling IDs to identify a bandwidth request or a resource request. Alternatively, users may be assigned signaling IDs from a full set of RA

15

signaling IDs. The sequence may be scrambled by resource request ID to identify as BW or resource request. The assigned sequence, location, or scrambling may be a unique identifier for a user's resource request. Users may be assigned multiple signaled IDs for different configured services, such as VoIP and http traffic resource requests, among other configured services. If the user has another mechanism for obtaining resource requests and opportunities for resource requests are frequent, the user may not be assigned signaling for transmitting resource requests in this manner.

According to yet another embodiment, a bandwidth or resource request may use resources that are specified persistently. One or more RBs and multiple RBs may be distributed to provide diversity. A UL bandwidth or resource may be overlaid with other traffic on a same resource as a traffic signal or a control signal. If the user has another mechanism for resource requests and opportunities for requests are frequent, the user may not be assigned signaling for transmitting resource requests in this manner. UL bandwidth and resource requests for the mobile terminal **20** may include 4-10 bits, with an initial message containing limited fields, such as QoS and a first transmission spectral efficiency or a mobile terminal buffer size including CRC. The UL bandwidth requests and resource requests for a mobile terminal **20** are intended to be reliable signaling with diversity, with interference cancellation used at the base station **16**. Users may be separated by locations of RBs, sub frame, and assigned sequences. Regarding sequences, each user may be assigned a sequence block to use. In other embodiments, users may be assigned a same set of sequences to facilitate detection at the base station **16**. Alternatively, orthogonal sequences such as Zadoff-Chu or Walsh sequences may be used. The sequence length may be less than the length of the RB. If N RBs are assigned for each resource request channel, it may be repeated over all RBs. Alternatively, the sequence may be spread over all N RBs.

The mobile terminal **20** may send a request for service signal. The message size may be minimal as it indicates a renewal or continuation of a configured service. According to a first option, the service may be renewed through a single message after the mobile terminal receives a UL assignment for a given type of service. The message may be a simple ON/OFF toggle to renewal service with previous or existing parameters. The message may be sent in a persistently assigned UL control resource space and the message type may indicate that the service renewal is being signaled. The mobile terminals **20** may be assigned multiple messages to toggle multiple services, parameters of renewal for first transmission may be set to a default and a re-configuration signal in first transmission may provide parameter changes.

Alternatively, a scrambled ID may be provided to the mobile terminal **20** for a UL renewal request. After the mobile terminal **20** receives a UL assignment for a given type of service, the service may be renewed through a single message. The message may be a simple ON/OFF toggle to renew service with previous or existing parameters. The message may be sent using resource requests in random access space to renew service to last configuration parameters. The mobile terminals **20** may be assigned multiple messages to toggle multiple services. The parameters of renewal for a first transmission may be set to a default.

FIG. 9 illustrates an access and uplink resource allocation flow diagram between the mobile terminals **20** and the base station **16**. The mobile terminals **20** initiate an access request to the base station **16** using a randomly selected sequence (step S90). The base station **16** provides the mobile terminals **20** with an access grant and an initial assignment (step

16

S92). The mobile terminals **20** receive an initial UL assignment with a user ID and resource allocations (UL and/or DL) (step S94). The mobile terminals **20** submit a UL bandwidth request to the base station **16** (step S95). The base station **16** provides UL resource assignments (step S96) The mobile terminal **20** performs UL data transmission, including re-configuration of service and continuation of service (step S97). If the mobile terminal **20** is moved into a different cell, then a UL service renewal request may be sent to the base station (step S98).

The invention may be realized in hardware, software, or a combination of hardware and software. Any kind of computing system, or other apparatus adapted for carrying out the methods described herein, is suited to perform the functions described herein.

A typical combination of hardware and software could be a computer system having one or more processing elements and a computer program stored on a storage medium that, when loaded and executed, controls the computer system such that it carries out the methods described herein. The invention can also be embedded in a computer program product, which comprises all the features enabling the implementation of the methods described herein, and which, when loaded in a computing system is able to carry out these methods. Storage medium refers to any volatile or non-volatile storage device.

It will be appreciated by persons skilled in the art that the present invention is not limited to what has been particularly shown and described herein above. In addition, unless mention was made above to the contrary, it should be noted that all of the accompanying drawings are not to scale. A variety of modifications and variations are possible in light of the above teachings without departing from the scope and spirit of the invention, which is limited only by the following claims.

What is claimed is:

1. A base station, comprising:

at least one antenna; and

a processing element coupled to at least one antenna, wherein the processing element is configured to:

receive, from a mobile station operating in a cell associated with the base station, an access request, wherein the access request is determined based, at least in part, on a mobile station randomly selected random access signaling identification, wherein the mobile station is communicatively coupled to the base station over an orthogonal frequency division multiplexed (OFDM) based wireless network;

transmit an uplink access uplink grant to the mobile station in response to the access request;

receive a resource request for sending uplink information from the mobile station, wherein the resource request specifies a renewal of service for one or more configured services, and wherein the resource request message toggles the renewal of the one or more configured services using a single request message; and

receive a first transmission for a configured service of the one or more configured services according to a set of parameters, wherein the set of parameters are set to a previous configuration in the cell based on the renewal.

2. The base station of claim 1,

wherein the set of parameters includes one or more of delay constraints, quality of service (QoS), packet backlog, and resource size.

17

3. The base station of claim 1,
wherein the one or more configured services include one or more of voice over internet protocol (VoIP) and hypertext transfer protocol (HTTP) traffic.
4. The base station of claim 1,
wherein the renewal of service for the one or more configured services comprises multiple messages for multiple services.
5. The base station of claim 1,
wherein the processing element is further configured to:
receive a second transmission from the mobile station,
wherein the second transmission includes a re-configuration message, wherein the reconfiguration message uses hybrid automatic request (HARD) transmissions.
6. The base station of claim 5,
wherein the re-configuration message includes one or more of changes to mobile power header room, update of capabilities, request for different multiple input, multiple output (MIMO) mode, request for different modulation and coding scheme (MCS) indication of mobile data backlog size, indication to continue assigning uplink resources until data backlog is emptied, changes to resource size specification, changes to delay requirement, quality of service (QoS), and requests of an additional service/resources.
7. The base station of claim 1,
wherein a second transmission from the mobile station includes a header to indicate the re-configuration message has been added to the packet.
8. A non-transitory computer readable storage medium that stores program instructions executable by a processing element of a mobile station to:
transmit, to a base station while operating in a cell associated with the base station, an access request, wherein the access request is determined based, at least in part, on a randomly selected random access signaling identification, wherein the mobile station is communicatively coupled to the base station over an orthogonal frequency division multiplexed (OFDM) based wireless network;
receive an uplink access uplink grant from the base station in response to the access request;
transmit a resource request for sending uplink information to the base station, wherein the resource request specifies a renewal of service for one or more configured services, and wherein the resource request message toggles the renewal of the one or more configured services using a single request message; and
transmit a first transmission for a configured service of the one or more configured service according to a set of parameters, wherein the set of parameters are set to a previous configuration in the cell based on the renewal.
9. The non-transitory computer readable storage medium of claim 8,
wherein the set of parameters includes one or more of delay constraints, quality of service (QoS), packet backlog, and resource size.
10. The non-transitory computer readable storage medium of claim 8,
wherein the one or more configured services include one or more of voice over internet protocol (VoIP) and hypertext transfer protocol (HTTP) traffic.
11. The non-transitory computer readable storage medium of claim 8,

18

- wherein the renewal of service for the one or more configured services comprises multiple messages for multiple services.
12. The non-transitory computer readable storage medium of claim 8,
wherein the program instructions are further executable by the processing element of the mobile station to:
transmit a second transmission, wherein the second transmission includes a re-configuration message, wherein the reconfiguration message uses hybrid automatic request (HARQ) transmissions.
13. The non-transitory computer readable storage medium of claim 12,
wherein the re-configuration message includes one or more of changes to mobile power header room, update of capabilities, request for different multiple input, multiple output (MIMO) mode, request for different modulation and coding scheme (MCS) indication of mobile data backlog size, indication to continue assigning uplink resources until data backlog is emptied, changes to resource size specification, changes to delay requirement, quality of service (QoS), and requests of an additional service/resources.
14. A mobile station, comprising:
at least one antenna; and
a processing element coupled to at least one antenna, wherein the processing element is configured to:
randomly select a random access signaling identification;
transmit, to a base station while operating in a cell associated with the base station, an access request, wherein the access request is determined based, at least in part, on the random access signaling identification, wherein the mobile station is communicatively coupled to the base station over an orthogonal frequency division multiplexed (OFDM) based wireless network;
receive, in response to the access request, an uplink access uplink grant from the base station;
transmit, to the base station, a resource request for sending uplink information, wherein the resource request specifies a renewal of service for one or more configured services, and wherein the resource request message toggles the renewal of the one or more configured services using a single request message; and
transmit, to the base station, a first transmission for a configured service of the one or more configured services according to a set of parameters, wherein the set of parameters are set to a previous configuration in the cell based on the renewal.
15. The mobile station of claim 14,
wherein the set of parameters includes one or more of delay constraints, quality of service (QoS), packet backlog, and resource size.
16. The mobile station of claim 14,
wherein the one or more configured services include one or more of voice over internet protocol (VoIP) and hypertext transfer protocol (HTTP) traffic.
17. The mobile station of claim 14,
wherein the renewal of service for the one or more configured services comprises multiple messages for multiple services.
18. The mobile station of claim 14,
wherein the processing element is further configured to:
transmit, to the base station, a second transmission, wherein the second transmission includes a re-con-

figuration message, wherein the reconfiguration message uses hybrid automatic request (HARQ) transmissions.

19. The mobile station of claim **18**,
wherein the re-configuration message includes one or 5
more of changes to mobile power header room, update
of capabilities, request for different multiple input,
multiple output (MIMO) mode, request for different
modulation and coding scheme (MCS) indication of
mobile data backlog size, indication to continue assign- 10
ing uplink resources until data backlog is emptied,
changes to resource size specification, changes to delay
requirement, quality of service (QoS), and requests of
an additional service/resources.

20. The mobile station of claim **14**, 15
wherein a second transmission includes a header to indi-
cate the re-configuration message has been added to the
packet.

* * * * *