



US010059918B2

(12) **United States Patent**
Cizek et al.

(10) **Patent No.:** **US 10,059,918 B2**
(45) **Date of Patent:** **Aug. 28, 2018**

(54) **METHOD OF VITALLY SUPPORTING
MICROALGAE IN A FLEXIBLE
BIOREACTOR**

(71) Applicant: **Heliae Development, LLC**, Gilbert, AZ
(US)

(72) Inventors: **Luke Cizek**, Mesa, AZ (US); **Mason
Oelschlager**, Gilbert, AZ (US); **Justin
Hayden**, Phoenix, AZ (US); **Miguel
Olaizola**, Gilbert, AZ (US); **Mason
McCarty**, Scottsdale, AZ (US);
Richard Mazur, Phoenix, AZ (US)

(73) Assignee: **Heliae Development LLC**, Gilbert, AZ
(US)

(*) Notice: Subject to any disclaimer, the term of this
patent is extended or adjusted under 35
U.S.C. 154(b) by 0 days.

(21) Appl. No.: **15/142,964**

(22) Filed: **Apr. 29, 2016**

(65) **Prior Publication Data**

US 2016/0289629 A1 Oct. 6, 2016

Related U.S. Application Data

(63) Continuation of application No.
PCT/US2016/025343, filed on Mar. 31, 2016, and a
continuation-in-part of application No. 14/675,432,
filed on Mar. 31, 2015, now abandoned.

(51) **Int. Cl.**

C12N 1/12 (2006.01)
C12M 1/04 (2006.01)
C12M 1/00 (2006.01)
C12M 3/00 (2006.01)
C12M 1/12 (2006.01)
C12M 1/02 (2006.01)
C12M 1/34 (2006.01)

(52) **U.S. Cl.**

CPC **C12N 1/12** (2013.01); **C12M 21/02**
(2013.01); **C12M 23/14** (2013.01); **C12M**
23/26 (2013.01); **C12M 23/48** (2013.01);
C12M 27/04 (2013.01); **C12M 29/04**
(2013.01); **C12M 37/00** (2013.01); **C12M**
41/22 (2013.01); **C12M 41/36** (2013.01);
C12M 41/40 (2013.01)

(58) **Field of Classification Search**

None
See application file for complete search history.

(56) **References Cited**

U.S. PATENT DOCUMENTS

4,236,349 A 12/1980 Ramus
4,654,240 A 3/1987 Johnston
5,565,015 A 10/1996 Kobayashi
5,686,304 A 11/1997 Codner
6,165,372 A 12/2000 Ziemer et al.
6,432,698 B1 8/2002 Gaugler et al.

6,571,735 B1 6/2003 Wilkinson
8,910,494 B2 12/2014 Kahlert
2005/0239198 A1 10/2005 Kunas et al.
2006/0013749 A1 1/2006 Arencibia, Jr.
2006/0198763 A1 9/2006 Dang
2006/0270036 A1 11/2006 Goodwin
2007/0113474 A1 5/2007 Everett et al.
2008/0139865 A1* 6/2008 Galliher B08B 15/02
588/249
2008/0153080 A1 6/2008 Woods et al.
2008/0160591 A1 7/2008 Willson et al.
2009/0180933 A1 7/2009 Kauling et al.
2009/0305389 A1 12/2009 Willson et al.
2010/0028990 A1 2/2010 Broadley et al.
2010/0099170 A1 4/2010 Aswani
2010/0255458 A1 10/2010 Kinkaid
2011/0013474 A1 1/2011 Ludwig et al.
2011/0104790 A1 5/2011 Kassebaum et al.
2011/0281340 A1 11/2011 Turner et al.
2013/0082410 A1 4/2013 Goodwin et al.
2013/0089925 A1 4/2013 Damren et al.
2013/0244319 A1 9/2013 Dimitrelos
2014/0113340 A1 4/2014 Harethi et al.

(Continued)

FOREIGN PATENT DOCUMENTS

CA 2801768 1/2013
GB 2202549 9/1988

(Continued)

OTHER PUBLICATIONS

International Search Report and Written Opinion for PCT/US2016/
025343, dated Sep. 22, 2016.

GE Healthcare Life Sciences, "ReadyCircuit bags and tubing
assemblies," Data file 28-9606-44 AE, Nov. 2013.

Eibl et al., "Single-use Technology in Biopharmaceutical Produc-
tion," Dechema Biotechnologie, www.dechema.de, 2nd Edition,
Mar. 2012.

ATMI Life Sciences, Integrity PadReactor a New Culture in Cell
Growth, www.atmi-lifesciences.com, 2010.

(Continued)

Primary Examiner — Michelle F. Paguio Frising
(74) *Attorney, Agent, or Firm* — Heliae Development
LLC; Veronica-Adele R. Cao; Justin Kniep

(57) **ABSTRACT**

Some embodiments include a method. The method can
include: inoculating a bioreactor with one or more first
microorganisms and a first fluidic support medium, the
bioreactor having one or more bioreactor walls at least
partially enclosing a bioreactor cavity, being configured to
be at least one of folded up or rolled up, and being sterile
when the bioreactor is inoculated with the one or more first
microorganisms, the one or more bioreactor walls having at
least one bioreactor wall material, and the at least one
bioreactor wall material being flexible and at least partially
transparent; and vitally supporting the one or more first
microorganisms with the bioreactor, a supply of light, and a
supply of organic carbon. Other embodiments of related
systems and methods are also disclosed.

20 Claims, 12 Drawing Sheets

(56)

References Cited

U.S. PATENT DOCUMENTS

2014/0134672 A1 5/2014 Tuttmann et al.
2014/0315290 A1 10/2014 Mottahedeh
2014/0322804 A1 10/2014 Boily et al.
2015/0315538 A1* 11/2015 Whitman C12P 7/6409
435/71.2
2015/0330903 A1 11/2015 Koeperick

FOREIGN PATENT DOCUMENTS

JP 2007282629 11/2007
WO 2005006838 1/2005
WO 2007025968 3/2007
WO 2007070452 6/2007
WO 2010076795 7/2010
WO 2011017171 2/2011

OTHER PUBLICATIONS

Results of the Partial International Search Report for PCT/US2016/025343, dated Jun. 6, 2016, 4 pages.

Pulz, O., "Photobioreactors: Production Systems for Phototrophic Microorganisms," Applied Microbiology and Biotechnology, vol. 57, pp. 287-293 (Aug. 22, 2001).

Ugwu, et al., "Photobioreactors for Mass Cultivation on Algae," Bioresource Technology, Jul. 2008 (available online Mar. 26, 2017), pp. 4021-4028, vol. 99, Institute of Life Sciences and Bioengineering, University of Tsukuba, 1-1-1 Tennoai, Tsukuba City, Ibaraki 305-8572, Japan.

* cited by examiner

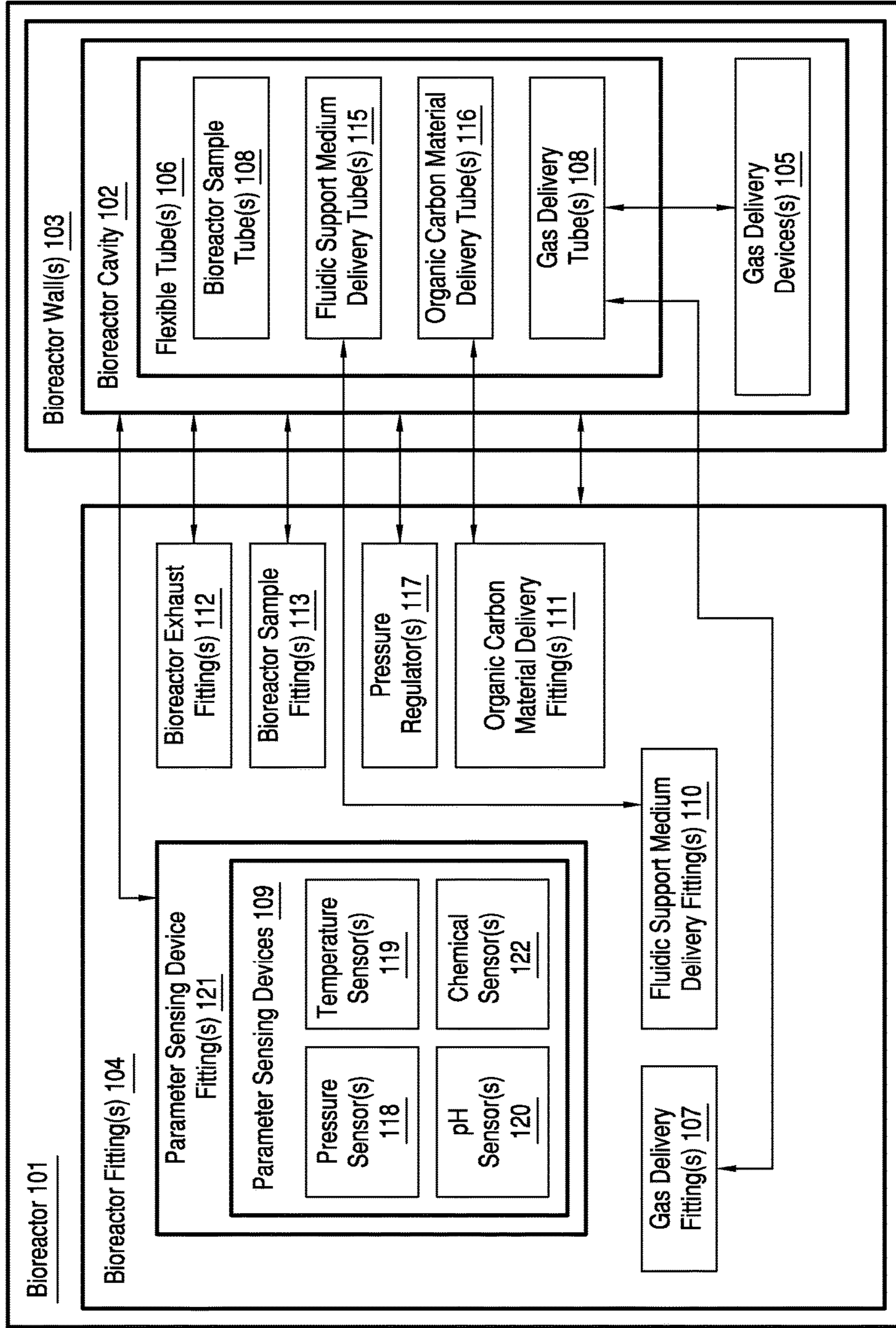

FIG. 1

100

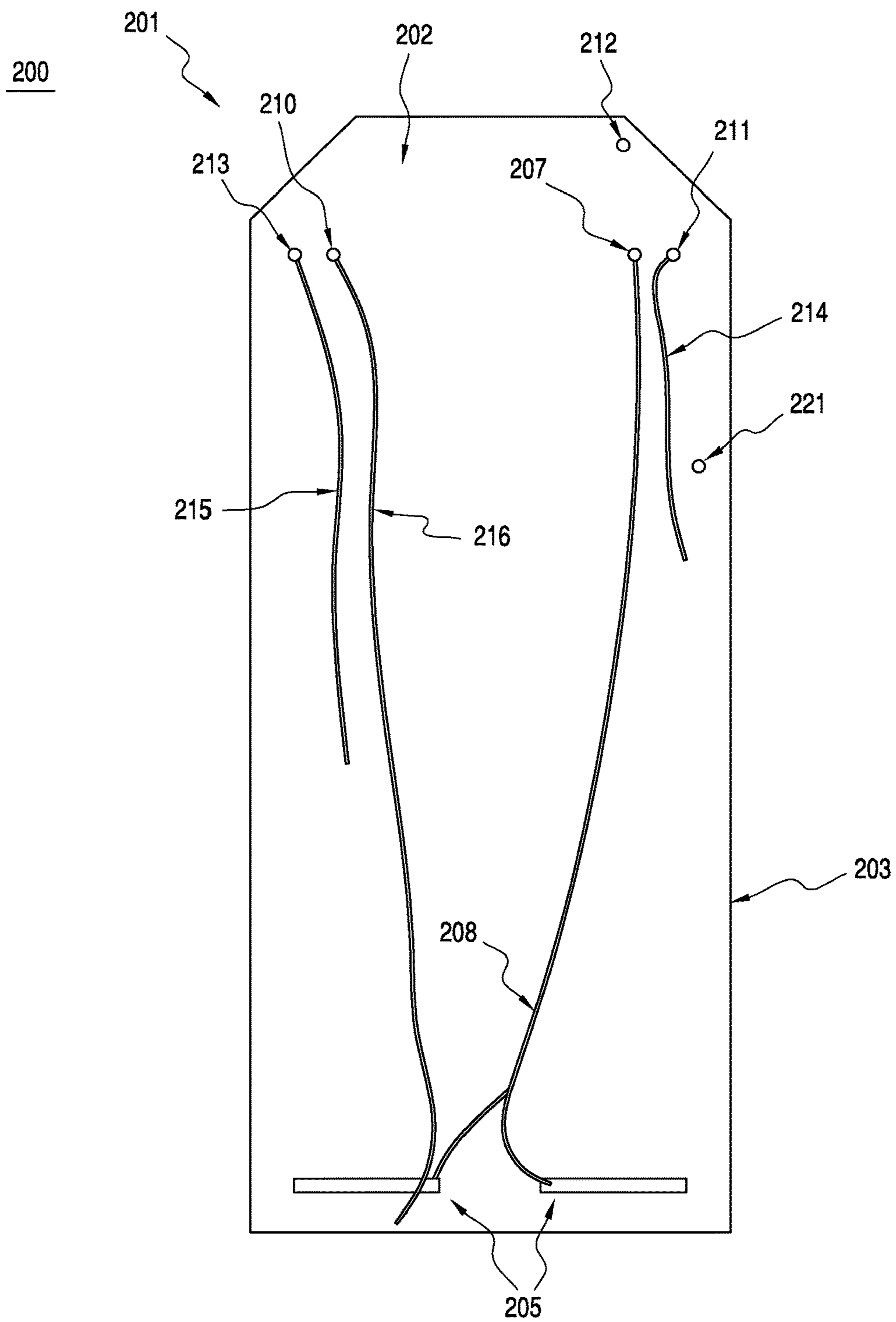
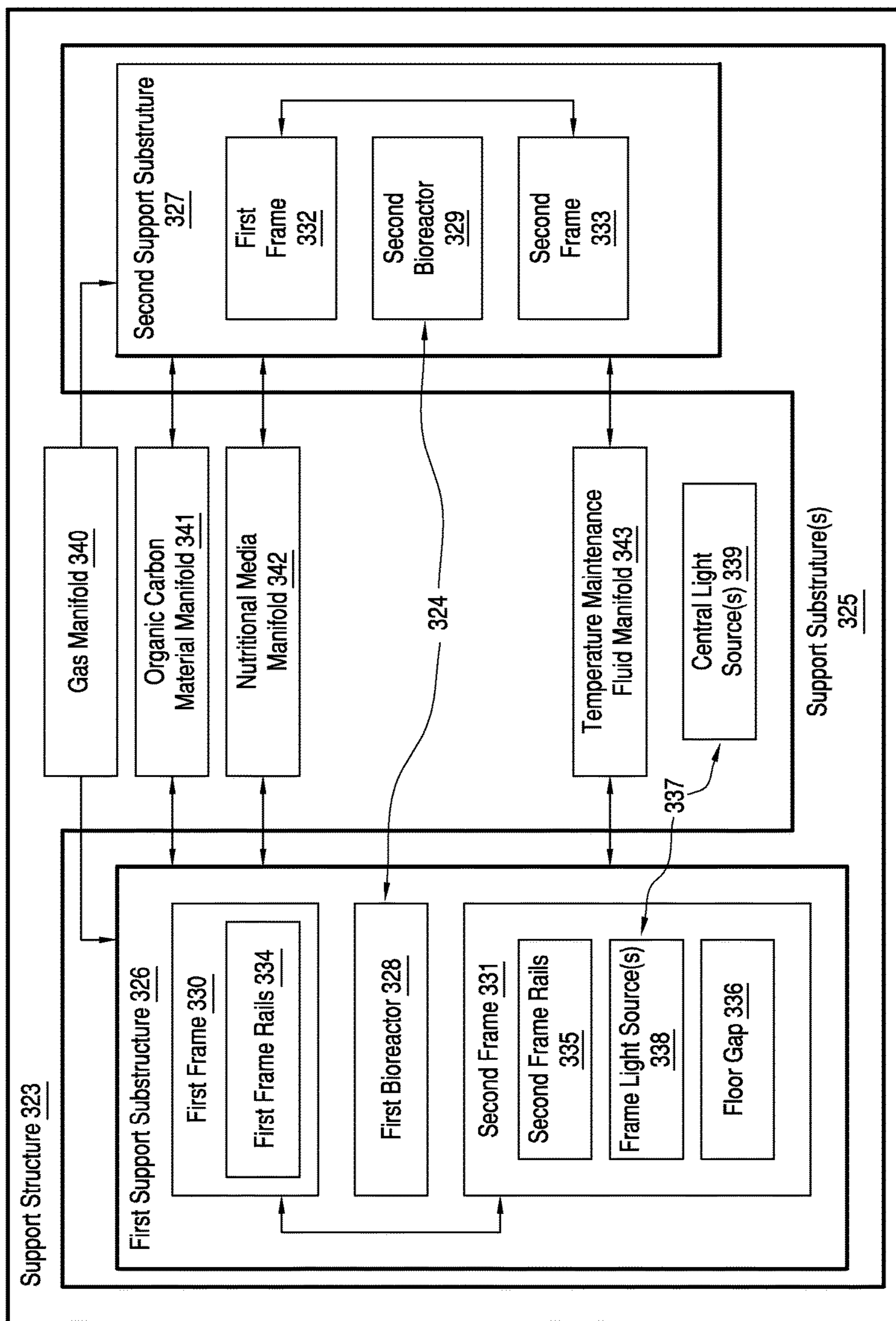

FIG. 2



300

FIG. 3

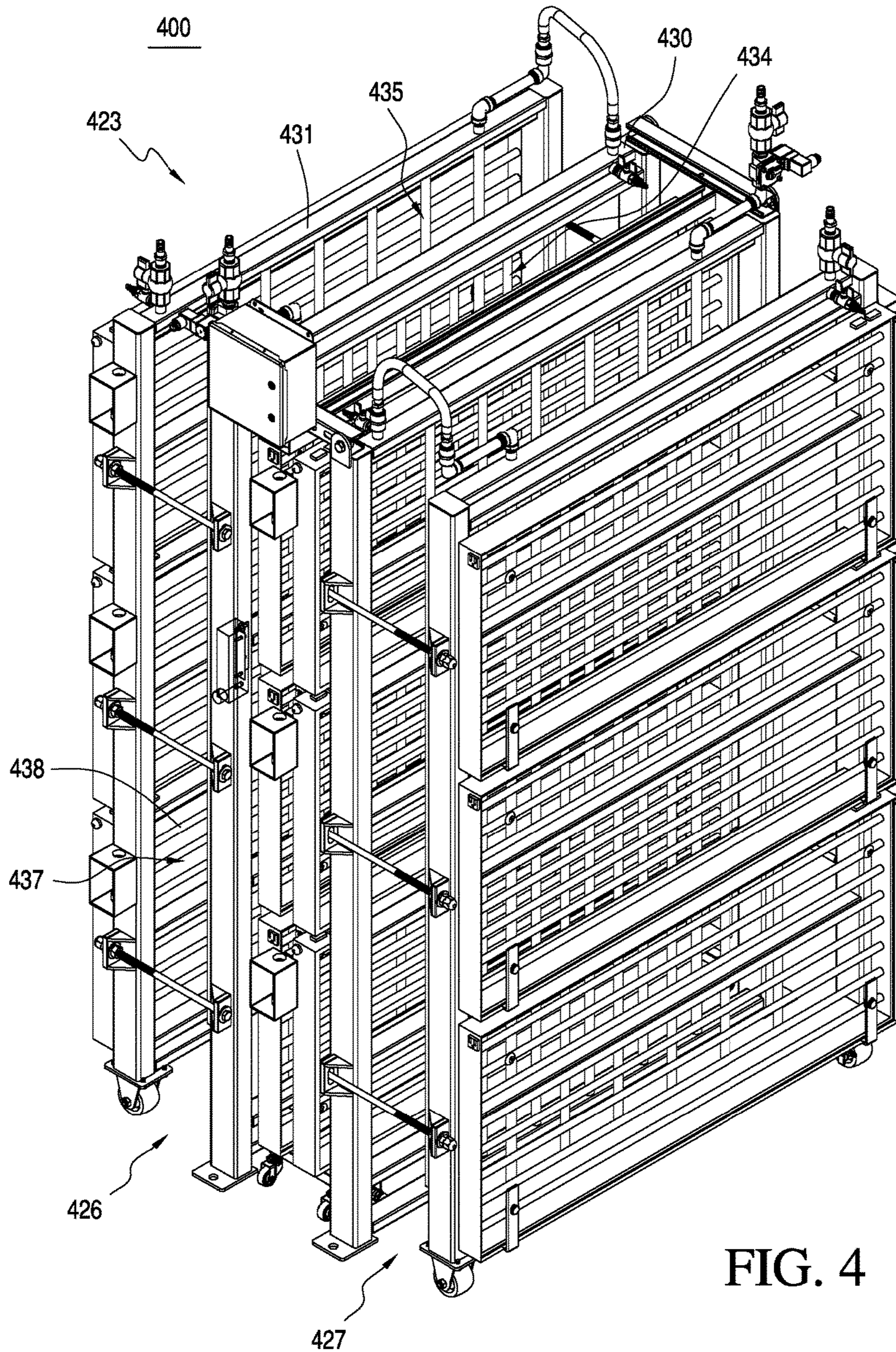

FIG. 4

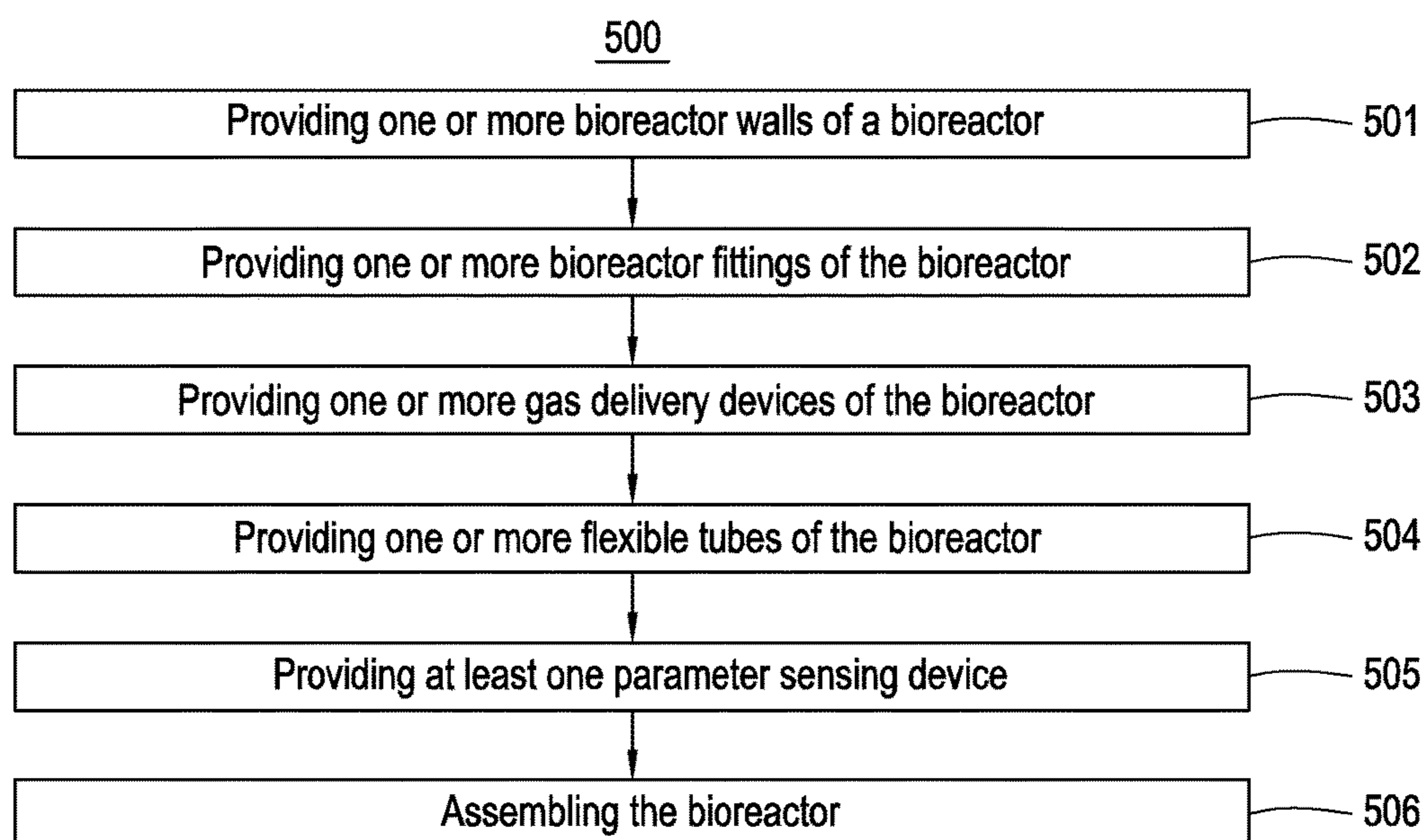

FIG. 5

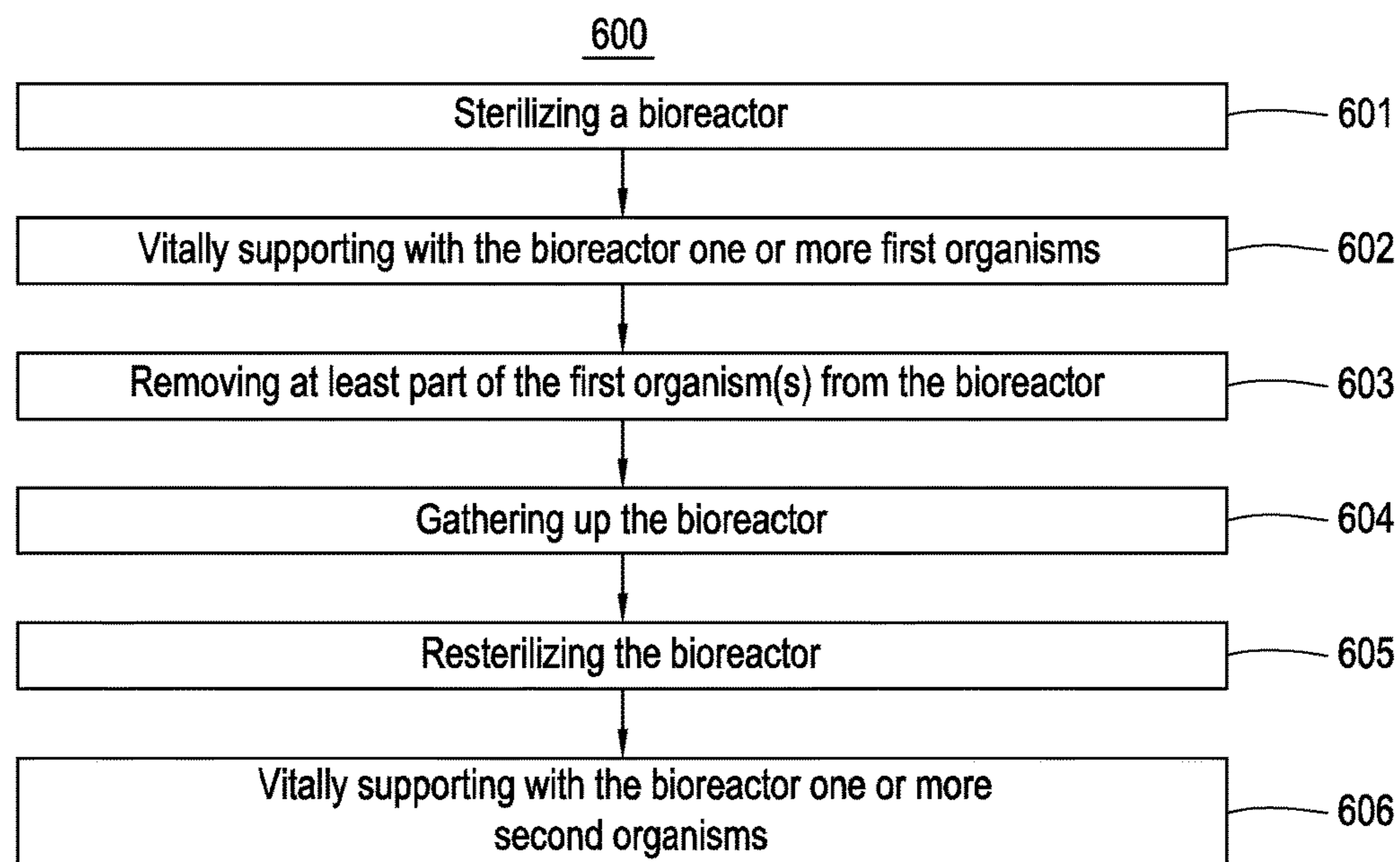

FIG. 6

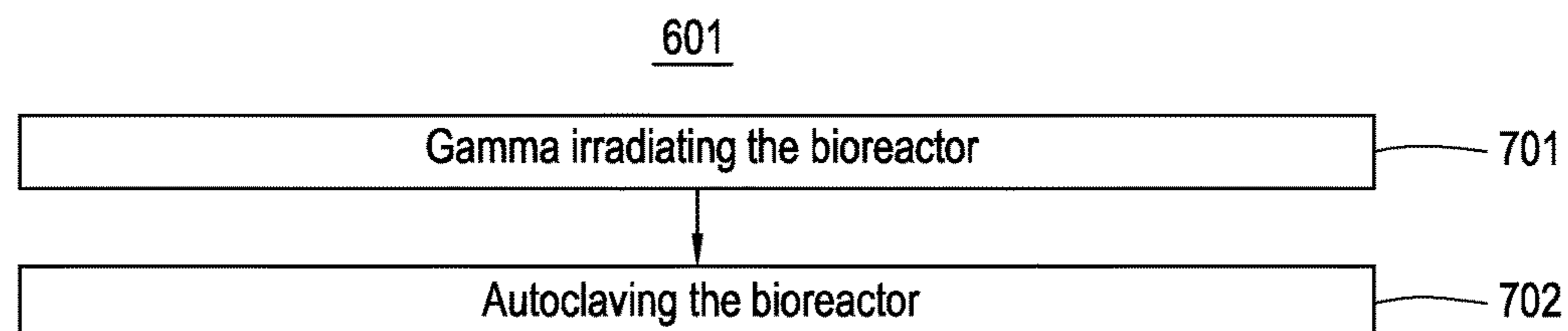

FIG. 7

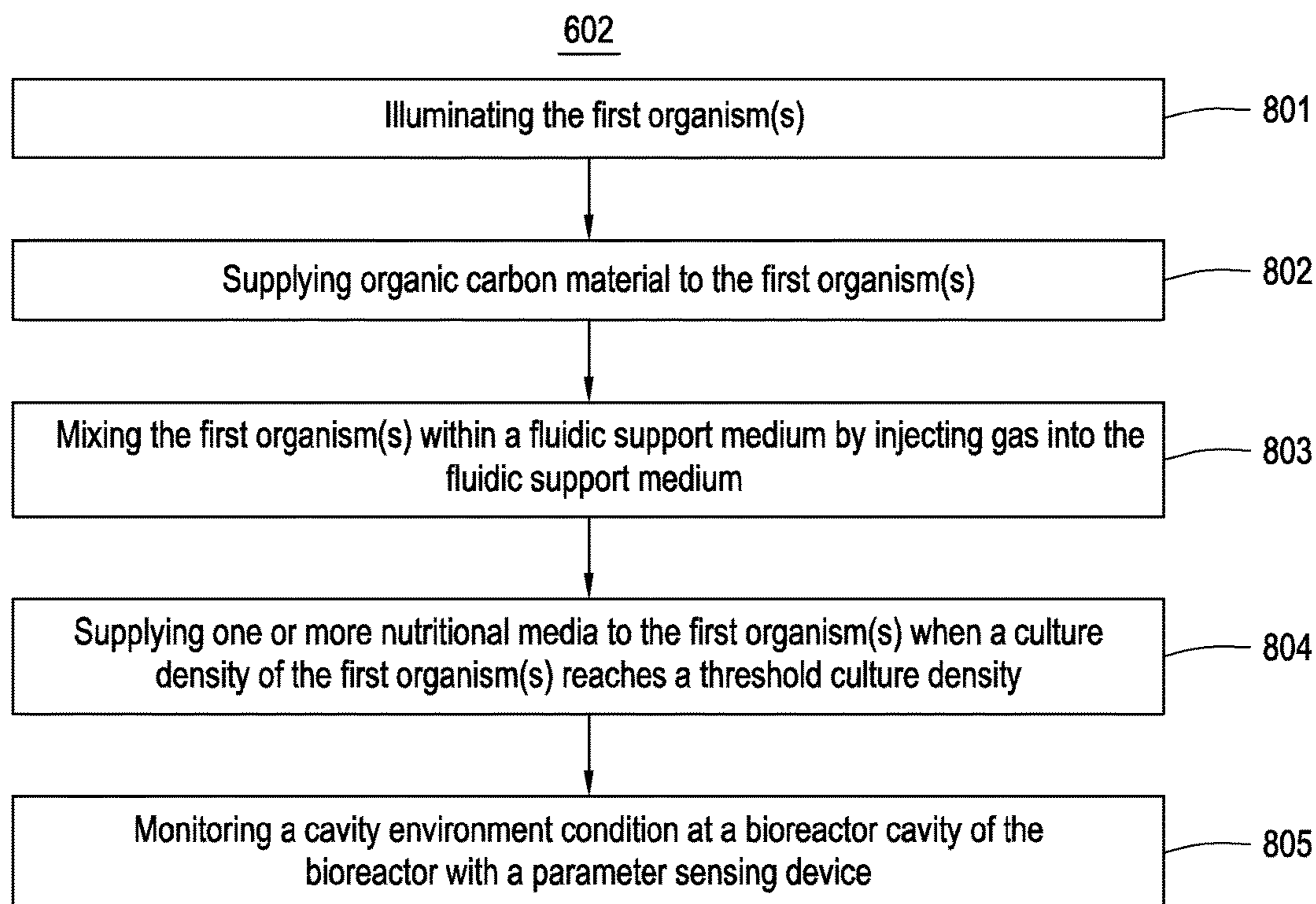

FIG. 8

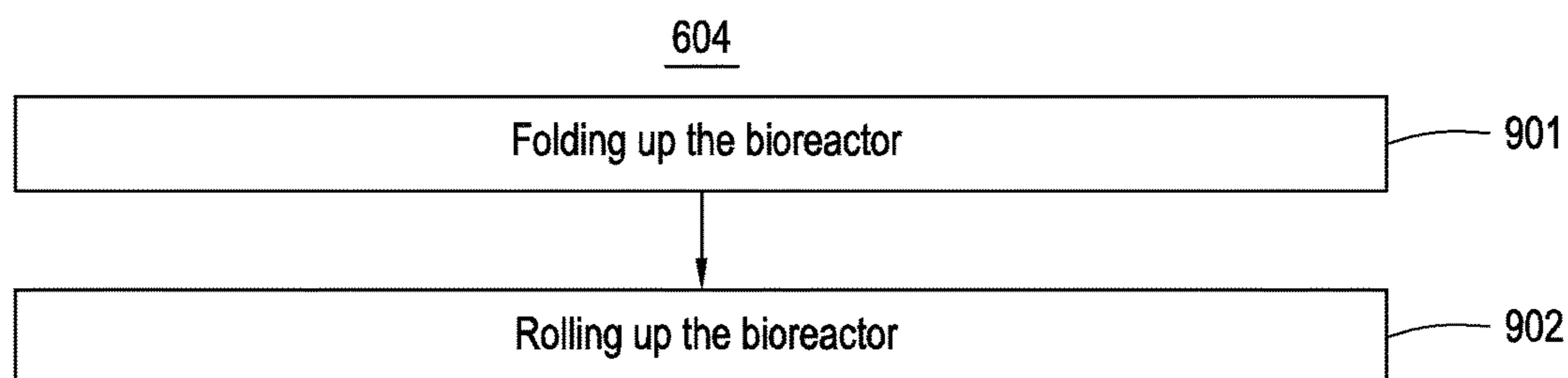

FIG. 9

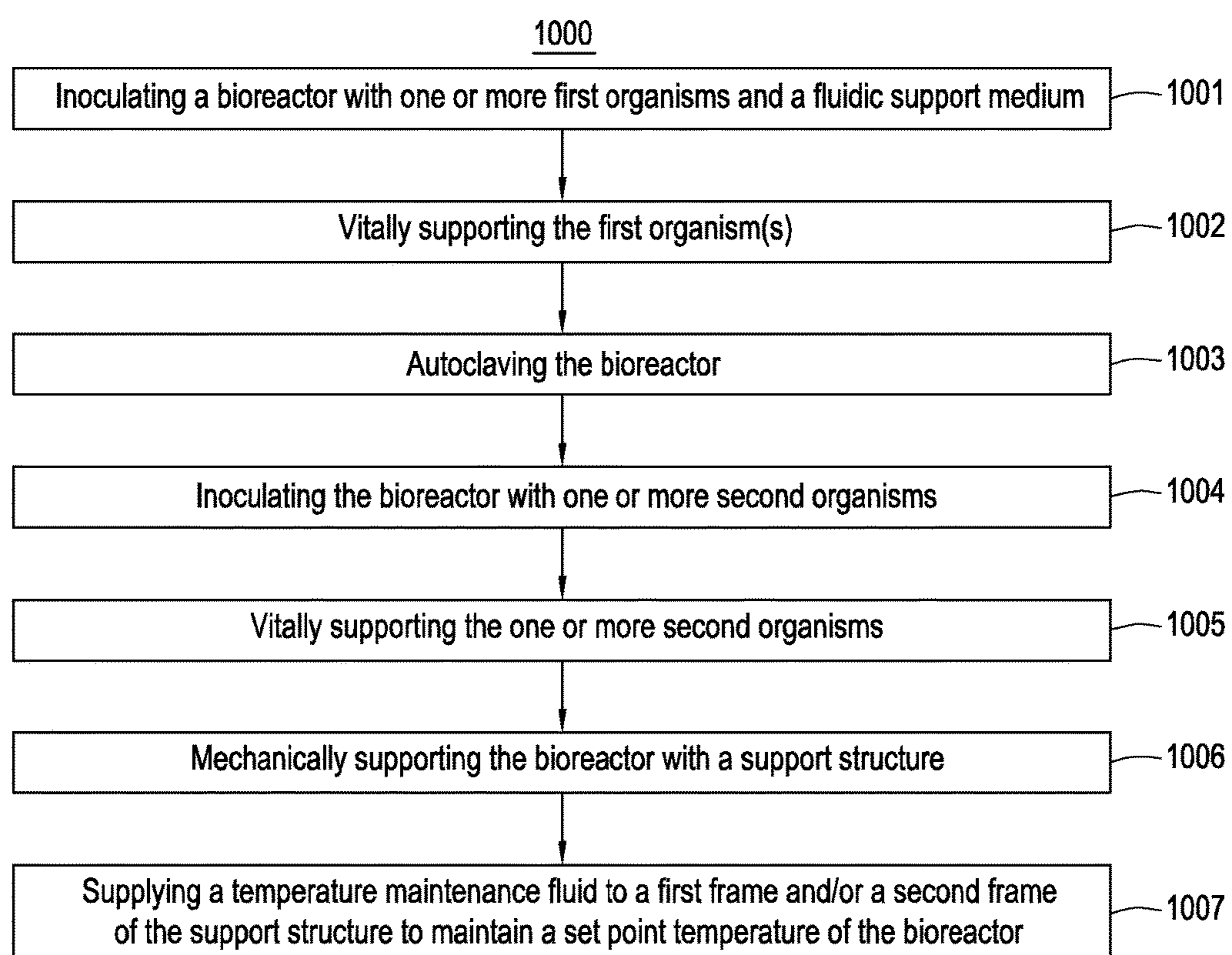

FIG. 10

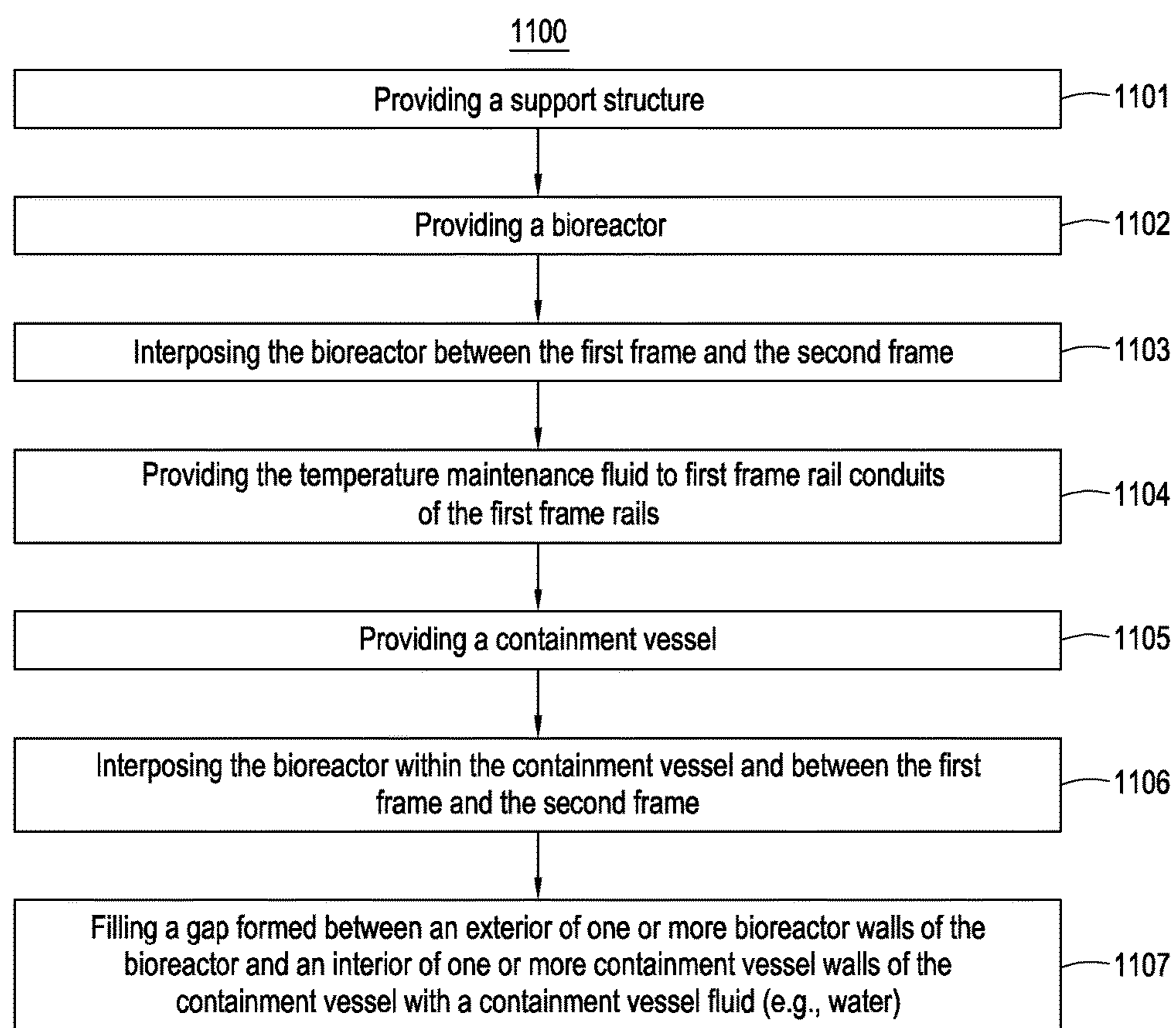

FIG. 11

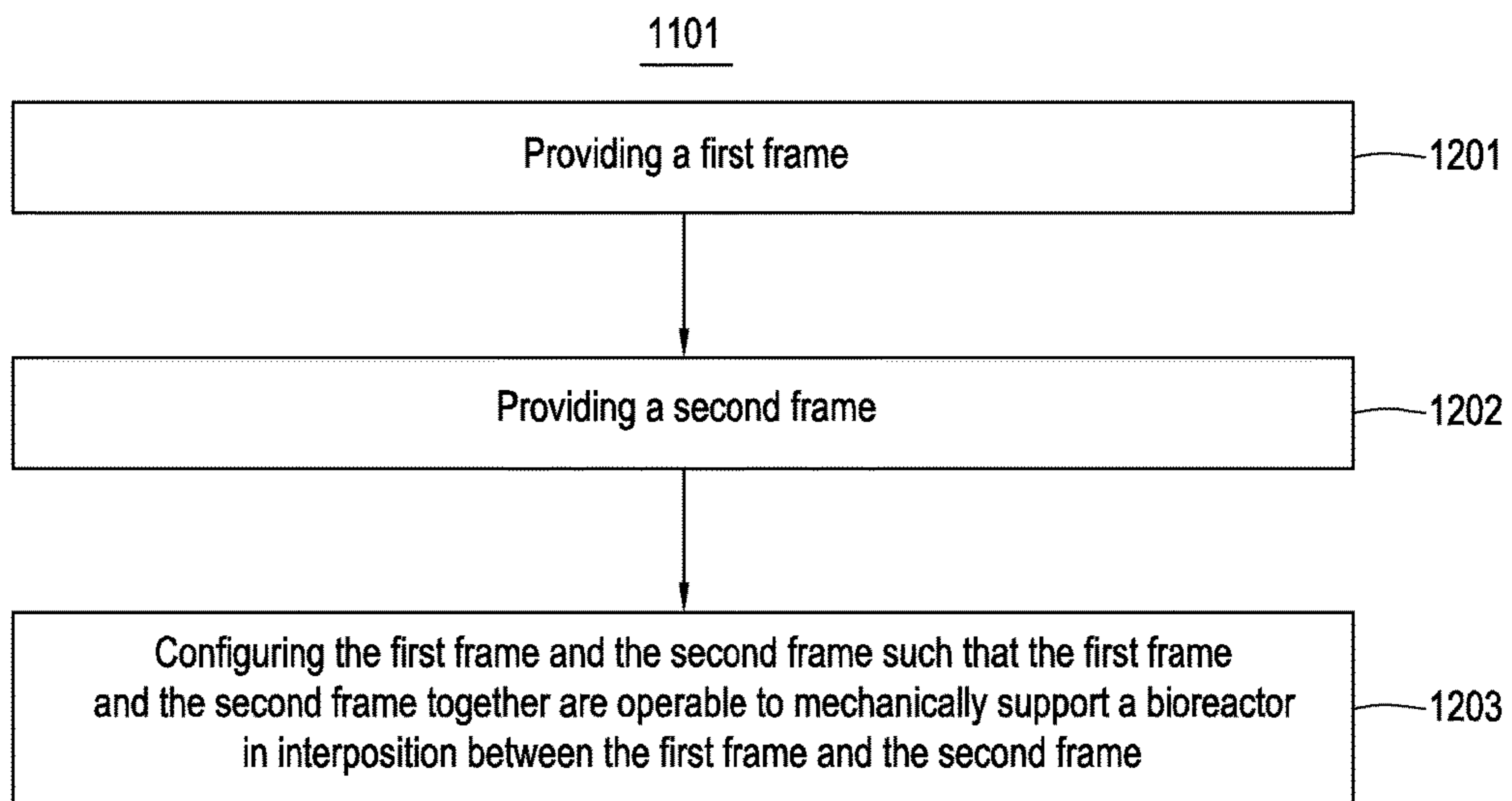

FIG. 12

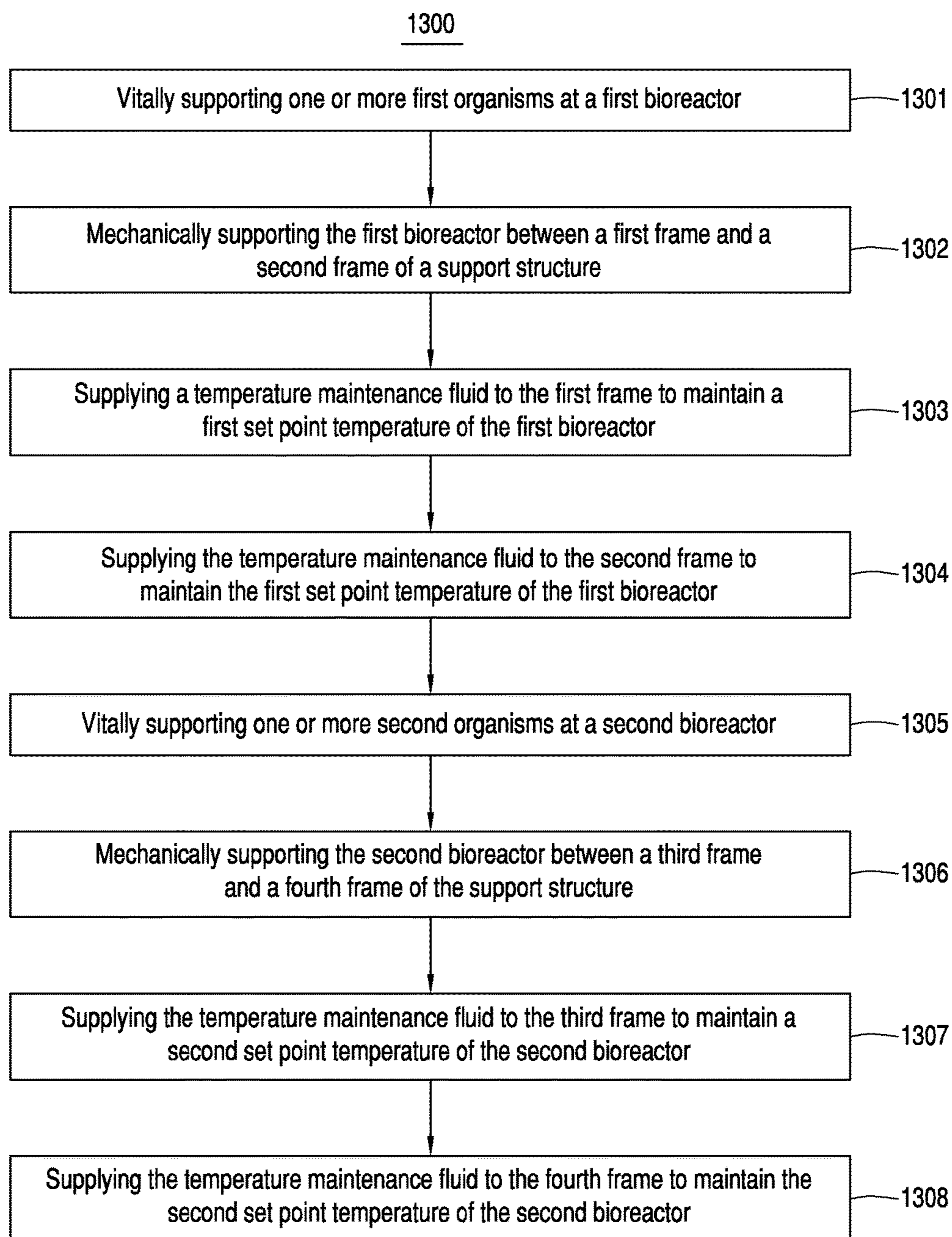
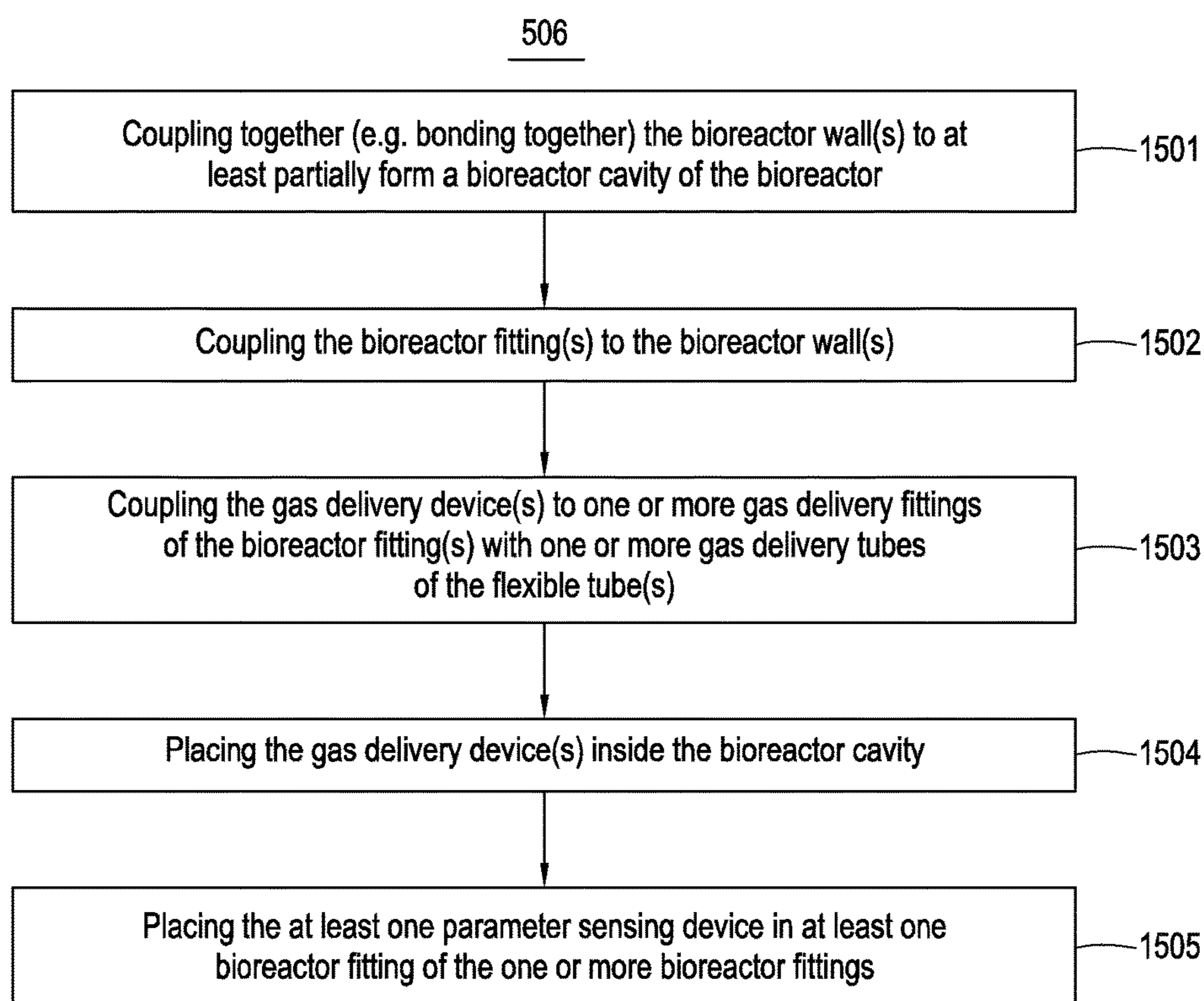
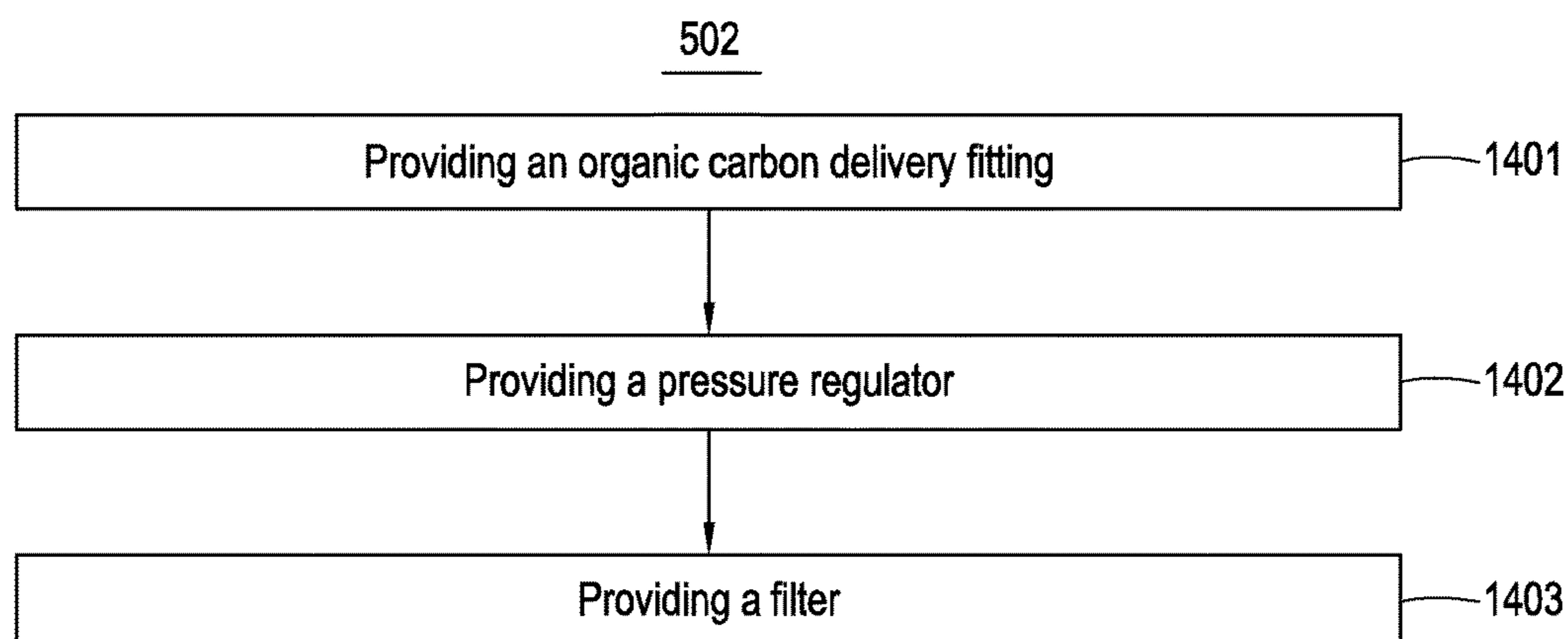

FIG. 13



1

**METHOD OF VITALLY SUPPORTING
MICROALGAE IN A FLEXIBLE
BIOREACTOR**

CROSS-REFERENCE TO RELATED
APPLICATIONS

This application is a continuation of International Patent Application No. PCT/US2016/025343, filed Mar. 31, 2016, and is a continuation-in-part of U.S. Non-Provisional patent application Ser. No. 14/675,432, filed Mar. 31, 2015. Meanwhile, International Patent Application No. PCT/US2016/025343 is a continuation-in-part of U.S. Non-Provisional patent application Ser. No. 14/675,432. International Patent Application No. PCT/US2016/025343 and U.S. Non-Provisional patent application Ser. No. 14/675,432 are incorporated by reference herein in their entirety.

FIELD OF THE INVENTION

This invention relates generally to systems for vitally supporting one or more organisms, and relates more particularly to such systems that permit for bioreactor sterilization, bioreactor mechanical support and temperature maintenance, and/or increased organism growth and methods of providing and using the same.

DESCRIPTION OF THE BACKGROUND

Worldwide traditional sources of protein, nutritional fatty acids, and petroleum oil are being depleted as the population and consumer demand increases. Algae (e.g., microalgae) is a renewable source with potential from traditional sources to produce biochemically active substances (e.g., lipids, proteins, polysaccharides) that can be used in whole cell and extract product forms to produce food, agricultural additives, nutritional supplements, cosmetics, specialty chemicals, and biofuels, as well as various other co-products (e.g., carotenoids, chlorophyll, phycocyanin, etc.) providing natural colorants and antioxidants. Algae also can be suitable as a replacement feedstock for traditional sources due to a variety of factors, including algae's high per-acre productivity compared to other terrestrial plants, algae's availability as a non-fish-based feedstock resources in places where the fish meal is becoming a scarce commodity, algae's ability to be grown on otherwise non-productive or non-arable land, and algae's ability to use a wide variety of water sources (fresh, brackish, saline, and wastewater). Realizing the potential for algae as a replacement resource can depend on the ability to culture the algae in reliable bioreactor systems capable of repeatedly producing high culture densities, high productivity rates, and high quality biomass (e.g., desirable profiles of biochemically active substances, low concentrations of contamination, etc.).

Accordingly, improved systems and methods for vitally supporting organisms (e.g., algae) able to produce biochemically active substances are desirable for their promise in satisfying future nutritional, agricultural, chemical, and energy needs in a clean, innocuous, sustainable, and/or cost effective manner.

BRIEF DESCRIPTION OF THE DRAWINGS

To facilitate further description of the embodiments, the following drawings are provided in which:

FIG. 1 illustrates an exemplary block diagram of a system, according to an embodiment;

2

FIG. 2 illustrates a schematic side view of a system, according to an embodiment;

FIG. 3 illustrates an exemplary block diagram of a system, according to an embodiment;

5 FIG. 4 illustrates a system, according to an embodiment;

FIG. 5 illustrates a flow chart for an embodiment of a method;

FIG. 6 illustrates a flow chart for an embodiment of a method;

10 FIG. 7 illustrates a flow chart of an exemplary activity of sterilizing a bioreactor, according to the embodiment of FIG. 6;

FIG. 8 illustrates a flow chart of an exemplary activity of vitally supporting with the bioreactor one or more first organisms, according to the embodiment of FIG. 6

15 FIG. 9 illustrates a flow chart of an exemplary activity of gathering up the bioreactor, according to the embodiment of FIG. 6;

20 FIG. 10 illustrates a flow chart for an embodiment of a method;

FIG. 11 illustrates a flow chart for an embodiment of a method;

25 FIG. 12 illustrates a flow chart of an exemplary activity of providing a support structure, according to the embodiment of FIG. 11;

FIG. 13 illustrates a flow chart for an embodiment of a method;

30 FIG. 14 illustrates a flow chart for an exemplary activity of providing one or more bioreactor fittings of a bioreactor, according to the method of FIG. 13; and

FIG. 15 illustrates a flowchart for an exemplary activity of assembling the bioreactor, according to the method of FIG. 13.

35 For simplicity and clarity of illustration, the drawing figures illustrate the general manner of construction, and descriptions and details of well-known features and techniques may be omitted to avoid unnecessarily obscuring the invention. Additionally, elements in the drawing figures are not necessarily drawn to scale. For example, the dimensions of some of the elements in the figures may be exaggerated relative to other elements to help improve understanding of embodiments of the present invention. The same reference numerals in different figures denote the same elements.

45 The terms "first," "second," "third," "fourth," and the like in the description and in the claims, if any, are used for distinguishing between similar elements and not necessarily for describing a particular sequential or chronological order. It is to be understood that the terms so used are interchangeable under appropriate circumstances such that the embodiments described herein are, for example, capable of operation in sequences other than those illustrated or otherwise described herein. Furthermore, the terms "include," and "have," and any variations thereof, are intended to cover a non-exclusive inclusion, such that a process, method, system, article, device, or apparatus that comprises a list of elements is not necessarily limited to those elements, but may include other elements not expressly listed or inherent to such process, method, system, article, device, or apparatus.

50 The terms "left," "right," "front," "back," "top," "bottom," "over," "under," and the like in the description and in the claims, if any, are used for descriptive purposes and not necessarily for describing permanent relative positions. It is to be understood that the terms so used are interchangeable under appropriate circumstances such that the embodiments

of the invention described herein are, for example, capable of operation in other orientations than those illustrated or otherwise described herein.

The terms “couple,” “coupled,” “couples,” “coupling,” and the like should be broadly understood and refer to connecting two or more elements or signals, electrically, mechanically and/or otherwise. Two or more electrical elements may be electrically coupled but not be mechanically or otherwise coupled; two or more mechanical elements may be mechanically coupled, but not be electrically or otherwise coupled; two or more electrical elements may be mechanically coupled, but not be electrically or otherwise coupled. Coupling may be for any length of time, e.g., permanent or semi-permanent or only for an instant.

“Electrical coupling” and the like should be broadly understood and include coupling involving any electrical signal, whether a power signal, a data signal, and/or other types or combinations of electrical signals. “Mechanical coupling” and the like should be broadly understood and include mechanical coupling of all types.

The absence of the word “removably,” “removable,” and the like near the word “coupled,” and the like does not mean that the coupling, etc. in question is or is not removable.

DETAILED DESCRIPTION OF EXAMPLES OF EMBODIMENTS

Some embodiments include a system. The system comprises a bioreactor operable to vitally support one or more microorganisms and enclose the microorganism(s) and a fluidic support medium. The bioreactor can comprise a bioreactor cavity and one or more bioreactor walls at least partially forming the bioreactor cavity and comprising at least one bioreactor wall material. Further, the bioreactor can comprise one or more bioreactor fittings in communication with the bioreactor cavity, one or more gas delivery devices disposed within the bioreactor cavity, and one or more flexible tubes disposed within the bioreactor cavity. Further, the bioreactor fitting(s) can comprise at least one gas delivery fitting. Meanwhile, the gas delivery device(s) can be operable to inject gas into the bioreactor cavity to mix the microorganism(s), and the flexible tube(s) can comprise at least one gas delivery tube coupling the gas delivery device(s) to the gas delivery fitting(s). Further still, the bioreactor wall material(s) can be flexible, the bioreactor can be autoclaved one or more times to sterilize the bioreactor, and the bioreactor can be folded up and/or rolled up.

In these or other embodiments, the microorganism(s) can comprise at least one of microalgae or cyanobacteria, can comprise phototropic microorganisms, can comprise heterotrophic microorganisms, and/or can comprise mixotrophic microorganisms. In these or other embodiments, the bioreactor can comprise a photobioreactor, and the at least one bioreactor wall material can be at least partially transparent. Further, the bioreactor fitting(s) can comprise at least one organic carbon material delivery fitting operable to supply an organic carbon material to the microorganism(s). In these or other embodiments, the at least one bioreactor wall material comprises polypropylene and polyamide. In these or other embodiments, the bioreactor can comprise at least one parameter sensing device. In these or other embodiments, the gas delivery device(s) can be configured so that the gas injected by the gas delivery device(s) into the bioreactor cavity can comprise gas bubbles comprising a diameter greater than or equal to approximately 40 micrometers and less than or equal to approximately 2 millimeters and/or can comprise a volumetric flow rate of greater than or

equal to approximately 10 liters per minute and less than or equal to approximately 120 liters per minute. In these or other embodiments, the gas delivery device(s) can comprise at least one sparger, the sparger(s) can comprise a sparger material, and the sparger material can comprise porous stainless steel or silicon. In these or other embodiments, the bioreactor fitting(s) can comprise a fluidic support medium delivery fitting operable to supply the microorganism(s) and the fluidic support medium to the bioreactor cavity, and the flexible tube(s) can comprise a fluidic support medium delivery tube operable to convey the microorganism(s) and the fluidic support medium at the bioreactor cavity. Further, the fluidic support medium delivery tube can comprise a fluidic support medium delivery tube input and a fluidic support medium delivery tube output, the fluidic support medium delivery tube input can be coupled to the fluidic support medium delivery fitting, and the fluidic support medium delivery tube output can comprise a non-planar cross section located within the bioreactor cavity. In these or other embodiments, at least one of the bioreactor fitting(s) can comprise a bioreactor fitting filter. In these or other embodiments, the bioreactor can comprise at least one pressure regulator operable to limit a bioreactor cavity pressure of the bioreactor cavity. In these or other embodiments, the bioreactor cavity can comprise at least one heat weld coupling together the one or more bioreactor walls. In these or other embodiments, the bioreactor is configured so that the bioreactor is able to be autoclaved to sterilize the bioreactor before the bioreactor vitally supports the microorganism(s). In these or other embodiments, the bioreactor can be operable to vitally support one or more first microorganisms of the microorganism(s) and one or more second microorganisms of the microorganism(s) at different times, and the bioreactor can be autoclaved to sterilize the bioreactor after the bioreactor vitally supports the first microorganism(s) and before the bioreactor vitally supports the second microorganism(s). In these or other embodiments, the bioreactor cavity can be substantially axenic when operating to vitally support the microorganism(s).

Some embodiments include a system. The system can comprise a bioreactor operable to vitally support one or more microorganisms. Meanwhile, the bioreactor can comprise a bioreactor cavity means for containing the microorganism(s) and a fluidic support medium, a parameter sensing means for monitoring a cavity environment condition at the bioreactor, and a bioreactor mixing means for mixing the microorganism(s). Further, the bioreactor can be autoclaved one or more times to sterilize the bioreactor, and the bioreactor can be folded up and/or rolled up.

In these or other embodiments, the microorganism(s) can comprise at least one of microalgae or cyanobacteria, can comprise phototropic microorganisms, can comprise heterotrophic microorganisms, and/or can comprise mixotrophic microorganisms. In these or other embodiments, the bioreactor can comprise an organic carbon material delivery means for supplying organic carbon material to the microorganism(s). In these or other embodiments, the bioreactor can comprise a pressure regulation means for limiting a bioreactor cavity pressure of the bioreactor cavity. In these or other embodiments, the bioreactor can comprise a filtration means for filtering a supply of at least one of a gas, one or more nutritional media, or the fluidic support medium. In these or other embodiments, the bioreactor is configured so that the bioreactor is able to be autoclaved to sterilize the bioreactor before the bioreactor vitally supports the microorganism(s). In these or other embodiments, the bioreactor can be operable to vitally support one or more first micro-

5

organisms of the microorganism(s) and one or more second microorganisms of the microorganism(s) at different times, and the bioreactor can be autoclaved to sterilize the bioreactor after the bioreactor vitally supports the first microorganism(s) and before the bioreactor vitally supports the second microorganism(s).

Some embodiments include a method. The method can comprise: providing one or more bioreactor walls of a bioreactor, the bioreactor wall(s) comprising at least one bioreactor wall material; providing one or more bioreactor fittings of the bioreactor, the bioreactor fitting(s) comprising at least one gas delivery fitting; providing one or more gas delivery devices of the bioreactor; providing one or more flexible tubes of the bioreactor, the flexible tube(s) comprising at least one gas delivery tube; coupling together the bioreactor wall(s) to at least partially form a bioreactor cavity of the bioreactor, the bioreactor cavity being configured to contain one or more microorganisms and a fluidic support medium; coupling the bioreactor fitting(s) to the bioreactor wall(s); coupling the gas delivery device(s) to the gas delivery fitting(s) with the gas delivery tube(s); and placing the gas delivery device(s) inside the bioreactor cavity. Meanwhile, the bioreactor can be operable to vitally support the microorganism(s), the bioreactor fitting(s) can communicate with the bioreactor cavity when the bioreactor fitting(s) are coupled to the bioreactor wall(s), and the gas delivery device(s) are operable to inject gas into the bioreactor cavity to mix the microorganism(s). Further, the at least one bioreactor wall material can be flexible, the bioreactor can be autoclaved one or more times to sterilize the bioreactor, and the bioreactor can be folded up and/or rolled up.

In these or other embodiments, coupling together the bioreactor wall(s) to at least partially form a bioreactor cavity of the bioreactor comprises heat welding together the bioreactor wall(s) to at least partially form the bioreactor cavity of the bioreactor.

Some embodiments include a method. The method can comprise: sterilizing a bioreactor, wherein sterilizing the bioreactor comprises at least one of gamma irradiating the bioreactor or autoclaving the bioreactor; after sterilizing the bioreactor, vitally supporting one or more first microorganisms with the bioreactor; after vitally supporting the first microorganism(s) with the bioreactor, removing the first microorganism(s) from the bioreactor; after removing the first microorganism(s) from the bioreactor, gathering up the bioreactor, wherein gathering up the bioreactor after removing the first microorganism(s) from the bioreactor comprises at least one of folding the bioreactor after removing the first microorganism(s) from the bioreactor or rolling up the bioreactor after removing the first microorganism(s) from the bioreactor; after gathering up the bioreactor, resterilizing the bioreactor, wherein resterilizing the bioreactor comprises autoclaving the bioreactor; and after resterilizing the bioreactor, vitally supporting one or more second microorganisms with the bioreactor.

In these or other embodiments, the method can further comprise gathering up the bioreactor before sterilizing the bioreactor, wherein gathering up the bioreactor before sterilizing the bioreactor comprises at least one of folding the bioreactor before sterilizing the bioreactor or rolling up the bioreactor before sterilizing the bioreactor. In these or other embodiments, vitally supporting the first microorganism(s) can comprise illuminating the first microorganism(s) and/or supplying organic carbon material to the first microorganism(s). In these or other embodiments, vitally supporting the first microorganism(s) can comprise mixing the first microorganism(s) within a fluidic support medium

6

by injecting gas into the fluidic support medium, wherein the gas can comprise gas bubbles comprising a diameter greater than or equal to approximately 40 micrometers and less than or equal to approximately 2 millimeters. In these or other embodiments, vitally supporting the first microorganism(s) with the bioreactor can comprise vitally supporting the first microorganism(s) with the bioreactor while the bioreactor cavity is substantially axenic, and vitally supporting the second microorganism(s) with the bioreactor comprises vitally supporting the second microorganism(s) with the bioreactor while the bioreactor cavity is substantially axenic.

Some embodiments include a system. The system can comprise a support structure operable to mechanically support a first bioreactor. The support structure can comprise a first frame and a second frame together being operable to mechanically support the first bioreactor in interposition between the first frame and the second frame. The first frame can maintain a first set point temperature of the first bioreactor when the first bioreactor is vitally supporting one or more first microorganisms and when the support structure is mechanically supporting the first bioreactor. Further, the first bioreactor can be operable to vitally support the first microorganism(s). Meanwhile, the first bioreactor can comprise a first bioreactor cavity configured to contain the first microorganism(s) and a first fluidic support medium, and can comprise one or more first bioreactor walls at least partially forming the first bioreactor cavity. Also, the first bioreactor wall(s) can comprise at least one first bioreactor wall material and the at least one first bioreactor wall material can be flexible.

In these or other embodiments, the system can comprise the first bioreactor, the first bioreactor can be autoclaved one or more times to sterilize the first bioreactor, and/or the first bioreactor can be folded up and/or rolled up. In these or other embodiments, the first bioreactor can comprise one or more bioreactor fittings in communication with the first bioreactor cavity, one or more gas delivery devices disposed within the first bioreactor cavity, and one or more flexible tubes disposed within the first bioreactor cavity. Further, the bioreactor fitting(s) can comprise at least one gas delivery fitting, the gas delivery device(s) can inject gas into the first bioreactor cavity to mix the first microorganism(s), and the flexible tube(s) can comprise at least one gas delivery tube coupling the gas delivery device(s) to the gas delivery fitting(s). In these or other embodiments, the first microorganism(s) can comprise at least one of microalgae or cyanobacteria, can comprise phototropic microorganisms, can comprise heterotrophic microorganisms, and/or can comprise mixotrophic microorganisms. In these or other embodiments, the second frame can maintain the first set point temperature of the first bioreactor when the first bioreactor is vitally supporting the first microorganism(s) and when the support structure is mechanically supporting the first bioreactor. In these or other embodiments, the first frame can comprise two or more first frame rails, each first frame rail of the two or more first frame rails can comprise a first frame rail conduit, each first frame rail conduit of the two or more first frame rail conduits can convey a temperature maintenance fluid to exchange thermal energy between the first bioreactor and the temperature maintenance fluid in order to maintain the first set point temperature of the first bioreactor when the first bioreactor is vitally supporting the first microorganism(s), and the two or more first frame rails can mechanically support the first bioreactor. In these or other embodiments, the two or more first frame rails can receive the temperature maintenance fluid in parallel. In these or other embodiments, the two or more first frame rails

can comprise stainless steel, and the temperature maintenance fluid can comprise water. In these or other embodiments, the support structure can comprise a floor gap underneath one of the first frame or the second frame to permit the first bioreactor to bulge into the floor gap when the support structure is mechanically supporting the first bioreactor. In these or other embodiments, the system can further comprise at least one light source mechanically supported by the support structure and operable to illuminate the first microorganism(s) when the first bioreactor is vitally supporting the first microorganism(s) and when the support structure is mechanically supporting the first bioreactor.

In these or other embodiments, the support structure can mechanically support a second bioreactor. The support structure can comprise a third frame and a fourth frame together being operable to mechanically support the second bioreactor in interposition between the third frame and the fourth frame, the third frame can maintain a second set point temperature of the second bioreactor when the second bioreactor is vitally supporting one or more second microorganisms and when the support structure is mechanically supporting the second bioreactor, and the second bioreactor can vitally support the second microorganism(s). Meanwhile, the second bioreactor can comprise a second bioreactor cavity configured to contain the second microorganism(s) and a second fluidic support medium, and can comprise one or more second bioreactor walls at least partially forming the second bioreactor cavity. Further, the second bioreactor wall(s) can comprise at least one second bioreactor wall material and the at least one second bioreactor wall material can be flexible. In these or other embodiments, the first set point temperature of the first bioreactor can be approximately equal to the second set point temperature of the second bioreactor. In these or other embodiments, the first microorganism(s) can comprise the second microorganism(s).

Some embodiments include a system. The system comprises a support means for mechanically supporting a first bioreactor and maintaining a first set point temperature of the first bioreactor when the first bioreactor is vitally supporting one or more first microorganisms and when the support means is mechanically supporting the first bioreactor. The first bioreactor can be operable to vitally support the first microorganism(s). Further, the first bioreactor can comprise a first bioreactor cavity configured to contain the first microorganism(s) and a first fluidic support medium, and can comprise one or more first bioreactor walls at least partially forming the first bioreactor cavity. Also, the first bioreactor wall(s) can comprise at least one first bioreactor wall material and the at least one first bioreactor wall material can be flexible.

In these or other embodiments, the support means can further be for mechanically supporting a second bioreactor and maintaining a second set point temperature of the second bioreactor when the second bioreactor is vitally supporting one or more second microorganisms and when the support means is mechanically supporting the second bioreactor. Further, the second bioreactor can vitally support the second microorganism(s). Meanwhile, the second bioreactor can comprise a second bioreactor cavity configured to contain the second microorganism(s) and a second fluidic support medium, and can comprise one or more second bioreactor walls at least partially forming the second bioreactor cavity. Also, the second bioreactor wall(s) can comprise at least one second bioreactor wall material and the at least one second bioreactor wall material can be flexible.

Some embodiments include a method. The method can comprise providing a support structure operable to mechanically support a first bioreactor operable to vitally support one or more first microorganisms. Meanwhile, providing the support structure can comprise: providing a first frame; providing a second frame; and configuring the first frame and the second frame such that the first frame and the second frame together are operable to mechanically support the first bioreactor in interposition between the first frame and the second frame. Further, the first frame can maintain a first set point temperature of the first bioreactor when the first bioreactor is vitally supporting the first microorganism(s) and when the support structure is mechanically supporting the first bioreactor. Further still, the first bioreactor can comprise a first bioreactor cavity configured to contain the first microorganism(s) and a first fluidic support medium, and can comprise one or more first bioreactor walls at least partially forming the first bioreactor cavity. Also, the one or more first bioreactor walls can comprise at least one first bioreactor wall material and the at least one first bioreactor wall material can be flexible.

In these or other embodiments, the method can comprise providing the first bioreactor, and interposing the first bioreactor between the first frame and the second frame. In these or other embodiments, providing the first frame can comprise providing two or more first frame rails. Further, each first frame rail of the two or more first frame rails can comprise a first frame rail conduit, each first frame rail conduit of the two or more first frame rail conduits can convey a temperature maintenance fluid to exchange thermal energy between the first bioreactor and the temperature maintenance fluid in order to maintain the first set point temperature of the first bioreactor when the first bioreactor is vitally supporting the first microorganism(s), and the two or more first frame rails can mechanically support the first bioreactor. In these or other embodiments, the method can comprise providing the temperature maintenance fluid to the first frame rail conduit of the two or more first frame rails.

Some embodiments can include a method. The method can comprise: vitally supporting one or more first microorganisms at a first bioreactor, the first bioreactor comprising (i) a first bioreactor cavity configured to contain the first microorganism(s) and a first fluidic support medium and (ii) one or more first bioreactor walls at least partially forming the first bioreactor cavity, the one or more first bioreactor walls comprising at least one first bioreactor wall material, and the at least one first bioreactor wall material being flexible; mechanically supporting the first bioreactor between a first frame and a second frame of a support structure; and supplying a temperature maintenance fluid to the first frame to maintain a first set point temperature of the first bioreactor while vitally supporting the first microorganism(s) at the first bioreactor and while mechanically supporting the first bioreactor between the first frame and the second frame of the support structure.

In these or other embodiments, the method can comprise supplying the temperature maintenance fluid to the second frame to maintain the first set point temperature of the first bioreactor while vitally supporting the first microorganism(s) at the first bioreactor and while mechanically supporting the first bioreactor between the first frame and the second frame of the support structure. In these or other embodiments, the method can further comprise: vitally supporting one or more second microorganisms at a second bioreactor, the second bioreactor comprising (i) a second bioreactor cavity configured to contain the second microorganism(s) and a second fluidic support medium and (ii) one

or more second bioreactor walls at least partially forming the second bioreactor cavity, the one or more second bioreactor walls comprising at least one second bioreactor wall material, and the at least one second bioreactor wall material being flexible; mechanically supporting the second bioreactor between a third frame and a fourth frame of the support structure; and supplying the temperature maintenance fluid to the third frame to maintain a second set point temperature of the second bioreactor while vitally supporting the second microorganism(s) at the second bioreactor and while mechanically supporting the second bioreactor between the third frame and the fourth frame of the support structure.

Some embodiments can include a system. The system can comprise a bioreactor operable to vitally support one or more microorganisms. Further, the bioreactor can comprise a bioreactor cavity configured to contain the microorganism(s) and a fluidic support medium, and can comprise one or more bioreactor walls at least partially forming the bioreactor cavity. Also, the bioreactor wall(s) comprising at least one bioreactor wall material. Meanwhile, the at least one bioreactor wall material can be flexible, and the bioreactor can be configured to be folded up and/or rolled up.

In these or other embodiments, at least one of (a) when the microorganism(s) are taxonomically classified in taxonomic family Haematococcaceae, the bioreactor can vitally support the microorganism(s) such that an average density of the microorganism(s) is greater than or equal to approximately 12 grams per liter and/or an average maximum production rate of the microorganism(s) is greater than or equal to approximately 2.5 grams per liter per day; (b) when the microorganism(s) are taxonomically classified in taxonomic family Chlorellaceae, and the bioreactor can vitally support the microorganism(s) such that an average density of the microorganism(s) is greater than or equal to approximately 36 grams per liter, and/or an average maximum production rate of the microorganism(s) is greater than or equal to approximately 9 grams per liter per day; and/or (c) when the microorganism(s) are taxonomically classified in taxonomic family Chlamydomonadaceae, the bioreactor can vitally support the microorganism(s) such that an average density of the microorganism(s) is greater than or equal to approximately 7 grams per liter and/or an average maximum production rate of the microorganism(s) is greater than or equal to approximately 3 grams per liter per day.

In these or other embodiments, the bioreactor can be autoclaved one or more times to sterilize the bioreactor. In these or other embodiments, the bioreactor can comprise one or more bioreactor fittings in communication with the bioreactor cavity, one or more gas delivery devices disposed within the bioreactor cavity, and one or more flexible tubes disposed within the bioreactor cavity. Further, the bioreactor fitting(s) can comprise at least one gas delivery fitting, the gas delivery device(s) can inject gas into the first bioreactor cavity to mix the microorganism(s), and the flexible tube(s) can comprise at least one gas delivery tube coupling the gas delivery device(s) to the gas delivery fitting(s).

In these or other embodiments, the one or more gas delivery devices can be configured so that the gas injected by the gas delivery device(s) into the bioreactor comprises gas bubbles comprising a diameter greater than or equal to approximately 40 micrometers and less than or equal to approximately 2 millimeters and/or a volumetric flow rate of greater than or equal to approximately 10 liters per minute and less than or equal to approximately 120 liters per minute.

In these or other embodiments, the bioreactor can comprise a photobioreactor and the at least one bioreactor wall material can be at least partially transparent, and/or the bioreactor can comprise one or more bioreactor fittings in communication with the bioreactor cavity. Further, the bioreactor fitting(s) can comprise at least one organic carbon material delivery fitting operable to supply organic carbon material to the microorganism(s). In these or other embodiments, the at least one bioreactor wall material can comprise polypropylene and polyamide. In these or other embodiments, the bioreactor cavity can be substantially axenic when operating to vitally support the microorganism(s). In these or other embodiments, the bioreactor cavity can comprise a volume greater than or equal to approximately 18.92 liters.

In these or other embodiments, the system can further comprise a support structure operable to mechanically support the first bioreactor. Further, the support structure can comprise a first frame and a second frame together being operable to mechanically support the first bioreactor in interposition between the first frame and the second frame, and the first frame can maintain a first set point temperature of the first bioreactor when the first bioreactor is vitally supporting the first microorganism(s) and when the support structure is mechanically supporting the first bioreactor. In these or other embodiments, the second frame can maintain the first set point temperature of the first bioreactor when the first bioreactor is vitally supporting the first microorganism(s) and when the support structure is mechanically supporting the first bioreactor. In these or other embodiments, the first frame can comprise two or more first frame rails, each first frame rail of the two or more first frame rails can comprise a first frame rail conduit, each first frame rail conduit of the two or more first frame rail conduits can convey a temperature maintenance fluid to exchange thermal energy between the first bioreactor and the temperature maintenance fluid in order to maintain the first set point temperature of the first bioreactor when the first bioreactor is vitally supporting the first microorganism(s), and the two or more first frame rails can mechanically support the first bioreactor. In these or other embodiments, the two or more first frame rails can receive the temperature maintenance fluid in parallel.

Some embodiments include a system. The system can comprise a bioreactor operable to vitally support one or more microorganisms. Further, the bioreactor can comprise a bioreactor cavity means for containing the microorganism(s) and a fluidic support medium. In these or other embodiments, at least one of (a) when the microorganism(s) are taxonomically classified in taxonomic family Haematococcaceae, the bioreactor can vitally support the microorganism(s) such that an average density of the microorganism(s) is greater than or equal to approximately 12 grams per liter and/or an average maximum production rate of the microorganism(s) is greater than or equal to approximately 2.5 grams per liter per day; (b) when the microorganism(s) are taxonomically classified in taxonomic family Chlorellaceae, and the bioreactor can vitally support the microorganism(s) such that an average density of the microorganism(s) is greater than or equal to approximately 36 grams per liter, and/or an average maximum production rate of the microorganism(s) is greater than or equal to approximately 9 grams per liter per day; and/or (c) when the microorganism(s) are taxonomically classified in taxonomic family Chlamydomonadaceae, the bioreactor can vitally support the microorganism(s) such that an average density of the microorganism(s) is greater than or equal to approxi-

mately 7 grams per liter and/or an average maximum production rate of the microorganism(s) is greater than or equal to approximately 3 grams per liter per day.

Some embodiments include a method. The method can comprise providing a bioreactor operable to vitally support one or more microorganisms. Further, providing the bioreactor can comprise: providing one or more bioreactor walls, the bioreactor wall(s) comprising at least one bioreactor wall material and the at least one bioreactor wall material being flexible; and coupling together the bioreactor wall(s) so that the bioreactor wall(s) at least partially form a bioreactor cavity configured to contain the microorganism(s) and a fluidic support medium. In these or other embodiments, at least one of (a) when the microorganism(s) are taxonomically classified in taxonomic family Haematococcaceae, the bioreactor can vitally support the microorganism(s) such that an average density of the microorganism(s) is greater than or equal to approximately 12 grams per liter and/or an average maximum production rate of the microorganism(s) is greater than or equal to approximately 2.5 grams per liter per day; (b) when the microorganism(s) are taxonomically classified in taxonomic family Chlorellaceae, and the bioreactor can vitally support the microorganism(s) such that an average density of the microorganism(s) is greater than or equal to approximately 36 grams per liter, and/or an average maximum production rate of the microorganism(s) is greater than or equal to approximately 9 grams per liter per day; and/or (c) when the microorganism(s) are taxonomically classified in taxonomic family Chlamydomonadaceae, the bioreactor can vitally support the microorganism(s) such that an average density of the microorganism(s) is greater than or equal to approximately 7 grams per liter and/or an average maximum production rate of the microorganism(s) is greater than or equal to approximately 3 grams per liter per day.

In these or other embodiments, coupling together the bioreactor wall(s) so that the bioreactor wall(s) at least partially form the bioreactor cavity can comprise bonding together by heat welding the bioreactor wall(s) so that the bioreactor wall(s) at least partially form the bioreactor cavity. Further, the at least one bioreactor wall material can comprise a polymer material.

Some embodiments include a method. The method can comprise: inoculating a bioreactor with one or more first microorganisms and a first fluidic support medium, the bioreactor comprising one or more bioreactor walls at least partially forming a bioreactor cavity, the bioreactor being configured to be at least one of folded up or rolled up, the bioreactor wall(s) comprising at least one bioreactor wall material, and the at least one bioreactor wall material being flexible; and vitally supporting the first microorganism(s) with the bioreactor such that: (a) when the microorganism(s) are taxonomically classified in taxonomic family Haematococcaceae, the bioreactor can vitally support the microorganism(s) such that an average density of the microorganism(s) is greater than or equal to approximately 12 grams per liter and/or an average maximum production rate of the microorganism(s) is greater than or equal to approximately 2.5 grams per liter per day; (b) when the microorganism(s) are taxonomically classified in taxonomic family Chlorellaceae, and the bioreactor can vitally support the microorganism(s) such that an average density of the microorganism(s) is greater than or equal to approximately 36 grams per liter, and/or an average maximum production rate of the microorganism(s) is greater than or equal to approximately 9 grams per liter per day; and/or (c) when the microorganism(s) are taxonomically classified in taxonomic

family Chlamydomonadaceae, the bioreactor can vitally support the microorganism(s) such that an average density of the microorganism(s) is greater than or equal to approximately 7 grams per liter and/or an average maximum production rate of the microorganism(s) is greater than or equal to approximately 3 grams per liter per day.

In these or other embodiments, the method can further comprise: after vitally supporting the first microorganism(s), autoclaving the bioreactor; after autoclaving the bioreactor, inoculating the bioreactor with one or more second microorganisms; and after inoculating the bioreactor with the second microorganism(s), vitally supporting the second microorganism(s) with the bioreactor.

In these or other embodiments, the method can further comprise: mechanically supporting the bioreactor with a support structure comprising a first frame and a second frame together being operable to mechanically support the bioreactor in interposition between the first frame and the second frame; and supplying a temperature maintenance fluid to the first frame to maintain a set point temperature of the bioreactor while vitally supporting the first microorganism(s) and while mechanically supporting the bioreactor with the support structure.

Some embodiments include a system. The system can comprise a bioreactor operable to vitally support one or more microorganisms and enclose the one or more microorganisms and a fluidic support medium. Meanwhile, the bioreactor can comprise a bioreactor cavity, one or more bioreactor walls at least partially forming the bioreactor cavity and comprising at least one bioreactor wall material, one or more bioreactor fittings in communication with the bioreactor cavity, one or more gas delivery devices disposed within the bioreactor cavity, one or more flexible tubes disposed within the bioreactor cavity, and at least one parameter sensing device. The one or more bioreactor fittings can comprise at least one gas delivery fitting, the one or more gas delivery devices can be operable to inject gas into the bioreactor cavity to mix the one or more microorganisms, and/or the one or more flexible tubes can comprise at least one gas delivery tube coupling the one or more gas delivery devices to the at least one gas delivery fitting. Further, the at least one bioreactor wall material can be flexible. Further still, while the bioreactor is assembled to include the one or more bioreactor fittings, the one or more gas delivery devices, the one or more flexible tubes, and the at least one parameter sensing device, the bioreactor can be configured so that the bioreactor, as assembled, is able to be autoclaved one or more times to sterilize the bioreactor; and while the bioreactor is assembled to include the one or more bioreactor fittings, the one or more gas delivery devices, the one or more flexible tubes, and the at least one parameter sensing device, the bioreactor, as assembled, is configured to be at least one of folded up or rolled up.

Some embodiments include a system. The system can comprise a bioreactor operable to vitally support one or more microorganisms. Meanwhile, the bioreactor can comprise a bioreactor cavity means for containing the one or more microorganisms and a fluidic support medium, a parameter sensing means for monitoring a cavity environment condition at the bioreactor, and a bioreactor mixing means for mixing the one or more microorganisms. Further, while the bioreactor is assembled to include the bioreactor cavity means, the parameter sensing means, and the bioreactor mixing means, the bioreactor, as assembled, is configured to be at least one of folded up or rolled up; and while the bioreactor is assembled to include the bioreactor cavity means, the parameter sensing means, and the bioreactor

mixing means, and while the bioreactor, as assembled, is at least one of folded up or rolled up, the bioreactor is configured so that the bioreactor, as assembled, is able to be autoclaved one or more times to sterilize the bioreactor.

Some embodiments include a system. The system can comprise a support structure configured to mechanically support a first bioreactor. Meanwhile, the support structure can comprise a first frame and a second frame, together with the first frame, being configured to mechanically support the first bioreactor in interposition between the first frame and the second frame. The first frame can be configured to maintain a first set point temperature of the first bioreactor through an exchange of thermal energy between the first frame and the first bioreactor when the first bioreactor is vitally supporting one or more first microorganisms and when the support structure is mechanically supporting the first bioreactor. Further, the first bioreactor can comprise a first bioreactor cavity configured to contain the one or more first microorganisms and a first fluidic support medium, and one or more first bioreactor walls at least partially enclosing the first bioreactor cavity. The one or more first bioreactor walls can comprise at least one first bioreactor wall material, and the at least one first bioreactor wall material can be flexible.

Some embodiments include a system. The system can comprise a support means configured to mechanically support a first bioreactor and maintain a first set point temperature of the first bioreactor through an exchange of thermal energy between the support means and the first bioreactor when the first bioreactor is vitally supporting one or more first microorganisms and when the support means is mechanically supporting the first bioreactor. Meanwhile, the first bioreactor can comprise a first bioreactor cavity configured to contain the one or more first microorganisms and a first fluidic support medium, and one or more first bioreactor walls at least partially enclosing the first bioreactor cavity. The one or more first bioreactor walls can comprise at least one first bioreactor wall material, and the at least one first bioreactor wall material can be flexible.

Some embodiments include a system. The system can comprise a support structure configured to mechanically support a first bioreactor. Meanwhile, the support structure can comprise a first frame and a second frame, together with the first frame, being configured to mechanically support the first bioreactor in interposition between the first frame and the second frame. The first frame can be configured to maintain a first set point temperature of the first bioreactor through an exchange of thermal energy between the first frame and the first bioreactor when the first bioreactor is vitally supporting one or more first microorganisms and when the support structure is mechanically supporting the first bioreactor. Further, the second frame can be configured to maintain the first set point temperature of the first bioreactor through an exchange of thermal energy between the second frame and the first bioreactor when the first bioreactor is vitally supporting the one or more first microorganisms and when the support structure is mechanically supporting the first bioreactor. Also, the first bioreactor can comprise a first bioreactor cavity configured to contain the one or more first microorganisms and a first fluidic support medium, and one or more first bioreactor walls at least partially enclosing the first bioreactor cavity. The one or more first bioreactor walls can comprise at least one first bioreactor wall material, and the at least one first bioreactor wall material can be flexible. Further, the first frame can comprise two or more first frame rails, and each first frame rail of the two or more first frame rails can comprise a first

frame rail conduit. Meanwhile, each first frame rail conduit of the two or more first frame rail conduits can be configured to convey a temperature maintenance fluid to exchange first thermal energy between the first bioreactor and the temperature maintenance fluid in order to maintain the first set point temperature of the first bioreactor when the first bioreactor is vitally supporting the one or more first microorganisms, and the two or more first frame rails can be operable to mechanically support the first bioreactor.

Some embodiments include a method. The method can comprise: providing one or more bioreactor walls of a bioreactor, the one or more bioreactor walls comprising at least one bioreactor wall material; providing one or more bioreactor fittings of the bioreactor, the one or more bioreactor fittings comprising at least one gas delivery fitting; providing one or more gas delivery devices of the bioreactor; providing one or more flexible tubes of the bioreactor, the one or more flexible tubes comprising at least one gas delivery tube; providing at least one parameter sensing device; and assembling the bioreactor. Further, assembling the bioreactor can comprise: coupling together the one or more bioreactor walls to at least partially form a bioreactor cavity of the bioreactor, the bioreactor cavity being configured to contain one or more microorganisms and a fluidic support medium; coupling the one or more bioreactor fittings to the one or more bioreactor walls; coupling the one or more gas delivery devices to the at least one gas delivery fitting with the at least one gas delivery tube; placing the one or more gas delivery devices inside the bioreactor cavity while the one or more gas delivery devices are coupled to the at least one gas delivery fitting by the at least one gas delivery tube; and placing the at least one parameter sensing device in at least one bioreactor fitting of the one or more bioreactor fittings. Meanwhile, when the bioreactor is assembled, the bioreactor can be operable to vitally support the one or more microorganisms. Further, the one or more bioreactor fittings can communicate with the bioreactor cavity when the bioreactor fittings are coupled to the one or more bioreactor walls and when the one or more bioreactor walls are coupled together, the one or more gas delivery devices can be operable to inject gas into the bioreactor cavity to mix the one or more microorganisms, and the at least one bioreactor wall material can be flexible. Further still, while the bioreactor is assembled to include the one or more bioreactor fittings, the one or more gas delivery devices, the one or more flexible tubes, and the at least one parameter sensing device, the bioreactor can be configured so that the bioreactor, as assembled, is able to be autoclaved one or more times to sterilize the bioreactor; and while the bioreactor is assembled to include the one or more bioreactor fittings, the one or more gas delivery devices, the one or more flexible tubes, and the at least one parameter sensing device, the bioreactor, as assembled, can be configured to be at least one of folded up or rolled up.

In these or other embodiments, providing the one or more bioreactor fittings of the bioreactor can comprise providing a pressure regulation device for limiting a bioreactor cavity pressure of the bioreactor cavity. Further, providing the one or more bioreactor fittings of the bioreactor can comprise providing a filter for filtering a supply of at least one of a gas, one or more nutritional media, or the fluidic support medium.

Some embodiments include a method of culturing one or more microalgae. The method can comprise: inoculating a bioreactor with the one or more microalgae and a fluidic support medium, the bioreactor comprising one or more bioreactor walls at least partially enclosing a bioreactor

cavity, being configured to be at least one of folded up or rolled up, and being sterile when the bioreactor is inoculated with the one or more microalgae, the one or more bioreactor walls comprising at least one bioreactor wall material, the at least one bioreactor wall material being flexible and at least partially transparent; and vitally supporting the one or more microalgae. Meanwhile, vitally supporting the one or more microalgae can comprise: supplying the one or more microalgae with an organic carbon material; supplying the one or more microalgae with a quantity of light based on the culture density; and supplying one or more nutritional media to the one or more microalgae when a culture density of the one or more microalgae reaches a threshold culture density.

Some embodiments include a method. The method can comprise: inoculating a bioreactor with one or more first microorganisms and a first fluidic support medium, the bioreactor comprising one or more bioreactor walls at least partially enclosing a bioreactor cavity, being configured to be at least one of folded up or rolled up, and being sterile when the bioreactor is inoculated with the one or more first microorganisms, the one or more bioreactor walls comprising at least one bioreactor wall material, and the at least one bioreactor wall material being flexible and at least partially transparent; and vitally supporting the one or more first microorganisms with the bioreactor, a supply of light, and a supply of organic carbon, such that at least one of: (i) when the one or more first microorganisms are taxonomically classified in taxonomic family Haematococcaceae, at least one of an average density of the one or more first microorganisms is greater than or equal to approximately 12 grams per liter or an average maximum production rate of the one or more first microorganisms is greater than or equal to approximately 2.5 grams per liter per day, (ii) when the one or more first microorganisms are taxonomically classified in taxonomic family Chlorellaceae, at least one of the average density of the one or more first microorganisms is greater than or equal to approximately 36 grams per liter or the average maximum production rate of the one or more first microorganisms is greater than or equal to approximately 9 grams per liter per day, or (iii) when the one or more first microorganisms are taxonomically classified in taxonomic family Chlamydomonadaceae, at least one of the average density of the one or more first microorganisms is greater than or equal to approximately 7 grams per liter or the average maximum production rate of the one or more first microorganisms is greater than or equal to approximately 3 grams per liter per day.

Some embodiments include a method. The method can comprise: inoculating a bioreactor with one or more first microorganisms and a first fluidic support medium, the bioreactor comprising one or more bioreactor walls at least partially enclosing a bioreactor cavity, being configured to be at least one of folded up or rolled up, and being sterile when the bioreactor is inoculated with the one or more first microorganisms, the one or more bioreactor walls comprising at least one bioreactor wall material, and the at least one bioreactor wall material being flexible and at least partially transparent; vitally supporting the one or more first microorganisms with the bioreactor, a supply of light, and a supply of organic carbon, such that at least one of: (i) when the one or more first microorganisms are taxonomically classified in taxonomic family Haematococcaceae, at least one of an average density of the one or more first microorganisms is greater than or equal to approximately 12 grams per liter or an average maximum production rate of the one or more first microorganisms is greater than or equal to approximately 2.5 grams per liter per day, (ii) when the one or more first

microorganisms are taxonomically classified in taxonomic family Chlorellaceae, at least one of the average density of the one or more first microorganisms is greater than or equal to approximately 36 grams per liter or the average maximum production rate of the one or more first microorganisms is greater than or equal to approximately 9 grams per liter per day, or (iii) when the one or more first microorganisms are taxonomically classified in taxonomic family Chlamydomonadaceae, at least one of the average density of the one or more first microorganisms is greater than or equal to approximately 7 grams per liter or the average maximum production rate of the one or more first microorganisms is greater than or equal to approximately 3 grams per liter per day; mechanically supporting the bioreactor with a support structure comprising a first frame and a second frame together being operable to mechanically support the bioreactor in interposition between the first frame and the second frame; and supplying a temperature maintenance fluid to the first frame to maintain a set point temperature of the bioreactor through an exchange of thermal energy between the first frame and the bioreactor while vitally supporting the one or more first microorganisms with the bioreactor and while mechanically supporting the bioreactor with the support structure.

Some embodiments include a method. The method can comprise: conducting a first sterilization of an assembled bioreactor, wherein sterilizing the assembled bioreactor comprises at least one of gamma irradiating the assembled bioreactor or autoclaving the assembled bioreactor; after conducting the first sterilization of the assembled bioreactor, vitally supporting one or more first microorganisms with the assembled bioreactor; after vitally supporting the one or more first microorganisms with the assembled bioreactor, removing the one or more first microorganisms from the assembled bioreactor; after removing the one or more first microorganisms from the assembled bioreactor, gathering up the assembled bioreactor, wherein gathering up the assembled bioreactor after removing the one or more first microorganisms from the assembled bioreactor comprises at least one of folding the assembled bioreactor after removing the one or more first microorganisms from the assembled bioreactor or rolling up the assembled bioreactor after removing the one or more first microorganisms from the assembled bioreactor; after gathering up the assembled bioreactor, conducting a second sterilization of the assembled bioreactor, wherein the second sterilization of the assembled bioreactor comprises autoclaving the bioreactor; and after conducting the second sterilization of the assembled bioreactor, vitally supporting one or more second microorganisms with the assembled bioreactor.

Some embodiments include a method. The method can comprise: gathering up an assembled bioreactor before conducting a first sterilization of the assembled bioreactor, wherein gathering up the assembled bioreactor before conducting the first sterilization of the assembled bioreactor comprises at least one of folding the assembled bioreactor before sterilizing the bioreactor or rolling up the bioreactor before sterilizing the assembled bioreactor; conducting the first sterilization of the assembled bioreactor, wherein sterilizing the assembled bioreactor comprises at least one of gamma irradiating the assembled bioreactor or autoclaving the assembled bioreactor; after conducting the first sterilization of the assembled bioreactor, vitally supporting one or more first microorganisms with the assembled bioreactor; after vitally supporting the one or more first microorganisms with the assembled bioreactor, removing the one or more first microorganisms from the assembled bioreactor; after

removing the one or more first microorganisms from the assembled bioreactor, gathering up the assembled bioreactor, wherein gathering up the assembled bioreactor after removing the one or more first microorganisms from the assembled bioreactor comprises at least one of folding the assembled bioreactor after removing the one or more first microorganisms from the assembled bioreactor or rolling up the assembled bioreactor after removing the one or more first microorganisms from the assembled bioreactor; after gathering up the assembled bioreactor, conducting a second sterilization of the assembled bioreactor, wherein the second sterilization of the assembled bioreactor comprises autoclaving the bioreactor; and after conducting the second sterilization of the assembled bioreactor, vitally supporting one or more second microorganisms with the assembled bioreactor. Meanwhile, the assembled bioreactor can comprise a greatest physical dimension, and the assembled bioreactor can be the at least one of folded up or rolled up such that the greatest physical dimension is reducible by at least approximately 75%.

Some embodiments include a method. The method can comprise: providing a support structure; and providing a bioreactor operable to vitally support one or more microorganisms. The bioreactor can comprise a bioreactor cavity configured to contain the one or more microorganisms and a fluidic support medium, and one or more bioreactor walls at least partially enclosing the bioreactor cavity. Meanwhile, the one or more bioreactor walls can comprise at least one bioreactor wall material, and the at least one bioreactor wall material can be flexible. Also, the support structure can be operable to mechanically support the bioreactor. Further, providing the support structure can comprise: providing a first frame; providing a second frame; and configuring the first frame and the second frame such that the first frame and the second frame together are operable to mechanically support the bioreactor in interposition between the first frame and the second frame. The first frame can be further operable to maintain a set point temperature of the bioreactor through an exchange of thermal energy between the first frame and the bioreactor when the bioreactor is vitally supporting the one or more microorganisms and when the support structure is mechanically supporting the bioreactor.

Some embodiments include a method. The method can comprise: providing a support structure; providing a bioreactor operable to vitally support one or more microorganisms; and interposing the bioreactor between the first frame and the second frame. The bioreactor can comprise a bioreactor cavity configured to contain the one or more microorganisms and a fluidic support medium, and one or more bioreactor walls at least partially enclosing the bioreactor cavity. Meanwhile, the one or more bioreactor walls can comprise at least one bioreactor wall material, and the at least one bioreactor wall material can be flexible. Also, the support structure can be operable to mechanically support the bioreactor. Further, providing the support structure can comprise: providing a first frame; providing a second frame; and configuring the first frame and the second frame such that the first frame and the second frame together are operable to mechanically support the bioreactor in interposition between the first frame and the second frame. Further still, the first frame can be operable to maintain a set point temperature of the bioreactor through an exchange of thermal energy between the first frame and the bioreactor when the bioreactor is vitally supporting the one or more microorganisms and when the support structure is mechanically supporting the bioreactor, and the second frame can be operable to maintain the set point temperature of the biore-

actor through an exchange of thermal energy between the second frame and the bioreactor when the bioreactor is vitally supporting the one or more first microorganisms and when the support structure is mechanically supporting the bioreactor.

Turning to the drawings, FIG. 1 illustrates an exemplary block diagram of a system 100, according to an embodiment. System 100 is merely exemplary and is not limited to the embodiments presented herein. System 100 can be employed in many different embodiments or examples not specifically depicted or described herein.

System 100 comprises a bioreactor 101. Meanwhile, bioreactor 101 comprises a bioreactor cavity 102 and one or more bioreactor walls 103. Further, bioreactor 101 can comprise one or more bioreactor fittings 104, one or more gas delivery devices 105, one or more flexible tubes 106, one or more parameter sensing devices 109, and/or one or more pressure regulators 117.

In many embodiments, bioreactor fitting(s) 104 can comprise one or more gas delivery fittings 107, one or more fluidic support medium delivery fittings 110, one or more organic carbon material delivery fittings 111, one or more bioreactor exhaust fittings 112, one or more bioreactor sample fittings 113, and/or one or more parameter sensing device fittings 121. In these or other embodiments, flexible tube(s) 106 can comprise one or more gas delivery tubes 108, one or more organic carbon material delivery tubes 114, one or more bioreactor sample tubes 115, and/or one or more fluidic support medium delivery tubes 116. Further, in these or other embodiments, parameter sensing device(s) 109 can comprise one or more pressure sensors 118, one or more temperature sensors 119, one or more pH sensors 120, and/or one or more chemical sensors 122.

As explained in greater detail herein, bioreactor 101 is operable to vitally support (e.g., sustain, grow, nurture, cultivate, etc.) one or more organisms (e.g., one or more macroorganisms, one or more microorganisms, etc.). In these or other embodiments, the organism(s) can comprise one or more autotrophic organisms or one or more heterotrophic organisms. In further embodiments, the organism(s) can comprise one or more mixotrophic organisms. In many embodiments, the organism(s) can comprise one or more phototrophic organisms. In still other embodiments, the organism(s) can comprise one or more genetically modified organisms. In some embodiments, the organism(s) vitally supported by bioreactor 101 can comprise one or more organism(s) of a single type, multiple single organisms of different types, or multiple ones of one or more organisms of different types.

In many embodiments, exemplary microorganism(s) that bioreactor 101 may be implemented to vitally support can include algae (e.g., microalgae), fungi (e.g., mold), and/or cyanobacteria. For example, in many embodiments, bioreactor 101 can be implemented to vitally support microalgae that are taxonomically classified in one or more of the following taxonomic phyla: Chlorophyta, Cyanophyta (Cyanobacteria), and Heterokontophyta. Further, in many embodiments, bioreactor 101 can be implemented to vitally support microalgae that are taxonomically classified in one or more of the following taxonomic classes: Bacillariophyceae, Eustigmatophyceae, Chrysophyceae, Chlorophyceae, and Trebouxiophyceae. Further still, in many embodiments, bioreactor 101 can be implemented to vitally support microalgae that are taxonomically classified in one or more of the following taxonomic families: Chlorellaceae, Haematococcaceae, Scenedesmaceae, Porphyridiaceae, Chlamydomonadaceae, or Micractiniaceae. Even further still, in

various embodiments, bioreactor **101** can be implemented to vitally support microalgae that are taxonomically classified in one or more of the following taxonomic genera: sp. *Nannochloropsis*, *Chlorella*, *Haematococcus*, *Dunaliella*, *Scenedesmus*, *Selenastrum*, *Oscillatoria*, *Phormidium*, *Porphyridium*, *Chlamydomonas*, *Micractinium*, *Spirulina*, *Amphora*, and *Ochromonas*. Even further still yet, in a variety of embodiments, bioreactor **101** can be implemented to vitally support microalgae that are taxonomically classified in one or more of the following taxonomic species: *Achnanthes orientalis*, *Agmenellum* spp., *Amphiprora hyaline*, *Amphora coffeiformis*, *Amphora coffeiformis* var. *linea*, *Amphora coffeiformis* var. *punctata*, *Amphora coffeiformis* var. *taylori*, *Amphora coffeiformis* var. *tenuis*, *Amphora delicatissima*, *Amphora delicatissima* var. *capitata*, *Amphora* sp., *Anabaena*, *Ankistrodesmus*, *Ankistrodesmus falcatus*, *Boekelovia hooglandii*, *Borodinella* sp., *Botryococcus braunii*, *Botryococcus sudeticus*, *Bracteococcus minor*, *Bracteococcus medionucleatus*, *Carteria*, *Chaetoceros gracilis*, *Chaetoceros muelleri*, *Chaetoceros muelleri* var. *subsalsum*, *Chaetoceros* sp., *Chlamydomas perigranulata*, *Chlorella anitrata*, *Chlorella antarctica*, *Chlorella aureoviridis*, *Chlorella Candida*, *Chlorella capsulate*, *Chlorella desiccata*, *Chlorella ellipsoidea*, *Chlorella emersonii*, *Chlorella fusca*, *Chlorella fusca* var. *vacuolata*, *Chlorella glucotropha*, *Chlorella infusioinum*, *Chlorella infusioinum* var. *actophila*, *Chlorella infusioinum* var. *auxenophila*, *Chlorella kessleri*, *Chlorella lobophora*, *Chlorella luteoviridis*, *Chlorella luteoviridis* var. *aureoviridis*, *Chlorella luteoviridis* var. *lutescens*, *Chlorella miniata*, *Chlorella minutissima*, *Chlorella mutabilis*, *Chlorella nocturna*, *Chlorella ovalis*, *Chlorella parva*, *Chlorella photophila*, *Chlorella pringsheimii*, *Chlorella protothecoides*, *Chlorella protothecoides* var. *acidicola*, *Chlorella regularis*, *Chlorella regularis* var. *minima*, *Chlorella regularis* var. *umbricata*, *Chlorella reisiglii*, *Chlorella saccharophila*, *Chlorella saccharophila* var. *ellipsoidea*, *Chlorella salina*, *Chlorella simplex*, *Chlorella sorokiniana*, *Chlorella* sp., *Chlorella sphaerica*, *Chlorella stigmatophora*, *Chlorella vanniellii*, *Chlorella vulgaris*, *Chlorella vulgaris* fo. *tertia*, *Chlorella vulgaris* var. *autotrophica*, *Chlorella vulgaris* var. *viridis*, *Chlorella vulgaris* var. *vulgaris*, *Chlorella vulgaris* var. *vulgaris* fo. *tertia*, *Chlorella vulgaris* var. *vulgaris* fo. *viridis*, *Chlorella xanthella*, *Chlorella zofingiensis*, *Chlorella trebouxioides*, *Chlorella vulgaris*, *Chlorococcum infusioinum*, *Chlorococcum* sp., *Chlorogonium*, *Chroomonas* sp., *Chryso-sphaera* sp., *Cricosphaera* sp., *Cryptocodinium cohnii*, *Cryptomonas* sp., *Cyclotella cryptica*, *Cyclotella meneghiniana*, *Cyclotella* sp., *Dunaliella* sp., *Dunaliella bardawil*, *Dunaliella bioculata*, *Dunaliella granulate*, *Dunaliella maritime*, *Dunaliella minuta*, *Dunaliella parva*, *Dunaliella peircei*, *Dunaliella primolecta*, *Dunaliella salina*, *Dunaliella terricola*, *Dunaliella tertiolecta*, *Dunaliella viridis*, *Dunaliella tertiolecta*, *Eremosphaera viridis*, *Eremosphaera* sp., *Ellipsoidon* sp., *Euglena* spp., *Franceia* sp., *Fragilaria crotonensis*, *Fragilaria* sp., *Gleocapsa* sp., *Gleothamnion* sp., *Haematococcus pluvialis*, *Hymenomonas* sp., *Isochrysis* aff. *galbana*, *Isochrysis galbana*, *Lepocinclis*, *Micractinium*, *Micractinium*, *Monoraphidium minutum*, *Monoraphidium* sp., *Nannochloris* sp., *Nannochloropsis salina*, *Nannochloropsis* sp., *Navicula acceptata*, *Navicula biskanterae*, *Navicula pseudotenelloides*, *Navicula pelliculosa*, *Navicula saprophila*, *Navicula* sp., *Nephrochloris* sp., *Nephroselmis* sp., *Nitzschia communis*, *Nitzschia alexandrina*, *Nitzschia closterium*, *Nitzschia communis*, *Nitzschia dissipata*, *Nitzschia frustulum*, *Nitzschia hantzschiana*, *Nitzschia inconspicua*,

Nitzschia intermedia, *Nitzschia microcephala*, *Nitzschia pusilla*, *Nitzschia pusilla elliptica*, *Nitzschia pusilla monoensis*, *Nitzschia quadrangular*, *Nitzschia* sp., *Ochromonas* sp., *Oocystis parva*, *Oocystis pusilla*, *Oocystis* sp., *Oscillatoria limnetica*, *Oscillatoria* sp., *Oscillatoria subbrevis*, *Parachlorella kessleri*, *Pascheria acidophila*, *Pavlova* sp., *Phaeodactylum tricomutum*, *Phagus*, *Phormidium*, *Platymonas* sp., *Pleurochrysis carterae*, *Pleurochrysis dentate*, *Pleurochrysis* sp., *Prototheca wickerhamii*, *Prototheca stagnora*, *Prototheca portoricensis*, *Prototheca moriformis*, *Prototheca zopfii*, *Pseudochlorella aquatica*, *Pyramimonas* sp., *Pyrobotrys*, *Rhodococcus opacus*, *Sarcinoid chryso-phyte*, *Scenedesmus armatus*, *Schizochytrium*, *Spirogyra*, *Spirulina platensis*, *Stichococcus* sp., *Synechococcus* sp., *Synechocystis*, *Tagetes erecta*, *Tagetes patula*, *Tetraedron*, *Tetraselmis* sp., *Tetraselmis suecica*, *Thalassiosira weissflogii*, and *Viridiella fridericiana*.

Exemplary embodiments of bioreactor **101** and exemplary types of organisms able to be vitally supported by bioreactor **101** are disclosed herein, including at Tables 1-5 below, which are not in any way intended to limit the scope of the invention. As would be understood in the art, the reclassification of various taxa is not unusual, and occurs as developments in science are made. Any disclosure in the specification regarding the taxonomic classification of exemplary types of organisms should be viewed in light of such developments.

For example, a strain of microalgae taxonomically classified in the *Chlorella* genus that achieved the performance characteristics described herein with respect to taxonomic family Chlorellaceae, and that was implemented with the methods described herein provides an exemplary organism able to be vitally supported by bioreactor **101** but is not intended to limit implementation of the invention to a particular strain of microalgae. Analysis of the deoxyribonucleic acid (DNA) sequence of the exemplary strain of *Chlorella* in the NCBI 18s ribosomal DNA (rDNA) reference database of the Culture Collection of Algae at the University of Cologne (CCAC) in Cologne, Germany showed substantial similarity (i.e., greater than 95%) of the exemplary strain of *Chlorella* with multiple known strains of microalgae taxonomically classified in the *Chlorella* and *Micractinium* genera. Microalgae taxonomically classified in the *Chlorella* and *Micractinium* genera appear closely related in many taxonomic classification trees for microalgae, and types of microalgae may be re-classified from time to time within the *Chlorella* and *Micractinium* genera. Accordingly, while the exemplary microalgae strain is referred to herein as being of the *Chlorella* genus, it is recognized that microalgae strains in related taxonomic classifications with similar characteristics to the exemplary microalgae strain would reasonably be expected to produce similar results. Therefore, in many embodiments, references herein to an organism classified in a first taxonomic genus (e.g., *Chlorella*) can include an organism classified in another taxonomic genus (e.g., *Micractinium*) that is genetically and/or morphologically similar to the first genus, and vice versa.

Bioreactor cavity **102** can hold (e.g., contain) the organism(s) being vitally supported by bioreactor **101**, and in many embodiments, also can contain a fluidic support medium configured to hold, and in many embodiments, submerge the organism(s). In many embodiments, the fluidic support medium can comprise a culture medium, and the culture medium can comprise water. Meanwhile, bioreactor cavity **102** is at least partially formed and enclosed by bioreactor wall(s) **103**. When bioreactor **101** is implemented

with bioreactor fitting(s) **104**, bioreactor fitting(s) **104** together with bioreactor wall(s) **103** can fully form and enclose bioreactor cavity **102**. Further, as explained in greater detail below, bioreactor wall(s) **103** and one or more of bioreactor fitting(s) **104**, as applicable, can be operable to at least partially (e.g., fully) seal the contents of bioreactor cavity **102** (e.g., the organism(s) and/or fluidic support medium) within bioreactor cavity **102**. As a result, bioreactor **101** can maintain conditions mitigating the risk of introducing foreign (e.g., unintended) and/or contaminating organisms to bioreactor cavity **102**. In other words, bioreactor **101** can engender the dominance (e.g., proliferation) of certain (e.g., intended) organism(s) being vitally supported at bioreactor **102** over foreign (e.g., unintended) and/or contaminating organisms. For example, bioreactor **101** can maintain substantially (e.g., absolutely) axenic conditions in the bioreactor cavity **102**.

Bioreactor wall(s) **103** comprise one or more bioreactor wall materials. When bioreactor wall(s) **103** comprise multiple bioreactor walls, two or more of the bioreactor walls can comprise the same bioreactor wall material(s) and/or two or more of the bioreactor walls can comprise different bioreactor wall material(s).

In many embodiments, part or all of the bioreactor wall material(s) can comprise (e.g., consist of) one or more flexible materials. In some embodiments, bioreactor **101** can comprise a bag bioreactor.

In these or other embodiments, part or all of the bioreactor wall material(s) (e.g., the flexible material(s)) can comprise one or more partially transparent (e.g., fully transparent) and/or partially translucent (e.g., fully translucent) materials, such as, for example, when bioreactor **101** comprises a photobioreactor (i.e., when the organism(s) comprise phototrophic organism(s)). For example, implementing the bioreactor wall material(s) (e.g., the flexible material(s)) with at least partially transparent or translucent materials can permit light radiation to pass through bioreactor wall(s) **103** to be used as an energy source by the organism(s) contained at bioreactor cavity **102**. Still, in some embodiments, bioreactor **101** can vitally support phototrophic organisms when the bioreactor wall material(s) (e.g., the flexible material(s)) of bioreactor wall(s) **103** are opaque, such as, for example, by providing sources of light radiation internal to bioreactor cavity **102**. Further, in some embodiments, part or all of the bioreactor wall material(s) (e.g., the flexible material(s)) can comprise one or more selectively partially transparent (e.g., fully transparent) and/or partially translucent (e.g., fully translucent) materials, able to shift from opaque to at least partial transparency (e.g., full transparency) or at least partial translucency (e.g., full translucency).

For example, the bioreactor wall material(s) (e.g., the flexible and/or at least partially transparent or translucent material(s)) can comprise one or more polymer materials or one or more other suitable materials. In these or other embodiments, exemplary polymer material(s) can comprise polypropylene, polyamide, polyethylene, polyphenylsulfone, polyvinylidene fluoride, ethylene chlorotrifluoroethylene copolymer, polyetherimide, polysulfone, polyphenylene sulfide, thermoplastic polyimide, polyetheretherketone, and/or polyaryletherketone. In some embodiments, the bioreactor wall material(s) (e.g., the flexible and/or at least partially transparent or translucent material(s)) can comprise a melting point greater than or equal to approximately 125 degrees Celsius and less than or equal to approximately 225 degrees Celsius. In further embodiments, the bioreactor wall material(s) (e.g., the flexible and/or at least partially transparent or translucent material(s)) can comprise an elastic

modulus greater than or equal to approximately 1.1 Giga-Pascals and less than or equal to approximately 2.5 Giga-Pascals.

Further, bioreactor wall(s) **103** each can be manufactured from one or more sheets of material (e.g., thin films). In some embodiments, when one or more of bioreactor wall(s) **103** each comprise multiple sheets of material, the multiple sheets of material can be laminated or coextruded together.

In these laminated or coextruded embodiments, the multiple sheets can be devoid of any air bubbles between them or can comprise one or more air bubbles between them. In some embodiments, implementing the laminated or coextruded multiple sheets with air bubbles in between can make it easier to identify a leak is present to alert an operator of bioreactor **101** that bioreactor cavity **102** may no longer be sealed and/or in an axenic condition, as explained in greater detail below, and can facilitate cleanup efforts. In these or other embodiments, two or more of the multiple sheets of material can comprise the same bioreactor wall material(s) and/or two or more of the multiple sheets of material can comprise different bioreactor wall material(s). For example, in some embodiments, each of bioreactor wall(s) **103** can comprise two sheets of material laminated or coextruded together with one sheet comprising polypropylene and one sheet comprising polyamide.

Meanwhile, in many embodiments, one or more of bioreactor wall(s) **103** can be coupled together to at least partially form and enclose bioreactor cavity **102**. For example, the one or more of bioreactor wall(s) **103** can be coupled together by heat welding (e.g., heat sealing, hot plate welding, laser welding, etc.) or by another suitable coupling method. Further, one or more parts of bioreactor wall(s) **103** can be coupled together (e.g., by heat welding) to structurally reinforce bioreactor **101**. When bioreactor wall(s) **103** are manufactured from a single sheet of material, the single sheet of material can be folded over and coupled (e.g., bonded) to itself in order to form bioreactor cavity **102**. Meanwhile, when bioreactor wall(s) **103** are manufactured from multiple sheets of material, the multiple sheets of material can be coupled (e.g., bonded) together to form bioreactor cavity **102**.

Further, when one or more of bioreactor wall(s) **103** comprise two sheets of material laminated together with one sheet comprising polypropylene and one sheet comprising polyamide, bioreactor wall(s) **103** can be coupled (e.g., bonded) together at the sheet or sheets of bioreactor wall(s) **103** that comprise polypropylene. For example, in some embodiments, one or more sheets of the laminated materials (e.g., polypropylene sheet(s)) can be joined (e.g., bonded) by heat welding and one or more sheets of the laminated materials (e.g., polyamide sheet(s)) cannot be joined (e.g., bonded) together by heat welding. In these or other embodiments, the joinable sheets of the laminated materials can be arranged so that the joinable sheets face inwardly toward bioreactor cavity **102** and the non-joinable sheets face outwardly away from bioreactor cavity **102** when bioreactor wall(s) **103** are coupled together.

Bioreactor cavity **102** can comprise a cavity volume and a cavity surface area. The cavity surface area can refer to a total surface area of the one or more surfaces forming bioreactor cavity **102**. The cavity volume and/or cavity surface area of bioreactor cavity **102** can comprise any desirable volume and/or surface area. However, in some embodiments, the cavity volume and/or cavity surface area can be constrained by an available geometry (e.g., the dimensions) of the sheet material(s) used to manufacture bioreactor wall(s) **103**. Other factors that can constrain the

cavity volume and/or cavity surface area can include a light penetration depth through bioreactor wall(s) **103** and into bioreactor cavity **102** (e.g., when the organism(s) vitally supported by bioreactor **101** are phototrophic organism(s)), a size of an available autoclave for sterilizing bioreactor **101** as discussed in greater detail below, and/or a size of a support structure implemented to mechanically support bioreactor **101**. For example, the support structure can be similar or identical to support structure **323** (FIG. 3) and/or support structure **423** (FIG. 4). In many embodiments, the cavity volume of bioreactor cavity **102** can be greater than or equal to approximately 3.785 liters, greater than or equal to approximately 18.92 liters, and/or greater than or equal to approximately 25.48 liters. In some embodiments, the cavity volume of bioreactor cavity **102** can be less than or equal to approximately 248.9 liters.

Meanwhile, bioreactor cavity **102** can comprise a largest lateral cross sectional area. In many embodiments, the largest lateral cross sectional area of bioreactor cavity **102** can refer to a largest cross sectional area of bioreactor cavity **102** measured parallel to the width and depth dimensions of bioreactor **101**. In these or other embodiments, the lateral cross sectional area of bioreactor cavity **102** can be measured from the cavity surface of bioreactor cavity **102**. In many embodiments, the greatest lateral cross sectional area of bioreactor cavity **102** can be greater than or equal to approximately 0.043 square meters and less than or equal to approximately 0.318 square meters.

Bioreactor **101** and/or bioreactor cavity **102** can comprise any desirable geometries (e.g., dimensions and/or shapes). For example, the geometry of bioreactor **101** can be at least partially determined by cutting the sheet material(s) used for bioreactor wall(s) **103** to the desired geometry. Meanwhile, the geometry of bioreactor cavity **102** can be determined by the points of coupling (e.g., one or more weld lines) of bioreactor wall(s) **103**, and in some embodiments, by one or more fold lines of bioreactor wall(s) **103**. In many embodiments, bioreactor **101** and/or bioreactor cavity **102** can comprise an approximately polygonal prismatic shape (e.g., an approximately rectangular, hexagonal, or octagonal prismatic shape).

Meanwhile, bioreactor **101** can comprise a length (e.g., longest) dimension, a width dimension, and a depth dimension. The width and depth dimensions can represent greatest dimensions of bioreactor **101** in directions that are approximately orthogonal to the length dimension and to each other. In these embodiments, the length dimension can be greater than or equal to approximately 182 centimeters and less than or equal to approximately 244 centimeters; the width dimension can be greater than or equal to approximately 51 centimeters and less than or equal to approximately 102 centimeters; and/or the depth dimension can be greater than or equal to approximately 7 centimeters and less than or equal to approximately 10 centimeters.

Also, bioreactor wall(s) **103** can comprise a bioreactor wall thickness. When bioreactor wall(s) **103** comprise multiple bioreactor walls, two or more of the bioreactor walls can comprise the same bioreactor wall thickness and/or two or more of the bioreactor walls can comprise different bioreactor wall thicknesses. In many embodiments, the bioreactor wall thickness can be greater than or equal to approximately 152.4 micrometers and less than or equal to approximately 355.6 micrometers. In some embodiments, the bioreactor wall thickness can be approximately 254.0 micrometers.

Meanwhile, bioreactor wall(s) **103** can comprise an exterior surface area. The exterior surface area of bioreactor wall(s) **103** can refer to a total surface area of an exterior of bioreactor wall(s) **103**.

Bioreactor fitting(s) **104** (e.g., gas delivery fitting(s) **107**, fluidic support medium delivery fitting(s) **110**, organic carbon material delivery fitting(s) **111**, bioreactor exhaust fitting(s) **112**, bioreactor sample fitting(s) **113**, parameter sensing device fittings **121**) can communicate with bioreactor cavity **102** to provide ingress to and/or egress from bioreactor cavity **102** (e.g., while maintaining an at least partial seal of bioreactor cavity **102**). In many embodiments, bioreactor fitting(s) **104** can be coupled to bioreactor wall(s) **103** and/or can be located (e.g., disposed) at one or more apertures passing through bioreactor wall(s) **103**. Meanwhile, flexible tube(s) **106** (e.g., gas delivery tube(s) **108**, organic carbon material delivery tube(s) **114**, bioreactor sample tube(s) **115**) can be coupled to one or more of bioreactor fitting(s) **104** and can be located (e.g., disposed) within bioreactor cavity **102**. Flexible tube(s) **106** can comprise one or more flexible and/or at least partially transparent materials, such as, for example, one or more polymers.

For example, fluidic support medium fitting(s) **110** can be coupled to fluidic support medium delivery tube(s) **116**, such as, for example, at one or more inputs of fluidic support medium delivery tube(s) **116**. Fluidic support medium fitting(s) **110** can receive and supply (e.g., via fluidic support medium delivery tube(s) **116**) the organism(s) to bioreactor cavity **102**. Further, fluidic support medium fitting(s) **110** can receive and supply (e.g., via fluidic support medium delivery tube(s) **116**) the fluidic support medium, one or more nutritional media, one or more anti-foaming agents, and/or one or more surfactants to bioreactor cavity **102**.

For example, nutritional media can comprise one or more components (e.g., organic compounds, inorganic compounds, and/or water) aiding in the vital support of the organism(s) at bioreactor cavity **102**. Exemplary nutritional media can comprise magnesium sulfate heptahydrate, trace metals, phosphate, phosphate dibasic, one or more nitrates (e.g., sodium nitrate), iron, and/or potassium phosphate dibasic.

In many embodiments, the nutritional media can be supplied to the organism(s) at bioreactor cavity **102** when the organism(s) reach a certain culture density (e.g., a threshold culture density). For example, the nutritional media can be supplied to the organism(s) at bioreactor cavity **102** when the organism(s) reach a culture density of at least approximately 5 grams per liter, 10 grams per liter, or 15 grams per liter. In these or other embodiments, the nutritional media can be supplied to the organism(s) at bioreactor cavity **102** each time the culture density of the organism(s) increases by a certain culture density. For example, the nutritional media can be supplied to the organism(s) at bioreactor cavity **102** when and/or each time the organism(s) reach a culture density of greater than or equal to approximately 2 grams per liter and less than or equal to approximately 3 grams per liter.

Meanwhile, the anti-foaming agent(s) can comprise one or more agents (e.g., chemicals) configured to reduce and/or offset foam production by the organism(s). Reducing and/or offsetting foam production by the organism(s) can prevent bioreactor cavity **102** from rupturing.

Further, the surfactant(s) can comprise one or more compounds configured to reduce a surface tension between two or more of the contents (e.g., one or more organism(s) and a fluidic support medium) of bioreactor cavity **102**. Reducing the surface tension between two or more of the contents

of bioreactor cavity **102** can aid in mixing the contents of bioreactor cavity **102** as described further below with respect to gas delivery device(s) **105**.

In many embodiments, fluidic support medium delivery tube(s) **116** can convey the organism(s), the fluidic support medium, the one or more nutritional media, the anti-foaming agent(s), and/or the surfactant(s) to one or more outputs of fluidic support medium delivery tube(s) **116** that drain into bioreactor cavity **102**. In many embodiments, one or more of these output(s) can comprise a non-planar cross section within bioreactor cavity **102** to prevent the output(s) from suctioning to bioreactor wall(s) **103**. For example, one or more v-shaped cuts can be provided at the output(s) to form the non-planar cross section(s). Still, in other embodiments, fluidic support medium delivery tube(s) **116** can be omitted.

In many embodiments, the organism(s) being vitally supported by bioreactor **101** can be partially and/or fully harvested (e.g., removed) from bioreactor cavity **102**. In some embodiments, the organism(s) being vitally supported by bioreactor **101** can be partially and/or fully harvested (e.g., removed) from bioreactor cavity **102** via fluidic support medium fitting(s) **110**. However, in many embodiments, one or more of fluidic support medium fitting(s) **110** can be decoupled (e.g., temporarily decoupled) and removed from bioreactor wall(s) **103** and the organism(s) can be partially and/or fully harvested (e.g., removed) from bioreactor cavity **102** via the aperture(s) in bioreactor wall(s) **103** from which the decoupled fitting(s) of fluidic support medium fitting(s) **110** are removed. In various embodiments, all of the organism(s) being vitally supported by bioreactor **101** can be harvested (e.g., removed) from bioreactor cavity **102** simultaneously in one entire batch (i.e., fully harvested) or the organism(s) being vitally supported by bioreactor **101** can be harvested (e.g., removed) from bioreactor cavity **102** in multiple batches over time (e.g., partially harvested). In other embodiments, the organism(s) being vitally supported by bioreactor **101** can be continuously partially harvested (e.g., removed) from bioreactor cavity **102** over time. In some embodiments, when the organism(s) being vitally supported at bioreactor **101** are partially and/or continuously harvested, bioreactor cavity **102** can also be re-inoculated with new organism(s) and/or fluidic support media. Exemplary embodiments of methods for inoculating (e.g., supplying) and re-inoculating bioreactor cavity **102** with organism(s) are discussed in greater detail below.

In some embodiments, the organism(s) being vitally supported by bioreactor **101** can be continuously partially harvested (e.g., removed) from bioreactor cavity **102** at intervals. Although the interval can be any suitable period of time, which may be determined based on the type of organism(s) being vitally supported by bioreactor **101**, in many embodiments, the interval can be approximately 7-12 days or approximately 10-12 days.

In further embodiments, the organism(s) being vitally supported by bioreactor **101** can be partially and/or continuously partially harvested (e.g., removed) from bioreactor cavity **102** when a culture density of the organism(s) reaches a certain culture density. Although the culture density for partially and/or continuously partially harvesting (e.g., removing) the organism(s) from bioreactor cavity **102** can be any suitable culture density, which may be determined based on the type of organism(s) being vitally supported by bioreactor **101**, in many embodiments, the culture density for partially and/or continuously partially harvesting (e.g., removing) the organism(s) from bioreactor cavity **102** can comprise at least approximately 2 grams per liter. In more specific embodiments, the culture density for partially and/

or continuously partially harvesting (e.g., removing) the organism(s) from bioreactor cavity **102** can be (i) greater than or equal to approximately 2 grams per liter and less than or equal to approximately 5 grams per liter, (ii) greater than or equal to approximately 7 grams per liter and less than or equal to approximately 12 grams per liter, (iii) greater than or equal to approximately 7 grams per liter and less than or equal to approximately 10 grams per liter, or (iv) greater than or equal to approximately 20 grams per liter and less than or equal to approximately 30 grams per liter.

In implementation, fluidic support medium fitting(s) **110** can comprise any suitable fitting or fittings configured to provide ingress of the organism(s), the fluidic support medium, the one or more nutritional media, the anti-foaming agent(s), and/or the surfactant(s) into, and in some embodiments, egress of the organism(s), the fluidic support medium, the one or more nutritional media, the anti-foaming agent(s), and/or the surfactant(s) out of bioreactor cavity **102**. In many embodiments, the fitting(s) are configured to provide unidirectional ingress of the organism(s), the fluidic support medium, the one or more nutritional media the anti-foaming agent(s), and/or the surfactant(s) into bioreactor cavity **102** to help maintain an at least partial seal of bioreactor cavity **102**. For example, in some embodiments, fluidic support medium fitting(s) **110** can comprise one or more check valves. Further, fluidic support medium fitting(s) **110** (e.g., the check valve(s)) can be sealed in place with one or more gaskets. In some embodiments, fluidic support medium fitting(s) **110** can comprise one or more filters configured to filter the fluidic support medium and/or the one or more nutritional media. For example, the filter(s) can comprise a single filter or multiple filters in series, can be disc shaped, and/or can be operable to filter micro-particles (e.g., down to approximately 0.1 micrometers).

In these or other embodiments, organic carbon material delivery fitting(s) **111** can be coupled to organic carbon material delivery tube(s) **114**, such as, for example, at one or more inputs of organic carbon material delivery tube(s) **114**. Organic carbon material delivery fitting(s) **111** can receive and supply (e.g., via organic carbon material delivery tube(s) **114**) organic carbon material to bioreactor cavity **102**. In some embodiments, the organic carbon material can be used as an energy source by the organism(s) being vitally supported by bioreactor **101**, such as, for example, when the organism(s) comprise heterotrophic organism(s) or mixotrophic organism(s).

Exemplary organic carbon materials can comprise acetic acid, acetate, or glucose. In some embodiments, the organic carbon materials can be mixed with ammonium bicarbonate, magnesium sulfate heptahydrate, trace metals, iron, phosphate, phosphate dibasic, one or more nitrates (e.g., sodium nitrate), such as, for example, before the organic carbon material(s) are supplied to the organism(s) being vitally supported by bioreactor **101**. In these or other embodiments, the organic carbon materials can be mixed with one or more of the nutritional media, such as, for example, before the organic carbon material(s) are supplied to the organism(s) being vitally supported by bioreactor **101**.

Further, organic carbon material delivery tube(s) **114** can convey the organic carbon material to one or more outputs of organic carbon material delivery tube(s) **114** that drain into bioreactor cavity **102**. In many embodiments, one or more of these output(s) can comprise a non-planar cross section located within bioreactor cavity **102** to prevent the output(s) from suctioning to bioreactor wall(s) **103**. For example, one or more v-shaped cuts can be provided at the output(s) to form the non-planar cross section(s). Still, in

some embodiments, organic carbon material delivery tube(s) **114** can be omitted, and in further embodiments, organic carbon material delivery fitting(s) **111** can be omitted, such as, for example, when the organism(s) being vitally supported by bioreactor **101** are not heterotrophic or mixo-

trophic. In implementation, organic carbon material delivery fitting(s) **111** can comprise any suitable fitting or fittings configured to provide ingress (e.g., unidirectional ingress) of the carbon source material into bioreactor cavity **102**. For example, in some embodiments, fluidic support medium fitting(s) **110** can comprise one or more check valves. Meanwhile, in many embodiments, organic carbon material delivery fitting(s) **111** can comprise one or more filters configured to filter the organic carbon material received at organic carbon material delivery fitting(s) **111** of contaminants. For example, the filter(s) can comprise a single filter or multiple filters in series, can be disc shaped, and/or can be operable to filter micro-particles or nano-particles. Further, organic carbon material delivery fitting(s) **111** (e.g., the check valve(s)) can be sealed in place with one or more gaskets.

In these or other embodiments, bioreactor sample fitting(s) **113** can be coupled to bioreactor sample tube(s) **115**, such as, for example, at one or more outputs of bioreactor sample tube(s) **115**. Bioreactor sample fitting(s) **113** can be used to obtain (e.g., via bioreactor sample tube(s) **115**) one or more samples of the organism(s) held at bioreactor cavity **102**, such as, for example, to determine a condition of the organism(s). For example, in many embodiments, bioreactor sample fitting(s) **113** can receive one or more syringes that can apply suction to bioreactor sample fitting(s) **113** to withdraw (e.g., via organic carbon material delivery tube(s) **114**) the sample(s) of the organism(s) held at bioreactor cavity **102**.

Further, bioreactor sample tube(s) **115** can receive the sample(s) from one or more inputs of bioreactor sample tube(s) **115** in communication with the organism(s) at bioreactor cavity **102** and convey the sample(s) to bioreactor sample fitting(s) **113**. In many embodiments, one or more of these input(s) can comprise a non-planar cross section located within bioreactor cavity **102** to prevent the input(s) from suctioning to bioreactor wall(s) **103**. For example, one or more v-shaped cuts can be provided at the input(s) to form the non-planar cross section(s). Still, in some embodiments, bioreactor sample tube(s) **115** can be omitted, and in further embodiments, bioreactor sample fitting(s) **113** can be omitted.

In implementation, bioreactor sample fitting(s) **113** can comprise any suitable fitting or fittings configured to permit the sample(s) of the organism(s) to be obtained from bioreactor cavity **102** without disrupting an at least partial seal of bioreactor cavity **102**. For example, in some embodiments, bioreactor sample fitting(s) **113** can comprise one or more double check valves with stop cocks. In some embodiments, bioreactor sample fitting(s) **113** (e.g., the double check valve(s) with stop cocks) can be sealed in place with one or more gaskets.

In these or other embodiments, bioreactor exhaust fitting(s) **112** can vent gas (e.g., air) produced by the organism(s) being vitally supported by bioreactor **101** from bioreactor cavity **102** and/or gas injected into bioreactor cavity **102** by gas delivery device(s) **105**, such as, for example, to reduce a cavity pressure at bioreactor cavity **102**. In some embodiments, bioreactor exhaust fitting(s) **112** can be coupled (e.g., removably coupled) to one or more inputs of one or more bioreactor exhaust tubes located

outside of bioreactor cavity **102**. In other embodiments, the bioreactor exhaust tube(s) can be omitted.

In implementation, bioreactor exhaust fitting(s) **112** can comprise any suitable fitting or fittings configured to permit unidirectional egress of gas out from bioreactor cavity **102**. For example, in some embodiments, bioreactor exhaust fitting(s) **112** can comprise one or more check valves. In some embodiments, bioreactor exhaust fitting(s) **112** (e.g., the check valve(s)) can be sealed in place with one or more gaskets.

In many embodiments, the bioreactor exhaust tube(s) can convey the gas vented from bioreactor exhaust fitting(s) **112** to a bleach-water solution in communication with the one or more outputs of the bioreactor exhaust tube(s) to sterilize contaminants of the vented gas. In some embodiments, the bleach-water solution can comprise a bleach to water ratio of greater than or equal to approximately 400 parts per million (ppm). In other embodiments, bioreactor exhaust fitting(s) **112** can comprise one or more filters configured to filter the vented gas of contaminants, such as, for example, when the bioreactor exhaust tube(s) are omitted. For example, the filter(s) can comprise a single filter or multiple filters in series, can be disc shaped, and/or can be operable to filter micro-particles (e.g., down to approximately 0.1 micrometers) or nano-particles.

In these or other embodiments, gas delivery fitting(s) **107** can be coupled to one or more inlets of gas delivery tube(s) **108**, which can be coupled to gas delivery device(s) **105** at one or more outlets of gas delivery tube(s) **108**. Gas delivery fitting(s) **107** can be configured to receive gas (e.g., air, oxygen, carbon dioxide, etc.) and supply the gas (e.g., via gas delivery tube(s) **108**) to gas delivery device(s) **105**. Gas delivery device(s) **105** can be located (e.g., disposed) within bioreactor cavity **102** and can be operable to inject the gas provided to gas delivery device(s) **105** into bioreactor cavity **102** to mix and/or aerate the organism(s) (e.g., within the fluidic support medium) being vitally supported by bioreactor **101**. For example, gas delivery device(s) **105** can mix and/or aerate the organism(s) (e.g., within the fluidic support medium) being vitally supported by bioreactor **101** in order to prevent sedimentation of the organism(s) and to better distribute exposure of the organism(s) to energy sources (e.g., light and/or carbon source material) and/or nutritional components (e.g., the one or more nutritional media) at bioreactor cavity **102**. In many embodiments, gas delivery device(s) **105** can be located (e.g., disposed) at a position low within bioreactor cavity **102** relative to the Earth to promote mixing of the organism(s) as gravitational forces return the organism(s) to gas delivery device(s) **105** after gas delivery device(s) **105** stir up the organism(s) with the injected gas. In some embodiments, gas delivery tube(s) **108** can be omitted and gas delivery device(s) **105** can be coupled directly to gas delivery fitting(s) **107**.

In implementation, gas delivery fitting(s) **107** can comprise any suitable fitting or fittings configured to permit ingress (e.g., unidirectional ingress) of gas (e.g., air, oxygen, carbon dioxide, etc.) and to supply the gas to gas delivery device(s) **105**. For example, in some embodiments, bioreactor sample fitting(s) **113** can comprise one or more check valves. Meanwhile, in many embodiments, gas delivery fitting(s) **107** can comprise one or more filters configured to filter the gas received at gas delivery fitting(s) **107** of contaminants. For example, the filter(s) can comprise a single filter or multiple filters in series, can be disc shaped, and/or can be operable to filter micro-particles (e.g., down to approximately 0.22 micrometers) or nano-particles. In some

embodiments, bioreactor sample fitting(s) **113** (e.g., the check valve(s)) can be sealed in place with one or more gaskets.

Further, in implementation, gas delivery device(s) **105** can comprise one or more devices configured to inject gas into bioreactor cavity **102**. In general, the arrangement and geometry of gas delivery device(s) **105** within bioreactor cavity **102** and the exit velocity, mass, and/or volume of gas injected by gas delivery device(s) **105** can affect the proficiency of the mixing and/or aeration of the organism(s) being vitally supported by bioreactor **101**. However, increasing the exit velocity, mass, and/or volume of the gas also increases the shear forces acting on the organism(s), which at some level can harm (e.g., kill) the organism(s). Accordingly, in many embodiments, the exit velocity, mass, and/or volume of the gas can be limited based on the shear forces applied to the organism(s) and thus, the arrangement and geometry of gas delivery device(s) **105** can take on increased importance. In many embodiments, the arrangement and geometry of gas delivery device(s) **105** can be configured such that gas delivery device(s) **105** are no greater than approximately 10.2 centimeters away from at least part of bioreactor wall(s) **103**, and when gas delivery device(s) **105** comprise multiple gas delivery devices, such that gas delivery device(s) **105** are no greater than approximately 10.2 centimeters away from each other. In these or other embodiments, gas delivery device(s) **105** can be configured such that a ratio of the active surface area of gas delivery device(s) **105** to the largest lateral cross sectional area of bioreactor cavity **102** is greater than or equal to approximately 13.00 and less than or equal to approximately 30.64. The active surface area of gas delivery device(s) **105** can refer to the surface area of gas delivery device(s) **105** from which gas can pass from gas delivery device(s) **105** to bioreactor cavity **102** (e.g., orifices, pores, etc.).

Meanwhile, gas delivery device(s) **105** can be configured so that gas bubbles of the gas injected into bioreactor cavity **102** comprise a diameter greater than or equal to approximately 40 micrometers and less than or equal to approximately 2 millimeters and/or so that a volumetric flow rate of the gas injected into bioreactor cavity **102** is greater than or equal to approximately 10 liters per minute and less than or equal to approximately 60, 120, 180, or 200 liters per minute. Further, gas delivery device(s) **105** can inject gas into bioreactor cavity **102** such that the gas comprises a superficial flow velocity when exiting gas delivery device(s) **105** of greater than or equal to approximately 0.000167 meters per second and less than or equal to approximately 0.0205 meters per second. Further still, gas delivery device(s) **105** can inject gas into bioreactor cavity **102** such that the volumetric mass-transfer coefficient ($k_L a$) of the gas to the organism(s) being vitally supported at bioreactor **101** is greater than or equal to approximately 0.062 inverse second (s^{-1}) to approximately 0.182 inverse second (s^{-1}).

In these or other embodiments, using surfactant(s) at bioreactor cavity **102** can permit improved mixing of the organism(s) being vitally supported by bioreactor **101** by reducing surface tension between two or more contents (e.g., one or more organisms and a fluidic support medium) at bioreactor cavity **102**. Using the surfactant(s) in combination with gas delivery device(s) **105** configured so that gas bubbles of the gas injected into bioreactor cavity **102** comprise a diameter greater than or equal to approximately 40 micrometers and less than or equal to approximately 2 millimeters and/or so that a volumetric flow rate of the gas injected into bioreactor cavity **102** is greater than or equal to approximately 10 liters per minute and less than or equal to

approximately 60, 120, 180, or 200 liters per minute can be advantageous when implementing bioreactor **101**. For example, a residence time at bioreactor cavity **102** of the gas injected into bioreactor cavity **102** can be limited by a height of bioreactor cavity **102**. In some embodiments, residence time can refer to an average amount of time taken for gas injected into bioreactor cavity **102** by gas delivery device(s) **105** to evacuate from bioreactor cavity **102** through bioreactor exhaust fitting(s) **112** and/or can refer to an average amount of time that gas injected into bioreactor cavity **102** by gas delivery device(s) **105** remains in contact with any organism(s) being vitally supported by bioreactor **101**. Decreasing a height of bioreactor cavity **102** can decrease a residence time at bioreactor cavity **102** of the gas injected into bioreactor cavity **102**, which can result in insufficient mixing and/or aeration, and therefore growth of the organism(s) being vitally supported by bioreactor **101**. Accordingly, in many embodiments, using surfactant(s) in combination with gas delivery device(s) **105** configured so that gas bubbles of the gas injected into bioreactor cavity **102** comprise a diameter greater than or equal to approximately 40 micrometers and less than or equal to approximately 2 millimeters and/or so that a volumetric flow rate of the gas injected into bioreactor cavity **102** is greater than or equal to approximately 10 liters per minute and less than or equal to approximately 60, 120, 180, or 200 liters per minute can permit improved mixing and/or aeration of the organism(s) being vitally supported by bioreactor **101** to offset a decrease in residence time.

In many embodiments, gas delivery device(s) **105** can comprise one or more spargers. The sparger(s) can comprise porous and/or fixed-orifice sparger(s). Further, the fixed-orifice sparger(s) can be configured to inject gas uni-directionally and/or multi-directionally and/or can comprise fixed-orifices arranged uniformly and/or sparsely. Meanwhile, the porous sparger(s) inherently can be configured to inject gas multi-directionally and sparsely. The sparger(s) can comprise a sparger material comprising polymer (e.g., flashspun high density polyethylene, sintered polymer), ceramic, metalloid (e.g., silicon), and/or metal (e.g., stainless steel and/or porous stainless steel). Meanwhile, in some embodiments, the sparger material can comprise a flexible material. For example, in some embodiments, the sparger(s) can comprise tube or plate spargers. In these embodiments, the tube sparger(s) can comprise a diameter (e.g., 0.635 centimeters) and/or a length (e.g., 35.6 centimeters) as determined by the mixing and/or aeration needs of the organism(s) and/or as determined by the volume and geometry of bioreactor cavity **102**. In many embodiments, the diameters of the pores and/or fixed-orifices of the sparger(s) implemented for gas delivery device(s) **105** can be configured so that gas bubbles of the gas injected into bioreactor cavity **102** comprise a diameter greater than or equal to approximately 40 micrometers and less than or equal to approximately 2 millimeters and/or so that a volumetric flow rate of the gas injected into bioreactor cavity **102** is greater than or equal to approximately 10 liters per minute and less than or equal to approximately 60, 120, 180, or 200 liters per minute.

Still, in other embodiments, gas delivery device(s) **105** and/or gas delivery fitting(s) **107** can be replaced or implemented concomitantly with one or more other bioreactor mixing and/or aeration device(s) configured to mix and/or aerate the organism(s) (e.g., within the fluidic support medium) being vitally supported by bioreactor **101**. Exemplary other mixing device(s) can comprise one or more impellers, one or more air stones, etc.

In these or other embodiments, pressure regulator(s) **117** can limit a maximum cavity pressure of bioreactor cavity **102**. In many embodiments, pressure regulator(s) **117** can be operable as a safety precaution to prevent bioreactor **101** from rupturing under the cavity pressure at bioreactor cavity **102**.

For example, in some embodiments, one or more of pressure regulator(s) **117** can vent gas (e.g., air) produced by the organism(s) being vitally supported by bioreactor **101** from bioreactor cavity **102** to prevent the maximum cavity pressure of bioreactor cavity **102** from being exceeded. In some embodiments, bioreactor fitting(s) **104** and/or bioreactor exhaust fitting(s) **112** can comprise one or more of pressure regulator(s) **117**. Further, in these or other embodiments, one or more of pressure regulator(s) **117** can be similar to bioreactor exhaust fitting(s) **112**. For example, one or more of pressure regulator(s) **117** can communicate with bioreactor cavity **102** to provide egress from bioreactor cavity **102**. In some embodiments, one or more of pressure regulator(s) **117** can comprise one or more blowoff valves configured to blow under a predetermined amount of cavity pressure. In other embodiments, one or more of pressure regulator(s) **117** can comprise one or more valves configured to open and vent the gas upon sensing the cavity pressure has exceeded a predetermined amount of cavity pressure, such as, for example, by reference to one or more of pressure sensor(s) **118** as discussed below.

In other embodiments, one or more of pressure regulator(s) **117** can restrict, stop, and/or reroute gas being received at gas delivery fitting(s) **107** and/or can restrict, stop, and/or reroute organic source material being received at organic carbon material delivery fitting(s) **111** to prevent the maximum cavity pressure of bioreactor cavity **102** from being exceeded. These pressure regulator(s) **117** can operate under the principal of preventing more gas from entering bioreactor cavity **102** (i.e., when regulating gas delivery fitting(s) **107**) to prevent the maximum cavity pressure of bioreactor cavity **102** from being exceeded and/or under the principal of preventing more gas from being formed by the organism(s) (i.e., when regulating organic carbon material delivery fitting(s) **111**) to prevent the maximum cavity pressure of bioreactor cavity **102** from being exceeded. In further embodiments, one or more of pressure regulator(s) **117** can comprise a valve configured to close (e.g., restricting or stopping flow) or open (e.g., rerouting flow) upon sensing the cavity pressure has exceeded a predetermined amount of cavity pressure, such as, for example, by reference to one or more of pressure sensor(s) **118** as discussed below.

In these or other embodiments, parameter sensing device fitting(s) **121** can receive parameter sensing device(s) **109** to permit parameter sensing devices to communicate with bioreactor cavity **102**. Parameter sensing device(s) **109** (e.g., pressure sensor(s) **118**, temperature sensor(s) **119**, pH sensor(s) **120**, chemical sensor(s) **122**) can be operable to monitor (e.g., measure) one or more cavity environmental conditions (e.g., pressure, temperature, pH, chemical concentration, etc.) at bioreactor cavity **102**. In some embodiments, one or more of parameter sensing device(s) **109** each can monitor (e.g., measure) multiple of the cavity environmental condition(s) at bioreactor cavity **102**.

For example, pressure sensor(s) **118** can monitor the cavity pressure at bioreactor cavity **102**, such as, for example, to determine the cavity pressure for pressure regulator(s) **117** and/or to help vitally support the organism(s) held at bioreactor cavity **102**. Meanwhile, temperature sensor(s) **119** can monitor the cavity temperature of

bioreactor cavity **102**, pH sensor(s) **120** can monitor the cavity pH of bioreactor cavity **102**, and oxygen sensor(s) **122** can monitor the quantity of one or more elements (e.g., oxygen) or compounds (e.g., carbon dioxide) present (e.g., dissolved) at bioreactor cavity **102** to help vitally support the organism(s) held at bioreactor cavity **102**. For example, nutritional media, organic carbon material, light radiation, gas, etc. provided to bioreactor cavity **102** and/or the organism(s) can be regulated based on the data collected from parameter sensing device(s) **109**. Further, bioreactor cavity **102** can be cooled or warmed to maintain a set point temperature of bioreactor **101**. The set point temperature of bioreactor **101** can comprise a desired temperature of bioreactor **101**. For example, the set point temperature can be determined based on the organism(s) being vitally supported by bioreactor **101** and can vary depending on the type or types of organism(s). In many examples, the set point temperature can be established to maximize an average density and/or average maximum production rate of the organism(s) being vitally supported at bioreactor **101**.

In implementation, parameter sensing device fitting(s) **121** can comprise any suitable fitting or fittings configured to receive parameter sensing device(s) **109** for communication with bioreactor cavity **102**. For example, in some embodiments, parameter sensing device fitting(s) **121** can comprise one or more check valves. In some embodiments, parameter sensing device fitting(s) **121** (e.g., the check valve(s)) can be sealed in place with one or more gaskets. Further, pressure sensor(s) **118** can comprise one or more pressure transducers; temperature sensor(s) **119** can comprise one or more thermometers, one or more thermocouples, etc.; pH sensor(s) **120** can comprise one or more pH meters; and/or chemical sensor(s) **122** can comprise one or more chemical meters (e.g., dissolved oxygen meters).

As indicated above, when bioreactor **101** comprises a photobioreactor, bioreactor **101** can permit light radiation to pass through bioreactor wall(s) **103** to be used as an energy source by the organism(s) being vitally supported by bioreactor **101**. In these embodiments, light radiation can be supplied to the organism(s) by one or more light sources (e.g., light source(s) **337** (FIG. 3)) and/or by natural light. In many embodiments, a quantity of light supplied to the organism(s) being vitally supported by bioreactor **101** can depend on the type of organism(s) being vitally supported by bioreactor **101**. Further, in these or other embodiments, a quantity of light supplied to the organism(s) being vitally supported by bioreactor **101** can be based upon a culture density of the organism(s). For example, in some embodiments, the quantity of light being supplied to the organism(s) can be changed (e.g., increased or decreased) when the organism(s) reach a certain culture density. In some embodiments, the quantity of light being supplied to the organism(s) can be doubled when the organism(s) reach a culture density of approximately 0.5 gram per liter. In these or other embodiments, the quantity of light can be measured in micro moles per square meter per second. Meanwhile, in many embodiments, a ratio of the exterior surface area of bioreactor wall(s) **103** to the cavity volume of bioreactor cavity **102** can be greater than or equal to approximately 5.23 inverse meters (m^{-1}) and less than or equal to approximately 17.98 inverse meters (m^{-1}).

Meanwhile, bioreactor **101** (e.g., bioreactor cavity **102**, bioreactor wall(s) **103**, bioreactor fitting(s) **104**, gas delivery device(s) **105**, flexible tube(s) **106**, parameter sensing device(s) **109**, and/or pressure regulator(s) **117**) can be sterilized one or more times before being used to vitally support one or more organisms, such as, for example, when

two or more or all of bioreactor cavity **102**, bioreactor wall(s) **103**, bioreactor fitting(s) **104**, gas delivery device(s) **105**, flexible tube(s) **106**, parameter sensing device(s) **109**, and pressure regulator(s) **117** are assembled together. Further, bioreactor **101** (e.g., bioreactor cavity **102**, bioreactor wall(s) **103**, bioreactor fitting(s) **104**, gas delivery device(s) **105**, flexible tube(s) **106**, parameter sensing device(s) **109**, and/or pressure regulator(s) **117**) can be sterilized one or more times again after being used to vitally support one or more organisms to permit reuse of bioreactor **101** one or more times to support other organism(s). The organism(s) can be the same type or different types of organism(s) for the multiple uses of bioreactor **101**. As a result, bioreactor cavity **102** can be substantially axenic when bioreactor **101** begins vitally supporting the organism(s) and can be maintained in a substantially axenic condition during the term of use by bioreactor wall(s) **103** and bioreactor fitting(s) **104** at least partially sealing bioreactor cavity **102**. In many embodiments, bioreactor cavity **102** can be substantially axenic when bioreactor cavity **102** is at least 99.0 percent, 99.5 percent, or 99.9 percent free of organism(s) other than the organism(s) intended to be vitally supported by bioreactor **101** by relative volume to each other. In these or other embodiments, bioreactor cavity **102** can be substantially axenic when bioreactor cavity **102** is sufficiently free of foreign (e.g., unintended) and/or contaminating organism(s) that certain (e.g., intended) organism(s) being vitally supported at bioreactor cavity **102** maintain dominance (e.g., proliferate) over the foreign (e.g., unintended) and/or contaminating organism(s). Further, bioreactor cavity **102** can be absolutely axenic when bioreactor cavity **102** is 100 percent free of foreign (e.g., unintended) and/or contaminating organism(s) (e.g., macroorganisms and microorganisms).

In these embodiments, bioreactor **101** (e.g., bioreactor cavity **102**, bioreactor wall(s) **103**, bioreactor fitting(s) **104**, gas delivery device(s) **105**, flexible tube(s) **106**, parameter sensing device(s) **109**, and/or pressure regulator(s) **117**) can be sterilized initially by gamma radiation exposure, autoclave, and/or chemical exposure (e.g., ethylene oxide) and then sterilized again for reuse by gamma radiation exposure, autoclave and/or chemical exposure. In many embodiments, bioreactor **101** (e.g., bioreactor cavity **102**, bioreactor wall(s) **103**, bioreactor fitting(s) **104**, gas delivery device(s) **105**, flexible tube(s) **106**, parameter sensing device(s) **109**, and/or pressure regulator(s) **117**) can be sterilized again for reuse by autoclave at least once or multiple times without degrading (e.g., structurally damaging) bioreactor **101** (e.g., bioreactor cavity **102**, bioreactor wall(s) **103**, bioreactor fitting(s) **104**, gas delivery device(s) **105**, flexible tube(s) **106**, parameter sensing device(s) **109**, and/or pressure regulator(s) **117**) sufficiently to prevent bioreactor wall(s) **103** and bioreactor fitting(s) **104** from maintaining an at least partial seal of bioreactor cavity **102** and/or maintaining a level of non-contamination substantially similar to that of the level of non-contamination of an immediately prior use of bioreactor **101**. In some embodiments, the level of non-contamination can be substantially similar when the contamination conditions are within approximately ± 0.01 percent or ± 0.02 percent of each other as it relates to the percentage extent to which bioreactor cavity **102** is free of organism(s) other than the organism(s) intended to be vitally supported by bioreactor **101** by relative volume to each other. In other words, bioreactor **101** (e.g., bioreactor cavity **102**, bioreactor wall(s) **103**, bioreactor fitting(s) **104**, gas delivery device(s) **105**, flexible tube(s) **106**, parameter sensing device(s) **109**, and/or pressure regulator(s) **117**) can be

sterilized again for reuse by gamma radiation exposure, autoclave, and/or chemical exposure at least once or multiple times while maintaining the structural integrity of bioreactor **101** (e.g., bioreactor cavity **102**, bioreactor wall(s) **103**, bioreactor fitting(s) **104**, gas delivery device(s) **105**, flexible tube(s) **106**, parameter sensing device(s) **109**, and/or pressure regulator(s) **117**). Exemplary embodiments of methods for autoclaving bioreactor **101** are discussed in greater detail below.

As a volume of a contents (e.g., fluidic support medium, one or more nutritional media, organism(s), etc.) of bioreactor cavity **102** increases, stress placed on bioreactor **101**, bioreactor wall(s) **103**, and/or one or more welds coupling together bioreactor wall(s) **103** by the contents of bioreactor cavity **102** can cause bioreactor **101**, bioreactor wall(s) **103**, and/or one or more welds coupling together bioreactor wall(s) **103** to rupture. Accordingly, in some embodiments, bioreactor **101** can be positioned and/or at least partially sealed in a cavity of a containment vessel, such as, for example, to collect any of the fluidic support medium, one or more nutritional media, and/or organism(s) that may leak from bioreactor **101** in the event that bioreactor cavity **102** ruptures. Positioning and/or at least partially sealing bioreactor **101** in the cavity of the containment vessel can make it easier to identify a leak is present to alert an operator of bioreactor **101** that bioreactor cavity **102** may no longer be sealed and/or in an axenic condition, and can facilitate cleanup efforts. Notably, in some embodiments, loss of axenic conditions may warrant complete disposal of the contents of bioreactor cavity **102**. However, in other embodiments, bioreactor cavity **101** can continue to vitally support the organism(s) even in the event an axenic condition of bioreactor cavity **102** is lost.

In these or other embodiments, the cavity of the containment vessel can be similar or identical to bioreactor cavity **102**, and/or the containment vessel can be similar or identical to bioreactor **101**. For example, the containment vessel can comprise a bag (e.g., an open bag). In many embodiments, the containment vessel can comprise one or more containment vessel walls. In these or other embodiments, the containment vessel walls can be similar or identical to bioreactor wall(s) **103**.

In some embodiments, when bioreactor **101** is positioned and/or at least partially sealed in the cavity of the containment vessel, a containment vessel fluid can be positioned between an exterior of bioreactor wall(s) **103** and an interior of the containment vessel wall(s). In these embodiments, the containment vessel fluid can be operable to mechanically support bioreactor **101**, such as, for example, by providing exterior pressure on the exterior of bioreactor wall(s) **103**. Further, by providing exterior pressure on the exterior of bioreactor wall(s) **103**, the containment vessel fluid can be operable to mitigate stress placed on bioreactor **101**, bioreactor wall(s) **103**, and/or one or more welds coupling together bioreactor wall(s) **103** by the contents (e.g., fluidic support medium, one or more nutritional media, organism(s), etc.) of bioreactor cavity **102**.

The containment vessel fluid can comprise one or more fluids suitable to mechanically support bioreactor **101**. In many embodiments, the containment vessel fluid can comprise water. In these embodiments, the containment vessel can be referred to as a water column. In some embodiments, implementing the containment vessel wall(s) and/or the containment vessel fluid to be transparent or translucent can permit light radiation to pass through the containment vessel wall(s) and/or the containment vessel fluid to reach the organism(s) at bioreactor cavity **102**.

Further, bioreactor **101** (e.g., bioreactor cavity **102**, bioreactor wall(s) **103**, bioreactor fitting(s) **104**, gas delivery device(s) **105**, flexible tube(s) **106**, parameter sensing device(s) **109**, and/or pressure regulator(s) **117**) is able to be gathered up by folding (e.g., in half or into quarters) and/or rolling up bioreactor **101** (e.g., like a sleeping bag). In many embodiments, bioreactor **101** (e.g., bioreactor cavity **102**, bioreactor wall(s) **103**, bioreactor fitting(s) **104**, gas delivery device(s) **105**, flexible tube(s) **106**, parameter sensing device(s) **109**, and/or pressure regulator(s) **117**) can be manufactured of flexible materials permitting bioreactor **101** to be gathered up and/or fit into an autoclave. For example, in some embodiments, a greatest physical dimension of bioreactor **101** can be reduced by approximately 50 percent, 55 percent, 60 percent, 65 percent, 70 percent, 75 percent, 80 percent, 85 percent, or 90 percent by bioreactor **101** being gathered up. Accordingly, in some embodiments, flexible materials can refer to materials being sufficiently flexible to permit the greatest physical dimension of bioreactor **101** to be reduced by approximately 50 percent, 55 percent, 60 percent, 65 percent, 70 percent, 75 percent, 80 percent, 85 percent, or 90 percent by bioreactor **101** being gathered up and/or to be fit into an autoclave.

Advantageously, because bioreactor **101** can be sterilized one or more times generally, bioreactor **101** can be reused. Reuse of bioreactor **101** can result in cost savings over non-reusable bioreactors and can reduce material waste. Meanwhile, sterilization of bioreactor **101** by autoclaving can be beneficial over other forms of sterilization because bioreactor cavity **101** can be sterilized with little to no disassembly required and in a manner that is more cost effective than other forms of sterilization. For example, sterilization by autoclave does not require the expensive and complicated storage and transportation protocols that storing radioactive materials for gamma irradiation may require. Further, because bioreactor **101** can be gathered up, bioreactor **101** can be advantageously stored in more locations than would be possible with a constant geometry bioreactor and bioreactor **101** can also be gathered up when being autoclaved. Gathering up bioreactor **101** when bioreactor **101** is being autoclaved can mitigate damage inflicted on bioreactor **101** by the autoclave. Further still, because bioreactor cavity **102** can be maintained in a substantially (e.g., absolutely) axenic condition during operation of bioreactor **101**, organism(s) vitally supported by bioreactor **101** can be vitally supported for extended lengths of time (e.g., as long as approximately three months) relative to organisms vitally supported at conventional bioreactors. Accordingly, in many examples, the frequency of stages at which the organism(s) of bioreactor **101** may need to be transferred to higher volume bioreactors compared to organisms vitally supported at conventional bioreactors can be reduced. For example, in some embodiments, organism(s) vitally supported by bioreactor **101** can be transferred directly to open air ponds rather than first needing to be progressively transferred between or among multiple bioreactors. Moreover, because bioreactor cavity **102** can be maintained in a substantially axenic condition during operation of bioreactor **101**, bioreactor **101** can be particularly well suited for vitally supported genetically modified organisms, which may need to be isolated from competing organism(s) that have already naturally and/or optimally adapted to the environment until the genetically modified organisms are robust enough to survive. In many embodiments, the ability of bioreactor cavity **102** to be maintained in a substantially (e.g., absolutely) axenic condition during operation of bioreactor **101** can result from the ability to maintain bioreactor cavity **102**

at least partially (e.g., fully) sealed after sterilization due to the configuration of bioreactor **101** and the conditions of operation of bioreactor **101** as described herein.

Notably, bioreactor **101** (e.g., bioreactor cavity **102**, bioreactor wall(s) **103**, bioreactor fitting(s) **104**, gas delivery device(s) **105**, flexible tube(s) **106**, parameter sensing device(s) **109**, and/or pressure regulator(s) **117**) can be gathered up (e.g., folded up and/or rolled up) and autoclaved while being gathered up. By applying water to bioreactor cavity **102** during autoclaving, all surfaces of bioreactor **101** can be sterilized (e.g., autoclaved) despite bioreactor **101** being gathered up. That is, the advantages of gathering up bioreactor **101** during autoclaving may not detract from the ability of bioreactor **101** to be sterilized by being autoclaved.

Also advantageously, organism(s) being vitally supported by bioreactor **101** can achieve higher average densities and/or average maximum production rates than organism(s) vitally supported by conventional bioreactors. Average maximum production rate can refer to an increase in mass per unit volume per unit time (e.g., grams per liter per day) averaged across multiple similar or identical batches of organism(s) vitally supported by bioreactor **101**. For example, the average maximum production rate for organism(s) taxonomically classified in taxonomic family Haematococcaceae can be based on multiple batches of organism(s) taxonomically classified in taxonomic family Haematococcaceae that are vitally supported by bioreactor **101**. For example, in some embodiments, bioreactor **101** can vitally support organism(s) taxonomically classified in taxonomic family Haematococcaceae at an average density greater than or equal to approximately 12 grams per liter (e.g., approximately 13.34 grams per liter) or greater than or equal to approximately 14 grams per liter. In these or other embodiments, bioreactor **101** can vitally support organism(s) taxonomically classified in taxonomic family Haematococcaceae at an average maximum production rate of greater than or equal to approximately 2.5 grams per liter per day (e.g., approximately 2.78 grams per liter per day). Further, bioreactor **101** can vitally support organism(s) taxonomically classified in taxonomic family Chlorellaceae at an average density greater than or equal to approximately 36 grams per liter (e.g., approximately 40.3 grams per liter) or greater than or equal to approximately 50 grams per liter. In these or other embodiments, bioreactor **101** can vitally support organism(s) taxonomically classified in taxonomic family Chlorellaceae at an average maximum production rate of greater than or equal to approximately 9 grams per liter per day (e.g., approximately 9.86 grams per liter per day). Further still, bioreactor **101** can vitally support organism(s) taxonomically classified in taxonomic family Chlamydomonadaceae at an average density of greater than or equal to approximately 7 grams per liter (e.g., 7.63 grams per liter). In these or other embodiments, bioreactor **101** can vitally support organism(s) taxonomically classified in taxonomic family Chlamydomonadaceae at an average maximum production rate of greater than or equal to approximately 3 grams per liter per day (e.g., approximately 3.3 grams per liter per day). Notably, in these or other embodiments, the organism(s) can be harvested prior to achieving the foregoing average densities and/or average maximum production rates, and in some embodiments, the organism(s) can achieve higher average densities and/or average maximum production rates than the foregoing average densities and/or average maximum production rates.

In many embodiments, bioreactor cavity **102** can be inoculated (e.g., supplied) and/or re-inoculated with organism(s), such as, for example, while maintaining bioreactor

cavity **102** in a substantially axenic or at least sterile condition. For example, in some embodiments, bioreactor cavity **102** can be inoculated (e.g., supplied) and/or re-inoculated with organism(s) using a sterile volume of a polymerase chain reaction (PCR) laminar flow hood or another implement configured to provide a sterile volume in which to work. In many embodiments, bioreactor cavity **102** can be inoculated (e.g., supplied) and/or re-inoculated with organism(s) in a similar or identical manner.

In many embodiments, the sterile volume of the PCR laminar flow hood can be prepared for use by wiping down the sterile volume with 70 percent ethanol one or more times and/or by irradiating the sterile volume with ultraviolet radiation for greater than or equal to approximately 30 minutes. In some embodiments, bioreactor **101** can be inflated with filtered (e.g., sterile) air to facilitate inoculation and/or installed in a support structure configured to mechanically support bioreactor **101**. For example, the support structure can be similar or identical to support structure **323** (FIG. 3) and/or support structure **423** (FIG. 4)

In many embodiments, a filter assembly can be placed in the sterile volume of the PCR laminar flow hood. The filter assembly can be operable to filter the fluidic support medium when the fluidic support medium is transferred to bioreactor cavity **102**. In these or other embodiments, the filter assembly can be stored in an autoclaved bag to maintain the filter assembly in sterile condition. When the filter assembly is stored in the autoclaved bag, the filter assembly can be removed from the autoclaved bag from within the sterile volume of the PCR laminar flow hood. The autoclaved bag can be sprayed with 70 percent ethanol prior to placement in the sterile volume of the PCR laminar flow hood.

In some embodiments, part of a bioreactor transfer tube can be sprayed with 70 percent ethanol nearest an input of the bioreactor transfer tube and that part of the bioreactor transfer tube can be placed in the sterile volume of the PCR laminar flow hood. The output of the bioreactor transfer tube can be coupled to an input of at least one of fluidic support medium delivery fitting(s) **110** in a sterile coupling. In many embodiments, the transfer tube can have been sterilized along with bioreactor **101** prior to inoculation of bioreactor **101**. The input of the bioreactor transfer tube can be coupled to an output of the filter assembly within the sterile volume of the PCR laminar flow hood. In some embodiments, the bioreactor transfer tube can be coupled to an output of the filter assembly via one or more quick disconnects. The quick disconnects can be sprayed with 70 percent ethanol prior to coupling.

In some embodiments, an output of a fluidic support medium transfer tube can be fed through a peristaltic pump and can be coupled to an input of the filter assembly in the sterile volume of the PCR laminar flow hood. In some embodiments, the output of the fluidic support medium transfer tube can be coupled to the input of the filter assembly via one or more quick disconnects. In further embodiments, the quick disconnects can be sprayed with 70 percent ethanol prior to coupling. An input of the fluidic support medium transfer tube can be coupled to a fluidic support medium reservoir holding the fluidic support medium. Air can be purged from the peristaltic pump and/or the filter assembly and then the peristaltic pump can be operated to transfer the fluidic support medium through the fluidic support medium transfer tube, the filter assembly, the bioreactor transfer tube, and the at least one of fluidic support medium delivery fitting(s) **110** into bioreactor cavity **102**.

In some embodiments, an output of an organism transfer tube can be fed through the peristaltic pump and can be coupled to the input of the bioreactor transfer tube in the sterile volume of the PCR laminar flow hood, such as, for example, via one or more quick disconnects. In many embodiments, the quick disconnects can be sprayed with 70 percent ethanol prior to coupling. In some embodiments, the part of the bioreactor transfer tube nearest the input of the bioreactor transfer tube can be sprayed with 70 percent ethanol and that part of the bioreactor transfer tube can be placed in the sterile volume of the PCR laminar flow hood. An input of the organism transfer tube can be coupled to an organism reservoir holding the organism(s), which may be in a nascent condition. The peristaltic pump can be operated to transfer the organisms through the organism transfer tube, the bioreactor transfer tube, and the at least one of fluidic support medium delivery fitting(s) **110** into bioreactor cavity **102**.

Notably, in some embodiments, transfer of the fluidic support medium can be performed prior to transfer of the organism(s). However, in other embodiments, transfer of the organism(s) can be performed prior to the transfer of the fluidic support medium or simultaneously with the transfer of the fluidic support medium.

As previously introduced above, in many embodiments, bioreactor **101** (e.g., bioreactor cavity **102**, bioreactor wall(s) **103**, bioreactor fitting(s) **104**, gas delivery device(s) **105**, flexible tube(s) **106**, parameter sensing device(s) **109**, and/or pressure regulator(s) **117**) can be autoclaved. For example, when being autoclaved, bioreactor **101** (e.g., bioreactor cavity **102**, bioreactor wall(s) **103**, bioreactor fitting(s) **104**, gas delivery device(s) **105**, flexible tube(s) **106**, parameter sensing device(s) **109**, and/or pressure regulator(s) **117**) can be exposed to water elevated to high temperatures (e.g., temperatures in excess of approximately 121 or 134 degrees Celsius) as a result of the water being pressurized. Thus, in many embodiments, bioreactor **101** (e.g., bioreactor cavity **102**, bioreactor wall(s) **103**, bioreactor fitting(s) **104**, gas delivery device(s) **105**, flexible tube(s) **106**, parameter sensing device(s) **109**, and/or pressure regulator(s) **117**) can be manufactured of materials able to resist these temperatures and pressures of water. Notably, methods for autoclaving bioreactor **101** can vary depending on the size of autoclave used.

In many embodiments, air can be purged from bioreactor **101** (e.g., via bioreactor exhaust tube(s)) using a vacuum pump. Further, any exterior tube(s) (e.g., the exhaust tube(s) and/or the bioreactor transfer tube) of bioreactor **101** can be coiled up and individually secured with autoclave tape. In various embodiments, bioreactor **101** can be gathered (e.g., folded and/or rolled up). For example, in some embodiments, bioreactor **101** can be rolled up from a top down along the length dimension of bioreactor **101**. In other embodiments, bioreactor **101** can first be folded (e.g., in half) one or more times (e.g., about the length dimension of bioreactor **101**) and then rolled up from a top down along the length dimension of bioreactor **101**. In some embodiments, the coiled exterior tube(s) can be secured to bioreactor wall(s) **103** prior to gathering up bioreactor **101** or while gathering up bioreactor **101**. In various embodiments, bioreactor **101** can be maintained in the gathered up configuration using autoclave tape and/or a heat welded strap of bioreactor wall material.

After gathering up bioreactor **101**, bioreactor **101** can be placed in the autoclave. The autoclave can be operated to

sterilize bioreactor 101. For example, the autoclave can be operated for approximately 45 minutes on an instrument or a liquid cycle.

FIG. 2 illustrates a schematic side view of a system 200, according to an embodiment. System 200 can be similar or identical to system 100 (FIG. 1).

For example, system 200 can comprise bioreactor 201, bioreactor cavity 202, one or more bioreactor walls 203, one or more gas delivery devices 205, one or more gas delivery fittings 207, one or more gas delivery tubes 208, one or more fluidic support medium delivery fittings 210, one or more organic carbon material delivery fittings 211, one or more bioreactor exhaust fittings 212, one or more bioreactor sample fittings 213, one or more organic carbon material delivery tubes 214, one or more bioreactor sample tubes 215, one or more fluidic support medium delivery tubes 216, and one or more parameter sensing device fittings 221. In some embodiments, bioreactor 201 can be similar or identical to bioreactor 101 (FIG. 1); bioreactor cavity 202 can be similar or identical to bioreactor cavity 102 (FIG. 1); bioreactor wall(s) 203 can be similar or identical to bioreactor wall(s) 103 (FIG. 1); gas delivery device(s) 205 can be similar or identical to gas delivery device(s) 105 (FIG. 1);

gas delivery fitting(s) 207 can be similar or identical to gas delivery fitting(s) 107 (FIG. 1); gas delivery tube(s) 208 can be similar or identical to gas delivery tube(s) 108 (FIG. 1); fluidic support medium delivery fitting(s) 210 can be similar or identical to fluidic support medium delivery fitting(s) 110 (FIG. 1); organic carbon material delivery fitting(s) 211 can be similar or identical to organic carbon material delivery fitting(s) 111 (FIG. 1); bioreactor exhaust fitting(s) 212 can be similar or identical to bioreactor exhaust fitting(s) 112 (FIG. 1); bioreactor sample fitting(s) 213 can be similar or identical to bioreactor sample fitting(s) 113 (FIG. 1); organic carbon material delivery tube(s) 214 can be similar or identical to organic carbon material delivery tube(s) 114 (FIG. 1); bioreactor sample tube(s) 215 can be similar or identical to bioreactor sample tube(s) 115 (FIG. 1); fluidic support medium delivery tube(s) 216 can be similar or identical to fluidic support medium delivery tube(s) 116 (FIG. 1); and/or parameter sensing device fitting(s) 221 can be similar or identical to parameter sensing device fitting(s) 121 (FIG. 1).

Tables 1-5 as follow illustrate various exemplary operational conditions under which bioreactor 101 (FIG. 1) and/or bioreactor 201 can be operated in order to vitally support exemplary taxonomically classified organisms.

TABLE 1

<i>Chlorella</i> sp. (Mixotrophic Conditions)	
Organic Carbon Material	i) Option 1 (Mix of carbon and nitrogen)—Up to approximately 40% acetic acid and up to approximately 4% sodium nitrate; and ii) Option 2 (Mix of carbon and all nutrients)—Up to approximately 40% acetic acid, up to approximately 4% sodium nitrate, up to approximately 3.34 milligrams per liter trace metals solution, and up to approximately 6.67 milligrams per liter magnesium sulfate heptahydrate
Fluidic Support Medium	2X modified BG-11 and approximately 100 microliters per liter Antifoam 204
Nutritional Media Regimen	i) Implemented once culture density reaches approximately 5 grams per liter and approximately 15 grams per liter; ii) For Organic Carbon Material Option 1—Add up to approximately 150 milligrams per liter magnesium sulfate heptahydrate, up to approximately 0.5 milliliters per liter trace metals, and up to approximately 200 milligrams per liter phosphate dibasic; and iii) For Organic Carbon Material Option 2—Add up to approximately 200 milligrams per liter phosphate dibasic
Cavity Environment Conditions	i) pH—Approximately 7.5 ii) Temperature—Approximately 28 degrees Celsius
Lighting (e.g., both sides of bioreactor)	i) Either T-5 Fluorescent or light emitting diode; ii) For culture densities at or below approximately 0.5 grams per liter—Approximately 140 micro moles per/(meters ² per second); and iii) For culture densities above approximately 0.5 grams per liter—Approximately 280 micro moles per/(meters ² per second)
Aeration	i) Approximately 5 micron stainless steel air sparger; and ii) Approximately 60 liters per minute air flow rate
Substructure Frame Spacing (i.e., Bioreactor Depth)	Approximately 10.16 centimeters (e.g., Approximately 5.08 centimeters light path)
Partial Harvest Frequency	Approximately every 7 days
Partial Harvest Density	Approximately 20-30 grams per liter

TABLE 2

<i>Haematococcus pluvialis</i> (Mixotrophic conditions)	
Organic Carbon Material	i) Option 1 (Mix of carbon and nitrogen)—Up to approximately 20% acetic acid and up to approximately 2% sodium nitrate ii) Option 2 (carbon only)—Up to approximately 20% acetic acid
Fluidic Support Medium	Modified Microbio Media approximately 100 microliters per liter Antifoam 204 (mixture of organic polyether dispersions, available

TABLE 2-continued

<i>Haematococcus pluvialis</i> (Mixotrophic conditions)	
	from Sigma Aldrich of St. Louis, Missouri, United States of America)
Nutritional Media Regimen	i) Implemented each time the culture density increases by approximately 2-3 grams per liter; ii) For first approximately 2-3 grams per liter increase—Add up to approximately 3.5 milliliters per liter nitrate stock, up to approximately 1.0 milliliters per liter trace metals stock, up to approximately 1.0 milliliters per liter iron stock, and up to approximately 1.5 milliliters per liter phosphate stock; and iii) For additional approximately 2-3 grams per liter increases—Add up to approximately 1.0 milliliters per liter trace metals stock, up to approximately 1.0 milliliters per liter iron stock, and up to approximately 1.5 milliliters per liter phosphate stock
Cavity Environment Conditions	i) pH—Approximately 7.5 ii) Temperature—Approximately 25 degrees Celsius
Lighting (e.g., both sides of bioreactor)	i) Either T-5 Fluorescent or light emitting diode; ii) For culture densities at or below approximately 0.5 grams per liter—Approximately 140 micro moles per/(meters ² per second); and iii) For culture densities above approximately 0.5 grams per liter—Approximately 280 micro moles per/(meters ² per second)
Aeration	i) Approximately 5 micron stainless steel air sparger; or ii) Flexible polymer air sparger
Substructure Frame Spacing (i.e., Bioreactor Depth)	Approximately 8.255 centimeters (4.1275 centimeters light path)
Partial Harvest Frequency	Approximately every 10-12 days
Partial Harvest Density	Approximately 7-10 grams per liter

TABLE 3

<i>Scenedesmus</i> sp. (Mixotrophic conditions)	
Organic Carbon Material	i) Option 1 (Mix of carbon and nitrogen)—Up to approximately 40% acetic acid and up to approximately 4% sodium nitrate; and ii) Option 2 (carbon only)—Up to approximately 10 grams per liter glucose (feed batch)
Fluidic Support Medium	2X modified BG-11 and approximately 100 microliters per liter Antifoam 204
Nutritional Media Regimen	i) Implemented once culture density reaches approximately 5 grams per liter; ii) Add up to approximately 150 milligrams per liter magnesium sulfate heptahydrate, up to approximately 0.5 milliliters per liter trace metals, and up to approximately 200 milligrams per liter potassium phosphate dibasic; and iii) For Organic Carbon Material Option 2 ONLY—Add up to approximately 10 grams per liter glucose approximately every 3 grams per liter increase in culture density plus approximately 0.75X nitrate
Cavity Environment Conditions	i) pH—Approximately 7.5 ii) Temperature—Approximately 25 degrees Celsius
Lighting (e.g., both sides of bioreactor)	i) Either T-5 Fluorescent or light emitting diode; ii) For culture densities at or below approximately 0.5 grams per liter—Approximately 140 micro moles per/(meters ² per second); and iii) For culture densities above approximately 0.5 grams per liter—Approximately 280 micro moles per/(meters ² per second)
Aeration	i) (a) Approximately 5 micron stainless steel air sparger or (b) Flexible polymer air sparger; and ii) 20 liters per minute air flow rate
Substructure Frame Spacing (i.e., Bioreactor Depth)	Approximately 10.16 centimeters (e.g., Approximately 5.08 centimeters light path)
Partial Harvest Frequency	Approximately every 7 days
Partial Harvest Density	Approximately 7-12 grams per liter

TABLE 4

<i>Porphyridium</i> sp. (Phototrophic conditions)	
Organic Carbon Material	None
Fluidic Support Medium	i) Modified f/2 and approximately 100 microliters per liter Antifoam 204
Nutritional Media Regimen	i) Implemented once culture density reaches approximately 5 grams per liter; and ii) Add up to approximately 150 milligrams per liter magnesium sulfate heptahydrate, up to approximately 0.5 milliliters per liter trace metals, and up to approximately 200 milligrams per liter potassium phosphate dibasic
Cavity Environment Conditions	i) pH—Approximately 7.5 ii) Temperature—Approximately 25 degrees Celsius
Lighting (e.g., both sides of bioreactor)	i) Either T-5 Fluorescent or light emitting diode; ii) For culture densities at or below approximately 0.5 grams per liter—Approximately 140 micro moles per/(meters ² per second); and iii) For culture densities above approximately 0.5 grams per liter—Approximately 280 micro moles per/(meters ² per second)
Aeration	i) Flexible polymer air sparger; and ii) 30 liters per minute air flow rate
Substructure Frame Spacing (i.e., Bioreactor Depth)	Approximately 10.16 centimeters (e.g., Approximately 5.08 centimeters light path)
Partial Harvest Frequency	As needed
Partial Harvest Density	Approximately 1.5-2.5 grams per liter

TABLE 5

<i>Chlamydomonas</i> sp. (Mixotrophic conditions)	
Organic Carbon Material	Up to approximately 20% acetic acid and up to approximately 22 grams per liter ammonium bicarbonate
Fluidic Support Medium	Modified Bristol's Media and approximately 100 microliters per liter Antifoam 204
Nutritional Medi Regimen	None
Cavity Environment Conditions	i) pH—Approximately 7.5 ii) Temperature—Approximately 25 degrees Celsius
Lighting (e.g., both sides of bioreactor)	i) Either T-5 Fluorescent or light emitting diode; ii) For culture densities at or below approximately 0.5 grams per liter—Approximately 140 micro moles per/(meters ² per second); and iii) For culture densities above approximately 0.5 grams per liter—Approximately 280 micro moles per/(meters ² per second)
Aeration	i) Approximately 5 micron stainless steel air sparger; and ii) Approximately 20 liters per minute air flow rate
Substructure Frame Spacing (i.e., Bioreactor Depth)	Approximately 10.16 centimeters (e.g., Approximately 5.08 centimeters light path)
Partial Harvest Frequency	None (Full harvest)
Partial Harvest Density	Approximately 2-5 grams per liter

Turning ahead now in the drawings, FIG. 3 illustrates an exemplary block diagram of a system 300, according to an embodiment. System 300 is merely exemplary and is not limited to the embodiments presented herein. System 300 can be employed in many different embodiments or examples not specifically depicted or described herein.

System 300 comprises a support structure 323. As explained in greater detail below, support structure 323 is operable to mechanically support one or more bioreactors 324. In these or other embodiments, as also explained in greater detail below, support structure 323 can be operable to maintain a set point temperature of one or more of bioreactor(s) 324, such as, for example, through an exchange of thermal energy between support structure 323 and one or more of bioreactor(s) 324. In many embodiments, one or more of bioreactor(s) 324 can be similar or identical to bioreactor 101 (FIG. 1) and/or bioreactor 201 (FIG. 2). Accordingly, the term set point temperature can refer to the set point temperature as defined above with respect to system 100 (FIG. 1). Further, when bioreactor(s) 324 com-

prise multiple bioreactors, two or more of bioreactor(s) 324 can be similar or identical to each other and/or two or more of bioreactor(s) 324 can be different from each other. For example, the bioreactor wall materials of the bioreactor walls of two or more of bioreactor(s) 324 can be different. In some embodiments, system 300 can comprise one or more of bioreactor(s) 324.

In many embodiments, support structure 323 comprises one or more support substructures 325. Each support substructure of support substructure(s) 325 can mechanically support one bioreactor of bioreactor(s) 324. In these or other embodiments, each support substructure of support substructure(s) 325 can maintain a set point temperature of one bioreactor of bioreactor(s) 324, such as, for example, through an exchange of thermal energy between the support substructure and the bioreactor. In further embodiments, each of support substructure(s) 325 can be similar or identical to each other.

For example, support substructure(s) 325 can comprise a first support substructure 326 and a second support substructure

ture 327. In these embodiments, first support substructure 326 can mechanically support a first bioreactor 328 of bioreactor(s) 324, and second support substructure 327 can mechanically support a second bioreactor 329 of bioreactor(s) 324. Further, first support substructure 326 can comprise a first frame 330 and a second frame 331, and second support substructure 327 can comprise a first frame 332 and a second frame 333. In many embodiments, first frame 330 can be similar or identical to first frame 332, and second frame 331 can be similar or identical to second frame 333. Further, first frame 330 can be similar to second frame 331, and first frame 332 can be similar to second frame 333.

As indicated above, first support substructure 326 can be similar or identical to second support substructure 327. Accordingly, to increase the clarity of the description of system 300 generally, the description of second support substructure 327 is limited so as not to be redundant with respect to first support substructure 326.

In many embodiments, first frame 330 and second frame 331 together can mechanically support first bioreactor 328 in interposition between first frame 330 and second frame 331. That is, bioreactor 328 can be sandwiched between first frame 330 and second frame 331 at a slot formed between first frame 330 and second frame 331. In these or other embodiments, first frame 330 and second frame 331 together can mechanically support first bioreactor 328 in an approximately vertical orientation. Further, first frame 330 and second frame 331 can be oriented approximately parallel to each other.

In many embodiments, second frame 331 can be selectively moveable relative to first frame 330 so that the volume of the slot formed between first frame 330 and second frame 331 can be adjusted. For example, second frame 331 can be supported by one or more wheels permitting second frame 331 to be rolled closer to or further from first frame 330. Meanwhile, in these or other embodiments, second frame 331 can be coupled to first frame 330 by one or more adjustable coupling mechanisms. The adjustable coupling mechanism(s) can hold second frame 331 in a desired position relative to first frame 330 while being adjustable so that the position can be changed when desirable. In implementation, the adjustable coupling mechanism(s) can comprise one or more threaded screws extending between first frame 330 and second frame 331, such as, for example, in a direction orthogonal to first frame 330 and second frame 331. Turning the threaded screws can cause second frame 331 to move (e.g., on the wheel(s)) relative to first frame 330.

Meanwhile, in some embodiments, first frame 330 can be operable to maintain a set point temperature of first bioreactor 328 when first bioreactor 328 is operating to vitally support one or more organisms and when support structure 323 (e.g., first support substructure 326, first frame 330, and/or second frame 331) is mechanically supporting first bioreactor 328. In these or other embodiments, second frame 331 can be operable to maintain the set point temperature of first bioreactor 328 when first bioreactor 328 is operating to vitally support the organism(s) and when support structure 300 (e.g., second support substructure 327, first frame 330, and/or second frame 331) is mechanically supporting first bioreactor 328. Support structure 323, first frame 330, and/or second frame 331 can be operable to maintain the set point temperature of first bioreactor 328 through an exchange of thermal energy between support structure 323, first frame 330, and/or second frame 331 and first bioreactor 328.

In many embodiments, first frame 330 can comprise multiple first frame rails 334. First frame rails 334 can be approximately planar to each other and/or can be spaced at regular or irregular intervals relative to each other. Accordingly, first frame rails 334 can resemble pickets in a fence-like arrangement configured to mechanically support first bioreactor 328. Further, each frame rail of first frame rails 334 can comprise a hollow conduit. First frame rails 334 can be configured to receive and convey a temperature maintenance fluid at the hollow conduits. By conveying the temperature maintenance fluid through the hollow conduits of first frame rails 334 while first frame 330 mechanically supports first bioreactor 328, thermal energy can be transferred between first bioreactor 328 and the temperature maintenance fluid. For example, the temperature maintenance fluid can be chilled to lower a temperature of first bioreactor 328 or heated to raise a temperature of first bioreactor 328 in order to maintain the set point temperature of first bioreactor 328 when first bioreactor 328 is vitally supporting one or more organism(s). In these or other embodiments, thermal energy can be transferred from the temperature maintenance fluid to first frame 330 and from first frame 330 to first bioreactor 328, such as, for example, then the temperature maintenance fluid is used to raise the temperature of first bioreactor 328, or thermal energy can be transferred from first bioreactor 328 to first frame 330 and from first frame 330 to the temperature maintenance fluid, such as, for example, then the temperature maintenance fluid is used to lower the temperature of first bioreactor 328.

In many embodiments, two or more of the hollow conduits of first frame rails 334 can be coupled together, such as, for example, so that the two or more hollow conduits of first frame rails 334 can receive the temperature maintenance fluid from a same temperature maintenance source. In these or other embodiments, two or more of the hollow conduits of first frame rails 334 can receive the temperature maintenance fluid serially and/or two or more of the hollow conduits of first frame rails 334 can receive the temperature maintenance fluid in parallel. Configuring two or more of the hollow conduits of first frame rails 334 to receive the temperature maintenance fluid in parallel can be advantageous because a total path that a given volume of the temperature maintenance fluid takes through the hollow conduits of first frame rails 334 can be reduced. As a result, the temperature of the given volume of the temperature maintenance fluid can remain closer to a starting temperature of the given volume of the temperature maintenance fluid. That is, as the path length that the given volume of the temperature maintenance fluid increases, so too does the amount of time that the given volume of the temperature maintenance fluid undergoes thermal energy transfer with bioreactor 324. Meanwhile, minimizing the temperature flux in the temperature maintenance fluid can permit the set point temperature of bioreactor 324 to be more accurately maintained. To further minimize the temperature flux, the temperature maintenance fluid can be forced upward (e.g., against gravity) into and through first frame rails 334 from the temperature maintenance source.

In implementation, first frame rails 334 can comprise two or more pipes. First frame rails 334 (e.g., the pipes) can comprise one or more frame rail materials able to mechanically support bioreactor 324 while facilitating thermal energy transfer between the temperature maintenance fluid and bioreactor 324. In many embodiments, the frame rail material(s) can also be selected so as to minimally chemically react with the temperature maintenance fluid. For example, the frame rail material(s) can comprise metal (e.g.,

stainless steel, copper, etc.). In these or other examples, the temperature maintenance fluid can comprise water. Meanwhile, in many embodiments, first frame 330 can comprise one or more perimeter beams configured to reinforce (e.g., frame) first frame rails 334. In these embodiments, the perimeter beams can comprise one or more beam materials able to mechanically support bioreactor 324. In many embodiments, first frame 330 can also be bolted to the ground for support.

As indicated above, in many embodiments, in many embodiments, second frame 331 can be similar or identical to first frame 330. Accordingly, second frame 331 can comprise multiple second frame rails 335. Meanwhile, second frame rails 335 can be similar or identical to first frame rails 334. In some embodiments, the hollow conduits of first frame rails 334 can be coupled to hollow conduits of 335. In these embodiments, the hollow conduits of first frame rails 334 and second frame rails 335 can receive the temperature maintenance fluid from the same source. However, in these or other embodiments, the hollow conduits of first frame rails 334 and the hollow conduits of second frame rails 335 can receive the temperature maintenance fluid from different sources.

In many embodiments, first support substructure 326 comprises a floor gap 336. Floor gap 336 can be located underneath one of first frame 330 or second frame 331. Floor gap 336 can permit first bioreactor 328 to bulge into floor gap 336 past first support substructure 326 when first support substructure 326 is mechanically supporting first bioreactor 328. Permitting first bioreactor 328 to bulge into floor gap 336 can relieve stress from first bioreactor 328. For example, in many embodiments, bioreactor(s) 324 can experience the greatest amount of stress at their base(s) when being mechanically supported in a vertical position, such as, for example, by support structure 323. In these embodiments, permitting first bioreactor 328 to bulge into floor gap 336 such that first support substructure 326 is not restraining first bioreactor 328 at floor gap 336 can relieve more stress from first bioreactor 328 than constraining all of first bioreactor 328 at both sides with first frame 330 and second frame 331, even if first frame 330 and second frame 331 are reinforced.

System 300 (e.g., support structure 323) can comprise one or more light sources 337. Light source(s) 337 can be operable to illuminate the organism(s) being vitally supported at bioreactor(s) 324. In many embodiments, second frame 331 can comprise and/or mechanically support one or more frame light source(s) 338 of light source(s) 337. Meanwhile, system 300 (e.g., support structure 323) can comprise one or more central light source(s) 339. In these or other embodiments, support substructure(s) 325 (e.g., first support substructure 326 and second support substructure 327) can be mirrored about a central vertical plane of support structure 323. Accordingly, central light source(s) 339 can be interpositioned between first support substructure 326 and second support substructure 327 so that first bioreactor 328 and second bioreactor 329 each can receive light from central light source(s) 339.

In implementation, light source(s) 337 (e.g., frame light source(s) 338 and/or central light source(s) 339) can comprise one or more banks of light bulbs and/or light emitting diodes. In some embodiments, light source(s) 337 (e.g., the light bulbs and/or light emitting diodes) can emit one or more wavelengths of light, as desirable for the particular organism(s) being vitally supported by bioreactor(s) 324.

Advantageously, because each support substructure of support substructure(s) 325 can maintain a set point tem-

perature of different ones of bioreactor(s) 324, each of bioreactor(s) 324 can be maintained at a set point temperature independently of each other. For example, when bioreactor(s) 324 are vitally supporting different types of organism(s), bioreactor(s) 324 can comprise different set point temperatures. Nonetheless, in many embodiments, bioreactor(s) 324 can comprise the same set point temperatures.

Meanwhile, in many embodiments, system 300 can comprise gas manifold 340, organic carbon material manifold 341, nutritional media manifold 342, and/or temperature maintenance fluid manifold 343. Gas manifold 340 can be operable to provide gas to one or more gas delivery fittings of bioreactor(s) 324. The gas delivery fitting(s) can be similar or identical to gas delivery fitting(s) 107 (FIG. 1) and/or gas delivery fitting(s) 207 (FIG. 2). Further, organic carbon material manifold 341 can be operable to deliver organic carbon material to one or more organic carbon material delivery fittings of bioreactor(s) 324. The organic carbon material delivery fitting(s) can be similar or identical to organic carbon material delivery fitting(s) 111 (FIG. 1) and/or organic carbon material delivery fitting(s) 211 (FIG. 2). Further still, nutritional media manifold 342 can be operable to provide nutritional media to one or more fluidic support medium delivery fittings of bioreactor(s) 324. The fluidic support medium delivery fitting(s) can be similar or identical to fluidic support medium delivery fitting(s) 110 (FIG. 1) and/or fluidic support medium delivery fitting(s) 210 (FIG. 2). Meanwhile, temperature maintenance fluid manifold can be configured to provide the temperature maintenance fluid to the hollow conduits of first frame 330 and/or second frame 331.

Gas manifold 340, organic carbon material manifold 341, nutritional media manifold 342, and/or temperature maintenance fluid manifold 343 each can comprise one or more tubes, one or more valves, one or more gaskets, one or more reservoirs, one or more pumps, and/or control logic (e.g., one or more computer processors, one or more transitory memory storage modules, and/or one or more non-transitory memory storage modules) configured to perform their respective functions. In these embodiments, the control logic can communicate with one or more parameter sensing devices of bioreactor(s) 324 to determine when to perform their respective functions (i.e., according to the needs of the organism(s) being vitally supported by bioreactor(s) 324). The parameter sensing device(s) can be similar or identical to parameter sensing device(s) 109 (FIG. 1).

In some embodiments, bioreactor(s) 324 can be positioned and/or at least partially sealed in one or more containment vessels while support structure 323 is mechanically supporting bioreactor(s) 324. Each of the containment vessel(s) can be similar or identical to the containment vessel described above with respect to bioreactor 101 (FIG. 1). In many embodiments, the containment vessel(s) can be filled with a containment vessel fluid to provide additional mechanical support for bioreactor(s) 324 while support structure 323 is mechanically supporting bioreactor(s) 324. The containment vessel fluid can be similar or identical to the containment vessel fluid described above with respect to bioreactor 101 (FIG. 1).

Turning to the next drawing, FIG. 4 illustrates a system 400, according to an embodiment. System 400 can be similar or identical to system 300 (FIG. 3).

For example, system 400 can comprise support structure 423, first support substructure 426, second support substructure 427, first frame 430, second frame 431, first frame rails 434, second frame rails 435, and one or more light source(s) 437. In these embodiments, light source(s) 437 can comprise

one or more frame light sources **438**. In many embodiments, support structure **423** can be similar or identical to support structure **323** (FIG. 3); first support substructure **426** can be similar or identical to first support substructure **326** (FIG. 3); second support substructure **427** can be similar or identical to second support substructure **327** (FIG. 3); first frame **430** can be similar or identical to first frame **330** (FIG. 3); second frame **431** can be similar or identical to second frame **331** (FIG. 3); first frame rails **434** can be similar or identical to first frame rails **334** (FIG. 3); second frame rails **435** can be similar or identical to second frame rails **335** (FIG. 3); and/or light source(s) **437** can be similar or identical to light source(s) **337** (FIG. 3). Further, frame light source(s) **438** can be similar or identical to frame light source(s) **338**.

Turning ahead again in the drawings, FIG. 5 illustrates a flow chart for an embodiment of a method **500**. In some embodiments, method **500** can comprise a method of providing a system. The system can be similar or identical to system **100** (FIG. 1) and/or system **200** (FIG. 2). Method **500** is merely exemplary and is not limited to the embodiments presented herein. Method **500** can be employed in many different embodiments or examples not specifically depicted or described herein. In some embodiments, the activities of method **500** can be performed in the order presented. In other embodiments, the activities of method **500** can be performed in any other suitable order. In still other embodiments, one or more of the activities of method **500** can be combined or skipped.

In many embodiments, method **500** can comprise activity **501** of providing one or more bioreactor walls of a bioreactor. In these or other embodiments, the bioreactor wall(s) can be similar or identical to bioreactor wall(s) **103** (FIG. 1) and/or bioreactor wall(s) **203** (FIG. 2). Further, the bioreactor can be similar or identical to bioreactor **101** (FIG. 1) and/or bioreactor **201** (FIG. 2).

In some embodiments, method **500** can comprise activity **502** of providing one or more bioreactor fittings of the bioreactor. In these or other embodiments, the bioreactor fitting(s) can be similar or identical to bioreactor fitting(s) **104** (FIG. 1). FIG. 14 illustrates an exemplary activity **502**, according to the embodiment of FIG. 5.

For example, activity **502** can comprise activity **1401** of providing an organic carbon delivery fitting. In these or other embodiments, the organic carbon material delivery fitting can be similar or identical to one of organic carbon material delivery fitting(s) **111** (FIG. 1).

Further, activity **502** can comprise activity **1402** of providing a pressure regulator. In these or other embodiments, the pressure regulator can be similar or identical to one of pressure regulator(s) **117**.

Further still, activity **502** can comprise activity **1403** of providing a filter. In these or other embodiments, the filter can be similar or identical to one of the filters described above with respect to system **100** (FIG. 1).

Referring now back to FIG. 5, in some embodiments, method **500** can comprise activity **503** of providing one or more gas delivery devices of the bioreactor. In these or other embodiments, the gas delivery device(s) can be similar or identical to gas delivery device(s) **105** (FIG. 1) and/or gas delivery device(s) **205** (FIG. 2).

In some embodiments, method **500** can comprise activity **504** of providing one or more flexible tubes of the bioreactor. In these or other embodiments, the flexible tube(s) can be similar or identical to flexible tube(s) **106** (FIG. 1). For example, in many embodiments, performing activity **504** can comprise providing an organic carbon material delivery tube of the one or more flexible tubes of the bioreactor. In

some embodiments, the organic carbon material delivery tube can be similar or identical to one of organic carbon material delivery tube(s) **114** (FIG. 1) and/or organic carbon material delivery tube **214** (FIG. 2).

In some embodiments, method **500** can comprise activity **505** of providing at least one parameter sensing device. In these or other embodiments, the parameter sensing device(s) can be similar or identical to parameter sensing device(s) **109** (FIG. 1).

In some embodiments, method **500** can comprise activity **506** of assembling the bioreactor. In these or other embodiments, performing activity **506** can be similar or identical to assembling bioreactor **101** (FIG. 1) as described above with respect to system **100** (FIG. 1). FIG. 15 illustrates an exemplary activity **506**, according to the embodiment of FIG. 5.

For example, activity **506** can comprise activity **1501** of coupling together (e.g., bonding together) the bioreactor wall(s) to at least partially form a bioreactor cavity of the bioreactor. In many embodiments, performing activity **1501** can be performed similarly or identically to coupling together bioreactor wall(s) **103** (FIG. 1) to at least partially form bioreactor cavity **102** (FIG. 1) of bioreactor **101** (FIG. 1) as described above with respect to system **100** (FIG. 1). For example, activity **1501** can comprise heat welding together the bioreactor wall(s) to at least partially form the bioreactor cavity of the bioreactor.

In some embodiments, activity **506** can comprise activity **1502** of coupling the bioreactor fitting(s) to the bioreactor wall(s). In some embodiments, activity **1502** can be performed before, after, or approximately simultaneously with activity **1502**. Meanwhile, in many embodiments, performing activity **1502** can be similar or identical to coupling bioreactor fitting(s) **104** (FIG. 1) to the bioreactor wall(s) **103** (FIG. 1) as described above with respect to system **100** (FIG. 1).

In some embodiments, activity **506** can comprise activity **1503** of coupling the gas delivery device(s) to one or more gas delivery fittings of the bioreactor fitting(s) with one or more gas delivery tubes of the flexible tube(s). In these embodiments, the gas delivery fitting(s) can be similar or identical to gas delivery fitting(s) **105** (FIG. 1) and/or gas delivery fitting(s) **205** (FIG. 2); and/or the gas delivery tube(s) can be similar or identical to gas delivery tube(s) **106** (FIG. 1) and/or gas delivery tube(s) **206** (FIG. 2). In some embodiments, activity **1503** can be performed before, after, or approximately simultaneously with activity **1501** and/or activity **1502**.

In some embodiments, activity **506** can comprise activity **1504** of placing the gas delivery device(s) inside the bioreactor cavity. In these embodiments, activity **1504** can be performed before activity **1501** is completed.

In some embodiments, activity **506** can comprise activity **1505** of placing the at least one parameter sensing device in at least one bioreactor fitting of the one or more bioreactor fittings. In many embodiments, performing activity **1505** can be similar or identical to placing parameter sensing device(s) **109** (FIG. 1) in at least one bioreactor fitting of bioreactor fitting(s) **104** (FIG. 1).

Turning ahead again in the drawings, FIG. 6 illustrates a flow chart for an embodiment of a method **600**. Method **600** is merely exemplary and is not limited to the embodiments presented herein. Method **600** can be employed in many different embodiments or examples not specifically depicted or described herein. In some embodiments, the activities of method **600** can be performed in the order presented. In other embodiments, the activities of method **600** can be

performed in any other suitable order. In still other embodiments, one or more of the activities of method 600 can be combined or skipped.

In many embodiments, method 600 can comprise activity 601 of sterilizing a bioreactor. In these embodiments, the bioreactor can be similar or identical to bioreactor 101 (FIG. 1) and/or bioreactor 201 (FIG. 2). FIG. 7 illustrates a flow chart of an exemplary activity 601, according to the embodiment of FIG. 6.

For example, activity 601 can comprise activity 701 of gamma irradiating the bioreactor. In many embodiments, activity 701 can be performed by exposing the bioreactor to a radioactive isotope configured to emit gamma radiation.

In some embodiments, activity 601 can comprise activity 702 of autoclaving the bioreactor. Activity 702 can be performed similarly or identically to autoclaving bioreactor 101 (FIG. 1) as described above with respect to system 100 (FIG. 1). In some embodiments, activity 701 can be omitted when activity 702 is performed, or vice versa. In other embodiments, both activity 701 and activity 702 can be performed.

Referring now back to FIG. 6, method 600 can comprise activity 602 of vitally supporting with the bioreactor one or more first organisms. In these embodiments, the first organism(s) can be similar or identical to the organism(s) described above with respect to system 100 (FIG. 1). Further, activity 602 can be performed similarly or identically to vitally supporting one or more organisms with bioreactor 101 (FIG. 1) as described above with respect to system 100 (FIG. 1). In many embodiments, activity 602 can be performed after activity 601. FIG. 8 illustrates a flow chart of an exemplary activity 602, according to the embodiment of FIG. 6.

For example, activity 602 can comprise activity 801 of illuminating the first organism(s). In many embodiments, activity 801 can be performed using one or more light source(s), which can be similar or identical to light source(s) 337 (FIG. 3) and/or light source(s) 437 (FIG. 4). In some embodiments, performing activity 801 can comprise supplying a quantity of light to the first organism(s) based on a culture density of the first organism(s). In some embodiments, activity 801 can be omitted, such as, for example, when the first organism(s) are not phototrophic organism(s).

In some embodiments, activity 602 can comprise activity 802 of supplying organic carbon material to the first organism(s). Activity 802 can be performed similarly or identically to supplying organic carbon material to the organism(s) as described above with respect to system 100 (FIG. 1). Further, the organic carbon material can be similar or identical to the organic carbon material described above with respect to system 100 (FIG. 1). In some embodiments, activity 802 can be omitted, such as, for example, when the first organism(s) comprise autotrophic organism(s).

In many embodiments, activity 602 can comprise activity 803 of mixing the first organism(s) within a fluidic support medium by injecting gas into the fluidic support medium. The fluidic support medium can be similar or identical to the fluidic support medium described above with respect to system 100 (FIG. 1). Further, the gas can be similar or identical to the gas described above with respect to gas delivery device(s) 105 (FIG. 1) of system 100 (FIG. 1). Further still, activity 803 can be performed similarly or identically to mixing the organism(s) within a fluidic support medium by injecting gas into the fluidic support medium as described above with respect to system 100 (FIG. 1).

In further embodiments, activity 602 can comprise activity 804 of supplying one or more nutritional media to the

first organism(s) when a culture density of the first organism(s) reaches a threshold culture density. In some embodiments, performing activity 804 can be similar or identical to supplying one or more nutritional media to the first organism(s) when a culture density of the first organism(s) reaches a threshold culture density as described above with respect to system 100 (FIG. 1). The one or more nutritional media can be similar or identical to the one or more nutritional media described above with respect to system 100 (FIG. 1).

In some embodiments, activity 602 can comprise activity 805 of monitoring a cavity environment condition at a bioreactor cavity of the bioreactor with a parameter sensing device. The bioreactor cavity can be similar or identical to bioreactor cavity 102 (FIG. 1) and/or bioreactor cavity 202 (FIG. 2); and/or the parameter sensing device can be similar or identical to one of parameter sensing device(s) 109 (FIG. 1).

In some embodiments, activity 602 can comprise activity 806 of operating the bioreactor in substantially axenic conditions. In many embodiments, activity 806 can be performed simultaneously with one or more of activities 801-805.

Referring back to FIG. 6, method 600 can comprise activity 603 of removing at least part of the first organism(s) from the bioreactor. In many embodiments, activity 603 can be performed similarly or identically to partially or fully harvesting (e.g., removing) the organism(s) from bioreactor 101 (FIG. 1) as described above with respect to system 100 (FIG. 1). In some embodiments, activity 603 can be performed after activity 602 and/or before one or both of activities 604 and 605. In many embodiments, activity 603 can be repeated one or more times, such as, for example, when the first organism(s) reach one or more culture densities as described above with respect to system 100 (FIG. 1).

In many embodiments, method 600 can comprise activity 604 of gathering up the bioreactor (e.g., after removing the organism(s) from the bioreactor). Activity 604 can be performed similarly or identically to gathering up bioreactor 101 (FIG. 1) as described above with respect to system 100 (FIG. 1). In various embodiments, activity 604 can be performed one or more times. For example, activity 604 can be performed before activity 601 (e.g., when activity 601 comprises activity 702) and/or before activity 605. FIG. 9 illustrates a flow chart of an exemplary activity 604, according to the embodiment of FIG. 6.

Activity 604 can comprise activity 901 of folding up the bioreactor (e.g., after removing the first organism(s) from the bioreactor). Further, activity 604 can comprise activity 902 of rolling up the bioreactor (e.g., after removing the first organism(s) from the bioreactor). In some embodiments, only one or both of activity 901 and activity 902 can be performed.

Referring again to FIG. 6, method 600 can comprise activity 605 of resterilizing the bioreactor. Performing activity 605 can be similar or identical to performing activity 702 (FIG. 7).

Further, method 600 can comprise activity 606 of vitally supporting with the bioreactor one or more second organisms with the bioreactor. Performing activity 606 can be similar to performing activity 602 but with respect to the second organism(s). In many embodiments, activity 606 can be performed after activity 605.

Turning ahead again in the drawings, FIG. 10 illustrates a flow chart for an embodiment of a method 1000. Method 1000 is merely exemplary and is not limited to the embodi-

ments presented herein. Method **1000** can be employed in many different embodiments or examples not specifically depicted or described herein. In some embodiments, the activities of method **1000** can be performed in the order presented. In other embodiments, the activities of method **1000** can be performed in any other suitable order. In still other embodiments, one or more of the activities of method **1000** can be combined or skipped.

In many embodiments, method **1000** can comprise activity **1001** of inoculating a bioreactor with one or more first organisms and a fluidic support medium. In some embodiments, activity **1001** can be performed similarly or identically to inoculating bioreactor **101** with one or more organisms and a fluidic support medium as described above with respect to system **100** (FIG. 1). The bioreactor can be similar or identical to bioreactor **101**. Further, the first organism(s) and/or the fluidic support medium can be similar or identical to the organism(s) and/or the fluidic support medium as described above with respect to system **100** (FIG. 1).

In these or other embodiments, method **1000** can comprise activity **1002** of vitally supporting the first organism(s). In many embodiments, performing activity **1002** can be similar or identical to performing activity **602** (FIG. 6). In further embodiments, activity **1002** can be performed after activity **1001**. Further, activity **1002** can be performed to achieve the average densities and/or average maximum production rates of the first organism(s) as described above with respect to system **100** (FIG. 1).

Further, method **1000** can comprise activity **1003** of autoclaving the bioreactor. For example, performing activity **1003** can be similar or identical to performing activity **702** (FIG. 7). In many embodiments, activity **1003** can be performed after activity **1001** and/or activity **1002**.

In some embodiments, method **1000** can comprise activity **1004** of inoculating the bioreactor with one or more second organisms. The second organism(s) can be similar or identical to the organism(s) described above with respect to system **100** (FIG. 1). In many embodiments, performing activity **1004** can be similar or identical to performing activity **1001**. In these or other embodiments, activity **1004** can be performed after activity **1003**.

Further, method **1000** can comprise activity **1005** of vitally supporting the one or more second organisms. In many embodiments, performing activity **1005** can be similar or identical to performing activity **1002**. In these or other embodiments, activity **1005** can be performed after activity **1004**.

In some embodiments, method **1000** can comprise activity **1006** of mechanically supporting the bioreactor with a support structure. The support structure can be similar or identical to support structure **323** (FIG. 3) and/or support structure **423** (FIG. 4). Further, activity **1006** can be performed similarly or identically to mechanically supporting one of bioreactor(s) **324** (FIG. 3) with support structure **323** (FIG. 3) as described above with respect to system **300** (FIG. 3).

In further embodiments, method **1000** can comprise activity **1007** of supplying a temperature maintenance fluid to a first frame and/or a second frame of the support structure to maintain a set point temperature of the bioreactor. The temperature maintenance fluid can be similar or identical to the temperature maintenance fluid described above with respect to system **300** (FIG. 3). Further, the set point temperature can be similar or identical to the set point temperature described above with respect to system **100** (FIG. 1) and/or system **300** (FIG. 3). Meanwhile, the first frame can be similar or identical to first frame **330** (FIG. 3)

and/or first frame **430** (FIG. 4); and/or the second frame can be similar or identical to second frame **331** (FIG. 3) and/or second frame **431** (FIG. 4). Activity **1007** can be performed similarly or identically to supplying a temperature maintenance fluid to first frame **330** (FIG. 3) and/or second frame **331** (FIG. 3) of support structure **323** (FIG. 3) to maintain a set point temperature of bioreactor **328** (FIG. 3) as described above with respect to system **300** (FIG. 3) and/or temperature maintenance fluid manifold **343** (FIG. 3). In some embodiments, activity **1006** and/or activity **1007** can be omitted.

Turning ahead again in the drawings, FIG. 11 illustrates a flow chart for an embodiment of a method **1100**. In some embodiments, method **1100** can comprise a method of providing a system. The system can be similar or identical to system **300** (FIG. 3) and/or system **400** (FIG. 4). Method **1100** is merely exemplary and is not limited to the embodiments presented herein. Method **1100** can be employed in many different embodiments or examples not specifically depicted or described herein. In some embodiments, the activities of method **1100** can be performed in the order presented. In other embodiments, the activities of method **1100** can be performed in any other suitable order. In still other embodiments, one or more of the activities of method **1100** can be combined or skipped.

In many embodiments, method **1100** can comprise activity **1101** of providing a support structure. In these embodiments, the support structure can be similar or identical to support structure **323** (FIG. 3) and/or support structure **423** (FIG. 4). FIG. 12 illustrates a flow chart for an exemplary activity **1101**, according to the embodiment of FIG. 11.

For example, activity **1101** can comprise activity **1201** of providing a first frame. In these embodiments, the first frame can be similar or identical to first frame **330** (FIG. 3), first frame **430** (FIG. 4), and/or first frame **332** (FIG. 3). For example, performing activity **1201** can comprise providing two or more first frame rails. The first frame rails can be similar or identical to first frame rails **334** (FIG. 3) and/or first frame rails **434** (FIG. 4).

Further, activity **1101** can comprise activity **1202** of providing a second frame. For example, performing activity **1202** can comprise providing two or more second frame rails. The second frame rails can be similar to first frame rails **334** (FIG. 3) and/or first frame rails **434** (FIG. 4) and similar or identical to the second frame rails described above with respect to system **300** (FIG. 3).

In some embodiments, activity **1101** can comprise activity **1203** of configuring the first frame and the second frame such that the first frame and the second frame together are operable to mechanically support a bioreactor in interposition between the first frame and the second frame. For example, performing activity **1203** can comprise orienting the first frame and the second frame vertically and parallel to each other to form a slot in between.

Referring back to FIG. 11, in some embodiments, method **1100** can comprise activity **1102** of providing the bioreactor. The bioreactor can be similar or identical to bioreactor **101** (FIG. 1), bioreactor **200** (FIG. 2), one of bioreactor(s) **324** (FIG. 3), and/or bioreactor **328** (FIG. 3).

Further, method **1100** can comprise activity **1103** of interposing the bioreactor between the first frame and the second frame. For example, performing activity **1103** can comprise lowering the bioreactor into the slot formed between the first frame and the second frame. In some embodiments, activity **1103** can be performed approximately simultaneously with or after activity **1102**.

Meanwhile, in some embodiments, method **1100** can comprise activity **1104** of providing the temperature maintenance fluid to first frame rail conduits of the first frame rails. The first frame rail conduits can be similar or identical to the hollow conduits of first frame rails **334** (FIG. 3). In some embodiments, activity **1104** can be omitted.

In some embodiments, method **1100** can comprise activity **1105** of providing a containment vessel. In many embodiments, the containment vessel can be similar or identical to the containment vessel described above with respect to system **100** (FIG. 1).

Further, method **1100** can comprise activity **1106** of interposing the bioreactor within the containment vessel and between the first frame and the second frame. In many embodiments, performing activity **1106** can be similar or identical to interposing the bioreactor within the containment vessel and between the first frame and the second frame as described above with respect to system **100** (FIG. 1).

Further still, method **1100** can comprise activity **1107** of filling a gap formed between an exterior of one or more bioreactor walls of the bioreactor and an interior of one or more containment vessel walls of the containment vessel with a containment vessel fluid (e.g., water). In many embodiments, the containment vessel fluid can be similar or identical to the containment vessel fluid described above with respect to system **100** (FIG. 1). In these or other embodiments, performing activity **1107** can be similar or identical to filling a gap formed between an exterior of one or more bioreactor walls of the bioreactor and an interior of one or more containment vessel walls of the containment vessel with a containment vessel fluid as described above with respect to system **100** (FIG. 1).

Turning ahead again in the drawings, FIG. 13 illustrates a flow chart for an embodiment of a method **1300**. Method **1300** is merely exemplary and is not limited to the embodiments presented herein. Method **1300** can be employed in many different embodiments or examples not specifically depicted or described herein. In some embodiments, the activities of method **1300** can be performed in the order presented. In other embodiments, the activities of method **1300** can be performed in any other suitable order. In still other embodiments, one or more of the activities of method **1300** can be combined or skipped.

In some embodiments, method **1300** can comprise activity **1301** of vitally supporting one or more first organisms at a first bioreactor. The first bioreactor can be similar or identical to bioreactor **101** (FIG. 1), bioreactor **200** (FIG. 2), one or bioreactor(s) **324** (FIG. 3), and/or first bioreactor **328** (FIG. 3). Also, the first organism(s) can be similar or identical to the organism(s) described above with respect to system **100** (FIG. 1).

Further, method **1300** can comprise activity **1302** of mechanically supporting the first bioreactor between a first frame and a second frame of a support structure. In these embodiments, the support structure can be similar or identical to support structure **323** (FIG. 3) and/or support structure **423** (FIG. 4); the first frame can be similar or identical to first frame **330** (FIG. 3) and/or first frame **430** (FIG. 4); and/or the second frame can be similar or identical to first frame **331** (FIG. 3) and/or second frame **431** (FIG. 4).

In some embodiments, method **1300** can comprise activity **1303** of supplying a temperature maintenance fluid to the first frame to maintain a first set point temperature of the first bioreactor. The temperature maintenance fluid and the first set point temperature can be similar or identical to the temperature maintenance fluid and the set point temperature

described above with respect to system **300** (FIG. 3). In some embodiments, activity **1303** can be omitted.

In further embodiments, method **1300** can comprise activity **1304** of supplying the temperature maintenance fluid to the second frame to maintain the first set point temperature of the first bioreactor. In some embodiments, activity **1304** can be omitted.

Meanwhile, in many embodiments, method **1300** can comprise activity **1305** of vitally supporting one or more second organisms at a second bioreactor. The first bioreactor can be similar or identical to bioreactor **101** (FIG. 1), bioreactor **200** (FIG. 2), one or bioreactor(s) **324** (FIG. 3), and/or second bioreactor **329** (FIG. 3). Also, the second organism(s) can be similar or identical to the organism(s) described above with respect to system **100** (FIG. 1).

Further, method **1300** can comprise activity **1306** of mechanically supporting the second bioreactor between a third frame and a fourth frame of the support structure. In these embodiments, the third frame can be similar or identical to first frame **332** (FIG. 3) and/or first frame **432** (FIG. 4); and/or the fourth frame can be similar or identical to first frame **333** (FIG. 3) and/or second frame **431** (FIG. 4).

In some embodiments, method **1300** can comprise activity **1307** of supplying the temperature maintenance fluid to the third frame to maintain a second set point temperature of the second bioreactor. The second set point temperature can be similar or identical to the set point temperature described above with respect to system **300** (FIG. 3). In some embodiments, activity **1307** can be omitted.

In further embodiments, method **1300** can comprise activity **1308** of supplying the temperature maintenance fluid to the fourth frame to maintain the second set point temperature of the second bioreactor. In some embodiments activity **1308** can be omitted.

Meanwhile, in many embodiments, two or more of activities **1301-1308** can be performed approximately simultaneously with each other.

Although the invention has been described with reference to specific embodiments, it will be understood by those skilled in the art that various changes may be made without departing from the spirit or scope of the invention. Accordingly, the disclosure of embodiments of the invention is intended to be illustrative of the scope of the invention and is not intended to be limiting. It is intended that the scope of the invention shall be limited only to the extent required by the appended claims. For example, to one of ordinary skill in the art, it will be readily apparent that one or more of the activities of method **500** (FIG. 5), method **600** (FIG. 6), method **1000** (FIG. 10), method **1100** (FIG. 11), and/or method **1300** (FIG. 13) may be comprised of many different activities, be performed by many different modules, and in many different orders, that any element of FIGS. 1-15 may be modified, and that the foregoing discussion of certain of these embodiments does not necessarily represent a complete description of all possible embodiments.

Generally, replacement of one or more claimed elements constitutes reconstruction and not repair. Additionally, benefits, other advantages, and solutions to problems have been described with regard to specific embodiments. The benefits, advantages, solutions to problems, and any element or elements that may cause any benefit, advantage, or solution to occur or become more pronounced, however, are not to be construed as critical, required, or essential features or elements of any or all of the claims, unless such benefits, advantages, solutions, or elements are stated in such claim.

Moreover, embodiments and limitations disclosed herein are not dedicated to the public under the doctrine of dedi-

cation if the embodiments and/or limitations: (1) are not expressly claimed in the claims; and (2) are or are potentially equivalents of express elements and/or limitations in the claims under the doctrine of equivalents.

What is claimed is:

1. A method comprising:

inoculating a bioreactor with one or more first microorganisms and a first fluidic support medium, wherein the bioreactor comprises one or more bioreactor walls and one or more bioreactor fittings, the one or more bioreactor walls together with the one or more bioreactor fittings fully enclose a bioreactor cavity, the bioreactor is configured to be gathered up, the bioreactor is sterile when the bioreactor is inoculated with the one or more first microorganisms, the one or more bioreactor walls comprise at least one bioreactor wall material, the at least one bioreactor wall material is flexible and at least partially transparent;

vitaly supporting the one or more first microorganisms with the bioreactor, a supply of light, and a supply of organic carbon, such that when the one or more first microorganism are taxonomically classified in the taxonomic family Chlorellaceae, at least one of the average density of the one or more first microorganisms is greater than or equal to approximately 36 grams per liter or the average maximum production rate of the one or more first microorganisms is greater than or equal to approximately 9 grams per liter per day;

after vitaly supporting the one or more first microorganisms with the bioreactor, applying water to the bioreactor cavity and gathering up the assembled bioreactor to include the one or more bioreactor walls and the one or more bioreactor fittings, wherein gathering up the assembled bioreactor comprises at least one of folding up the bioreactor or rolling up the bioreactor;

autoclaving the bioreactor while the bioreactor is assembled, gathered up, and containing water;

after autoclaving the bioreactor, inoculating the bioreactor with one or more second microorganisms, the bioreactor being sterile when the bioreactor is inoculated with the one or more second microorganisms; and

after inoculating the bioreactor with the one or more second microorganisms, vitaly supporting the one or more second microorganisms with the bioreactor.

2. The method of claim 1 wherein:

the one or more bioreactor fittings comprise at least one gas delivery fitting; and

the bioreactor further comprises:

one or more gas delivery devices located within the bioreactor cavity, the one or more gas delivery devices being operable to inject gas into the bioreactor cavity to mix the one or more microorganisms; and

one or more flexible tubes located within the bioreactor cavity, the one or more flexible tubes comprising at least one gas delivery tube coupling the one or more gas delivery devices to the at least one gas delivery fitting.

3. The method of claim 2 wherein:

autoclaving the bioreactor while the bioreactor is assembled to include the one or more bioreactor walls and the one or more bioreactor fittings further comprises autoclaving the bioreactor while the bioreactor is assembled to include the one or more bioreactor walls, the one or more bioreactor fittings, the one or more flexible tubes, and the one or more gas delivery devices.

4. The method of claim 2 wherein:

when the bioreactor is assembled to include the one or more bioreactor walls, the one or more bioreactor fittings, the one or more flexible tubes, and the one or more gas delivery devices, the bioreactor further comprises a greatest physical dimension; and

the bioreactor, as assembled, is configured to be gathered up, wherein the gathered up assembled bioreactor comprises at least one of folded up or rolled up such that the greatest physical dimension is reducible by at least approximately 75%.

5. The method of claim 2 wherein:

vitaly supporting the one or more first microorganism with the bioreactor comprises:

placing a parameter sensing means at a bioreactor fitting of the one or more bioreactor fittings; and monitoring a cavity environment condition at the bioreactor cavity with the parameter sensing means.

6. The method of claim 1 further comprising:

mechanically supporting the bioreactor with a support structure comprising a first frame and a second frame together being operable to mechanically support the bioreactor in interposition between the first frame and the second frame, wherein the first frame comprises two or more first frame rails comprising a hollow first frame rail conduit and each first frame rail is approximately planar with the other first frame rails and spaced along the plane relative to the other first frame rails, and the first frame rails are configured to form a floor gap disposed at a base of the first frame between a floor and a lowest first frame rail; and

conveying a temperature maintenance fluid through the hollow first frame rail conduit of the two or more first frame rails to maintain a set point temperature of the bioreactor through an exchange of thermal energy between the hollow first frame rail conduit and the bioreactor, wherein the hollow first frame rail conduit simultaneously provides mechanical support to the bioreactor and vitaly supports the one or more first microorganism in the bioreactor by maintaining a set point temperature of the bioreactor.

7. The method of claim 6, further comprising:

relieving stress at a base end of the bioreactor disposed closest to the floor by expanding the flexible material of at least one bioreactor wall at the base end from between the first frame and second frame into the floor gap.

8. The method of claim 1 wherein:

vitaly supporting the one or more first microorganisms with the bioreactor comprises:

mixing the one or more first microorganisms within the first fluidic support medium by injecting gas into the first fluidic support medium;

and

the gas comprises gas bubbles comprising a diameter greater than or equal to approximately 40 micrometers and less than or equal to approximately 2 millimeters.

9. The method of claim 1 wherein:

vitaly supporting the one or more first microorganisms with the bioreactor comprises:

mixing the one or more first microorganisms within the first fluidic support medium by injecting gas into the first fluidic support medium at a volumetric flow rate of greater than or equal to approximately 10 liters per minute and less than or equal to approximately 60 liters per minute.

10. A method comprising:
 inoculating a bioreactor with one or more first microorganisms and a first fluidic support medium, wherein the bioreactor comprises one or more bioreactor walls and one or more bioreactor fittings, the one or more bioreactor walls together with the one or more bioreactor fittings fully enclose a bioreactor cavity, the bioreactor is configured to be gathered up, the bioreactor is sterile when the bioreactor is inoculated with the one or more first microorganisms, the one or more bioreactor walls comprise at least one bioreactor wall material, the at least one bioreactor wall material is flexible and at least partially transparent;
 vitally supporting the one or more first microorganisms with the bioreactor, a supply of light, and a supply of organic carbon, such that when the one or more first microorganism are taxonomically classified in the taxonomic family Chlorellaceae, at least one of the average density of the one or more first microorganisms is greater than or equal to approximately 36 grams per liter or the average maximum production rate of the one or more first microorganisms is greater than or equal to approximately 9 grams per liter per day;
 mechanically supporting the bioreactor with a support structure comprising a first frame and a second frame together being operable to mechanically support the bioreactor in interposition between the first frame and the second frame, wherein the first frame comprises two or more first frame rails comprising a hollow first frame rail conduit and each first frame rail is approximately planar with the other first frame rails and spaced along the plane relative to the other first frame rails, and the first frame rails are configured to form a floor gap disposed at a base of the first frame between a floor and a lowest first frame rail; and
 conveying a temperature maintenance fluid through the hollow first frame rail conduit of the two or more first frame rails to maintain a set point temperature of the bioreactor through an exchange of thermal energy between the hollow first frame rail conduit and the bioreactor, wherein the hollow first frame rail conduit simultaneously provides mechanical support to the bioreactor and vitally supports the one or more first microorganism in the bioreactor by maintaining a set point temperature of the bioreactor.

11. The method of claim 10 wherein:
 the one or more bioreactor fittings comprise at least one gas delivery fitting; and
 the bioreactor further comprises:
 one or more gas delivery devices located within the bioreactor cavity, the one or more gas delivery devices being operable to inject gas into the bioreactor cavity to mix the one or more microorganisms; and
 one or more flexible tubes located within the bioreactor cavity, the one or more flexible tubes comprising at least one gas delivery tube coupling the one or more gas delivery devices to the at least one gas delivery fitting.

12. The method of claim 11 further comprising:
 after vitally supporting the one or more first microorganisms with the bioreactor, applying water to the bioreactor cavity and gathering up the assembled bioreactor to include the one or more bioreactor walls, the one or more bioreactor fittings, the one or more flexible tubes, and the one or more gas delivery devices, wherein

gathering up the assembled bioreactor comprises at least one of folding up the bioreactor or rolling up the bioreactor;
 autoclaving the bioreactor while the bioreactor is assembled, gathered up, and containing water;
 after autoclaving the bioreactor, inoculating the bioreactor with one or more second microorganisms, the bioreactor being sterile when the bioreactor is inoculated with the one or more second microorganisms; and
 after inoculating the bioreactor with the one or more second microorganisms, vitally supporting the one or more second microorganisms with the bioreactor.

13. The method of claim 11 wherein:
 when the bioreactor is assembled to include the one or more bioreactor walls, the one or more bioreactor fittings, the one or more flexible tubes, and the one or more gas delivery devices, the bioreactor further comprises a greatest physical dimension; and
 the bioreactor, as assembled, is configured to be gathered up wherein the gathered up assembled bioreactor comprises at least one of folded up or rolled up such that the greatest physical dimension is reducible by at least approximately 75%.

14. The method of claim 13 wherein:
 vitally supporting the one or more first microorganism with the bioreactor comprises:
 placing a parameter sensing means at a bioreactor fitting of the one or more bioreactor fittings; and
 monitoring a cavity environment condition at the bioreactor cavity with the parameter sensing means.

15. The method of claim 13 wherein:
 vitally supporting the one or more first microorganisms with the bioreactor comprises:
 mixing the one or more first microorganisms within the first fluidic support medium by injecting gas into the first fluidic support medium;
 and
 the gas comprises gas bubbles comprising a diameter greater than or equal to approximately 40 micrometers and less than or equal to approximately 2 millimeters.

16. The method of claim 13 wherein:
 vitally supporting the one or more first microorganisms with the bioreactor comprises:
 mixing the one or more first microorganisms within the first fluidic support medium by injecting gas into the first fluidic support medium at a volumetric flow rate of greater than or equal to approximately 10 liters per minute and less than or equal to approximately 60 liters per minute.

17. The method of claim 10 wherein:
 the bioreactor cavity comprises a greatest lateral cross sectional area; and
 the greatest lateral cross sectional area is greater than or equal to approximately 0.043 square meters and less than or equal to approximately 0.318 square meters.

18. The method of claim 10, further comprising:
 relieving stress at a base end of the bioreactor disposed closest to the floor by expanding the flexible material of at least one bioreactor wall at the base end from between the first frame and second frame into the floor gap.

19. The method of claim 1 wherein:
 the bioreactor cavity comprises a greatest lateral cross sectional area; and
 the greatest lateral cross sectional area is greater than or equal to approximately 0.043 square meters and less than or equal to approximately 0.318 square meters.

20. The method of claim 1 wherein:
the bioreactor cavity comprises a greatest lateral cross
sectional area; and
the greatest lateral cross sectional area is greater than or
equal to approximately 0.043 square meters and less 5
than or equal to approximately 0.318 square meters;
the one or more bioreactor fittings comprise at least one
gas delivery fitting;
the bioreactor further comprises:
one or more gas delivery devices located within the 10
bioreactor cavity, the one or more gas delivery
devices being operable to inject gas into the biore-
actor cavity to mix the one or more microorganisms;
and
one or more flexible tubes located within the bioreactor 15
cavity, the one or more flexible tubes comprising at
least one gas delivery tube coupling the one or more
gas delivery devices to the at least one gas delivery
fitting;
and 20
a ratio of an active area of the one or more gas delivery
devices to the greatest lateral cross sectional area of the
bioreactor cavity is greater than or equal to approxi-
mately 13.00 and less than or equal to approximately
30.64. 25

* * * * *