



US010043516B2

(12) **United States Patent**
Saddler et al.

(10) **Patent No.:** **US 10,043,516 B2**
(45) **Date of Patent:** **Aug. 7, 2018**

(54) **INTELLIGENT AUTOMATED ASSISTANT**

(58) **Field of Classification Search**

(71) Applicant: **Apple Inc.**, Cupertino, CA (US)

None

See application file for complete search history.

(72) Inventors: **Harry J. Saddler**, Berkeley, CA (US);
Aimee T. Piercy, Cupertino, CA (US);
Garrett L. Weinberg, Cupertino, CA (US);
Susan L. Booker, Cupertino, CA (US)

(56) **References Cited**

U.S. PATENT DOCUMENTS

6,011,585 A 1/2000 Anderson
6,014,428 A 1/2000 Wolf

(Continued)

(73) Assignee: **Apple Inc.**, Cupertino, CA (US)

(*) Notice: Subject to any disclaimer, the term of this patent is extended or adjusted under 35 U.S.C. 154(b) by 0 days.

FOREIGN PATENT DOCUMENTS

CA 2631796 A1 7/2007
CA 2694314 A1 8/2010

(Continued)

(21) Appl. No.: **15/385,606**

(22) Filed: **Dec. 20, 2016**

OTHER PUBLICATIONS

(65) **Prior Publication Data**
US 2018/0090143 A1 Mar. 29, 2018

“Alexa, Turn Up the Heat!”, Smartthings Samsung [online], Available online at <https://web.archive.org/web/20160329142041/https://blog.smartthings.com/news/smartthingsupdates/alexa-turn-up-the-heat/>, Mar. 3, 2016, 3 pages.

(Continued)

Related U.S. Application Data

(60) Provisional application No. 62/399,232, filed on Sep. 23, 2016.

Primary Examiner — Douglas Godbold

(74) *Attorney, Agent, or Firm* — Dentons US LLP

(51) **Int. Cl.**
G10L 15/22 (2006.01)
G10L 15/18 (2013.01)
G06F 3/16 (2006.01)
G10L 13/02 (2013.01)
G10L 15/08 (2006.01)

(57) **ABSTRACT**

Systems and processes for operating an automated assistant are disclosed. In one example process, an electronic device provides an audio output via a speaker of the electronic device. While providing the audio output, the electronic device receives, via a microphone of the electronic device, a natural language speech input. The electronic device derives a representation of user intent based on the natural language speech input and the audio output, identifies a task based on the derived user intent; and performs the identified task.

(Continued)

(52) **U.S. Cl.**
CPC **G10L 15/22** (2013.01); **G06F 3/165** (2013.01); **G10L 13/02** (2013.01); **G10L 15/1815** (2013.01); **G06F 3/0482** (2013.01); **G06F 3/0488** (2013.01); **G06F 3/04817** (2013.01); **G10L 2015/088** (2013.01); **G10L 2015/221** (2013.01); **G10L 2015/223** (2013.01)

33 Claims, 39 Drawing Sheets

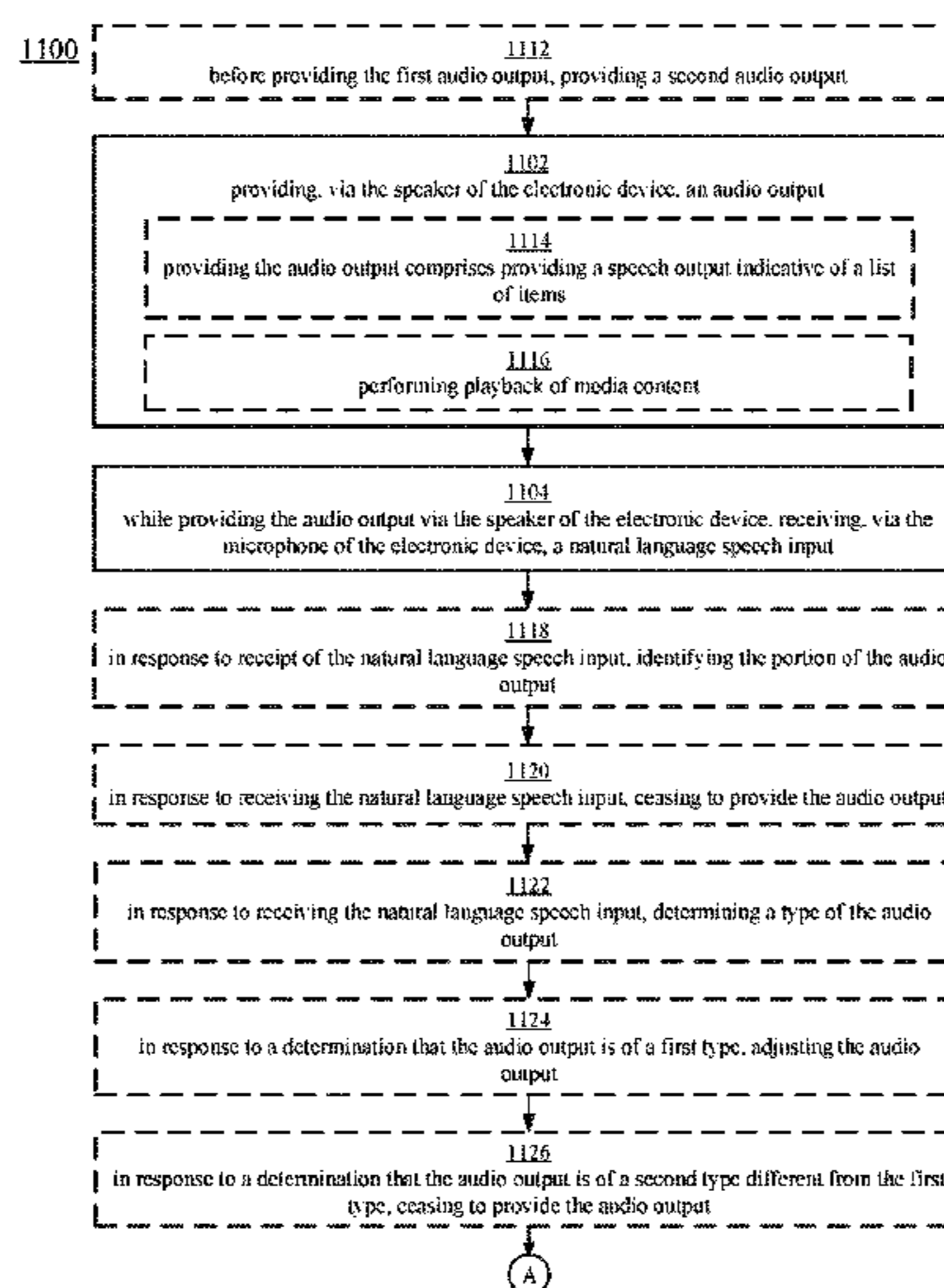

- (51) **Int. Cl.**
G06F 3/0481 (2013.01)
G06F 3/0488 (2013.01)
G06F 3/0482 (2013.01)

(56) **References Cited**
 U.S. PATENT DOCUMENTS

6,016,471 A	1/2000	Kuhn et al.	6,115,686 A	9/2000	Chung et al.
6,017,219 A	1/2000	Adams, Jr. et al.	6,116,907 A	9/2000	Baker et al.
6,018,705 A	1/2000	Gaudet	6,119,101 A	9/2000	Peckover
6,018,711 A	1/2000	French-St. George et al.	6,121,960 A	9/2000	Carroll et al.
6,020,881 A	2/2000	Naughton et al.	6,122,340 A	9/2000	Darley et al.
6,023,536 A	2/2000	Visser	6,122,614 A	9/2000	Kahn et al.
6,023,676 A	2/2000	Erell	6,122,616 A	9/2000	Henton
6,023,684 A	2/2000	Pearson	6,122,647 A	9/2000	Horowitz et al.
6,024,288 A	2/2000	Gottlich et al.	6,125,284 A	9/2000	Moore et al.
6,026,345 A	2/2000	Shah et al.	6,125,346 A	9/2000	Nishimura et al.
6,026,375 A	2/2000	Hall et al.	6,125,356 A	9/2000	Brockman et al.
6,026,388 A	2/2000	Liddy et al.	6,129,582 A	10/2000	Wilhite et al.
6,026,393 A	2/2000	Gupta et al.	6,138,098 A	10/2000	Shieber et al.
6,029,132 A	2/2000	Kuhn et al.	6,138,158 A	10/2000	Boyle et al.
6,029,135 A	2/2000	Krasle	6,141,642 A	10/2000	Oh
6,035,267 A	3/2000	Watanabe et al.	6,141,644 A	10/2000	Kuhn et al.
6,035,303 A	3/2000	Baer et al.	6,144,377 A	11/2000	Oppermann et al.
6,035,336 A	3/2000	Lu et al.	6,144,380 A	11/2000	Shwarts et al.
6,038,533 A	3/2000	Buchsbaum et al.	6,144,938 A	11/2000	Surace et al.
6,040,824 A	3/2000	Maekawa et al.	6,144,939 A	11/2000	Pearson et al.
6,041,023 A	3/2000	Lakhansingh	6,151,401 A	11/2000	Annaratone
6,047,255 A	4/2000	Williamson	6,151,574 A	11/2000	Lee et al.
6,047,300 A	4/2000	Walfish et al.	6,154,551 A	11/2000	Frenkel
6,052,654 A	4/2000	Gaudet et al.	6,154,720 A	11/2000	Onishi et al.
6,052,656 A	4/2000	Suda et al.	6,157,935 A	12/2000	Tran et al.
6,054,990 A	4/2000	Tran	6,161,084 A	12/2000	Messerly et al.
6,055,514 A	4/2000	Wren	6,161,087 A	12/2000	Wightman et al.
6,055,531 A	4/2000	Bennett et al.	6,161,944 A	12/2000	Leman
6,061,646 A	5/2000	Martino et al.	6,163,769 A	12/2000	Acero et al.
6,064,767 A	5/2000	Muir et al.	6,163,809 A	12/2000	Buckley
6,064,951 A	5/2000	Park et al.	6,167,369 A	12/2000	Schulze
6,064,959 A	5/2000	Young et al.	6,169,538 B1	1/2001	Nowlan et al.
6,064,960 A	5/2000	Bellegarda et al.	6,172,948 B1	1/2001	Keller et al.
6,064,963 A	5/2000	Gainsboro	6,173,194 B1	1/2001	Vanttila
6,067,519 A	5/2000	Lowry	6,173,251 B1	1/2001	Ito et al.
6,067,520 A	5/2000	Lee	6,173,261 B1	1/2001	Arai et al.
6,069,648 A	5/2000	Suso et al.	6,173,263 B1	1/2001	Conkie
6,070,138 A	5/2000	Iwata	6,173,279 B1	1/2001	Levin et al.
6,070,139 A	5/2000	Miyazawa et al.	6,177,905 B1	1/2001	Welch
6,070,140 A	5/2000	Tran	6,177,931 B1	1/2001	Alexander et al.
6,070,147 A	5/2000	Harms et al.	6,179,432 B1	1/2001	Zhang et al.
6,073,033 A	6/2000	Campo	6,182,028 B1	1/2001	Karaali et al.
6,073,036 A	6/2000	Heikkinen et al.	6,182,099 B1	1/2001	Nakasato
6,073,091 A	6/2000	Kanevsky et al.	6,185,533 B1	2/2001	Holm et al.
6,073,097 A	6/2000	Gould et al.	6,188,391 B1	2/2001	Seely et al.
6,076,051 A	6/2000	Messerly et al.	6,188,967 B1	2/2001	Kurtzberg et al.
6,076,060 A	6/2000	Lin et al.	6,188,999 B1	2/2001	Moody
6,076,088 A	6/2000	Paik et al.	6,191,939 B1	2/2001	Burnett
6,078,885 A	6/2000	Beutnagel	6,192,253 B1	2/2001	Charlier et al.
6,078,914 A	6/2000	Redfern	6,192,340 B1	2/2001	Abecassis
6,081,750 A	6/2000	Hoffberg et al.	6,195,641 B1	2/2001	Loring et al.
6,081,774 A	6/2000	de Hita et al.	6,199,076 B1	3/2001	Logan et al.
6,081,780 A	6/2000	Lumelsky	6,205,456 B1	3/2001	Nakao
6,081,782 A	6/2000	Rabin	6,208,044 B1	3/2001	Viswanadham et al.
6,085,204 A	7/2000	Chijiwa et al.	6,208,932 B1	3/2001	Ohmura et al.
6,088,671 A	7/2000	Gould et al.	6,208,956 B1	3/2001	Motoyama
6,088,731 A	7/2000	Kiraly et al.	6,208,964 B1	3/2001	Sabourin
6,092,036 A	7/2000	Hamann et al.	6,208,967 B1	3/2001	Pauws et al.
6,092,038 A	7/2000	Kanevsky et al.	6,208,971 B1	3/2001	Bellegarda et al.
6,092,043 A	7/2000	Squires et al.	6,212,564 B1	4/2001	Harter et al.
6,094,649 A	7/2000	Bowen et al.	6,216,102 B1	4/2001	Martino et al.
6,097,391 A	8/2000	Wilcox	6,216,131 B1	4/2001	Liu et al.
6,101,468 A	8/2000	Gould et al.	6,217,183 B1	4/2001	Shipman
6,101,470 A	8/2000	Eide et al.	6,219,641 B1	4/2001	Socaciu
6,105,865 A	8/2000	Hardesty	6,222,347 B1	4/2001	Gong
6,108,627 A	8/2000	Sabourin	6,226,403 B1	5/2001	Parthasarathy
6,108,640 A	8/2000	Slotznick	6,226,533 B1	5/2001	Akahane
6,111,562 A	8/2000	Downs et al.	6,226,614 B1	5/2001	Mizuno et al.
6,111,572 A	8/2000	Blair et al.	6,226,655 B1	5/2001	Borman et al.
			6,230,322 B1	5/2001	Saib et al.
			6,232,539 B1	5/2001	Looney et al.
			6,232,966 B1	5/2001	Kurlander
			6,233,545 B1	5/2001	Datig
			6,233,547 B1	5/2001	Denber et al.
			6,233,559 B1	5/2001	Balakrishnan
			6,233,578 B1	5/2001	Machihara et al.
			6,237,025 B1	5/2001	Ludwig et al.
			6,240,303 B1	5/2001	Katzur
			6,243,681 B1	6/2001	Guji et al.

(56)

References Cited

U.S. PATENT DOCUMENTS

6,246,981 B1	6/2001	Papineni et al.	6,353,794 B1	3/2002	Davis et al.
6,248,946 B1	6/2001	Dwek	6,356,287 B1	3/2002	Ruberry et al.
6,249,606 B1	6/2001	Kiraly et al.	6,356,854 B1	3/2002	Schubert et al.
6,259,436 B1	7/2001	Moon et al.	6,356,864 B1	3/2002	Foltz et al.
6,259,826 B1	7/2001	Pollard et al.	6,356,905 B1	3/2002	Gershman et al.
6,260,011 B1	7/2001	Heckerman et al.	6,357,147 B1	3/2002	Darley et al.
6,260,013 B1	7/2001	Sejnoha	6,359,572 B1	3/2002	Vale
6,260,016 B1	7/2001	Holm et al.	6,359,970 B1	3/2002	Burgess
6,260,024 B1	7/2001	Shkedy	6,360,227 B1	3/2002	Aggarwal et al.
6,266,098 B1	7/2001	Cove et al.	6,360,237 B1	3/2002	Schulz et al.
6,266,637 B1	7/2001	Donovan et al.	6,363,347 B1	3/2002	Rozak
6,268,859 B1	7/2001	Andresen et al.	6,363,348 B1	3/2002	Besling et al.
6,269,712 B1	8/2001	Zentmyer	6,366,883 B1	4/2002	Campbell et al.
6,271,835 B1	8/2001	Hoeksma	6,366,884 B1	4/2002	Bellegarda et al.
6,272,456 B1	8/2001	De Campos	6,374,217 B1	4/2002	Bellegarda
6,272,464 B1	8/2001	Kiraz et al.	6,374,226 B1	4/2002	Hunt et al.
6,275,795 B1	8/2001	Tzirkel-Hancock	6,377,530 B1	4/2002	Burrows
6,275,824 B1	8/2001	O'Flaherty et al.	6,377,925 B1	4/2002	Greene, Jr. et al.
6,278,443 B1	8/2001	Amro et al.	6,377,928 B1	4/2002	Saxena et al.
6,278,970 B1	8/2001	Milner	6,381,593 B1	4/2002	Yano et al.
6,282,507 B1	8/2001	Horiguchi et al.	6,385,586 B1	5/2002	Dietz
6,282,511 B1	8/2001	Mayer	6,385,662 B1	5/2002	Moon et al.
6,285,785 B1	9/2001	Bellegarda et al.	6,389,114 B1	5/2002	Dowens et al.
6,285,786 B1	9/2001	Seni et al.	6,397,183 B1	5/2002	Baba et al.
6,289,085 B1	9/2001	Miyashita et al.	6,397,186 B1	5/2002	Bush et al.
6,289,124 B1	9/2001	Okamoto	6,400,806 B1	6/2002	Uppaluru
6,289,301 B1	9/2001	Higginbotham et al.	6,400,996 B1	6/2002	Hoffberg et al.
6,289,353 B1	9/2001	Hazlehurst et al.	6,401,065 B1	6/2002	Kanevsky et al.
6,292,772 B1	9/2001	Kantrowitz	6,401,085 B1	6/2002	Gershman et al.
6,292,778 B1	9/2001	Sukkar	6,405,169 B1	6/2002	Kondo et al.
6,295,390 B1	9/2001	Kobayashi et al.	6,405,238 B1	6/2002	Votipka
6,295,391 B1	9/2001	Rudd et al.	6,408,272 B1	6/2002	White et al.
6,295,541 B1	9/2001	Bodnar et al.	6,411,924 B1	6/2002	De Hita et al.
6,297,818 B1	10/2001	Ulrich et al.	6,411,932 B1	6/2002	Molnar et al.
6,298,314 B1	10/2001	Blackadar et al.	6,415,250 B1	7/2002	Van Den Akker
6,298,321 B1	10/2001	Karlov et al.	6,417,873 B1	7/2002	Fletcher et al.
6,300,947 B1	10/2001	Kanevsky	6,418,431 B1	7/2002	Mahajan et al.
6,304,844 B1	10/2001	Pan et al.	6,421,305 B1	7/2002	Gioscia et al.
6,304,846 B1	10/2001	George et al.	6,421,672 B1	7/2002	McAllister et al.
6,307,548 B1	10/2001	Flinchem et al.	6,421,707 B1	7/2002	Miller et al.
6,308,149 B1	10/2001	Gaussier et al.	6,424,944 B1	7/2002	Hikawa
6,310,610 B1	10/2001	Beaton et al.	6,430,531 B1	8/2002	Polish
6,311,152 B1	10/2001	Bai et al.	6,430,551 B1	8/2002	Thelen et al.
6,311,157 B1	10/2001	Strong	6,434,522 B1	8/2002	Tsuboka
6,311,189 B1	10/2001	deVries et al.	6,434,524 B1	8/2002	Weber
6,314,397 B1	11/2001	Lewis et al.	6,434,529 B1	8/2002	Walker et al.
6,317,237 B1	11/2001	Nakao et al.	6,434,604 B1	8/2002	Harada et al.
6,317,594 B1	11/2001	Gossman et al.	6,437,818 B1	8/2002	Ludwig et al.
6,317,707 B1	11/2001	Bangalore et al.	6,438,523 B1	8/2002	Oberteuffer et al.
6,317,831 B1	11/2001	King	6,442,518 B1	8/2002	Van Thong et al.
6,321,092 B1	11/2001	Fitch et al.	6,442,523 B1	8/2002	Siegel
6,321,179 B1	11/2001	Glance et al.	6,446,076 B1	9/2002	Burkey et al.
6,321,196 B1	11/2001	Franceschi	6,448,485 B1	9/2002	Barile
6,323,846 B1	11/2001	Westerman et al.	6,448,986 B1	9/2002	Smith
6,324,499 B1	11/2001	Lewis et al.	6,449,620 B1	9/2002	Draper et al.
6,324,502 B1	11/2001	Handel et al.	6,453,281 B1	9/2002	Walters et al.
6,324,512 B1	11/2001	Junqua et al.	6,453,292 B2	9/2002	Ramaswamy et al.
6,324,514 B2	11/2001	Matulich et al.	6,453,312 B1	9/2002	Goiffon et al.
6,330,538 B1	12/2001	Breen	6,453,315 B1	9/2002	Weissman et al.
6,330,539 B1	12/2001	Takayama et al.	6,456,616 B1	9/2002	Rantanen
6,331,867 B1	12/2001	Eberhard et al.	6,456,972 B1	9/2002	Gladstein et al.
6,332,175 B1	12/2001	Birrell et al.	6,460,015 B1	10/2002	Hetherington et al.
6,334,103 B1	12/2001	Surace et al.	6,460,029 B1	10/2002	Fries et al.
6,335,722 B1	1/2002	Tani et al.	6,462,778 B1	10/2002	Abram et al.
6,336,365 B1	1/2002	Blackadar et al.	6,463,128 B1	10/2002	Elwin
6,336,727 B1	1/2002	Kim	6,463,413 B1	10/2002	Applebaum et al.
6,340,937 B1	1/2002	Stepita-Klauco	6,466,654 B1	10/2002	Cooper et al.
6,341,316 B1	1/2002	Kloba et al.	6,467,924 B2	10/2002	Shipman
6,343,267 B1	1/2002	Kuhn et al.	6,469,712 B1	10/2002	Hilpert, Jr. et al.
6,345,240 B1	2/2002	Havens	6,469,722 B1	10/2002	Kinoe et al.
6,345,250 B1	2/2002	Martin	6,469,732 B1	10/2002	Chang et al.
6,347,296 B1	2/2002	Friedland	6,470,347 B1	10/2002	Gillam
6,351,522 B1	2/2002	Vitikainen	6,473,630 B1	10/2002	Baranowski et al.
6,351,762 B1	2/2002	Ludwig et al.	6,473,754 B1	10/2002	Matsubayashi et al.
6,353,442 B1	3/2002	Masui	6,477,488 B1	11/2002	Bellegarda
			6,477,494 B2	11/2002	Hyde-Thomson et al.
			6,487,533 B2	11/2002	Hyde-Thomson et al.
			6,487,534 B1	11/2002	Thelen et al.
			6,487,663 B1	11/2002	Jaisimha et al.

(56)

References Cited

U.S. PATENT DOCUMENTS

6,489,951 B1	12/2002	Wong et al.	6,603,837 B1	8/2003	Kesanupalli et al.
6,490,547 B1	12/2002	Atkin et al.	6,604,059 B2	8/2003	Strubbe et al.
6,490,560 B1	12/2002	Ramaswamy et al.	6,606,101 B1	8/2003	Malamud et al.
6,493,006 B1	12/2002	Gourdol et al.	6,606,388 B1	8/2003	Townsend et al.
6,493,428 B1	12/2002	Hillier	6,606,632 B1	8/2003	Saulpaugh et al.
6,493,652 B1	12/2002	Ohlenbusch et al.	6,611,789 B1	8/2003	Darley
6,493,667 B1	12/2002	De Souza et al.	6,615,172 B1	9/2003	Bennett et al.
6,499,013 B1	12/2002	Weber	6,615,175 B1	9/2003	Gazdzinski
6,499,014 B1	12/2002	Chihara	6,615,176 B2	9/2003	Lewis et al.
6,499,016 B1	12/2002	Anderson et al.	6,615,220 B1	9/2003	Austin et al.
6,501,937 B1	12/2002	Ho et al.	6,621,768 B1	9/2003	Keller et al.
6,502,022 B1	12/2002	Chastain et al.	6,621,892 B1	9/2003	Banister et al.
6,502,194 B1	12/2002	Berman et al.	6,622,121 B1	9/2003	Crepuy et al.
6,504,990 B1	1/2003	Abecassis	6,622,136 B2	9/2003	Russell
6,505,155 B1	1/2003	Vanbuskirk et al.	6,622,148 B1	9/2003	Noble et al.
6,505,158 B1	1/2003	Conkie	6,623,529 B1	9/2003	Lakritz
6,505,175 B1	1/2003	Silverman et al.	6,625,583 B1	9/2003	Silverman et al.
6,505,183 B1	1/2003	Loofbourrow et al.	6,628,808 B1	9/2003	Bach et al.
6,507,829 B1	1/2003	Richards et al.	6,631,186 B1	10/2003	Adams et al.
6,510,406 B1	1/2003	Marchisio	6,631,346 B1	10/2003	Karaorman et al.
6,510,412 B1	1/2003	Sasai et al.	6,633,741 B1	10/2003	Posa et al.
6,510,417 B1	1/2003	Woods et al.	6,633,846 B1	10/2003	Bennett et al.
6,513,006 B2	1/2003	Howard et al.	6,633,932 B1	10/2003	Bork et al.
6,513,008 B2	1/2003	Pearson et al.	6,642,940 B1	11/2003	Dakss et al.
6,513,063 B1	1/2003	Julia et al.	6,643,401 B1	11/2003	Kashioka et al.
6,519,565 B1	2/2003	Clements et al.	6,643,824 B1	11/2003	Bates et al.
6,519,566 B1	2/2003	Boyer et al.	6,647,260 B2	11/2003	Dusse et al.
6,523,026 B1	2/2003	Gillis	6,650,735 B2	11/2003	Burton et al.
6,523,061 B1	2/2003	Halverson et al.	6,651,042 B1	11/2003	Field et al.
6,523,172 B1	2/2003	Martinez-Guerra et al.	6,651,218 B1	11/2003	Adler et al.
6,526,351 B2	2/2003	Whitham	6,654,740 B2	11/2003	Tokuda et al.
6,526,382 B1	2/2003	Yuschik	6,658,389 B1	12/2003	Alpdemir
6,526,395 B1	2/2003	Morris	6,658,408 B2	12/2003	Yano et al.
6,529,592 B1	3/2003	Khan	6,658,577 B2	12/2003	Huppi et al.
6,529,608 B2	3/2003	Gersabeck et al.	6,661,438 B1	12/2003	Shiraishi et al.
6,532,444 B1	3/2003	Weber	6,662,023 B1	12/2003	Helle
6,532,446 B1	3/2003	King	6,665,639 B2	12/2003	Mozer et al.
6,535,610 B1	3/2003	Stewart	6,665,640 B1	12/2003	Bennett et al.
6,535,852 B2	3/2003	Eide	6,665,641 B1	12/2003	Coorman et al.
6,535,983 B1	3/2003	McCormack et al.	6,671,672 B1	12/2003	Heck
6,536,139 B2	3/2003	Darley et al.	6,671,683 B2	12/2003	Kanno
6,538,665 B2	3/2003	Crow et al.	6,671,856 B1	12/2003	Gillam
6,542,171 B1	4/2003	Satou et al.	6,675,169 B1	1/2004	Bennett et al.
6,542,584 B1	4/2003	Sherwood et al.	6,675,233 B1	1/2004	Du et al.
6,542,868 B1	4/2003	Badt et al.	6,677,932 B1	1/2004	Westerman
6,546,262 B1	4/2003	Freadman	6,680,675 B1	1/2004	Suzuki
6,546,367 B2	4/2003	Otsuka	6,684,187 B1	1/2004	Conkie
6,546,388 B1	4/2003	Edlund et al.	6,684,376 B1	1/2004	Kerzman et al.
6,549,497 B2	4/2003	Miyamoto et al.	6,690,387 B2	2/2004	Zimmerman et al.
6,553,343 B1	4/2003	Kagoshima et al.	6,690,800 B2	2/2004	Resnick
6,553,344 B2	4/2003	Bellegarda et al.	6,690,828 B2	2/2004	Meyers
6,556,971 B1	4/2003	Rigsby et al.	6,690,956 B2	2/2004	Chua et al.
6,556,983 B1	4/2003	Altschuler et al.	6,691,064 B2	2/2004	Vroman
6,560,903 B1	5/2003	Darley	6,691,090 B1	2/2004	Laurila et al.
6,563,769 B1	5/2003	Van Der Meulen	6,691,111 B2	2/2004	Lazaridis et al.
6,564,186 B1	5/2003	Kiraly et al.	6,691,151 B1	2/2004	Cheyen et al.
6,567,549 B1	5/2003	Marianetti et al.	6,694,295 B2	2/2004	Lindholm et al.
6,570,557 B1	5/2003	Westerman et al.	6,694,297 B2	2/2004	Sato
6,570,596 B2	5/2003	Frederiksen	6,697,780 B1	2/2004	Beutnagel et al.
6,582,342 B2	6/2003	Kaufman	6,697,824 B1	2/2004	Bowman-Amuah
6,583,806 B2	6/2003	Ludwig et al.	6,701,294 B1	3/2004	Ball et al.
6,584,464 B1	6/2003	Warthen	6,701,305 B1	3/2004	Holt et al.
6,587,403 B1	7/2003	Keller et al.	6,701,318 B2	3/2004	Fox et al.
6,587,404 B1	7/2003	Keller et al.	6,704,015 B1	3/2004	Bovarnick et al.
6,590,303 B1	7/2003	Austin et al.	6,704,034 B1	3/2004	Rodriguez et al.
6,591,379 B1	7/2003	LeVine et al.	6,704,698 B1	3/2004	Paulsen, Jr. et al.
6,594,673 B1	7/2003	Smith et al.	6,704,710 B2	3/2004	Strong
6,594,688 B2	7/2003	Ludwig et al.	6,708,153 B2	3/2004	Brittan et al.
6,597,345 B2	7/2003	Hirshberg	6,711,585 B1	3/2004	Copperman et al.
6,598,021 B1	7/2003	Shambaugh et al.	6,714,221 B1	3/2004	Christie et al.
6,598,022 B2	7/2003	Yuschik	6,716,139 B1	4/2004	Hosseinzadeh-Dolkhani et al.
6,598,039 B1	7/2003	Livowsky	6,718,324 B2	4/2004	Edlund et al.
6,598,054 B2	7/2003	Schuetze et al.	6,718,331 B2	4/2004	Davis et al.
6,601,026 B2	7/2003	Appelt et al.	6,720,980 B1	4/2004	Lui et al.
6,601,234 B1	7/2003	Bowman-Amuah	6,721,728 B2	4/2004	McGreevy
			6,721,734 B1	4/2004	Subasic et al.
			6,724,370 B2	4/2004	Dutta et al.
			6,725,197 B1	4/2004	Wuppermann et al.
			6,728,675 B1	4/2004	Maddalozzo, Jr. et al.

(56)

References Cited

U.S. PATENT DOCUMENTS

6,728,681	B2	4/2004	Whitham	6,839,464	B2	1/2005	Hawkins et al.
6,728,729	B1	4/2004	Jawa et al.	6,839,667	B2	1/2005	Reich
6,731,312	B2	5/2004	Robbin	6,839,669	B1	1/2005	Gould et al.
6,732,142	B1	5/2004	Bates et al.	6,839,670	B1	1/2005	Stammmer et al.
6,735,562	B1	5/2004	Zhang et al.	6,839,742	B1	1/2005	Dyer et al.
6,735,632	B1	5/2004	Kiraly et al.	6,842,767	B1	1/2005	Partovi et al.
6,738,738	B2	5/2004	Henton	6,847,966	B1	1/2005	Sommer et al.
6,738,742	B2	5/2004	Badt et al.	6,847,979	B2	1/2005	Allemang et al.
6,741,264	B1	5/2004	Lesser	6,850,775	B1	2/2005	Berg
6,742,021	B1	5/2004	Halverson et al.	6,850,887	B2	2/2005	Epstein et al.
6,751,592	B1	6/2004	Shiga	6,851,115	B1	2/2005	Cheyet et al.
6,751,595	B2	6/2004	Busayapongchai et al.	6,856,259	B1	2/2005	Sharp
6,751,621	B1	6/2004	Calistri-Yeh et al.	6,857,800	B2	2/2005	Zhang et al.
6,754,504	B1	6/2004	Reed	6,859,931	B1	2/2005	Cheyet et al.
6,757,362	B1	6/2004	Cooper et al.	6,862,568	B2	3/2005	Case
6,757,365	B1	6/2004	Bogard	6,862,710	B1	3/2005	Marchisio
6,757,646	B2	6/2004	Marchisio	6,862,713	B1	3/2005	Kraft et al.
6,757,653	B2	6/2004	Buth et al.	6,865,533	B2	3/2005	Addison et al.
6,757,718	B1	6/2004	Halverson et al.	6,868,045	B1	3/2005	Schroder
6,760,412	B1	7/2004	Loucks	6,868,385	B1	3/2005	Gerson
6,760,700	B2	7/2004	Lewis et al.	6,870,529	B1	3/2005	Davis
6,760,754	B1	7/2004	Isaacs et al.	6,871,346	B1	3/2005	Kumbalimutt et al.
6,762,741	B2	7/2004	Weindorf	6,873,953	B1	3/2005	Lennig
6,762,777	B2	7/2004	Carroll	6,873,986	B2	3/2005	McConnell et al.
6,763,089	B2	7/2004	Feigenbaum	6,876,947	B1	4/2005	Darley et al.
6,766,294	B2	7/2004	MacGinite et al.	6,877,003	B2	4/2005	Ho et al.
6,766,295	B1	7/2004	Murveit et al.	6,879,957	B1	4/2005	Pechter et al.
6,766,320	B1	7/2004	Wang et al.	6,882,335	B2	4/2005	Saarinen
6,766,324	B2	7/2004	Carlson et al.	6,882,337	B2	4/2005	Shetter
6,768,979	B1	7/2004	Menendez-Pidal et al.	6,882,747	B2	4/2005	Thawonmas et al.
6,771,982	B1	8/2004	Toupin	6,882,955	B1	4/2005	Ohlenbusch et al.
6,772,123	B2	8/2004	Cooklev et al.	6,882,971	B2	4/2005	Craner
6,772,195	B1	8/2004	Hatlelid et al.	6,885,734	B1	4/2005	Eberle et al.
6,772,394	B1	8/2004	Kamada	6,889,361	B1	5/2005	Bates et al.
6,775,358	B1	8/2004	Breitenbach et al.	6,895,084	B1	5/2005	Saylor et al.
6,778,951	B1	8/2004	Contractor	6,895,257	B2	5/2005	Boman et al.
6,778,952	B2	8/2004	Bellegarda	6,895,380	B2	5/2005	Sepe, Jr.
6,778,962	B1	8/2004	Kasai et al.	6,895,558	B1	5/2005	Loveland
6,778,970	B2	8/2004	Au	6,898,550	B1	5/2005	Blackadar et al.
6,778,979	B2	8/2004	Grefenstette et al.	6,901,364	B2	5/2005	Nguyen et al.
6,782,510	B1	8/2004	Gross et al.	6,901,399	B1	5/2005	Corston et al.
6,784,901	B1	8/2004	Harvey et al.	6,904,405	B2	6/2005	Suominen
6,785,869	B1	8/2004	Berstis	6,907,112	B1	6/2005	Guedalia et al.
6,789,094	B2	9/2004	Rudoff et al.	6,907,140	B2	6/2005	Matsugu et al.
6,789,231	B1	9/2004	Reynar et al.	6,910,004	B2	6/2005	Tarbouriech et al.
6,790,704	B2	9/2004	Doyle et al.	6,910,007	B2	6/2005	Stylianou et al.
6,792,082	B1	9/2004	Levine	6,910,012	B2	6/2005	Hartley et al.
6,792,083	B2	9/2004	Dams et al.	6,910,186	B2	6/2005	Kim
6,792,086	B1	9/2004	Saylor et al.	6,911,971	B2	6/2005	Suzuki et al.
6,792,407	B2	9/2004	Kibre et al.	6,912,407	B1	6/2005	Clarke et al.
6,794,566	B2	9/2004	Pachet	6,912,498	B2	6/2005	Stevens et al.
6,795,059	B2	9/2004	Endo	6,912,499	B1	6/2005	Sabourin et al.
6,799,162	B1	9/2004	Goronzy et al.	6,915,138	B2	7/2005	Kraft
6,799,226	B1	9/2004	Robbin et al.	6,915,246	B2	7/2005	Gusler et al.
6,801,604	B2	10/2004	Maes et al.	6,915,294	B1	7/2005	Singh et al.
6,801,964	B1	10/2004	Mandavi	6,917,373	B2	7/2005	Vong et al.
6,803,905	B1	10/2004	Capps et al.	6,918,677	B2	7/2005	Shipman
6,804,649	B2	10/2004	Miranda	6,924,828	B1	8/2005	Hirsch
6,804,677	B2	10/2004	Shadmon et al.	6,925,438	B2	8/2005	Mohamed et al.
6,807,536	B2	10/2004	Achlioptas et al.	6,928,149	B1	8/2005	Panjwani et al.
6,807,574	B1	10/2004	Partovi et al.	6,928,614	B1	8/2005	Everhart
6,809,724	B1	10/2004	Shiraishi et al.	6,931,255	B2	8/2005	Mekuria
6,810,379	B1	10/2004	Vermeulen et al.	6,931,384	B1	8/2005	Horvitz et al.
6,813,218	B1	11/2004	Antonelli et al.	6,932,708	B2	8/2005	Yamashita et al.
6,813,491	B1	11/2004	McKinney	6,933,928	B1	8/2005	Lilienthal et al.
6,813,607	B1	11/2004	Faruquie et al.	6,934,394	B1	8/2005	Anderson
6,816,578	B1	11/2004	Kredo et al.	6,934,684	B2	8/2005	Alpdemir et al.
6,820,055	B2	11/2004	Saindon et al.	6,934,756	B2	8/2005	Maes
6,829,018	B2	12/2004	Lin et al.	6,934,812	B1	8/2005	Robbin et al.
6,829,603	B1	12/2004	Chai et al.	6,937,975	B1	8/2005	Elworthy
6,832,194	B1	12/2004	Mozer et al.	6,937,986	B2	8/2005	Denenberg et al.
6,832,381	B1	12/2004	Mathur et al.	6,944,593	B2	9/2005	Kuzunuki et al.
6,836,537	B1	12/2004	Zirngibl et al.	6,944,846	B2	9/2005	Ryzhov
6,836,651	B2	12/2004	Segal et al.	6,948,094	B2	9/2005	Schultz et al.
6,836,760	B1	12/2004	Bellegarda et al.	6,950,087	B2	9/2005	Knox et al.
				6,950,502	B1	9/2005	Jenkins
				6,952,799	B2	10/2005	Edwards et al.
				6,954,755	B2	10/2005	Reisman
				6,954,899	B1	10/2005	Anderson

(56)

References Cited

U.S. PATENT DOCUMENTS

6,956,845 B2	10/2005	Baker et al.	7,046,850 B2	5/2006	Braspenning et al.
6,957,076 B2	10/2005	Hunzinger	7,047,193 B1	5/2006	Bellegarda
6,957,183 B2	10/2005	Malayath et al.	7,050,550 B2	5/2006	Steinbiss et al.
6,960,734 B1	11/2005	Park	7,050,796 B2	5/2006	Humphrey et al.
6,961,699 B1	11/2005	Kahn et al.	7,050,976 B1	5/2006	Packingham
6,961,912 B2	11/2005	Aoki et al.	7,050,977 B1	5/2006	Bennett
6,963,759 B1	11/2005	Gerson	7,051,096 B1	5/2006	Krawiec et al.
6,963,841 B2	11/2005	Handal et al.	7,054,419 B2	5/2006	Culliss
6,964,023 B2	11/2005	Maes et al.	7,054,888 B2	5/2006	LaChapelle et al.
6,965,376 B2	11/2005	Tani et al.	7,057,607 B2	6/2006	Mayoraz et al.
6,965,863 B1	11/2005	Zuberec et al.	7,058,569 B2	6/2006	Coorman et al.
6,968,311 B2	11/2005	Knockeart et al.	7,058,888 B1	6/2006	Gjerstad et al.
6,970,820 B2	11/2005	Junqua et al.	7,058,889 B2	6/2006	Trovato et al.
6,970,881 B1	11/2005	Mohan et al.	7,062,223 B2	6/2006	Gerber et al.
6,970,915 B1	11/2005	Partovi et al.	7,062,225 B2	6/2006	White
6,970,935 B1	11/2005	Maes	7,062,428 B2	6/2006	Hogenhout et al.
6,975,986 B2	12/2005	Hartley et al.	7,062,438 B2	6/2006	Kobayashi et al.
6,976,090 B2	12/2005	Ben-Shaul et al.	7,065,185 B1	6/2006	Koch
6,978,127 B1	12/2005	Bulthuis et al.	7,065,485 B1	6/2006	Chong-White et al.
6,978,239 B2	12/2005	Chu et al.	7,069,213 B2	6/2006	Thompson
6,980,949 B2	12/2005	Ford	7,069,220 B2	6/2006	Coffman et al.
6,980,953 B1	12/2005	Kanevsky et al.	7,069,560 B1	6/2006	Cheyser et al.
6,980,955 B2	12/2005	Okutani et al.	7,072,686 B1	7/2006	Schrager
6,983,251 B1	1/2006	Umemoto et al.	7,072,941 B2	7/2006	Griffin et al.
6,985,858 B2	1/2006	Frey et al.	7,076,527 B2	7/2006	Bellegarda et al.
6,985,865 B1	1/2006	Packingham et al.	7,079,713 B2	7/2006	Simmons
6,985,958 B2	1/2006	Zwieginzew et al.	7,082,322 B2	7/2006	Harano
6,988,063 B2	1/2006	Tokuda et al.	7,084,758 B1	8/2006	Cole
6,988,071 B1	1/2006	Gazdzinski	7,084,856 B2	8/2006	Huppi
6,990,450 B2	1/2006	Case et al.	7,085,716 B1	8/2006	Even et al.
6,996,520 B2	2/2006	Levin	7,085,723 B2	8/2006	Ross et al.
6,996,531 B2	2/2006	Korall et al.	7,085,960 B2	8/2006	Bouat et al.
6,996,575 B2	2/2006	Cox et al.	7,088,345 B2	8/2006	Robinson et al.
6,999,066 B2	2/2006	Litwiller	7,088,853 B2	8/2006	Hiroe et al.
6,999,914 B1	2/2006	Boerner et al.	7,089,292 B1	8/2006	Roderick et al.
6,999,925 B2	2/2006	Fischer et al.	7,092,370 B2	8/2006	Jiang et al.
6,999,927 B2	2/2006	Mozer et al.	7,092,887 B2	8/2006	Mozer et al.
7,000,189 B2	2/2006	Dutta et al.	7,092,928 B1	8/2006	Elad et al.
7,002,556 B2	2/2006	Tsukada et al.	7,092,950 B2	8/2006	Wong et al.
7,003,099 B1	2/2006	Zhang et al.	7,093,693 B1	8/2006	Gazdzinski
7,003,457 B2	2/2006	Halonon et al.	7,095,733 B1	8/2006	Yarlagadda et al.
7,003,463 B1	2/2006	Maes et al.	7,096,183 B2	8/2006	Junqua
7,003,522 B1	2/2006	Reynar et al.	7,100,117 B1	8/2006	Chwa et al.
7,006,969 B2	2/2006	Atal	7,103,548 B2	9/2006	Squibbs et al.
7,006,973 B1	2/2006	Genly et al.	7,107,204 B1	9/2006	Liu et al.
7,007,026 B2	2/2006	Wilkinson et al.	7,110,938 B1	9/2006	Cheng et al.
7,007,239 B1	2/2006	Hawkins et al.	7,110,998 B1	9/2006	Bhandari et al.
7,010,581 B2	3/2006	Brown et al.	7,111,248 B2	9/2006	Mulvey et al.
7,013,289 B2	3/2006	Horn et al.	7,111,774 B2	9/2006	Song
7,013,308 B1	3/2006	Tunstall-Pedoe	7,112,827 B2	9/2006	Hayakawa et al.
7,013,429 B2	3/2006	Fujimoto et al.	7,113,803 B2	9/2006	Dehlin
7,015,894 B2	3/2006	Morohoshi	7,113,943 B2	9/2006	Bradford et al.
7,020,685 B1	3/2006	Chen et al.	7,115,035 B2	10/2006	Tanaka
7,023,979 B1	4/2006	Wu et al.	7,117,231 B2	10/2006	Fischer et al.
7,024,363 B1	4/2006	Comerford et al.	7,120,586 B2	10/2006	Loui et al.
7,024,364 B2	4/2006	Guerra et al.	7,120,865 B1	10/2006	Horvitz et al.
7,024,366 B1	4/2006	Deyoe et al.	7,123,696 B2	10/2006	Lowe
7,024,460 B2	4/2006	Koopmas et al.	7,124,081 B1	10/2006	Bellegarda
7,027,568 B1	4/2006	Simpson et al.	7,124,082 B2	10/2006	Freedman
7,027,974 B1	4/2006	Busch et al.	7,124,164 B1	10/2006	Chemtob
7,027,990 B2	4/2006	Sussman	7,124,300 B1	10/2006	Lemke
7,028,252 B1	4/2006	Baru et al.	7,127,046 B1	10/2006	Smith et al.
7,030,861 B1	4/2006	Westerman et al.	7,127,394 B2	10/2006	Strong et al.
7,031,530 B2	4/2006	Driggs et al.	7,127,396 B2	10/2006	Chu et al.
7,031,909 B2	4/2006	Mao et al.	7,127,403 B1	10/2006	Saylor et al.
7,035,794 B2	4/2006	Sirivara	7,129,932 B1	10/2006	Klarlund et al.
7,035,801 B2	4/2006	Jimenez-Feltstrom	7,133,900 B1	11/2006	Szeto
7,035,807 B1	4/2006	Brittain et al.	7,136,710 B1	11/2006	Hoffberg et al.
7,036,128 B1	4/2006	Julia et al.	7,136,818 B1	11/2006	Cosatto et al.
7,036,681 B2	5/2006	Suda et al.	7,137,126 B1	11/2006	Coffman et al.
7,038,659 B2	5/2006	Rajkowski	7,139,697 B2	11/2006	Häkkinen et al.
7,039,588 B2	5/2006	Okutani et al.	7,139,714 B2	11/2006	Bennett et al.
7,043,420 B2	5/2006	Ratnaparkhi	7,139,722 B2	11/2006	Perrella et al.
7,043,422 B2	5/2006	Gao et al.	7,143,028 B2	11/2006	Hillis et al.
7,046,230 B2	5/2006	Zadesky et al.	7,143,037 B1	11/2006	Chestnut
			7,143,038 B2	11/2006	Katae
			7,143,040 B2	11/2006	Durston et al.
			7,146,319 B2	12/2006	Hunt
			7,146,437 B2	12/2006	Robbin et al.

(56)

References Cited

U.S. PATENT DOCUMENTS

7,149,319 B2	12/2006	Roeck	7,260,567 B2	8/2007	Parikh et al.
7,149,695 B1	12/2006	Bellegarda	7,263,373 B2	8/2007	Mattisson
7,149,964 B1	12/2006	Cottrille et al.	7,266,189 B1	9/2007	Day
7,152,070 B1	12/2006	Musick et al.	7,266,495 B1	9/2007	Beaufays et al.
7,152,093 B2	12/2006	Ludwig et al.	7,266,496 B2	9/2007	Wang et al.
7,154,526 B2	12/2006	Foote et al.	7,266,499 B2	9/2007	Surace et al.
7,155,668 B2	12/2006	Holland et al.	7,269,544 B2	9/2007	Simske
7,158,647 B2	1/2007	Azima et al.	7,269,556 B2	9/2007	Kiss et al.
7,159,174 B2	1/2007	Johnson et al.	7,272,224 B1	9/2007	Normile et al.
7,162,412 B2	1/2007	Yamada et al.	7,275,063 B2	9/2007	Horn
7,162,482 B1	1/2007	Dunning	7,277,088 B2	10/2007	Robinson et al.
7,165,073 B2	1/2007	Vandersluis	7,277,854 B2	10/2007	Bennett et al.
7,166,791 B2	1/2007	Robbin et al.	7,277,855 B1	10/2007	Acker et al.
7,171,350 B2	1/2007	Lin et al.	7,280,958 B2	10/2007	Pavlov et al.
7,171,360 B2	1/2007	Huang et al.	7,283,072 B1	10/2007	Plachta et al.
7,174,042 B1	2/2007	Simmons et al.	7,283,992 B2	10/2007	Liu et al.
7,174,295 B1	2/2007	Kivimaki	7,289,102 B2	10/2007	Hinckley et al.
7,174,297 B2	2/2007	Guerra et al.	7,290,039 B1	10/2007	Lisitsa et al.
7,174,298 B2	2/2007	Sharma	7,292,579 B2	11/2007	Morris
7,177,794 B2	2/2007	Mani et al.	7,292,979 B2	11/2007	Karas et al.
7,177,798 B2	2/2007	Hsu et al.	7,292,980 B1	11/2007	August et al.
7,177,817 B1	2/2007	Khosla et al.	7,296,019 B1	11/2007	Chandrasekar et al.
7,181,386 B2	2/2007	Mohri et al.	7,296,230 B2	11/2007	Fukatsu et al.
7,181,388 B2	2/2007	Tian	7,299,033 B2	11/2007	Kjellberg et al.
7,184,064 B2	2/2007	Zimmerman et al.	7,302,392 B1	11/2007	Thenthiruperai et al.
7,185,276 B2	2/2007	Keswa	7,302,394 B1	11/2007	Baray et al.
7,188,085 B2	3/2007	Pelletier	7,302,686 B2	11/2007	Togawa
7,190,351 B1	3/2007	Goren	7,308,404 B2	12/2007	Venkataraman et al.
7,190,794 B2	3/2007	Hinde	7,308,408 B1	12/2007	Stifelman et al.
7,191,118 B2	3/2007	Bellegarda	7,310,329 B2	12/2007	Vieri et al.
7,191,131 B1	3/2007	Nagao	7,310,600 B1	12/2007	Garner et al.
7,193,615 B2	3/2007	Kim et al.	7,310,605 B2	12/2007	Janakiraman et al.
7,194,186 B1	3/2007	Strub et al.	7,313,514 B2	12/2007	Rose et al.
7,194,413 B2	3/2007	Mahoney et al.	7,313,523 B1	12/2007	Bellegarda et al.
7,194,471 B1	3/2007	Nagatsuka et al.	7,315,809 B2	1/2008	Xun
7,194,611 B2	3/2007	Bear et al.	7,315,818 B2	1/2008	Stevens et al.
7,194,699 B2	3/2007	Thomson et al.	7,318,020 B1	1/2008	Kim
7,197,120 B2	3/2007	Luehrig et al.	7,319,957 B2	1/2008	Robinson et al.
7,197,460 B1	3/2007	Gupta et al.	7,321,783 B2	1/2008	Kim, II
7,200,550 B2	4/2007	Menezes et al.	7,322,023 B2	1/2008	Shulman et al.
7,200,558 B2	4/2007	Kato et al.	7,324,833 B2	1/2008	White et al.
7,200,559 B2	4/2007	Wang	7,324,947 B2	1/2008	Jordan et al.
7,203,297 B2	4/2007	Vitikainen et al.	7,328,155 B2	2/2008	Endo et al.
7,203,646 B2	4/2007	Bennett	7,328,250 B2	2/2008	Wang et al.
7,206,809 B2	4/2007	Ludwig et al.	7,333,998 B2	2/2008	Heckerman et al.
7,212,827 B1	5/2007	Veschi	7,345,670 B2	3/2008	Armstrong
7,216,008 B2	5/2007	Sakata	7,345,671 B2	3/2008	Robbin et al.
7,216,066 B2	5/2007	Di et al.	7,349,953 B2	3/2008	Lisitsa et al.
7,216,073 B2	5/2007	Lavi et al.	7,353,139 B1	4/2008	Burrell et al.
7,216,079 B1	5/2007	Barnard et al.	7,359,493 B1	4/2008	Wang et al.
7,216,080 B2	5/2007	Tsiao et al.	7,359,671 B2	4/2008	Richenstein et al.
7,218,920 B2	5/2007	Hyon	7,359,851 B2	4/2008	Tong et al.
7,218,943 B2	5/2007	Klassen et al.	7,360,158 B1	4/2008	Beeman
7,219,063 B2	5/2007	Schalk et al.	7,362,738 B2	4/2008	Taube et al.
7,219,123 B1	5/2007	Fiechter et al.	7,363,227 B2	4/2008	Mapes-Riordan et al.
7,225,125 B2	5/2007	Bennett et al.	7,363,586 B1	4/2008	Briggs et al.
7,228,278 B2	6/2007	Nguyen et al.	7,365,260 B2	4/2008	Kawashima
7,231,343 B1	6/2007	Treadgold et al.	7,366,461 B1	4/2008	Brown
7,231,597 B1	6/2007	Braun et al.	7,369,984 B2	5/2008	Fairweather
7,233,790 B2	6/2007	Kjellberg et al.	7,373,291 B2	5/2008	Garst
7,233,904 B2	6/2007	Luisi	7,373,612 B2	5/2008	Risch et al.
7,234,026 B2	6/2007	Robbin et al.	7,376,556 B2	5/2008	Bennett
7,236,932 B1	6/2007	Grajski	7,376,632 B1	5/2008	Sadek et al.
7,240,002 B2	7/2007	Minamino et al.	7,376,645 B2	5/2008	Bernard
7,243,130 B2	7/2007	Horvitz et al.	7,378,963 B1	5/2008	Begault et al.
7,243,305 B2	7/2007	Schabes et al.	7,379,874 B2	5/2008	Schmid et al.
7,246,118 B2	7/2007	Chastain et al.	7,380,203 B2	5/2008	Keely et al.
7,246,151 B2	7/2007	Isaacs et al.	7,383,170 B2	6/2008	Mills et al.
7,248,900 B2	7/2007	Deeds et al.	7,386,110 B2	6/2008	Petrunka et al.
7,251,313 B1	7/2007	Miller et al.	7,386,438 B1	6/2008	Franz et al.
7,251,454 B2	7/2007	White	7,386,449 B2	6/2008	Sun et al.
7,254,773 B2	8/2007	Bates et al.	7,386,799 B1	6/2008	Clanton et al.
7,257,537 B2	8/2007	Ross et al.	7,389,224 B1	6/2008	Elworthy
7,259,752 B1	8/2007	Simmons	7,389,225 B1	6/2008	Jensen et al.
7,260,529 B1	8/2007	Lengen	7,392,185 B2	6/2008	Bennett
			7,394,947 B2	7/2008	Li et al.
			7,398,209 B2	7/2008	Kennewick et al.
			7,401,300 B2	7/2008	Nurmi
			7,403,938 B2	7/2008	Harrison et al.

(56)

References Cited

U.S. PATENT DOCUMENTS

7,403,941 B2	7/2008	Bedworth et al.	7,539,656 B2	5/2009	Fratkina et al.
7,404,143 B2	7/2008	Freelander et al.	7,541,940 B2	6/2009	Upton
7,409,337 B1	8/2008	Potter et al.	7,542,967 B2	6/2009	Hurst-Hiller et al.
7,409,347 B1	8/2008	Bellegarda	7,542,971 B2	6/2009	Thione et al.
7,412,389 B2	8/2008	Yang	7,543,232 B2	6/2009	Easton, Jr. et al.
7,412,470 B2	8/2008	Masuno et al.	7,546,382 B2	6/2009	Healey et al.
7,415,100 B2	8/2008	Cooper et al.	7,546,529 B2	6/2009	Reynar et al.
7,415,469 B2	8/2008	Singh et al.	7,548,895 B2	6/2009	Pulsipher
7,418,382 B1	8/2008	Maes	7,552,045 B2	6/2009	Barliga et al.
7,418,389 B2	8/2008	Chu et al.	7,552,055 B2	6/2009	Lecoeuche
7,418,392 B1	8/2008	Mozer et al.	7,555,431 B2	6/2009	Bennett
7,426,467 B2	9/2008	Nashida et al.	7,555,496 B1	6/2009	Lantrip et al.
7,426,468 B2	9/2008	Coifman et al.	7,558,381 B1	7/2009	Ali et al.
7,427,024 B1	9/2008	Gazdzinski et al.	7,558,730 B2	7/2009	Davis et al.
7,428,541 B2	9/2008	Houle	7,559,026 B2	7/2009	Girish et al.
7,430,508 B2	9/2008	Williamson et al.	7,561,069 B2	7/2009	Horstemeyer
7,433,869 B2	10/2008	Gollapudi	7,562,007 B2	7/2009	Hwang
7,433,921 B2	10/2008	Ludwig et al.	7,562,032 B2	7/2009	Abbosh et al.
7,436,947 B2	10/2008	Wadler et al.	7,565,104 B1	7/2009	Brown et al.
7,441,184 B2	10/2008	Frerebeau et al.	7,565,380 B1	7/2009	Venkatachary
7,443,316 B2	10/2008	Lim	7,568,151 B2	7/2009	Barger et al.
7,444,589 B2	10/2008	Zellner	7,571,092 B1	8/2009	Nieh
7,447,360 B2	11/2008	Li et al.	7,571,106 B2	8/2009	Cao et al.
7,447,624 B2	11/2008	Fuhrmann et al.	7,577,522 B2	8/2009	Rosenberg
7,447,635 B1	11/2008	Konopka et al.	7,580,551 B1	8/2009	Srihari et al.
7,447,637 B1	11/2008	Grant et al.	7,580,576 B2	8/2009	Wang et al.
7,451,081 B1	11/2008	Gajic et al.	7,580,839 B2	8/2009	Tamura et al.
7,454,351 B2	11/2008	Jeschke et al.	7,584,093 B2	9/2009	Potter et al.
7,460,652 B2	12/2008	Chang	7,584,278 B2	9/2009	Rajarajan et al.
7,461,043 B2	12/2008	Hess	7,584,429 B2	9/2009	Fabritius
7,467,087 B1	12/2008	Gillick et al.	7,593,868 B2	9/2009	Margiloff et al.
7,467,164 B2	12/2008	Marsh	7,596,269 B2	9/2009	King et al.
7,472,061 B1	12/2008	Alewine et al.	7,596,499 B2	9/2009	Anguera et al.
7,472,065 B2	12/2008	Aaron et al.	7,596,606 B2	9/2009	Codignotto
7,475,010 B2	1/2009	Chao	7,596,765 B2	9/2009	Almas
7,475,015 B2	1/2009	Epstein et al.	7,599,918 B2	10/2009	Shen et al.
7,475,063 B2	1/2009	Datta et al.	7,603,349 B1	10/2009	Kraft et al.
7,477,238 B2	1/2009	Fux et al.	7,603,381 B2	10/2009	Burke et al.
7,477,240 B2	1/2009	Yanagisawa	7,606,444 B1	10/2009	Erol et al.
7,478,037 B2	1/2009	Strong	7,609,179 B2	10/2009	Diaz-Gutierrez et al.
7,478,091 B2	1/2009	Mojsilovic et al.	7,610,258 B2	10/2009	Yuknewicz et al.
7,478,129 B1	1/2009	Chemtob	7,613,264 B2	11/2009	Wells et al.
7,479,948 B2	1/2009	Kim et al.	7,614,008 B2	11/2009	Ording
7,479,949 B2	1/2009	Jobs et al.	7,617,094 B2	11/2009	Aoki et al.
7,483,832 B2	1/2009	Tischer	7,620,407 B1	11/2009	Donald et al.
7,483,894 B2	1/2009	Cao	7,620,549 B2	11/2009	Di Cristo et al.
7,487,089 B2	2/2009	Mozer	7,620,894 B1	11/2009	Kahn
7,487,093 B2	2/2009	Mutsuno et al.	7,623,119 B2	11/2009	Autio et al.
7,490,034 B2	2/2009	Finnigan et al.	7,624,007 B2	11/2009	Bennett
7,490,039 B1	2/2009	Shaffer et al.	7,627,481 B1	12/2009	Kuo et al.
7,493,251 B2	2/2009	Gao et al.	7,630,900 B1	12/2009	Strom
7,493,560 B1	2/2009	Kipnes et al.	7,630,901 B2	12/2009	Omi
7,496,498 B2	2/2009	Chu et al.	7,633,076 B2	12/2009	Huppi et al.
7,496,512 B2	2/2009	Zhao et al.	7,634,409 B2	12/2009	Kennewick et al.
7,499,923 B2	3/2009	Kawatani	7,634,413 B1	12/2009	Kuo et al.
7,502,738 B2	3/2009	Kennewick et al.	7,634,718 B2	12/2009	Nakajima
7,505,795 B1	3/2009	Lim et al.	7,634,732 B1	12/2009	Blagsvedt et al.
7,508,324 B2	3/2009	Suraqui	7,636,657 B2	12/2009	Ju et al.
7,508,373 B2	3/2009	Lin et al.	7,640,158 B2	12/2009	Detlef et al.
7,516,123 B2	4/2009	Betz et al.	7,640,160 B2	12/2009	Di Cristo et al.
7,519,327 B2	4/2009	White	7,643,990 B1	1/2010	Bellegarda
7,519,398 B2	4/2009	Hirose	7,647,225 B2	1/2010	Bennett et al.
7,522,927 B2	4/2009	Fitch et al.	7,649,454 B2	1/2010	Singh et al.
7,523,036 B2	4/2009	Akabane et al.	7,649,877 B2	1/2010	Vieri et al.
7,523,108 B2	4/2009	Cao	7,653,883 B2	1/2010	Hotelling et al.
7,526,466 B2	4/2009	Au	7,656,393 B2	2/2010	King et al.
7,526,738 B2	4/2009	Ording et al.	7,657,424 B2	2/2010	Bennett
7,528,713 B2	5/2009	Singh et al.	7,657,828 B2	2/2010	Lucas et al.
7,529,671 B2	5/2009	Rockenbeck et al.	7,657,844 B2	2/2010	Gibson et al.
7,529,676 B2	5/2009	Koyama	7,657,849 B2	2/2010	Chaudhri et al.
7,535,997 B1	5/2009	McQuaide, Jr. et al.	7,663,607 B2	2/2010	Hotelling et al.
7,536,029 B2	5/2009	Choi et al.	7,664,558 B2	2/2010	Lindahl et al.
7,536,565 B2	5/2009	Girish et al.	7,664,638 B2	2/2010	Cooper et al.
7,538,685 B1	5/2009	Cooper et al.	7,669,134 B1	2/2010	Christie et al.
7,539,619 B1	5/2009	Seligman et al.	7,672,841 B2	3/2010	Bennett
			7,672,952 B2	3/2010	Isaacson et al.
			7,673,238 B2	3/2010	Girish et al.
			7,673,251 B1	3/2010	Wibisono
			7,673,340 B1	3/2010	Cohen et al.

(56)

References Cited

U.S. PATENT DOCUMENTS

7,676,026 B1	3/2010	Baxter, Jr.	7,779,356 B2	8/2010	Griesmer
7,676,365 B2	3/2010	Hwang et al.	7,779,357 B2	8/2010	Naik
7,676,463 B2	3/2010	Thompson et al.	7,783,283 B2	8/2010	Kuusinen et al.
7,679,534 B2	3/2010	Kay et al.	7,783,486 B2	8/2010	Rosser et al.
7,680,649 B2	3/2010	Park	7,788,590 B2	8/2010	Taboada et al.
7,681,126 B2	3/2010	Roose	7,788,663 B2	8/2010	Illowsky et al.
7,683,886 B2	3/2010	Willey	7,796,980 B1	9/2010	McKinney et al.
7,683,893 B2	3/2010	Kim	7,797,265 B2	9/2010	Brinker et al.
7,684,985 B2	3/2010	Dominach et al.	7,797,269 B2	9/2010	Rieman et al.
7,684,990 B2	3/2010	Caskey et al.	7,797,331 B2	9/2010	Theimer et al.
7,684,991 B2	3/2010	Stohr et al.	7,797,629 B2	9/2010	Fux et al.
7,689,245 B2	3/2010	Cox et al.	7,801,721 B2	9/2010	Rosart et al.
7,689,408 B2	3/2010	Chen et al.	7,801,728 B2	9/2010	Ben-David et al.
7,689,409 B2	3/2010	Heinecke	7,801,729 B2	9/2010	Mozer
7,689,412 B2	3/2010	Wu et al.	7,805,299 B2	9/2010	Coifman
7,689,421 B2	3/2010	Li et al.	7,809,550 B1	10/2010	Barrows
7,693,715 B2	4/2010	Hwang et al.	7,809,565 B2	10/2010	Coifman
7,693,717 B2	4/2010	Kahn et al.	7,809,569 B2	10/2010	Attwater et al.
7,693,719 B2	4/2010	Chu et al.	7,809,570 B2	10/2010	Kennewick et al.
7,693,720 B2	4/2010	Kennewick et al.	7,809,610 B2	10/2010	Cao
7,698,131 B2	4/2010	Bennett	7,809,744 B2	10/2010	Nevidomski et al.
7,702,500 B2	4/2010	Blaedow	7,818,165 B2	10/2010	Carlgren et al.
7,702,508 B2	4/2010	Bennett	7,818,176 B2	10/2010	Freeman et al.
7,703,091 B1	4/2010	Martin et al.	7,818,215 B2	10/2010	King et al.
7,706,510 B2	4/2010	Ng	7,818,291 B2	10/2010	Ferguson et al.
7,707,026 B2	4/2010	Liu	7,818,672 B2	10/2010	Mccormack et al.
7,707,027 B2	4/2010	Balchandran et al.	7,822,608 B2	10/2010	Cross, Jr. et al.
7,707,032 B2	4/2010	Wang et al.	7,823,123 B2	10/2010	Sabbouh
7,707,221 B1	4/2010	Dunning et al.	7,826,945 B2	11/2010	Zhang et al.
7,707,226 B1	4/2010	Tonse	7,827,047 B2	11/2010	Anderson et al.
7,707,267 B2	4/2010	Lisitsa et al.	7,831,423 B2	11/2010	Schubert
7,710,262 B2	5/2010	Ruha	7,831,426 B2	11/2010	Bennett
7,711,129 B2	5/2010	Lindahl et al.	7,831,432 B2	11/2010	Bodin et al.
7,711,550 B1	5/2010	Feinberg et al.	7,835,504 B1	11/2010	Donald et al.
7,711,565 B1	5/2010	Gazdzinski	7,836,437 B2	11/2010	Kacmarcik et al.
7,711,672 B2	5/2010	Au	7,840,348 B2	11/2010	Kim et al.
7,712,053 B2	5/2010	Bradford et al.	7,840,400 B2	11/2010	Lavi et al.
7,716,056 B2	5/2010	Weng et al.	7,840,447 B2	11/2010	Kleinrock et al.
7,716,216 B1	5/2010	Harik et al.	7,840,581 B2	11/2010	Ross et al.
7,720,674 B2	5/2010	Kaiser et al.	7,840,912 B2	11/2010	Elias et al.
7,720,683 B1	5/2010	Vermeulen et al.	7,844,394 B2	11/2010	Kim
7,721,226 B2	5/2010	Barabe et al.	7,848,924 B2	12/2010	Nurminen et al.
7,721,301 B2	5/2010	Wong et al.	7,848,926 B2	12/2010	Goto et al.
7,724,242 B2	5/2010	Hillis et al.	7,853,444 B2	12/2010	Wang et al.
7,724,696 B1	5/2010	Parekh	7,853,445 B2	12/2010	Bachenko et al.
7,725,307 B2	5/2010	Bennett	7,853,574 B2	12/2010	Kraenzel et al.
7,725,318 B2	5/2010	Gavalda et al.	7,853,577 B2	12/2010	Sundaresan et al.
7,725,320 B2	5/2010	Bennett	7,853,664 B1	12/2010	Wang et al.
7,725,321 B2	5/2010	Bennett	7,853,900 B2	12/2010	Nguyen et al.
7,725,838 B2	5/2010	Williams	7,865,817 B2	1/2011	Ryan et al.
7,729,904 B2	6/2010	Bennett	7,869,999 B2	1/2011	Amato et al.
7,729,916 B2	6/2010	Coffman et al.	7,870,118 B2	1/2011	Jiang et al.
7,734,461 B2	6/2010	Kwak et al.	7,870,133 B2	1/2011	Krishnamoorthy et al.
7,735,012 B2	6/2010	Naik	7,873,149 B2	1/2011	Schultz et al.
7,739,588 B2	6/2010	Reynar et al.	7,873,519 B2	1/2011	Bennett
7,742,953 B2	6/2010	King et al.	7,873,654 B2	1/2011	Bernard
7,743,188 B2	6/2010	Haitani et al.	7,877,705 B2	1/2011	Chambers et al.
7,747,616 B2	6/2010	Yamada et al.	7,880,730 B2	2/2011	Robinson et al.
7,752,152 B2	7/2010	Paek et al.	7,881,283 B2	2/2011	Cormier et al.
7,756,708 B2	7/2010	Cohen et al.	7,881,936 B2	2/2011	Longe et al.
7,756,868 B2	7/2010	Lee	7,885,390 B2	2/2011	Chaudhuri et al.
7,756,871 B2	7/2010	Yacoub et al.	7,885,844 B1	2/2011	Cohen et al.
7,757,173 B2	7/2010	Beaman	7,886,233 B2	2/2011	Rainisto et al.
7,757,182 B2	7/2010	Elliott et al.	7,889,101 B2	2/2011	Yokota
7,761,296 B1	7/2010	Bakis et al.	7,889,184 B2	2/2011	Blumenberg et al.
7,763,842 B2	7/2010	Hsu et al.	7,889,185 B2	2/2011	Blumenberg et al.
7,774,202 B2	8/2010	Spengler et al.	7,890,330 B2	2/2011	Ozkaragoz et al.
7,774,204 B2	8/2010	Mozer et al.	7,890,652 B2	2/2011	Bull et al.
7,774,388 B1	8/2010	Runchey	7,895,039 B2	2/2011	Braho et al.
7,777,717 B2	8/2010	Fux et al.	7,895,531 B2	2/2011	Radtke et al.
7,778,432 B2	8/2010	Larsen	7,899,666 B2	3/2011	Varone
7,778,595 B2	8/2010	White et al.	7,904,297 B2	3/2011	Mirkovic et al.
7,778,632 B2	8/2010	Kurlander et al.	7,908,287 B1	3/2011	Katragadda
7,778,830 B2	8/2010	Davis et al.	7,912,289 B2	3/2011	Kansal et al.
7,779,353 B2	8/2010	Grigoriu et al.	7,912,699 B1	3/2011	Saraclar et al.
			7,912,702 B2	3/2011	Bennett
			7,912,720 B1	3/2011	Hakkani-Tur et al.
			7,912,828 B2	3/2011	Bonnet et al.
			7,913,185 B1	3/2011	Benson et al.

(56)

References Cited

U.S. PATENT DOCUMENTS

7,916,979 B2	3/2011	Simmons	8,060,824 B2	11/2011	Brownrigg, Jr. et al.
7,917,367 B2	3/2011	Di Cristo et al.	8,064,753 B2	11/2011	Freeman
7,917,497 B2	3/2011	Harrison et al.	8,065,143 B2	11/2011	Yanagihara
7,920,678 B2	4/2011	Cooper et al.	8,065,155 B1	11/2011	Gazdzinski
7,920,682 B2	4/2011	Byrne et al.	8,065,156 B2	11/2011	Gazdzinski
7,920,857 B2	4/2011	Lau et al.	8,068,604 B2	11/2011	Leeds et al.
7,925,525 B2	4/2011	Chin	8,069,046 B2	11/2011	Kennewick et al.
7,925,610 B2	4/2011	Elbaz et al.	8,069,422 B2	11/2011	Sheshagiri et al.
7,929,805 B2	4/2011	Wang et al.	8,073,681 B2	12/2011	Baldwin et al.
7,930,168 B2	4/2011	Weng et al.	8,073,695 B1	12/2011	Hendricks et al.
7,930,183 B2	4/2011	Odell et al.	8,077,153 B2	12/2011	Benko et al.
7,930,197 B2	4/2011	Ozzie et al.	8,078,473 B1	12/2011	Gazdzinski
7,936,339 B2	5/2011	Marggraff et al.	8,082,153 B2	12/2011	Coffman et al.
7,936,861 B2	5/2011	Martin et al.	8,082,498 B2	12/2011	Salamon et al.
7,936,863 B2	5/2011	John et al.	8,090,571 B2	1/2012	Elshishiny et al.
7,937,075 B2	5/2011	Zellner	8,095,364 B2	1/2012	Longe et al.
7,941,009 B2	5/2011	Li et al.	8,099,289 B2	1/2012	Mozer et al.
7,945,294 B2	5/2011	Zhang et al.	8,099,395 B2	1/2012	Pabla et al.
7,945,470 B1	5/2011	Cohen et al.	8,099,418 B2	1/2012	Inoue et al.
7,949,529 B2	5/2011	Weider et al.	8,103,510 B2	1/2012	Sato
7,949,534 B2	5/2011	Davis et al.	8,107,401 B2	1/2012	John et al.
7,949,752 B2	5/2011	Lange et al.	8,112,275 B2	2/2012	Kennewick et al.
7,953,679 B2	5/2011	Chidlovskii et al.	8,112,280 B2	2/2012	Lu
7,957,975 B2	6/2011	Burns et al.	8,117,037 B2	2/2012	Gazdzinski
7,958,136 B1	6/2011	Curtis et al.	8,117,542 B2	2/2012	Radtke et al.
7,962,179 B2	6/2011	Huang	8,121,413 B2	2/2012	Hwang et al.
7,974,835 B2	7/2011	Balchandran et al.	8,121,837 B2	2/2012	Agapi et al.
7,974,844 B2	7/2011	Sumita	8,122,094 B1	2/2012	Kotab
7,974,972 B2	7/2011	Cao	8,122,353 B2	2/2012	Bouta
7,975,216 B2	7/2011	Woolf et al.	8,130,929 B2	3/2012	Wilkes et al.
7,983,478 B2	7/2011	Liu et al.	8,131,557 B2	3/2012	Davis et al.
7,983,915 B2	7/2011	Knight et al.	8,135,115 B1	3/2012	Hogg, Jr. et al.
7,983,917 B2	7/2011	Kennewick et al.	8,138,912 B2	3/2012	Singh et al.
7,983,919 B2	7/2011	Conkie	8,140,335 B2	3/2012	Kennewick et al.
7,983,997 B2	7/2011	Allen et al.	8,140,567 B2	3/2012	Padovitz et al.
7,984,062 B2	7/2011	Dunning et al.	8,145,489 B2	3/2012	Freeman et al.
7,986,431 B2	7/2011	Emori et al.	8,150,694 B2	4/2012	Kennewick et al.
7,987,151 B2	7/2011	Schott et al.	8,150,700 B2	4/2012	Shin et al.
7,987,244 B1	7/2011	Lewis et al.	8,155,956 B2	4/2012	Cho et al.
7,991,614 B2	8/2011	Washio et al.	8,156,005 B2	4/2012	Vieri
7,992,085 B2	8/2011	Wang-Aryattanwanich et al.	8,160,877 B1	4/2012	Nucci et al.
7,996,228 B2	8/2011	Miller et al.	8,160,883 B2	4/2012	Lecoeuche
7,996,589 B2	8/2011	Schultz et al.	8,165,321 B2	4/2012	Paquier et al.
7,996,769 B2	8/2011	Fux et al.	8,165,886 B1	4/2012	Gagnon et al.
7,996,792 B2	8/2011	Anzures et al.	8,166,019 B1	4/2012	Lee et al.
7,999,669 B2	8/2011	Singh et al.	8,166,032 B2	4/2012	Sommer et al.
8,000,453 B2	8/2011	Cooper et al.	8,170,790 B2	5/2012	Lee et al.
8,005,664 B2	8/2011	Hanumanthappa	8,175,872 B2	5/2012	Kristjansson et al.
8,005,679 B2	8/2011	Jordan et al.	8,179,370 B1	5/2012	Yamasani et al.
8,006,180 B2	8/2011	Tunning et al.	8,188,856 B2	5/2012	Singh et al.
8,014,308 B2	9/2011	Gates et al.	8,190,359 B2	5/2012	Bourne
8,015,006 B2	9/2011	Kennewick et al.	8,195,467 B2	6/2012	Mozer et al.
8,015,011 B2	9/2011	Nagano et al.	8,195,468 B2	6/2012	Kennewick et al.
8,015,144 B2	9/2011	Zheng et al.	8,200,495 B2	6/2012	Braho et al.
8,018,431 B1	9/2011	Zehr et al.	8,201,109 B2	6/2012	Van Os et al.
8,019,271 B1	9/2011	Izdepski	8,204,238 B2	6/2012	Mozer
8,020,104 B2	9/2011	Robarts et al.	8,205,788 B1	6/2012	Gazdzinski et al.
8,024,195 B2	9/2011	Mozer et al.	8,209,183 B1	6/2012	Patel et al.
8,024,415 B2	9/2011	Horvitz et al.	8,213,911 B2	7/2012	Williams et al.
8,027,836 B2	9/2011	Baker et al.	8,219,115 B1	7/2012	Nelissen
8,031,943 B2	10/2011	Chen et al.	8,219,406 B2	7/2012	Yu et al.
8,032,383 B1	10/2011	Bhardwaj et al.	8,219,407 B1	7/2012	Roy et al.
8,036,901 B2	10/2011	Mozer	8,219,608 B2	7/2012	alSafadi et al.
8,037,034 B2	10/2011	Plachta et al.	8,224,649 B2	7/2012	Chaudhari et al.
8,041,557 B2	10/2011	Liu	8,228,299 B1	7/2012	Maloney et al.
8,041,570 B2	10/2011	Mirkovic et al.	8,233,919 B2	7/2012	Haag et al.
8,041,611 B2	10/2011	Kleinrock et al.	8,234,111 B2	7/2012	Lloyd et al.
8,042,053 B2	10/2011	Darwish et al.	8,239,206 B1	8/2012	LeBeau et al.
8,046,363 B2	10/2011	Cha et al.	8,239,207 B2	8/2012	Seligman et al.
8,046,374 B1	10/2011	Bromwich et al.	8,244,712 B2	8/2012	Serlet et al.
8,050,500 B1	11/2011	Batty et al.	8,250,071 B1	8/2012	Killalea et al.
8,054,180 B1	11/2011	Scotfield et al.	8,254,829 B1	8/2012	Kindred et al.
8,055,502 B2	11/2011	Clark et al.	8,255,216 B2	8/2012	White
8,055,708 B2	11/2011	Chitsaz et al.	8,255,217 B2	8/2012	Stent et al.
8,056,070 B2	11/2011	Goller et al.	8,260,247 B2	9/2012	Lazaridis et al.
			8,260,617 B2	9/2012	Dhanakshirur et al.
			8,270,933 B2	9/2012	Riemer et al.
			8,275,621 B2	9/2012	Alewine et al.
			8,279,171 B2	10/2012	Hirai et al.

(56)

References Cited

U.S. PATENT DOCUMENTS

8,280,438 B2	10/2012	Barbera	8,595,004 B2	11/2013	Koshinaka
8,285,546 B2	10/2012	Reich	8,600,743 B2	12/2013	Lindahl et al.
8,285,551 B2	10/2012	Gazdzinski	8,600,930 B2	12/2013	Sata et al.
8,285,553 B2	10/2012	Gazdzinski	8,606,568 B1	12/2013	Tickner et al.
8,290,777 B1	10/2012	Nguyen et al.	8,620,659 B2	12/2013	Di Cristo et al.
8,290,778 B2	10/2012	Gazdzinski	8,620,662 B2	12/2013	Bellegarda
8,290,781 B2	10/2012	Gazdzinski	8,626,681 B1	1/2014	Jurca et al.
8,296,124 B1	10/2012	Holsztyńska et al.	8,639,516 B2	1/2014	Lindahl et al.
8,296,145 B2	10/2012	Clark et al.	8,645,137 B2	2/2014	Bellegarda et al.
8,296,146 B2	10/2012	Gazdzinski	8,645,138 B1	2/2014	Weinstein et al.
8,296,153 B2	10/2012	Gazdzinski	8,654,936 B1	2/2014	Tofighbakhsh et al.
8,296,380 B1	10/2012	Kelly et al.	8,655,646 B2	2/2014	Lee et al.
8,296,383 B2	10/2012	Lindahl	8,655,901 B1	2/2014	Li et al.
8,300,801 B2	10/2012	Sweeney et al.	8,660,843 B2	2/2014	Falcon et al.
8,301,456 B2	10/2012	Gazdzinski	8,660,849 B2	2/2014	Gruber et al.
8,311,834 B1	11/2012	Gazdzinski	8,660,970 B1	2/2014	Fiedorowicz
8,311,835 B2	11/2012	Lecoeuche	8,661,112 B2	2/2014	Creamer et al.
8,311,838 B2	11/2012	Lindahl et al.	8,661,340 B2	2/2014	Goldsmith et al.
8,312,017 B2	11/2012	Martin et al.	8,670,979 B2	3/2014	Gruber et al.
8,321,786 B2	11/2012	Lunati et al.	8,675,084 B2	3/2014	Bolton et al.
8,326,627 B2	12/2012	Kennewick et al.	8,676,904 B2	3/2014	Lindahl et al.
8,332,205 B2	12/2012	Krishnan et al.	8,677,377 B2	3/2014	Cheyer et al.
8,332,218 B2	12/2012	Cross et al.	8,681,950 B2	3/2014	Vlack et al.
8,332,224 B2	12/2012	Di Cristo et al.	8,682,667 B2	3/2014	Haughay et al.
8,332,748 B1	12/2012	Karam	8,687,777 B1	4/2014	Lavian et al.
8,340,975 B1	12/2012	Rosenberger	8,688,446 B2	4/2014	Yanagihara et al.
8,345,665 B2	1/2013	Vieri et al.	8,688,453 B1	4/2014	Joshi et al.
8,346,563 B1	1/2013	Hjelm et al.	8,695,074 B2	4/2014	Saraf et al.
8,352,183 B2	1/2013	Thota et al.	8,696,364 B2	4/2014	Cohen
8,352,268 B2	1/2013	Naik et al.	8,706,472 B2	4/2014	Ramerth et al.
8,352,272 B2	1/2013	Rogers et al.	8,706,474 B2	4/2014	Blume et al.
8,355,919 B2	1/2013	Silverman et al.	8,706,503 B2	4/2014	Cheyer et al.
8,359,234 B2	1/2013	Vieri	8,713,119 B2	4/2014	Lindahl et al.
8,370,145 B2	2/2013	Endo et al.	8,713,418 B2	4/2014	King et al.
8,370,158 B2	2/2013	Gazdzinski	8,719,006 B2	5/2014	Bellegarda et al.
8,371,503 B2	2/2013	Gazdzinski	8,719,014 B2	5/2014	Wagner et al.
8,374,871 B2	2/2013	Ehsani et al.	8,731,610 B2	5/2014	Appaji
8,375,320 B2	2/2013	Kotler et al.	8,731,912 B1	5/2014	Tickner et al.
8,380,504 B1	2/2013	Peden et al.	8,731,942 B2	5/2014	Cheyer et al.
8,380,507 B2	2/2013	Herman et al.	8,739,208 B2	5/2014	Rodriguez et al.
8,381,107 B2	2/2013	Rottler et al.	8,744,852 B1	6/2014	Seymour et al.
8,381,135 B2	2/2013	Hotelling et al.	8,760,537 B2	6/2014	Johnson et al.
8,386,485 B2	2/2013	Kerschberg et al.	8,762,145 B2	6/2014	Ouchi et al.
8,386,926 B1	2/2013	Matsuoka	8,762,156 B2	6/2014	Chen et al.
8,391,844 B2	3/2013	Lamiroux et al.	8,762,469 B2	6/2014	Lindahl et al.
8,396,714 B2	3/2013	Rogers et al.	8,768,693 B2	7/2014	Lempel et al.
8,406,745 B1	3/2013	Upadhyay et al.	8,768,702 B2	7/2014	Boettcher et al.
8,423,288 B2	4/2013	Stahl et al.	8,775,154 B2	7/2014	Clinchant et al.
8,428,758 B2	4/2013	Naik et al.	8,775,931 B2	7/2014	Fux et al.
8,433,778 B1	4/2013	Shreesha et al.	8,781,841 B1	7/2014	Wang
8,442,821 B1	5/2013	Vanhoucke	8,798,255 B2	8/2014	Lubowich et al.
8,447,612 B2	5/2013	Gazdzinski	8,798,995 B1	8/2014	Edara et al.
8,452,597 B2	5/2013	Bringert et al.	8,799,000 B2	8/2014	Guzzoni et al.
8,457,959 B2	6/2013	Kaiser	8,805,690 B1	8/2014	LeBeau et al.
8,458,115 B2	6/2013	Cai et al.	8,812,302 B2	8/2014	Xiao et al.
8,458,278 B2	6/2013	Christie et al.	8,838,457 B2	9/2014	Cerra et al.
8,464,150 B2	6/2013	Davidson et al.	8,855,915 B2	10/2014	Furuhata et al.
8,473,289 B2	6/2013	Jitkoff et al.	8,861,925 B1	10/2014	Ohme
8,479,122 B2	7/2013	Hotelling et al.	8,862,252 B2	10/2014	Rottler et al.
8,484,027 B1	7/2013	Murphy	8,868,409 B1	10/2014	Mengibar et al.
8,489,599 B2	7/2013	Bellotti	8,880,405 B2	11/2014	Cerra et al.
8,498,857 B2	7/2013	Kopparapu et al.	8,886,540 B2	11/2014	Cerra et al.
8,514,197 B2	8/2013	Shahrray et al.	8,886,541 B2	11/2014	Friedlander
8,515,750 B1	8/2013	Lei et al.	8,892,446 B2	11/2014	Cheyer et al.
8,521,513 B2	8/2013	Millett et al.	8,898,568 B2	11/2014	Bull et al.
8,521,531 B1 *	8/2013	Kim G10L 15/22 704/252	8,903,716 B2	12/2014	Chen et al.
8,527,276 B1	9/2013	Senior et al.	8,909,693 B2	12/2014	Frissora et al.
8,543,398 B1	9/2013	Strope et al.	8,930,176 B2	1/2015	Li et al.
8,560,229 B1	10/2013	Park et al.	8,930,191 B2	1/2015	Gruber et al.
8,571,851 B1	10/2013	Tickner et al.	8,938,394 B1	1/2015	Faaborg et al.
8,583,416 B2	11/2013	Huang et al.	8,942,986 B2	1/2015	Cheyer et al.
8,583,511 B2	11/2013	Hendrickson	8,943,423 B2	1/2015	Merrill et al.
8,589,869 B2	11/2013	Wolfram	8,972,240 B2	3/2015	Brockett et al.
8,589,911 B1	11/2013	Sharkey et al.	8,972,432 B2	3/2015	Shaw et al.
			8,972,878 B2	3/2015	Mohler et al.
			8,983,383 B1	3/2015	Haskin
			8,989,713 B2	3/2015	Doulton
			8,990,235 B2	3/2015	King et al.
			8,994,660 B2	3/2015	Neels et al.

(56)

References Cited

U.S. PATENT DOCUMENTS

8,996,350	B1	3/2015	Dub et al.	2001/0029455	A1	10/2001	Chin et al.
8,996,376	B2	3/2015	Fleizach et al.	2001/0030660	A1	10/2001	Zainoulline
8,996,381	B2	3/2015	Mozer et al.	2001/0032080	A1	10/2001	Fukada
9,009,046	B1	4/2015	Stewart	2001/0041021	A1	11/2001	Boyle et al.
9,020,804	B2	4/2015	Barbaiani et al.	2001/0042107	A1	11/2001	Palm
9,026,425	B2	5/2015	Nikoulina et al.	2001/0044724	A1	11/2001	Hon et al.
9,031,834	B2	5/2015	Coorman et al.	2001/0047264	A1	11/2001	Roundtree
9,037,967	B1	5/2015	Al-Jefri et al.	2001/0055963	A1	12/2001	Cloutier
9,043,208	B2	5/2015	Koch et al.	2001/0056342	A1	12/2001	Piehn et al.
9,049,255	B2	6/2015	MacFarlane et al.	2001/0056347	A1	12/2001	Chazan et al.
9,053,706	B2	6/2015	Jitkoff et al.	2002/0001395	A1	1/2002	Davis et al.
9,058,811	B2	6/2015	Wang et al.	2002/0002039	A1	1/2002	Qureshey et al.
9,063,979	B2	6/2015	Chiu et al.	2002/0002413	A1	1/2002	Tokue
9,070,366	B1 *	6/2015	Mathias G06F 17/279	2002/0002461	A1	1/2002	Tetsumoto
9,071,701	B2	6/2015	Donaldson et al.	2002/0002465	A1	1/2002	Maes
9,081,411	B2	7/2015	Kalns et al.	2002/0004703	A1	1/2002	Gaspard, II
9,081,482	B1	7/2015	Zhai et al.	2002/0010581	A1	1/2002	Euler et al.
9,098,467	B1	8/2015	Blanksteen et al.	2002/0010584	A1	1/2002	Schultz et al.
9,101,279	B2	8/2015	Ritchey et al.	2002/0010589	A1	1/2002	Nashida et al.
9,112,984	B2	8/2015	Sejnoha et al.	2002/0010726	A1	1/2002	Rogson
9,117,447	B2	8/2015	Gruber et al.	2002/0010798	A1	1/2002	Ben-Shaul et al.
9,123,338	B1	9/2015	Sanders et al.	2002/0013707	A1	1/2002	Shaw et al.
9,171,541	B2	10/2015	Kennewick et al.	2002/0013784	A1	1/2002	Swanson
9,171,546	B1	10/2015	Pike	2002/0013852	A1	1/2002	Janik
9,190,062	B2	11/2015	Haughay	2002/0015024	A1	2/2002	Westerman et al.
9,208,153	B1	12/2015	Zaveri et al.	2002/0015064	A1	2/2002	Robotham et al.
9,218,809	B2	12/2015	Bellegarda	2002/0021278	A1	2/2002	Hinckley et al.
9,218,819	B1	12/2015	Stekkelpak et al.	2002/0026315	A1	2/2002	Miranda
9,223,537	B2	12/2015	Brown et al.	2002/0026456	A1	2/2002	Bradford
9,255,812	B2	2/2016	Maeoka et al.	2002/0031254	A1	3/2002	Lantrip et al.
9,258,604	B1	2/2016	Bilobrov et al.	2002/0031262	A1	3/2002	Imagawa et al.
9,262,612	B2	2/2016	Cheyser	2002/0032048	A1	3/2002	Kitao et al.
9,292,487	B1	3/2016	Weber	2002/0032564	A1	3/2002	Ehsani et al.
9,292,489	B1	3/2016	Sak et al.	2002/0032591	A1	3/2002	Mahaffy et al.
9,299,344	B2	3/2016	Braho et al.	2002/0032751	A1	3/2002	Bharadwaj
9,305,543	B2	4/2016	Fleizach et al.	2002/0035467	A1	3/2002	Morimoto et al.
9,305,548	B2	4/2016	Kennewick et al.	2002/0035469	A1	3/2002	Holzapfel
9,311,912	B1	4/2016	Swietlinski et al.	2002/0035474	A1	3/2002	Alpdemir
9,313,317	B1	4/2016	LeBeau et al.	2002/0040297	A1	4/2002	Tsiao et al.
9,318,108	B2	4/2016	Gruber et al.	2002/0040359	A1	4/2002	Green et al.
9,325,809	B1	4/2016	Barros et al.	2002/0042707	A1	4/2002	Zhao et al.
9,338,493	B2	5/2016	Van Os et al.	2002/0045438	A1	4/2002	Tagawa et al.
9,349,368	B1	5/2016	LeBeau et al.	2002/0045961	A1	4/2002	Gibbs et al.
9,361,084	B1	6/2016	Costa	2002/0046025	A1	4/2002	Hain
9,367,541	B1	6/2016	Servan et al.	2002/0046032	A1	4/2002	Wutte
9,377,871	B2	6/2016	Waddell et al.	2002/0046315	A1	4/2002	Miller et al.
9,378,740	B1	6/2016	Rosen et al.	2002/0049587	A1	4/2002	Miyazawa
9,380,155	B1	6/2016	Reding et al.	2002/0052730	A1	5/2002	Nakao
9,390,726	B1	7/2016	Smus et al.	2002/0052740	A1	5/2002	Charlesworth et al.
9,401,147	B2	7/2016	Jitkoff et al.	2002/0052746	A1	5/2002	Handelman
9,412,392	B2	8/2016	Lindahl	2002/0052747	A1	5/2002	Sarukkai
9,423,266	B2	8/2016	Clark et al.	2002/0052913	A1	5/2002	Yamada et al.
9,436,918	B2	9/2016	Pantel et al.	2002/0054094	A1	5/2002	Matsuda
9,437,186	B1	9/2016	Liu et al.	2002/0055844	A1	5/2002	L'Esperance et al.
9,437,189	B2	9/2016	Epstein et al.	2002/0055934	A1	5/2002	Lipscomb et al.
9,454,957	B1	9/2016	Mathias et al.	2002/0057293	A1	5/2002	Liao
9,495,129	B2	11/2016	Fleizach et al.	2002/0059066	A1	5/2002	O'hagan
9,502,025	B2	11/2016	Kennewick et al.	2002/0059068	A1	5/2002	Rose et al.
9,510,044	B1	11/2016	Pereira et al.	2002/0065659	A1	5/2002	Isono et al.
9,536,527	B1	1/2017	Carlson	2002/0065797	A1	5/2002	Meidan et al.
9,547,647	B2	1/2017	Badaskar	2002/0067308	A1	6/2002	Robertson
9,548,050	B2	1/2017	Gruber et al.	2002/0069063	A1	6/2002	Buchner et al.
9,607,612	B2	3/2017	Deleeuw	2002/0069071	A1	6/2002	Knockeart et al.
9,620,113	B2	4/2017	Kennewick et al.	2002/0069220	A1	6/2002	Tran
9,620,126	B2	4/2017	Chiba	2002/0072816	A1	6/2002	Shdema et al.
9,626,955	B2	4/2017	Fleizach et al.	2002/0072908	A1	6/2002	Case et al.
9,633,660	B2	4/2017	Haughay	2002/0072914	A1	6/2002	Alshawi et al.
9,652,453	B2	5/2017	Mathur et al.	2002/0072915	A1	6/2002	Bower
9,734,839	B1 *	8/2017	Adams G10L 21/00	2002/0073177	A1	6/2002	Clark et al.
2001/0000534	A1	4/2001	Matulich et al.	2002/0077082	A1	6/2002	Cruickshank
2001/0005859	A1	6/2001	Okuyama et al.	2002/0077817	A1	6/2002	Atal
2001/0020259	A1	9/2001	Sekiguchi et al.	2002/0078041	A1	6/2002	Wu
2001/0023397	A1	9/2001	Tajima et al.	2002/0080163	A1	6/2002	Morey
2001/0027394	A1	10/2001	Theimer	2002/0082831	A1	6/2002	Hwang et al.
2001/0027396	A1	10/2001	Sato	2002/0083068	A1	6/2002	Quass et al.
				2002/0085037	A1	7/2002	Leavitt et al.
				2002/0086268	A1	7/2002	Shpiro
				2002/0086680	A1	7/2002	Hunzinger
				2002/0087306	A1	7/2002	Lee et al.

(56)

References Cited

U.S. PATENT DOCUMENTS

2002/0087508	A1	7/2002	Hull et al.	2002/0184003	A1	12/2002	Hakkinen et al.
2002/0087974	A1	7/2002	Sprague et al.	2002/0184015	A1	12/2002	Li et al.
2002/0091511	A1	7/2002	Hellwig et al.	2002/0184027	A1	12/2002	Brittan et al.
2002/0091529	A1	7/2002	Whitham	2002/0184189	A1	12/2002	Hay et al.
2002/0095286	A1	7/2002	Ross et al.	2002/0188454	A1	12/2002	Sauber
2002/0095290	A1	7/2002	Kahn et al.	2002/0188847	A1	12/2002	Valeria
2002/0099547	A1	7/2002	Chu et al.	2002/0189426	A1	12/2002	Hirade et al.
2002/0099552	A1	7/2002	Rubin et al.	2002/0191029	A1	12/2002	Gillespie et al.
2002/0101447	A1	8/2002	Carro	2002/0193996	A1	12/2002	Squibbs et al.
2002/0103641	A1	8/2002	Kuo et al.	2002/0196911	A1	12/2002	Gao et al.
2002/0103644	A1	8/2002	Brocius et al.	2002/0198714	A1	12/2002	Zhou
2002/0103646	A1	8/2002	Kochanski et al.	2002/0198715	A1	12/2002	Belrose
2002/0107684	A1	8/2002	Gao	2003/0001881	A1	1/2003	Mannheimer et al.
2002/0109709	A1	8/2002	Sagar	2003/0002632	A1	1/2003	Bhogal et al.
2002/0110248	A1	8/2002	Kovales et al.	2003/0003609	A1	1/2003	Sauer et al.
2002/0111198	A1	8/2002	Heie et al.	2003/0003897	A1	1/2003	Hyon
2002/0111806	A1	8/2002	Franz et al.	2003/0004703	A1	1/2003	Prabhakar et al.
2002/0111810	A1	8/2002	Khan et al.	2003/0004968	A1	1/2003	Romer et al.
2002/0116082	A1	8/2002	Gudorf	2003/0005174	A1	1/2003	Coffman et al.
2002/0116171	A1	8/2002	Russell	2003/0009459	A1	1/2003	Chastain et al.
2002/0116185	A1	8/2002	Cooper et al.	2003/0013483	A1	1/2003	Ausems et al.
2002/0116189	A1	8/2002	Yeh et al.	2003/0016770	A1	1/2003	Trans et al.
2002/0116420	A1	8/2002	Allam et al.	2003/0018475	A1	1/2003	Basu et al.
2002/0117384	A1	8/2002	Marchant	2003/0020760	A1	1/2003	Takatsu et al.
2002/0120697	A1	8/2002	Generous et al.	2003/0023420	A1	1/2003	Goodman et al.
2002/0120925	A1	8/2002	Logan	2003/0023426	A1	1/2003	Pun et al.
2002/0122053	A1	9/2002	Dutta et al.	2003/0025676	A1	2/2003	Cappendijk
2002/0123804	A1	9/2002	Gwon et al.	2003/0026392	A1	2/2003	Brown et al.
2002/0123891	A1	9/2002	Epstein et al.	2003/0026402	A1	2/2003	Clapper
2002/0123892	A1	9/2002	Woodward	2003/0028380	A1	2/2003	Freeland et al.
2002/0123894	A1	9/2002	Woodward	2003/0030645	A1	2/2003	Ribak et al.
2002/0126097	A1	9/2002	Savolainen	2003/0033148	A1	2/2003	Silverman et al.
2002/0128821	A1	9/2002	Ehsani et al.	2003/0033152	A1	2/2003	Cameron
2002/0128827	A1	9/2002	Bu et al.	2003/0033153	A1	2/2003	Olson et al.
2002/0128840	A1	9/2002	Hinde et al.	2003/0033214	A1	2/2003	Mikkelsen et al.
2002/0129057	A1	9/2002	Spielberg	2003/0036909	A1	2/2003	Kato
2002/0133341	A1	9/2002	Gillick et al.	2003/0037073	A1	2/2003	Tokuda et al.
2002/0133347	A1	9/2002	Schoneburg et al.	2003/0037077	A1	2/2003	Brill et al.
2002/0133348	A1	9/2002	Pearson et al.	2003/0037254	A1	2/2003	Fischer et al.
2002/0135565	A1	9/2002	Gordon et al.	2003/0038786	A1	2/2003	Nguyen et al.
2002/0135618	A1	9/2002	Maes et al.	2003/0040908	A1	2/2003	Yang et al.
2002/0137505	A1	9/2002	Eiche et al.	2003/0046075	A1	3/2003	Stone
2002/0138254	A1	9/2002	Isaka et al.	2003/0046401	A1	3/2003	Abbott et al.
2002/0138265	A1	9/2002	Stevens et al.	2003/0046434	A1	3/2003	Flanagin et al.
2002/0138270	A1	9/2002	Bellegarda et al.	2003/0048881	A1	3/2003	Trajkovic et al.
2002/0138274	A1	9/2002	Sharma et al.	2003/0050781	A1	3/2003	Tamura et al.
2002/0138616	A1	9/2002	Basson et al.	2003/0051136	A1	3/2003	Curtis et al.
2002/0140679	A1	10/2002	Wen	2003/0055537	A1	3/2003	Odinak et al.
2002/0143523	A1	10/2002	Balaj et al.	2003/0055623	A1	3/2003	Epstein et al.
2002/0143532	A1	10/2002	McClean et al.	2003/0055641	A1	3/2003	Yi et al.
2002/0143533	A1	10/2002	Lucas et al.	2003/0061317	A1	3/2003	Brown et al.
2002/0143542	A1	10/2002	Eide	2003/0061570	A1	3/2003	Hatori et al.
2002/0143551	A1	10/2002	Sharma et al.	2003/0063073	A1	4/2003	Geaghan et al.
2002/0143826	A1	10/2002	Day et al.	2003/0065805	A1	4/2003	Barnes, Jr.
2002/0151297	A1	10/2002	Remboski et al.	2003/0069893	A1	4/2003	Kanai et al.
2002/0152045	A1	10/2002	Dowling et al.	2003/0074195	A1	4/2003	Bartosik et al.
2002/0152255	A1	10/2002	Smith et al.	2003/0074198	A1	4/2003	Sussman
2002/0154160	A1	10/2002	Hosokawa	2003/0074457	A1	4/2003	Kluth
2002/0156771	A1	10/2002	Frieder et al.	2003/0076301	A1	4/2003	Tsuk et al.
2002/0161865	A1	10/2002	Nguyen	2003/0078766	A1	4/2003	Appelt et al.
2002/0163544	A1	11/2002	Baker et al.	2003/0078778	A1	4/2003	Emam et al.
2002/0164000	A1	11/2002	Cohen et al.	2003/0078779	A1	4/2003	Desai et al.
2002/0165717	A1	11/2002	Solmer et al.	2003/0078780	A1	4/2003	Kochanski et al.
2002/0165918	A1	11/2002	Bettis	2003/0078969	A1	4/2003	Sprague et al.
2002/0166123	A1	11/2002	Schrader et al.	2003/0079024	A1	4/2003	Hough et al.
2002/0167534	A1	11/2002	Burke	2003/0079038	A1	4/2003	Robbin et al.
2002/0169592	A1	11/2002	Aityan	2003/0080991	A1	5/2003	Crow et al.
2002/0169605	A1	11/2002	Damiba et al.	2003/0083113	A1	5/2003	Chua et al.
2002/0173273	A1	11/2002	Spurgat et al.	2003/0083878	A1	5/2003	Lee et al.
2002/0173889	A1	11/2002	Odinak et al.	2003/0083884	A1	5/2003	Odinak et al.
2002/0173955	A1	11/2002	Reich	2003/0084350	A1	5/2003	Eibach et al.
2002/0173961	A1	11/2002	Guerra	2003/0085870	A1	5/2003	Hinckley
2002/0173962	A1	11/2002	Tang et al.	2003/0086699	A1	5/2003	Benyamin et al.
2002/0173966	A1	11/2002	Henton	2003/0088414	A1	5/2003	Huang et al.
2002/0177993	A1	11/2002	Veditz et al.	2003/0088421	A1	5/2003	Maes et al.
				2003/0090467	A1	5/2003	Hohl et al.
				2003/0090474	A1	5/2003	Schaefer
				2003/0095096	A1	5/2003	Robbin et al.
				2003/0097210	A1	5/2003	Horst et al.

(56)

References Cited

U.S. PATENT DOCUMENTS

2003/0097379	A1	5/2003	Ireton	2003/0197736	A1	10/2003	Murphy
2003/0097407	A1	5/2003	Litwin et al.	2003/0197744	A1	10/2003	Irvine
2003/0097408	A1	5/2003	Kageyama et al.	2003/0200085	A1	10/2003	Nguyen et al.
2003/0098892	A1	5/2003	Hiipakka	2003/0200452	A1	10/2003	Tagawa et al.
2003/0099335	A1	5/2003	Tanaka et al.	2003/0200858	A1	10/2003	Xie
2003/0101045	A1	5/2003	Moffatt et al.	2003/0202697	A1	10/2003	Simard et al.
2003/0101054	A1	5/2003	Davis et al.	2003/0204392	A1	10/2003	Finnigan et al.
2003/0115060	A1	6/2003	Junqua et al.	2003/0204492	A1	10/2003	Wolf et al.
2003/0115064	A1	6/2003	Gusler et al.	2003/0206199	A1	11/2003	Pusa et al.
2003/0115186	A1	6/2003	Wilkinson et al.	2003/0208756	A1	11/2003	Macrae et al.
2003/0115289	A1	6/2003	Chinn et al.	2003/0210266	A1	11/2003	Cragun et al.
2003/0115552	A1	6/2003	Jahnke et al.	2003/0212543	A1	11/2003	Epstein et al.
2003/0117365	A1	6/2003	Shteyn	2003/0212961	A1	11/2003	Soin et al.
2003/0120494	A1	6/2003	Jost et al.	2003/0214519	A1	11/2003	Smith et al.
2003/0122652	A1	7/2003	Himmelstein et al.	2003/0216919	A1	11/2003	Roushar
2003/0122787	A1	7/2003	Zimmerman et al.	2003/0221198	A1	11/2003	Sloo et al.
2003/0125927	A1	7/2003	Seme	2003/0224760	A1	12/2003	Day
2003/0125945	A1	7/2003	Doyle	2003/0228863	A1	12/2003	Vander Veen et al.
2003/0125955	A1	7/2003	Arnold et al.	2003/0228909	A1	12/2003	Tanaka et al.
2003/0126559	A1	7/2003	Fuhrmann	2003/0229490	A1	12/2003	Etter
2003/0128819	A1	7/2003	Lee et al.	2003/0229616	A1	12/2003	Wong
2003/0130847	A1	7/2003	Case et al.	2003/0233230	A1	12/2003	Ammicht et al.
2003/0131320	A1	7/2003	Kumhyr et al.	2003/0233237	A1	12/2003	Garside et al.
2003/0133694	A1	7/2003	Yeo	2003/0233240	A1	12/2003	Kaatrasalo
2003/0134678	A1	7/2003	Tanaka	2003/0234824	A1	12/2003	Litwiller
2003/0135501	A1	7/2003	Frerebeau et al.	2003/0236663	A1	12/2003	Dimitrova et al.
2003/0135740	A1	7/2003	Talmor et al.	2003/0237055	A1	12/2003	Lange et al.
2003/0139925	A1	7/2003	Anderson et al.	2004/0001396	A1	1/2004	Keller et al.
2003/0140088	A1	7/2003	Robinson et al.	2004/0006467	A1	1/2004	Anisimovich et al.
2003/0144846	A1	7/2003	Denenberg et al.	2004/0008277	A1	1/2004	Nagaishi et al.
2003/0145285	A1	7/2003	Miyahira et al.	2004/0010484	A1	1/2004	Foulger et al.
2003/0147512	A1	8/2003	Abhuri	2004/0012556	A1	1/2004	Yong et al.
2003/0149557	A1	8/2003	Cox et al.	2004/0013252	A1	1/2004	Craner
2003/0149567	A1	8/2003	Schmitz et al.	2004/0015342	A1	1/2004	Garst et al.
2003/0149978	A1	8/2003	Plotnick	2004/0021676	A1	2/2004	Chen et al.
2003/0152203	A1	8/2003	Berger et al.	2004/0022369	A1	2/2004	Vitikainen et al.
2003/0152261	A1	8/2003	Hiroe et al.	2004/0022373	A1	2/2004	Suder et al.
2003/0152894	A1	8/2003	Townshend	2004/0023643	A1	2/2004	Vander Veen et al.
2003/0154079	A1	8/2003	Ota et al.	2004/0024834	A1	2/2004	Alegria et al.
2003/0154081	A1	8/2003	Chu et al.	2004/0030551	A1	2/2004	Marcu et al.
2003/0154116	A1	8/2003	Lofton	2004/0030554	A1	2/2004	Boxberger-Oberoi et al.
2003/0157968	A1	8/2003	Boman et al.	2004/0030556	A1	2/2004	Bennett
2003/0158732	A1	8/2003	Pi et al.	2004/0030559	A1	2/2004	Payne et al.
2003/0158735	A1	8/2003	Yamada et al.	2004/0030996	A1	2/2004	Van Liempd et al.
2003/0158737	A1	8/2003	Csicsatka	2004/0036715	A1	2/2004	Warren
2003/0160702	A1	8/2003	Tanaka	2004/0044516	A1	3/2004	Kennewick et al.
2003/0160830	A1	8/2003	Degross	2004/0048627	A1	3/2004	Olvera-Hernandez
2003/0163316	A1	8/2003	Addison et al.	2004/0049388	A1	3/2004	Roth et al.
2003/0164848	A1	9/2003	Dutta et al.	2004/0049391	A1	3/2004	Polanyi et al.
2003/0167167	A1	9/2003	Gong	2004/0051729	A1	3/2004	Borden, IV
2003/0167318	A1	9/2003	Robbin et al.	2004/0052338	A1	3/2004	Celi, Jr. et al.
2003/0167335	A1	9/2003	Alexander	2004/0054530	A1	3/2004	Davis et al.
2003/0171911	A1	9/2003	Fairweather	2004/0054533	A1	3/2004	Bellegarda
2003/0171928	A1	9/2003	Falcon et al.	2004/0054534	A1	3/2004	Junqua
2003/0171936	A1	9/2003	Sall et al.	2004/0054535	A1	3/2004	Mackie et al.
2003/0174830	A1	9/2003	Boyer et al.	2004/0054541	A1	3/2004	Kryze et al.
2003/0177046	A1	9/2003	Socha-Leialoha et al.	2004/0054690	A1	3/2004	Hillerbrand et al.
2003/0179222	A1	9/2003	Noma et al.	2004/0055446	A1	3/2004	Robbin et al.
2003/0182115	A1	9/2003	Malayath et al.	2004/0056899	A1	3/2004	Sinclair, II et al.
2003/0182119	A1	9/2003	Junqua et al.	2004/0059574	A1	3/2004	Ma et al.
2003/0182131	A1	9/2003	Arnold et al.	2004/0059577	A1	3/2004	Pickering
2003/0182394	A1	9/2003	Ryngle et al.	2004/0059790	A1	3/2004	Austin-Lane et al.
2003/0187655	A1	10/2003	Dunsmuir	2004/0061717	A1	4/2004	Menon et al.
2003/0187659	A1	10/2003	Cho et al.	2004/0062367	A1	4/2004	Fellenstein et al.
2003/0187775	A1	10/2003	Du et al.	2004/0064593	A1	4/2004	Sinclair et al.
2003/0187844	A1	10/2003	Li et al.	2004/0069122	A1	4/2004	Wilson
2003/0187925	A1	10/2003	Inala et al.	2004/0070567	A1	4/2004	Longe et al.
2003/0188005	A1	10/2003	Yoneda et al.	2004/0070612	A1	4/2004	Sinclair et al.
2003/0188192	A1	10/2003	Tang et al.	2004/0073427	A1	4/2004	Moore
2003/0190074	A1	10/2003	Loudon et al.	2004/0073428	A1	4/2004	Zlokarnik et al.
2003/0191625	A1	10/2003	Gorin et al.	2004/0076086	A1	4/2004	Keller et al.
2003/0191645	A1	10/2003	Zhou	2004/0078382	A1	4/2004	Mercer et al.
2003/0193481	A1	10/2003	Sokolsky	2004/0085162	A1	5/2004	Agarwal et al.
2003/0194080	A1	10/2003	Michaelis et al.	2004/0085368	A1	5/2004	Johnson, Jr. et al.
2003/0195741	A1	10/2003	Mani et al.	2004/0086120	A1	5/2004	Akins, III et al.
				2004/0093213	A1	5/2004	Conkie
				2004/0093215	A1	5/2004	Gupta et al.
				2004/0093328	A1	5/2004	Damle
				2004/0094018	A1	5/2004	Ueshima et al.

(56)

References Cited

U.S. PATENT DOCUMENTS

- | | | | | | | | |
|--------------|----|---------|---------------------|--------------|----|---------|-----------------------|
| 2004/0096105 | A1 | 5/2004 | Holtsberg | 2004/0225650 | A1 | 11/2004 | Cooper et al. |
| 2004/0098250 | A1 | 5/2004 | Kimchi et al. | 2004/0225746 | A1 | 11/2004 | Niell et al. |
| 2004/0100479 | A1 | 5/2004 | Nakano et al. | 2004/0226042 | A1 | 11/2004 | Ellis |
| 2004/0106432 | A1 | 6/2004 | Kanamori et al. | 2004/0230420 | A1 | 11/2004 | Kadambe et al. |
| 2004/0107169 | A1 | 6/2004 | Lowe | 2004/0230637 | A1 | 11/2004 | Lecoueche et al. |
| 2004/0111266 | A1 | 6/2004 | Coorman et al. | 2004/0236778 | A1 | 11/2004 | Junqua et al. |
| 2004/0111332 | A1 | 6/2004 | Baar et al. | 2004/0242286 | A1 | 12/2004 | Benco et al. |
| 2004/0114731 | A1 | 6/2004 | Gillett et al. | 2004/0243412 | A1 | 12/2004 | Gupta et al. |
| 2004/0120476 | A1 | 6/2004 | Harrison et al. | 2004/0243415 | A1 | 12/2004 | Commarford et al. |
| 2004/0122656 | A1 | 6/2004 | Abir | 2004/0243419 | A1 | 12/2004 | Wang |
| 2004/0122664 | A1 | 6/2004 | Lorenzo et al. | 2004/0249629 | A1 | 12/2004 | Webster |
| 2004/0122673 | A1 | 6/2004 | Park et al. | 2004/0249637 | A1 | 12/2004 | Baker et al. |
| 2004/0124583 | A1 | 7/2004 | Landis | 2004/0249667 | A1 | 12/2004 | Oon |
| 2004/0125088 | A1 | 7/2004 | Zimmerman et al. | 2004/0252119 | A1 | 12/2004 | Hunleth et al. |
| 2004/0125922 | A1 | 7/2004 | Specht | 2004/0252604 | A1 | 12/2004 | Johnson et al. |
| 2004/0127198 | A1 | 7/2004 | Roskind et al. | 2004/0252966 | A1 | 12/2004 | Holloway et al. |
| 2004/0127241 | A1 | 7/2004 | Shostak | 2004/0254791 | A1 | 12/2004 | Coifman et al. |
| 2004/0128137 | A1 | 7/2004 | Bush et al. | 2004/0254792 | A1 | 12/2004 | Busayapongchai et al. |
| 2004/0128614 | A1 | 7/2004 | Andrews et al. | 2004/0257432 | A1 | 12/2004 | Girish et al. |
| 2004/0133817 | A1 | 7/2004 | Choi | 2004/0259536 | A1 | 12/2004 | Keskar et al. |
| 2004/0135701 | A1 | 7/2004 | Yasuda et al. | 2004/0260438 | A1 | 12/2004 | Chernetsky et al. |
| 2004/0135774 | A1 | 7/2004 | La Monica | 2004/0260547 | A1 | 12/2004 | Cohen et al. |
| 2004/0136510 | A1 | 7/2004 | Vander Veen | 2004/0260718 | A1 | 12/2004 | Fedorov et al. |
| 2004/0138869 | A1 | 7/2004 | Heinecke | 2004/0261023 | A1 | 12/2004 | Bier |
| 2004/0138881 | A1 | 7/2004 | Divay et al. | 2004/0262051 | A1 | 12/2004 | Carro |
| 2004/0145607 | A1 | 7/2004 | Alderson | 2004/0263636 | A1 | 12/2004 | Cutler et al. |
| 2004/0148154 | A1 | 7/2004 | Acerro et al. | 2004/0267825 | A1 | 12/2004 | Novak et al. |
| 2004/0152054 | A1 | 8/2004 | Gleissner et al. | 2004/0268253 | A1 | 12/2004 | Demello et al. |
| 2004/0153306 | A1 | 8/2004 | Tanner et al. | 2004/0268262 | A1 | 12/2004 | Gupta et al. |
| 2004/0155869 | A1 | 8/2004 | Robinson et al. | 2005/0002507 | A1 | 1/2005 | Timmins et al. |
| 2004/0160419 | A1 | 8/2004 | Padgitt | 2005/0010409 | A1 | 1/2005 | Hull et al. |
| 2004/0162741 | A1 | 8/2004 | Flaxer et al. | 2005/0012723 | A1 | 1/2005 | Pallakoff |
| 2004/0167778 | A1 | 8/2004 | Valsan et al. | 2005/0015254 | A1 | 1/2005 | Beaman |
| 2004/0168120 | A1 | 8/2004 | Scopes | 2005/0015751 | A1 | 1/2005 | Grassens |
| 2004/0170379 | A1 | 9/2004 | Yao et al. | 2005/0015772 | A1 | 1/2005 | Saare et al. |
| 2004/0174399 | A1 | 9/2004 | Wu et al. | 2005/0021330 | A1 | 1/2005 | Mano et al. |
| 2004/0174434 | A1 | 9/2004 | Walker et al. | 2005/0021424 | A1 | 1/2005 | Lewis et al. |
| 2004/0176958 | A1 | 9/2004 | Salmenkaita et al. | 2005/0022114 | A1 | 1/2005 | Shanahan et al. |
| 2004/0177319 | A1 | 9/2004 | Horn | 2005/0024341 | A1 | 2/2005 | Gillespie et al. |
| 2004/0178994 | A1 | 9/2004 | Kairls, Jr. | 2005/0024345 | A1 | 2/2005 | Eastty et al. |
| 2004/0181392 | A1 | 9/2004 | Parikh et al. | 2005/0027385 | A1 | 2/2005 | Yueh |
| 2004/0183833 | A1 | 9/2004 | Chua | 2005/0030175 | A1 | 2/2005 | Wolfe |
| 2004/0186713 | A1 | 9/2004 | Gomas et al. | 2005/0031106 | A1 | 2/2005 | Henderson |
| 2004/0186714 | A1 | 9/2004 | Baker | 2005/0033582 | A1 | 2/2005 | Gadd et al. |
| 2004/0186777 | A1 | 9/2004 | Margiloff et al. | 2005/0033771 | A1 | 2/2005 | Schmitter et al. |
| 2004/0186857 | A1 | 9/2004 | Serlet et al. | 2005/0034164 | A1 | 2/2005 | Sano et al. |
| 2004/0193398 | A1 | 9/2004 | Chu et al. | 2005/0038657 | A1 | 2/2005 | Roth et al. |
| 2004/0193420 | A1 | 9/2004 | Kennewick et al. | 2005/0039141 | A1 | 2/2005 | Burke et al. |
| 2004/0193421 | A1 | 9/2004 | Blass | 2005/0042591 | A1 | 2/2005 | Bloom et al. |
| 2004/0193426 | A1 | 9/2004 | Maddux et al. | 2005/0043946 | A1 | 2/2005 | Ueyama et al. |
| 2004/0196256 | A1 | 10/2004 | Wobbrock et al. | 2005/0043949 | A1 | 2/2005 | Roth et al. |
| 2004/0198436 | A1 | 10/2004 | Alden | 2005/0043974 | A1 | 2/2005 | Vassilev et al. |
| 2004/0199375 | A1 | 10/2004 | Ehsani et al. | 2005/0044569 | A1 | 2/2005 | Marcus |
| 2004/0199387 | A1 | 10/2004 | Wang et al. | 2005/0045373 | A1 | 3/2005 | Born |
| 2004/0199663 | A1 | 10/2004 | Horvitz et al. | 2005/0049862 | A1 | 3/2005 | Choi et al. |
| 2004/0203520 | A1 | 10/2004 | Schirtzinger et al. | 2005/0049870 | A1 | 3/2005 | Zhang et al. |
| 2004/0205151 | A1 | 10/2004 | Sprigg et al. | 2005/0049880 | A1 | 3/2005 | Roth et al. |
| 2004/0205671 | A1 | 10/2004 | Sukehiro et al. | 2005/0050526 | A1 | 3/2005 | Dahne-Steuber et al. |
| 2004/0208302 | A1 | 10/2004 | Urban et al. | 2005/0055212 | A1 | 3/2005 | Nagao |
| 2004/0210438 | A1 | 10/2004 | Gillick et al. | 2005/0055403 | A1 | 3/2005 | Brittan |
| 2004/0210442 | A1 | 10/2004 | Glynn et al. | 2005/0058438 | A1 | 3/2005 | Hayashi |
| 2004/0210634 | A1 | 10/2004 | Ferrer et al. | 2005/0060151 | A1 | 3/2005 | Kuo et al. |
| 2004/0213419 | A1 | 10/2004 | Varma et al. | 2005/0060155 | A1 | 3/2005 | Chu et al. |
| 2004/0215449 | A1 | 10/2004 | Roy | 2005/0071165 | A1 | 3/2005 | Hofstader et al. |
| 2004/0215731 | A1 | 10/2004 | Tzann-en Szeto | 2005/0071332 | A1 | 3/2005 | Ortega et al. |
| 2004/0216049 | A1 | 10/2004 | Lewis et al. | 2005/0071437 | A1 | 3/2005 | Bear et al. |
| 2004/0218451 | A1 | 11/2004 | Said et al. | 2005/0074113 | A1 | 4/2005 | Mathew et al. |
| 2004/0220798 | A1 | 11/2004 | Chi et al. | 2005/0075875 | A1 | 4/2005 | Shozakai et al. |
| 2004/0220809 | A1 | 11/2004 | Wang et al. | 2005/0075881 | A1 | 4/2005 | Rigazio et al. |
| 2004/0221235 | A1 | 11/2004 | Marchisio et al. | 2005/0080613 | A1 | 4/2005 | Colledge et al. |
| 2004/0223485 | A1 | 11/2004 | Arellano et al. | 2005/0080620 | A1 | 4/2005 | Rao et al. |
| 2004/0223599 | A1 | 11/2004 | Bear et al. | 2005/0080625 | A1 | 4/2005 | Bennett et al. |
| 2004/0224638 | A1 | 11/2004 | Fadell et al. | 2005/0080632 | A1 | 4/2005 | Endo et al. |
| 2004/0225501 | A1 | 11/2004 | Cutaia et al. | 2005/0080780 | A1 | 4/2005 | Colledge et al. |
| 2004/0225504 | A1 | 11/2004 | Junqua et al. | 2005/0086059 | A1 | 4/2005 | Bennett |
| | | | | 2005/0086255 | A1 | 4/2005 | Schran et al. |
| | | | | 2005/0086605 | A1 | 4/2005 | Ferrer et al. |
| | | | | 2005/0091118 | A1 | 4/2005 | Fano |
| | | | | 2005/0094475 | A1 | 5/2005 | Naoui |

(56)

References Cited

U.S. PATENT DOCUMENTS

2005/0099398	A1	5/2005	Garside et al.	2005/0195429	A1	9/2005	Archbold
2005/0100214	A1	5/2005	Zhang et al.	2005/0196733	A1	9/2005	Budra et al.
2005/0102144	A1	5/2005	Rapoport	2005/0201572	A1	9/2005	Lindahl et al.
2005/0102614	A1	5/2005	Brockett et al.	2005/0202854	A1	9/2005	Kortum et al.
2005/0102625	A1	5/2005	Lee et al.	2005/0203738	A1	9/2005	Hwang
2005/0105712	A1	5/2005	Williams et al.	2005/0203747	A1	9/2005	Lecoeuche
2005/0108001	A1	5/2005	Aarskog	2005/0203782	A1	9/2005	Smith
2005/0108017	A1	5/2005	Esser et al.	2005/0203991	A1	9/2005	Kawamura et al.
2005/0108074	A1	5/2005	Bloechl et al.	2005/0209848	A1	9/2005	Ishii
2005/0108338	A1	5/2005	Simske et al.	2005/0210394	A1	9/2005	Crandall et al.
2005/0108344	A1	5/2005	Tafoya et al.	2005/0216271	A1	9/2005	Konig
2005/0108642	A1	5/2005	Sinclair et al.	2005/0216331	A1	9/2005	Ahrens et al.
2005/0114124	A1	5/2005	Liu et al.	2005/0222843	A1	10/2005	Kahn et al.
2005/0114140	A1	5/2005	Brackett et al.	2005/0222973	A1	10/2005	Kaiser
2005/0114306	A1	5/2005	Shu et al.	2005/0228665	A1	10/2005	Kobayashi et al.
2005/0114791	A1	5/2005	Bollenbacher et al.	2005/0245243	A1	11/2005	Zuniga
2005/0119890	A1	6/2005	Hirose	2005/0246350	A1	11/2005	Canaran
2005/0119897	A1	6/2005	Bennett et al.	2005/0246365	A1	11/2005	Lowles et al.
2005/0125215	A1	6/2005	Wu et al.	2005/0246686	A1	11/2005	Seshadri et al.
2005/0125216	A1	6/2005	Chitrapura et al.	2005/0246726	A1	11/2005	Labrou et al.
2005/0125218	A1	6/2005	Rajput et al.	2005/0251572	A1	11/2005	McMahan et al.
2005/0125226	A1	6/2005	Magee	2005/0254481	A1	11/2005	Vishik et al.
2005/0125235	A1	6/2005	Lazay et al.	2005/0255874	A1	11/2005	Stewart-Baxter et al.
2005/0131951	A1	6/2005	Zhang et al.	2005/0261901	A1	11/2005	Davis et al.
2005/0132301	A1	6/2005	Ikeda	2005/0261903	A1	11/2005	Kawazoe et al.
2005/0136949	A1	6/2005	Barnes, Jr.	2005/0262440	A1	11/2005	Stanciu et al.
2005/0138305	A1	6/2005	Zellner	2005/0267738	A1	12/2005	Wilkinson et al.
2005/0140504	A1	6/2005	Marshall et al.	2005/0267757	A1	12/2005	Iso-Sipila et al.
2005/0143970	A1	6/2005	Roth et al.	2005/0268247	A1	12/2005	Baneth
2005/0143972	A1	6/2005	Gopalakrishnan et al.	2005/0271216	A1	12/2005	Lashkari
2005/0144003	A1	6/2005	Iso-Sipila	2005/0273332	A1	12/2005	Scott et al.
2005/0144070	A1	6/2005	Cheshire	2005/0273337	A1	12/2005	Erell et al.
2005/0144568	A1	6/2005	Gruen et al.	2005/0273626	A1	12/2005	Pearson et al.
2005/0148356	A1	7/2005	Ferguson et al.	2005/0275505	A1	12/2005	Himmelstein
2005/0149214	A1	7/2005	Yoo et al.	2005/0278297	A1	12/2005	Nelson
2005/0149326	A1	7/2005	Hogengout et al.	2005/0278643	A1	12/2005	Ukai et al.
2005/0149328	A1	7/2005	Huang et al.	2005/0278647	A1	12/2005	Leavitt et al.
2005/0149330	A1	7/2005	Katae	2005/0283363	A1	12/2005	Weng et al.
2005/0149332	A1	7/2005	Kuzunuki et al.	2005/0283364	A1	12/2005	Longe et al.
2005/0149510	A1	7/2005	Shafrir	2005/0283726	A1	12/2005	Lunati
2005/0152558	A1	7/2005	Van Tassel	2005/0283729	A1	12/2005	Morris et al.
2005/0152602	A1	7/2005	Chen et al.	2005/0288934	A1	12/2005	Omi
2005/0154578	A1	7/2005	Tong et al.	2005/0288936	A1	12/2005	Busayapongchai et al.
2005/0154580	A1	7/2005	Horowitz et al.	2005/0289458	A1	12/2005	Kylmanen
2005/0154591	A1	7/2005	Lecoeuche	2005/0289463	A1	12/2005	Wu et al.
2005/0159939	A1	7/2005	Mohler et al.	2006/0001652	A1	1/2006	Chiu et al.
2005/0159957	A1	7/2005	Roth et al.	2006/0004570	A1	1/2006	Ju et al.
2005/0162395	A1	7/2005	Unruh	2006/0004640	A1	1/2006	Swierczek
2005/0165015	A1	7/2005	Ncube et al.	2006/0004744	A1	1/2006	Nevidomski et al.
2005/0165607	A1	7/2005	Di Fabbrizio et al.	2006/0007174	A1	1/2006	Shen
2005/0166153	A1	7/2005	Eytchison et al.	2006/0009973	A1	1/2006	Nguyen et al.
2005/0171766	A1	8/2005	Albesano et al.	2006/0013414	A1	1/2006	Shih
2005/0171779	A1	8/2005	Joublin	2006/0013446	A1	1/2006	Stephens
2005/0177445	A1	8/2005	Church	2006/0015317	A1	1/2006	Nakagawa
2005/0181770	A1	8/2005	Helferich	2006/0015326	A1	1/2006	Mori et al.
2005/0182616	A1	8/2005	Kotipalli	2006/0015341	A1	1/2006	Baker
2005/0182627	A1	8/2005	Tanaka et al.	2006/0015484	A1	1/2006	Weng et al.
2005/0182628	A1	8/2005	Choi	2006/0015819	A1	1/2006	Hawkins et al.
2005/0182629	A1	8/2005	Coorman et al.	2006/0018446	A1	1/2006	Schmandt et al.
2005/0182630	A1	8/2005	Miro et al.	2006/0018492	A1	1/2006	Chiu et al.
2005/0182765	A1	8/2005	Liddy	2006/0020471	A1*	1/2006	Ju G10L 15/22 704/275
2005/0184958	A1	8/2005	Gnanamgari et al.	2006/0020890	A1	1/2006	Kroll et al.
2005/0185779	A1	8/2005	Toms	2006/0025999	A1	2/2006	Feng et al.
2005/0187767	A1	8/2005	Godden	2006/0026233	A1	2/2006	Tenembaum et al.
2005/0187770	A1	8/2005	Kompe et al.	2006/0026521	A1	2/2006	Hotelling et al.
2005/0187773	A1	8/2005	Filoche et al.	2006/0026535	A1	2/2006	Hotelling et al.
2005/0190059	A1	9/2005	Wehrenberg	2006/0026536	A1	2/2006	Hotelling et al.
2005/0190970	A1	9/2005	Griffin	2006/0033724	A1	2/2006	Chaudhri et al.
2005/0190973	A1	9/2005	Kristensson et al.	2006/0035632	A1	2/2006	Sorvari et al.
2005/0191159	A1	9/2005	Benko	2006/0036946	A1	2/2006	Radtke et al.
2005/0192795	A1	9/2005	Lam et al.	2006/0041424	A1	2/2006	Todhunter et al.
2005/0192801	A1	9/2005	Lewis et al.	2006/0041431	A1	2/2006	Maes
2005/0192807	A1	9/2005	Emam et al.	2006/0041549	A1	2/2006	Gundersen et al.
2005/0192812	A1	9/2005	Buchholz et al.	2006/0041590	A1	2/2006	King et al.
2005/0195077	A1	9/2005	Mcculloch et al.	2006/0041926	A1	2/2006	Istvan et al.
				2006/0047632	A1	3/2006	Zhang
				2006/0050865	A1	3/2006	Kortum et al.
				2006/0052141	A1	3/2006	Suzuki

(56)

References Cited

U.S. PATENT DOCUMENTS

2006/0053007	A1	3/2006	Niemisto et al.	2006/0161870	A1	7/2006	Hotelling et al.
2006/0053014	A1	3/2006	Yoshizawa	2006/0161871	A1	7/2006	Hotelling et al.
2006/0053365	A1	3/2006	Hollander et al.	2006/0161872	A1	7/2006	Rytivaara et al.
2006/0053379	A1	3/2006	Henderson et al.	2006/0165105	A1	7/2006	Shenfield et al.
2006/0053387	A1	3/2006	Ording	2006/0167676	A1	7/2006	Plumb
2006/0058999	A1	3/2006	Barker et al.	2006/0168150	A1	7/2006	Naik et al.
2006/0059424	A1	3/2006	Petri et al.	2006/0168507	A1	7/2006	Hansen
2006/0059437	A1	3/2006	Conklin	2006/0168539	A1	7/2006	Hawkins et al.
2006/0060762	A1	3/2006	Chan et al.	2006/0172720	A1	8/2006	Islam et al.
2006/0061488	A1	3/2006	Dunton	2006/0173683	A1	8/2006	Roth et al.
2006/0064693	A1	3/2006	Messer et al.	2006/0173684	A1	8/2006	Fischer et al.
2006/0067535	A1	3/2006	Culbert et al.	2006/0174207	A1	8/2006	Deshpande
2006/0067536	A1	3/2006	Culbert et al.	2006/0178868	A1	8/2006	Billerey-Mosier
2006/0069567	A1	3/2006	Tischer et al.	2006/0181519	A1	8/2006	Vernier et al.
2006/0069664	A1	3/2006	Ling et al.	2006/0183466	A1	8/2006	Lee et al.
2006/0072248	A1	4/2006	Watanabe et al.	2006/0184370	A1	8/2006	Kwak et al.
2006/0072716	A1	4/2006	Pham	2006/0184886	A1	8/2006	Chung et al.
2006/0074628	A1	4/2006	Elbaz et al.	2006/0187073	A1	8/2006	Lin et al.
2006/0074651	A1	4/2006	Arun et al.	2006/0190169	A1	8/2006	Kawai
2006/0074660	A1	4/2006	Waters et al.	2006/0190255	A1	8/2006	Fukada
2006/0074674	A1	4/2006	Zhang et al.	2006/0190269	A1	8/2006	Tessel et al.
2006/0074750	A1	4/2006	Clark et al.	2006/0190436	A1	8/2006	Richardson et al.
2006/0074898	A1	4/2006	Gavalda et al.	2006/0190577	A1	8/2006	Yamada
2006/0075429	A1	4/2006	Istvan et al.	2006/0193518	A1	8/2006	Dong
2006/0077055	A1	4/2006	Basir	2006/0194181	A1	8/2006	Rosenberg
2006/0080098	A1	4/2006	Campbell	2006/0195206	A1	8/2006	Moon et al.
2006/0085183	A1	4/2006	Jain	2006/0195323	A1	8/2006	Monne et al.
2006/0085187	A1	4/2006	Barquilla	2006/0195516	A1	8/2006	Beaupre
2006/0085465	A1	4/2006	Nori et al.	2006/0197753	A1	9/2006	Hotelling
2006/0085757	A1	4/2006	Andre et al.	2006/0197755	A1	9/2006	Bawany
2006/0093998	A1	5/2006	Vertegaal	2006/0200253	A1	9/2006	Hoffberg et al.
2006/0095265	A1	5/2006	Chu et al.	2006/0200342	A1	9/2006	Corston-Oliver et al.
2006/0095790	A1	5/2006	Nguyen et al.	2006/0200347	A1	9/2006	Kim et al.
2006/0095846	A1	5/2006	Nurmi	2006/0205432	A1	9/2006	Hawkins et al.
2006/0095848	A1	5/2006	Naik	2006/0206313	A1	9/2006	Xu et al.
2006/0097991	A1	5/2006	Hotelling et al.	2006/0206454	A1	9/2006	Forstall et al.
2006/0100848	A1	5/2006	Cozzi et al.	2006/0206724	A1	9/2006	Schaufele et al.
2006/0100849	A1	5/2006	Chan	2006/0212415	A1	9/2006	Backer et al.
2006/0101354	A1	5/2006	Hashimoto et al.	2006/0217967	A1	9/2006	Goertzen et al.
2006/0103633	A1	5/2006	Gioeli	2006/0218244	A1	9/2006	Rasmussen et al.
2006/0106592	A1	5/2006	Brockett et al.	2006/0221738	A1	10/2006	Park et al.
2006/0106594	A1	5/2006	Brockett et al.	2006/0221788	A1	10/2006	Lindahl et al.
2006/0106595	A1	5/2006	Brockett et al.	2006/0224570	A1	10/2006	Quiroga et al.
2006/0111906	A1	5/2006	Cross et al.	2006/0229802	A1	10/2006	Vertelney et al.
2006/0111909	A1	5/2006	Maes et al.	2006/0229870	A1	10/2006	Kobal
2006/0112810	A1	6/2006	Eves et al.	2006/0229876	A1	10/2006	Aaron et al.
2006/0116874	A1	6/2006	Samuelsson et al.	2006/0230350	A1	10/2006	Baluja
2006/0116877	A1	6/2006	Pickering et al.	2006/0230410	A1	10/2006	Kurganov et al.
2006/0117002	A1	6/2006	Swen	2006/0234680	A1	10/2006	Doulton
2006/0119582	A1	6/2006	Ng et al.	2006/0235550	A1	10/2006	Csicsatka et al.
2006/0122834	A1	6/2006	Bennett	2006/0235690	A1	10/2006	Tomasic et al.
2006/0122836	A1	6/2006	Cross et al.	2006/0235700	A1	10/2006	Wong et al.
2006/0129379	A1	6/2006	Ramsey et al.	2006/0235841	A1	10/2006	Betz et al.
2006/0129929	A1	6/2006	Weber et al.	2006/0236262	A1	10/2006	Bathiche et al.
2006/0130006	A1	6/2006	Chitale	2006/0239419	A1	10/2006	Joseph et al.
2006/0132812	A1	6/2006	Barnes et al.	2006/0239471	A1	10/2006	Mao et al.
2006/0135214	A1	6/2006	Zhang et al.	2006/0240866	A1	10/2006	Eilts et al.
2006/0136213	A1	6/2006	Hirose et al.	2006/0241948	A1	10/2006	Abrash et al.
2006/0136280	A1	6/2006	Cho et al.	2006/0242190	A1	10/2006	Wnek
2006/0136352	A1	6/2006	Brun et al.	2006/0246955	A1	11/2006	Nirhamo et al.
2006/0141990	A1	6/2006	Zak et al.	2006/0247931	A1	11/2006	Caskey et al.
2006/0142576	A1	6/2006	Meng et al.	2006/0252457	A1	11/2006	Schrager
2006/0142993	A1	6/2006	Menendez-Pidal et al.	2006/0253210	A1	11/2006	Rosenberg
2006/0143007	A1	6/2006	Koh et al.	2006/0253787	A1	11/2006	Fogg
2006/0143559	A1	6/2006	Spielberg et al.	2006/0256934	A1	11/2006	Mazor
2006/0143576	A1	6/2006	Gupta et al.	2006/0258376	A1	11/2006	Ewell et al.
2006/0148520	A1	7/2006	Baker et al.	2006/0262876	A1	11/2006	LaDue
2006/0149544	A1	7/2006	Hakkani-Tur et al.	2006/0265208	A1	11/2006	Assadollahi
2006/0149557	A1	7/2006	Kaneko et al.	2006/0265503	A1	11/2006	Jones et al.
2006/0149558	A1	7/2006	Kahn et al.	2006/0265648	A1	11/2006	Rainisto et al.
2006/0150087	A1	7/2006	Cronenberger et al.	2006/0271364	A1	11/2006	Mirkovic et al.
2006/0152496	A1	7/2006	Knaven	2006/0271627	A1	11/2006	Szczepanek
2006/0153040	A1	7/2006	Girish et al.	2006/0274051	A1	12/2006	Longe et al.
2006/0156252	A1	7/2006	Sheshagiri et al.	2006/0274905	A1	12/2006	Lindahl et al.
2006/0156307	A1	7/2006	Kunjithapatham et al.	2006/0277031	A1	12/2006	Ramsey et al.
				2006/0277058	A1	12/2006	J'maev et al.
				2006/0282264	A1	12/2006	Denny et al.
				2006/0282415	A1	12/2006	Shibata et al.
				2006/0282455	A1	12/2006	Lee et al.

(56)

References Cited

U.S. PATENT DOCUMENTS

2006/0286527	A1	12/2006	Morel	2007/0080936	A1	4/2007	Tsuk et al.
2006/0287864	A1	12/2006	Pusa et al.	2007/0083366	A1	4/2007	Peters
2006/0288024	A1	12/2006	Braica	2007/0083467	A1	4/2007	Lindahl et al.
2006/0291666	A1	12/2006	Ball et al.	2007/0083623	A1	4/2007	Nishimura et al.
2006/0293876	A1	12/2006	Kamatani et al.	2007/0088556	A1	4/2007	Andrew
2006/0293880	A1	12/2006	Elshishiny et al.	2007/0089132	A1	4/2007	Qureshey et al.
2006/0293886	A1	12/2006	Odell et al.	2007/0089135	A1	4/2007	Qureshey et al.
2006/0293889	A1	12/2006	Kiss et al.	2007/0093277	A1	4/2007	Cavacuiti et al.
2006/0293890	A1	12/2006	Blair et al.	2007/0094026	A1	4/2007	Ativanichayaphong et al.
2007/0003026	A1	1/2007	Hodge et al.	2007/0098195	A1	5/2007	Holmes
2007/0004451	A1	1/2007	Anderson	2007/0100206	A1	5/2007	Lin et al.
2007/0005206	A1	1/2007	Zhang et al.	2007/0100602	A1	5/2007	Kim
2007/0005849	A1	1/2007	Oliver	2007/0100619	A1	5/2007	Purho et al.
2007/0006098	A1	1/2007	Krumm et al.	2007/0100624	A1	5/2007	Weng et al.
2007/0011154	A1	1/2007	Musgrove et al.	2007/0100635	A1	5/2007	Mahajan et al.
2007/0014280	A1	1/2007	Cormier et al.	2007/0100709	A1	5/2007	Lee et al.
2007/0016563	A1	1/2007	Omoigui	2007/0100790	A1	5/2007	Cheyet et al.
2007/0016865	A1	1/2007	Johnson et al.	2007/0100814	A1	5/2007	Lee et al.
2007/0021956	A1	1/2007	Qu et al.	2007/0100883	A1	5/2007	Rose et al.
2007/0022380	A1	1/2007	Swartz et al.	2007/0106491	A1	5/2007	Carter et al.
2007/0025704	A1	2/2007	Tsukazaki et al.	2007/0106497	A1	5/2007	Ramsey et al.
2007/0026852	A1	2/2007	Logan et al.	2007/0106512	A1	5/2007	Acero et al.
2007/0027732	A1	2/2007	Hudgens	2007/0106513	A1	5/2007	Boillot et al.
2007/0028009	A1	2/2007	Robbin et al.	2007/0106657	A1	5/2007	Brzeski et al.
2007/0030824	A1	2/2007	Ribaudo et al.	2007/0106674	A1	5/2007	Agrawal et al.
2007/0032247	A1	2/2007	Shaffer et al.	2007/0106685	A1	5/2007	Houh et al.
2007/0033003	A1	2/2007	Morris	2007/0112562	A1	5/2007	Vainio et al.
2007/0033005	A1	2/2007	Cristo et al.	2007/0112568	A1	5/2007	Fingscheidt et al.
2007/0033026	A1	2/2007	Bartosik et al.	2007/0116195	A1	5/2007	Thompson et al.
2007/0033054	A1	2/2007	Snitkovskiy et al.	2007/0118351	A1	5/2007	Sumita
2007/0036117	A1	2/2007	Taube et al.	2007/0118377	A1	5/2007	Badino et al.
2007/0036286	A1	2/2007	Champlin et al.	2007/0118378	A1	5/2007	Skuratovsky
2007/0036294	A1	2/2007	Chaudhuri et al.	2007/0121846	A1	5/2007	Altberg et al.
2007/0038436	A1	2/2007	Cristo et al.	2007/0124131	A1	5/2007	Chino et al.
2007/0038452	A1	2/2007	Blair et al.	2007/0124132	A1	5/2007	Takeuchi et al.
2007/0038460	A1	2/2007	Navratil et al.	2007/0124149	A1	5/2007	Shen et al.
2007/0038609	A1	2/2007	Wu	2007/0124289	A1	5/2007	Imielinski
2007/0040813	A1	2/2007	Kushler et al.	2007/0124291	A1	5/2007	Hassan et al.
2007/0041361	A1	2/2007	Iso-Sipila	2007/0124675	A1	5/2007	Ban et al.
2007/0042812	A1	2/2007	Basir et al.	2007/0124676	A1	5/2007	Amundsen et al.
2007/0043568	A1	2/2007	Dhanakshirur et al.	2007/0127888	A1	6/2007	Hayashi et al.
2007/0043574	A1	2/2007	Coffinan et al.	2007/0128777	A1	6/2007	Yin et al.
2007/0043687	A1	2/2007	Bodart et al.	2007/0129059	A1	6/2007	Nadarajah et al.
2007/0043820	A1	2/2007	George et al.	2007/0129098	A1	6/2007	Cheng et al.
2007/0044038	A1	2/2007	Horentrup et al.	2007/0130014	A1	6/2007	Altberg et al.
2007/0046641	A1	3/2007	Lim	2007/0130128	A1	6/2007	Garg et al.
2007/0047719	A1	3/2007	Dhawan et al.	2007/0132738	A1	6/2007	Lowles et al.
2007/0050184	A1	3/2007	Drucker et al.	2007/0133771	A1	6/2007	Stifelman et al.
2007/0050191	A1	3/2007	Weider et al.	2007/0135187	A1	6/2007	Kreiner et al.
2007/0050393	A1	3/2007	Vogel et al.	2007/0135949	A1	6/2007	Snover et al.
2007/0050712	A1	3/2007	Hull et al.	2007/0136064	A1	6/2007	Carroll
2007/0052586	A1	3/2007	Horstemeyer	2007/0136071	A1	6/2007	Lee et al.
2007/0055493	A1	3/2007	Lee	2007/0136778	A1	6/2007	Birger et al.
2007/0055508	A1	3/2007	Zhao et al.	2007/0143163	A1	6/2007	Weiss et al.
2007/0055514	A1	3/2007	Beattie et al.	2007/0143376	A1	6/2007	McIntosh
2007/0055525	A1	3/2007	Kennewick et al.	2007/0149252	A1	6/2007	Jobs et al.
2007/0055529	A1	3/2007	Kanevsky et al.	2007/0150403	A1	6/2007	Mock et al.
2007/0058832	A1	3/2007	Hug et al.	2007/0150444	A1	6/2007	Chesnais et al.
2007/0060107	A1	3/2007	Day	2007/0150842	A1	6/2007	Chaudhri et al.
2007/0060114	A1	3/2007	Ramer et al.	2007/0152978	A1	7/2007	Kocienda et al.
2007/0060118	A1	3/2007	Guyette	2007/0152980	A1	7/2007	Kocienda et al.
2007/0061152	A1	3/2007	Doi	2007/0155346	A1	7/2007	Mijatovic et al.
2007/0061487	A1	3/2007	Moore et al.	2007/0156410	A1	7/2007	Stohr et al.
2007/0061712	A1	3/2007	Bodin et al.	2007/0156627	A1	7/2007	D'Alicandro
2007/0061754	A1	3/2007	Ardhanari et al.	2007/0157089	A1	7/2007	Van Os et al.
2007/0067173	A1	3/2007	Bellegarda	2007/0157268	A1	7/2007	Girish et al.
2007/0067272	A1	3/2007	Flynt et al.	2007/0162274	A1	7/2007	Ruiz et al.
2007/0072553	A1	3/2007	Barbera	2007/0162296	A1	7/2007	Altberg et al.
2007/0073540	A1	3/2007	Hirakawa et al.	2007/0162414	A1	7/2007	Horowitz et al.
2007/0073541	A1	3/2007	Tian	2007/0165003	A1	7/2007	Fux et al.
2007/0073745	A1	3/2007	Scott et al.	2007/0167136	A1	7/2007	Groth
2007/0074131	A1	3/2007	Assadollahi et al.	2007/0168922	A1	7/2007	Kaiser et al.
2007/0074617	A1	4/2007	Vergo	2007/0173233	A1	7/2007	Vander Veen et al.
2007/0075965	A1	4/2007	Huppi et al.	2007/0173267	A1	7/2007	Klassen et al.
2007/0079027	A1	4/2007	Marriott et al.	2007/0174057	A1	7/2007	Genly
				2007/0174188	A1	7/2007	Fish
				2007/0174350	A1	7/2007	Pell et al.
				2007/0174396	A1	7/2007	Kumar et al.
				2007/0179776	A1	8/2007	Segond et al.

(56)

References Cited

U.S. PATENT DOCUMENTS

2007/0179778	A1	8/2007	Gong et al.	2007/0274468	A1	11/2007	Cai
2007/0180383	A1	8/2007	Naik	2007/0276651	A1	11/2007	Bliss et al.
2007/0182595	A1	8/2007	Ghasabian	2007/0276714	A1	11/2007	Beringer
2007/0185551	A1	8/2007	Meadows et al.	2007/0276810	A1	11/2007	Rosen
2007/0185754	A1	8/2007	Schmidt	2007/0277088	A1	11/2007	Bodin et al.
2007/0185831	A1	8/2007	Churcher	2007/0281603	A1	12/2007	Nath et al.
2007/0185917	A1	8/2007	Prahlad et al.	2007/0282595	A1	12/2007	Tunning et al.
2007/0188901	A1	8/2007	Heckerman et al.	2007/0285958	A1	12/2007	Platchta et al.
2007/0192026	A1	8/2007	Lee et al.	2007/0286363	A1	12/2007	Burg et al.
2007/0192027	A1	8/2007	Lee et al.	2007/0286399	A1	12/2007	Ramamoorthy et al.
2007/0192095	A1	8/2007	Braho et al.	2007/0288238	A1	12/2007	Hetherington et al.
2007/0192105	A1	8/2007	Neeracher et al.	2007/0288241	A1	12/2007	Cross et al.
2007/0192179	A1	8/2007	Van et al.	2007/0288449	A1	12/2007	Datta et al.
2007/0192293	A1	8/2007	Swen	2007/0291108	A1	12/2007	Huber et al.
2007/0192403	A1	8/2007	Heine et al.	2007/0294077	A1	12/2007	Narayanan et al.
2007/0192744	A1	8/2007	Reponen	2007/0294078	A1	12/2007	Kim et al.
2007/0198267	A1	8/2007	Jones et al.	2007/0294083	A1	12/2007	Bellegarda et al.
2007/0198269	A1	8/2007	Braho et al.	2007/0294199	A1	12/2007	Nelken et al.
2007/0198273	A1	8/2007	Hennecke	2007/0294263	A1	12/2007	Punj et al.
2007/0198566	A1	8/2007	Sustik	2007/0299664	A1	12/2007	Peters et al.
2007/0203869	A1	8/2007	Ramsey et al.	2007/0299831	A1	12/2007	Williams et al.
2007/0203955	A1	8/2007	Pomerantz	2007/0300140	A1	12/2007	Makela et al.
2007/0207785	A1	9/2007	Chatterjee et al.	2007/0300185	A1	12/2007	Macbeth et al.
2007/0208555	A1	9/2007	Blass et al.	2008/0001785	A1	1/2008	Elizarov et al.
2007/0208569	A1	9/2007	Subramanian et al.	2008/0010355	A1	1/2008	Vieri et al.
2007/0208579	A1	9/2007	Peterson	2008/0010605	A1	1/2008	Frank et al.
2007/0208726	A1	9/2007	Krishnaprasad et al.	2008/0012950	A1	1/2008	Lee et al.
2007/0211071	A1	9/2007	Slotznick et al.	2008/0013751	A1	1/2008	Hiselius
2007/0213099	A1	9/2007	Bast	2008/0015863	A1	1/2008	Agapi et al.
2007/0213857	A1	9/2007	Bodin et al.	2008/0015864	A1	1/2008	Ross et al.
2007/0213984	A1	9/2007	Ativanichayaphong et al.	2008/0016575	A1	1/2008	Vincent et al.
2007/0213986	A1	9/2007	Bodin et al.	2008/0021708	A1	1/2008	Bennett et al.
2007/0217693	A1	9/2007	Kretzschmar, Jr.	2008/0021886	A1	1/2008	Wang-Aryattanwanich et al.
2007/0219645	A1	9/2007	Thomas et al.	2008/0022208	A1	1/2008	Morse
2007/0219777	A1	9/2007	Chu et al.	2008/0027726	A1	1/2008	Hansen et al.
2007/0219786	A1	9/2007	Isaac et al.	2008/0031475	A1	2/2008	Goldstein
2007/0219801	A1	9/2007	Sundaram et al.	2008/0033719	A1	2/2008	Hall et al.
2007/0219803	A1	9/2007	Chiu et al.	2008/0034032	A1	2/2008	Healey et al.
2007/0219983	A1	9/2007	Fish	2008/0034044	A1	2/2008	Bhakta et al.
2007/0225980	A1	9/2007	Sumita	2008/0036743	A1	2/2008	Westerman et al.
2007/0225984	A1	9/2007	Milstein et al.	2008/0040339	A1	2/2008	Zhou et al.
2007/0226652	A1	9/2007	Kikuchi et al.	2008/0042970	A1	2/2008	Liang et al.
2007/0229323	A1	10/2007	Plachta et al.	2008/0043936	A1	2/2008	Liebermann
2007/0230729	A1	10/2007	Naylor et al.	2008/0043943	A1	2/2008	Sipher et al.
2007/0233484	A1	10/2007	Coelho et al.	2008/0046239	A1	2/2008	Boo
2007/0233487	A1	10/2007	Cohen et al.	2008/0046250	A1	2/2008	Agapi et al.
2007/0233490	A1	10/2007	Yao	2008/0046422	A1	2/2008	Lee et al.
2007/0233497	A1	10/2007	Paek et al.	2008/0046820	A1	2/2008	Lee et al.
2007/0233692	A1	10/2007	Lisa et al.	2008/0046948	A1	2/2008	Verosub
2007/0233725	A1*	10/2007	Michmerhuizen G10L 13/08	2008/0048908	A1	2/2008	Sato
2007/0238488	A1	10/2007	Scott	2008/0050027	A1	2/2008	Bashyam et al.
2007/0238489	A1	10/2007	Scott	2008/0052063	A1	2/2008	Bennett et al.
2007/0238520	A1	10/2007	Kacmarcik	2008/0052073	A1	2/2008	Goto et al.
2007/0239429	A1	10/2007	Johnson et al.	2008/0052077	A1	2/2008	Bennett et al.
2007/0239453	A1	10/2007	Paek et al.	2008/0052080	A1	2/2008	Narayanan et al.
2007/0240043	A1	10/2007	Fux et al.	2008/0052262	A1	2/2008	Kosinov et al.
2007/0240044	A1	10/2007	Fux et al.	2008/0055194	A1	3/2008	Baudino et al.
2007/0240045	A1	10/2007	Fux et al.	2008/0056459	A1	3/2008	Vallier et al.
2007/0240172	A1	10/2007	Banker et al.	2008/0056579	A1	3/2008	Guha
2007/0241885	A1	10/2007	Clipsham et al.	2008/0057922	A1	3/2008	Kokes et al.
2007/0244702	A1	10/2007	Kahn et al.	2008/0059190	A1	3/2008	Chu et al.
2007/0244976	A1	10/2007	Carroll et al.	2008/0059200	A1	3/2008	Puli
2007/0247441	A1	10/2007	Kim et al.	2008/0059876	A1	3/2008	Hantler et al.
2007/0255435	A1	11/2007	Cohen et al.	2008/0062141	A1	3/2008	Chaudhri
2007/0255979	A1	11/2007	Deily et al.	2008/0065382	A1	3/2008	Gerl et al.
2007/0257890	A1	11/2007	Hotelling et al.	2008/0065387	A1	3/2008	Cross et al.
2007/0258642	A1	11/2007	Thota	2008/0071529	A1	3/2008	Silverman et al.
2007/0260460	A1	11/2007	Hyatt	2008/0071544	A1	3/2008	Beaufays et al.
2007/0260595	A1	11/2007	Beatty et al.	2008/0071742	A1	3/2008	Yang et al.
2007/0260822	A1	11/2007	Adams	2008/0072143	A1	3/2008	Assadollahi
2007/0261080	A1	11/2007	Saetti	2008/0075296	A1	3/2008	Lindhahl et al.
2007/0265831	A1	11/2007	Dinur et al.	2008/0076972	A1	3/2008	Dorogusker et al.
2007/0265850	A1	11/2007	Kennewick et al.	2008/0077310	A1	3/2008	Murlidar et al.
2007/0271104	A1	11/2007	McKay	2008/0077384	A1	3/2008	Agapi et al.
2007/0271510	A1	11/2007	Grigoriu et al.	2008/0077386	A1	3/2008	Gao et al.
				2008/0077391	A1	3/2008	Chino et al.
				2008/0077393	A1	3/2008	Gao et al.
				2008/0077406	A1	3/2008	Ganong, III
				2008/0077859	A1	3/2008	Schabes et al.

(56)

References Cited

U.S. PATENT DOCUMENTS

- | | | | | | |
|-----------------|--------|-------------------|------------------|---------|---------------------------------------|
| 2008/0079566 A1 | 4/2008 | Singh et al. | 2008/0154828 A1 | 6/2008 | Antebi et al. |
| 2008/0080411 A1 | 4/2008 | Cole | 2008/0157867 A1 | 7/2008 | Krah |
| 2008/0082332 A1 | 4/2008 | Mallett et al. | 2008/0161113 A1 | 7/2008 | Hansen et al. |
| 2008/0082338 A1 | 4/2008 | O'Neil et al. | 2008/0162120 A1 | 7/2008 | Mactavish et al. |
| 2008/0082390 A1 | 4/2008 | Hawkins et al. | 2008/0162137 A1 | 7/2008 | Saitoh et al. |
| 2008/0082576 A1 | 4/2008 | Bodin et al. | 2008/0162471 A1 | 7/2008 | Bernard |
| 2008/0082651 A1 | 4/2008 | Singh et al. | 2008/0163119 A1 | 7/2008 | Kim et al. |
| 2008/0084974 A1 | 4/2008 | Dhanakshirur | 2008/0163131 A1 | 7/2008 | Hirai et al. |
| 2008/0085689 A1 | 4/2008 | Zellner | 2008/0165144 A1 | 7/2008 | Forstall et al. |
| 2008/0091406 A1 | 4/2008 | Baldwin et al. | 2008/0165980 A1 | 7/2008 | Pavlovic et al. |
| 2008/0091426 A1 | 4/2008 | Rempel et al. | 2008/0165994 A1 | 7/2008 | Caren et al. |
| 2008/0091428 A1 | 4/2008 | Bellegarda | 2008/0167013 A1 | 7/2008 | Novick et al. |
| 2008/0091443 A1 | 4/2008 | Strope et al. | 2008/0167858 A1 | 7/2008 | Christie et al. |
| 2008/0096531 A1 | 4/2008 | Mcquaide et al. | 2008/0167876 A1 | 7/2008 | Bakis et al. |
| 2008/0096533 A1 | 4/2008 | Manfredi et al. | 2008/0168052 A1 | 7/2008 | Ott et al. |
| 2008/0096726 A1 | 4/2008 | Riley et al. | 2008/0168366 A1 | 7/2008 | Kocienda et al. |
| 2008/0097937 A1 | 4/2008 | Hadjarian | 2008/0183473 A1 | 7/2008 | Nagano et al. |
| 2008/0098302 A1 | 4/2008 | Roose | 2008/0186960 A1 | 8/2008 | Kocheisen et al. |
| 2008/0098480 A1 | 4/2008 | Henry et al. | 2008/0189099 A1 | 8/2008 | Friedman et al. |
| 2008/0100579 A1 | 5/2008 | Robinson et al. | 2008/0189106 A1 | 8/2008 | Low et al. |
| 2008/0101584 A1 | 5/2008 | Gray et al. | 2008/0189110 A1 | 8/2008 | Freeman et al. |
| 2008/0103774 A1 | 5/2008 | White | 2008/0189114 A1 | 8/2008 | Fail et al. |
| 2008/0109222 A1 | 5/2008 | Liu | 2008/0189606 A1 | 8/2008 | Rybak |
| 2008/0109402 A1 | 5/2008 | Wang et al. | 2008/0195312 A1 | 8/2008 | Aaron et al. |
| 2008/0114480 A1 | 5/2008 | Harb | 2008/0195388 A1 | 8/2008 | Bower et al. |
| 2008/0114598 A1 | 5/2008 | Prieto et al. | 2008/0195391 A1 | 8/2008 | Marple et al. |
| 2008/0114604 A1 | 5/2008 | Wei et al. | 2008/0195601 A1 | 8/2008 | Ntoulas et al. |
| 2008/0114841 A1 | 5/2008 | Lambert | 2008/0195630 A1 | 8/2008 | Exartier et al. |
| 2008/0115084 A1 | 5/2008 | Scott et al. | 2008/0195940 A1 | 8/2008 | Gail et al. |
| 2008/0118143 A1 | 5/2008 | Gordon et al. | 2008/0200142 A1 | 8/2008 | Abdel-Kader et al. |
| 2008/0119953 A1 | 5/2008 | Reed | 2008/0201000 A1 | 8/2008 | Heikkila et al. |
| 2008/0120102 A1 | 5/2008 | Rao | 2008/0201306 A1 | 8/2008 | Cooper et al. |
| 2008/0120112 A1 | 5/2008 | Jordan et al. | 2008/0201375 A1 | 8/2008 | Khedouri et al. |
| 2008/0120196 A1 | 5/2008 | Reed et al. | 2008/0201434 A1 | 8/2008 | Holmes et al. |
| 2008/0120311 A1 | 5/2008 | Reed | 2008/0204379 A1 | 8/2008 | Perez-Noguera |
| 2008/0120312 A1 | 5/2008 | Reed | 2008/0207176 A1 | 8/2008 | Brackbill et al. |
| 2008/0120330 A1 | 5/2008 | Reed | 2008/0208585 A1 | 8/2008 | Ativanichayaphong et al. |
| 2008/0120342 A1 | 5/2008 | Reed et al. | 2008/0208587 A1 | 8/2008 | Ben-David et al. |
| 2008/0122796 A1 | 5/2008 | Jobs et al. | 2008/0208864 A1 | 8/2008 | Cucerzan et al. |
| 2008/0124695 A1 | 5/2008 | Myers et al. | 2008/0212796 A1 | 9/2008 | Denda |
| 2008/0126075 A1 | 5/2008 | Thorn et al. | 2008/0219641 A1 | 9/2008 | Sandrew et al. |
| 2008/0126077 A1 | 5/2008 | Thorn | 2008/0221866 A1 | 9/2008 | Katragadda et al. |
| 2008/0126091 A1 | 5/2008 | Clark et al. | 2008/0221879 A1 | 9/2008 | Cerra et al. |
| 2008/0126093 A1 | 5/2008 | Sivadas | 2008/0221880 A1 | 9/2008 | Cerra et al. |
| 2008/0126100 A1 | 5/2008 | Grost et al. | 2008/0221887 A1 | 9/2008 | Rose et al. |
| 2008/0126491 A1 | 5/2008 | Portele et al. | 2008/0221889 A1 | 9/2008 | Cerra et al. |
| 2008/0129520 A1 | 6/2008 | Lee | 2008/0221903 A1 | 9/2008 | Kanevsky et al. |
| 2008/0130867 A1 | 6/2008 | Bowen | 2008/0222118 A1 | 9/2008 | Scian et al. |
| 2008/0131006 A1 | 6/2008 | Oliver | 2008/0226130 A1 | 9/2008 | Kansal et al. |
| 2008/0132221 A1 | 6/2008 | Willey et al. | 2008/0228463 A1 | 9/2008 | Mori et al. |
| 2008/0132295 A1 | 6/2008 | Horowitz | 2008/0228485 A1 | 9/2008 | Owen |
| 2008/0133215 A1 | 6/2008 | Sarukkai | 2008/0228490 A1 | 9/2008 | Fischer et al. |
| 2008/0133228 A1 | 6/2008 | Rao | 2008/0228495 A1 | 9/2008 | Cross et al. |
| 2008/0133230 A1 | 6/2008 | Herforth et al. | 2008/0228496 A1 | 9/2008 | Yu et al. |
| 2008/0133241 A1 | 6/2008 | Baker et al. | 2008/0228928 A1 | 9/2008 | Donelli et al. |
| 2008/0133956 A1 | 6/2008 | Fadell | 2008/0229185 A1 | 9/2008 | Lynch |
| 2008/0140413 A1 | 6/2008 | Millman et al. | 2008/0229218 A1 | 9/2008 | Maeng |
| 2008/0140416 A1 | 6/2008 | Shostak | 2008/0235017 A1 | 9/2008 | Satomura et al. |
| 2008/0140652 A1 | 6/2008 | Millman et al. | 2008/0235023 A1 | 9/2008 | Kennewick et al. |
| 2008/0140657 A1 | 6/2008 | Azvine et al. | 2008/0235024 A1 | 9/2008 | Goldberg et al. |
| 2008/0140702 A1 | 6/2008 | Reed et al. | 2008/0235027 A1 | 9/2008 | Cross |
| 2008/0141125 A1 | 6/2008 | Ghassabian et al. | 2008/0240569 A1 | 10/2008 | Tonouchi |
| 2008/0141180 A1 | 6/2008 | Reed et al. | 2008/0242280 A1 | 10/2008 | Shapiro et al. |
| 2008/0141182 A1 | 6/2008 | Barsness et al. | 2008/0242322 A1 | 10/2008 | Scott et al. |
| 2008/0146245 A1 | 6/2008 | Appaji | 2008/0242363 A1 | 10/2008 | Onda et al. |
| 2008/0146290 A1 | 6/2008 | Sreeram et al. | 2008/0243834 A1 | 10/2008 | Rieman et al. |
| 2008/0147408 A1 | 6/2008 | Da Palma et al. | 2008/0244390 A1 | 10/2008 | Fux et al. |
| 2008/0147411 A1 | 6/2008 | Dames et al. | 2008/0244446 A1 | 10/2008 | Lefevre et al. |
| 2008/0147874 A1 | 6/2008 | Yoneda et al. | 2008/0247519 A1 | 10/2008 | Abella et al. |
| 2008/0150900 A1 | 6/2008 | Han | 2008/0247529 A1 | 10/2008 | Barton et al. |
| 2008/0154577 A1 | 6/2008 | Kim et al. | 2008/0248797 A1* | 10/2008 | Freeman H04M 1/72522
455/425 |
| 2008/0154599 A1 | 6/2008 | Muschett et al. | 2008/0249770 A1 | 10/2008 | Kim et al. |
| 2008/0154600 A1 | 6/2008 | Tian et al. | 2008/0249778 A1 | 10/2008 | Barton et al. |
| 2008/0154603 A1 | 6/2008 | Oddo | 2008/0253577 A1 | 10/2008 | Eppolito |
| 2008/0154612 A1 | 6/2008 | Evermann et al. | 2008/0254425 A1 | 10/2008 | Cohen et al. |
| | | | 2008/0255837 A1 | 10/2008 | Kahn et al. |
| | | | 2008/0255842 A1 | 10/2008 | Simhi et al. |
| | | | 2008/0255845 A1 | 10/2008 | Bennett |

(56)

References Cited

U.S. PATENT DOCUMENTS

2008/0256613	A1	10/2008	Grover	2009/0055168	A1	2/2009	Wu et al.
2008/0259022	A1	10/2008	Mansfield et al.	2009/0055175	A1	2/2009	Terrell et al.
2008/0262828	A1	10/2008	Och et al.	2009/0055179	A1	2/2009	Cho et al.
2008/0262838	A1	10/2008	Nurminen et al.	2009/0055186	A1	2/2009	Lance et al.
2008/0262846	A1	10/2008	Burns et al.	2009/0055380	A1	2/2009	Peng et al.
2008/0263139	A1	10/2008	Martin	2009/0055381	A1	2/2009	Wu et al.
2008/0267416	A1	10/2008	Goldstein et al.	2009/0055648	A1	2/2009	Kim et al.
2008/0270118	A1	10/2008	Kuo et al.	2009/0058823	A1	3/2009	Kocienda
2008/0270138	A1	10/2008	Knight et al.	2009/0058860	A1	3/2009	Fong et al.
2008/0270139	A1	10/2008	Shi et al.	2009/0060351	A1	3/2009	Li et al.
2008/0270140	A1	10/2008	Hertz et al.	2009/0060472	A1	3/2009	Bull et al.
2008/0270151	A1	10/2008	Mahoney et al.	2009/0063974	A1	3/2009	Bull et al.
2008/0270344	A1	10/2008	Yurick et al.	2009/0064031	A1	3/2009	Bull et al.
2008/0273672	A1	11/2008	Didcock et al.	2009/0070097	A1	3/2009	Wu et al.
2008/0277473	A1	11/2008	Kotlarsky et al.	2009/0070102	A1	3/2009	Maegawa
2008/0281510	A1	11/2008	Shahine	2009/0070109	A1	3/2009	Didcock et al.
2008/0281582	A1	11/2008	Hsu et al.	2009/0070114	A1	3/2009	Staszak
2008/0288259	A1	11/2008	Chambers et al.	2009/0074214	A1	3/2009	Bradford et al.
2008/0288460	A1	11/2008	Poniatowski et al.	2009/0076792	A1	3/2009	Lawson-Tancred
2008/0292112	A1	11/2008	Valenzuela et al.	2009/0076796	A1	3/2009	Daraselvia
2008/0294418	A1	11/2008	Cleary et al.	2009/0076798	A1	3/2009	Oh et al.
2008/0294517	A1	11/2008	Hill	2009/0076819	A1	3/2009	Wouters et al.
2008/0294651	A1	11/2008	Masuyama et al.	2009/0076821	A1	3/2009	Brenner et al.
2008/0294981	A1	11/2008	Balzano et al.	2009/0076825	A1	3/2009	Bradford et al.
2008/0298563	A1	12/2008	Rondeau et al.	2009/0077165	A1	3/2009	Rhodes et al.
2008/0298766	A1	12/2008	Wen et al.	2009/0079622	A1	3/2009	Seshadri et al.
2008/0299523	A1	12/2008	Chai et al.	2009/0083034	A1	3/2009	Hernandez et al.
2008/0300871	A1	12/2008	Gilbert	2009/0083035	A1	3/2009	Huang et al.
2008/0300877	A1	12/2008	Gilbert et al.	2009/0083036	A1	3/2009	Zhao et al.
2008/0300878	A1	12/2008	Bennett	2009/0083037	A1	3/2009	Gleason et al.
2008/0301567	A1	12/2008	Martin et al.	2009/0083047	A1	3/2009	Lindahl et al.
2008/0303645	A1	12/2008	Seymour et al.	2009/0089058	A1	4/2009	Bellegarda
2008/0306727	A1	12/2008	Thurmair et al.	2009/0092239	A1	4/2009	Macwan et al.
2008/0312909	A1	12/2008	Hermansen et al.	2009/0092260	A1	4/2009	Powers
2008/0312928	A1	12/2008	Goebel et al.	2009/0092261	A1	4/2009	Bard
2008/0313335	A1	12/2008	Jung et al.	2009/0092262	A1	4/2009	Costa et al.
2008/0316183	A1	12/2008	Westerman et al.	2009/0094029	A1	4/2009	Koch et al.
2008/0319735	A1	12/2008	Kambhatla et al.	2009/0094033	A1	4/2009	Mozer et al.
2008/0319738	A1	12/2008	Liu et al.	2009/0097634	A1	4/2009	Nambiar et al.
2008/0319753	A1	12/2008	Hancock	2009/0097637	A1	4/2009	Boscher et al.
2008/0319763	A1	12/2008	Di Fabbri et al.	2009/0098903	A1	4/2009	Donaldson et al.
2008/0319783	A1	12/2008	Yao et al.	2009/0100049	A1	4/2009	Cao
2009/0003115	A1	1/2009	Lindahl et al.	2009/0100454	A1	4/2009	Weber
2009/0005012	A1	1/2009	Van Heugten	2009/0104898	A1	4/2009	Harris
2009/0005891	A1	1/2009	Batson et al.	2009/0106026	A1	4/2009	Ferrieux
2009/0006096	A1	1/2009	Li et al.	2009/0106376	A1	4/2009	Tom et al.
2009/0006097	A1	1/2009	Etezadi et al.	2009/0106397	A1	4/2009	O'Keefe
2009/0006099	A1	1/2009	Sharpe et al.	2009/0112572	A1	4/2009	Thorn
2009/0006100	A1	1/2009	Badger et al.	2009/0112576	A1	4/2009	Jackson et al.
2009/0006343	A1	1/2009	Platt et al.	2009/0112592	A1	4/2009	Candelore et al.
2009/0006345	A1	1/2009	Platt et al.	2009/0112677	A1	4/2009	Rhett
2009/0006488	A1	1/2009	Lindahl et al.	2009/0112892	A1	4/2009	Cardie et al.
2009/0006671	A1	1/2009	Batson et al.	2009/0119587	A1	5/2009	Allen et al.
2009/0007001	A1	1/2009	Morin et al.	2009/0123021	A1	5/2009	Jung et al.
2009/0011709	A1	1/2009	Akasaka et al.	2009/0123071	A1	5/2009	Iwasaki
2009/0012748	A1	1/2009	Beish et al.	2009/0125477	A1	5/2009	Lu et al.
2009/0012775	A1	1/2009	El Hady et al.	2009/0125602	A1	5/2009	Bhatia et al.
2009/0018828	A1	1/2009	Nakadai et al.	2009/0125947	A1	5/2009	Ibaraki
2009/0018829	A1	1/2009	Kuperstein	2009/0128505	A1	5/2009	Partridge et al.
2009/0018834	A1	1/2009	Cooper et al.	2009/0132253	A1	5/2009	Bellegarda
2009/0018835	A1	1/2009	Cooper et al.	2009/0132255	A1*	5/2009	Lu G10L 15/22 704/275
2009/0018839	A1	1/2009	Cooper et al.	2009/0137286	A1	5/2009	Luke et al.
2009/0018840	A1	1/2009	Lutz et al.	2009/0138263	A1	5/2009	Shozakai et al.
2009/0022329	A1	1/2009	Mahowald	2009/0138736	A1	5/2009	Chin
2009/0024595	A1	1/2009	Chen	2009/0138828	A1	5/2009	Schultz et al.
2009/0028435	A1	1/2009	Wu et al.	2009/0144049	A1	6/2009	Haddad et al.
2009/0030800	A1	1/2009	Grois	2009/0144428	A1	6/2009	Bowater et al.
2009/0030978	A1	1/2009	Johnson et al.	2009/0144609	A1	6/2009	Liang et al.
2009/0043580	A1	2/2009	Mozer et al.	2009/0146848	A1	6/2009	Ghassabian
2009/0043583	A1	2/2009	Agapi et al.	2009/0150147	A1	6/2009	Jacoby et al.
2009/0043763	A1	2/2009	Peng	2009/0150156	A1	6/2009	Kennewick et al.
2009/0044094	A1	2/2009	Rapp et al.	2009/0152349	A1	6/2009	Bonev et al.
2009/0048821	A1	2/2009	Yam et al.	2009/0153288	A1	6/2009	Hope et al.
2009/0048845	A1	2/2009	Burckart et al.	2009/0154669	A1	6/2009	Wood et al.
2009/0049067	A1	2/2009	Murray	2009/0157382	A1	6/2009	Bar
				2009/0157384	A1	6/2009	Toutanova et al.
				2009/0157401	A1	6/2009	Bennett
				2009/0158200	A1	6/2009	Palahnuk et al.

(56)

References Cited

U.S. PATENT DOCUMENTS

2009/0158323	A1	6/2009	Bober et al.	2009/0249247	A1	10/2009	Tseng et al.
2009/0158423	A1	6/2009	Orlassino et al.	2009/0252350	A1	10/2009	Seguin
2009/0160803	A1	6/2009	Hashimoto	2009/0253457	A1	10/2009	Seguin
2009/0163243	A1	6/2009	Barbera	2009/0253463	A1	10/2009	Shin et al.
2009/0164301	A1	6/2009	O'Sullivan et al.	2009/0254339	A1	10/2009	Seguin
2009/0164441	A1	6/2009	Cheyner	2009/0254345	A1	10/2009	Fleizach et al.
2009/0164655	A1	6/2009	Pettersson et al.	2009/0254819	A1	10/2009	Song et al.
2009/0164937	A1	6/2009	Alviar et al.	2009/0254823	A1	10/2009	Barrett
2009/0167508	A1	7/2009	Fadell et al.	2009/0259475	A1	10/2009	Yamagami et al.
2009/0167509	A1	7/2009	Fadell et al.	2009/0259969	A1	10/2009	Pallakoff
2009/0171578	A1	7/2009	Kim et al.	2009/0265171	A1	10/2009	Davis
2009/0171662	A1	7/2009	Huang et al.	2009/0265368	A1	10/2009	Crider et al.
2009/0171664	A1	7/2009	Kennewick et al.	2009/0271109	A1	10/2009	Lee et al.
2009/0172108	A1	7/2009	Singh	2009/0271175	A1	10/2009	Bodin et al.
2009/0172542	A1	7/2009	Girish et al.	2009/0271176	A1	10/2009	Bodin et al.
2009/0174667	A1	7/2009	Kocienda et al.	2009/0271178	A1	10/2009	Bodin et al.
2009/0174677	A1	7/2009	Gehani et al.	2009/0271188	A1	10/2009	Agapi et al.
2009/0177300	A1	7/2009	Lee	2009/0271189	A1	10/2009	Agapi et al.
2009/0177461	A1	7/2009	Ehsani et al.	2009/0274315	A1	11/2009	Carnes et al.
2009/0177966	A1	7/2009	Chaudhri	2009/0281789	A1	11/2009	Waibel et al.
2009/0182445	A1	7/2009	Girish et al.	2009/0284482	A1	11/2009	Chin
2009/0182549	A1	7/2009	Anisimovich et al.	2009/0286514	A1	11/2009	Lichorowic et al.
2009/0182702	A1	7/2009	Miller	2009/0287583	A1	11/2009	Holmes
2009/0183070	A1	7/2009	Robbins	2009/0290718	A1	11/2009	Kahn et al.
2009/0187402	A1	7/2009	Scholl	2009/0292987	A1	11/2009	Sorenson
2009/0187577	A1	7/2009	Reznik et al.	2009/0296552	A1	12/2009	Hicks et al.
2009/0187950	A1	7/2009	Nicas et al.	2009/0298474	A1	12/2009	George
2009/0191895	A1	7/2009	Singh et al.	2009/0298529	A1	12/2009	Mahajan
2009/0192782	A1	7/2009	Drewes	2009/0299745	A1	12/2009	Kennewick et al.
2009/0192787	A1	7/2009	Roon	2009/0299849	A1	12/2009	Cao et al.
2009/0192798	A1	7/2009	Basson et al.	2009/0300391	A1	12/2009	Jessup et al.
2009/0198497	A1	8/2009	Kwon	2009/0300488	A1	12/2009	Salamon et al.
2009/0204409	A1	8/2009	Mozer et al.	2009/0304198	A1	12/2009	Herre et al.
2009/0204478	A1	8/2009	Kaib et al.	2009/0305203	A1	12/2009	Okumura et al.
2009/0204596	A1	8/2009	Brun et al.	2009/0306967	A1	12/2009	Nicolov et al.
2009/0204601	A1	8/2009	Grasset	2009/0306969	A1	12/2009	Goud et al.
2009/0204620	A1	8/2009	Thione et al.	2009/0306979	A1	12/2009	Jaiswal et al.
2009/0210230	A1	8/2009	Schwarz et al.	2009/0306980	A1	12/2009	Shin
2009/0210232	A1	8/2009	Sanchez et al.	2009/0306981	A1	12/2009	Cromack et al.
2009/0213134	A1	8/2009	Stephanick et al.	2009/0306985	A1	12/2009	Roberts et al.
2009/0215466	A1	8/2009	Ahl et al.	2009/0306988	A1	12/2009	Chen et al.
2009/0215503	A1	8/2009	Zhang et al.	2009/0306989	A1	12/2009	Kaji
2009/0216396	A1	8/2009	Yamagata	2009/0307162	A1	12/2009	Bui et al.
2009/0216528	A1	8/2009	Gemello et al.	2009/0307201	A1	12/2009	Dunning et al.
2009/0216540	A1	8/2009	Tessel et al.	2009/0307584	A1	12/2009	Davidson et al.
2009/0216704	A1	8/2009	Zheng et al.	2009/0307594	A1	12/2009	Kosonen et al.
2009/0219166	A1	9/2009	MacFarlane et al.	2009/0313014	A1	12/2009	Shin et al.
2009/0221274	A1	9/2009	Venkatakrishnan et al.	2009/0313020	A1	12/2009	Koivunen
2009/0222257	A1	9/2009	Sumita et al.	2009/0313023	A1	12/2009	Jones
2009/0222270	A2	9/2009	Likens et al.	2009/0313026	A1	12/2009	Coffman et al.
2009/0222488	A1	9/2009	Boerries et al.	2009/0313544	A1	12/2009	Wood et al.
2009/0228126	A1	9/2009	Spielberg et al.	2009/0313564	A1	12/2009	Rottler et al.
2009/0228273	A1	9/2009	Wang et al.	2009/0316943	A1	12/2009	Frigola Munoz et al.
2009/0228277	A1	9/2009	Bonforte et al.	2009/0318119	A1	12/2009	Basir et al.
2009/0228281	A1	9/2009	Singleton et al.	2009/0318198	A1	12/2009	Carroll
2009/0228439	A1	9/2009	Manolescu et al.	2009/0319257	A1	12/2009	Blume et al.
2009/0228792	A1	9/2009	Van Os et al.	2009/0319266	A1	12/2009	Brown et al.
2009/0228842	A1	9/2009	Westerman et al.	2009/0326923	A1	12/2009	Yan et al.
2009/0234638	A1	9/2009	Ranjan et al.	2009/0326936	A1	12/2009	Nagashima
2009/0234651	A1	9/2009	Basir et al.	2009/0326938	A1	12/2009	Marila et al.
2009/0234655	A1	9/2009	Kwon	2009/0326949	A1	12/2009	Douthitt et al.
2009/0235280	A1	9/2009	Tannier et al.	2009/0327977	A1	12/2009	Bachfischer et al.
2009/0239202	A1	9/2009	Stone	2010/0004918	A1	1/2010	Lee et al.
2009/0239552	A1	9/2009	Churchill et al.	2010/0004931	A1	1/2010	Ma et al.
2009/0240485	A1	9/2009	Dalal et al.	2010/0005081	A1	1/2010	Bennett
2009/0241054	A1	9/2009	Hendricks	2010/0010803	A1	1/2010	Ishikawa et al.
2009/0241760	A1	10/2009	Georges	2010/0010814	A1	1/2010	Patel
2009/0247237	A1	10/2009	Mittleman et al.	2010/0013760	A1	1/2010	Hirai et al.
2009/0248182	A1	10/2009	Logan et al.	2010/0013796	A1	1/2010	Abileah et al.
2009/0248395	A1	10/2009	Alewine et al.	2010/0017212	A1	1/2010	Attwater et al.
2009/0248402	A1	10/2009	Ito et al.	2010/0017382	A1	1/2010	Katragadda et al.
2009/0248420	A1	10/2009	Basir et al.	2010/0019834	A1	1/2010	Zerbe et al.
2009/0248422	A1	10/2009	Li et al.	2010/0023318	A1	1/2010	Lemoine
2009/0248456	A1	10/2009	Fahmy et al.	2010/0023320	A1	1/2010	Di Cristo et al.
2009/0249198	A1	10/2009	Davis et al.	2010/0023331	A1	1/2010	Duta et al.
				2010/0026526	A1	2/2010	Yokota
				2010/0030549	A1	2/2010	Lee et al.
				2010/0030928	A1	2/2010	Conroy et al.
				2010/0031143	A1	2/2010	Rao et al.

(56)

References Cited

U.S. PATENT DOCUMENTS

- | | | | | | |
|-----------------|--------|-------------------|------------------|---------|-------------------------------------|
| 2010/0036653 A1 | 2/2010 | Kim et al. | 2010/0131899 A1 | 5/2010 | Hubert |
| 2010/0036655 A1 | 2/2010 | Cecil et al. | 2010/0138215 A1 | 6/2010 | Williams |
| 2010/0036660 A1 | 2/2010 | Bennett | 2010/0138224 A1 | 6/2010 | Bedingfield, Sr. |
| 2010/0037183 A1 | 2/2010 | Miyashita et al. | 2010/0138416 A1 | 6/2010 | Bellotti |
| 2010/0042400 A1 | 2/2010 | Block et al. | 2010/0138680 A1 | 6/2010 | Brisebois et al. |
| 2010/0042576 A1 | 2/2010 | Roettger et al. | 2010/0138759 A1 | 6/2010 | Roy |
| 2010/0046842 A1 | 2/2010 | Conwell et al. | 2010/0138798 A1 | 6/2010 | Wilson et al. |
| 2010/0049498 A1 | 2/2010 | Cao et al. | 2010/0142740 A1 | 6/2010 | Roerup |
| 2010/0049514 A1 | 2/2010 | Kennewick et al. | 2010/0145694 A1 | 6/2010 | Ju et al. |
| 2010/0050064 A1 | 2/2010 | Liu et al. | 2010/0145700 A1 | 6/2010 | Kennewick et al. |
| 2010/0054512 A1 | 3/2010 | Solum | 2010/0145707 A1 | 6/2010 | Ljolje et al. |
| 2010/0057443 A1 | 3/2010 | Di Cristo et al. | 2010/0146442 A1 | 6/2010 | Nagasaka et al. |
| 2010/0057457 A1 | 3/2010 | Ogata et al. | 2010/0150321 A1 | 6/2010 | Harris et al. |
| 2010/0057461 A1 | 3/2010 | Neubacher et al. | 2010/0153114 A1 | 6/2010 | Shih et al. |
| 2010/0057643 A1 | 3/2010 | Yang | 2010/0153115 A1 | 6/2010 | Klee et al. |
| 2010/0060646 A1 | 3/2010 | Unsal et al. | 2010/0153448 A1 | 6/2010 | Harpur et al. |
| 2010/0063804 A1 | 3/2010 | Sato et al. | 2010/0161311 A1 | 6/2010 | Massuh |
| 2010/0063825 A1 | 3/2010 | Williams et al. | 2010/0161313 A1 | 6/2010 | Karttunen |
| 2010/0063961 A1 | 3/2010 | Guiheneuf et al. | 2010/0161337 A1 | 6/2010 | Pulz et al. |
| 2010/0064113 A1 | 3/2010 | Lindahl et al. | 2010/0161554 A1 | 6/2010 | Datuashvili et al. |
| 2010/0064218 A1 | 3/2010 | Bull et al. | 2010/0164897 A1 | 7/2010 | Morin et al. |
| 2010/0064226 A1 | 3/2010 | Stefaniak et al. | 2010/0169075 A1 | 7/2010 | Raffa et al. |
| 2010/0066684 A1 | 3/2010 | Shahraray et al. | 2010/0169093 A1 | 7/2010 | Washio |
| 2010/0067723 A1 | 3/2010 | Bergmann et al. | 2010/0169097 A1 | 7/2010 | Nachman et al. |
| 2010/0067867 A1 | 3/2010 | Lin et al. | 2010/0169098 A1 | 7/2010 | Patch |
| 2010/0070281 A1 | 3/2010 | Conkie et al. | 2010/0171713 A1 | 7/2010 | Kwok et al. |
| 2010/0070521 A1 | 3/2010 | Clinchant et al. | 2010/0174544 A1 | 7/2010 | Heifets |
| 2010/0070899 A1 | 3/2010 | Hunt et al. | 2010/0175066 A1 | 7/2010 | Paik |
| 2010/0071003 A1 | 3/2010 | Bychkov et al. | 2010/0179932 A1 | 7/2010 | Yoon et al. |
| 2010/0076760 A1 | 3/2010 | Kraenzel et al. | 2010/0179991 A1 | 7/2010 | Lorch et al. |
| 2010/0076993 A1 | 3/2010 | Klawitter et al. | 2010/0180218 A1 | 7/2010 | Boston et al. |
| 2010/0077350 A1 | 3/2010 | Lim et al. | 2010/0185448 A1 | 7/2010 | Meisel |
| 2010/0079501 A1 | 4/2010 | Ikeda et al. | 2010/0185949 A1 | 7/2010 | Jaeger |
| 2010/0080398 A1 | 4/2010 | Waldmann | 2010/0191520 A1 | 7/2010 | Gruhn et al. |
| 2010/0080470 A1 | 4/2010 | Deluca et al. | 2010/0197359 A1 | 8/2010 | Harris |
| 2010/0081456 A1 | 4/2010 | Singh et al. | 2010/0199180 A1 | 8/2010 | Brichter et al. |
| 2010/0081487 A1 | 4/2010 | Chen et al. | 2010/0199215 A1 | 8/2010 | Seymour et al. |
| 2010/0082286 A1 | 4/2010 | Leung | 2010/0204986 A1 | 8/2010 | Kennewick et al. |
| 2010/0082327 A1 | 4/2010 | Rogers et al. | 2010/0211199 A1 | 8/2010 | Naik et al. |
| 2010/0082328 A1 | 4/2010 | Rogers et al. | 2010/0211379 A1 | 8/2010 | Gorman et al. |
| 2010/0082329 A1 | 4/2010 | Silverman et al. | 2010/0216509 A1 | 8/2010 | Riemer et al. |
| 2010/0082333 A1 | 4/2010 | Al-Shammari | 2010/0217604 A1* | 8/2010 | Baldwin G06Q 30/02
704/275 |
| 2010/0082346 A1 | 4/2010 | Rogers et al. | 2010/0222033 A1 | 9/2010 | Scott et al. |
| 2010/0082347 A1 | 4/2010 | Rogers et al. | 2010/0222098 A1 | 9/2010 | Garg |
| 2010/0082348 A1 | 4/2010 | Silverman et al. | 2010/0223055 A1 | 9/2010 | Mclean |
| 2010/0082349 A1 | 4/2010 | Bellegarda et al. | 2010/0223056 A1 | 9/2010 | Kadiramanathan et al. |
| 2010/0082567 A1 | 4/2010 | Rosenblatt et al. | 2010/0223131 A1 | 9/2010 | Scott et al. |
| 2010/0082970 A1 | 4/2010 | Lindahl et al. | 2010/0225599 A1 | 9/2010 | Danielsson et al. |
| 2010/0086152 A1 | 4/2010 | Rank et al. | 2010/0225809 A1 | 9/2010 | Connors et al. |
| 2010/0086153 A1 | 4/2010 | Hagen et al. | 2010/0227642 A1 | 9/2010 | Kim et al. |
| 2010/0086156 A1 | 4/2010 | Rank et al. | 2010/0228540 A1 | 9/2010 | Bennett |
| 2010/0088020 A1 | 4/2010 | Sano et al. | 2010/0228549 A1 | 9/2010 | Herman et al. |
| 2010/0088093 A1 | 4/2010 | Lee et al. | 2010/0228691 A1 | 9/2010 | Yang et al. |
| 2010/0088100 A1 | 4/2010 | Lindahl | 2010/0229082 A1 | 9/2010 | Karmarkar et al. |
| 2010/0094632 A1 | 4/2010 | Davis et al. | 2010/0229100 A1 | 9/2010 | Miller et al. |
| 2010/0098231 A1 | 4/2010 | Wohlert et al. | 2010/0231474 A1 | 9/2010 | Yamagajo et al. |
| 2010/0100212 A1 | 4/2010 | Lindahl et al. | 2010/0235167 A1 | 9/2010 | Bourdon |
| 2010/0100384 A1 | 4/2010 | Ju et al. | 2010/0235341 A1 | 9/2010 | Bennett |
| 2010/0100385 A1 | 4/2010 | Davis et al. | 2010/0235729 A1 | 9/2010 | Kocienda et al. |
| 2010/0100816 A1 | 4/2010 | Mccloskey et al. | 2010/0235732 A1 | 9/2010 | Bergman |
| 2010/0103776 A1 | 4/2010 | Chan | 2010/0235770 A1 | 9/2010 | Ording et al. |
| 2010/0106486 A1 | 4/2010 | Hua et al. | 2010/0241418 A1 | 9/2010 | Maeda et al. |
| 2010/0106498 A1 | 4/2010 | Morrison et al. | 2010/0250542 A1 | 9/2010 | Fujimaki |
| 2010/0106500 A1 | 4/2010 | McKee et al. | 2010/0250599 A1 | 9/2010 | Schmidt et al. |
| 2010/0106503 A1 | 4/2010 | Farrell et al. | 2010/0255858 A1 | 10/2010 | Juhasz |
| 2010/0114856 A1 | 5/2010 | Kuboyama | 2010/0257160 A1 | 10/2010 | Cao |
| 2010/0114887 A1 | 5/2010 | Conway et al. | 2010/0257478 A1 | 10/2010 | Longe et al. |
| 2010/0121637 A1 | 5/2010 | Roy et al. | 2010/0262599 A1 | 10/2010 | Nitz |
| 2010/0125456 A1 | 5/2010 | Weng et al. | 2010/0268537 A1 | 10/2010 | Al-Telmissani |
| 2010/0125458 A1 | 5/2010 | Franco et al. | 2010/0268539 A1 | 10/2010 | Xu et al. |
| 2010/0125460 A1 | 5/2010 | Mellott et al. | 2010/0269040 A1 | 10/2010 | Lee |
| 2010/0125811 A1 | 5/2010 | Moore et al. | 2010/0274753 A1 | 10/2010 | Liberty et al. |
| 2010/0131269 A1 | 5/2010 | Park et al. | 2010/0277579 A1 | 11/2010 | Cho et al. |
| 2010/0131273 A1 | 5/2010 | Aley-Raz et al. | 2010/0278320 A1 | 11/2010 | Arsenault et al. |
| 2010/0131498 A1 | 5/2010 | Linthicum et al. | 2010/0278453 A1 | 11/2010 | King |
| | | | 2010/0280983 A1 | 11/2010 | Cho et al. |
| | | | 2010/0281034 A1 | 11/2010 | Petrou et al. |
| | | | 2010/0286984 A1 | 11/2010 | Wandinger et al. |

(56)

References Cited

U.S. PATENT DOCUMENTS

2010/0286985	A1	11/2010	Kennewick et al.	2011/0065456	A1	3/2011	Brennan et al.
2010/0287514	A1	11/2010	Cragun et al.	2011/0066366	A1	3/2011	Ellanti et al.
2010/0290632	A1	11/2010	Lin	2011/0066468	A1	3/2011	Huang et al.
2010/0293460	A1	11/2010	Budelli	2011/0066634	A1	3/2011	Phillips et al.
2010/0295645	A1	11/2010	Falldin et al.	2011/0072492	A1	3/2011	Mohler et al.
2010/0299133	A1	11/2010	Kopparapu et al.	2011/0076994	A1	3/2011	Kim et al.
2010/0299138	A1	11/2010	Kim	2011/0077943	A1	3/2011	Miki et al.
2010/0299142	A1	11/2010	Freeman et al.	2011/0080260	A1	4/2011	Wang et al.
2010/0302056	A1	12/2010	Dutton et al.	2011/0081889	A1	4/2011	Gao et al.
2010/0304342	A1	12/2010	Zilber	2011/0082688	A1	4/2011	Kim et al.
2010/0304705	A1	12/2010	Hursey et al.	2011/0083079	A1	4/2011	Farrell et al.
2010/0305807	A1	12/2010	Basir et al.	2011/0087491	A1	4/2011	Wittenstein et al.
2010/0305947	A1	12/2010	Schwarz et al.	2011/0090078	A1	4/2011	Kim et al.
2010/0312547	A1	12/2010	Van Os et al.	2011/0093261	A1	4/2011	Angott
2010/0312566	A1	12/2010	Odinak et al.	2011/0093265	A1	4/2011	Stent et al.
2010/0318366	A1	12/2010	Sullivan et al.	2011/0093271	A1	4/2011	Bernard et al.
2010/0318576	A1	12/2010	Kim	2011/0099000	A1	4/2011	Rai et al.
2010/0322438	A1	12/2010	Siotis	2011/0103682	A1	5/2011	Chidlovskii et al.
2010/0324709	A1	12/2010	Starmen	2011/0105097	A1	5/2011	Tadayon et al.
2010/0324895	A1	12/2010	Kurzweil et al.	2011/0106736	A1	5/2011	Aharonson et al.
2010/0324896	A1	12/2010	Attwater et al.	2011/0106892	A1	5/2011	Nelson et al.
2010/0324905	A1	12/2010	Kurzweil et al.	2011/0110502	A1	5/2011	Daye et al.
2010/0325131	A1	12/2010	Dumais et al.	2011/0111724	A1	5/2011	Baptiste
2010/0325158	A1	12/2010	Oral et al.	2011/0112827	A1	5/2011	Kennewick et al.
2010/0325573	A1	12/2010	Estrada et al.	2011/0112837	A1	5/2011	Kurki-Suonio et al.
2010/0325588	A1	12/2010	Reddy et al.	2011/0112838	A1	5/2011	Adibi
2010/0330908	A1	12/2010	Maddern et al.	2011/0112921	A1	5/2011	Kennewick et al.
2010/0332220	A1	12/2010	Hursey et al.	2011/0116610	A1	5/2011	Shaw et al.
2010/0332224	A1	12/2010	Mäkelä et al.	2011/0119049	A1	5/2011	Ylonen
2010/0332235	A1	12/2010	David	2011/0119051	A1	5/2011	Li et al.
2010/0332236	A1	12/2010	Tan	2011/0119623	A1	5/2011	Kim
2010/0332280	A1	12/2010	Bradley et al.	2011/0119715	A1	5/2011	Chang et al.
2010/0332348	A1	12/2010	Cao	2011/0123004	A1	5/2011	Chang et al.
2010/0332428	A1	12/2010	Mchenry et al.	2011/0125498	A1	5/2011	Pickering et al.
2010/0332976	A1	12/2010	Fux et al.	2011/0125540	A1	5/2011	Jang et al.
2010/0333030	A1	12/2010	Johns	2011/0125701	A1	5/2011	Nair et al.
2010/0333163	A1	12/2010	Daly	2011/0130958	A1	6/2011	Stahl et al.
2011/0002487	A1	1/2011	Panther et al.	2011/0131036	A1	6/2011	DiCristo et al.
2011/0004475	A1	1/2011	Bellegarda	2011/0131038	A1	6/2011	Oyaizu et al.
2011/0009107	A1	1/2011	Cuba et al.	2011/0131045	A1	6/2011	Cristo et al.
2011/0010178	A1	1/2011	Lee et al.	2011/0137636	A1	6/2011	Srihari et al.
2011/0010644	A1	1/2011	Merrill et al.	2011/0141141	A1	6/2011	Kankainen
2011/0015928	A1	1/2011	Odell et al.	2011/0143726	A1	6/2011	de Silva
2011/0016150	A1	1/2011	Engstrom et al.	2011/0143811	A1	6/2011	Rodriguez
2011/0018695	A1	1/2011	Bells et al.	2011/0144857	A1	6/2011	Wingrove et al.
2011/0021213	A1	1/2011	Carr	2011/0144901	A1	6/2011	Wang
2011/0022292	A1	1/2011	Shen et al.	2011/0144973	A1	6/2011	Bocchieri et al.
2011/0022388	A1	1/2011	Wu et al.	2011/0144999	A1	6/2011	Jang et al.
2011/0022393	A1	1/2011	Waller et al.	2011/0145718	A1	6/2011	Ketola et al.
2011/0022394	A1	1/2011	Wide et al.	2011/0151830	A1	6/2011	Blanda et al.
2011/0022472	A1	1/2011	Zon et al.	2011/0153209	A1	6/2011	Geelen
2011/0022952	A1	1/2011	Wu et al.	2011/0153322	A1	6/2011	Kwak et al.
2011/0029616	A1	2/2011	Wang et al.	2011/0153324	A1	6/2011	Ballinger et al.
2011/0030067	A1	2/2011	Wilson	2011/0153329	A1	6/2011	Moorer
2011/0033064	A1	2/2011	Johnson et al.	2011/0153330	A1	6/2011	Yazdani et al.
2011/0034183	A1	2/2011	Haag et al.	2011/0153373	A1	6/2011	Dantzig et al.
2011/0035144	A1	2/2011	Okamoto et al.	2011/0154193	A1	6/2011	Creutz et al.
2011/0035434	A1	2/2011	Lockwood	2011/0157029	A1	6/2011	Tseng
2011/0038489	A1	2/2011	Visser et al.	2011/0161072	A1	6/2011	Terao et al.
2011/0040707	A1	2/2011	Theisen et al.	2011/0161076	A1	6/2011	Davis et al.
2011/0045841	A1	2/2011	Kuhlke et al.	2011/0161079	A1	6/2011	Gruhn et al.
2011/0047072	A1	2/2011	Ciurea	2011/0161309	A1	6/2011	Lung et al.
2011/0047149	A1	2/2011	Vaananen	2011/0161852	A1	6/2011	Vainio et al.
2011/0047161	A1	2/2011	Myaeng et al.	2011/0166851	A1	7/2011	LeBeau et al.
2011/0050591	A1	3/2011	Kim et al.	2011/0167350	A1	7/2011	Hoellwarth
2011/0050592	A1	3/2011	Kim et al.	2011/0175810	A1	7/2011	Markovic et al.
2011/0054647	A1	3/2011	Chipchase	2011/0179002	A1	7/2011	Dumitru et al.
2011/0054894	A1	3/2011	Phillips et al.	2011/0179372	A1	7/2011	Moore et al.
2011/0054901	A1	3/2011	Qin et al.	2011/0183650	A1	7/2011	Mckee et al.
2011/0055256	A1	3/2011	Phillips et al.	2011/0184721	A1	7/2011	Subramanian et al.
2011/0060584	A1	3/2011	Ferrucci et al.	2011/0184730	A1	7/2011	LeBeau et al.
2011/0060587	A1	3/2011	Phillips et al.	2011/0184736	A1	7/2011	Slotznick
2011/0060589	A1	3/2011	Weinberg et al.	2011/0184768	A1	7/2011	Norton et al.
2011/0060807	A1	3/2011	Martin et al.	2011/0185288	A1	7/2011	Gupta et al.
2011/0064387	A1	3/2011	Mendeloff et al.	2011/0191108	A1	8/2011	Friedlander
				2011/0191271	A1	8/2011	Baker et al.
				2011/0191344	A1	8/2011	Jin et al.
				2011/0195758	A1	8/2011	Damale et al.
				2011/0196670	A1	8/2011	Dang et al.

(56)

References Cited

U.S. PATENT DOCUMENTS

2011/0197128	A1	8/2011	Assadollahi et al.	2012/0022872	A1	1/2012	Gruber et al.
2011/0201385	A1	8/2011	Higginbotham et al.	2012/0022874	A1	1/2012	Lloyd et al.
2011/0201387	A1	8/2011	Paek et al.	2012/0022876	A1	1/2012	LeBeau et al.
2011/0202526	A1	8/2011	Lee et al.	2012/0022967	A1	1/2012	Bachman et al.
2011/0205149	A1	8/2011	Tom et al.	2012/0023088	A1	1/2012	Cheng et al.
2011/0208511	A1	8/2011	Sikstrom et al.	2012/0023095	A1	1/2012	Wadycki et al.
2011/0208524	A1	8/2011	Haughay	2012/0023462	A1	1/2012	Rosing et al.
2011/0209088	A1	8/2011	Hinckley et al.	2012/0029661	A1	2/2012	Jones et al.
2011/0212717	A1	9/2011	Rhoads et al.	2012/0029910	A1	2/2012	Medlock et al.
2011/0218806	A1	9/2011	Alewine et al.	2012/0034904	A1	2/2012	LeBeau et al.
2011/0218855	A1	9/2011	Cao et al.	2012/0035907	A1	2/2012	Lebeau et al.
2011/0219018	A1	9/2011	Bailey et al.	2012/0035908	A1	2/2012	Lebeau et al.
2011/0223893	A1	9/2011	Lau et al.	2012/0035924	A1	2/2012	Jitkoff et al.
2011/0224972	A1	9/2011	Millett et al.	2012/0035925	A1	2/2012	Friend et al.
2011/0228913	A1	9/2011	Cochinwala et al.	2012/0035926	A1	2/2012	Ambler
2011/0231182	A1	9/2011	Weider et al.	2012/0035931	A1	2/2012	LeBeau et al.
2011/0231184	A1	9/2011	Kerr	2012/0035932	A1	2/2012	Jitkoff et al.
2011/0231188	A1	9/2011	Kennewick et al.	2012/0036556	A1	2/2012	LeBeau et al.
2011/0231432	A1	9/2011	Sata et al.	2012/0039539	A1	2/2012	Boiman et al.
2011/0231474	A1	9/2011	Locker et al.	2012/0041752	A1	2/2012	Wang et al.
2011/0238407	A1	9/2011	Kent	2012/0042014	A1	2/2012	Desai et al.
2011/0238408	A1	9/2011	Larcheveque et al.	2012/0042343	A1	2/2012	Laligand et al.
2011/0238676	A1	9/2011	Liu et al.	2012/0053815	A1	3/2012	Montanari et al.
2011/0239111	A1	9/2011	Grover	2012/0053829	A1	3/2012	Agarwal et al.
2011/0242007	A1	10/2011	Gray et al.	2012/0053945	A1	3/2012	Gupta et al.
2011/0246471	A1	10/2011	Rakib et al.	2012/0056815	A1	3/2012	Mehra
2011/0249144	A1	10/2011	Chang	2012/0059655	A1	3/2012	Cartales
2011/0250570	A1	10/2011	Mack et al.	2012/0062473	A1	3/2012	Xiao et al.
2011/0258188	A1	10/2011	Abdalmageed et al.	2012/0066212	A1	3/2012	Jennings
2011/0260829	A1	10/2011	Lee	2012/0066581	A1	3/2012	Spalink
2011/0260861	A1	10/2011	Singh et al.	2012/0075054	A1	3/2012	Ge et al.
2011/0264643	A1	10/2011	Cao	2012/0078611	A1	3/2012	Soltani et al.
2011/0264999	A1	10/2011	Bells et al.	2012/0078624	A1	3/2012	Yook et al.
2011/0274303	A1	11/2011	Filson et al.	2012/0078627	A1	3/2012	Wagner
2011/0276595	A1	11/2011	Kirkland et al.	2012/0082317	A1	4/2012	Pance et al.
2011/0276598	A1	11/2011	Kozempel	2012/0083286	A1	4/2012	Kim et al.
2011/0276944	A1	11/2011	Bergman et al.	2012/0084086	A1	4/2012	Gilbert et al.
2011/0279368	A1	11/2011	Klein et al.	2012/0084634	A1	4/2012	Wong et al.
2011/0282663	A1	11/2011	Talwar et al.	2012/0088219	A1	4/2012	Briscoe et al.
2011/0282888	A1	11/2011	Koperski et al.	2012/0089331	A1	4/2012	Schmidt et al.
2011/0282906	A1	11/2011	Wong	2012/0108166	A1	5/2012	Hymel
2011/0283189	A1	11/2011	McCarty	2012/0108221	A1	5/2012	Thomas et al.
2011/0288852	A1	11/2011	Dymetman et al.	2012/0116770	A1	5/2012	Chen et al.
2011/0288855	A1	11/2011	Roy	2012/0117499	A1	5/2012	Mori et al.
2011/0288861	A1	11/2011	Kurzweil et al.	2012/0124126	A1	5/2012	Alcazar et al.
2011/0288863	A1	11/2011	Rasmussen	2012/0128322	A1	5/2012	Shaffer et al.
2011/0288866	A1	11/2011	Rasmussen	2012/0130709	A1	5/2012	Bocchieri et al.
2011/0298585	A1	12/2011	Barry	2012/0136572	A1	5/2012	Norton
2011/0301943	A1	12/2011	Patch	2012/0136985	A1	5/2012	Popescu et al.
2011/0302162	A1	12/2011	Xiao et al.	2012/0137367	A1	5/2012	Dupont et al.
2011/0306426	A1	12/2011	Novak et al.	2012/0149342	A1	6/2012	Cohen et al.
2011/0307241	A1	12/2011	Waibel et al.	2012/0149394	A1	6/2012	Singh et al.
2011/0307491	A1	12/2011	Fisk et al.	2012/0150544	A1	6/2012	McLoughlin et al.
2011/0307810	A1	12/2011	Hilerio et al.	2012/0150580	A1	6/2012	Norton
2011/0313775	A1	12/2011	Laligand et al.	2012/0158293	A1	6/2012	Burnham
2011/0314032	A1	12/2011	Bennett et al.	2012/0158399	A1	6/2012	Tremblay et al.
2011/0314404	A1	12/2011	Kotler et al.	2012/0158422	A1	6/2012	Burnham et al.
2011/0320187	A1	12/2011	Motik et al.	2012/0159380	A1	6/2012	Kocienda et al.
2012/0002820	A1	1/2012	Leichter	2012/0163710	A1	6/2012	Skaff et al.
2012/0005602	A1	1/2012	Anttila et al.	2012/0166196	A1	6/2012	Ju et al.
2012/0008754	A1	1/2012	Mukherjee et al.	2012/0173222	A1	7/2012	Wang et al.
2012/0010886	A1	1/2012	Razavilar	2012/0173244	A1	7/2012	Kwak et al.
2012/0011138	A1	1/2012	Dunning et al.	2012/0173464	A1	7/2012	Tur et al.
2012/0013609	A1	1/2012	Reponen et al.	2012/0174121	A1	7/2012	Treat et al.
2012/0015629	A1	1/2012	Olsen et al.	2012/0179457	A1	7/2012	Newman et al.
2012/0016658	A1	1/2012	Wu et al.	2012/0179467	A1	7/2012	Williams
2012/0016678	A1	1/2012	Gruber et al.	2012/0185237	A1	7/2012	Gajic et al.
2012/0019400	A1	1/2012	Patel et al.	2012/0185480	A1	7/2012	Ni et al.
2012/0020490	A1	1/2012	Leichter	2012/0185781	A1	7/2012	Guzman et al.
2012/0022787	A1	1/2012	LeBeau et al.	2012/0191461	A1	7/2012	Lin et al.
2012/0022857	A1	1/2012	Baldwin et al.	2012/0192096	A1	7/2012	Bowman et al.
2012/0022860	A1	1/2012	Lloyd et al.	2012/0197743	A1	8/2012	Grigg et al.
2012/0022868	A1	1/2012	LeBeau et al.	2012/0197995	A1	8/2012	Caruso
2012/0022869	A1	1/2012	Lloyd et al.	2012/0197998	A1	8/2012	Kessel et al.
2012/0022870	A1	1/2012	Kristjansson et al.	2012/0201362	A1	8/2012	Crossan et al.
				2012/0209853	A1	8/2012	Desai et al.
				2012/0209874	A1	8/2012	Wong et al.
				2012/0214141	A1	8/2012	Raya et al.
				2012/0214517	A1	8/2012	Singh et al.

(56)

References Cited

U.S. PATENT DOCUMENTS

2012/0215762	A1	8/2012	Hall et al.	2013/0030815	A1	1/2013	Madhvanath et al.
2012/0221339	A1	8/2012	Wang et al.	2013/0030955	A1	1/2013	David
2012/0221552	A1	8/2012	Reponen et al.	2013/0031476	A1	1/2013	Coin et al.
2012/0223889	A1	9/2012	Medlock et al.	2013/0035086	A1	2/2013	Chardon et al.
2012/0223936	A1	9/2012	Aughey et al.	2013/0035942	A1	2/2013	Kim et al.
2012/0232885	A1	9/2012	Barbosa et al.	2013/0035961	A1	2/2013	Yegnanarayanan
2012/0232886	A1	9/2012	Capuozzo et al.	2013/0041647	A1	2/2013	Ramerth et al.
2012/0232906	A1	9/2012	Lindahl et al.	2013/0041654	A1	2/2013	Walker et al.
2012/0239661	A1	9/2012	Giblin	2013/0041661	A1	2/2013	Lee et al.
2012/0239761	A1	9/2012	Linner et al.	2013/0041665	A1	2/2013	Jang et al.
2012/0242482	A1	9/2012	Elumalai et al.	2013/0041968	A1	2/2013	Cohen et al.
2012/0245719	A1	9/2012	Story, Jr. et al.	2013/0046544	A1	2/2013	Kay et al.
2012/0245941	A1	9/2012	Cheyer	2013/0050089	A1	2/2013	Neels et al.
2012/0245944	A1	9/2012	Gruber et al.	2013/0054550	A1	2/2013	Bolohan
2012/0246064	A1	9/2012	Balkow	2013/0054609	A1	2/2013	Rajput et al.
2012/0250858	A1	10/2012	Iqbal et al.	2013/0054613	A1	2/2013	Bishop
2012/0252367	A1	10/2012	Gaglio et al.	2013/0054675	A1	2/2013	Jenkins et al.
2012/0252540	A1	10/2012	Kirigaya	2013/0054706	A1	2/2013	Graham et al.
2012/0253785	A1	10/2012	Hamid et al.	2013/0055099	A1	2/2013	Yao et al.
2012/0254143	A1	10/2012	Varma et al.	2013/0055147	A1	2/2013	Vasudev et al.
2012/0254152	A1	10/2012	Park et al.	2013/0063611	A1	3/2013	Papakipos et al.
2012/0254290	A1	10/2012	Naaman	2013/0066832	A1	3/2013	Sheehan et al.
2012/0259615	A1	10/2012	Morin et al.	2013/0067307	A1	3/2013	Tian et al.
2012/0265528	A1	10/2012	Gruber et al.	2013/0073286	A1	3/2013	Bastea-Forte et al.
2012/0265535	A1	10/2012	Bryant-Rich et al.	2013/0080152	A1	3/2013	Brun et al.
2012/0265806	A1	10/2012	Blanchflower et al.	2013/0080162	A1	3/2013	Chang et al.
2012/0271625	A1	10/2012	Bernard	2013/0080167	A1	3/2013	Mozer
2012/0271634	A1	10/2012	Lenke	2013/0080177	A1	3/2013	Chen
2012/0271635	A1	10/2012	Ljolje	2013/0080251	A1	3/2013	Dempski
2012/0271640	A1	10/2012	Basir	2013/0085755	A1	4/2013	Bringert et al.
2012/0271676	A1	10/2012	Aravamudan et al.	2013/0085761	A1	4/2013	Bringert et al.
2012/0275377	A1	11/2012	Lehane et al.	2013/0090921	A1	4/2013	Liu et al.
2012/0284015	A1	11/2012	Drewes	2013/0091090	A1	4/2013	Spivack et al.
2012/0284027	A1	11/2012	Mallett et al.	2013/0095805	A1	4/2013	Lebeau et al.
2012/0290291	A1	11/2012	Shelley et al.	2013/0096909	A1	4/2013	Brun et al.
2012/0290300	A1	11/2012	Lee et al.	2013/0096917	A1	4/2013	Edgar et al.
2012/0295708	A1	11/2012	Hernandez-Abrego et al.	2013/0097566	A1	4/2013	Berglund
2012/0296649	A1	11/2012	Bansal et al.	2013/0097682	A1	4/2013	Zeljko et al.
2012/0296654	A1	11/2012	Hendrickson et al.	2013/0100268	A1	4/2013	Mihailidis et al.
2012/0296891	A1	11/2012	Rangan	2013/0103391	A1	4/2013	Millmore et al.
2012/0297348	A1	11/2012	Santoro	2013/0106742	A1	5/2013	Lee et al.
2012/0303369	A1	11/2012	Brush et al.	2013/0110505	A1	5/2013	Gruber et al.
2012/0303371	A1	11/2012	Labsky et al.	2013/0110515	A1	5/2013	Guzzoni et al.
2012/0304124	A1	11/2012	Chen et al.	2013/0110518	A1	5/2013	Gruber et al.
2012/0309363	A1	12/2012	Gruber et al.	2013/0110519	A1	5/2013	Cheyer et al.
2012/0310642	A1	12/2012	Cao et al.	2013/0110520	A1	5/2013	Cheyer et al.
2012/0310649	A1	12/2012	Cannistraro et al.	2013/0111330	A1	5/2013	Staikos et al.
2012/0310652	A1	12/2012	O'Sullivan	2013/0111348	A1	5/2013	Gruber et al.
2012/0310922	A1	12/2012	Johnson et al.	2013/0111487	A1	5/2013	Cheyer et al.
2012/0311478	A1	12/2012	Van Os et al.	2013/0115927	A1	5/2013	Gruber et al.
2012/0311583	A1	12/2012	Gruber et al.	2013/0117022	A1	5/2013	Chen et al.
2012/0311584	A1	12/2012	Gruber et al.	2013/0124189	A1	5/2013	Baldwin et al.
2012/0311585	A1	12/2012	Gruber et al.	2013/0132084	A1	5/2013	Stonehocker et al.
2012/0316862	A1	12/2012	Sultan et al.	2013/0132089	A1	5/2013	Fanty et al.
2012/0316878	A1	12/2012	Singleton et al.	2013/0132871	A1	5/2013	Zeng et al.
2012/0317194	A1	12/2012	Tian	2013/0141551	A1	6/2013	Kim
2012/0317498	A1	12/2012	Logan et al.	2013/0142317	A1	6/2013	Reynolds
2012/0321112	A1	12/2012	Schubert et al.	2013/0142345	A1	6/2013	Waldmann
2012/0324391	A1	12/2012	Tocci et al.	2013/0144594	A1	6/2013	Bangalore et al.
2012/0327009	A1	12/2012	Fleizach	2013/0144616	A1	6/2013	Bangalore et al.
2012/0329529	A1	12/2012	van der Raadt	2013/0151339	A1	6/2013	Kim et al.
2012/0330660	A1	12/2012	Jaiswal	2013/0152092	A1	6/2013	Yadgar et al.
2012/0330661	A1	12/2012	Lindahl	2013/0154811	A1	6/2013	Ferren et al.
2012/0330990	A1	12/2012	Chen et al.	2013/0158977	A1	6/2013	Senior
2013/0005405	A1	1/2013	Prociw	2013/0165232	A1	6/2013	Nelson et al.
2013/0006633	A1	1/2013	Grokop et al.	2013/0166303	A1	6/2013	Chang et al.
2013/0006637	A1	1/2013	Kanevsky et al.	2013/0166442	A1	6/2013	Nakajima et al.
2013/0006638	A1	1/2013	Lindahl	2013/0170738	A1	7/2013	Capuozzo et al.
2013/0007648	A1	1/2013	Gamon et al.	2013/0172022	A1	7/2013	Seymour et al.
2013/0010575	A1	1/2013	He et al.	2013/0176244	A1	7/2013	Yamamoto et al.
2013/0013313	A1	1/2013	Shechtman et al.	2013/0176592	A1	7/2013	Sasaki
2013/0013319	A1	1/2013	Grant et al.	2013/0179440	A1	7/2013	Gordon
2013/0018659	A1	1/2013	Chi	2013/0183944	A1	7/2013	Mozer et al.
2013/0027875	A1	1/2013	Zhu et al.	2013/0185059	A1	7/2013	Riccardi et al.
2013/0030804	A1	1/2013	Zavaliagko et al.	2013/0185074	A1	7/2013	Gruber et al.
				2013/0185081	A1	7/2013	Cheyer et al.
				2013/0185336	A1	7/2013	Singh et al.
				2013/0187850	A1	7/2013	Schulz et al.
				2013/0191117	A1	7/2013	Atti et al.

(56)

References Cited

U.S. PATENT DOCUMENTS

2013/0197911 A1	8/2013	Wei et al.	2014/0047001 A1	2/2014	Phillips et al.
2013/0204813 A1	8/2013	Master et al.	2014/0052680 A1	2/2014	Nitz et al.
2013/0207898 A1	8/2013	Sullivan et al.	2014/0052791 A1	2/2014	Chakra et al.
2013/0218553 A1	8/2013	Fujii et al.	2014/0053082 A1	2/2014	Park et al.
2013/0218560 A1	8/2013	Hsiao et al.	2014/0057610 A1	2/2014	Olincy et al.
2013/0222249 A1	8/2013	Pasquero et al.	2014/0059030 A1	2/2014	Hakkani-Tur et al.
2013/0225128 A1	8/2013	Gomar	2014/0067361 A1	3/2014	Nikoulina et al.
2013/0231917 A1	9/2013	Naik	2014/0067371 A1	3/2014	Liensberger
2013/0234947 A1	9/2013	Kristensson et al.	2014/0067402 A1	3/2014	Kim
2013/0235987 A1	9/2013	Arroniz-Escobar et al.	2014/0068751 A1	3/2014	Last et al.
2013/0238647 A1	9/2013	Thompson	2014/0074466 A1*	3/2014	Sharifi G06F 17/30026 704/235
2013/0244615 A1	9/2013	Miller et al.	2014/0074470 A1	3/2014	Jansche et al.
2013/0246048 A1	9/2013	Nagase et al.	2014/0074472 A1	3/2014	Lin et al.
2013/0246050 A1	9/2013	Yu et al.	2014/0074815 A1	3/2014	Plimton
2013/0253911 A1	9/2013	Petri et al.	2014/0078065 A1	3/2014	Akkok et al.
2013/0253912 A1	9/2013	Medlock et al.	2014/0080428 A1	3/2014	Rhoads et al.
2013/0275117 A1	10/2013	Winer	2014/0081633 A1	3/2014	Badaskar et al.
2013/0275138 A1	10/2013	Gruber et al.	2014/0082501 A1	3/2014	Bae et al.
2013/0275164 A1	10/2013	Gruber et al.	2014/0086458 A1	3/2014	Rogers et al.
2013/0275625 A1	10/2013	Taivalsaari et al.	2014/0087711 A1	3/2014	Geyer et al.
2013/0275875 A1	10/2013	Gruber et al.	2014/0088961 A1	3/2014	Woodward et al.
2013/0275899 A1	10/2013	Schubert et al.	2014/0095171 A1	4/2014	Lynch et al.
2013/0283168 A1	10/2013	Brown et al.	2014/0095172 A1	4/2014	Cabaco et al.
2013/0289991 A1	10/2013	Eshwar et al.	2014/0095173 A1	4/2014	Lynch et al.
2013/0289993 A1	10/2013	Rao et al.	2014/0096209 A1	4/2014	Saraf et al.
2013/0289994 A1	10/2013	Newman et al.	2014/0098247 A1	4/2014	Rao et al.
2013/0291015 A1	10/2013	Pan	2014/0108017 A1	4/2014	Mason et al.
2013/0297317 A1	11/2013	Lee et al.	2014/0114554 A1	4/2014	Lagassey
2013/0297319 A1	11/2013	Kim	2014/0118155 A1	5/2014	Bowers et al.
2013/0297348 A1	11/2013	Cardoza et al.	2014/0122059 A1	5/2014	Patel et al.
2013/0304479 A1	11/2013	Teller et al.	2014/0122086 A1	5/2014	Kapur et al.
2013/0304758 A1	11/2013	Gruber et al.	2014/0122136 A1	5/2014	Jayanthi
2013/0304815 A1	11/2013	Puente et al.	2014/0122153 A1	5/2014	Truitt
2013/0305119 A1	11/2013	Kern et al.	2014/0135036 A1	5/2014	Bonanni et al.
2013/0307855 A1	11/2013	Lamb et al.	2014/0136187 A1	5/2014	Wolverton et al.
2013/0307997 A1	11/2013	O'Keefe et al.	2014/0136195 A1	5/2014	Abdossalami et al.
2013/0308922 A1	11/2013	Sano et al.	2014/0136212 A1	5/2014	Kwon et al.
2013/0311997 A1	11/2013	Gruber et al.	2014/0136946 A1	5/2014	Matas
2013/0316746 A1	11/2013	Miller et al.	2014/0142923 A1	5/2014	Jones et al.
2013/0322634 A1*	12/2013	Bennett G10L 21/00 381/17	2014/0142935 A1	5/2014	Lindahl et al.
2013/0325436 A1	12/2013	Wang et al.	2014/0143550 A1	5/2014	Ganong, III et al.
2013/0325443 A1	12/2013	Begeja et al.	2014/0143721 A1	5/2014	Suzuki et al.
2013/0325447 A1	12/2013	Levien et al.	2014/0146200 A1	5/2014	Scott et al.
2013/0325448 A1	12/2013	Levien et al.	2014/0152577 A1	6/2014	Yuen et al.
2013/0325481 A1	12/2013	Van Os et al.	2014/0155031 A1	6/2014	Lee et al.
2013/0325484 A1	12/2013	Chakladar et al.	2014/0157422 A1	6/2014	Livshits et al.
2013/0325979 A1	12/2013	Mansfield et al.	2014/0163951 A1	6/2014	Nikoulina et al.
2013/0329023 A1	12/2013	Suplee, III et al.	2014/0163953 A1	6/2014	Parikh
2013/0332159 A1	12/2013	Federighi et al.	2014/0163981 A1	6/2014	Cook et al.
2013/0332162 A1	12/2013	Keen	2014/0164532 A1	6/2014	Lynch et al.
2013/0332164 A1	12/2013	Nalk	2014/0173460 A1	6/2014	Kim
2013/0332168 A1	12/2013	Kim et al.	2014/0180499 A1	6/2014	Cooper et al.
2013/0332400 A1	12/2013	González	2014/0180689 A1	6/2014	Kim et al.
2013/0339256 A1	12/2013	Shroff	2014/0180697 A1*	6/2014	Torok G06F 17/3074 704/275
2013/0346068 A1	12/2013	Solem et al.	2014/0188477 A1	7/2014	Zhang
2013/0346347 A1	12/2013	Patterson et al.	2014/0195233 A1	7/2014	Bapat
2014/0006012 A1	1/2014	Zhou et al.	2014/0195244 A1	7/2014	Cha et al.
2014/0006025 A1	1/2014	Krishnan et al.	2014/0195251 A1	7/2014	Zeinstra et al.
2014/0006027 A1	1/2014	Kim et al.	2014/0195252 A1	7/2014	Gruber et al.
2014/0006153 A1	1/2014	Thangam et al.	2014/0203939 A1	7/2014	Harrington et al.
2014/0012580 A1	1/2014	Ganong et al.	2014/0207439 A1	7/2014	Venkatapathy et al.
2014/0012586 A1	1/2014	Rubin et al.	2014/0207446 A1*	7/2014	Klein G10L 21/10 704/233
2014/0019116 A1	1/2014	Lundberg et al.	2014/0207468 A1*	7/2014	Bartnik G10L 15/22 704/275
2014/0019133 A1	1/2014	Bao et al.	2014/0207582 A1	7/2014	Flinn et al.
2014/0028735 A1	1/2014	Williams et al.	2014/0214429 A1	7/2014	Pantel
2014/0032453 A1	1/2014	Eustice et al.	2014/0214537 A1	7/2014	Yoo et al.
2014/0033071 A1	1/2014	Gruber et al.	2014/0218372 A1	8/2014	Missig et al.
2014/0035823 A1	2/2014	Khoe et al.	2014/0222436 A1	8/2014	Binder et al.
2014/0039894 A1	2/2014	Shostak	2014/0222678 A1	8/2014	Sheets et al.
2014/0040274 A1	2/2014	Aravamudan et al.	2014/0223377 A1	8/2014	Shaw et al.
2014/0040748 A1	2/2014	Lemay et al.	2014/0223481 A1	8/2014	Fundament
2014/0040801 A1	2/2014	Patel et al.	2014/0230055 A1	8/2014	Boehl
2014/0040918 A1	2/2014	Li et al.	2014/0232656 A1	8/2014	Pasquero et al.
2014/0046934 A1	2/2014	Zhou et al.	2014/0236595 A1	8/2014	Gray
			2014/0236986 A1	8/2014	Guzman

(56)

References Cited

U.S. PATENT DOCUMENTS

2014/0237042	A1	8/2014	Ahmed et al.	2015/0006148	A1	1/2015	Goldszmit et al.
2014/0244257	A1	8/2014	Colibro et al.	2015/0006157	A1	1/2015	Andrade Silva et al.
2014/0244258	A1	8/2014	Song et al.	2015/0006178	A1	1/2015	Peng et al.
2014/0244263	A1	8/2014	Pontual et al.	2015/0006199	A1	1/2015	Snider et al.
2014/0244268	A1	8/2014	Abdelsamie et al.	2015/0012271	A1	1/2015	Peng et al.
2014/0244271	A1	8/2014	Lindahl	2015/0019219	A1	1/2015	Tzirkel-Hancock et al.
2014/0244712	A1	8/2014	Walters et al.	2015/0019221	A1	1/2015	Lee et al.
2014/0247383	A1	9/2014	Dave et al.	2015/0031416	A1	1/2015	Wells et al.
2014/0247926	A1	9/2014	Gainsboro et al.	2015/0033219	A1	1/2015	Breiner et al.
2014/0249817	A1	9/2014	Hart et al.	2015/0039292	A1	2/2015	Suleman et al.
2014/0249821	A1	9/2014	Kennewick et al.	2015/0039299	A1	2/2015	Weinstein et al.
2014/0250046	A1	9/2014	Winn et al.	2015/0039305	A1	2/2015	Huang
2014/0257815	A1	9/2014	Zhao et al.	2015/0040012	A1	2/2015	Faaborg et al.
2014/0258857	A1	9/2014	Dykstra-Erickson et al.	2015/0045003	A1	2/2015	Vora et al.
2014/0267022	A1	9/2014	Kim	2015/0045068	A1	2/2015	Soffer et al.
2014/0267599	A1	9/2014	Drouin et al.	2015/0046537	A1	2/2015	Rakib
2014/0272821	A1	9/2014	Pitschel et al.	2015/0050633	A1	2/2015	Christmas et al.
2014/0274203	A1	9/2014	Ganong et al.	2015/0058013	A1	2/2015	Pakhomov et al.
2014/0274211	A1	9/2014	Sejnoha et al.	2015/0058785	A1	2/2015	Ookawara
2014/0278343	A1	9/2014	Tran	2015/0065200	A1	3/2015	Namgung et al.
2014/0278349	A1	9/2014	Grieves et al.	2015/0066494	A1	3/2015	Salvador et al.
2014/0278379	A1	9/2014	Coccaro et al.	2015/0066496	A1	3/2015	Deoras et al.
2014/0278391	A1	9/2014	Braho et al.	2015/0066506	A1	3/2015	Romano et al.
2014/0278406	A1	9/2014	Tsumura et al.	2015/0066516	A1	3/2015	Nishikawa et al.
2014/0278413	A1	9/2014	Pitschel et al.	2015/0067485	A1	3/2015	Kim et al.
2014/0278429	A1	9/2014	Ganong, III	2015/0067822	A1	3/2015	Randall
2014/0278435	A1	9/2014	Ganong et al.	2015/0073788	A1	3/2015	Allauzen et al.
2014/0278443	A1	9/2014	Gunn et al.	2015/0073804	A1	3/2015	Senior et al.
2014/0278513	A1	9/2014	Prakash et al.	2015/0074524	A1	3/2015	Nicholson et al.
2014/0280138	A1	9/2014	Li et al.	2015/0082229	A1	3/2015	Ouyang et al.
2014/0280292	A1	9/2014	Skinder	2015/0088511	A1	3/2015	Bharadwaj et al.
2014/0280353	A1	9/2014	Delaney et al.	2015/0088514	A1	3/2015	Typrin
2014/0280450	A1	9/2014	Luna	2015/0088522	A1	3/2015	Hendrickson et al.
2014/0281983	A1	9/2014	Xian et al.	2015/0088523	A1	3/2015	Schuster
2014/0282003	A1	9/2014	Gruber et al.	2015/0095031	A1	4/2015	Conkie et al.
2014/0282007	A1	9/2014	Fleizach	2015/0095278	A1	4/2015	Flinn et al.
2014/0282045	A1	9/2014	Ayanam et al.	2015/0100316	A1	4/2015	Williams et al.
2014/0282201	A1	9/2014	Pasquero et al.	2015/0100983	A1	4/2015	Pan
2014/0282586	A1	9/2014	Shear et al.	2015/0106093	A1	4/2015	Weeks et al.
2014/0282743	A1	9/2014	Howard et al.	2015/0113407	A1	4/2015	Hoffert et al.
2014/0288990	A1	9/2014	Moore et al.	2015/0120723	A1	4/2015	Deshmukh et al.
2014/0297267	A1	10/2014	Spencer et al.	2015/0127350	A1	5/2015	Agiomyrgiannakis
2014/0297281	A1	10/2014	Togawa et al.	2015/0133109	A1	5/2015	Freeman et al.
2014/0297284	A1	10/2014	Gruber et al.	2015/0134334	A1	5/2015	Sachidanandam et al.
2014/0297288	A1	10/2014	Yu et al.	2015/0135085	A1	5/2015	Shoham et al.
2014/0304605	A1	10/2014	Ohmura et al.	2015/0135123	A1	5/2015	Carr et al.
2014/0310001	A1	10/2014	Kalns et al.	2015/0142420	A1	5/2015	Sarikaya et al.
2014/0316585	A1	10/2014	Boesveld et al.	2015/0142438	A1	5/2015	Dai et al.
2014/0317502	A1	10/2014	Brown et al.	2015/0142447	A1	5/2015	Kennewick et al.
2014/0324884	A1	10/2014	Lindahl et al.	2015/0148013	A1	5/2015	Baldwin et al.
2014/0337048	A1	11/2014	Brown et al.	2015/0149177	A1	5/2015	Kalns et al.
2014/0337266	A1	11/2014	Wolverton et al.	2015/0149182	A1	5/2015	Kalns et al.
2014/0337751	A1	11/2014	Lim et al.	2015/0149354	A1	5/2015	Mccooy
2014/0337814	A1	11/2014	Kalns et al.	2015/0149469	A1	5/2015	Xu et al.
2014/0344627	A1	11/2014	Schaub et al.	2015/0154185	A1	6/2015	Waibel
2014/0344687	A1	11/2014	Durham et al.	2015/0161370	A1	6/2015	North et al.
2014/0350924	A1	11/2014	Zurek et al.	2015/0161989	A1	6/2015	Hsu et al.
2014/0350933	A1	11/2014	Bak et al.	2015/0170664	A1	6/2015	Doherty et al.
2014/0351741	A1	11/2014	Medlock et al.	2015/0172463	A1	6/2015	Quast et al.
2014/0351760	A1	11/2014	Skory et al.	2015/0178388	A1	6/2015	Winnemoeller et al.
2014/0358519	A1	12/2014	Mirkin et al.	2015/0179176	A1	6/2015	Ryu et al.
2014/0358523	A1	12/2014	Sheth et al.	2015/0185964	A1	7/2015	Stout
2014/0365209	A1	12/2014	Evermann	2015/0186012	A1	7/2015	Coleman et al.
2014/0365214	A1	12/2014	Bayley	2015/0186110	A1	7/2015	Kannan
2014/0365216	A1	12/2014	Gruber et al.	2015/0186155	A1	7/2015	Brown et al.
2014/0365226	A1	12/2014	Sinha	2015/0186351	A1	7/2015	Hicks et al.
2014/0365227	A1	12/2014	Cash et al.	2015/0187355	A1	7/2015	Parkinson et al.
2014/0365407	A1	12/2014	Brown et al.	2015/0189362	A1	7/2015	Lee et al.
2014/0365880	A1	12/2014	Bellegarda	2015/0193379	A1	7/2015	Mehta
2014/0365885	A1	12/2014	Carson et al.	2015/0193391	A1	7/2015	Khvostichenko et al.
2014/0365895	A1	12/2014	Paulson et al.	2015/0193392	A1	7/2015	Greenblatt et al.
2014/0370817	A1	12/2014	Luna	2015/0194152	A1	7/2015	Katuri et al.
2014/0372931	A1	12/2014	Zhai et al.	2015/0195379	A1	7/2015	Zhang et al.
2014/0379334	A1	12/2014	Fry	2015/0195606	A1	7/2015	McDevitt
2015/0003797	A1	1/2015	Schmidt	2015/0199077	A1	7/2015	Zuger et al.
				2015/0199960	A1	7/2015	Huo et al.
				2015/0201064	A1	7/2015	Bells et al.
				2015/0205858	A1	7/2015	Xie et al.
				2015/0212791	A1	7/2015	Kumar et al.

(56)

References Cited

U.S. PATENT DOCUMENTS

2015/0213796	A1*	7/2015	Waltermann	G10L 15/18 704/257	2016/0034811	A1	2/2016	Paulik et al.
2015/0220507	A1	8/2015	Mohajer et al.		2016/0042735	A1	2/2016	Vibbert et al.
2015/0221304	A1	8/2015	Stewart		2016/0042748	A1	2/2016	Jain et al.
2015/0221307	A1	8/2015	Shah et al.		2016/0055422	A1	2/2016	Li
2015/0227633	A1	8/2015	Shapira		2016/0063998	A1	3/2016	Krishnamoorthy et al.
2015/0228281	A1	8/2015	Raniere		2016/0071521	A1	3/2016	Haughay
2015/0234636	A1	8/2015	Barnes, Jr.		2016/0077794	A1	3/2016	Kim et al.
2015/0234800	A1	8/2015	Patrick et al.		2016/0080165	A1	3/2016	Ehsani et al.
2015/0242091	A1	8/2015	Lu et al.		2016/0086116	A1	3/2016	Rao et al.
2015/0243278	A1	8/2015	Kibre et al.		2016/0091967	A1	3/2016	Prokofieva et al.
2015/0245154	A1	8/2015	Dadu et al.		2016/0092447	A1	3/2016	Venkataraman et al.
2015/0248651	A1	9/2015	Akutagawa et al.		2016/0093291	A1	3/2016	Kim
2015/0248886	A1	9/2015	Sarikaya et al.		2016/0093298	A1	3/2016	Naik et al.
2015/0254057	A1	9/2015	Klein et al.		2016/0093301	A1	3/2016	Bellegarda et al.
2015/0254058	A1	9/2015	Klein et al.		2016/0093304	A1	3/2016	Kim et al.
2015/0254333	A1	9/2015	Fife et al.		2016/0094979	A1	3/2016	Naik et al.
2015/0255071	A1	9/2015	Chiba		2016/0117386	A1	4/2016	Ajmera et al.
2015/0256873	A1*	9/2015	Klein	H04N 21/26283 725/39	2016/0119338	A1	4/2016	Cheyer
2015/0261496	A1	9/2015	Faaborg et al.		2016/0125048	A1	5/2016	Hamada
2015/0269139	A1	9/2015	McAteer et al.		2016/0139662	A1	5/2016	Dabhade
2015/0278370	A1	10/2015	Stratvert et al.		2016/0147725	A1	5/2016	Patten et al.
2015/0279360	A1	10/2015	Mengibar et al.		2016/0148610	A1	5/2016	Kennewick, Jr. et al.
2015/0281380	A1	10/2015	Wang et al.		2016/0155442	A1	6/2016	Kannan et al.
2015/0286627	A1	10/2015	Chang et al.		2016/0155443	A1	6/2016	Khan et al.
2015/0287401	A1	10/2015	Lee et al.		2016/0162456	A1	6/2016	Munro et al.
2015/0287409	A1	10/2015	Jang		2016/0163312	A1	6/2016	Naik et al.
2015/0288629	A1	10/2015	Choi et al.		2016/0170966	A1	6/2016	Kolo
2015/0294086	A1	10/2015	Kare et al.		2016/0173960	A1	6/2016	Snibbe et al.
2015/0294516	A1	10/2015	Chiang		2016/0180844	A1	6/2016	Vanblon et al.
2015/0302855	A1	10/2015	Kim et al.		2016/0188181	A1	6/2016	Smith
2015/0309997	A1	10/2015	Lee et al.		2016/0189717	A1	6/2016	Kannan et al.
2015/0310858	A1	10/2015	Li et al.		2016/0212488	A1	7/2016	Os et al.
2015/0310862	A1	10/2015	Dauphin et al.		2016/0217784	A1	7/2016	Gelfenbeyn et al.
2015/0310879	A1	10/2015	Buchanan et al.		2016/0225372	A1	8/2016	Cheung et al.
2015/0312182	A1	10/2015	Langholz		2016/0240187	A1	8/2016	Fleizach et al.
2015/0317069	A1	11/2015	Clements et al.		2016/0260431	A1	9/2016	Newendorp et al.
2015/0317310	A1	11/2015	Eiche et al.		2016/0260433	A1	9/2016	Sumner et al.
2015/0324041	A1	11/2015	Varley et al.		2016/0260436	A1	9/2016	Lemay et al.
2015/0324334	A1	11/2015	Lee et al.		2016/0266871	A1	9/2016	Schmid et al.
2015/0331664	A1	11/2015	Osawa et al.		2016/0267904	A1	9/2016	Biadsky et al.
2015/0331711	A1	11/2015	Huang et al.		2016/0275941	A1	9/2016	Bellegarda et al.
2015/0332667	A1	11/2015	Mason		2016/0275947	A1	9/2016	Li et al.
2015/0339049	A1	11/2015	Kasemset et al.		2016/0282956	A1	9/2016	Ouyang et al.
2015/0339391	A1	11/2015	Kang et al.		2016/0299685	A1	10/2016	Zhai et al.
2015/0340040	A1	11/2015	Mun et al.		2016/0299882	A1	10/2016	Hegerty et al.
2015/0340042	A1	11/2015	Sejnoha et al.		2016/0299883	A1	10/2016	Zhu et al.
2015/0341717	A1	11/2015	Song et al.		2016/0307566	A1	10/2016	Bellegarda
2015/0347086	A1	12/2015	Liedholm et al.		2016/0314788	A1	10/2016	Jitkoff et al.
2015/0347382	A1	12/2015	Dolfing et al.		2016/0314792	A1	10/2016	Alvarez et al.
2015/0347385	A1	12/2015	Flor et al.		2016/0321261	A1	11/2016	Spasojevic et al.
2015/0347393	A1	12/2015	Futrell et al.		2016/0322050	A1	11/2016	Wang et al.
2015/0347733	A1	12/2015	Tsou et al.		2016/0336007	A1	11/2016	Hanazawa
2015/0347985	A1	12/2015	Gross et al.		2016/0336010	A1	11/2016	Lindahl
2015/0348547	A1	12/2015	Paulik et al.		2016/0337299	A1	11/2016	Lane et al.
2015/0348548	A1	12/2015	Piernot et al.		2016/0351190	A1	12/2016	Binder et al.
2015/0348549	A1	12/2015	Giuli et al.		2016/0357304	A1	12/2016	Hatori et al.
2015/0348551	A1	12/2015	Gruber et al.		2016/0357728	A1	12/2016	Bellegarda et al.
2015/0348554	A1	12/2015	Orr et al.		2016/0357861	A1	12/2016	Carlhian et al.
2015/0350031	A1	12/2015	Burks et al.		2016/0358598	A1	12/2016	Williams et al.
2015/0355879	A1	12/2015	Beckhardt et al.		2016/0358600	A1	12/2016	Nallasamy et al.
2015/0370531	A1	12/2015	Faaborg		2016/0378747	A1	12/2016	Orr et al.
2015/0370780	A1	12/2015	Wang et al.		2016/0379641	A1	12/2016	Liu et al.
2015/0371639	A1	12/2015	Foerster et al.		2017/0004824	A1	1/2017	Yoo et al.
2015/0371665	A1	12/2015	Naik et al.		2017/0068423	A1	3/2017	Napolitano et al.
2015/0373183	A1	12/2015	Woolsey et al.		2017/0068513	A1	3/2017	Stasior et al.
2015/0382047	A1*	12/2015	Van Os	G10L 15/22 725/38	2017/0068670	A1*	3/2017	Orr
2015/0382079	A1	12/2015	Lister et al.		2017/0083179	A1	3/2017	Gruber et al.
2016/0014476	A1	1/2016	Caliendo, Jr. et al.		2017/0091168	A1	3/2017	Bellegarda et al.
2016/0019886	A1	1/2016	Hong		2017/0092278	A1	3/2017	Evermann et al.
2016/0026258	A1	1/2016	Ou et al.		2017/0161018	A1	6/2017	Lemay et al.
2016/0027431	A1	1/2016	Kurzweil et al.		2017/0169819	A1*	6/2017	Mese
2016/0028666	A1	1/2016	Li		2017/0180499	A1	6/2017	Gelfenbeyn et al.
					2017/0230709	A1	8/2017	Van Os et al.

(56)

References Cited

U.S. PATENT DOCUMENTS

2017/0242653 A1* 8/2017 Lang H04S 7/301
 2017/0256256 A1* 9/2017 Wang G10L 15/22

FOREIGN PATENT DOCUMENTS

CA 2792412 A1 7/2011
 CA 2666438 C 6/2013
 CN 1263385 A 8/2000
 CN 1274440 A 11/2000
 CN 1321295 A 11/2001
 CN 1369858 A 9/2002
 CN 1378156 A 11/2002
 CN 1383109 A 12/2002
 CN 1407795 A 4/2003
 CN 1125436 C 10/2003
 CN 1471098 A 1/2004
 CN 1494695 A 5/2004
 CN 1524218 A 8/2004
 CN 1535519 A 10/2004
 CN 1640191 A 7/2005
 CN 1673939 A 9/2005
 CN 1757027 A 4/2006
 CN 1864204 A 11/2006
 CN 1898721 A 1/2007
 CN 2865153 Y 1/2007
 CN 1912994 A 2/2007
 CN 1959628 A 5/2007
 CN 1975715 A 6/2007
 CN 1995917 A 7/2007
 CN 101008942 A 8/2007
 CN 101162153 A 4/2008
 CN 101179754 A 5/2008
 CN 101183525 A 5/2008
 CN 101188644 A 5/2008
 CN 101228503 A 7/2008
 CN 101233741 A 7/2008
 CN 101246020 A 8/2008
 CN 101271689 A 9/2008
 CN 101277501 A 10/2008
 CN 101297541 A 10/2008
 CN 101325756 A 12/2008
 CN 101416471 A 4/2009
 CN 101427244 A 5/2009
 CN 101448340 A 6/2009
 CN 101453498 A 6/2009
 CN 101499156 A 8/2009
 CN 101535983 A 9/2009
 CN 101557432 A 10/2009
 CN 101632316 A 1/2010
 CN 101636736 A 1/2010
 CN 101673544 A 3/2010
 CN 101751387 A 6/2010
 CN 101847405 A 9/2010
 CN 101894547 A 11/2010
 CN 101939740 A 1/2011
 CN 101951553 A 1/2011
 CN 102137193 A 7/2011
 CN 102160043 A 8/2011
 CN 102246136 A 11/2011
 CN 202035047 U 11/2011
 CN 202092650 U 12/2011
 CN 102368256 A 3/2012
 CN 102682771 A 9/2012
 CN 102685295 A 9/2012
 CN 102693725 A 9/2012
 CN 102792320 A 11/2012
 CN 102917004 A 2/2013
 CN 103035240 A 4/2013
 CN 104423625 A 3/2015
 DE 102004029203 A1 12/2005
 DE 19841541 B4 12/2007
 DE 102008024258 A1 11/2009
 EP 981236 A1 2/2000
 EP 982732 A1 3/2000
 EP 984430 A2 3/2000

EP 1001588 A2 5/2000
 EP 1014277 A1 6/2000
 EP 1028425 A2 8/2000
 EP 1028426 A2 8/2000
 EP 1047251 A2 10/2000
 EP 1052566 A1 11/2000
 EP 1076302 A1 2/2001
 EP 1091615 A1 4/2001
 EP 1094406 A2 4/2001
 EP 1107229 A2 6/2001
 EP 634042 B1 7/2001
 EP 1229496 A2 8/2002
 EP 1233600 A2 8/2002
 EP 1245023 A1 10/2002
 EP 1246075 A2 10/2002
 EP 1280326 A1 1/2003
 EP 1291848 A2 3/2003
 EP 1311102 A1 5/2003
 EP 1315084 A1 5/2003
 EP 1315086 A1 5/2003
 EP 1320848 A1 6/2003
 EP 1345360 A2 9/2003
 EP 1347361 A1 9/2003
 EP 1368961 A2 12/2003
 EP 1379061 A2 1/2004
 EP 1432219 A1 6/2004
 EP 1435620 A1 7/2004
 EP 1480421 A1 11/2004
 EP 1517228 A2 3/2005
 EP 1536612 A1 6/2005
 EP 1566948 A1 8/2005
 EP 1650938 A1 4/2006
 EP 1675025 A2 6/2006
 EP 1693829 A1 8/2006
 EP 1699042 A1 9/2006
 EP 1739546 A2 1/2007
 EP 1181802 B1 2/2007
 EP 1818786 A1 8/2007
 EP 1892700 A1 2/2008
 EP 1912205 A2 4/2008
 EP 1939860 A1 7/2008
 EP 1944997 A2 7/2008
 EP 651543 B1 9/2008
 EP 1909263 B1 1/2009
 EP 1335620 B1 3/2009
 EP 2069895 A1 6/2009
 EP 2094032 A1 8/2009
 EP 2096840 A1 9/2009
 EP 2107553 A1 10/2009
 EP 2109295 A1 10/2009
 EP 1720375 B1 7/2010
 EP 2205010 A1 7/2010
 EP 2309491 A1 4/2011
 EP 2329348 6/2011
 EP 2400373 A1 12/2011
 EP 2431842 A2 3/2012
 EP 2551784 A1 1/2013
 EP 2555536 A1 2/2013
 EP 2575128 A2 4/2013
 EP 2733598 A2 5/2014
 EP 2801890 A1 11/2014
 EP 2801972 A1 11/2014
 EP 2930715 A1 10/2015
 EP 2938022 A1 10/2015
 EP 2940556 A1 11/2015
 FR 2911201 A1 7/2008
 GB 2342802 A 4/2000
 GB 2343285 A 5/2000
 GB 2346500 A 8/2000
 GB 2352377 A 1/2001
 GB 2367399 A 4/2002
 GB 2384399 A 7/2003
 GB 2402855 A 12/2004
 GB 2445436 A 7/2008
 GB 2445667 A 7/2008
 IT FI20010199 A1 4/2003
 JP 2000-32140 A 1/2000
 JP 2000-59497 A 2/2000
 JP 2000-90119 A 3/2000

(56)

References Cited

FOREIGN PATENT DOCUMENTS

JP	2000-99225	A	4/2000	JP	2004-523004	A	7/2004
JP	2000-134407	A	5/2000	JP	2004-289266	A	10/2004
JP	2000-163031	A	6/2000	JP	2004-295837	A	10/2004
JP	2000-207167	A	7/2000	JP	2004-310034	A	11/2004
JP	2000-216910	A	8/2000	JP	2004-333870	A	11/2004
JP	2000-224663	A	8/2000	JP	2004-534268	A	11/2004
JP	2000-272349	A	10/2000	JP	2004-347786	A	12/2004
JP	2000-276471	A	10/2000	JP	2005-55782	A	3/2005
JP	2000-331004	A	11/2000	JP	2005-63257	A	3/2005
JP	2000-339137	A	12/2000	JP	2005-70645	A	3/2005
JP	2000-352988	A	12/2000	JP	2005-80094	A	3/2005
JP	2000-352989	A	12/2000	JP	2005-86624	A	3/2005
JP	2001-13978	A	1/2001	JP	2005-506602	A	3/2005
JP	2001-14319	A	1/2001	JP	2005-92441	A	4/2005
JP	2001-22498	A	1/2001	JP	2005-149481	A	6/2005
JP	2001-34289	A	2/2001	JP	2005-157965	A	6/2005
JP	2001-34290	A	2/2001	JP	2005-181386	A	7/2005
JP	2001-045553	A	2/2001	JP	2005-189454	A	7/2005
JP	2001-56233	A	2/2001	JP	2005-210362	A	8/2005
JP	2001-109493	A	4/2001	JP	2005-221678	A	8/2005
JP	2001-125896	A	5/2001	JP	2005-228075	A	8/2005
JP	2001-148899	A	5/2001	JP	2005-275925	A	10/2005
JP	2001-273283	A	10/2001	JP	2005-283843	A	10/2005
JP	2001-282813	A	10/2001	JP	2005-311864	A	11/2005
JP	2001-296880	A	10/2001	JP	2005-332212	A	12/2005
JP	2001-325052	A	11/2001	JP	2006-003142	A	1/2006
JP	2002-14954	A	1/2002	JP	2006-4274	A	1/2006
JP	2002-24212	A	1/2002	JP	2006-5655	A	1/2006
JP	2002-30676	A	1/2002	JP	2006-23860	A	1/2006
JP	2002-33794	A	1/2002	JP	2006-30447	A	2/2006
JP	2002-41276	A	2/2002	JP	2006-31092	A	2/2006
JP	2002-41624	A	2/2002	JP	2006-59094	A	3/2006
JP	2002-82748	A	3/2002	JP	2006-079427	A	3/2006
JP	2002-82893	A	3/2002	JP	2006-80617	A	3/2006
JP	2002-123295	A	4/2002	JP	2006-107438	A	4/2006
JP	2002-132804	A	5/2002	JP	2006-146008	A	6/2006
JP	2002-169588	A	6/2002	JP	2006-146182	A	6/2006
JP	2002-182679	A	6/2002	JP	2006-155368	A	6/2006
JP	2002-182680	A	6/2002	JP	2006-189394	A	7/2006
JP	2002-516549	A	6/2002	JP	2006-195637	A	7/2006
JP	2002-230021	A	8/2002	JP	2006-201870	A	8/2006
JP	2002-236029	A	8/2002	JP	2006-208696	A	8/2006
JP	2002-524806	A	8/2002	JP	2006-229730	A	8/2006
JP	2002-281562	A	9/2002	JP	2006-237735	A	9/2006
JP	2002-304410	A	10/2002	JP	2006-244296	A	9/2006
JP	2002-534716	A	10/2002	JP	2006-522549	A	9/2006
JP	2002-341892	A	11/2002	JP	2006-267328	A1	10/2006
JP	2002-342033	A	11/2002	JP	2006-302091	A	11/2006
JP	2002-342212	A	11/2002	JP	2006-318373	A	11/2006
JP	2002-344880	A	11/2002	JP	2006-526185	A	11/2006
JP	2002-542501	A	12/2002	JP	2007-4633	A	1/2007
JP	2003-15682	A	1/2003	JP	2007-17990	A	1/2007
JP	2003-022087	A	1/2003	JP	2007-500903	A	1/2007
JP	2003-44091	A	2/2003	JP	2007-53796	A	3/2007
JP	2003-84877	A	3/2003	JP	2007-79690	A	3/2007
JP	2003-517158	A	5/2003	JP	2007-171534	A	7/2007
JP	2003-202897	A	7/2003	JP	2007-193794	A	8/2007
JP	2003-233568	A	8/2003	JP	2007-206317	A	8/2007
JP	2003-244317	A	8/2003	JP	2007-264471	A	10/2007
JP	2003-255991	A	9/2003	JP	2007-264792	A	10/2007
JP	2003-527656	A	9/2003	JP	2007-264892	A	10/2007
JP	2003-288356	A	10/2003	JP	2007-272773	A	10/2007
JP	2003-308079	A	10/2003	JP	2007-299352	A	11/2007
JP	2003-533909	A	11/2003	JP	2007-322647	A	12/2007
JP	2004-48804	A	2/2004	JP	2007-325089	A	12/2007
JP	2004-54080	A	2/2004	JP	2007-333603	A	12/2007
JP	2004-056226	A	2/2004	JP	2008-009120	A	1/2008
JP	2004-505322	A	2/2004	JP	2008-21002	A	1/2008
JP	2004-505525	A	2/2004	JP	2008-26381	A	2/2008
JP	2004-86356	A	3/2004	JP	2008-39928	A	2/2008
JP	2004-94936	A	3/2004	JP	2008-58813	A	3/2008
JP	2004-101901	A	4/2004	JP	2008-064687	A	3/2008
JP	2004-117905	A	4/2004	JP	2008-90545	A	4/2008
JP	2004-152063	A	5/2004	JP	2008-97003	A	4/2008
JP	2004-153306	A	5/2004	JP	2008-134949	A	6/2008
				JP	2008-526101	A	7/2008
				JP	2008-185693	A	8/2008
				JP	2008-198022	A	8/2008
				JP	2008-217468	A	9/2008

(56)

References Cited

FOREIGN PATENT DOCUMENTS							
JP	2008-228129	A	9/2008	KR	10-2007-0071675	A	7/2007
JP	2008-233678	A	10/2008	KR	10-2007-0094767	A	9/2007
JP	2008-236448	A	10/2008	KR	10-0757496	B1	9/2007
JP	2008-252161	A	10/2008	KR	10-2007-0100837	A	10/2007
JP	2008-268684	A	11/2008	KR	10-0776800	B1	11/2007
JP	2008-271481	A	11/2008	KR	10-0801227	B1	2/2008
JP	2008-299221	A	12/2008	KR	10-0810500	B1	3/2008
JP	2009-503623	A	1/2009	KR	10-2008-0033070	A	4/2008
JP	2009-36999	A	2/2009	KR	10-0819928	B1	4/2008
JP	2009-47920	A	3/2009	KR	10-2008-0049647	A	6/2008
JP	2009-069062	A	4/2009	KR	10-2008-0059332	A	6/2008
JP	2009-98490	A	5/2009	KR	10-2008-0109322	A	12/2008
JP	2009-140444	A	6/2009	KR	10-2009-0001716	A	1/2009
JP	2009-186989	A	8/2009	KR	10-2009-0028464	A	3/2009
JP	2009-193448	A	8/2009	KR	10-2009-0030117	A	3/2009
JP	2009-193457	A	8/2009	KR	10-2009-0086805	A	8/2009
JP	2009-193532	A	8/2009	KR	10-0920267	B1	10/2009
JP	2009-205367	A	9/2009	KR	10-2009-0122944	A	12/2009
JP	2009-294913	A	12/2009	KR	10-2009-0127961	A	12/2009
JP	2009-294946	A	12/2009	KR	10-2009-0129192	A	12/2009
JP	2010-66519	A	3/2010	KR	10-2010-0015958	A	2/2010
JP	2010-78979	A	4/2010	KR	10-2010-0048571	A	5/2010
JP	2010-108378	A	5/2010	KR	10-2010-0053149	A	5/2010
JP	2010-518526	A	5/2010	KR	10-2010-0119519	A	11/2010
JP	2010-157207	A	7/2010	KR	10-2011-0043644	A	4/2011
JP	2010-224236	A	10/2010	KR	10-1032792	B1	5/2011
JP	4563106	B2	10/2010	KR	10-2011-0068490	A	6/2011
JP	2010-535377	A	11/2010	KR	10-2011-0072847	A	6/2011
JP	2010-287063	A	12/2010	KR	10-2011-0086492	A	7/2011
JP	2011-41026	A	2/2011	KR	10-2011-0100620	A	9/2011
JP	2011-45005	A	3/2011	KR	10-2011-0113414	A	10/2011
JP	2011-59659	A	3/2011	KR	10-2011-0115134	A	10/2011
JP	2011-81541	A	4/2011	KR	10-2012-0020164	A	3/2012
JP	2011-525045	A	9/2011	KR	10-2012-0031722	A	4/2012
JP	2011-238022	A	11/2011	KR	10-1178310	B1	8/2012
JP	2012-014394	A	1/2012	KR	10-2012-0120316	A	11/2012
JP	2012-089020	A	5/2012	KR	10-2012-0137435	A	12/2012
JP	2012-116442	A	6/2012	KR	10-2012-0137440	A	12/2012
JP	2012-147063	A	8/2012	KR	10-2012-0138826	A	12/2012
JP	2012-518847	A	8/2012	KR	10-2012-0139827	A	12/2012
JP	2013-511214	A	3/2013	KR	10-1193668	B1	12/2012
JP	2013-73240	A	4/2013	KR	10-2013-0035983	A	4/2013
JP	2013-080476	A	5/2013	KR	10-1334342	B1	11/2013
JP	2013-517566	A	5/2013	KR	10-2013-0131252	A	12/2013
JP	2013-134430	A	7/2013	NL	1014847	C	10/2001
JP	2013-527947	A	7/2013	RU	2273106	C2	3/2006
JP	2013-156349	A	8/2013	RU	2349970	C2	3/2009
JP	2013-205999	A	10/2013	RU	2353068	C2	4/2009
JP	2013-238936	A	11/2013	RU	2364917	C2	8/2009
JP	2014-10688	A	1/2014	TW	468323	B	12/2001
JP	2014-026629	A	2/2014	TW	200601264	A	1/2006
JP	2014-72586	A	4/2014	TW	200638337	A	11/2006
JP	2014-077969	A	5/2014	TW	200643744	A	12/2006
JP	2014-145842	A	8/2014	TW	200801988	A	1/2008
JP	2014-150323	A	8/2014	TW	I301373	B	9/2008
JP	2015-41845	A	3/2015	TW	M348993	U	1/2009
KR	10-2001-0092415	A	10/2001	TW	200943903	A	10/2009
KR	2001-0093654	A	10/2001	TW	201018258	A	5/2010
KR	10-2001-0102132	A	11/2001	TW	201027515	A1	7/2010
KR	2002-0013984	A	2/2002	TW	201028996	A1	8/2010
KR	2002-0057262	A	7/2002	TW	201110108	A1	3/2011
KR	2002-0064149	A	8/2002	TW	2011-42823	A1	12/2011
KR	2002-0069952	A	9/2002	TW	201227715	A1	7/2012
KR	2003-0016993	A	3/2003	TW	201245989	A1	11/2012
KR	10-2004-0014835	A	2/2004	TW	201312548	A1	3/2013
KR	10-2004-0044632	A	5/2004	WO	2000/014727	A1	3/2000
KR	10-2005-0083561	A	8/2005	WO	2000/014728	A1	3/2000
KR	10-2005-0090568	A	9/2005	WO	2000/019697	A1	4/2000
KR	10-2006-0011603	A	2/2006	WO	2000/022820	A1	4/2000
KR	10-2006-0012730	A	2/2006	WO	2000/029964	A1	5/2000
KR	10-2006-0055313	A	5/2006	WO	2000/030070	A2	5/2000
KR	10-2006-0073574	A	6/2006	WO	2000/038041	A1	6/2000
KR	10-2006-0091469	A	8/2006	WO	2000/041065	A1	7/2000
KR	10-2006-0127647	A	12/2006	WO	2000/044173	A1	7/2000
KR	10-2007-0024262	A	3/2007	WO	2000/060435	A2	10/2000
				WO	2000/060435	A3	10/2000
				WO	2000/063766	A1	10/2000
				WO	2000/068936	A1	11/2000
				WO	2001/006489	A1	1/2001

(56)

References Cited

FOREIGN PATENT DOCUMENTS

WO 2001/26093 A1 4/2001
 WO 2001/030047 A2 4/2001
 WO 6001/030046 A2 4/2001
 WO 2001/033569 A1 5/2001
 WO 2001/035391 A1 5/2001
 WO 2001/044912 A2 6/2001
 WO 2001/046946 A1 6/2001
 WO 2001/065413 A1 9/2001
 WO 2001/067753 A1 9/2001
 WO 2001/071480 A2 9/2001
 WO 2002/010900 A2 2/2002
 WO 2002/025610 A1 3/2002
 WO 2002/031814 A1 4/2002
 WO 2002/037469 A2 5/2002
 WO 2002/049253 A2 6/2002
 WO 2002/071259 A1 9/2002
 WO 2002/073603 A1 9/2002
 WO 2002/080142 A2 10/2002
 WO 2003/003152 A2 1/2003
 WO 2003/003765 A1 1/2003
 WO 2003/023786 A2 3/2003
 WO 2003/036457 A2 5/2003
 WO 2003/041364 A2 5/2003
 WO 2003/049494 A1 6/2003
 WO 2003/056789 A1 7/2003
 WO 2003/067202 A2 8/2003
 WO 2003/084196 A1 10/2003
 WO 2003/094489 A1 11/2003
 WO 2003/105125 A1 12/2003
 WO 2003/107179 A1 12/2003
 WO 2004/008801 A1 1/2004
 WO 2004/025938 A1 3/2004
 WO 2004/047415 A1 6/2004
 WO 2004/055637 A2 7/2004
 WO 2004/057486 A1 7/2004
 WO 2004/061850 A1 7/2004
 WO 2004/072846 A2 8/2004
 WO 2004/084413 A2 9/2004
 WO 2005/003920 A2 1/2005
 WO 2005/008505 A1 1/2005
 WO 2005/008899 A1 1/2005
 WO 2005/010725 A2 2/2005
 WO 2005/027472 A2 3/2005
 WO 2005/027485 A1 3/2005
 WO 2005/031737 A1 4/2005
 WO 2005/034082 A1 4/2005
 WO 2005/034085 A1 4/2005
 WO 2005/041455 A1 5/2005
 WO 2005/059895 A1 6/2005
 WO 2005/064592 A1 7/2005
 WO 2005/069171 A1 7/2005
 WO 2005/101176 A2 10/2005
 WO 2006/020305 A2 2/2006
 WO 2006/037545 A2 4/2006
 WO 2006/054724 A1 5/2006
 WO 2006/056822 A1 6/2006
 WO 2006/078246 A1 7/2006
 WO 2006/084144 A2 8/2006
 WO 2006/101649 A2 9/2006
 WO 2006/129967 A1 12/2006
 WO 2006/133571 A1 12/2006
 WO 2007/002753 A2 1/2007
 WO 2007/036762 A1 4/2007
 WO 2007/080559 A2 7/2007
 WO 2007/083894 A1 7/2007
 WO 2007/125151 A1 11/2007
 WO 2008/030970 A2 3/2008
 WO 2008/071231 A1 6/2008
 WO 2008/085742 A2 7/2008
 WO 2008/098900 A2 8/2008
 WO 2008/109835 A2 8/2008
 WO 2008/120036 A1 10/2008
 WO 2008/130095 A1 10/2008
 WO 2008/140236 A1 11/2008
 WO 2008/142472 A1 11/2008

WO 2008/153639 A1 12/2008
 WO 2009/009240 A2 1/2009
 WO 2009/016631 A2 2/2009
 WO 2009/017280 A1 2/2009
 WO 2009/075912 A1 6/2009
 WO 2009/104126 A1 8/2009
 WO 2009/156438 A1 12/2009
 WO 2009/156978 A1 12/2009
 WO 2010/054373 A2 5/2010
 WO 2010/075623 A1 7/2010
 WO 2010/141802 A1 12/2010
 WO 2011/057346 A1 5/2011
 WO 2011/060106 A1 5/2011
 WO 2011/088053 A2 7/2011
 WO 2011/093025 A1 8/2011
 WO 2011/116309 A1 9/2011
 WO 2011/133543 A1 10/2011
 WO 2011/150730 A1 12/2011
 WO 2011/163350 A1 12/2011
 WO 2011/088053 A3 1/2012
 WO 2012/019637 A1 2/2012
 WO 2012/129231 A1 9/2012
 WO 2012/135157 A2 10/2012
 WO 2012/154317 A1 11/2012
 WO 2012/155079 A2 11/2012
 WO 2012/167168 A2 12/2012
 WO 2013/009578 A2 1/2013
 WO 2013/022135 A1 2/2013
 WO 2013/048880 A1 4/2013
 WO 2013/049358 A1 4/2013
 WO 2013/169842 A2 11/2013
 WO 2013/173511 A2 11/2013
 WO 2013/184953 A1 12/2013
 WO 2013/184990 A1 12/2013
 WO 2014/003138 A1 1/2014
 WO 2014/022148 A1 2/2014
 WO 2014/028797 A1 2/2014
 WO 2014/031505 A1 2/2014
 WO 2014/066352 A1 5/2014
 WO 2014/078965 A1 5/2014
 WO 2014/096506 A1 6/2014
 WO 2014/143959 A2 9/2014
 WO 2014/144579 A1 9/2014
 WO 2014/159581 A1 10/2014
 WO 2014/197336 A1 12/2014
 WO 2014/200728 A1 12/2014
 WO 2014/204659 A2 12/2014
 WO 2015/030796 A1 3/2015
 WO 2015/041892 A1 3/2015
 WO 2015/084659 A1 6/2015
 WO 2015/094169 A1 6/2015
 WO 2015/094369 A1 6/2015
 WO 2015/099939 A1 7/2015
 WO 2015/116151 A1 8/2015
 WO 2015/151133 A1 10/2015
 WO 2015/183401 A1 12/2015
 WO 2015/200207 A1 12/2015
 WO 2016/057268 A1 4/2016
 WO 2016/075081 A1 5/2016
 WO 2017/044629 A1 3/2017
 WO 2017/053311 A1 3/2017

OTHER PUBLICATIONS

“DIRECTV™ Voice”, Now Part of the DIRECTV Mobile App for Phones, Sep. 18, 2013, 5 pages.
 “SmartThings +Amazon Echo”, Smartthings Samsung [online], Available online <<https://web.archive.org/web/20160509231428/https://blog.smartthings.com/featured/alexa-turn-on-my-smart-things/>>, Aug. 21, 2015, 3 pages.
 “Ask Alexa—Things That Are Smart Wiki”, Available online at <[URL:http://thingsthataresmart.wiki/index.php?title=Ask_Alexa&oldid=4283](http://thingsthataresmart.wiki/index.php?title=Ask_Alexa&oldid=4283)>, [retrieved from internet on Aug. 2, 2017], Jun. 8, 2016, pp. 1-31.
 “The world of Virtual Assistants—more SemTech . . .”, End of Business as Usual—Glenn’s External blog, Online Available at <<https://web.archive.org/web/20091101840940/http://glennas>.

(56)

References Cited

OTHER PUBLICATIONS

wordpress.com/2009/10/17/the-world-of-virtual-assistants-more-semtech/>, Oct. 17, 2009, 5 pages.

2004 Chrysler Pacifica: U-Connect Hands-Free Communication System, The Best and Brightest of 2004, Brief Article, Automotive Industries, Sep. 2003, 1 page.

2007 Lexus GS 450h 4dr Sedan (3.5L 6cyl Gas/Electric Hybrid CVT), available at <http://review.cnet.com/4505-10865_16-31833144.html>, retrieved on Aug. 3, 2006, 10 pages.

ABCOT Pty. Ltd. "12.1" 925 Candela Mobile PC", LCDHardware.com, available at <http://www.lcdhardware.com/panel/12_1_panel/default.asp>, retrieved on Dec. 19, 2002, 2 pages.

ABF Software, "Lens—Magnifying Glass 1.5", available at <<http://download.com/3000-2437-10262078.html?tag=1st-0-1>>, retrieved on Feb. 11, 2004, 1 page.

Adium, "AboutAdium—Adium X—Trac", available at <<http://web.archive.org/web/20070819113247/http://trac.adiumx.com/wiki/AboutAdium>>, retrieved on Nov. 25, 2011, 2 pages.

adobe.com, "Reading PDF Documents with Adobe Reader 6.0—A Guide for People with Disabilities", Available online at <https://www.adobe.com/enterprise/accessibility/pdfs/acro6_cg_ue.pdf>, Jan. 2004, 76 pages.

Aikawa et al., "Generation for Multilingual MT", available at <<http://mtarchive.info/MTS-2001-Aikawa.pdf>>, retrieved on Sep. 18, 2001, 6 pages.

Alfred App, "Alfred", available at <<http://www.alfredapp.com/>>, retrieved on Feb. 8, 2012, 5 pages.

All Music Website, available at <<http://www.allmusic.com/>>, retrieved on Mar. 19, 2007, 2 pages.

Allen et al., "Automated Natural Spoken Dialog", Computer, vol. 35, No. 4, Apr. 2002, pp. 51-56.

Amano et al., "A User-friendly Multimedia Book Authoring System", The Institute of Electronics, Information and Communication Engineers Technical Report, vol. 103, No. 416, Nov. 2003, pp. 33-40.

Amano, Junko, "A User-Friendly Authoring System for Digital Talking Books", IEICE Technical Report, The Institute of Electronics, Information and Communication Engineers, vol. 103 No. 418, Nov. 6, 2003, pp. 33-40.

Ambite et al., "Design and Implementation of the CALO Query Manager", American Association for Artificial Intelligence, 2006, 8 pages.

Ambite et al., "Integration of Heterogeneous Knowledge Sources in the CALO Query Manager", The 4th International Conference on Ontologies, Databases and Applications of Semantics (ODBASE), 2005, 18 pages.

Amrel Corporation, "Rocky Matrix BackLit Keyboard", available at <http://www.amrel.com/asi_matrixkeyboard.html>, retrieved on Dec. 19, 2002, 1 page.

Anania, Peter, "Amazon Echo with Home Automation (Smart-things)", Available online at <https://www.youtube.com/watch?v=LMW6aXmsWNE>, Dec. 20, 2015, 1 page.

Anhui USTC IFK YTEK Co. Ltd., "Flytek Research Center Information Datasheet", available at <<http://www.ifltek.com/english/Research.htm>>, retrieved on Oct. 15, 2004, 3 pages.

Api.Ai, "Android App Review—Speaktoit Assistant", Available at <<https://www.youtube.com/watch?v=myE498nyfGw>>, Mar. 30, 2011, 3 pages.

Apple Computer, "Knowledge Navigator", published by Apple Computer no later than 2008, as depicted in Exemplary Screenshots from video entitled 'Knowledge Navigator', 2008, 7 pages.

Apple Computer, Inc., "Apple—iPod—Technical Specifications, iPod 20GB and 60GB Mac + PC", available at <<http://www.apple.com/ipod/color/specs.html>>, 2005, 3 pages.

Apple Computer, Inc., "Apple Announces iTunes 2", Press Release, Oct. 23, 2001, 2 pages.

Apple Computer, Inc., "Apple Introduces iTunes—World's Best and Easiest to Use Jukebox Software", Macworld Expo, Jan. 9, 2001, 2 pages.

Apple Computer, Inc., "Apple's iPod Available in Stores Tomorrow", Press Release, Nov. 9, 2001, 1 page.

Apple Computer, Inc., "iTunes 2, Playlist Related Help Screens", iTunes v2.0, 2000-2001, 8 pages.

Apple Computer, Inc., "iTunes 2: Specification Sheet", 2001, 2 pages.

Apple Computer, Inc., "iTunes, Playlist Related Help Screens", iTunes v1.0, 2000-2001, 8 pages.

Apple Computer, Inc., "QuickTime Movie Playback Programming Guide", Aug. 11, 2005, pp. 1-58.

Apple Computer, Inc., "QuickTime Overview", Aug. 11, 2005, pp. 1-34.

Apple Computer, Inc., "Welcome to Tiger", available at <http://www.maths.dundee.ac.uk/software/Welcome_to_Mac_OS_X_v10.4_Tiger.pdf>, 2005, pp. 1-32.

Apple, "iPhone User's Guide", Available at <<http://mesnotices.20minutes.fr/manuel-notice-mode-emploi/APPLE/IPHONE%2D%5FE#>>, Retrieved on Mar. 27, 2008, Jun. 2007, 137 pages.

Apple, "VoiceOver", available at <<http://www.apple.com/accessibility/voiceover/>>, Feb. 2009, 5 pages.

Badino et al., "Language Independent Phoneme Mapping for Foreign TTS", 5th ISCA Speech Synthesis Workshop, Pittsburgh, PA, Jun. 14-16, 2004, 2 pages.

Bederson et al., "The Craft of Information Visualization", Elsevier Science, Inc., 2003, 435 pages.

Bellegarda, Jerome R. "Latent Semantic Mapping", IEEE Signal Processing Magazine, vol. 22, No. 5, Sep. 2005, pp. 70-80.

Bellegarda, Jerome R., "Exploiting Latent Semantic Information in Statistical Language Modeling", Proceedings of the IEEE, vol. 88, No. 8, Aug. 2000, 18 pages.

Bellegarda, Jerome R., "Large Vocabulary Speech Recognition with Multispan Statistical Language Models", IEEE Transactions on Speech and Audio Processing, vol. 8, No. 1, Jan. 2000, 9 pages.

Belvin et al., "Development of the HRL Route Navigation Dialogue System", Proceedings of the First International Conference on Human Language Technology Research, Paper, 2001, 5 pages.

Berry et al., "PTIME: Personalized Assistance for Calendaring", ACM Transactions on Intelligent Systems and Technology, vol. 2, No. 4, Article 40, Jul. 2011, pp. 1-22.

Berry et al., "Task Management under Change and Uncertainty Constraint Solving Experience with the CALO Project", Proceedings of CP'05 Workshop on Constraint Solving under Change, 2005, 5 pages.

Bertulucci, Jeff, "Google Adds Voice Search to Chrome Browser", PC World, Jun. 14, 2011, 5 pages.

Best Buy, "When it Comes to Selecting a Projection TV, Toshiba Makes Everything Perfectly Clear", Previews of New Releases, available at <<http://www.bestbuy.com/HomeAudioVideo/Specials/ToshibaTVFeatures.asp>>, retrieved on Jan. 23, 2003, 5 pages.

Biemann et al., "Disentangling from Babylonian Confusion—Unsupervised Language Identification", CICLing'05 Proceedings of the 6th international conference on Computational Linguistics and Intelligent Text Processing, vol. 3406, Feb. 2005, pp. 773-784.

Biemann, Chris, "Unsupervised Part-of-Speech Tagging Employing Efficient Graph Clustering", Proceeding COLING ACL '06 Proceedings of the 21st International Conference on computational Linguistics and 44th Annual Meeting of the Association for Computational Linguistics: Student Research Workshop, 2006, pp. 7-12.

Birrell, Andrew, "Personal Jukebox (PJB)", available at <<http://birrell.org/andrew/talks/pjb-overview.ppt>>, Oct. 13, 2000, 6 pages.

Black et al., "Multilingual Text-to-Speech Synthesis", Acoustics, Speech and Signal Processing (ICASSP'04), Proceedings of the IEEE International Conference, vol. 3, May 17-21, 2004, pp. 761-764.

BluePhoneElite: About, available at <<http://www.reelintelligence.com/BluePhoneElite>>, retrieved on Sep. 25, 2006, 2 pages.

BluePhoneElite: Features, available at <<http://www.reelintelligence.com/BluePhoneElite/features.shtml>>, retrieved on Sep. 25, 2006, 2 pages.

(56)

References Cited

OTHER PUBLICATIONS

- Bluetooth PC Headsets, “‘Connecting’ Your Bluetooth Headset with Your Computer”, Enjoy Wireless VoIP Conversations, available at <<http://www.bluetoothpcheadsets.com/connect.htm>>, retrieved on Apr. 29, 2006, 4 pages.
- Bocchieri et al., “Use of Geographical Meta-Data in ASR Language and Acoustic Models”, IEEE International Conference on Acoustics Speech and Signal Processing, 2010, pp. 5118-5121.
- Bociurkiw, Michael, “Product Guide: Vanessa Matz”, available at <http://www.forbes.com/asap/2000/1127/vmartz_print.html>, retrieved on Jan. 23, 2003, 2 pages.
- Borden IV, G.R., “An Aural User Interface for Ubiquitous Computing”, Proceedings of the 6th International Symposium on Wearable Computers, IEEE, 2002, 2 pages.
- Brain, Marshall, “How MP3 Files Work”, available at <<http://www.howstuffworks.com>>, retrieved on Mar. 19, 2007, 4 pages.
- Bulyko et al., “Error-Correction Detection and Response Generation in a Spoken Dialogue System”, Speech Communication, vol. 45, 2005, pp. 271-288.
- Bulyko et al., “Joint Prosody Prediction and Unit Selection for Concatenative Speech Synthesis”, Electrical Engineering Department, University of Washington, Seattle, 2001, 4 pages.
- Bussler et al., “Web Service Execution Environment (WSMX)”, retrieved from Internet on Sep. 17, 2012, available at <<http://www.w3.org/Submission/WSMX>>, Jun. 3, 2005, 29 pages.
- Butcher, Mike, “EVI Arrives in Town to go Toe-to-Toe with Siri”, TechCrunch, Jan. 23, 2012, 2 pages.
- Butler, Travis, “Archos Jukebox 6000 Challenges Nomad Jukebox”, available at <<http://tidbits.com/article/6521>>, Aug. 13, 2001, 5 pages.
- Butler, Travis, “Portable MP3: The Nomad Jukebox”, available at <<http://tidbits.com/article/6261>>, Jan. 8, 2001, 4 pages.
- Cao et al., “Adapting Ranking SVM to Document Retrieval”, SIGIR ’06, Seattle, WA, Aug. 6-11, 2006, 8 pages.
- Car Working Group, “Hands-Free Profile 1.5 HFP1.5_SPEC”, Bluetooth Doc, available at <www.bluetooth.org>, Nov. 25, 2005, 93 pages.
- Caraballo et al., “Language Identification Based on a Discriminative Text Categorization Technique”, Iberspeech 2012—VII Jornadas En Tecnologia Del Habla and Iii Iberians Tech Workshop, Nov. 21, 2012, pp. 1-10.
- Castleos, “Whole House Voice Control Demonstration”, available online at : https://www.youtube.com/watch?v=9SRCoxrZ_W4, Jun. 2, 2012, 26 pages.
- Chai et al., “Comparative Evaluation of a Natural Language Dialog Based System and a Menu Driven System for Information Access: A Case Study”, Proceedings of the International Conference on Multimedia Information Retrieval (RIAO), Paris, Apr. 2000, 11 pages.
- Chakarova et al., “Digital Still Cameras—Downloading Images to a Computer”, Multimedia Reporting and Convergence, available at <<http://journalism.berkeley.edu/multimedia/tutorials/stillcams/downloading.html>>, retrieved on May 9, 2005, 2 pages.
- Chamberlain, Kim, “Quick Start Guide Natural Reader”, available online at <http://atrc.colostate.edu/files/quickstarts/Natural_Reader_Quick_Start_Guide>, Apr. 2008, 5 pages.
- Chartier, David, “Using Multi-Network Meebo Chat Service on Your iPhone”, available at <<http://www.tuaw.com/2007/07/04/using-multi-network-meebo-chat-service-on-your-iphone/>>, Jul. 4, 2007, 5 pages.
- Chelba et al., “Structured Language Modeling for Speech Recognition”, Available online at : <http://arxiv.org/pdf/cs/0001023.pdf>, Jan. 25, 2000, 7 pages.
- Chen et al., “An Improved Method for Image Retrieval Using Speech Annotation”, The 9th International Conference on Multimedia Modeling, Jan. 2003, pp. 1-17.
- Chen, Yi, “Multimedia Siri Finds and Plays Whatever You Ask for”, PSFK Report, Feb. 9, 2012, 9 pages.
- Cheyser et al., “The Open Agent Architecture”, Autonomous Agents and Multi-Agent Systems, vol. 4, Mar. 1, 2001, 6 pages.
- Cheyser, A., “Demonstration Video of Vanguard Mobile Portal”, published by SRI International no later than 2004, as depicted in ‘Exemplary Screenshots from video entitled Demonstration Video of Vanguard Mobile Portal’, 2004, 10 pages.
- Cheyser, Adam, “A Perspective on AI & Agent Technologies for SCM”, VerticalNet Presentation, 2001, 22 pages.
- Cheyser, Adam, “About Adam Cheyser”, available at <<http://www.adam.cheyser.com/about.html>>, retrieved on Sep. 17, 2012, 2 pages.
- Choi et al., “Acoustic and Visual Signal based Context Awareness System for Mobile Application”, IEEE Transactions on Consumer Electronics, vol. 57, No. 2, May 2011, pp. 738-746.
- Choularton et al., “User Responses to Speech Recognition Errors: Consistency of Behaviour Across Domains”, Proceedings of the 10th Australian International Conference on Speech Science & Technology, Dec. 8-10, 2004, pp. 457-462.
- Cisco Systems, Inc., “Cisco Unity Unified Messaging User Guide”, Release 4.0(5), Apr. 14, 2005, 152 pages.
- Cisco Systems, Inc., “Installation Guide for Cisco Unity Unified Messaging with Microsoft Exchange 2003/2000 (With Failover Configured)”, Release 4.0(5), Apr. 14, 2005, 152 pages.
- Cisco Systems, Inc., “Operations Manager Tutorial, Cisco’s IPC Management Solution”, 2006, 256 pages.
- Cohen et al., “Voice User Interface Design”, Excerpts from Chapter 1 and Chapter 10, 2004, 36 pages.
- Colt, Sam, “Here’s One Way Apple’s Smartwatch Could Be Better Than Anything Else”, Business Insider, Aug. 21, 2014, pp. 1-4.
- Combined Search Report and Examination Report under Sections 17 and 18(3) received for GB Patent Application No. 1009318.5, dated Oct. 8, 2010, 5 pages.
- Combined Search Report and Examination Report under Sections 17 and 18(3) received for GB Patent Application No. 1217449.6, dated Jan. 17, 2013, 6 pages.
- Compaq Inspiration Technology, “Personal Jukebox (PJB)—Systems Research Center and PAAD”, Oct. 13, 2000, 25 pages.
- Compaq, “Personal Jukebox”, available at <<http://research.compaq.com/SRC/pjb/>>, 2001, 3 pages.
- Conkie et al., “Preselection of Candidate Units in a Unit Selection-Based Text-to-Speech Synthesis System”, ISCA, 2000, 4 pages.
- Cox et al., “Speech and Language Processing for Next-Millennium Communications Services”, Proceedings of the IEEE, vol. 88, No. 8, Aug. 2000, 24 pages.
- Creative Technology Ltd., “Creative NOMAD® II: Getting Started—User Guide (On Line Version)”, available at <<http://ec1.images-amazon.com/media/i3d/01/A/man-migrate/MANUAL000026434.pdf>>, Apr. 2000, 46 pages.
- Creative Technology Ltd., “Nomad Jukebox”, User Guide, Version 1.0, Aug. 2000, 52 pages.
- Creative, “Creative NOMAD MuVo TX”, available at <<http://web.archive.org/web/20041024175952/www.creative.com/products/pfriendly.asp?product=9672>>, retrieved on Jun. 6, 2006, 1 page.
- Creative, “Creative NOMAD MuVo”, available at <<http://web.archive.org/web/20041024075901/www.creative.com/products/product.asp?category=213&subcategory=216&product=4983>>, retrieved on Jun. 7, 2006, 1 page.
- Creative, “Digital MP3 Player”, available at <<http://web.archive.org/web/20041024074823/www.creative.com/products/product.asp?category=213&subcategory=216&product=4983>>, 2004, 1 page.
- Cucerzan et al., “Bootstrapping a Multilingual Part-of-Speech Tagger in One Person-Day”, In Proceedings of the 6th Conference on Natural Language Learning, vol. 20, 2002, pp. 1-7.
- Davis et al., “A Personal Handheld Multi-Modal Shopping Assistant”, International Conference on Networking and Services, IEEE, 2006, 9 pages.
- Davis et al., “Stone Soup Translation”, Department of Linguistics, Ohio State University, 2001, 11 pages.
- De Herrera, Chris, “Microsoft ActiveSync 3.1”, Version 1.02, available at <<http://www.cewindows.net/wce/activesync3.1.htm>>, Oct. 13, 2000, 8 pages.
- Deedeevuu, “Amazon Echo Alarm Feature”, Available online at <https://www.youtube.com/watch?v=fdjU8eRLk7c>, Feb. 16, 2015, 1 page.

(56)

References Cited

OTHER PUBLICATIONS

- Del Strother, Jonathan, "Coverflow", available at <<http://www.steelskies.com/coverflow>>, retrieved on Jun. 15, 2006, 14 pages.
- Digital Audio in the New Era, *Electronic Design and Application*, No. 6, Jun. 30, 2003, 3 pages.
- Dittenbach et al., "A Natural Language Query Interface for Tourism Information", In: *Information and Communication Technologies in Tourism 2003*, XP055114393, Feb. 14, 2003, pp. 152-162.
- Dobrisek et al., "Evolution of the Information-Retrieval System for Blind and Visually-Impaired People", *International Journal of Speech Technology*, Kluwer Academic Publishers, Bo, vol. 6, No. 3, pp. 301-309.
- Domingue et al., "Web Service Modeling Ontology (WSMO)—An Ontology for Semantic Web Services", Position Paper at the W3C Workshop on Frameworks for Semantics in Web Services, Innsbruck, Austria, Jun. 2005, 6 pages.
- Donovan, R. E., "A New Distance Measure for Costing Spectral Discontinuities in Concatenative Speech Synthesizers", available at <<http://citeseerx.ist.osu.edu/viewdoc/summary?doi=10.1.1.21.6398>>, 2001, 4 pages.
- Dragon Naturally Speaking Version 11 Users Guide, Nuance Communications, Inc., Copyright @2002-2010, 132 pages.
- Dual Rate Speech Coder for Multimedia Communications Transmitting at 5.3 and 6.3 kbit/s, *International Telecommunication Union Recommendation G.723*, 7 pages.
- Dusan et al., "Multimodal Interaction on PDA's Integrating Speech and Pen Inputs", *Eurospeech Geneva*, 2003, 4 pages.
- Dyslexic.com, "AlphaSmart 3000 with CoWriter SmartApplet: Don Johnston Special Needs", available at <<http://www.dyslexic.com/procuts.php?catid=2&pid=465&PHPSESSID=2511b800000f7da>>, retrieved on Dec. 6, 2005, 13 pages.
- Eagle et al., "Social Serendipity: Proximity Sensing and Cueing", MIT Media Laboratory Technical Note 580, May 2004, 18 pages.
- Elliott et al., "Annotation Suggestion and Search for Personal Multimedia Objects on the Web", *CIVR*, Jul. 7-9, 2008, pp. 75-84.
- Eluminx, "Illuminated Keyboard", available at <<http://www.eluminx.com/>>, retrieved on Dec. 19, 2002, 1 page.
- Engst, Adam C., "SoundJam Keeps on Jammin'", available at <<http://db.tidbits.com/getbits.cgi?bart=05988>>, Jun. 19, 2000, 3 pages.
- Ericsson et al., "Software Illustrating a Unified Approach to Multimodality and Multilinguality in the In-Home Domain", *Talk and Look: Tools for Ambient Linguistic Knowledge*, Dec. 2006, 127 pages.
- Erol et al., "Multimedia Clip Generation From Documents for Browsing on Mobile Devices", *IEEE Transactions on Multimedia*, vol. 10, No. 5, Aug. 2008, 13 pages.
- Eslambolchilar et al., "Making Sense of Fisheye Views", *Second Dynamics and Interaction Workshop at University of Glasgow*, Aug. 2005, 6 pages.
- Eslambolchilar et al., "Multimodal Feedback for Tilt Controlled Speed Dependent Automatic Zooming", *UIST'04*, Oct. 24-27, 2004, 2 pages.
- European Search Report received for European Patent Application No. 01201774.5, dated Sep. 14, 2001, 3 pages.
- Evermann et al., "Posterior Probability Decoding, Confidence Estimation and System Combination", *Proceedings Speech Transcription Workshop*, 2000, 4 pages.
- EVI, "Meet Evi: The One Mobile Application that Provides Solutions for your Everyday Problems", Feb. 2012, 3 pages.
- Exhibit 1, "Natural Language Interface Using Constrained Intermediate Dictionary of Results", *List of Publications Manually Reviewed for the Search of U.S. Pat. No. 7,177,798*, Mar. 22, 2013, 1 page.
- Extended European Search Report (includes European Search Report and European Search Opinion) received for European Patent Application No. 06256215.2, dated Feb. 20, 2007, 6 pages.
- Extended European Search Report (includes European Search Report and European Search Opinion) received for European Patent Application No. 12186113.2, dated Apr. 28, 2014, 14 pages.
- Extended European Search Report (includes Partial European Search Report and European Search Opinion) received for European Patent Application No. 13169672.6, dated Aug. 14, 2013, 11 pages.
- Extended European Search Report (includes Partial European Search Report and European Search Opinion) received for European Patent Application No. 15169349.6, dated Jul. 28, 2015, 8 pages.
- Extended European Search Report (includes Partial European Search Report and European Search Opinion) received for European Patent Application No. 15196748.6, dated Apr. 4, 2016.
- Extended European Search Report (includes Partial European Search Report and European Search Opinion) received for European Patent Application No. 16150079.8, dated Feb. 18, 2016, 7 pages.
- Extended European Search Report (includes Supplementary European Search Report and Search Opinion) received for European Patent Application No. 07863218.9, dated Dec. 9, 2010, 7 pages.
- Extended European Search Report (includes Supplementary European Search Report and Search Opinion) received for European Patent Application No. 12727027.0, dated Sep. 26, 2014, 7 pages.
- Extended European Search Report (inclusive of the Partial European Search Report and European Search Opinion) received for European Patent Application No. 12729332.2, dated Oct. 31, 2014, 6 pages.
- Extended European Search Report and Search Opinion received for European Patent Application No. 12185276.8, dated Dec. 18, 2012, 4 pages.
- Extended European Search Report received for European Patent Application No. 11159884.3, dated May 20, 2011, 8 pages.
- Extended European Search Report received for European Patent Application No. 11707939.2, dated Nov. 18, 2016, 13 pages.
- Extended European Search Report received for European Patent Application No. 12186663.6, dated Jul. 16, 2013, 6 pages.
- Extended European Search Report received for European Patent Application No. 13726938.7, dated Dec. 14, 2015, 8 pages.
- Extended European Search Report received for European Patent Application No. 13770552.1, dated Jan. 7, 2016, 5 pages.
- Extended European Search Report received for European Patent Application No. 14719914.5, dated Oct. 10, 2016, 7 pages.
- Extended European Search Report received for European Patent Application No. 14737370.8, dated May 19, 2016, 12 pages.
- Extended European Search Report received for European Patent Application No. 16186308.9, dated Jan. 16, 2017, 9 pages.
- Extended European Search Report received for European Patent Application No. 16188272.5, dated Nov. 18, 2016, 12 pages.
- Extended European Search Report received for European Patent Application No. 16195814.5, dated Jul. 5, 2017, 13 pages.
- Extended European Search Report received for European Patent Application No. 16198245.9, dated Feb. 22, 2017, 13 pages.
- Extended Search Report received for European Patent Application No. 16188055.4, dated Dec. 22, 2016, 8 pages.
- Feigenbaum et al., "Computer-Assisted Semantic Annotation of Scientific Life Works", Oct. 15, 2007, 22 pages.
- Findlater et al., "Beyond QWERTY: Augmenting Touch-Screen Keyboards with Multi-Touch Gestures for Non-Alphanumeric Input", *CHI '12*, Austin, Texas, USA, May 5-10, 2012, 4 pages.
- Finkel et al., "Joint Parsing and Named Entity Recognition", *Human Language Technologies: The 2009 Annual Conference of the North American Chapter of the ACL*, Jun. 2009, pp. 326-334.
- Gannes, Liz, "Alfred App Gives Personalized Restaurant Recommendations", *AllThingsD*, Jul. 18, 2011, pp. 1-3.
- Gervasio et al., "Active Preference Learning for Personalized Calendar Scheduling Assistance", *CiteSeerx*, *Proceedings of IUI'05*, Jan. 2005, pp. 90-97.
- Gilloire et al., "Innovative Speech Processing for Mobile Terminals: An Annotated Bibliography", *Signal Processing*, vol. 80, No. 7, Jul. 2000, pp. 1149-1166.
- Glass, Alyssa, "Explaining Preference Learning", *CiteSeerx*, 2006, pp. 1-5.
- Glossary of Adaptive Technologies: Word Prediction, available at <<http://www.utoronto.ca/atrc/reference/techwordpred.html>>, retrieved on Dec. 6, 2005, 5 pages.

(56)

References Cited

OTHER PUBLICATIONS

Gmail, "About Group Chat", available at <<http://mail.google.com/support/bin/answer.py?answer=81090>>, Nov. 26, 2007, 2 pages.

Gomez et al., "Mouth Gesture and Voice Command Based Robot Command Interface", IEEE International Conference on Robotics and Automation, May 12-17, 2009, pp. 333-338.

Gong et al., "Guidelines for Handheld Mobile Device Interface Design", Proceedings of DSI 2004 Annual Meeting, 2004, pp. 3751-3756.

Gruber et al., "Siri, a Virtual Personal Assistant Bringing Intelligence to the Interface", Available at URL:<https://web.archive.org/web/20090824055846/http://tomgruber.org/writing/Siri-SemTech09.pdf>, Aug. 24, 2009, 21 pages.

Gruber, Thomas R., et al., U.S Appl. No. 61/186,414, filed Jun. 12, 2009 titled "System and Method for Semantic Auto-Completion" 13 pages.

Gruber, Thomas R., et al., U.S Appl. No. 61/493,201, filed Jun. 3, 2011 titled "Generating and Processing Data Items That Represent Tasks to Perform", 68 pages.

Gruber, Thomas R., et al., Unpublished U.S. Appl. No. 61/657,744, filed Jun. 9, 2012 titled "Automatically Adapting User Interfaces for Hands-Free Interaction", 40 pages.

Gruber, Tom, "(Avoiding) The Travesty of the Commons", Presentation at NPUC, New Paradigms for User Computing, IBM Almaden Research Center, Jul. 24, 2006, 52 pages.

Gruber, Tom, "2021: Mass Collaboration and the Really New Economy", TNTY Futures, vol. 1, No. 6, Available online at <<http://tomgruber.org/writing/tnty2001.htm>>, Aug. 2001, 5 pages.

Gruber, Tom, "Big Think Small Screen: How Semantic Computing in the Cloud will Revolutionize the Consumer Experience on the Phone", Keynote Presentation at Web 3.0 Conference, Jan. 2010, 41 pages.

Gruber, Tom, "Collective Knowledge Systems: Where the Social Web Meets the Semantic Web", Web Semantics: Science, Services and Agents on the World Wide Web, 2007, pp. 1-19.

Gruber, Tom, "Despite Our Best Efforts, Ontologies are not the Problem", AAAI Spring Symposium, Available online at <<http://tomgruber.org/writing/aaai-ss08.htm>>, Mar. 2008, pp. 1-40.

Gruber, Tom, "Enterprise Collaboration Management with Intraspect", Intraspect Technical White Paper, Jul. 2001, pp. 1-24.

Gruber, Tom, "Every Ontology is a Treaty—A Social Agreement—Among People with Some Common Motive in Sharing", Official Quarterly Bulletin of AIS Special Interest Group on Semantic Web and Information Systems, vol. 1, No. 3, 2004, pp. 1-5.

Gruber, Tom, "Helping Organizations Collaborate, Communicate, and Learn", Presentation to NASA Ames Research, Available online at <<http://tomgruber.org/writing/organizational-intelligence-talk.htm>>, Mar.-Oct. 2003, 30 pages.

Gruber, Tom, "Intelligence at the Interface: Semantic Technology and the Consumer Internet Experience", Presentation at Semantic Technologies Conference, Available online at <<http://tomgruber.org/writing/semtech08.htm>>, May 20, 2008, pp. 1-40.

Gruber, Tom, "It Is What It Does: The Pragmatics of Ontology for Knowledge Sharing", Proceedings of the International CIDOC CRM Symposium, Available online at <<http://tomgruber.org/writing/cidoc-ontology.htm>>, Mar. 26, 2003, 21 pages.

Gruber, Tom, "Ontologies, Web 2.0 and Beyond", Ontology Summit, Available online at <<http://tomgruber.org/writing/ontolog-social-web-keynote.htm>>, Apr. 2007, 17 pages.

Gruber, Tom, "Ontology of Folksonomy: A Mash-Up of Apples and Oranges", Int'l Journal on Semantic Web & Information Systems, vol. 3, No. 2, 2007, 7 pages.

Gruber, Tom, "Siri, A Virtual Personal Assistant-Bringing Intelligence to the Interface", Semantic Technologies Conference, Jun. 16, 2009, 21 pages.

Gruber, Tom, "TagOntology", Presentation to Tag Camp, Oct. 29, 2005, 20 pages.

Gruber, Tom, "Where the Social Web Meets the Semantic Web", Presentation at the 5th International Semantic Web Conference, Nov. 2006, 38 pages.

Guay, Matthew, "Location-Driven Productivity with Task Ave", available at <<http://iphone.appstorm.net/reviews/productivity/location-driven-productivity-with-task-ave/>>, Feb. 19, 2011, 7 pages.

Guim, Mark, "How to Set a Person-Based Reminder with Cortana", available at <<http://www.wpcentral.com/how-to-person-based-reminder-cortana>>, Apr. 26, 2014, 15 pages.

Gurevych et al., "Semantic Coherence Scoring Using an Ontology", North American Chapter of the Association for Computational Linguistics Archive, Proceedings of the 2003 Conference of the North American Chapter of the Association for Computational Linguistics on Human Language Technology, May 27, 2003, 8 pages.

Guzzoni et al., "A Unified Platform for Building Intelligent Web Interaction Assistants", Proceedings of the 2006 IEEE/WIC/ACM International Conference on Web Intelligence and Intelligent Agent Technology, Computer Society, 2006, 4 pages.

Guzzoni et al., "Active, A Platform for Building Intelligent Operating Rooms", Surgetica 2007 Computer-Aided Medical Interventions: Tools and Applications, 2007, pp. 191-198.

Guzzoni et al., "Active, A platform for Building Intelligent Software", Computational Intelligence, available at <<http://www.informatik.uni-trier.de/~pers/hd/g/Guzzoni:Didier>>, 2006, 5 pages.

Guzzoni et al., "Active, A Tool for Building Intelligent User Interfaces", ASC 2007, Palma de Mallorca, Aug. 2007, 6 pages.

Guzzoni et al., "Modeling Human-Agent Interaction with Active Ontologies", AAAI Spring Symposium, Interaction Challenges for Intelligent Assistants, Stanford University, Palo Alto, California, 2007, 8 pages.

Guzzoni, D., "Active: A Unified Platform for Building Intelligent Assistant Applications", Oct. 25, 2007, 262 pages.

Haga et al., "A Usability Survey of a Contents-Based Video Retrieval System by Combining Digital Video and an Electronic Bulletin Board", The Internet and Higher Education, vol. 8, No. 3, 2005, pp. 251-262.

Hain et al., "The Papageno TTS System", Siemens AG, Corporate Technology, Munich, Germany TC-STAR Workshop, 2006, 6 pages.

Haitsma et al., "A Highly Robust Audio Fingerprinting System", In Proceedings of the International Symposium on Music Information Retrieval (ISMIR), 2002, 9 pages.

Hardwar, Devindra, "Driving App Waze Builds its own Siri for Hands-Free Voice Control", Available online at <<http://venturebeat.com/2012/02/09/driving-app-waze-builds-its-own-siri-for-hands-free-voice-control/>>, retrieved on Feb. 9, 2012, 4 pages.

Hashimoto, Yoshiyuki, "Simple Guide for iPhone Siri, Which Can Be Operated with Your Voice", Shuwa System Co., Ltd., vol. 1, Jul. 5, 2012, pp. 8, 130, 131.

Hawkins et al., "Hierarchical Temporal Memory: Concepts, Theory and Terminology", Numenta, Inc., Mar. 27, 2007, 20 pages.

He et al., "A data-driven spoken language understanding system", 2003 IEEE Workshop on Automatic Speech Recognition and Understanding, 2003, pp. 583-588.

Headset Button Controller v7.3 APK Full APP Download for Android, Blackberry, iPhone, 11 pages.

Hear voice from Google translate, Available on URL:<https://www.youtube.com/watch?v=18AvMhFqD28>, Jan. 28, 2011, 1 page.

Hendrickson, Bruce, "Latent Semantic Analysis and Fiedler Retrieval", Linear Algebra and its Applications, vol. 421, 2007, pp. 345-355.

Hodjat et al., "Iterative Statistical Language Model Generation for use with an Agent-Oriented Natural Language Interface", Proceedings of HCI International, vol. 4, 2003, pp. 1422-1426.

Huang et al., "A Novel Approach to Robust Speech Endpoint Detection in Car Environments", Acoustics, Speech, and Signal Processing 2000, Icaspp '00, Proceeding S. 2000 IEEE International Conference on Jun. 5-9, 2000, vol. 3, Jun. 5, 2000, pp. 1751-1754.

iAP Sports Lingo 0x09 Protocol V1.00, May 1, 2006, 17 pages.

IBM, "Why Buy: ThinkPad", available at <<http://www.pc.ibm.com/us/thinkpad/easeofuse.html>>, retrieved on Dec. 19, 2002, 2 pages.

Ichat AV, "Video Conferencing for the Rest of Us", Apple—Mac OS X—iChat AV, available at <<http://www.apple.com/macosx/features/ichat/>>, retrieved on Apr. 13, 2006, 3 pages.

(56)

References Cited

OTHER PUBLICATIONS

id3.org, "id3v2.4.0-Frames", available at <<http://id3.oreid3v2.4.0-frames?action=print>>, retrieved on Jan. 22, 2015, 41 pages.

IEEE 1394 (Redirected from Firewire, Wikipedia, The Free Encyclopedia, available at <<http://www.wikipedia.org/wiki/Firewire>>, retrieved on Jun. 8, 2003, 2 pages.

Interactive Voice, available at <<http://www.helloivee.com/company/>>, retrieved on Feb. 10, 2014, 2 pages.

Guay, Matthew, "Location-Driven Productivity with Task Ave", available at <<http://iphone.appstorm.net/reviews/productivity/location-driven-productivity-with-task-ave/>>, Feb. 19, 2011, 7 pages.

International Preliminary Report on Patentability received for PCT Patent Application No. PCT/US2004/002873, dated Feb. 1, 2006, 5 pages.

International Preliminary report on Patentability received for PCT Patent Application No. PCT/US2004/016519, dated Jan. 23, 2006, 12 pages.

International Preliminary Report on Patentability received for PCT Patent Application No. PCT/US2005/030234, dated Mar. 20, 2007, 9 pages.

International Preliminary Report on Patentability received for PCT Patent Application No. PCT/US2008/000042, dated Jul. 7, 2009, 6 pages.

International Preliminary Report on Patentability received for PCT Patent Application No. PCT/US2008/000043, dated Jul. 7, 2009, 8 pages.

International Preliminary Report on Patentability received for PCT Patent Application No. PCT/US2008/000047, dated Jul. 7, 2009, 8 pages.

International Preliminary Report on Patentability received for PCT Patent Application No. PCT/US2009/051954, dated Mar. 24, 2011, 8 pages.

International Preliminary Report on Patentability received for PCT Patent Application No. PCT/US2009/055577, completed on Aug. 6, 2010, 12 pages.

International Preliminary Report on Patentability received for PCT Patent Application No. PCT/US2010/037378, dated Dec. 6, 2011, 9 pages.

International Preliminary Report on Patentability received for PCT Patent Application No. PCT/US2011/020350, dated Jul. 17, 2012, 12 pages.

International Preliminary Report on Patentability received for PCT Patent Application No. PCT/US2011/020825, dated Jan. 13, 2012, 17 pages.

International Preliminary Report on Patentability received for PCT Patent Application No. PCT/US2011/020861, dated Aug. 2, 2012, 11 pages.

International Preliminary Report on Patentability received for PCT Patent Application No. PCT/US2011/037014, dated Dec. 13, 2012, 10 pages.

International Preliminary Report on Patentability received for PCT Patent Application No. PCT/US2012/029810, dated Oct. 3, 2013, 9 pages.

International Preliminary Report on Patentability received for PCT Patent Application No. PCT/US2012/034028, dated Oct. 31, 2013, 7 pages.

International Preliminary Report on Patentability received for PCT Patent Application No. PCT/US2012/040571, dated Dec. 19, 2013, 10 pages.

International Preliminary Report on Patentability received for PCT Patent Application No. PCT/US2012/040801, dated Dec. 19, 2013, 16 pages.

International Preliminary Report on Patentability received for PCT Patent Application No. PCT/US2012/040931, dated Dec. 18, 2014, 9 pages.

International Preliminary Report on Patentability received for PCT Patent Application No. PCT/US2012/043098, dated Jan. 9, 2014, 8 pages.

International Preliminary Report on Patentability received for PCT Patent Application No. PCT/US2012/043100, dated Jan. 9, 2014, 7 pages.

International Preliminary Report on Patentability received for PCT Patent Application No. PCT/US2012/056382, dated Apr. 10, 2014, 9 pages.

International Preliminary Report on Patentability received for PCT Patent Application No. PCT/US2013/028412, dated Sep. 12, 2014, 12 pages.

International Preliminary Report on Patentability received for PCT Patent Application No. PCT/US2013/028920, dated Sep. 18, 2014, 11 pages.

International Preliminary Report on Patentability received for PCT Patent Application No. PCT/US2013/029156, dated Sep. 9, 2014, 7 pages.

International Preliminary Report on Patentability received for PCT Patent Application No. PCT/US2013/041225, dated Nov. 27, 2014, 9 pages.

International Preliminary Report on Patentability received for PCT Patent Application No. PCT/US2013/041233, dated Nov. 18, 2014, 8 pages.

International Preliminary Report on Patentability received for PCT Patent Application No. PCT/US2013/044574, dated Dec. 9, 2014, 8 pages.

International Preliminary Report on Patentability received for PCT Patent Application No. PCT/US2013/044834, dated Dec. 9, 2014, 9 pages.

International Preliminary Report on Patentability received for PCT Patent Application No. PCT/US2013/047659, dated Dec. 31, 2014, 15 pages.

International Preliminary Report on Patentability received for PCT Patent Application No. PCT/US2013/047668, dated Jan. 8, 2015, 13 pages.

International Preliminary Report on Patentability received for PCT Patent Application No. PCT/US2013/052558, dated Feb. 12, 2015, 12 pages.

International Preliminary Report on Patentability received for PCT Patent Application No. PCT/US2013/058916, dated Mar. 19, 2015, 8 pages.

International Preliminary Report on Patentability received for PCT Patent Application No. PCT/US2013/060121, dated Apr. 2, 2015, 6 pages.

International Preliminary Report on Patentability received for PCT Patent Application No. PCT/US2014/015418, dated Aug. 20, 2015, 12 pages.

International Preliminary Report on Patentability received for PCT Patent Application No. PCT/US2014/016988, dated Sep. 3, 2015, 8 pages.

International Preliminary Report on Patentability received for PCT Patent Application No. PCT/US2014/023822, dated Sep. 24, 2015, 12 pages.

International Preliminary Report on Patentability received for PCT Patent Application No. PCT/US2014/023826, dated Sep. 24, 2015, 9 pages.

International Preliminary Report on Patentability received for PCT Patent Application No. PCT/US2014/026871, dated Sep. 24, 2015, 7 pages.

International Preliminary Report on Patentability received for PCT Patent Application No. PCT/US2014/026873, dated Sep. 24, 2015, 9 pages.

International Preliminary Report on Patentability received for PCT Patent Application No. PCT/US2014/028785, dated Sep. 24, 2015, 15 pages.

International Preliminary Report on Patentability received for PCT Patent Application No. PCT/US2014/028950, dated Sep. 24, 2015, 8 pages.

International Preliminary Report on Patentability received for PCT Patent Application No. PCT/US2014/029050, dated Sep. 24, 2015, 7 pages.

International Preliminary Report on Patentability received for PCT Patent Application No. PCT/US2014/029562, dated Sep. 24, 2015, 16 pages.

(56)

References Cited

OTHER PUBLICATIONS

International Preliminary Report on Patentability received for PCT Patent Application No. PCT/US2014/040393, dated Dec. 8, 2015, 15 pages.

International Preliminary Report on Patentability received for PCT Patent Application No. PCT/US2014/040394, dated Dec. 23, 2015, 7 pages.

International Preliminary Report on Patentability received for PCT Patent Application No. PCT/US2014/040397, dated Dec. 17, 2015, 8 pages.

International Preliminary Report on Patentability received for PCT Patent Application No. PCT/US2014/040401, dated Dec. 8, 2015, 6 pages.

International Preliminary Report on Patentability received for PCT Patent Application No. PCT/US2014/040403, dated Dec. 23, 2015, 7 pages.

International Preliminary Report on Patentability received for PCT Patent Application No. PCT/US2014/040961, dated Dec. 17, 2015, 20 pages.

International Preliminary Report on Patentability received for PCT Patent Application No. PCT/US2014/041159, dated Dec. 17, 2015, 8 pages.

International Preliminary Report on Patentability received for PCT Patent Application No. PCT/US2014/041173, dated Dec. 17, 2015, 9 pages.

International Preliminary Report on Patentability received for PCT Patent Application No. PCT/US2014/049568, dated Feb. 18, 2016, 10 pages.

International Preliminary Report on Patentability received for PCT Patent Application No. PCT/US2015/023089, dated Jan. 12, 2017, 12 pages.

International Preliminary Report on Patentability received for PCT Patent Application No. PCT/US2015/023097, dated Jan. 12, 2017, 11 pages.

International Preliminary Report on Patentability received for PCT Patent Application No. PCT/US2015/023593, dated Dec. 15, 2016, 12 pages.

International Preliminary Report on Patentability received for PCT Patent Application No. PCT/US2015/029554, dated Dec. 29, 2016, 8 pages.

International Preliminary Report on Patentability Received for PCT Patent Application No. PCT/US2015/032470, dated Dec. 15, 2016, 9 pages.

International Preliminary Report on Patentability received for PCT Patent Application No. PCT/US2015/032724, dated Dec. 15, 2016, 8 pages.

International Preliminary Report on Patentability received for PCT Patent Application No. PCT/US2015/033051, dated Dec. 15, 2016, 10 pages.

International Preliminary Report on Patentability received for PCT Patent Application No. PCT/US2015/047062, dated Mar. 9, 2017, 18 pages.

International Preliminary Report on Patentability received for PCT Patent Application No. PCT/US2015/047064, dated Mar. 23, 2017, 9 pages.

International Preliminary Report on Patentability received for PCT Patent Application No. PCT/US2015/047281, dated Apr. 13, 2017, 13 pages.

International Preliminary Report on Patentability received for PCT Patent Application No. PCT/US2015/047553, dated Apr. 13, 2017, 7 pages.

International Preliminary Report on Patentability received for PCT Patent Application No. PCT/US2015/047583, dated Apr. 13, 2017, 7 pages.

International Preliminary Report on Patentability received for PCT Patent Application No. PCT/US2015/047584, dated Apr. 13, 2017, 7 pages.

International Preliminary Report on Patentability received for PCT Patent Application No. PCT/US2016/021103, dated Sep. 21, 2017, 11 pages.

International Preliminary Report on Patentability received for PCT Patent Application No. PCT/US2016/021104, dated Sep. 21, 2017, 11 pages.

International Preliminary Report on Patentability received for PCT Patent Application No. PCT/US2016/021409, dated Sep. 21, 2017, 16 pages.

International Preliminary Report on Patentability received for PCT Patent Application No. PCT/US2016/021410, dated Sep. 21, 2017, 12 pages.

International Preliminary Report on Patentability received for PCT Patent Application No. PCT/US2016/23312, dated Sep. 28, 2017, 5 pages.

International Search Report & Written Opinion received for PCT Patent Application No. PCT/US2016/021410, dated Jul. 26, 2016, 19 pages.

International Search Report and Written Opinion received for PCT Patent Application No. PCT/US16/23312, dated Jun. 27, 2016, 7 pages.

International Search Report and Written Opinion received for PCT Patent Application No. PCT/US2004/002873, dated Oct. 13, 2005, 7 pages.

International Search Report and Written Opinion received for PCT Patent Application No. PCT/US2004/016519, dated Nov. 3, 2005, 6 pages.

International Search Report and Written Opinion received for PCT Patent Application No. PCT/US2005/030234, dated Mar. 17, 2006, 11 pages.

International Search Report and Written Opinion received for PCT Patent Application No. PCT/US2005/038819, dated Apr. 5, 2006, 12 pages.

International Search Report and Written Opinion received for PCT Patent Application No. PCT/US2006/048669, dated Jul. 2, 2007, 12 pages.

International Search Report and Written Opinion received for PCT Patent Application No. PCT/US2006/048670, dated May 21, 2007, 11 pages.

International Search Report and Written Opinion received for PCT Patent Application No. PCT/US2006/048753, dated Jun. 19, 2007, 15 pages.

International Search Report and Written Opinion received for PCT Patent Application No. PCT/US2007/026243, dated Mar. 31, 2008, 10 pages.

International Search Report and Written Opinion received for PCT Patent Application No. PCT/US2007/088872, dated May 8, 2008, 8 pages.

International Search Report and Written Opinion received for PCT Patent Application No. PCT/US2007/088873, dated May 8, 2008, 7 pages.

International Search Report and Written Opinion received for PCT Patent Application No. PCT/US2008/000032, dated Jun. 12, 2008, 7 pages.

International Search Report and Written Opinion received for PCT Patent Application No. PCT/US2008/000042, dated May 21, 2008, 7 pages.

International Search Report and Written Opinion received for PCT Patent Application No. PCT/US2008/000043, dated Oct. 10, 2008, 12 pages.

International Search Report and Written Opinion received for PCT Patent Application No. PCT/US2008/000045, dated Jun. 12, 2008, 7 pages.

International Search Report and Written Opinion received for PCT Patent Application No. PCT/US2008/000047, dated Sep. 11, 2008, 12 pages.

International Search Report and Written Opinion received for PCT Patent Application No. PCT/US2008/000059, dated Sep. 19, 2008, 18 pages.

International Search Report and Written Opinion received for PCT Patent Application No. PCT/US2008/000061, dated Jul. 1, 2008, 13 pages.

International Search Report and Written Opinion received for PCT Patent Application No. PCT/US2009/051954, dated Oct. 30, 2009, 10 pages.

(56)

References Cited

OTHER PUBLICATIONS

International Search Report and Written Opinion received for PCT Patent Application No. PCT/US2009/055577, dated Jan. 26, 2010, 9 pages.

International Search Report and Written Opinion received for PCT Patent Application No. PCT/US2010/037378, dated Aug. 25, 2010, 14 pages.

International Search Report and Written Opinion received for PCT Patent Application No. PCT/US2011/020350, dated Jun. 30, 2011, 17 pages.

International Search Report and Written Opinion received for PCT Patent Application No. PCT/US2011/020825, dated Mar. 18, 2011, 9 pages.

International Search Report and Written Opinion received for PCT Patent Application No. PCT/US2011/020861, dated Nov. 29, 2011, 12 pages.

International Search Report and Written Opinion received for PCT Patent Application No. PCT/US2012/029810, dated Aug. 17, 2012, 11 pages.

International Search Report and Written Opinion received for PCT Patent Application No. PCT/US2012/034028, dated Jun. 11, 2012, 9 pages.

International Search Report and Written Opinion received for PCT Patent Application No. PCT/US2012/040571, dated Nov. 16, 2012, 14 pages.

International Search Report and Written Opinion received for PCT Patent Application No. PCT/US2012/040801, dated Oct. 22, 2012, 20 pages.

International Search Report and Written Opinion received for PCT Patent Application No. PCT/US2012/040931, dated Feb. 1, 2013, 4 pages. (International Search Report only).

International Search Report and Written Opinion received for PCT Patent Application No. PCT/US2012/043098, dated Nov. 14, 2012, 9 pages.

International Search Report and Written Opinion received for PCT Patent Application No. PCT/US2012/043100, dated Nov. 15, 2012, 8 pages.

International Search Report and Written Opinion received for PCT Patent Application No. PCT/US2012/056382, dated Dec. 20, 2012, 11 pages.

International Search Report and Written Opinion received for PCT Patent Application No. PCT/US2013/028412, dated Sep. 26, 2013, 17 pages.

International Search Report and Written Opinion received for PCT Patent Application No. PCT/US2013/028920, dated Jun. 27, 2013, 14 pages.

International Search Report and Written Opinion received for PCT Patent Application No. PCT/US2013/029156, dated Jul. 15, 2013, 9 pages.

International Search Report and Written Opinion received for PCT Patent Application No. PCT/US2013/040971, dated Nov. 12, 2013, 11 pages.

International Search Report and Written Opinion received for PCT Patent Application No. PCT/US2013/041225, dated Aug. 23, 2013, 3 pages. (International Search Report only).

International Search Report and Written Opinion received for PCT Patent Application No. PCT/US2013/044574, dated Sep. 27, 2013, 12 pages.

International Search Report and Written Opinion received for PCT Patent Application No. PCT/US2013/044834, dated Dec. 20, 2013, 13 pages.

International Search Report and Written Opinion received for PCT Patent Application No. PCT/US2013/047659, dated Jul. 7, 2014, 25 pages.

International Search Report and Written Opinion received for PCT Patent Application No. PCT/US2013/047668, dated Feb. 13, 2014, 17 pages.

International Search Report and Written Opinion received for PCT Patent Application No. PCT/US2013/052558, dated Jan. 30, 2014, 15 pages.

International Search Report and Written Opinion received for PCT Patent Application No. PCT/US2013/058916, dated Sep. 8, 2014, 10 pages.

International Search Report and Written Opinion received for PCT Patent Application No. PCT/US2013/060121, dated Dec. 6, 2013, 8 pages.

International Search Report and Written Opinion received for PCT Patent Application No. PCT/US2014/015418, dated Aug. 26, 2014, 17 pages.

International Search Report and Written Opinion received for PCT Patent Application No. PCT/US2014/016988, dated Apr. 29, 2014, 10 pages.

International Search Report and Written Opinion received for PCT Patent Application No. PCT/US2014/023822, dated Sep. 25, 2014, 14 pages.

International Search Report and Written Opinion received for PCT Patent Application No. PCT/US2014/023826, dated Oct. 9, 2014, 13 pages.

International Search Report and Written Opinion received for PCT Patent Application No. PCT/US2014/026871, dated Jul. 23, 2014, 9 pages.

International Search Report and Written Opinion received for PCT Patent Application No. PCT/US2014/026873, dated Jan. 5, 2015, 11 pages.

International Search Report and Written Opinion received for PCT Patent Application No. PCT/US2014/028785, dated Oct. 17, 2014, 23 pages.

International Search Report and Written Opinion received for PCT Patent Application No. PCT/US2014/028950, dated Nov. 25, 2014, 10 pages.

International Search Report and Written Opinion received for PCT Patent Application No. PCT/US2014/029050, dated Jul. 31, 2014, 9 pages.

International Search Report and Written Opinion received for PCT Patent Application No. PCT/US2014/029562, dated Sep. 18, 2014, 21 pages.

International Search Report and Written Opinion received for PCT Patent Application No. PCT/US2014/040393, dated Dec. 8, 2014, 23 pages.

International Search Report and Written Opinion received for PCT Patent Application No. PCT/US2014/040394, dated Aug. 8, 2014, 11 pages.

International Search Report and Written Opinion received for PCT Patent Application No. PCT/US2014/040397, dated Aug. 27, 2014, 12 pages.

International Search Report and Written Opinion received for PCT Patent Application No. PCT/US2014/040401, dated Sep. 4, 2014, 10 pages.

International Search Report and Written Opinion received for PCT Patent Application No. PCT/US2014/040403, dated Sep. 23, 2014, 9 pages.

International Search Report and Written Opinion received for PCT Patent Application No. PCT/US2014/040961, dated Mar. 10, 2015, 5 pages.

International Search Report and Written Opinion received for PCT Patent Application No. PCT/US2014/041159, dated Sep. 26, 2014, 10 pages.

International Search Report and Written Opinion received for PCT Patent Application No. PCT/US2014/041173, dated Sep. 10, 2014, 11 pages.

International Search Report and Written Opinion received for PCT Patent Application No. PCT/US2014/049568, dated Nov. 14, 2014, 12 pages.

International Search Report and Written Opinion received for PCT Patent Application No. PCT/US2014/053951, dated Dec. 8, 2014, 11 pages.

International Search Report and Written Opinion received for PCT Patent Application No. PCT/US2014/053957, dated Feb. 19, 2015, 11 pages.

International Search Report and Written Opinion received for PCT Patent Application No. PCT/US2014/053958, dated Feb. 19, 2015, 10 pages.

(56)

References Cited

OTHER PUBLICATIONS

International Search Report and Written Opinion received for PCT Patent Application No. PCT/US2015/019320, dated Jul. 2, 2015, 14 pages.

International Search Report and Written Opinion received for PCT Patent Application No. PCT/US2015/019321, dated Jun. 3, 2015, 11 pages.

International Search Report and Written Opinion received for PCT Patent Application No. PCT/US2015/019322, dated Jun. 18, 2015, 16 pages.

International Search Report and Written Opinion received for PCT Patent Application No. PCT/US2015/023089, dated Aug. 20, 2015, 16 pages.

International Search Report and Written Opinion received for PCT Patent Application No. PCT/US2015/023097, dated Jul. 7, 2015, 15 pages.

International Search Report and Written Opinion received for PCT Patent Application No. PCT/US2015/023593, dated Aug. 14, 2015, 16 pages.

International Search Report and Written Opinion received for PCT Patent Application No. PCT/US2015/025188, dated Jun. 23, 2015, 11 pages.

International Search Report and Written Opinion received for PCT Patent Application No. PCT/US2015/029554, dated Jul. 16, 2015, 11 pages.

International Search Report and Written Opinion received for PCT Patent Application No. PCT/US2015/032470, dated Oct. 1, 2015, 13 pages.

International Search Report and Written Opinion received for PCT Patent Application No. PCT/US2015/032724, dated Jul. 27, 2015, 11 pages.

International Search Report and Written Opinion received for PCT Patent Application No. PCT/US2015/033051, dated Aug. 5, 2015, 14 pages.

International Search Report and Written Opinion received for PCT Patent Application No. PCT/US2015/047062, dated Jan. 13, 2016, 25 pages.

International Search Report and Written Opinion received for PCT Patent Application No. PCT/US2015/047064, dated Nov. 13, 2015, 13 pages.

International Search Report and Written Opinion received for PCT Patent Application No. PCT/US2015/047281, dated Dec. 17, 2015, 19 pages.

International Search Report and Written Opinion received for PCT Patent Application No. PCT/US2015/047553, dated Jan. 5, 2016, 10 pages.

International Search Report and Written opinion received for PCT Patent Application No. PCT/US2015/047583, dated Feb. 3, 2016, 11 pages.

International Search Report and Written Opinion received for PCT Patent Application No. PCT/US2015/047584, dated Nov. 9, 2015, 10 pages.

International Search Report and Written Opinion received for PCT Patent Application No. PCT/US2015/053365, dated Mar. 10, 2016, 20 pages.

International Search Report and Written Opinion received for PCT Patent Application No. PCT/US2015/053366, dated Apr. 26, 2016, 16 pages.

International Search Report and Written Opinion received for PCT Patent Application No. PCT/US2016/021103, dated Jun. 8, 2016, 15 pages.

International Search Report and Written Opinion received for PCT Patent Application No. PCT/US2016/021104, dated Jun. 8, 2016, 15 pages.

International Search Report and Written opinion received for PCT Patent Application No. PCT/US2016/021409, dated May 26, 2016, 22 pages.

International Search report and Written Opinion received for PCT Patent Application No. PCT/US2016/024666, dated Jun. 10, 2016, 13 pages.

International Search Report and Written Opinion received for PCT Patent Application No. PCT/US2016/025404, dated Jun. 24, 2016, 21 pages.

International Search Report and Written Opinion received for PCT Patent Application No. PCT/US2016/025407, dated Jun. 23, 2016, 18 pages.

International Search Report and Written Opinion received for PCT Patent Application No. PCT/US2016/025408, dated Aug. 11, 2016, 19 pages.

International Search Report and Written Opinion received for PCT Patent Application No. PCT/US2016/031059, dated Aug. 8, 2016, 11 pages.

International Search Report and Written Opinion received for PCT Patent Application No. PCT/US2016/031549, dated Aug. 5, 2016, 35 pages.

International Search Report and Written Opinion received for PCT Patent Application No. PCT/US2016/031550, dated Aug. 4, 2016, 13 pages.

International Search Report and Written Opinion received for PCT Patent Application No. PCT/US2016/035105, dated Aug. 29, 2016, 25 pages.

International Search Report and Written Opinion received for PCT Patent Application No. PCT/US2016/035107, dated Aug. 31, 2016, 26 pages.

International Search Report and Written Opinion received for PCT Patent Application No. PCT/US2016/035112, dated Aug. 22, 2016, 21 pages.

International Search Report and Written Opinion received for PCT Patent Application No. PCT/US2016/043005, dated Oct. 7, 2016, 17 pages.

International Search Report and Written Opinion Received for PCT Patent Application No. PCT/US2016/047184, dated Jan. 17, 2017, 22 pages.

International Search Report and Written Opinion received for PCT Patent Application No. PCT/US2016/047215, dated Oct. 24, 2016, 18 pages.

International Search Report and Written Opinion Received for PCT Patent Application No. PCT/US2016/051151, dated Nov. 22, 2016, 10 pages.

International Search Report and Written Opinion received for PCT Patent Application No. PCT/US2016/051927, dated Feb. 6, 2017, 17 pages.

International Search Report and Written Opinion received for PCT Patent Application No. PCT/US2016/053445, dated Dec. 6, 2016, 11 pages.

International Search Report and Written Opinion Received for PCT Patent Application No. PCT/US2016/054459, dated Dec. 29, 2016, 8 pages.

International Search Report and Written Opinion received for PCT Patent Application No. PCT/US2016/055914, dated Jan. 17, 2017, 10 pages.

International Search Report and Written Opinion received for PCT Patent Application No. PCT/US2016/056510, dated Jan. 9, 2017, 9 pages.

International Search Report and Written Opinion received for PCT Patent Application No. PCT/US2016/064452, dated Feb. 16, 2017, 23 pages.

International Search Report and Written Opinion received for PCT Patent Application No. PCT/US2017/019332, dated May 18, 2017, 9 pages.

International Search Report received for PCT Patent Application No. PCT/GB2009/051684, dated Mar. 12, 2010, 4 pages.

International Search Report received for PCT Patent Application No. PCT/US2002/024669, dated Nov. 5, 2002, 3 pages.

International Search Report received for PCT Patent Application No. PCT/US2002/024670, dated Sep. 26, 2002, 3 pages.

International Search Report received for PCT Patent Application No. PCT/US2002/033330, dated Feb. 4, 2003, 6 pages.

International Search Report received for PCT Patent Application No. PCT/US2005/046797, dated Nov. 24, 2006, 6 pages.

International Search Report received for PCT Patent Application No. PCT/US2011/037014, dated Oct. 4, 2011, 6 pages.

(56)

References Cited

OTHER PUBLICATIONS

International Search Report received for PCT Patent Application No. PCT/US2013/041233, dated Nov. 22, 2013, 3 pages.

Invitation to Pay Additional Fee Received for PCT Patent Application No. PCT/US2016/047184, dated Dec. 6, 2016, 9 pages.

Invitation to Pay Additional Fee Received for PCT Patent Application No. PCT/US2016/051927, dated Nov. 15, 2016, 2 pages.

Invitation to Pay Additional Fees and Partial International Search Report received for PCT Patent Application No. PCT/US2004/016519, dated Aug. 4, 2005, 6 pages.

Invitation to Pay Additional Fees and Partial International Search Report received for PCT Patent Application No. PCT/US2005/046797, dated Jul. 3, 2006, 6 pages.

Invitation to Pay Additional Fees and Partial International Search Report received for PCT Patent Application No. PCT/US2006/048738, dated Jul. 10, 2007, 4 pages.

Invitation to Pay Additional Fees and Partial International Search Report received for PCT Patent Application No. PCT/US2011/020350, dated Apr. 14, 2011, 5 pages.

Invitation to Pay Additional Fees and Partial International Search Report received for PCT Patent Application No. PCT/US2015/023089, dated Jun. 17, 2015, 7 pages.

Invitation to Pay Additional Fees received for PCT Application No. PCT/US2016/021410, dated Apr. 28, 2016, 2 pages.

Invitation to Pay Additional Fees received for PCT Patent Application No. PCT/US2008/000043, dated Jun. 27, 2008, 4 pages.

Invitation to Pay Additional Fees received for PCT Patent Application No. PCT/US2008/000047, dated Jul. 4, 2008, 4 pages.

Invitation to Pay Additional Fees received for PCT Patent Application No. PCT/US2011/037014, dated Aug. 2, 2011, 6 pages.

Invitation to Pay Additional Fees received for PCT Patent Application No. PCT/US2012/040801, dated Aug. 8, 2012, 2 pages.

Invitation to Pay Additional Fees received for PCT Patent Application No. PCT/US2013/047659, dated Feb. 27, 2014, 7 pages.

Invitation to Pay Additional Fees received for PCT Patent Application No. PCT/US2013/052558, dated Nov. 7, 2013, 6 pages.

Invitation to pay additional fees received for PCT Patent Application No. PCT/US2014/029562, dated Jul. 4, 2014, 7 pages.

Invitation to Pay Additional Fees received for PCT Patent Application No. PCT/US2014/040393, dated Sep. 17, 2014, 7 pages.

Invitation to Pay Additional Fees received for PCT Patent Application No. PCT/US2014/040961, dated Jan. 14, 2015, 3 pages.

Invitation to Pay Additional Fees received for PCT Patent Application No. PCT/US2015/047281, dated Oct. 8, 2015, 6 pages.

Invitation to Pay Additional Fees received for PCT Patent Application No. PCT/US2015/053366, dated Feb. 19, 2016, 8 pages.

Invitation to Pay Additional Fees received for PCT Patent Application No. PCT/US2016/025408, dated May 13, 2016, 2 pages.

Invitation to Pay Additional Fees received for PCT Patent Application No. PCT/US2014/028785, dated Jul. 4, 2014, 7 pages.

Invitation to pay additional fees received for the PCT Patent Application No. PCT/US2014/015418, dated May 26, 2014, 5 pages.

Iowegian International, "FIR Filter Properties, DSPGuru, Digital Signal Processing Central", available at <<http://www.dspguru.com/dsp/faq/fir/properties>> retrieved on Jul. 28, 2010, 6 pages.

iPhone Hacks, "Native iPhone MMS Application Released", available at <<http://www.iphonhacks.com/2007/12/iphone-mms-app.html>>, retrieved on Dec. 25, 2007, 5 pages.

iPhonechat, "iChat for iPhone in JavaScript", available at <<http://www.publicity.com/iPhoneChat/>>, retrieved on Dec. 25, 2007, 2 pages.

Iso-Sipila et al., "Multi-Lingual Speaker-Independent Voice User Interface for Mobile Devices", ICASSP 2006 Proceedings, IEEE International Conference on Acoustics, Speech and Signal Processing May 14, 2006, pp. 1-1081.

Jabra Corporation, "FreeSpeak: BT200 User Manual", 2002, 42 pages.

Jabra, "Bluetooth Headset: User Manual", 2005, 17 pages.

Jabra, "Bluetooth Introduction", 2004, 15 pages.

Jawaid et al., "Machine Translation with Significant Word Reordering and Rich Target-Side Morphology", WDS'11 Proceedings of Contributed Papers, Part I, 2011, pp. 161-166.

Jaybird, "Everything Wrong with AIM: Because We've All Thought About It", available at <<http://www.psychonoble.com/archives/articles/82.html>>, May 24, 2006, 3 pages.

Jensvoll, Maja Henriette, "The Acquisition of Past Tense in English/Norwegian Bilingual Children Single versus Dual Mechanisms", Proceedings of the 19th Scandinavian Conference of Linguistics, vol. 31, No. 3, 2003, pp. 545-557.

Jiang et al., "A Syllable-based Name Transliteration System", Proc. of the 2009 Named Entities Workshop, Aug. 7, 2009, pp. 96-99.

Jonsson et al., "Proximity-based Reminders Using Bluetooth", 2014 IEEE International Conference on Pervasive Computing and Communications Demonstrations, 2014, pp. 151-153.

Jouvet et al., "Evaluating Grapheme-to-phoneme Converters in Automatic Speech Recognition Context", IEEE, 2012, pp. 4821-4824.

Kahn et al., "CoABS Grid Scalability Experiments", Autonomous Agents and Multi-Agent Systems, vol. 7, 2003, pp. 171-178.

Kanda et al., "Robust Domain Selection Using Dialogue History in Multi-domain Spoken Dialogue Systems", Journal of Information Processing Society, vol. 48, No. 5, May 15, 2007, pp. 1980-1989. (English Abstract Submitted).

Kanda et al., "Spoken Language Understanding Using Dialogue Context in Database Search Task", Journal of Information Processing Society of Japan, vol. 47, No. 6, Jun. 15, 2006, pp. 1802-1811. (English Abstract Submitted).

Kane et al., "Slide Rule: Making Mobile Touch Screens Accessible to Blind People Using Multi-Touch Interaction Techniques", ASSETS, Oct. 13-15, 2008, pp. 73-80.

Katz et al., "REXTOR: A System for Generating Relations from Natural Language", Proceedings of the ACL Workshop on Natural Language Processing and Information Retrieval (NLP&IR), Oct. 2000, 11 pages.

Katzenmaier et al., "Identifying the Addressee in Human—Human-Robot Interactions based on Head Pose and Speech", Proc. ICMI '04, ACM, 2004, pp. 144-151.

Kazemzadeh et al., "Acoustic Correlates of User Response to Error in Human-Computer Dialogues", Automatic Speech Recognition and Understanding, 2003, pp. 215-220.

Kazmucha, Allyson, "How to Send Map Locations Using iMessage", iMore.com, Available at <<http://www.imore.com/how-use-iphone-share-your-location-your-iphone>>, Aug. 2, 2012, 6 pages.

Kickstarter, "Ivee Sleek: Wi-Fi Voice-Activated Assistant", available at <<https://www.kickstarter.com/projects/ivee/ivee-sleek-wi-fi-voice-activated-assistant>>, retrieved on Feb. 10, 2014, 13 pages.

Kitaoka et al., "Detection and Recognition of Correction Utterances on Misrecognition of Spoken Dialog System", Systems and Computers in Japan, vol. 36, No. 11 Oct. 2005, pp. 24-33.

Klabbers et al., "Reducing Audible Spectral Discontinuities", IEEE Transactions on Speech and Audio Processing, vol. 9, No. 1, Jan. 2001, 13 pages.

Knownav, "Knowledge Navigator", YouTube Video available at <http://www.youtube.com/watch?v=QRH8eimU_20>, Apr. 29, 2008, 1 page.

Kohler, Joachim, "Multilingual Phone Models for Vocabulary-Independent Speech Recognition Tasks", Speech Communication, vol. 35, No. 1-2, Aug. 2001, pp. 21-30.

Komatani et al., "Multi-domain Spoken Dialogue System with Extensibility and Robustness Against Speech Recognition Errors", Proceedings of the 7th SIGdial Workshop on Discourse and Dialogue, Association for Computational Linguistics, Jul. 2006, pp. 9-17.

Kominek et al., "Impact of Durational Outlier Removal from Unit Selection Catalogs", 5th ISCA Speech Synthesis Workshop, Jun. 14-16, 2004, 6 pages.

Küleki et al., "Turkish Word Segmentation Using Morphological Analyzer", 7th European Conference on Speech Communication and Technology, 2nd Interspeech Event, 2001, 4 pages.

Lafferty et al., "Conditional Random Fields: Probabilistic Models for Segmenting and Labeling Sequence Data", Proceedings of the 18th International Conference on Machine Learning, 2001, 9 pages.

(56)

References Cited

OTHER PUBLICATIONS

Larks, "Intelligent Software Agents", available at <<http://www.cs.cmu.edu/~softagents/larks.html>> retrieved on Mar. 15, 2013, 2 pages.

Lee et al., "On URL Normalization", Proceedings of the International Conference on Computational Science and its Applications, ICCSA 2005, pp. 1076-1085.

Lemon et al., "Multithreaded Context for Robust Conversational Interfaces: Context-Sensitive Speech Recognition and Interpretation of Corrective Fragments", ACM Transactions on Computer-Human Interaction, vol. 11, No. 3, Sep. 2004, pp. 241-267.

Leong et al., "CASIS: A Context-Aware Speech Interface System", Proceedings of the 10th International Conference on Intelligent User Interfaces, Jan. 2005, pp. 231-238.

Lewis, Cameron, "Task Ave for iPhone Review", Mac Life, Available at <http://www.maclife.com/article/reviews/task_ave_iphone_review>, Mar. 3, 2011, 5 pages.

Lewis, Peter, "Two New Ways to Buy Your Bits", CNN Money, available at <<http://money.cnn.com/2003/12/30/commentary/ontechnology/download/>>., Dec. 31, 2003, 4 pages.

Li et al., "A Phonotactic Language model for Spoken Language Identification", Proceedings of the 43rd Annual Meeting of the ACL, Jun. 25, 2005, pp. 515-522.

Lieberman et al., "Out of Context: Computer Systems that Adapt to, and Learn from, Context", IBM Systems Journal, vol. 39, No. 3 & 4, 2000, pp. 617-632.

Logan et al., "Mel Frequency Cepstral Co-efficients for Music Modeling", International Symposium on Music Information Retrieval, 2000, 2 pages.

Lyons et al., "Augmenting Conversations Using Dual-Purpose Speech", Proceedings of the 17th Annual ACM Symposium on User Interface Software and Technology, 2004, 10 pages.

Macsimum News, "Apple Files Patent for an Audio Interface for the iPod", available at <http://www.macsimumnews.com/index.php/archive/apple_files_patent_for_an_audio_interface_for_the_ipod>, retrieved on Jul. 13, 2006, 8 pages.

Mactech, "KeyStrokes 3.5 for Mac OS X Boosts Word Prediction", available at <<http://www.mactech.com/news/?p=1007129>>, retrieved on Jan. 7, 2008, 3 pages.

Mahedero et al., "Natural Language Processing of Lyrics", In Proceedings of the 13th Annual ACM International Conference on Multimedia, ACM, Nov. 6-11, 2005, 4 pages.

Mangu et al., "Finding Consensus in Speech Recognition: Word Error Minimization and Other Applications of Confusion Networks", Computer Speech and Language, vol. 14, No. 4, 2000, pp. 291-294.

Martins et al., "Extracting and Exploring the Geo-Temporal Semantics of Textual Resources", Semantic Computing, IEEE International Conference, 2008, pp. 1-9.

Meet Ivey, Your Wi-Fi Voice Activated Assistant, available at <<http://www.helloivee.com/>>, retrieved on Feb. 10, 2014, 8 pages.

Mel Scale, Wikipedia the Free Encyclopedia, Last modified on Oct. 13, 2009 and retrieved on Jul. 28, 2010, available at <http://en.wikipedia.org/wiki/Mel_scale>, 2 pages.

Meng et al., "Generating Phonetic Cognates to Handle Named Entities in English-Chinese Cross-Language Spoken Document Retrieval", Automatic Speech Recognition and Understanding, Dec. 2001, pp. 311-314.

Menta, Richard, "1200 Song MP3 Portable is a Milestone Player", available at <<http://www.mp3newswire.net/stories/personaljuke.html>>, Jan. 11, 2000, 4 pages.

Microsoft Corporation, Microsoft Office Word 2003 (SP2), Microsoft Corporation, SP3 as of 2005, pages MSWord 2003 Figures 1-5, 1983-2003.

Microsoft Windows XP, "Magnifier Utility", Oct. 25, 2001, 2 pages.

Microsoft, "Turn on and Use Magnifier", available at <<http://www.microsoft.com/windowsxp/using/accessibility/magnifierturnon.msp>>, retrieved on Jun. 6, 2009.

Microsoft/Ford, "Basic Sync Commands", www.SyncMyRide.com, Sep. 14, 2007, 1 page.

Miller, Chance, "Google Keyboard Updated with New Personalized Suggestions Feature", available at <<http://9to5google.com/2014/03/19/google-keyboard-updated-with-new-personalized-suggestions-feature/>>, Mar. 19, 2014, 4 pages.

Milward et al., "D2.2: Dynamic Multimodal Interface Reconfiguration, Talk and Look: Tools for Ambient Linguistic Knowledge", available at <<http://www.ihmc.us/users/nblaylock!Pubs/Files/talkd2.2.pdf>>, Aug. 8, 2006, 69 pages.

Miniman, Jared, "Applian Software's Replay Radio and Player v1.02", pocketnow.com—Review, available at <<http://www.pocketnow.com/reviews/replay/replay.htm>>, Jul. 31, 2001, 16 pages.

Minimum Phase, Wikipedia the free Encyclopedia, Last modified on Jan. 12, 2010 and retrieved on Jul. 28, 2010, available at <http://en.wikipedia.org/wiki/Minimum_phase>, 8 pages.

Mitra et al., "A Graph-Oriented Model for Articulation of Ontology Interdependencies", Advances in Database Technology, Lecture Notes in Computer Science, vol. 1777, 2000, pp. 1-15.

Moberg et al., "Cross-Lingual Phoneme Mapping for Multilingual Synthesis Systems", Proceedings of the 8th International Conference on Spoken Language Processing, Jeju Island, Korea, INTERSPEECH 2004, Oct. 4-8, 2004, 4 pages.

Moberg, M., "Contributions to Multilingual Low-Footprint TTS System for Hand-Held Devices", Doctoral Thesis, Tampere University of Technology, Aug. 17, 2007, 82 pages.

Mobile Speech Solutions, Mobile Accessibility, SVOX AG Product Information Sheet, available at <<http://www.svox.com/site/bra840604/con782768/mob965831936.aSQ?osLang=1>>, Sep. 27, 2012, 1 page.

Mobile Tech News, "T9 Text Input Software Updated", available at <<http://www.mobiletechnews.com/info/2004/11/23/122155.html>>, Nov. 23, 2004, 4 pages.

Modi et al., "CMRadar: A Personal Assistant Agent for Calendar Management", AAAI, Intelligent Systems Demonstrations, 2004, pp. 1020-1021.

Mok et al., "Media Searching on Mobile Devices", IEEE EIT 2007 Proceedings, 2007, pp. 126-129.

Morrison, Jonathan, "iPhone 5 Siri Demo", Online Available at <https://www.youtube.com/watch?v=_wHwG5IhWc>, Sep. 21, 2012, 3 pages.

Morton, Philip, "Checking If an Element Is Hidden", StackOverflow, Available at <<http://stackoverflow.com/questions/178325/checking-if-an-element-is-hidden>>, Oct. 7, 2008, 12 pages.

Murty et al., "Combining Evidence from Residual Phase and MFCC Features for Speaker Recognition", IEEE Signal Processing Letters, vol. 13, No. 1, Jan. 2006, 4 pages.

My Cool Aids, "What's New", available at <<http://www.mycoolaids.com/>>, 2012, 1 page.

Myers, Brad A., "Shortcutter for Palm", available at <<http://www.cs.cmu.edu/~pebbles/v5/shortcutter/palm/index.html>>, retrieved on Jun. 18, 2014, 10 pages.

N200 Hands-Free Bluetooth Car Kit, available at <www.wirelessground.com>, retrieved on Mar. 19, 2007, 3 pages.

Nakagawa et al., "Speaker Recognition by Combining MFCC and Phase Information", IEEE International Conference on Acoustics, Speech and Signal Processing (ICASSP), 2007, pp. 2005-2008.

Nakagawa et al., "Unknown Word Guessing and Part-of-Speech Tagging Using Support Vector Machines", Proceedings of the 6th NLPRS, 2001, pp. 325-331.

Naone, Erica, "TR10: Intelligent Software Assistant", Technology Review, Mar.-Apr. 2009, 2 pages.

Navigli, Roberto, "Word Sense Disambiguation: A Survey", ACM Computing Surveys, vol. 41, No. 2, Feb. 2009, 70 pages.

NCIP, "NCIP Library: Word Prediction Collection", available at <<http://www2.edc.org/ncip/library/wp/toc.htm>>, 1998, 4 pages.

NDTV, "Sony SmartWatch 2 Launched in India for Rs. 14,990", available at <<http://gadgets.ndtv.com/others/news/sony-smartwatch-2-launched-in-india-for-rs-14990-420319>>, Sep. 18, 2013, 4 pages.

NG, Simon, "Google's Task List Now Comes to Iphone", SimonBlog, Available at <<http://www.simonblog.com/2009/02/04/googles-task-list-now-comes-to-iphone/>>, Feb. 4, 2009, 3 pages.

(56)

References Cited

OTHER PUBLICATIONS

- Nguyen et al., "Generic Manager for Spoken Dialogue Systems", In DiaBruck: 7th Workshop on the Semantics and Pragmatics of Dialogue, Proceedings, 2003, 2 pages.
- Nonhoff-ARPS et al., "StraBenmusik: Portable MP3-Spieler mit USB Anschluss", CT Magazin Fuer Computer Technik, Verlag Heinz Heise GMBH, Hannover DE, No. 25, 2000, pp. 166-175.
- Notenboom, Leo A., "Can I Retrieve Old MSN Messenger Conversations?", available at <http://ask-leo.com/can_i_retrieve_old_msn_messenger_conversations.html>, Mar. 11, 2004, 23 pages.
- Noth et al., "Verbmobil: The Use of Prosody in the Linguistic Components of a Speech Understanding System", IEEE Transactions on Speech and Audio Processing, vol. 8, No. 5, Sep. 2000, pp. 519-532.
- Nozawa, Naoki et al., "iPhone 4S Perfect Manual", vol. 1, First Edition, Nov. 11, 2011, 5 pages.
- Oregon Scientific, "512MB Waterproof MP3 Player with FM Radio & Built-in Pedometer", available at <<http://www2.oregonscientific.com/shop/product.asp?cid=4&scid=11&4pid=581>>, retrieved on Jul. 31, 2006, 2 pages.
- Oregon Scientific, "Waterproof Music Player with FM Radio and Pedometer (MP121)—User Manual", 2005, 24 pages.
- Osxdaily, "Get a List of Siri Commands Directly from Siri", Available at <<http://osxdaily.com/2013/02/05/list-siri-commands/>>, Feb. 5, 2013, 15 pages.
- Padilla, Alfredo, "Palm Treo 750 Cell Phone Review—Messaging", available at <<http://www.wirelessinfo.com/content/palm-Treo-750-Cell-Phone-Review/Messaging.htm>>, Mar. 17, 2007, 6 pages.
- Palm, Inc., "User Guide: Your Palm® Treo.TM. 755p Smartphone", 2005-2007, 304 pages.
- Pan et al., "Natural Language Aided Visual Query Building for Complex Data Access", In proceeding of the Twenty-Second Conference on Innovative Applications of Artificial Intelligence, XP055114607, 2010, pp. 1821-1826.
- Panasonic, "Toughbook 28: Powerful, Rugged and Wireless", Panasonic: Toughbook Models, available at <http://www.panasonic.com/computer/notebook/html/01a_s8.htm>, retrieved on Dec. 19, 2002, 3 pages.
- Pathak et al., "Privacy-preserving Speech Processing: Cryptographic and String-matching Frameworks Show Promise", In: IEEE signal processing magazine, retrieved from <<http://www.merl.com/publications/docs/TR2013-063.pdf>>, Feb. 13, 2013, 16 pages.
- Patra et al., "A Kernel-Based Approach for Biomedical Named Entity Recognition", Scientific World Journal, vol. 2013, 2013, pp. 1-7.
- PhatNoise, Voice Index on Tap, Kenwood Music Keg, available at <<http://www.phatnoise.com/kenwood/kenwoodssamail.html>>, retrieved on Jul. 13, 2006, 1 page.
- Phoenix Solutions, Inc., "Declaration of Christopher Schmandt Regarding the MIT Galaxy System", West Interactive Corp., A Delaware Corporation, Document 40, Jul. 2, 2010, 162 pages.
- Poly-Optical Products, Inc., "Poly-Optical Fiber Optic Membrane Switch Backlighting", available at <http://www.poly-optical.com/membrane_switches.html>, retrieved on Dec. 19, 2002, 3 pages.
- Powell, Josh, "Now You See Me . . . Show/Hide Performance", available at <http://www.learningjquery.com/2010/05/now-you-see-me-showhide-performance>, May 4, 2010, 3 pages.
- Public Safety Technologies, "Tracer 2000 Computer", available at <<http://www.pst911.com/tracer.html>>, retrieved on Dec. 19, 2002, 3 pages.
- Quazza et al., "Actor: A Multilingual Unit-Selection Speech Synthesis System", Proceedings of 4th ISCA Tutorial and Research Workshop on Speech Synthesis, Jan. 1, 2001, 6 pages.
- Reddi, "The Parser".
- Ren et al., "Improving Selection Performance on Pen-Based Systems: A Study of Pen-Based Interaction for Selection Tasks", ACM Transactions on Computer-Human Interaction, vol. 7, No. 3, Sep. 2000, pp. 384-416.
- Ricker, Thomas, "Apple Patents Audio User Interface", Engadget, available at <<http://www.engadget.com/2006/05/04/apple-patents-audio-user-interface/>>, May 4, 2006, 6 pages.
- Robbin et al., "MP3 Player and Encoder for Macintosh!", SoundJam MP Plus, Version 2.0, 2000, 76 pages.
- Roddy et al., "Communication and Collaboration in a Landscape of B2B eMarketplaces", VerticalNet Solutions, White Paper, Jun. 15, 2000, 23 pages.
- Roseberry, Catherine, "How to Pair a Bluetooth Headset & Cell Phone", available at <http://mobileoffice.about.com/od/usingyourphone/ht/blueheadset_p.htm>, retrieved on Apr. 29, 2006, 2 pages.
- Rossfrank, "Konstenlose Sprachmitteilungs Festnetz", XP002234425, Dec. 10, 2000, pp. 1-4.
- Routines, "SmartThings Support", Available online at <<https://web.archive.org/web/20151207165701/https://support.smartthings.com/hc/en-us/articles/205380034-Routines>>, 2015, 2 pages.
- Ruch et al., "Using Lexical Disambiguation and Named-Entity Recognition to Improve Spelling Correction in the Electronic Patient Record", Artificial Intelligence in Medicine, Sep. 2003, pp. 169-184.
- Russo et al., "Urgency is a Non-Monotonic Function of Pulse Rate", Journal of the Acoustical Society of America, vol. 122, No. 5, 2007, 6 pages.
- Sankar, Ananth, "Bayesian Model Combination (BAYCOM) for Improved Recognition", IEEE International Conference on Acoustics, Speech, and Signal Processing (ICASSP), Mar. 18-23, 2005, pp. 845-848.
- San-Segundo et al., "Confidence Measures for Dialogue Management in the CU Communicator System", Proceedings of Acoustics, Speech and Signal Processing (ICASSP'00), Jun. 2000, 4 pages.
- Santaholma, Marianne E., "Grammar Sharing Techniques for Rule-based Multilingual NLP Systems", Proceedings of the 16th Nordic Conference of Computational Linguistics, NODALIDA, 2007, 9 pages.
- Sarawagi, Sunita, "CRF Package Page", available at <<http://crf.sourceforge.net/>>, retrieved on Apr. 6, 2011, 2 pages.
- Sarvas et al., "Metadata Creation System for Mobile Images", Conference Proceedings, The Second International Conference on Mobile Systems, Applications and Services, Jun. 6, 2004, pp. 36-48.
- Schluter et al., "Using Phase Spectrum Information for Improved Speech Recognition Performance", IEEE International Conference on Acoustics, Speech, and Signal Processing, 2001, pp. 133-136.
- Schnelle, Dirk, "Context Aware Voice User Interfaces for Workflow Support", Dissertation paper, Aug. 27, 2007, 254 pages.
- Schone et al., "Knowledge-Free Induction of Morphology Using Latent Semantic Analysis", Proceedings of the 2nd Workshop on Learning Language in Logic and the 4th Conference on Computational Natural Language Learning, vol. 7, 2000, pp. 67-72.
- Schultz, Tanja, "Speaker Characteristics", In: Speaker Classification I, retrieved from <<http://ccc.inaoep.mx/~villasen/bib/Speaker%20Characteristics.pdf>>, 2007, pp. 47-74.
- Sen et al., "Indian Accent Text-to-Speech System for Web Browsing", Sadhana, vol. 27, No. 1, Feb. 2002, pp. 113-126.
- Sethy et al., "A Syllable Based Approach for Improved Recognition of Spoken Names", ITRW on Pronunciation Modeling and Lexicon Adaptation for Spoken language Technology (PMLA2002), Sep. 14-15, 2002, pp. 30-35.
- Sheth et al., "Relationships at the Heart of Semantic Web: Modeling, Discovering, and Exploiting Complex Semantic Relationships", Enhancing the Power of the Internet: Studies in Fuzziness and Soft Computing, Oct. 13, 2002, pp. 1-38.
- Sigurdsson et al., "Mel Frequency Cepstral Co-efficients: An Evaluation of Robustness of MP3 Encoded Music", Proceedings of the 7th International Conference on Music Information Retrieval, 2006, 4 pages.
- Simonite, Tom, "One Easy Way to Make Siri Smarter", Technology Review, Oct. 18, 2011, 2 pages.
- Singh et al., "Automatic Generation of Phone Sets and Lexical Transcriptions", Acoustics, Speech and Signal Processing (ICASSP'00), 2000, pp. 1691-1694.
- Sinitsyn, Alexander, "A Synchronization Framework for Personal Mobile Servers", Proceedings of the Second IEEE Annual Confer-

(56)

References Cited

OTHER PUBLICATIONS

ence on Pervasive Computing and Communications Workshops, Piscataway, 2004, pp. 1, 3 and 5.

Sony Ericsson Corporate, "Sony Ericsson to introduce Auto pairing. TM. to Improve Bluetooth. TM. Connectivity Between Headsets and Phones", Press Release, available at <http://www.sonyericsson.com/spg.jsp?cc=global&lc=en&ver=4001&template=pc3_1_1&z...>, Sep. 28, 2005, 2 pages.

Speaker Recognition, Wikipedia, The Free Encyclopedia, Nov. 2, 2010, 4 pages.

Spiller, Karen, "Low-Decibel Earbuds Keep Noise at a Reasonable Level", available at <<http://www.nashuatelegraph.com/apps/pbcs.dll/article?Date=20060813&Cate...>>, Aug. 13, 2006, 3 pages.

Spivack, Nova, "Sneak Preview of Siri—Part Two—Technical Foundations—Interview with Tom Gruber, CTO of Siri", Online Available at <<https://web.archive.org/web/20100114234454/http://www.twine.com/item/12vhy39k4-22m/interview-with-tom-gruber-of-siri>>, Jan. 14, 2010, 5 pages.

SRI, "SRI Speech: Products: Software Development Kits: EduSpeak", available at <<http://web.archive.org/web/20090828084033/http://www.speechsri.com/products/eduspeak>shtml>>, retrieved on Jun. 20, 2013, 2 pages.

Stealth Computer Corporation, "Peripherals for Industrial Keyboards & Pointing Devices", available at <http://www.stealthcomputer.com/peripherals_oem.htm>, retrieved on Dec. 19, 2002, 6 pages.

Steinberg, Gene, "Sonicblue Rio Car (10 GB, Reviewed: 6 GB)", available at <<http://electronics.cnet.com/electronics/0-6342420-1304-4098389.html>>, Dec. 12, 2000, 2 pages.

Stent et al., "Geo-Centric Language Models for Local Business Voice Search", AT&T Labs—Research, 2009, pp. 389-396.

Strom et al., "Intelligent Barge-In in Conversational Systems", MIT laboratory for Computer Science, 2000, 4 pages.

Stuker et al., "Cross-System Adaptation and Combination for Continuous Speech Recognition: The Influence of Phoneme Set and Acoustic Front-End", Influence of Phoneme Set and Acoustic Front-End, Interspeech, Sep. 17-21, 2006, pp. 521-524.

Sullivan, Danny, "How Google Instant's Autocomplete Suggestions Work", available at <<http://searchengineland.com/how-google-instant-autocomplete-suggestions-work-62592>>, Apr. 6, 2011, 12 pages.

Sundaram et al., "Latent Perceptual Mapping with Data-Driven Variable-Length Acoustic Units for Template-Based Speech Recognition", ICASSP 2012, Mar. 2012, pp. 4125-4128.

Sycara et al., "The RETSINA MAS Infrastructure", Autonomous Agents and Multi-Agent Systems, vol. 7, 2003, 20 pages.

T3 Magazine, "Creative MuVo TX 256MB", available at <http://www.t3.co.uk/reviews/entertainment/mp3_player/creative_muvo_tx_256mb>, Aug. 17, 2004, 1 page.

Taos, "TAOS, Inc. Announces Industry's First Ambient Light Sensor to Convert Light Intensity to Digital Signals", News Release, available at <http://www.taosinc.com/pressrelease_090902.htm>, Sep. 16, 2002, 3 pages.

Textndrive, "Text'nDrive App Demo—Listen and Reply to your Messages by Voice while Driving!", YouTube Video available at <<http://www.youtube.com/watch?v=WaGfzoHsAMw>>, Apr. 27, 2010, 1 page.

TG3 Electronics, Inc., "BL82 Series Backlit Keyboards", available at <<http://www.tg3electronics.com/products/backlit/backlit.htm>>, retrieved on Dec. 19, 2002, 2 pages.

Tidwell, Jenifer, "Animated Transition", Designing Interfaces, Patterns for effective Interaction Design, Nov. 2005, First Edition, 4 pages.

Timothy et al., "Speech-Based Annotation and Retrieval of Digital Photographs", Interspeech. 8th Annual Conference of The International Speech Communication Association, Aug. 27, 2007, pp. 2165-2168.

Tofel, Kevin C., "SpeakTolt: A Personal Assistant for Older iPhones, iPads", Apple News, Tips and Reviews, Feb. 9, 2012, 7 pages.

Tombros et al., "Users' Perception of Relevance of Spoken Documents", Journal of the American Society for Information Science, New York, Aug. 2000, pp. 929-939.

Top 10 Best Practices for Voice User Interface Design available at <<http://www.developer.com/voice/article.php/1567051/Top-10-Best-Practices-for-Voice-UserInterface-Design.htm>>, Nov. 1, 2002, 4 pages.

Toutanova et al., "Feature-Rich Part-of-Speech Tagging with a Cyclic Dependency Network", Computer Science Dept., Stanford University, Stanford CA 94305-9040, 2003, 8 pages.

Tucker, Joshua, "Too Lazy to Grab Your TV Remote? Use Siri Instead", Engadget, Nov. 30, 2011, 8 pages.

Tur et al., "The CALO Meeting Assistant System", IEEE Transactions on Audio, Speech and Language Processing, vol. 18, No. 6, Aug. 2010, pp. 1601-1611.

Tur et al., "The CALO Meeting Speech Recognition and Understanding System", Proc. IEEE Spoken Language Technology Workshop, 2008, 4 pages.

Ushida et al., "Spoken Dialogue Engine based on Autonomous Behavior Decision Model", Omron Technics, vol. 40, No. 1, 2000, pp. 16-21. {See Communication under 37 CFR § 1.98(a) (3)}.

Veiga, Alex, "AT&T Wireless Launching Music Service", available at <http://bizyahoo.com/ap/041005/at_t_mobile_music_5.html?printer=1>, Oct. 5, 2004, 2 pages.

Vepa et al., "New Objective Distance Measures for Spectral Discontinuities in Concatenative Speech Synthesis", Proceedings of the IEEE 2002 Workshop on Speech Synthesis, 2002, 4 pages.

Verschelde, Jan, "MATLAB Lecture 8. Special Matrices in MATLAB", UIC, Dept. of Math, Stat. & CS, MCS 320, Introduction to Symbolic Computation, 2005, 4 pages.

Viikki et al., "Speaker- and Language-Independent Speech Recognition in Mobile Communication Systems", IEEE, vol. 1, 2001, pp. 5-8.

Vlingo Incar, "Distracted Driving Solution with Vlingo InCar", YouTube Video, Available online at <<http://www.youtube.com/watch?v=Vqs8XfXgz4>>, Oct. 2010, 2 pages.

Vlingo, "Vlingo Launches Voice Enablement Application on Apple App Store", Press Release, Dec. 3, 2008, 2 pages.

Vodafone Deutschland, "Samsung Galaxy S3 Tastatur Spracheingabe", Available online at—<<https://www.youtube.com/watch?v=6kOd6Gr8uFE>>, Aug. 22, 2012, 1 page.

Vogel et al., "Shift: A Technique for Operating Pen-Based Interfaces Using Touch", CHI '07 Proceedings, Mobile Interaction Techniques I, Apr. 28-May 3, 2007, pp. 657-666.

Voiceassist, "Send Text, Listen to and Send E-Mail by Voice", YouTube Video, Available online at <<http://www.youtube.com/watch?v=0tEU61nHHA4>>, Jul. 30, 2009, 1 page.

Voiceonthego, "Voice on the Go (BlackBerry)", YouTube Video, available online at <<http://www.youtube.com/watch?v=pJqpWgQS98w>>, Jul. 27, 2009, 1 page.

W3C Working Draft, "Speech Synthesis Markup Language Specification for the Speech Interface Framework", available at <<http://www.w3.org/TR/speech-synthesis>>, retrieved on Dec. 14, 2000, 42 pages.

Wahlster et al., "Smartkom: Multimodal Communication with a Life-Like Character", Eurospeech-Scandinavia, 7th European Conference on Speech Communication and Technology, 2001, 5 pages.

Waldinger et al., "Deductive Question Answering from Multiple Resources", New Directions in Question Answering, Published by AAI, Menlo Park, 2003, 22 pages.

Wang et al., "An Industrial-Strength Audio Search Algorithm", In Proceedings of the International Conference on Music Information Retrieval (ISMIR), 2003, 7 pages.

Wikipedia, "Acoustic Model", available at <<http://en.wikipedia.org/wiki/AcousticModel>>, retrieved on Sep. 14, 2011, 2 pages.

Wikipedia, "Language Model", available at <http://en.wikipedia.org/wiki/Language_model>, retrieved on Sep. 14, 2011, 3 pages.

Wikipedia, "Speech Recognition", available at <http://en.wikipedia.org/wiki/Speech_recognition>, retrieved on Sep. 14, 2011, 10 pages.

Wilson, Mark, "New iPod Shuffle Moves Buttons to Headphones, Adds Text to Speech", available at <<http://gizmodo.com/5167946/>>

(56)

References Cited

OTHER PUBLICATIONS

new-ipod-shuffle-moves-buttons-to-headphones-adds-text-to-speech>, Mar. 11, 2009, 13 pages.

Windows XP: A Big Surprise!—Experiencing Amazement from Windows XP, *New Computer*, No. 2, Feb. 28, 2002, 8 pages.

Wirelessinfo, “SMS/MMS Ease of Use (8.0)”, available at <<http://www.wirelessinfo.com/content/palm-Treo-750-Cell-Phone-Review/Messaging.htm>>, Mar. 2007, 3 pages.

Wolf, Jonathan, “The Next Step in Routing Configuration: Auto-Configuration Management Will Speed Service Rollout”, vol. 15.3, Mar. 2001, pp. 44-48.

Worldwide Character Encoding, Version 2.0, vols. 1,2 by Unicode, Inc., 12 pages.

Written Opinion received for PCT Patent Application No. PCT/US2005/046797, dated Nov. 24, 2006, 9 pages.

Wu et al., “Automatic Generation of Synthesis Units and Prosodic Information for Chinese Concatenative Synthesis”, *Speech Communication*, vol. 35, No. 3-4, Oct. 2001, pp. 219-237.

Wu, M., “Digital Speech Processing and Coding”, *Multimedia Signal Processing, Lecture-2 Course Presentation*, University of Maryland, College Park, 2003, 8 pages.

Wu, M., “Speech Recognition, Synthesis, and H.C.I.”, *Multimedia Signal Processing, Lecture-3 Course Presentation*, University of Maryland, College Park, 2003, 11 pages.

Xiang et al., “Correcting Phoneme Recognition Errors in Learning Word Pronunciation through Speech Interaction”, *Speech Communication*, vol. 55, No. 1, Jan. 1, 2013, pp. 190-203.

Xu et al., “Speech-Based Interactive Games for Language Learning: Reading, Translation, and Question-Answering”, *Computational Linguistics and Chinese Language Processing*, vol. 14, No. 2, Jun. 2009, pp. 133-160.

Yan et al., “A Scalable Approach to Using DNN-Derived Features in GMM-HMM Based Acoustic Modeling for LVCSR”, *InInterspeech*, 2013, pp. 104-108.

Yoon et al., “Letter-to-Sound Rules for Korean”, *Department of Linguistics, The Ohio State University*, 2002, 4 pages.

Young et al., “The HTK Book”, Version 3.4, Dec. 2006, 368 pages.

Young et al., “The Hidden Information State model: A practical framework for POMDP-based spoken dialogue management”, *Computer Speech & Language*, vol. 24, Issue 2, 2010, pp. 150-174.

Youtube, “New bar search for Facebook”, Available at “<https://www.youtube.com/watch?v=vwgN1WbvCas>”, 1 page.

Yunker, John, “Beyond Borders: Web Globalization Strategies”, *New Riders*, Aug. 22, 2002, 11 pages.

Zainab, “Google Input Tools Shows Onscreen Keyboard in Multiple Languages [Chrome]”, available at <<http://www.addictivetips.com/internet-tips/google-input-tools-shows-multiple-language-onscreen-keyboards-chrome/>>, Jan. 3, 2012, 3 pages.

Zangerle et al., “Recommending #-Tag in Twitter”, *Proceedings of the Workshop on Semantic Adaptive Socail Web*, 2011, pp. 1-12.

Zelig, “A Review of the Palm Treo 750v”, available at <<http://www.mtekk.com.au/Articles/tabid/54/articleType/ArticleView/articleId/769/A-Review-of-the-Palm-Treo-750v.aspx>>, Feb. 5, 2007, 3 pages.

Zhang et al., “Research of Text Classification Model Based on Latent Semantic Analysis and Improved HS-SVM”, *Intelligent Systems and Applications (ISA)*, 2010 2nd International Workshop, May 22-23, 2010, 5 pages.

Zhong et al., “JustSpeak: Enabling Universal Voice Control on Android”, *W4A’14, Proceedings of the 11th Web for All Conference*, No. 36, Apr. 7-9, 2014, 8 pages.

Zipnick et al., “U.S. Appl. No. 10/859,661, filed Jun. 2, 2004”.

Zovato et al., “Towards Emotional Speech Synthesis: A Rule based Approach”, *Proceedings of 5th ISCA Speech Synthesis Workshop—Pittsburgh*, 2004, pp. 219-220.

Zue et al., “Jupiter: A Telephone-Based Conversational Interface for Weather Information”, *IEEE Transactions on Speech and Audio Processing*, Jan. 2000, 13 pages.

International Search Report and Written Opinion received for PCT Patent Application No. PCT/US17/49775, dated Dec. 27, 2017, 14 pages.

Certification of Examination received for Australian Patent Application No. 2017101191, dated Feb. 20, 2018, 2 pages.

Office Action received for Australian Patent Application No. 2017101191, dated Nov. 10, 2017, 6 pages.

Office Action received for Danish Patent Application No. PA201770641, dated Mar. 8, 2018, 3 pages.

Office Action received for Danish Patent Application No. PA201770641, dated Oct. 25, 2017, 9 pages.

* cited by examiner

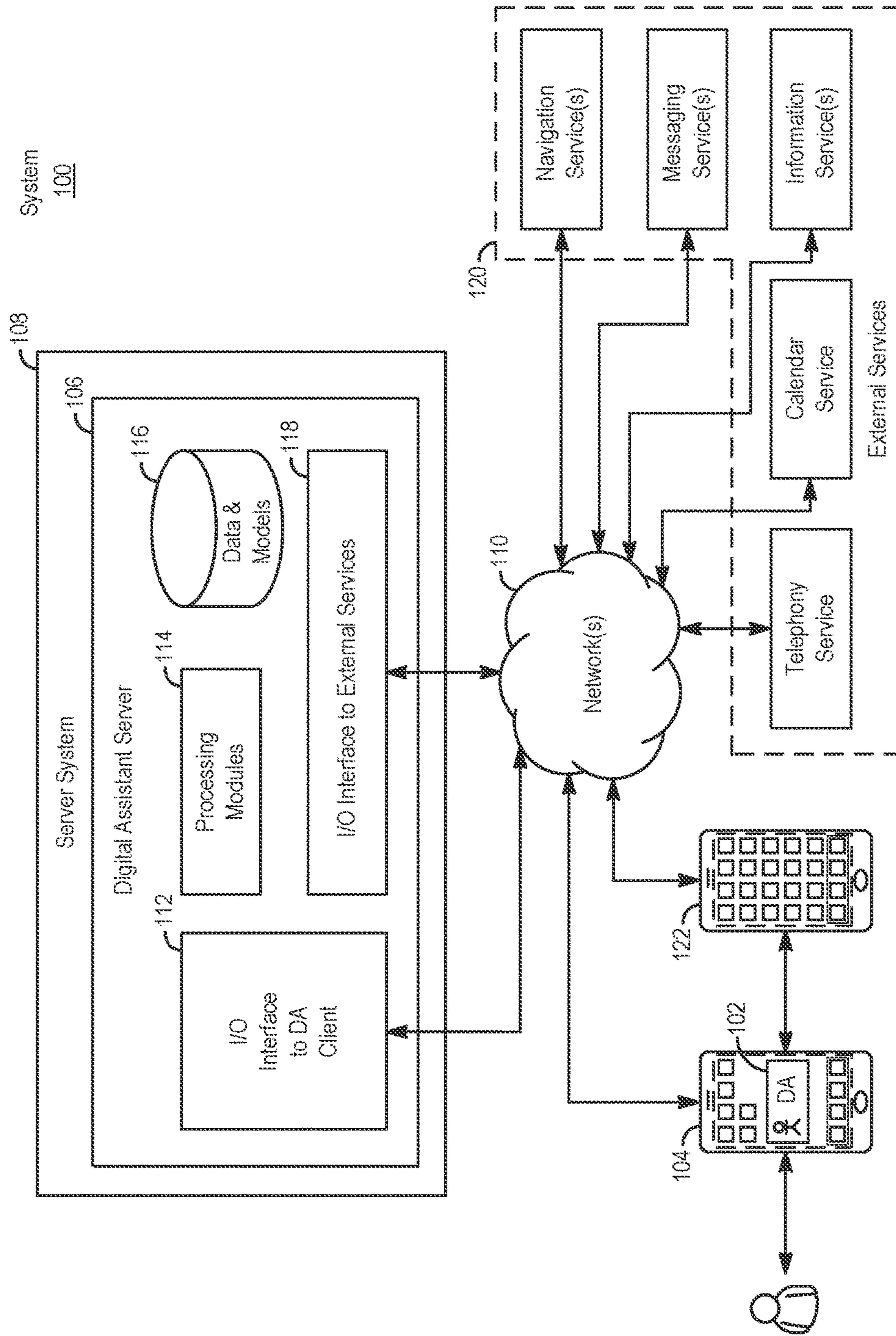

FIG. 1

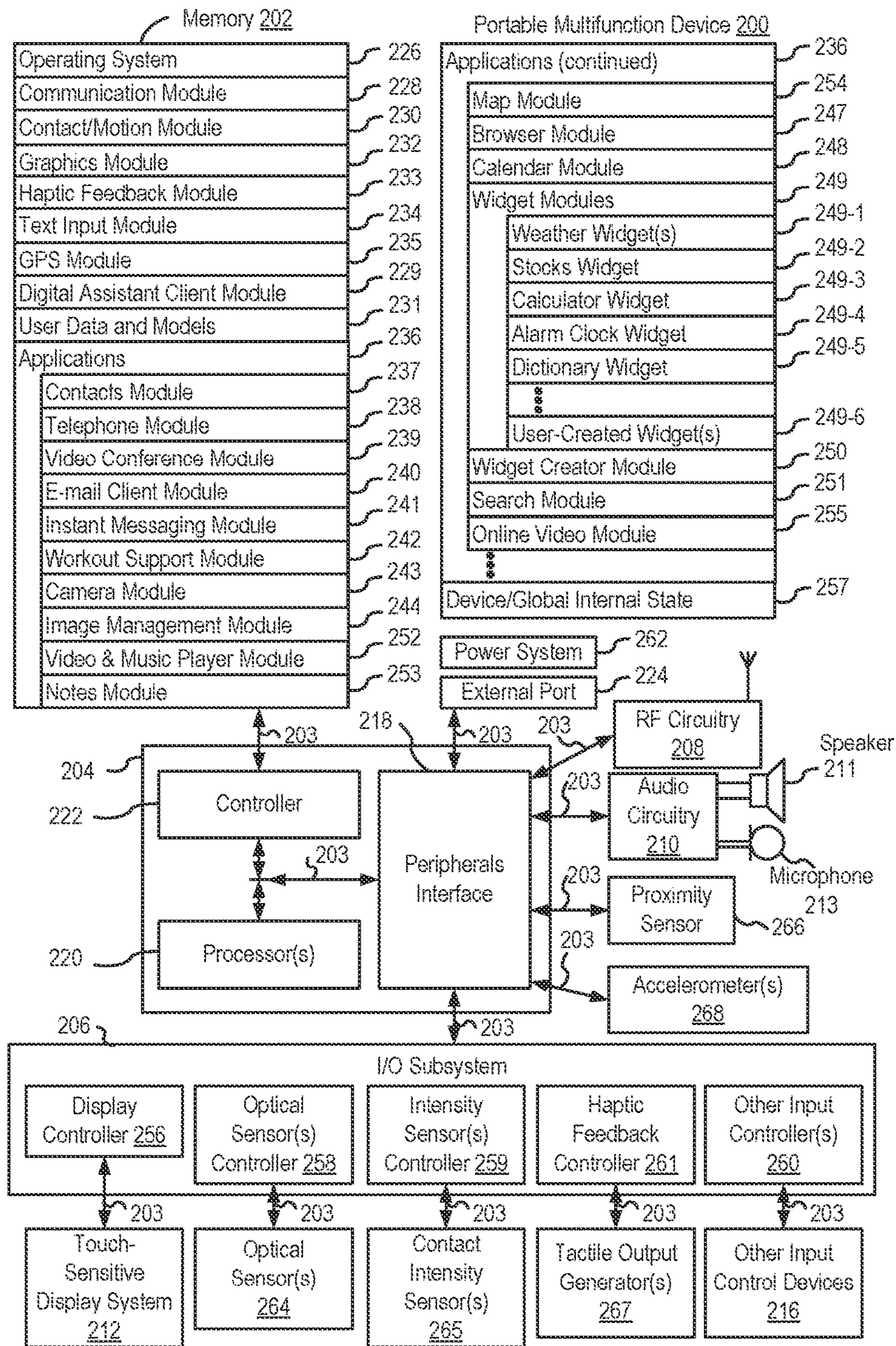

FIG. 2A

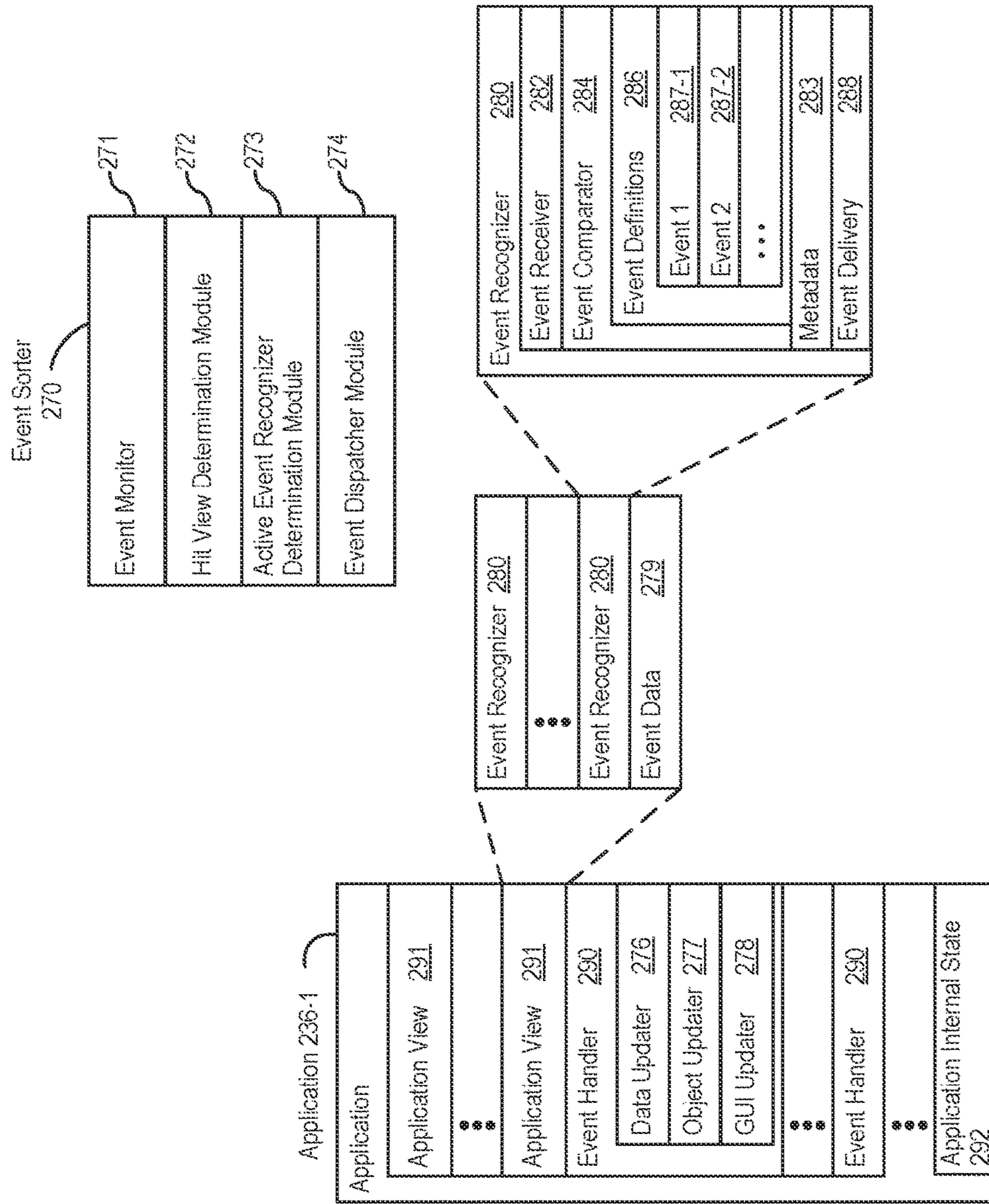

FIG. 2B

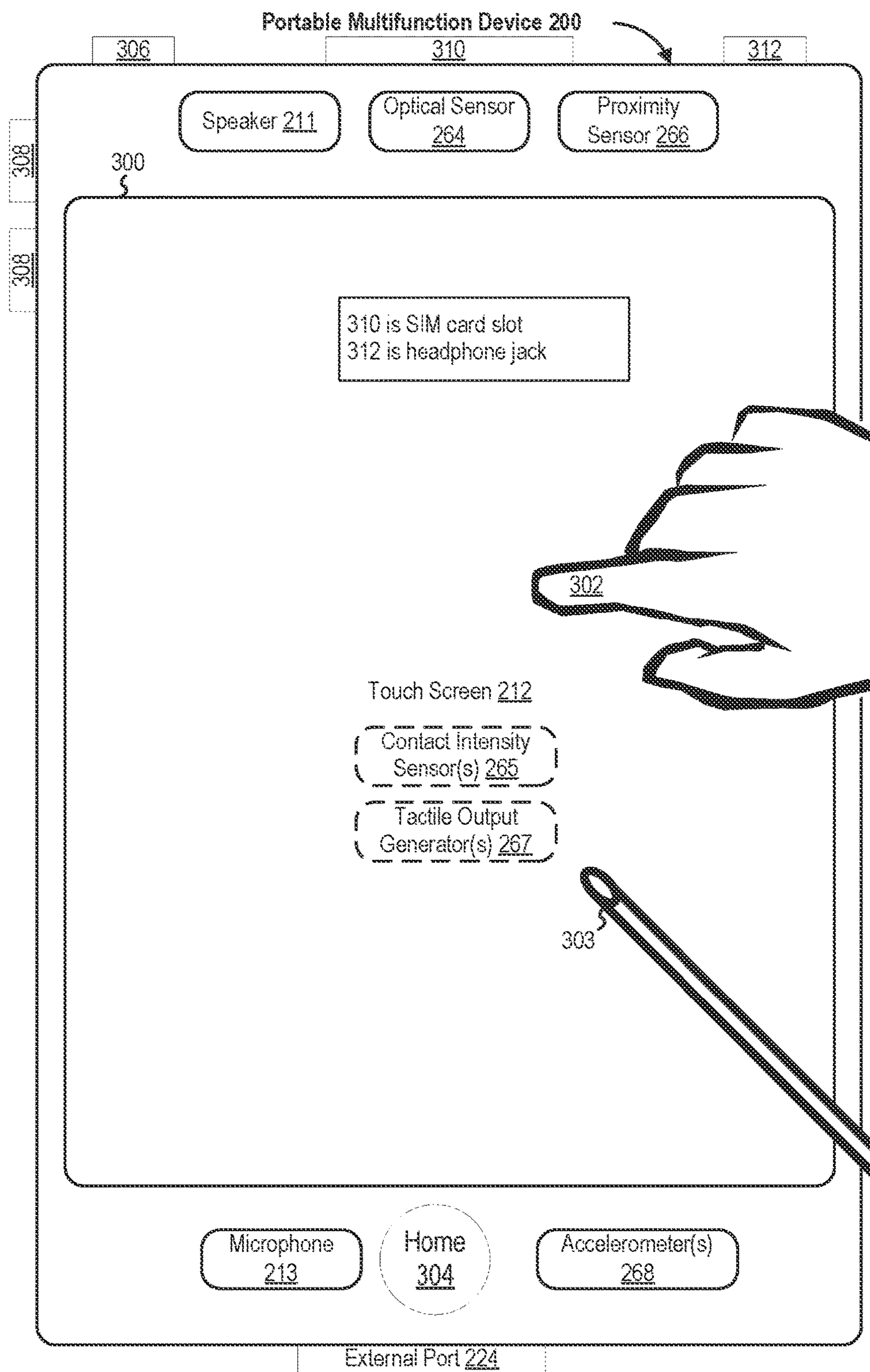

FIG. 3

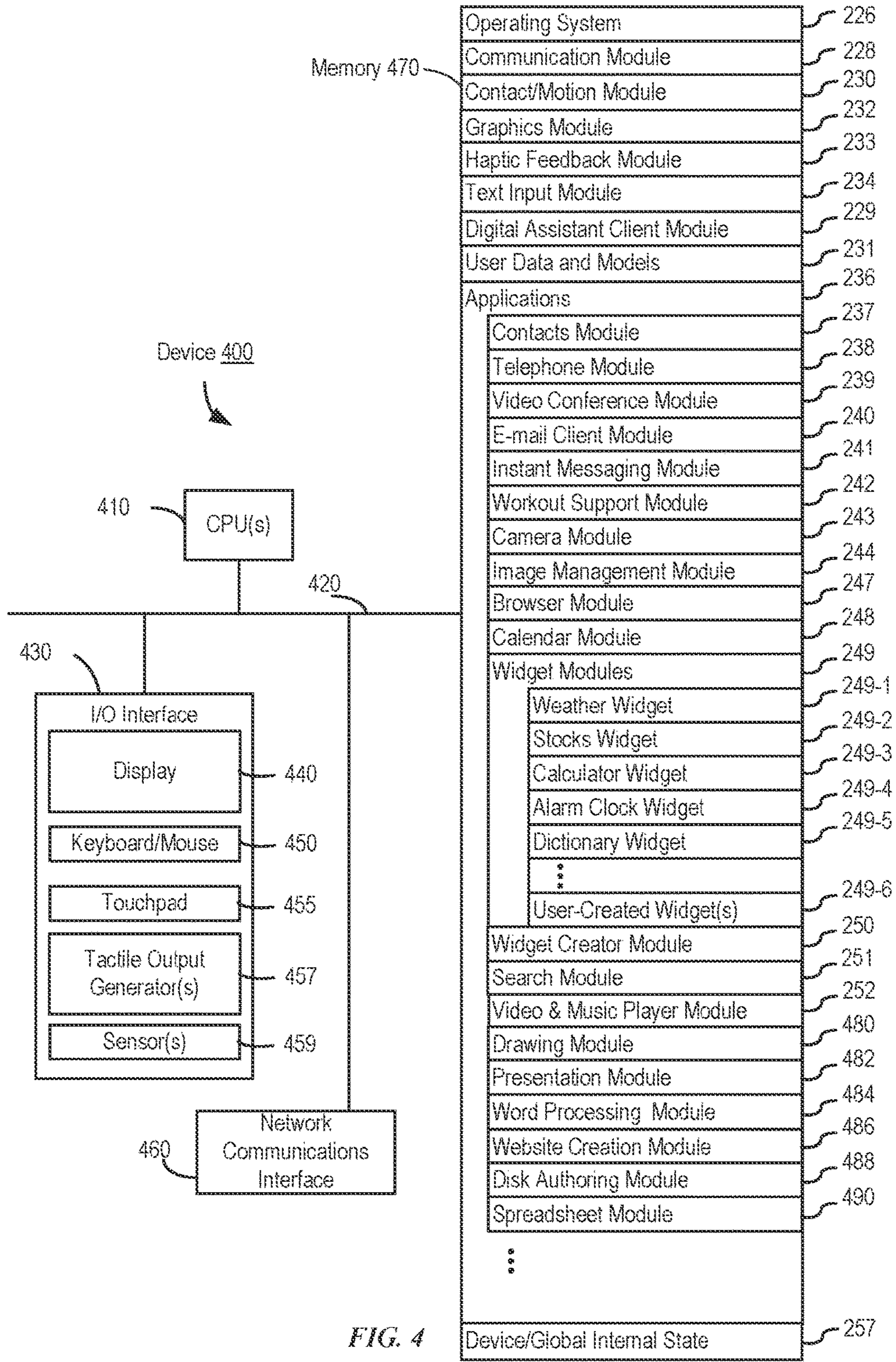

FIG. 4

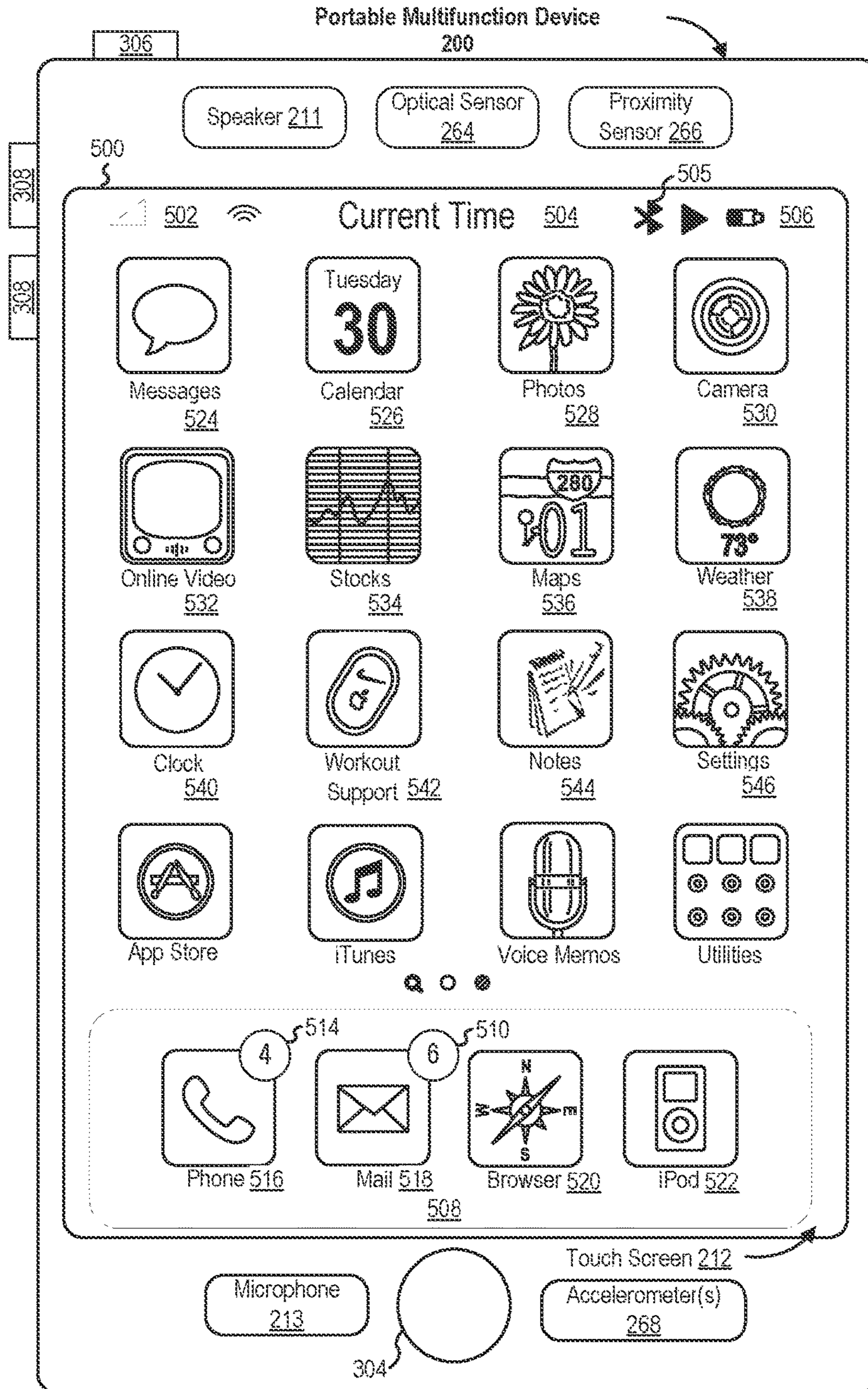

FIG. 5A

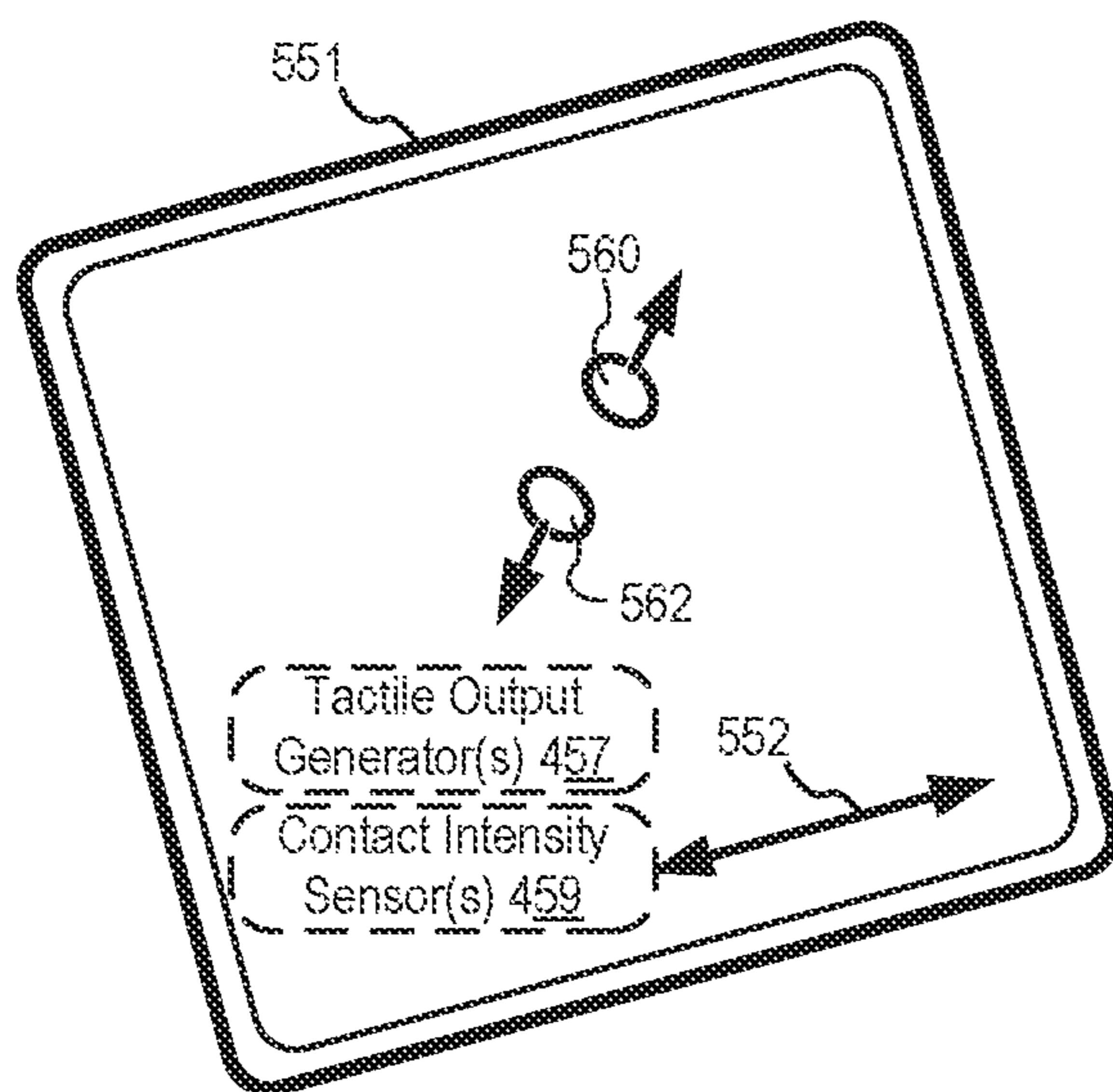
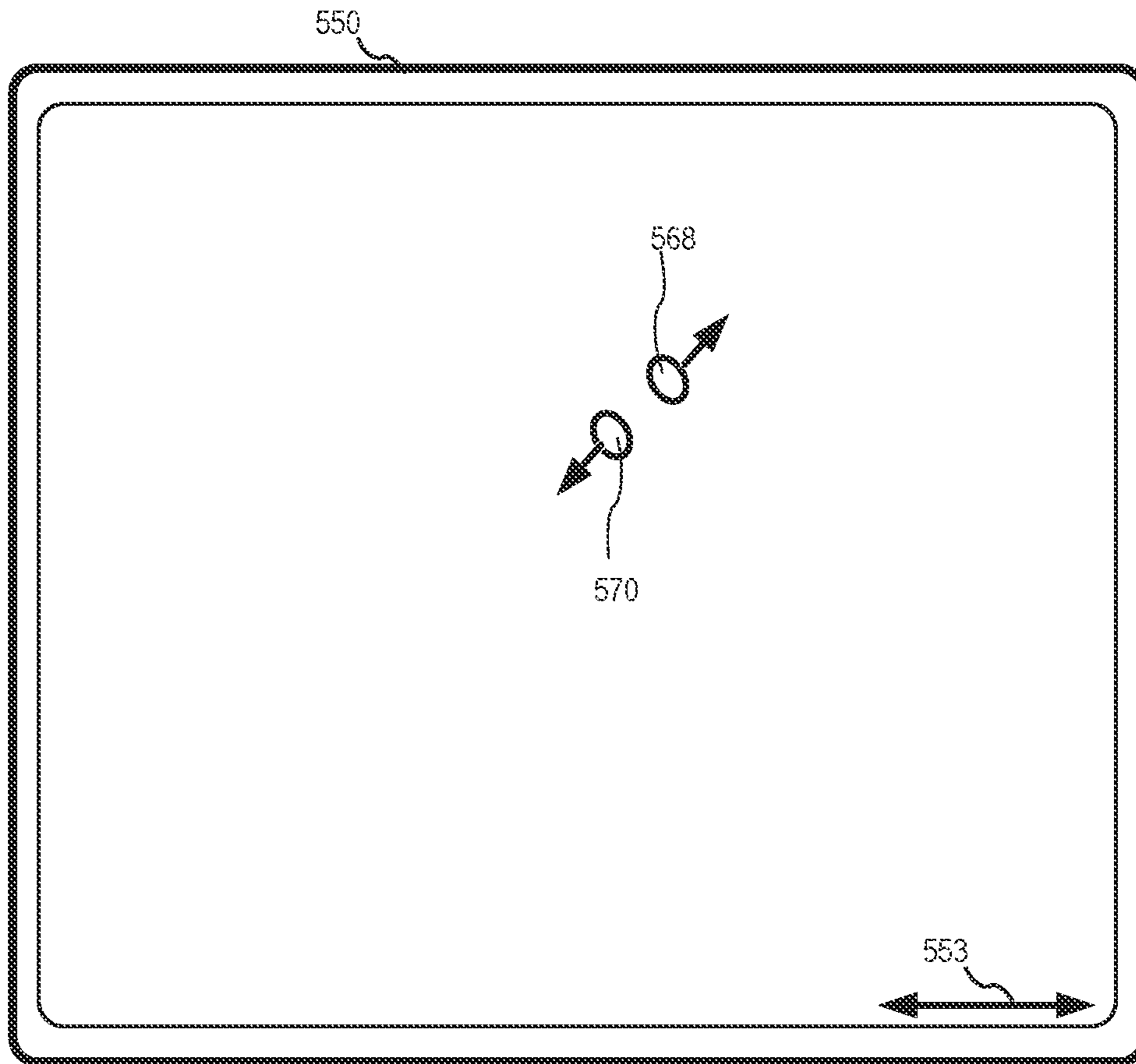

FIG. 5B

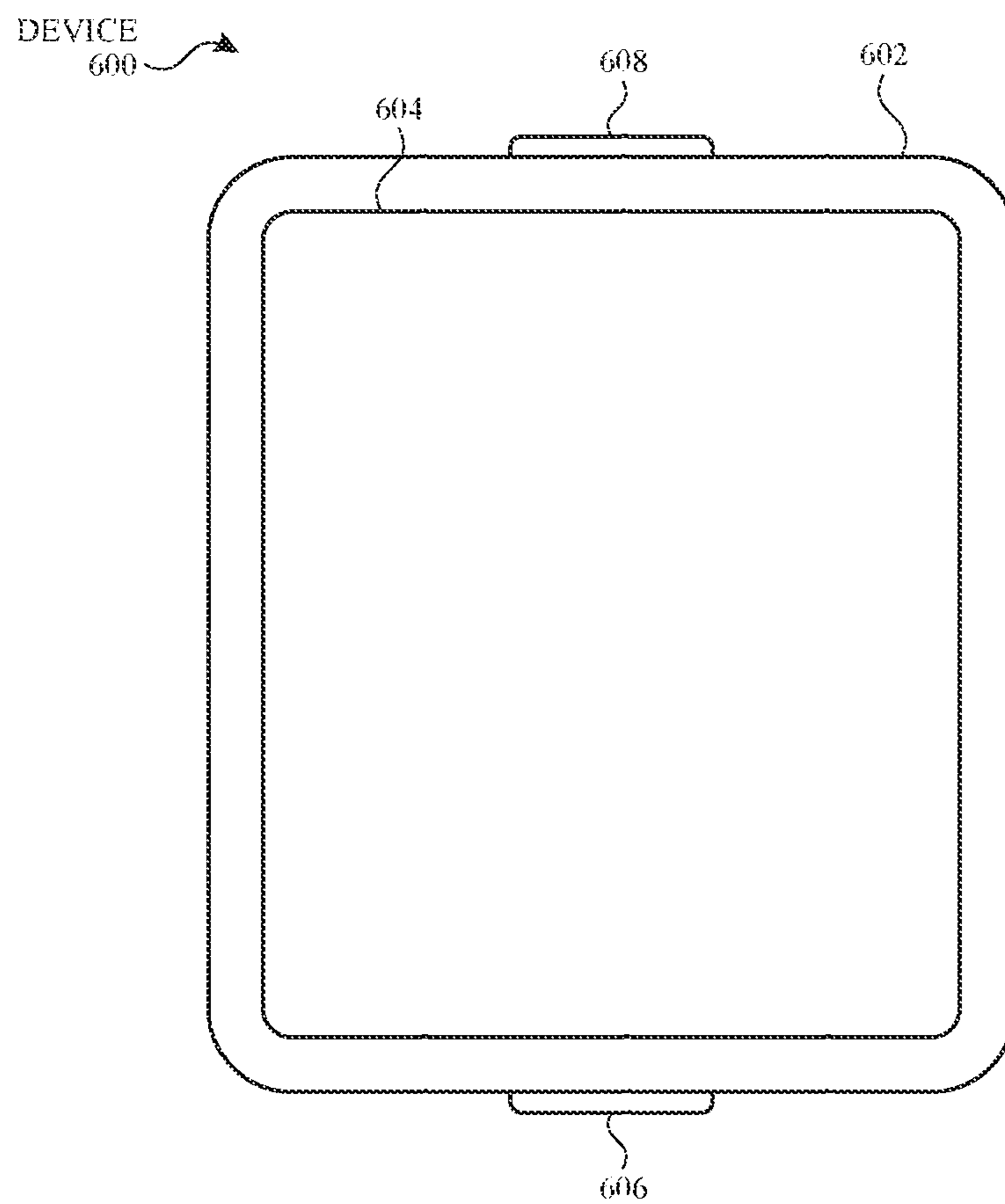

FIG. 6A

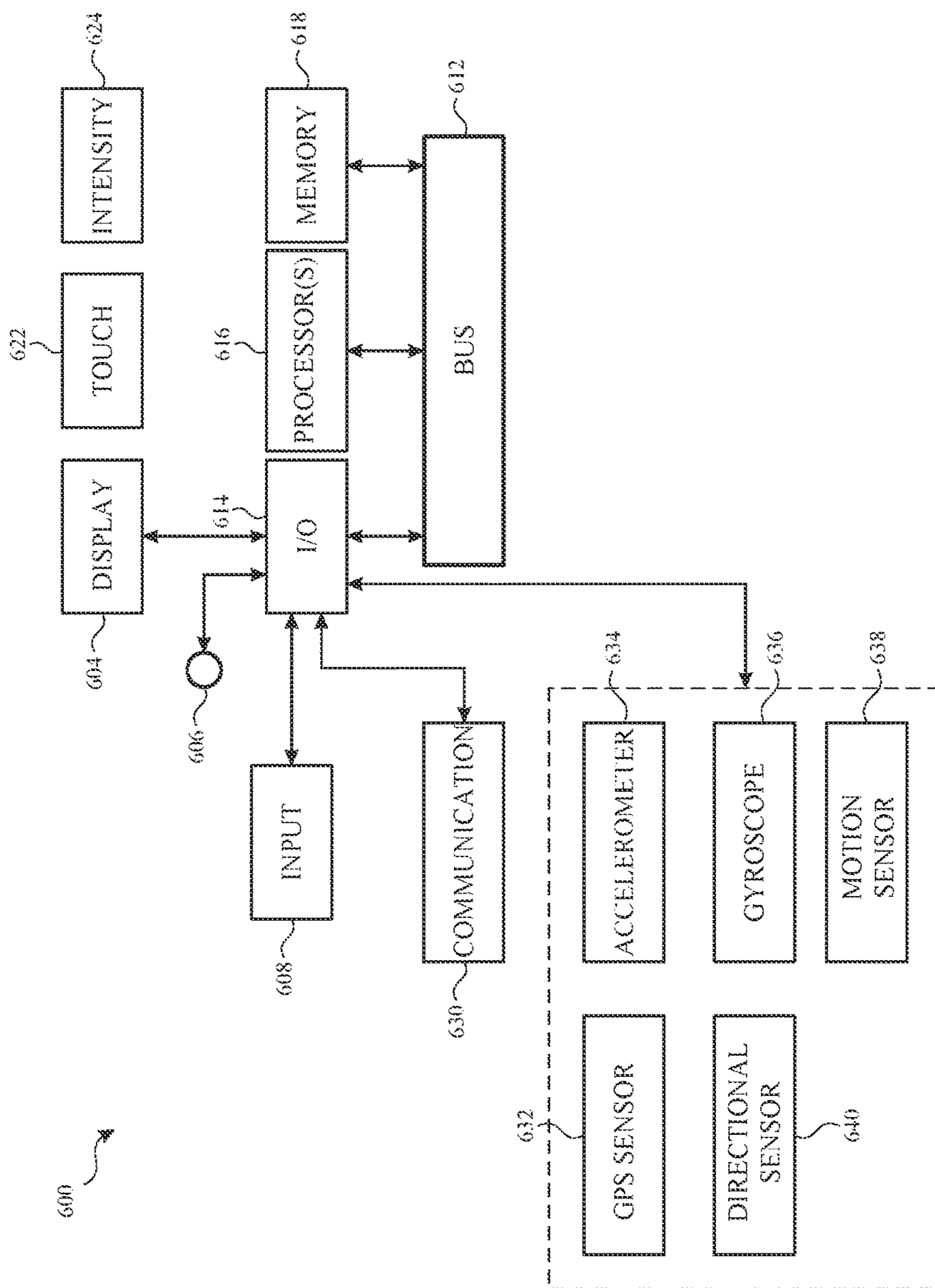

FIG. 6B

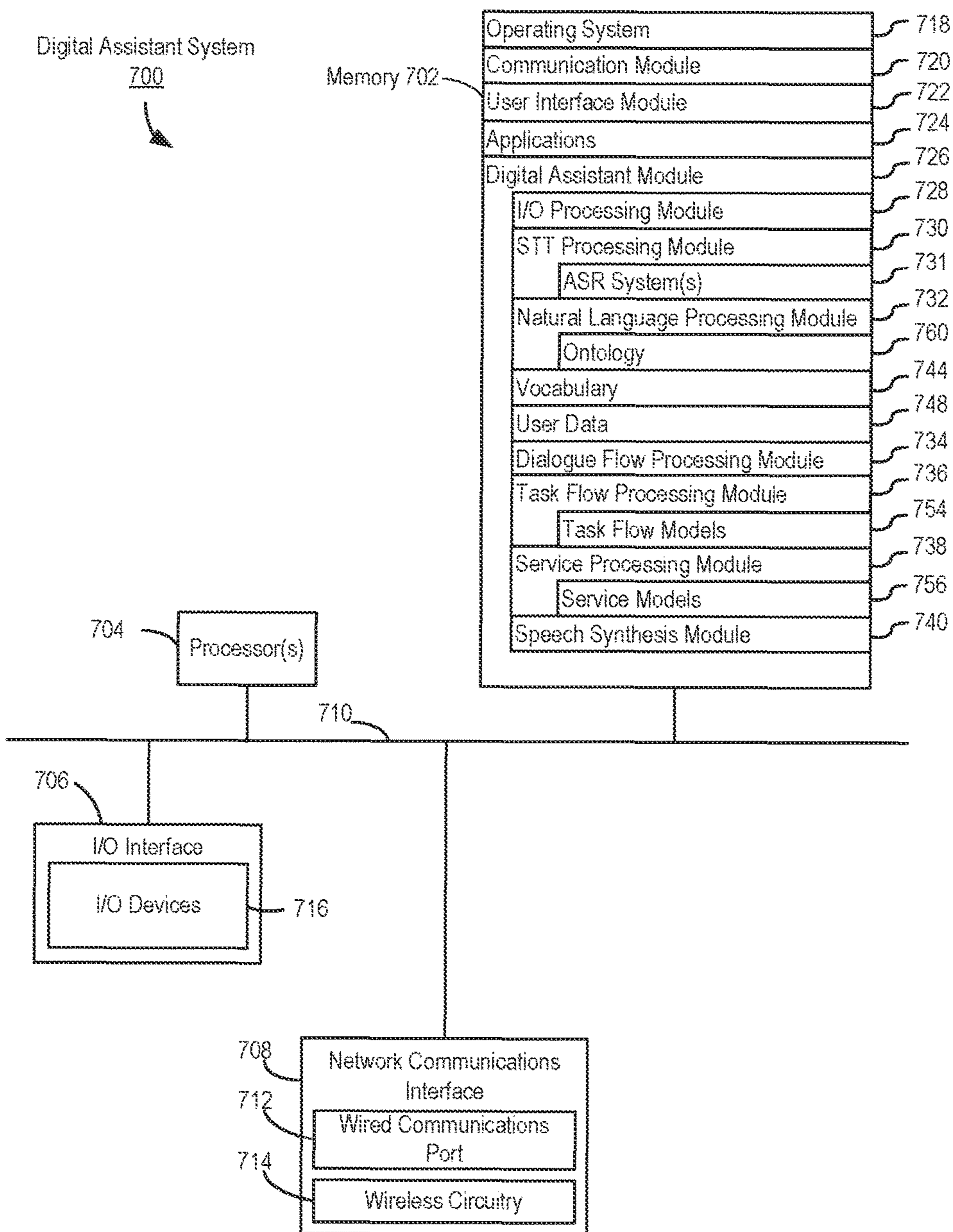

FIG. 7A

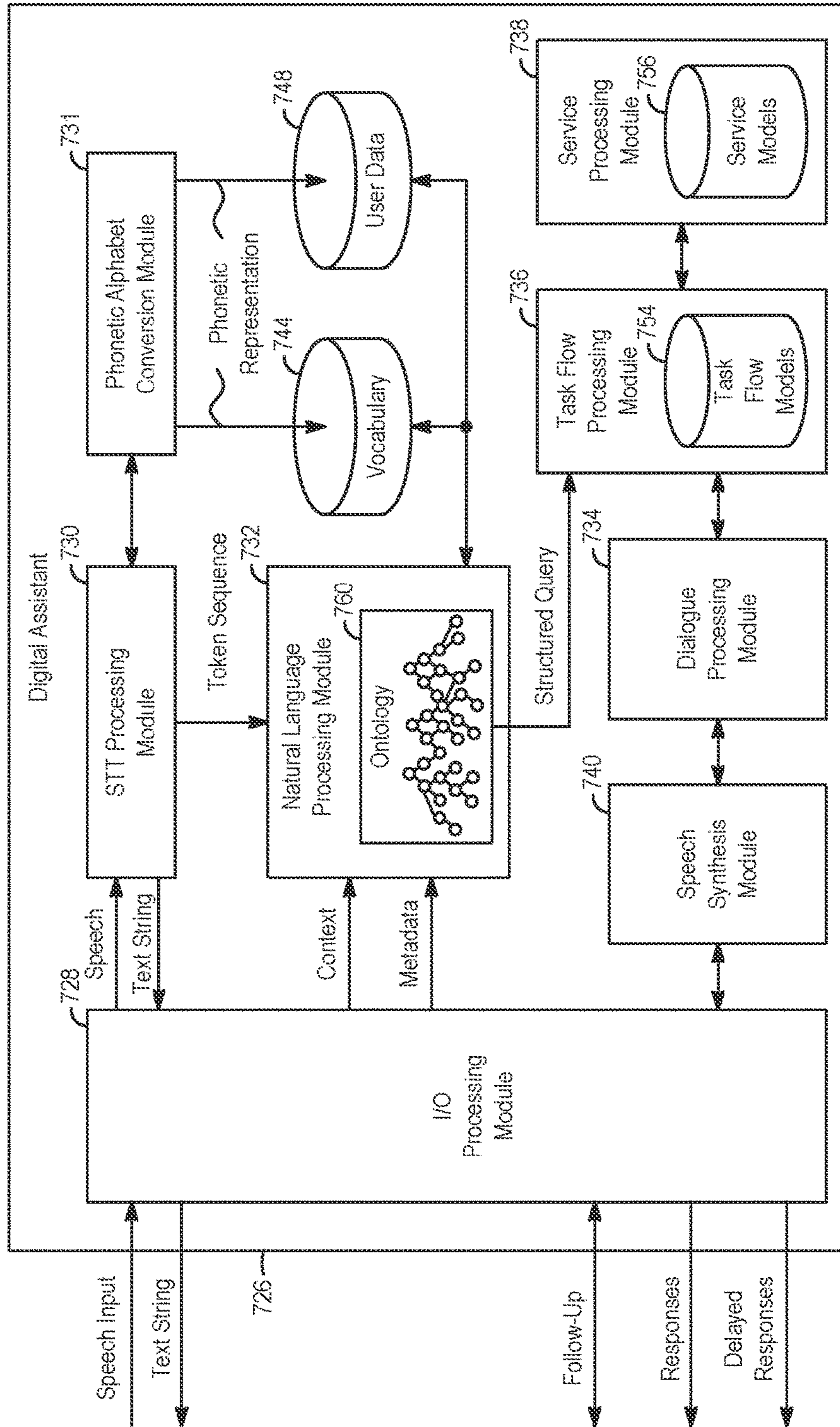

FIG. 7B

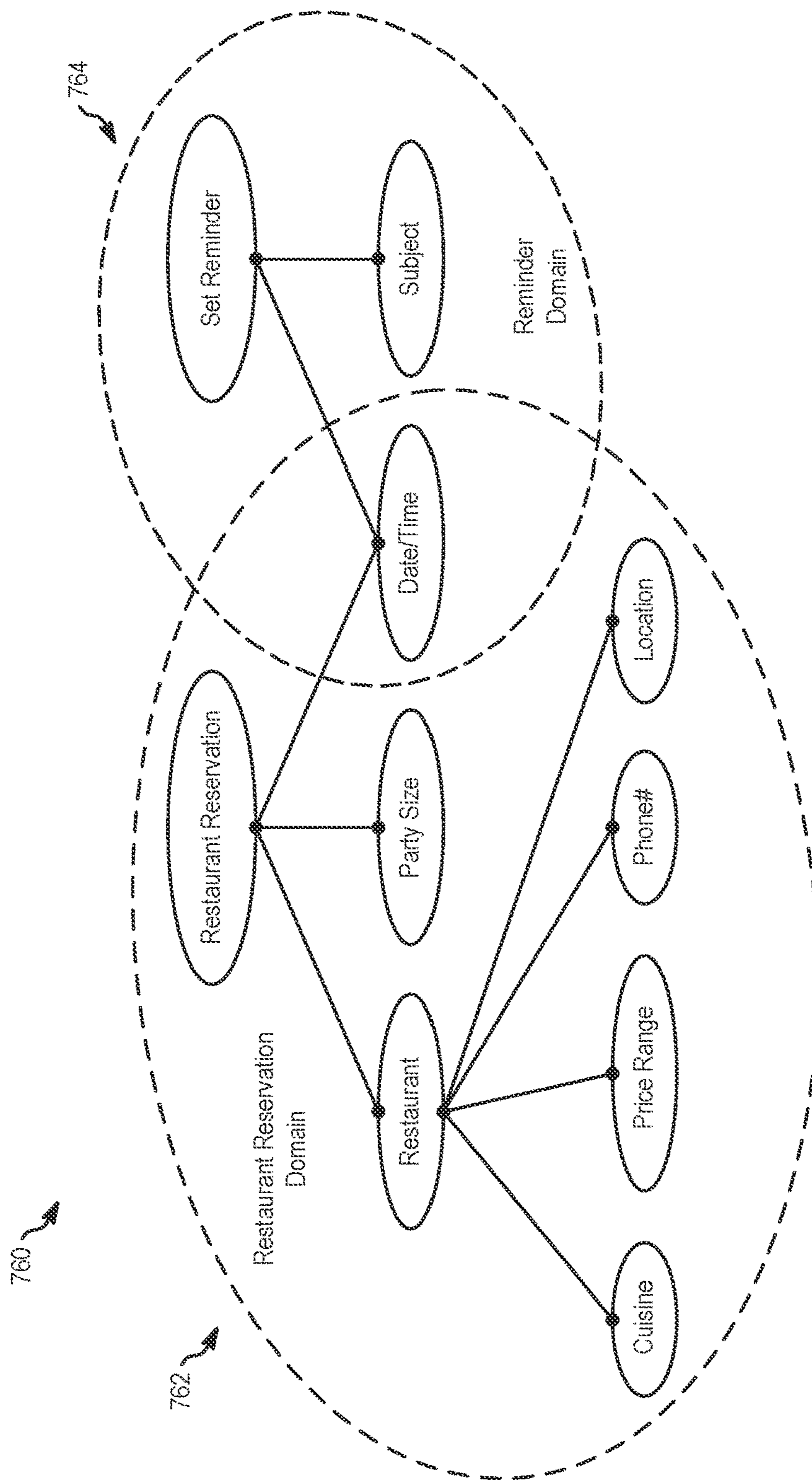

FIG. 7C

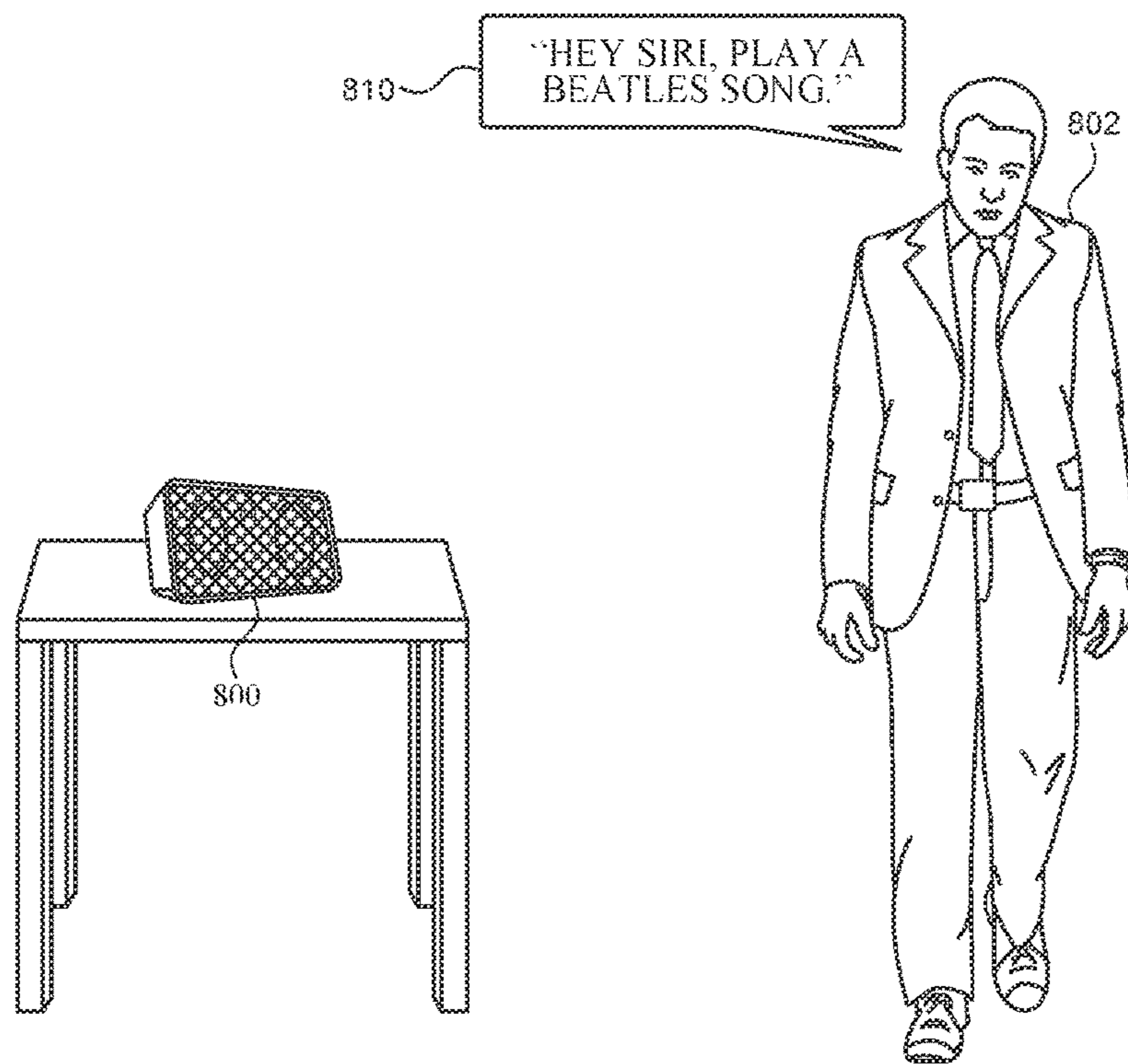

FIG. 8A

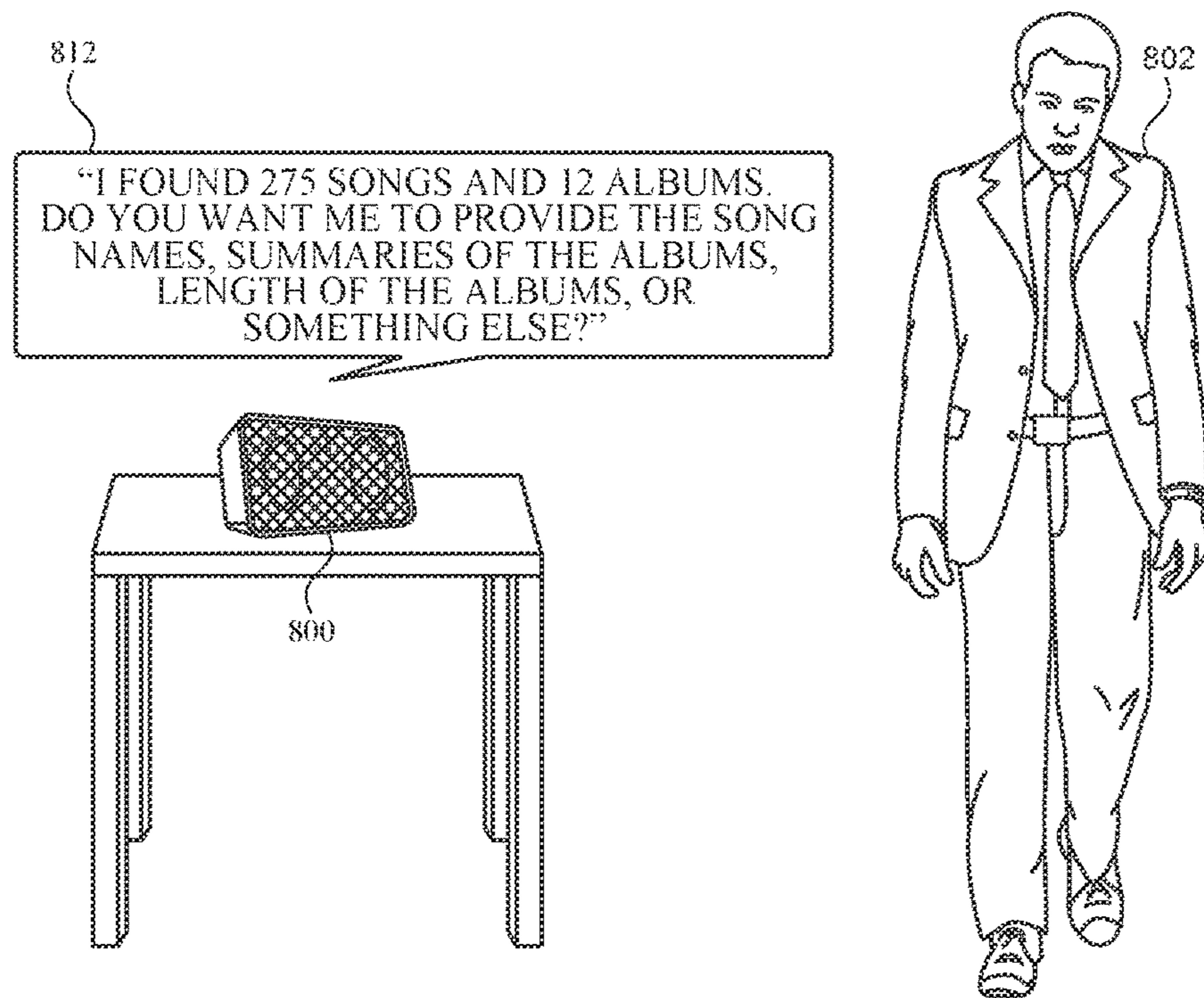

FIG. 8B

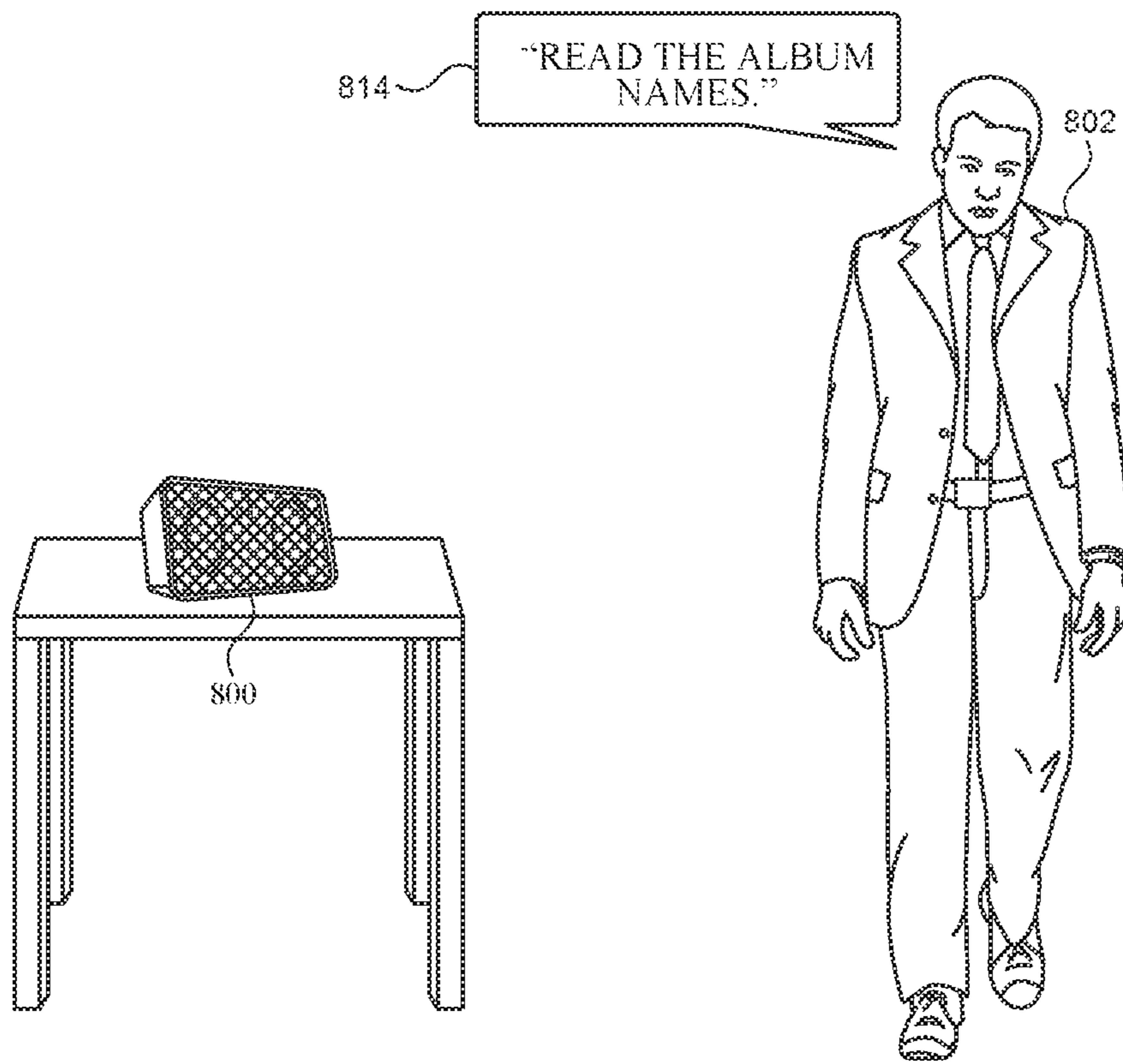

FIG. 8C

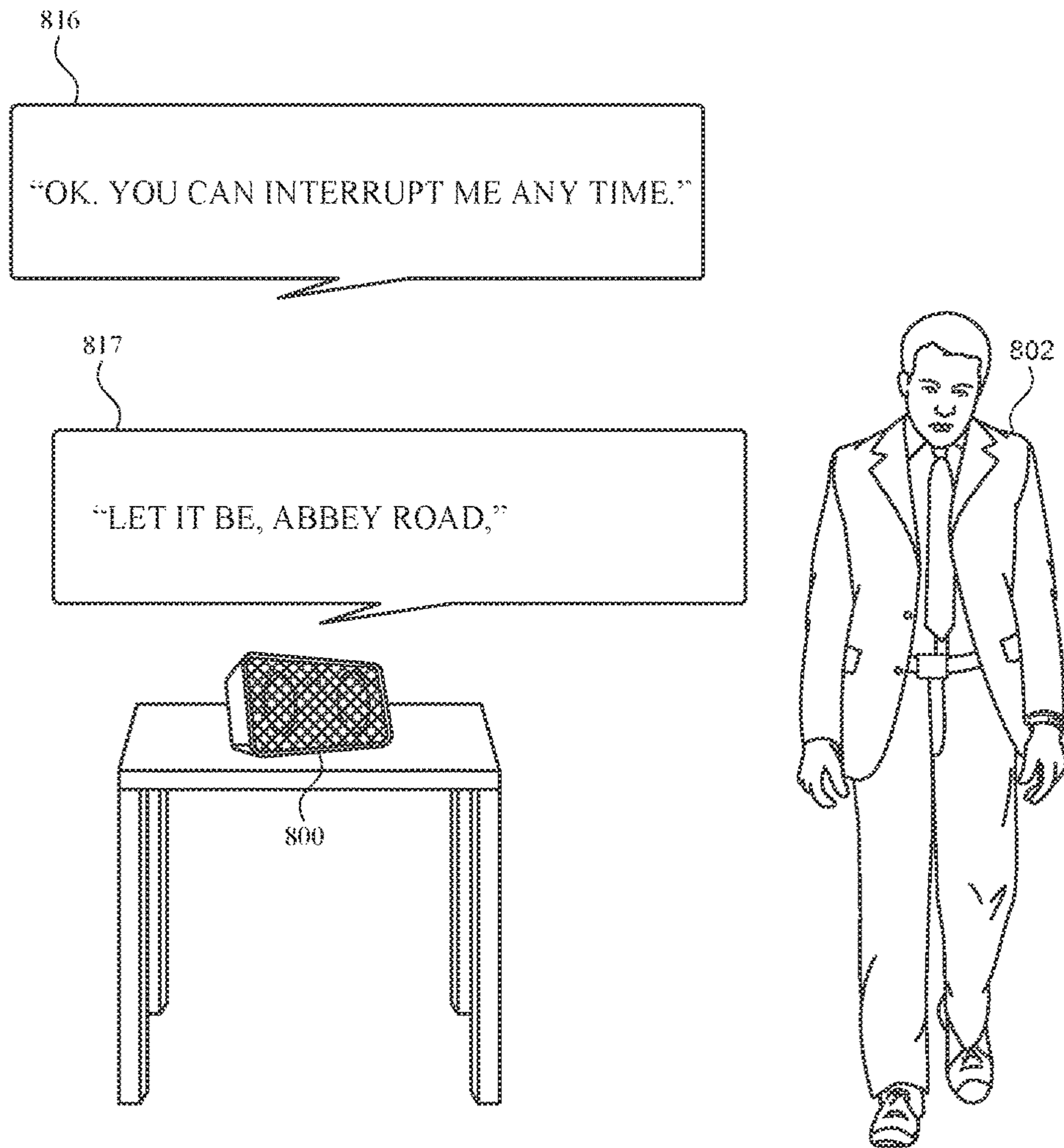

FIG. 8D

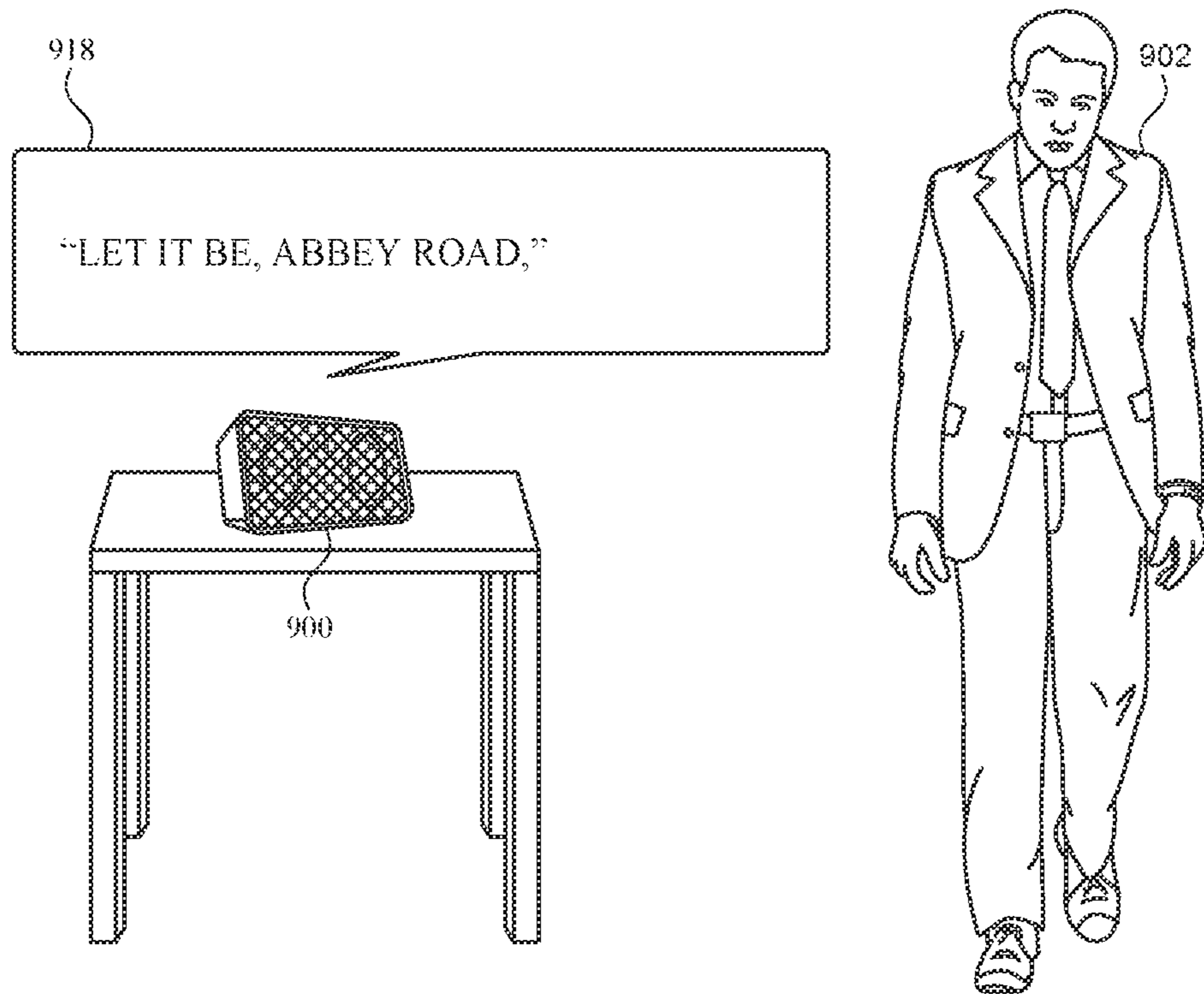

FIG. 9A

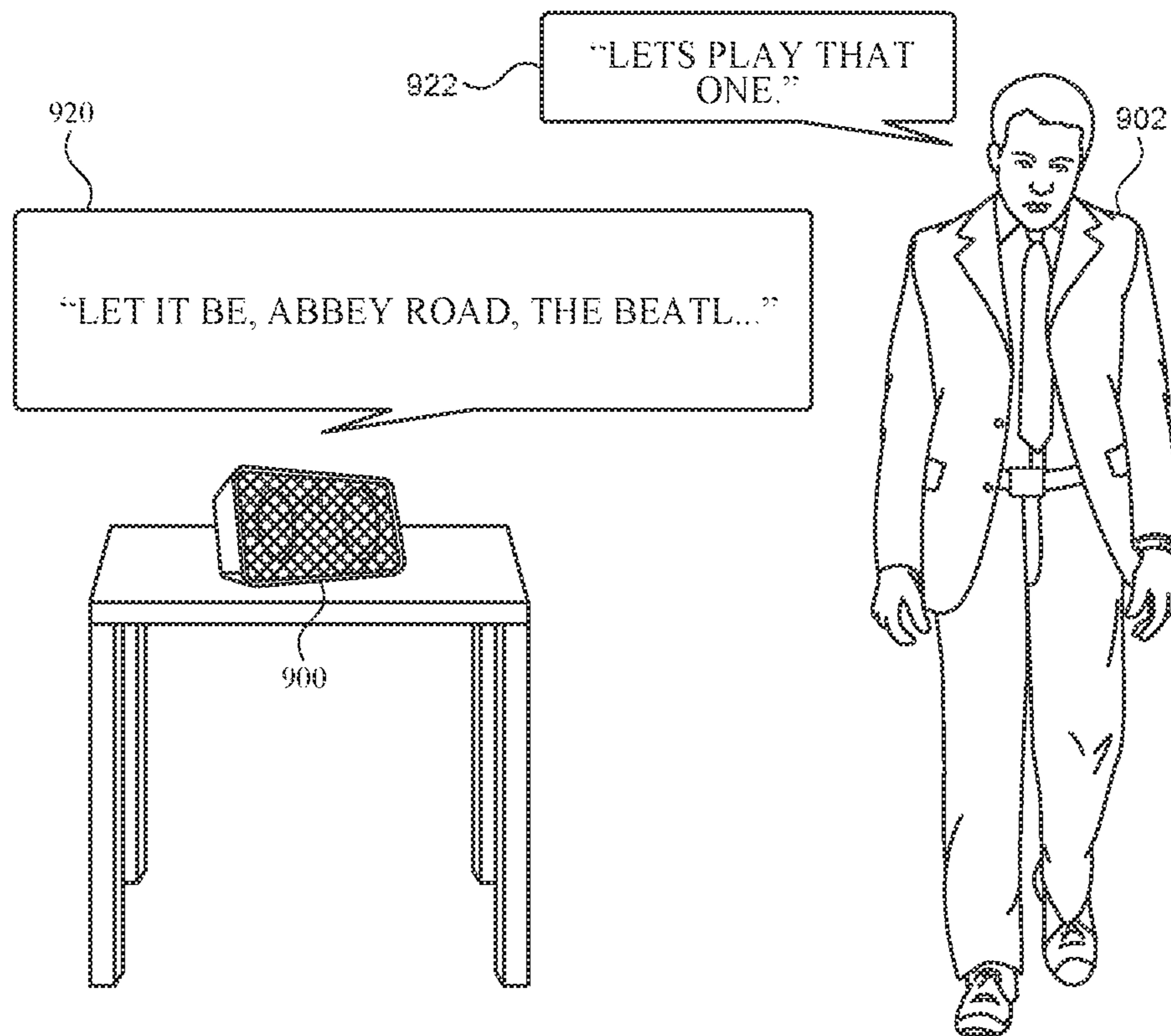

FIG. 9B

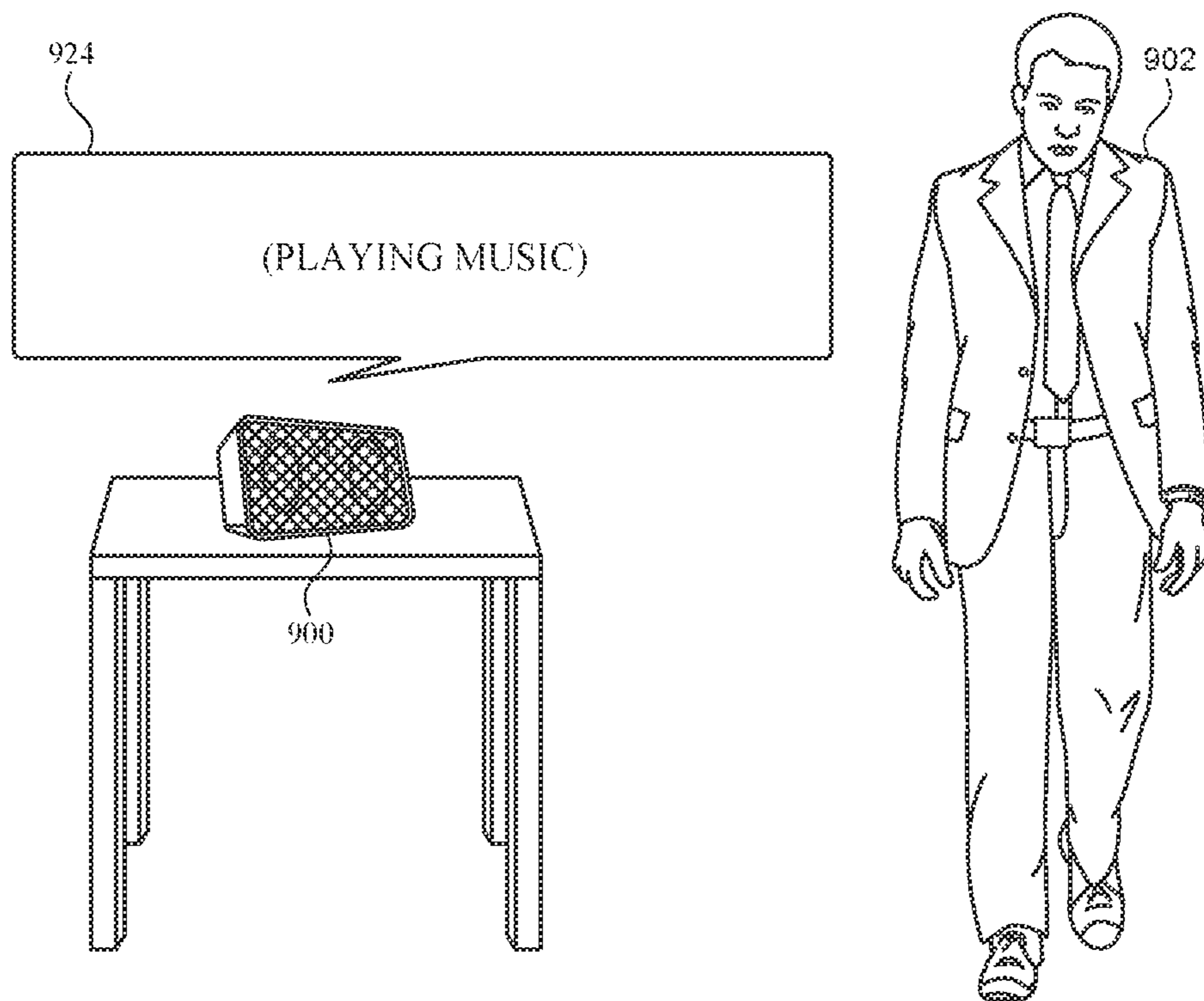

FIG. 9C

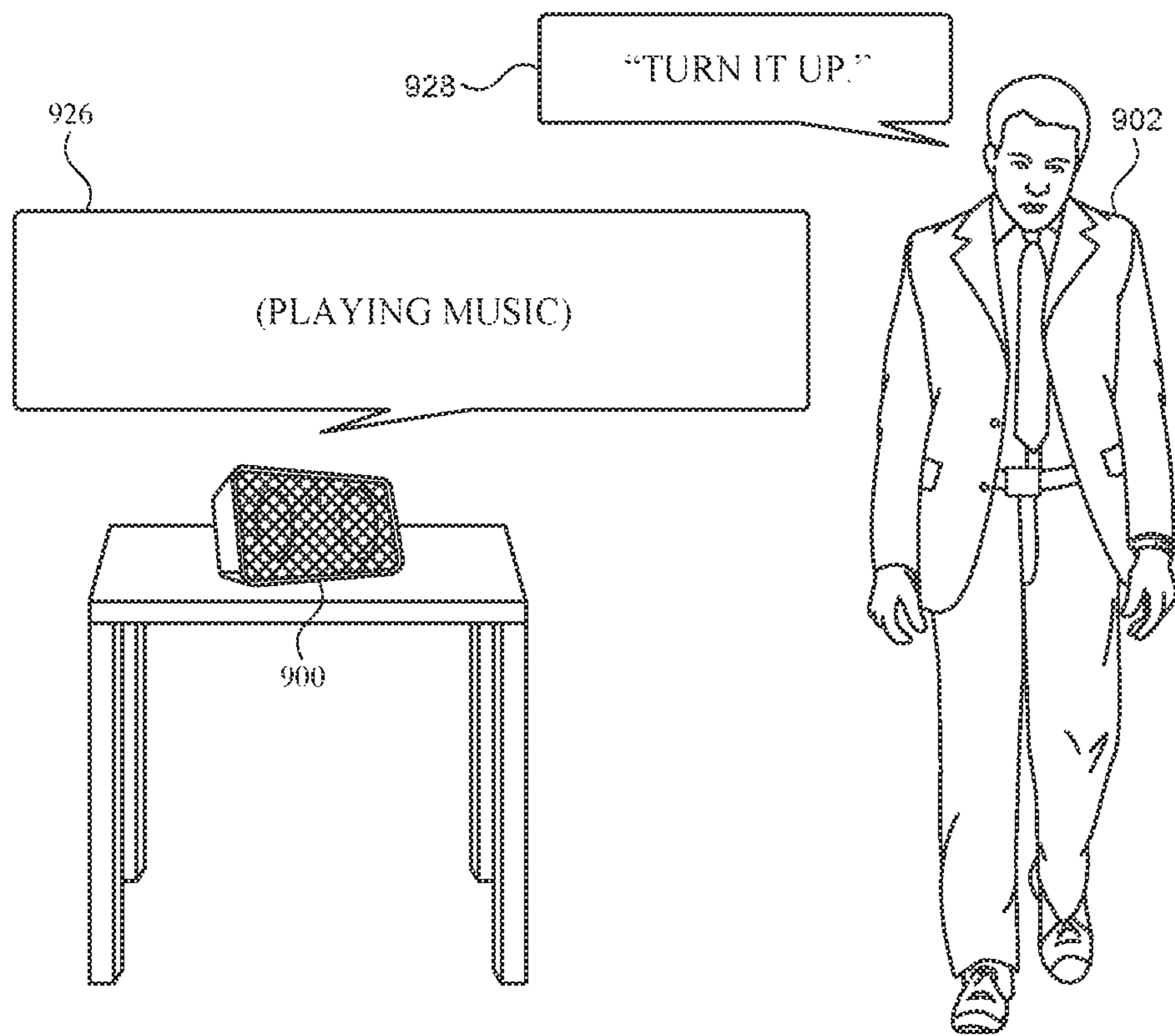

FIG. 9D

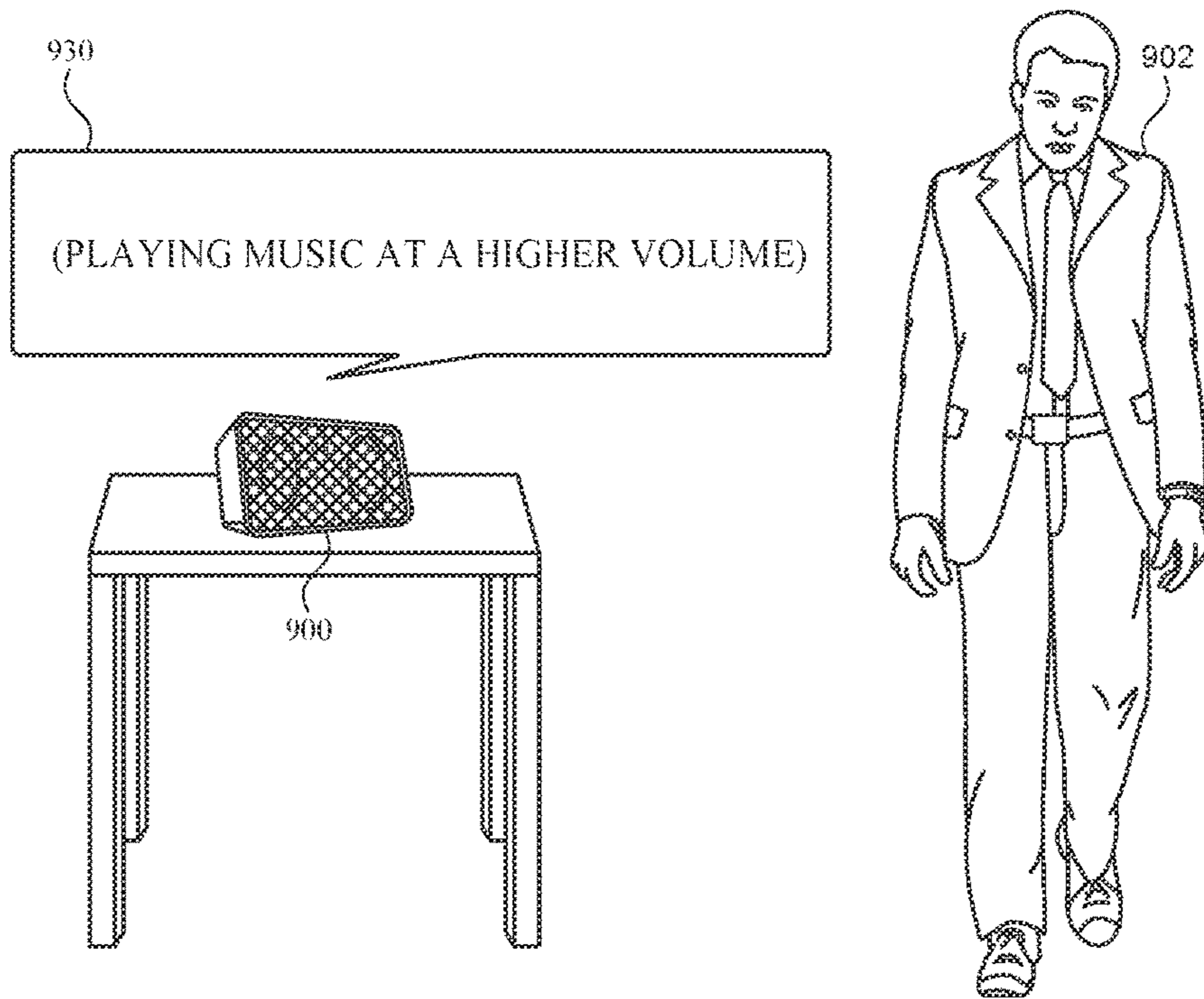

FIG. 9E

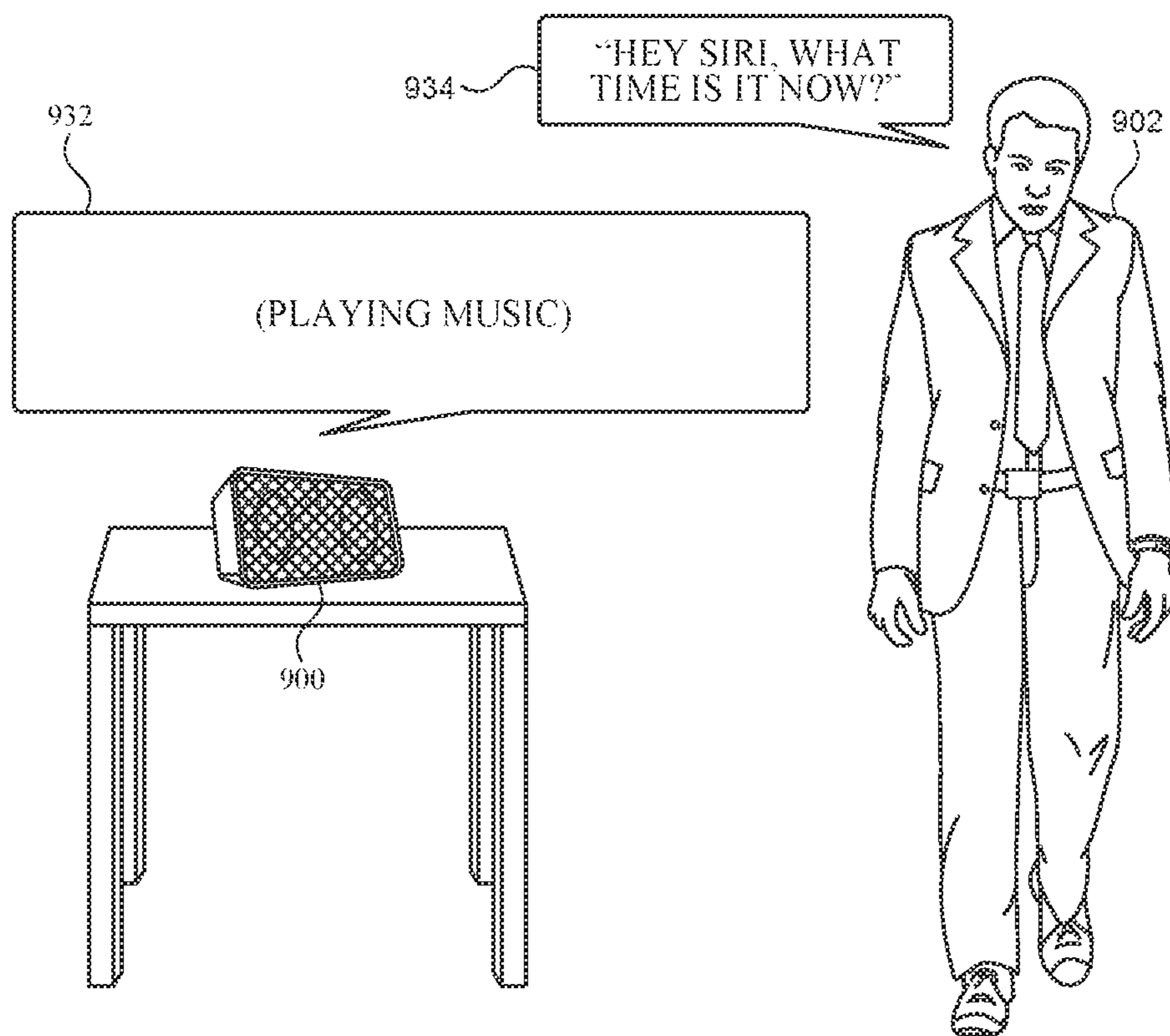

FIG. 9F

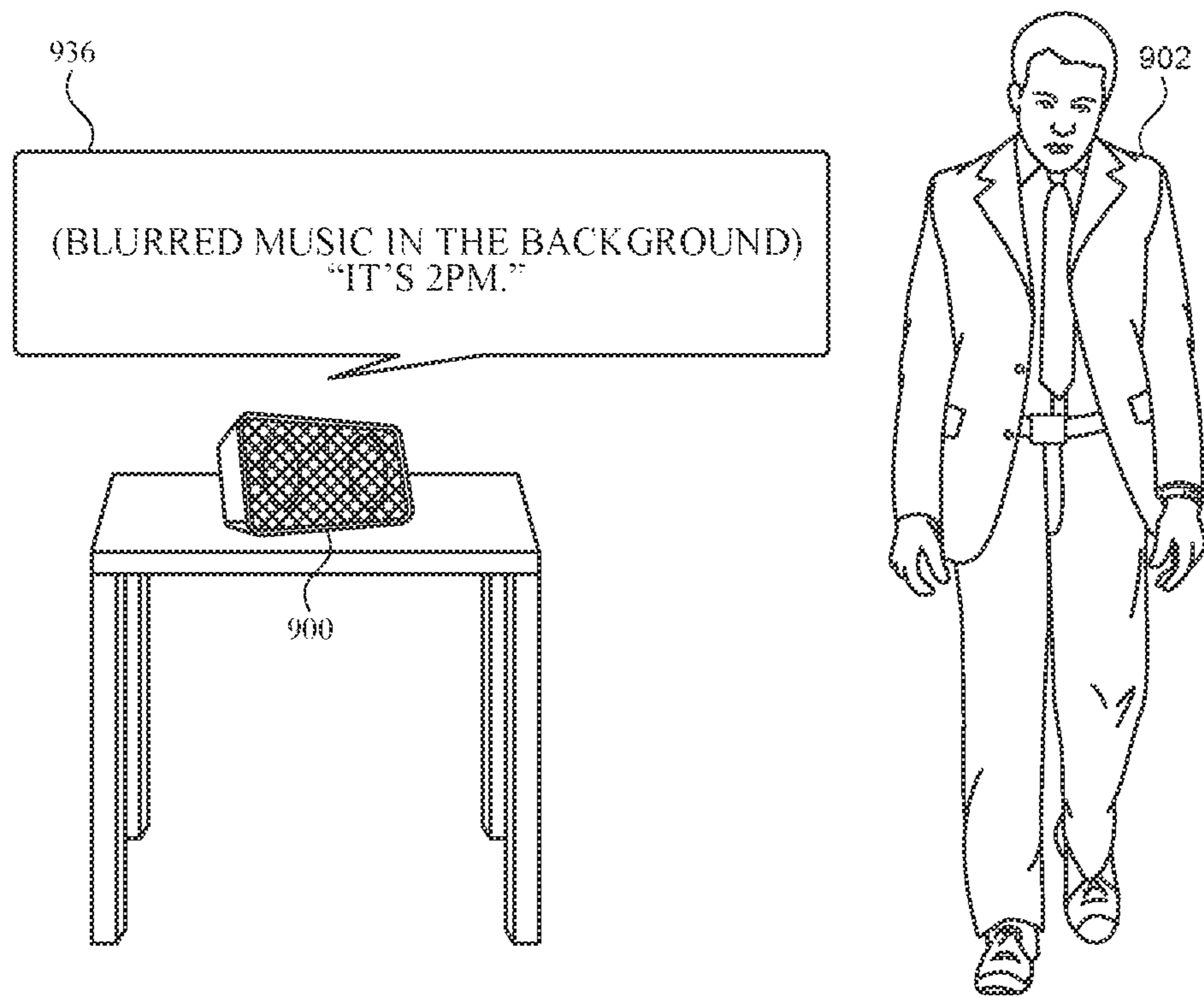

FIG. 9G

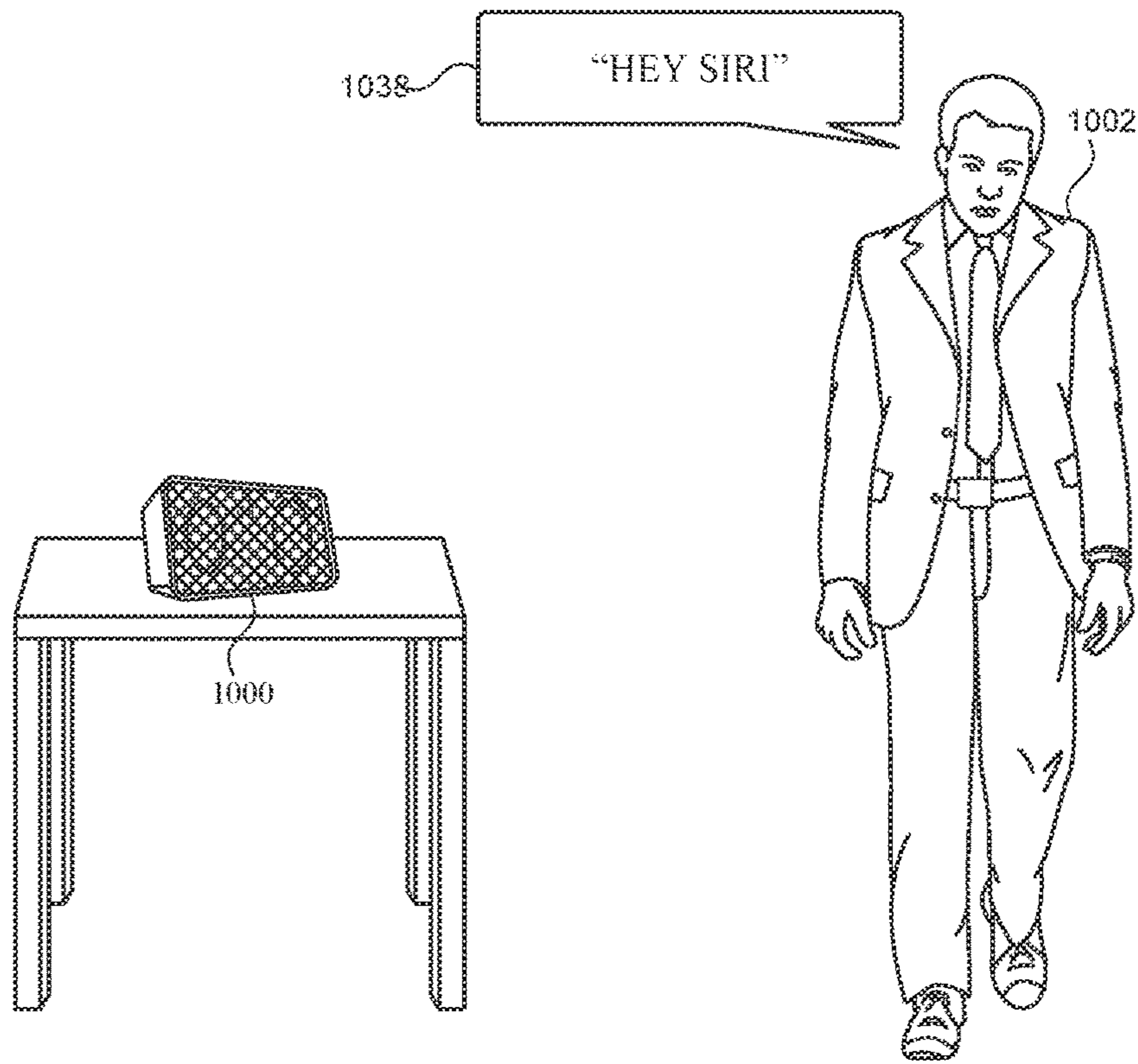

FIG. 10A

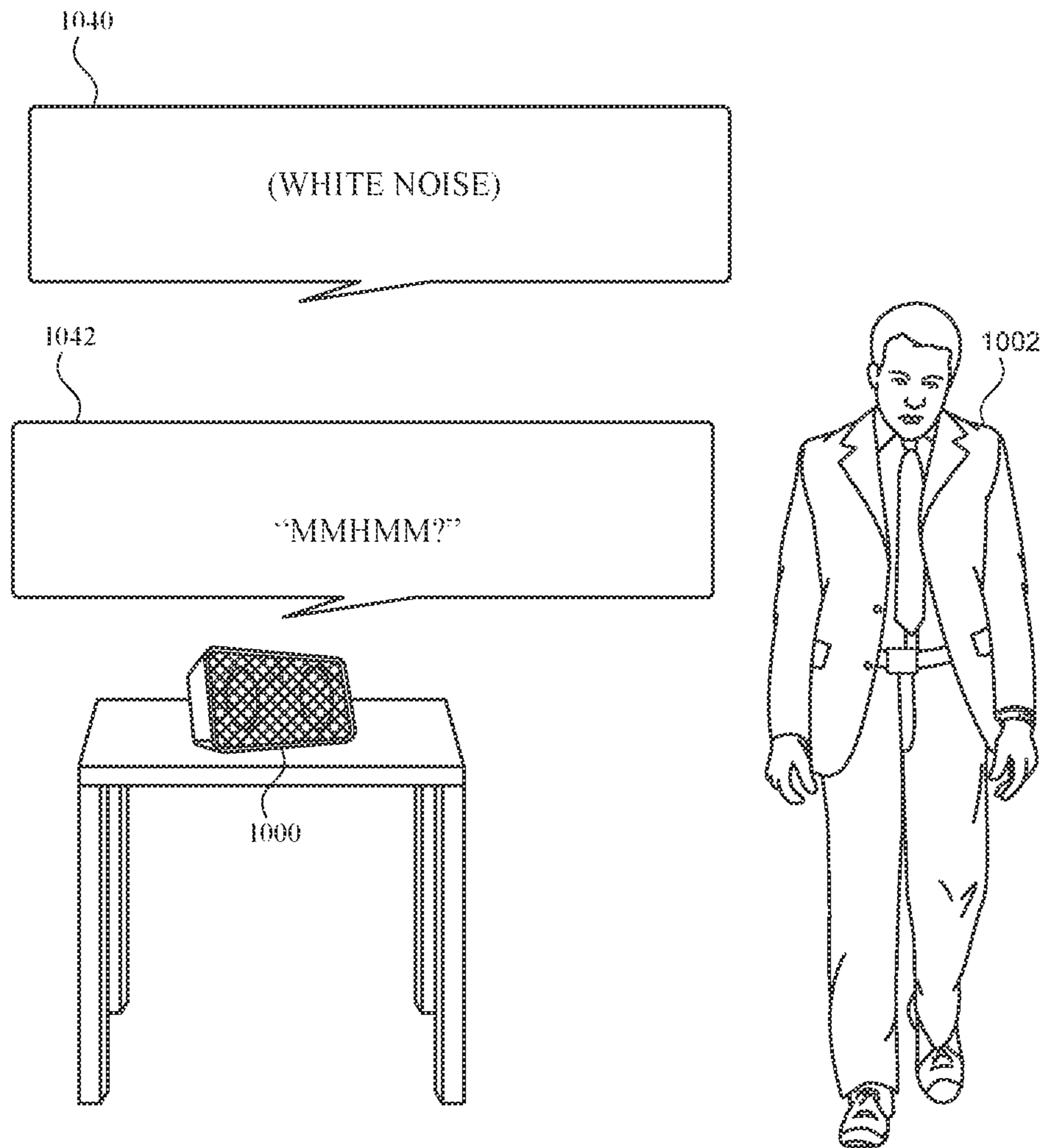

FIG. 10B

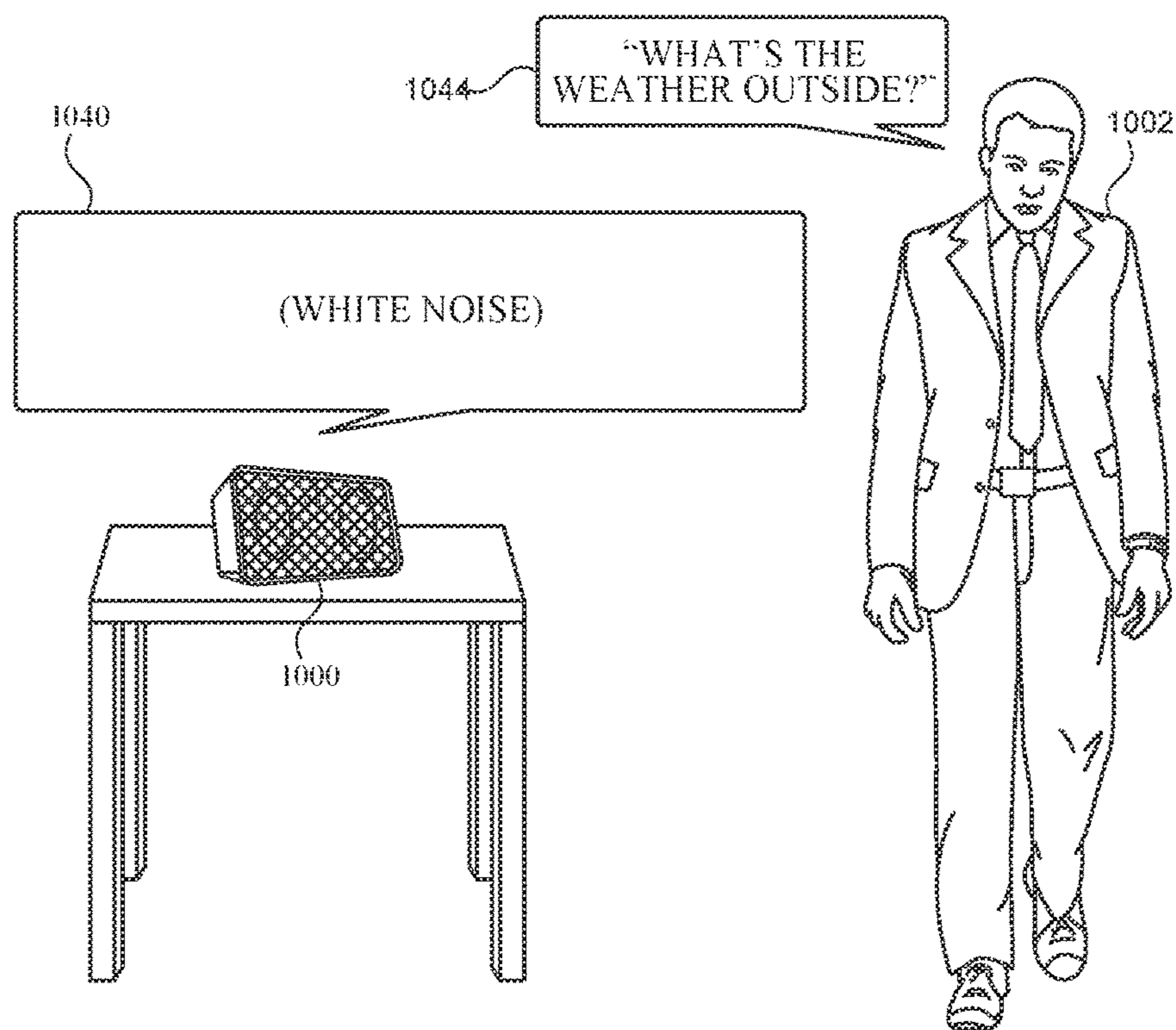

FIG. 10C

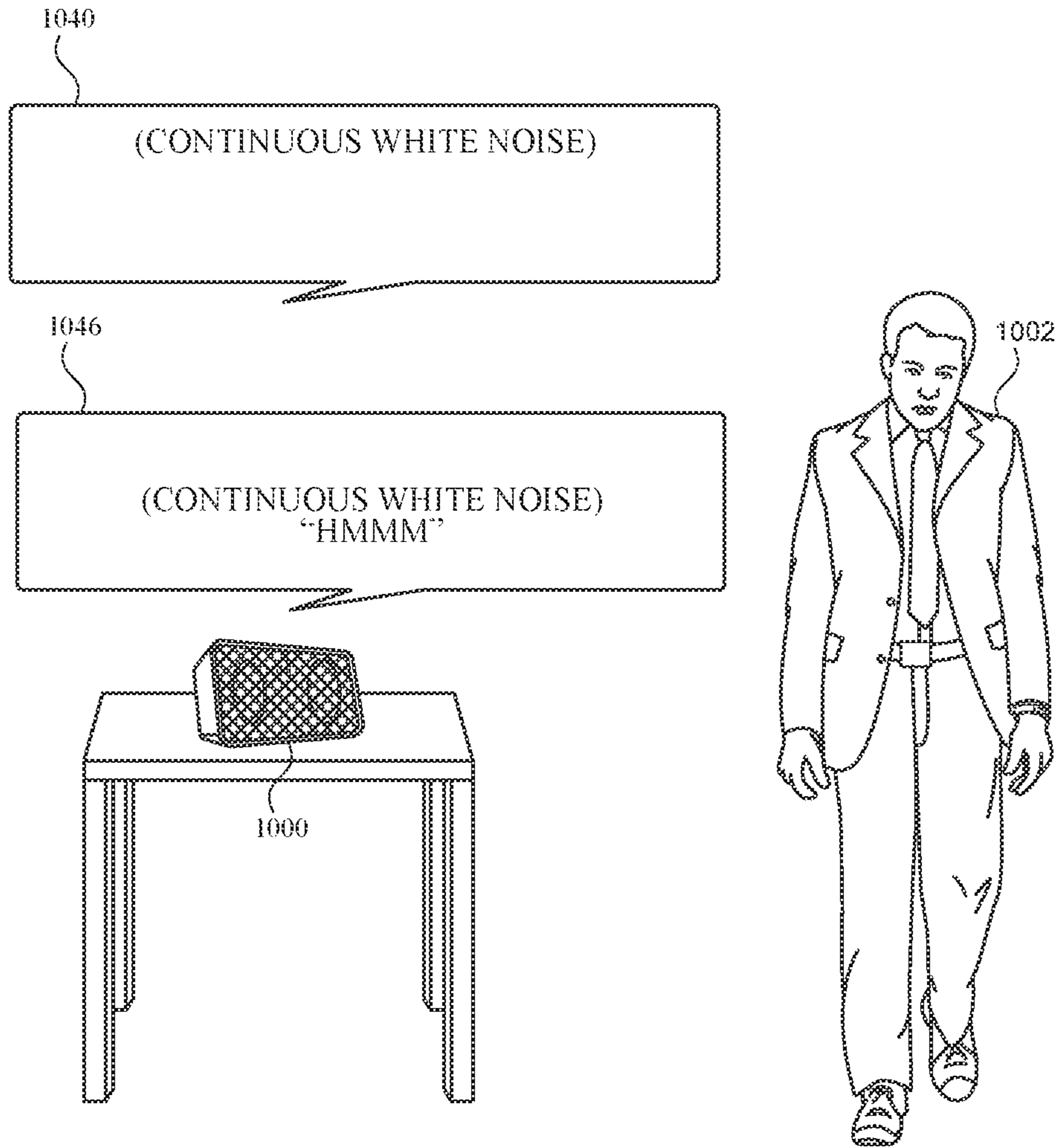

FIG. 10D

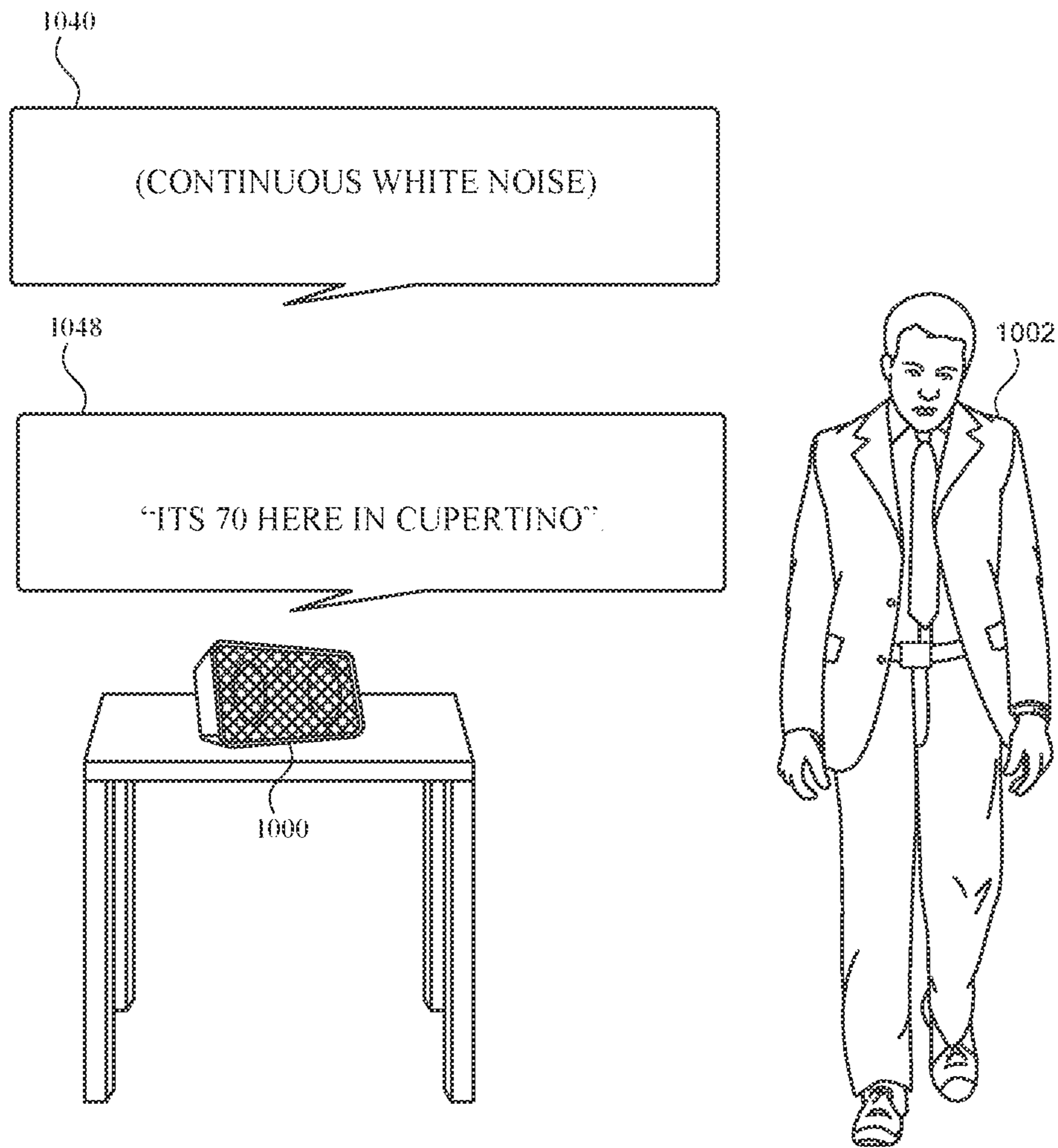

FIG. 10E

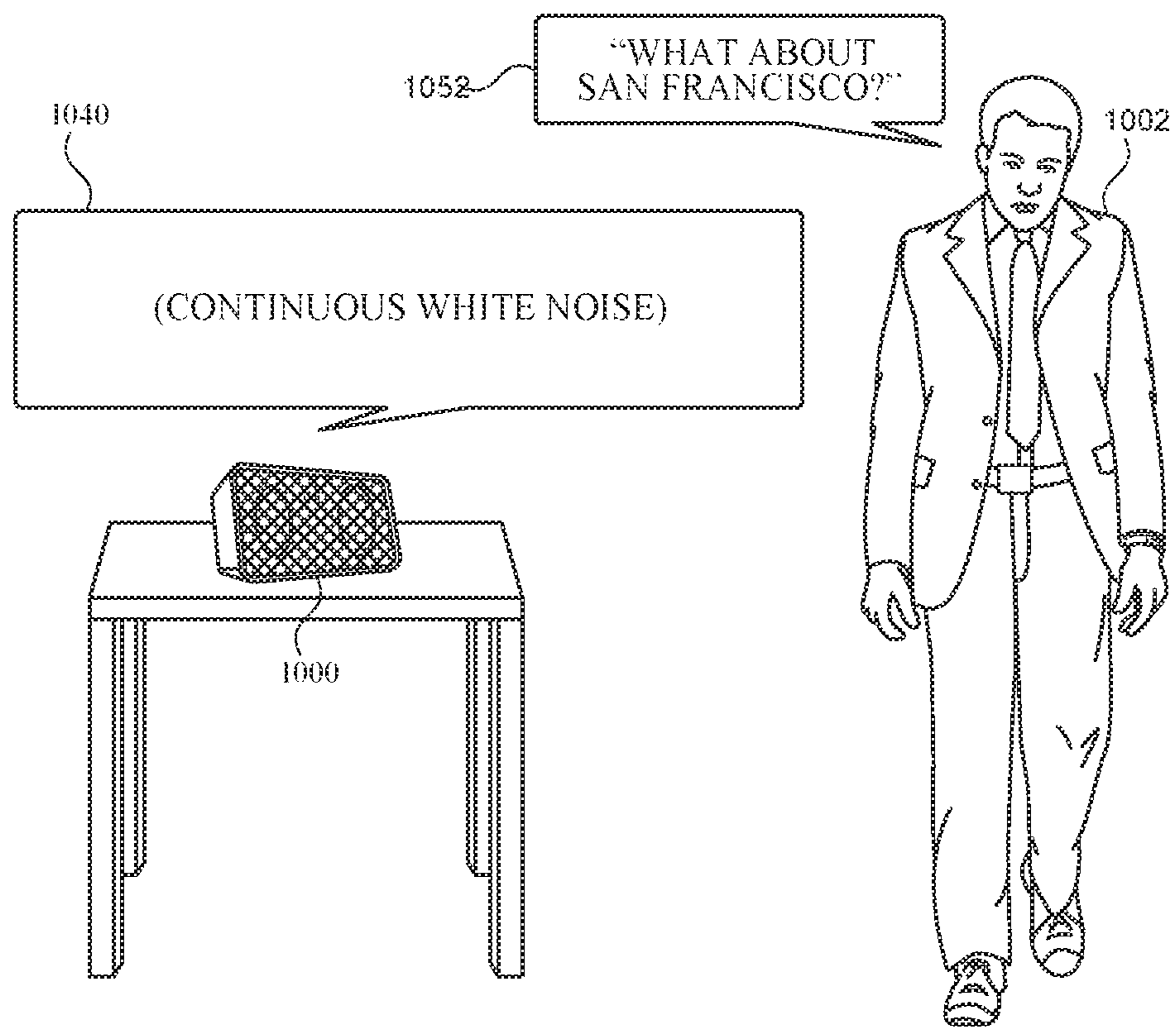

FIG. 10F

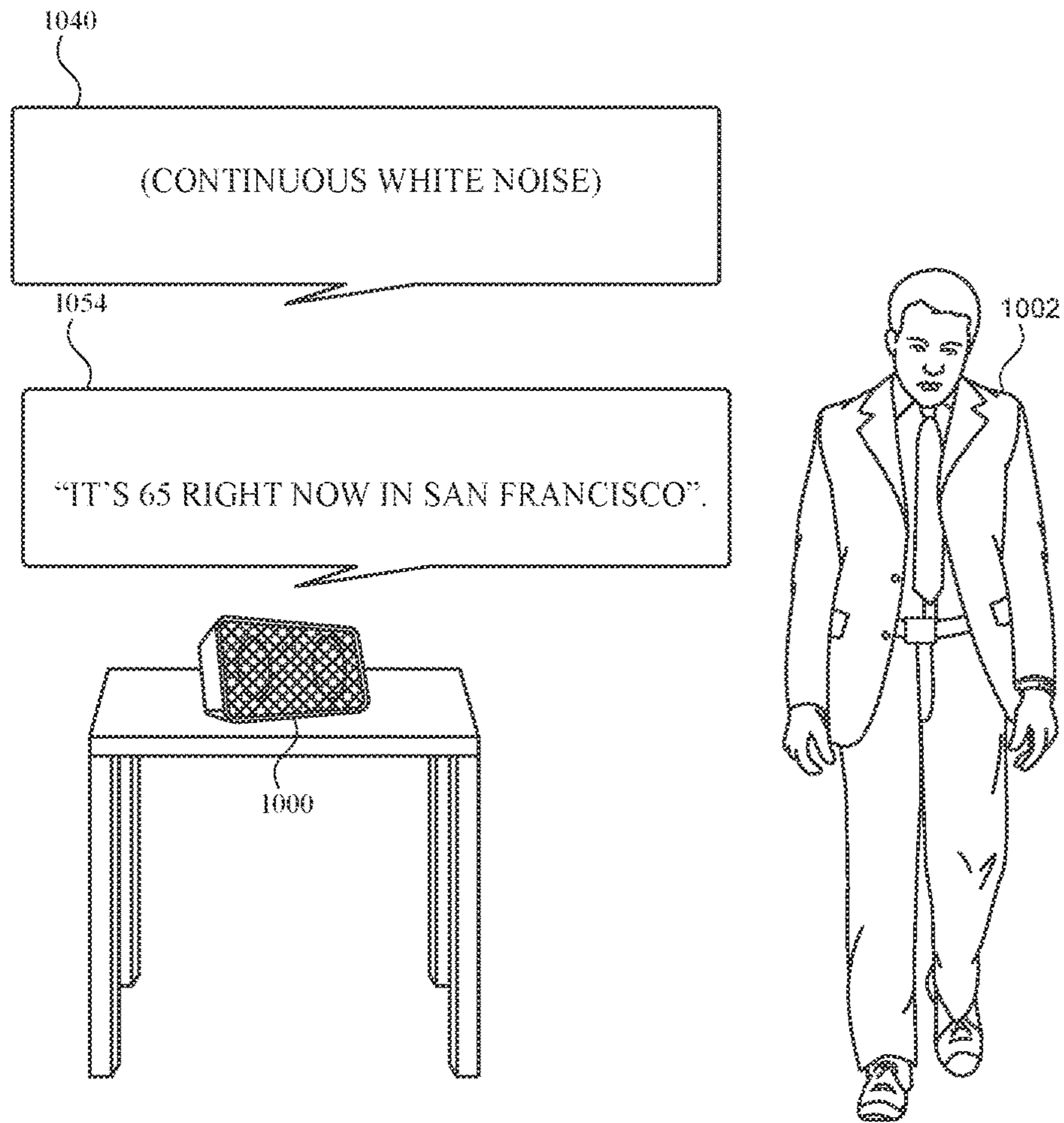

FIG. 10G

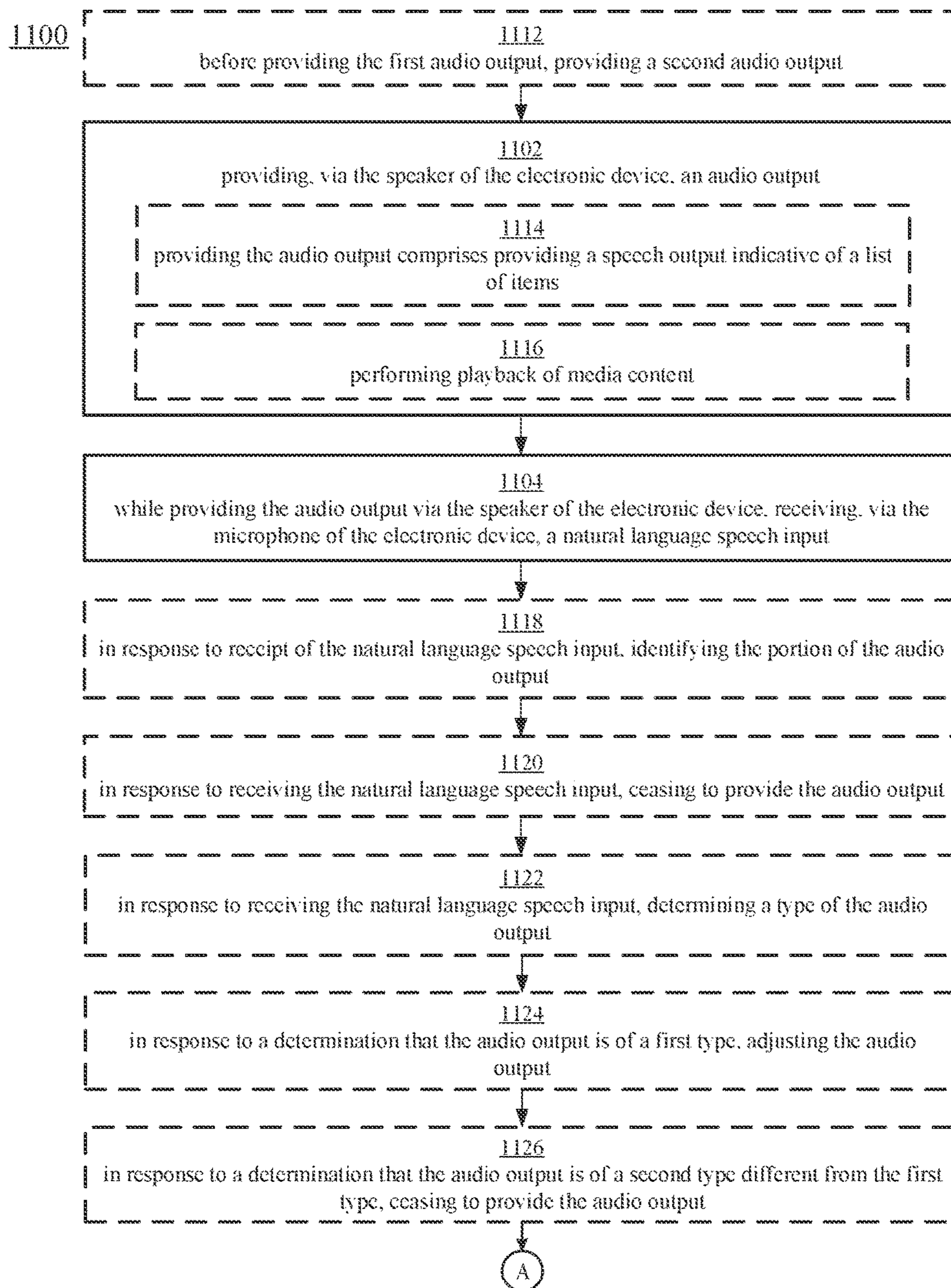

FIG. 11A

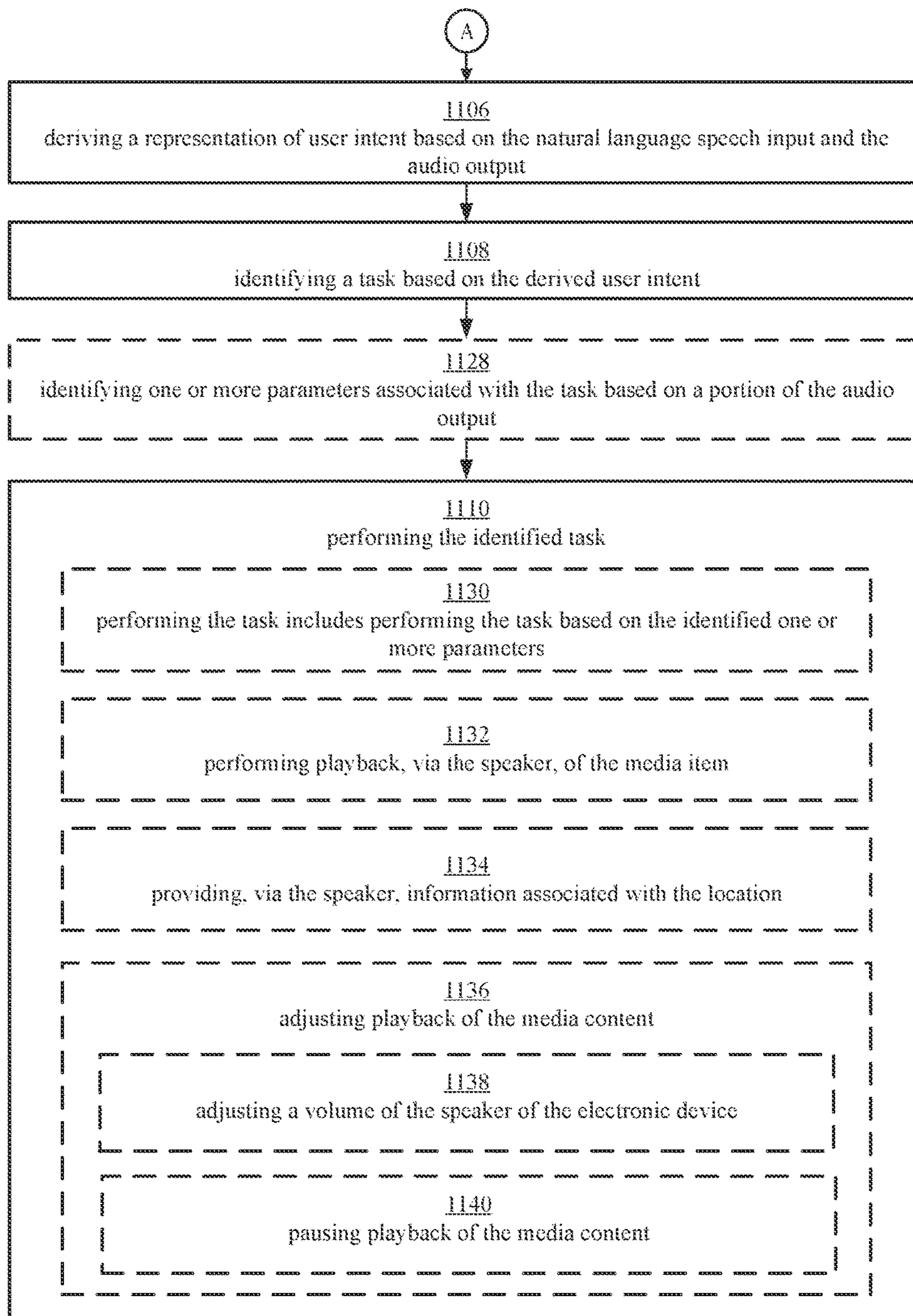

FIG. 11B

1200

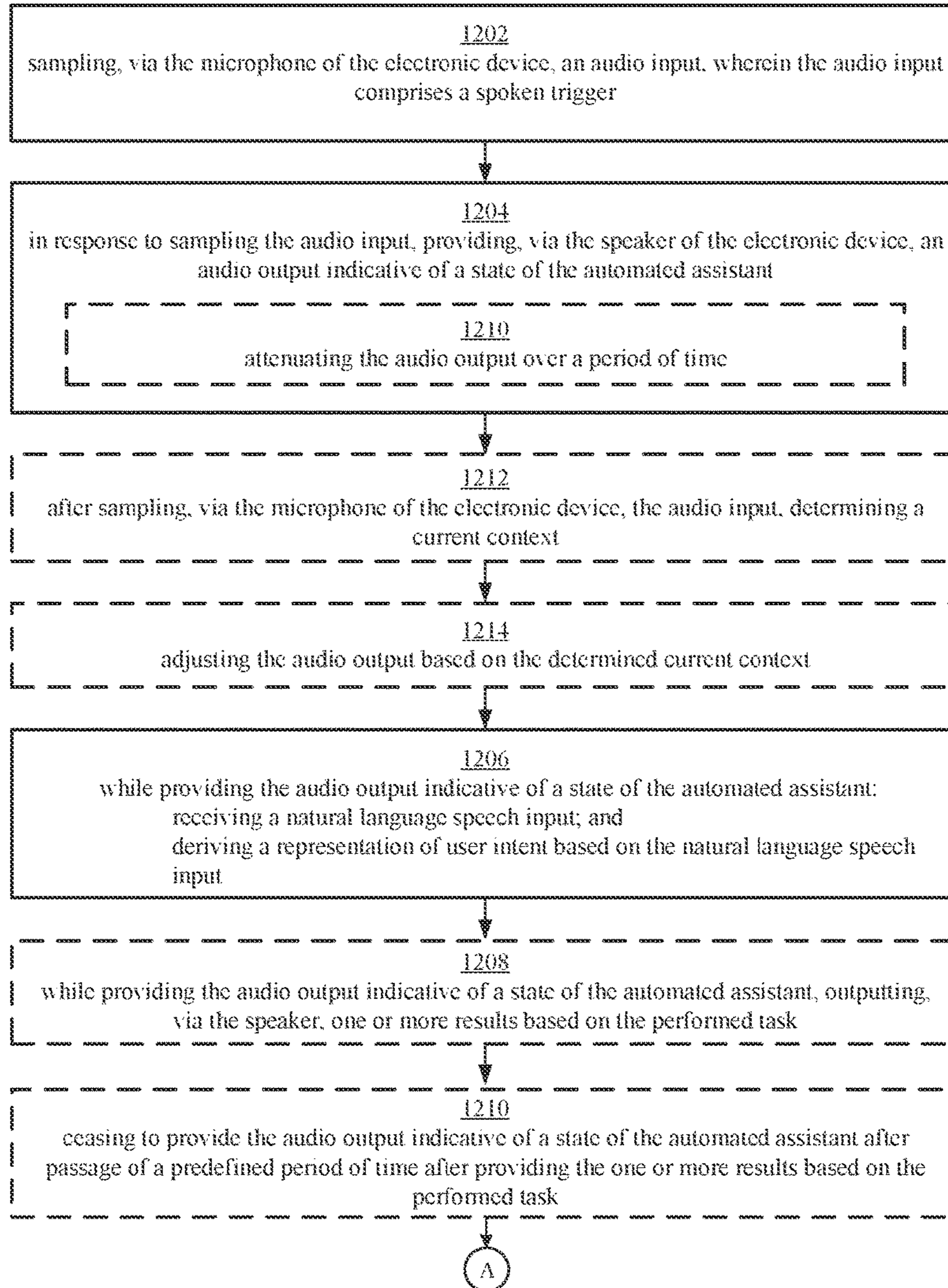

FIG. 12A

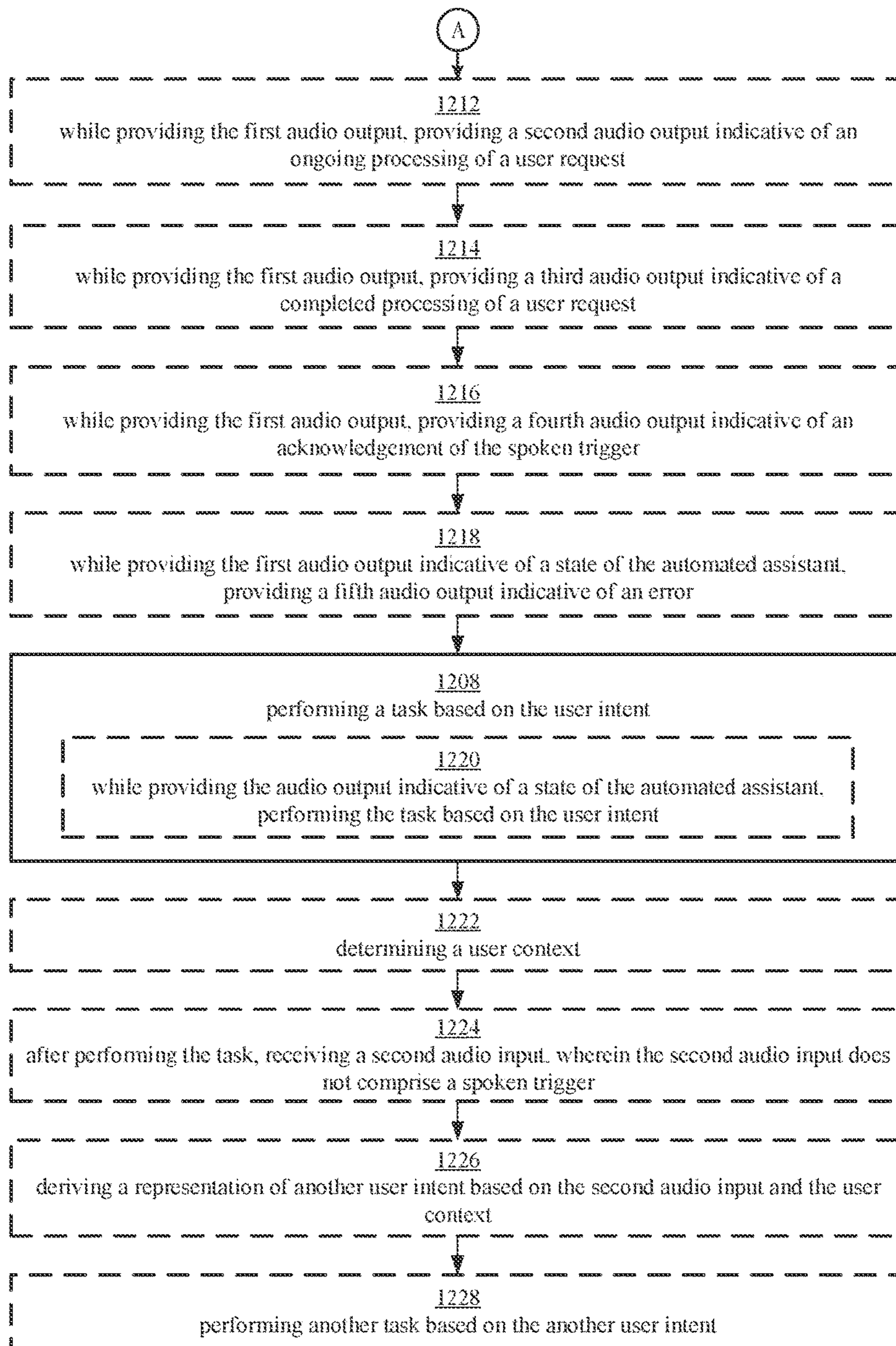

FIG. 12B

1300

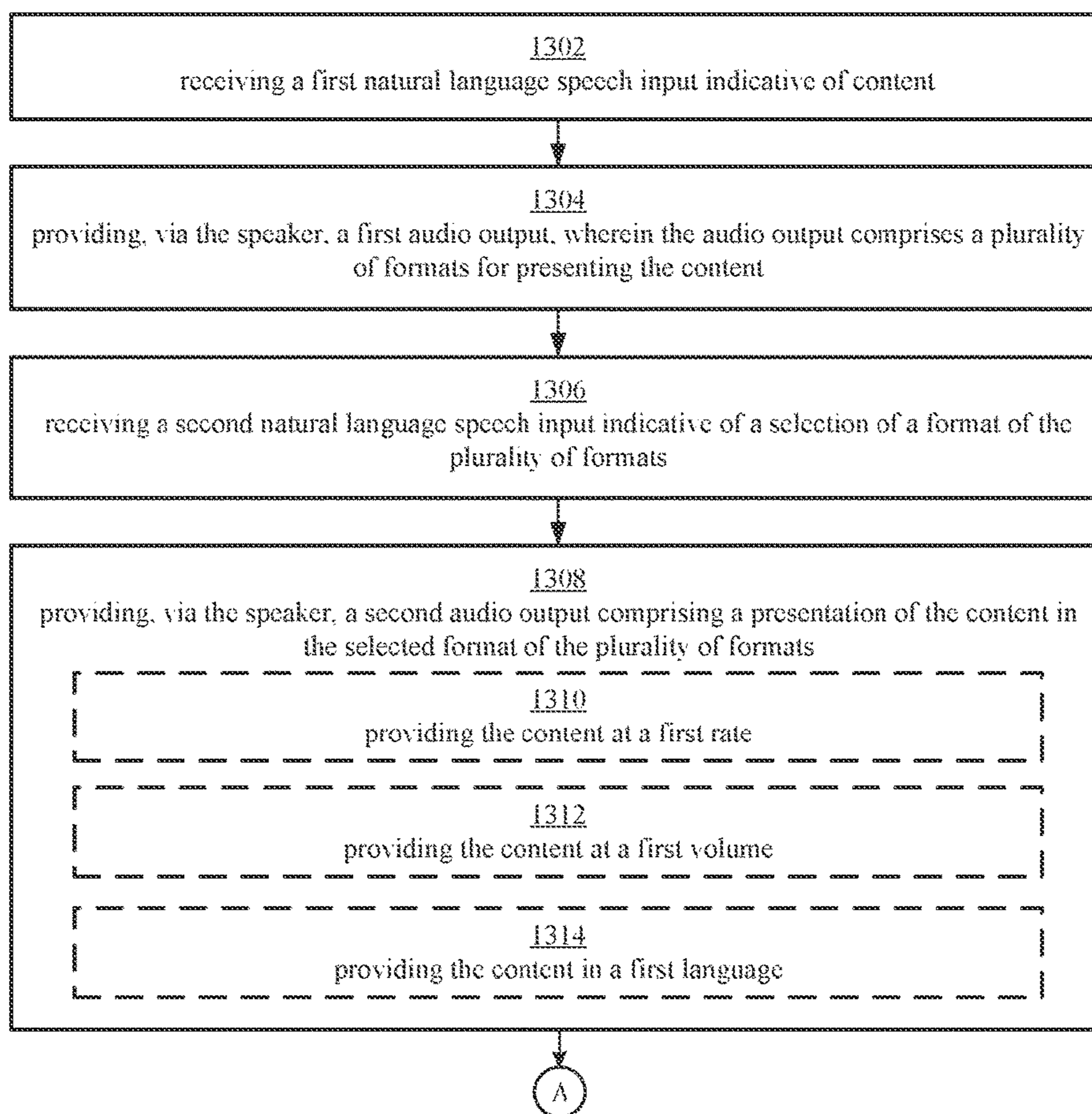

FIG. 13A

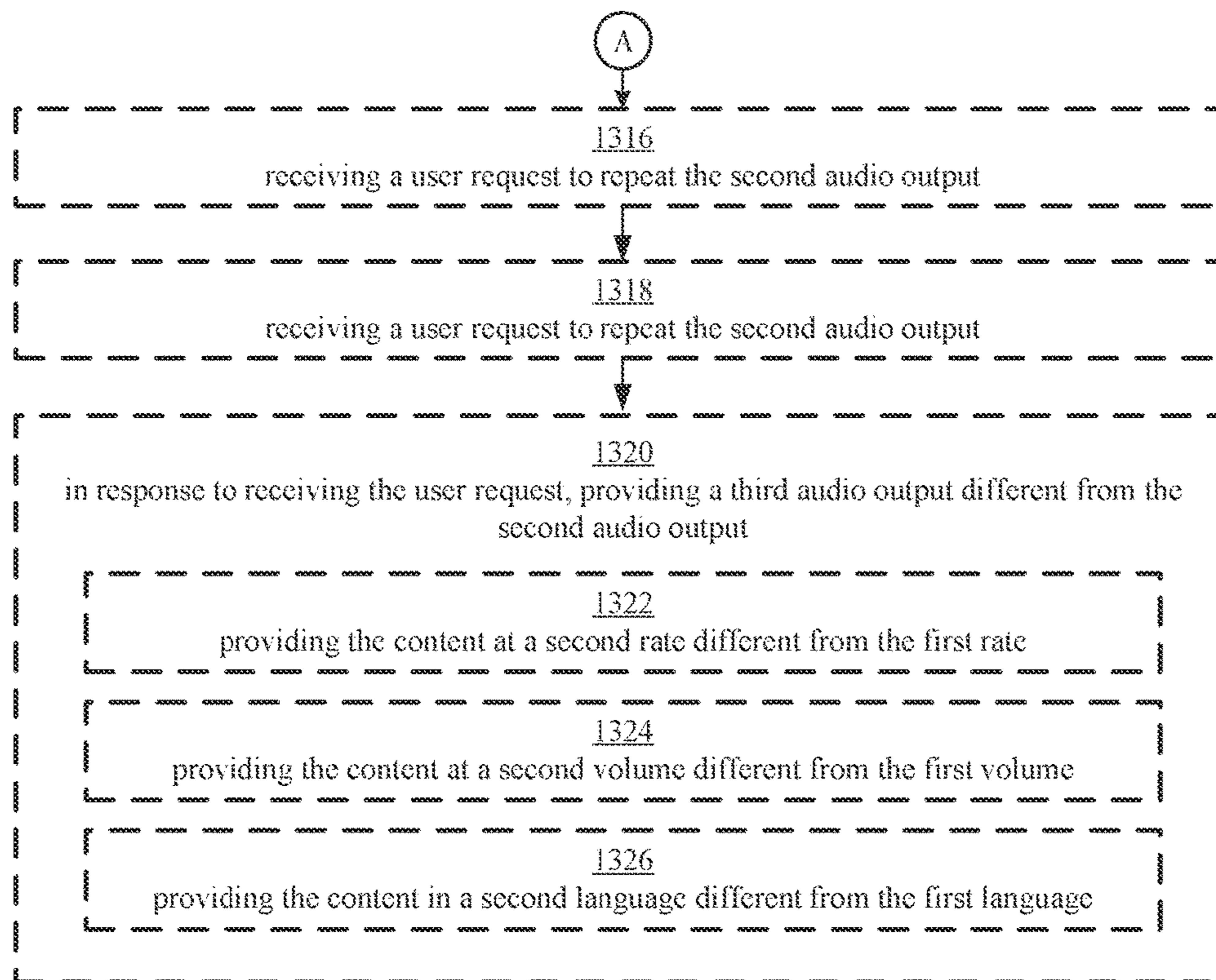

FIG. 13B

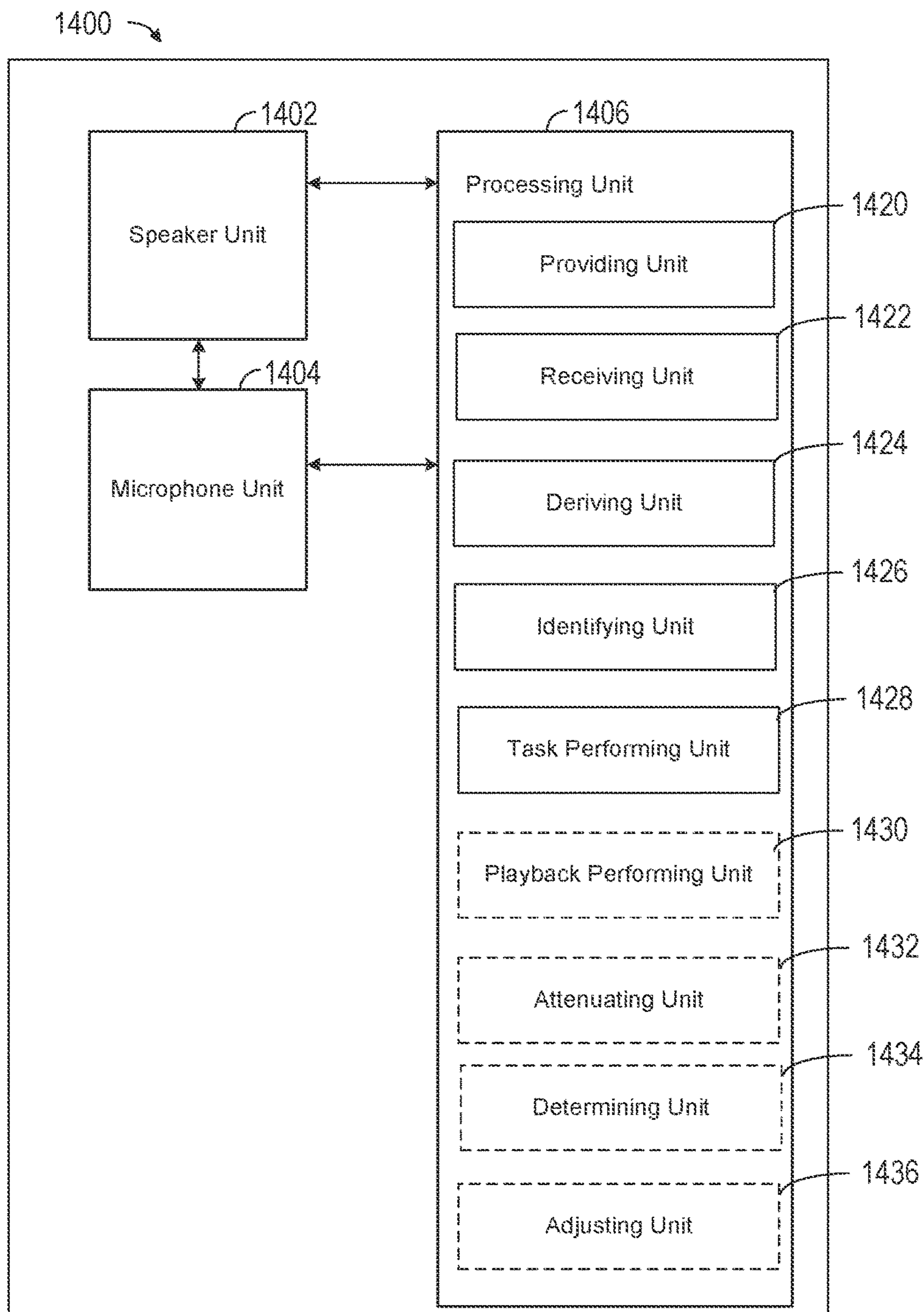

FIG. 14

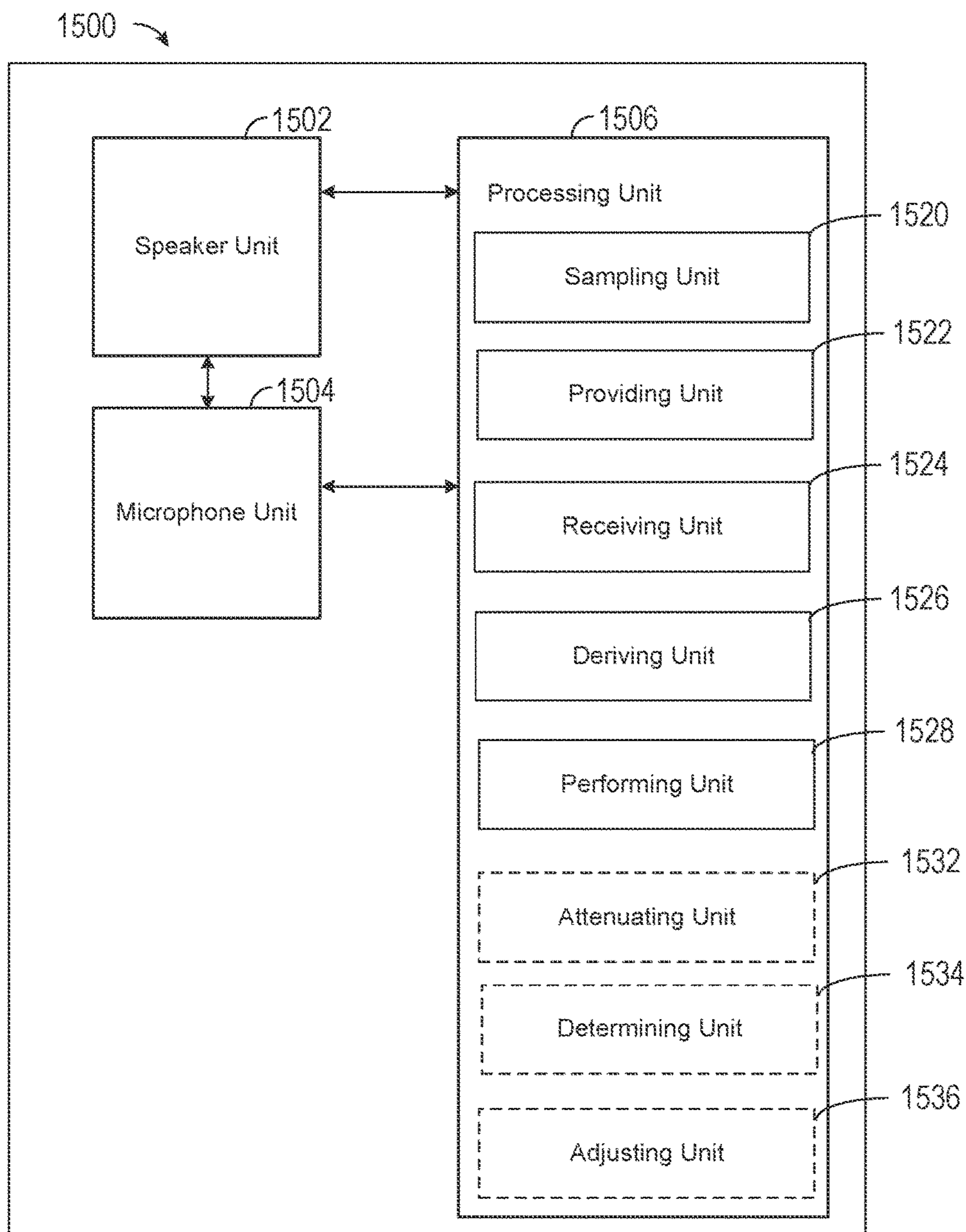

FIG. 15

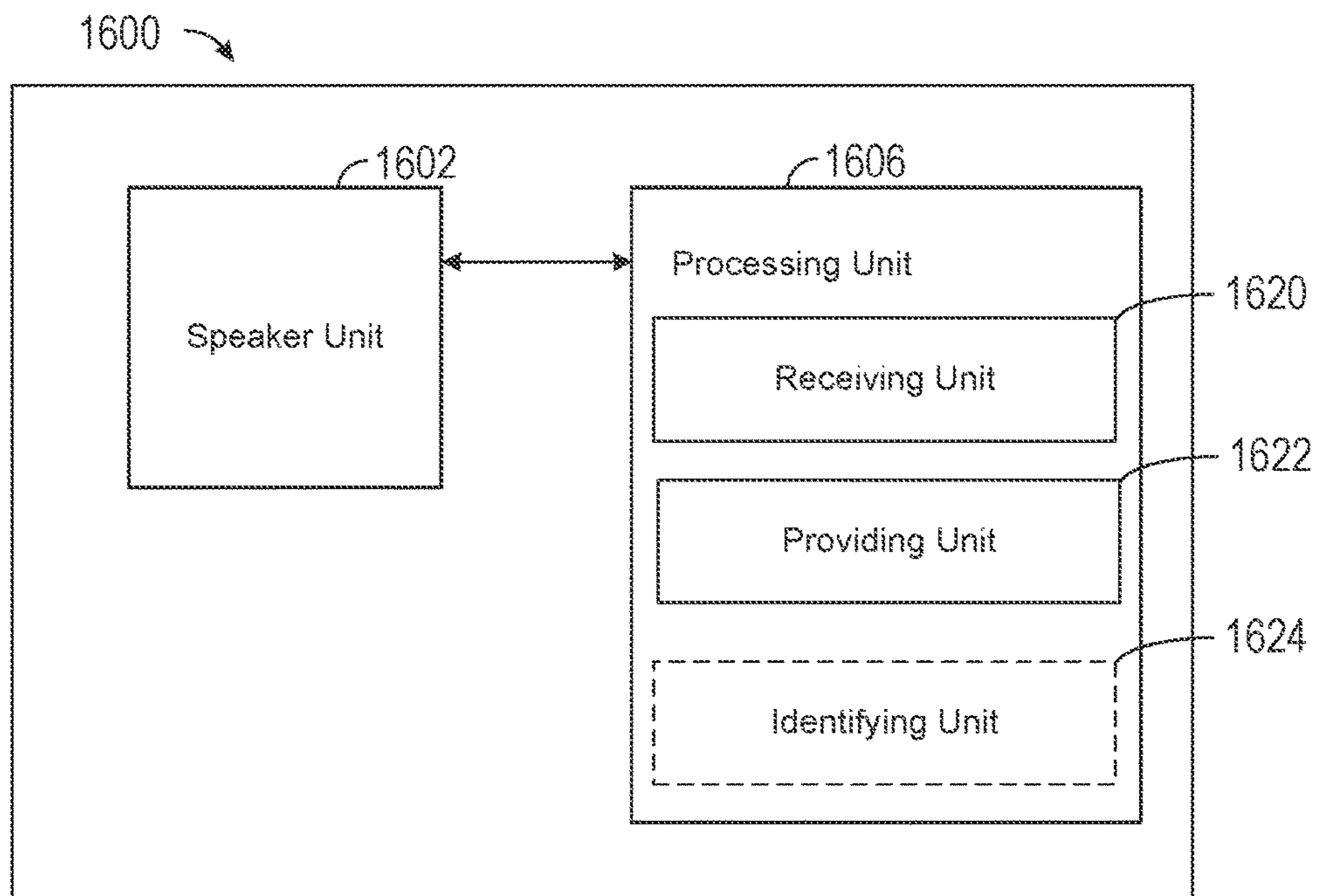

FIG. 16

INTELLIGENT AUTOMATED ASSISTANT**CROSS-REFERENCE TO RELATED APPLICATIONS**

This application claims priority to U.S. Provisional Patent Application Ser. No. 62/399,232, "INTELLIGENT AUTOMATED ASSISTANT," filed on Sep. 23, 2016. The content of this application is hereby incorporated by reference for all purposes.

FIELD

The present disclosure relates generally to intelligent systems, and more specifically, to providing voice-based interfaces for intelligent automated assistants.

BACKGROUND

An intelligent automated assistant can help users access content and perform tasks on an electronic device. In most cases, users rely, at least in part, on conventional, graphical user interfaces to interact with such devices. In some instances, however, an intelligent automated assistant may be implemented on an electronic device with limited or no display capabilities. Thus, the intelligent automated assistant may need to rely on auditory-based interfaces to interact with users.

BRIEF SUMMARY

Example methods are disclosed herein. An example method for operating an automated assistant includes: at an electronic device with a speaker and a microphone, providing, via the speaker of the electronic device, an audio output; while providing the audio output via the speaker of the electronic device, receiving, via the microphone of the electronic device, a natural language speech input; deriving a representation of user intent based on the natural language speech input and the audio output; identifying a task based on the derived user intent; and performing the identified task.

An example method for operating an automated assistant includes: at an electronic device with a microphone and a speaker, sampling, via the microphone of the electronic device, an audio input, wherein the audio input comprises a spoken trigger; in response to sampling the audio input, providing, via the speaker of the electronic device, an audio output indicative of a state of the automated assistant. While providing the audio output indicative of a state of the automated assistant, the electronic device receives a natural language speech input and derives a representation of user intent based on the natural language speech input. The electronic device performs a task based on the user intent.

An example method for operating an automated assistant includes: at an electronic device with a speaker, receiving a first natural language speech input indicative of content; providing, via the speaker, a first audio output, wherein the audio output comprises a plurality of formats for presenting the content; receiving a second natural language speech input indicative of a selection of a format of the plurality of formats; and providing, via the speaker, a second audio output comprising a presentation of the content in the selected format of the plurality of formats.

Example non-transitory computer readable storage media are disclosed herein. An example non-transitory computer readable storage medium stores one or more programs, the

one or more programs comprising instructions, which when executed by one or more processors of an electronic device, cause the device to: provide, via a speaker of the electronic device, an audio output; while providing the audio output via the speaker of the electronic device, receive, via a microphone of the electronic device, a natural language speech input; derive a representation of user intent based on the natural language speech input and the audio output; identify a task based on the derived user intent; and perform the identified task.

An example non-transitory computer readable storage medium stores one or more programs, the one or more programs comprising instructions, which when executed by one or more processors of an electronic device, cause the device to: sample, via a microphone of the electronic device, an audio input, wherein the audio input comprises a spoken trigger; in response to sampling the audio input, provide, via a speaker of the electronic device, an audio output indicative of a state of the automated assistant. The instructions further cause the device to: while providing the audio output indicative of a state of the automated assistant, receive a natural language speech input and derive a representation of user intent based on the natural language speech input. The instructions further cause the device to perform a task based on the user intent.

An example non-transitory computer readable storage medium stores one or more programs, the one or more programs comprising instructions, which when executed by one or more processors of an electronic device, cause the device to: receive a first natural language speech input indicative of content; provide, via a speaker of the electronic device, a first audio output, wherein the audio output comprises a plurality of formats for presenting the content; receive a second natural language speech input indicative of a selection of a format of the plurality of formats; and provide, via the speaker, a second audio output comprising a presentation of the content in the selected format of the plurality of formats.

Example devices are disclosed herein. An example electronic device for operating an automated assistant comprises: one or more processors; a memory; a speaker; a microphone; and one or more programs, wherein the one or more programs are stored in the memory and configured to be executed by the one or more processors, the one or more programs including instructions for: providing, via the speaker of the electronic device, an audio output; while providing the audio output via the speaker of the electronic device, receiving, via the microphone of the electronic device, a natural language speech input; deriving a representation of user intent based on the natural language speech input and the audio output; identifying a task based on the derived user intent; and performing the identified task.

An example electronic device for operating an automated assistant comprises: one or more processors; a memory; a microphone; a speaker; and one or more programs, wherein the one or more programs are stored in the memory and configured to be executed by the one or more processors, the one or more programs including instructions for: sampling, via the microphone of the electronic device, an audio input, wherein the audio input comprises a spoken trigger; in response to sampling the audio input, providing, via the speaker of the electronic device, an audio output indicative of a state of the automated assistant; while providing the audio output indicative of a state of the automated assistant: receiving a natural language speech input; and deriving a representation of user intent based on the natural language speech input; and performing a task based on the user intent.

An example electronic device comprises: one or more processors; a memory; a speaker; and one or more programs, wherein the one or more programs are stored in the memory and configured to be executed by the one or more processors, the one or more programs including instructions for: receiving a first natural language speech input indicative of content; providing, via the speaker, a first audio output, wherein the audio output comprises a plurality of formats for presenting the content; receiving a second natural language speech input indicative of a selection of a format of the plurality of formats; and providing, via the speaker, a second audio output comprising a presentation of the content in the selected format of the plurality of formats.

An example electronic device for operating an automated assistant comprises: a speaker; a microphone; and means for providing, via the speaker of the electronic device, an audio output; while providing the audio output via the speaker of the electronic device, means for receiving, via the microphone of the electronic device, a natural language speech input; means for deriving a representation of user intent based on the natural language speech input and the audio output; means for identifying a task based on the derived user intent; and means for performing the identified task.

An example electronic device for operating an automated assistant comprises: a microphone; a speaker; and means for sampling, via the microphone of the electronic device, an audio input, wherein the audio input comprises a spoken trigger; means for in response to sampling the audio input, providing, via the speaker of the electronic device, an audio output indicative of a state of the automated assistant; while providing the audio output indicative of a state of the automated assistant: means for receiving a natural language speech input; and means for deriving a representation of user intent based on the natural language speech input; and means for performing a task based on the user intent.

An example electronic device for operating an automated assistant comprises: a speaker; and means for receiving a first natural language speech input indicative of content; means for providing, via the speaker, a first audio output, wherein the audio output comprises a plurality of formats for presenting the content; means for receiving a second natural language speech input indicative of a selection of a format of the plurality of formats; and means for providing, via the speaker, a second audio output comprising a presentation of the content in the selected format of the plurality of formats.

DESCRIPTION OF THE FIGURES

For a better understanding of the various described embodiments, reference should be made to the Detailed Description below, in conjunction with the following drawings in which like reference numerals refer to corresponding parts throughout the figures.

FIG. 1 is a block diagram illustrating a system and environment for implementing a digital assistant according to various examples.

FIG. 2A is a block diagram illustrating a portable multifunction device implementing the client-side portion of a digital assistant in accordance with some embodiments.

FIG. 2B is a block diagram illustrating exemplary components for event handling according to various examples.

FIG. 3 illustrates a portable multifunction device implementing the client-side portion of a digital assistant according to various examples.

FIG. 4 is a block diagram of an exemplary multifunction device with a display and a touch-sensitive surface according to various examples.

FIG. 5A illustrates an exemplary user interface for a menu of applications on a portable multifunction device according to various examples.

FIG. 5B illustrates an exemplary user interface for a multifunction device with a touch-sensitive surface that is separate from the display according to various examples.

FIG. 6A illustrates a personal electronic device according to various examples.

FIG. 6B is a block diagram illustrating a personal electronic device according to various examples.

FIG. 7A is a block diagram illustrating a digital assistant system or a server portion thereof according to various examples.

FIG. 7B illustrates the functions of the digital assistant shown in FIG. 7A according to various examples.

FIG. 7C illustrates a portion of an ontology according to various examples.

FIGS. 8A-D illustrate an exemplary process for operating an intelligent automated assistant according to various examples.

FIGS. 9A-G illustrate an exemplary process for operating an intelligent automated assistant according to various examples.

FIGS. 10A-G illustrate an exemplary process for operating an intelligent automated assistant according to various examples.

FIGS. 11A-B illustrate a flowchart of an exemplary process for operating an intelligent automated assistant according to various examples.

FIGS. 12A-B illustrate a flowchart of an exemplary process for operating an intelligent automated assistant according to various examples.

FIGS. 13A-B illustrate a flowchart of an exemplary process for operating an intelligent automated assistant according to various examples.

FIG. 14 illustrates a functional block diagram of an electronic device according to various examples.

FIG. 15 illustrates a functional block diagram of an electronic device according to various examples.

FIG. 16 illustrates a functional block diagram of an electronic device according to various examples.

DETAILED DESCRIPTION

In the following description of the disclosure and embodiments, reference is made to the accompanying drawings in which it is shown by way of illustration of specific embodiments that can be practiced. It is to be understood that other embodiments and examples can be practiced and changes can be made without departing from the scope of the disclosure.

Techniques for providing voice-based interfaces of intelligent automated assistants are desirable. As described herein, described techniques improve the user's ability to interface with electronic devices, thereby enhancing productivity. Described techniques can reduce computational demand and battery power otherwise consumed as a result of redundant responses by electronic devices to user inputs.

Although the following description uses terms "first," "second," etc. to describe various elements, these elements should not be limited by the terms. These terms are only used to distinguish one element from another. For example, a first input could be termed a second input, and, similarly, a second input could be termed a first input, without departing from the scope of the various described examples. The first input and the second input can both be inputs and, in some cases, can be separate and different inputs.

The terminology used in the description of the various described examples herein is for the purpose of describing particular examples only and is not intended to be limiting. As used in the description of the various described examples and the appended claims, the singular forms “a,” “an,” and “the” are intended to include the plural forms as well, unless the context clearly indicates otherwise. It will also be understood that the term “and/or” as used herein refers to and encompasses any and all possible combinations of one or more of the associated listed items. It will be further understood that the terms “includes,” “including,” “comprises,” and/or “comprising,” when used in this specification, specify the presence of stated features, integers, steps, operations, elements, and/or components, but do not preclude the presence or addition of one or more other features, integers, steps, operations, elements, components, and/or groups thereof.

The term “if” may be construed to mean “when” or “upon” or “in response to determining” or “in response to detecting,” depending on the context. Similarly, the phrase “if it is determined” or “if [a stated condition or event] is detected” may be construed to mean “upon determining” or “in response to determining” or “upon detecting [the stated condition or event]” or “in response to detecting [the stated condition or event],” depending on the context.

1. System and Environment

FIG. 1 illustrates a block diagram of system 100 according to various examples. In some examples, system 100 can implement a digital assistant. The terms “digital assistant,” “virtual assistant,” “intelligent automated assistant,” or “automatic digital assistant” can refer to any information processing system that interprets natural language input in spoken and/or textual form to infer user intent, and performs actions based on the inferred user intent. For example, to act on an inferred user intent, the system can perform one or more of the following: identifying a task flow with steps and parameters designed to accomplish the inferred user intent, inputting specific requirements from the inferred user intent into the task flow; executing the task flow by invoking programs, methods, services, APIs, or the like; and generating output responses to the user in an audible (e.g., speech) and/or visual form.

Specifically, a digital assistant can be capable of accepting a user request at least partially in the form of a natural language command, request, statement, narrative, and/or inquiry. Typically, the user request can seek either an informational answer or performance of a task by the digital assistant. A satisfactory response to the user request can be a provision of the requested informational answer, a performance of the requested task, or a combination of the two. For example, a user can ask the digital assistant a question, such as “Where am I right now?” Based on the user’s current location, the digital assistant can answer, “You are in Central Park near the west gate.” The user can also request the performance of a task, for example, “Please invite my friends to my girlfriend’s birthday party next week.” In response, the digital assistant can acknowledge the request by saying “Yes, right away,” and then send a suitable calendar invite on behalf of the user to each of the user’s friends listed in the user’s electronic address book. During performance of a requested task, the digital assistant can sometimes interact with the user in a continuous dialogue involving multiple exchanges of information over an extended period of time. There are numerous other ways of interacting with a digital assistant to request information or performance of various tasks. In addition to providing verbal responses and taking programmed actions, the digital assis-

tant can also provide responses in other visual or audio forms, e.g., as text, alerts, music, videos, animations, etc.

As shown in FIG. 1, in some examples, a digital assistant can be implemented according to a client-server model. The digital assistant can include client-side portion 102 (hereafter “DA client 102”) executed on user device 104 and server-side portion 106 (hereafter “DA server 106”) executed on server system 108. DA client 102 can communicate with DA server 106 through one or more networks 110. DA client 102 can provide client-side functionalities such as user-facing input and output processing and communication with DA server 106. DA server 106 can provide server-side functionalities for any number of DA clients 102 each residing on a respective user device 104.

In some examples, DA server 106 can include client-facing I/O interface 112, one or more processing modules 114, data and models 116, and I/O interface to external services 118. The client-facing I/O interface 112 can facilitate the client-facing input and output processing for DA server 106. One or more processing modules 114 can utilize data and models 116 to process speech input and determine the user’s intent based on natural language input. Further, one or more processing modules 114 perform task execution based on inferred user intent. In some examples, DA server 106 can communicate with external services 120 through network(s) 110 for task completion or information acquisition. I/O interface to external services 118 can facilitate such communications.

User device 104 can be any suitable electronic device. For example, user devices can be a portable multifunctional device (e.g., device 200, described below with reference to FIG. 2A), a multifunctional device (e.g., device 400, described below with reference to FIG. 4), or a personal electronic device (e.g., device 600, described below with reference to FIG. 6A-B.) A portable multifunctional device can be, for example, a mobile telephone that also contains other functions, such as PDA and/or music player functions. Specific examples of portable multifunction devices can include the iPhone®, iPod Touch®, and iPad® devices from Apple Inc. of Cupertino, Calif. Other examples of portable multifunction devices can include, without limitation, laptop or tablet computers. Further, in some examples, user device 104 can be a non-portable multifunctional device. In particular, user device 104 can be a desktop computer, a game console, a television, or a television set-top box. In some examples, user device 104 can include a touch-sensitive surface (e.g., touch screen displays and/or touchpads). Further, user device 104 can optionally include one or more other physical user-interface devices, such as a physical keyboard, a mouse, and/or a joystick. Various examples of electronic devices, such as multifunctional devices, are described below in greater detail.

Examples of communication network(s) 110 can include local area networks (LAN) and wide area networks (WAN), e.g., the Internet. Communication network(s) 110 can be implemented using any known network protocol, including various wired or wireless protocols, such as, for example, Ethernet, Universal Serial Bus (USB), FIREWIRE, Global System for Mobile Communications (GSM), Enhanced Data GSM Environment (EDGE), code division multiple access (CDMA), time division multiple access (TDMA), Bluetooth, Wi-Fi, voice over Internet Protocol (VoIP), Wi-MAX, or any other suitable communication protocol.

Server system 108 can be implemented on one or more standalone data processing apparatus or a distributed network of computers. In some examples, server system 108 can also employ various virtual devices and/or services of

third-party service providers (e.g., third-party cloud service providers) to provide the underlying computing resources and/or infrastructure resources of server system 108.

In some examples, user device 104 can communicate with DA server 106 via second user device 122. Second user device 122 can be similar or identical to user device 104. For example, second user device 122 can be similar to devices 200, 400, or 600 described below with reference to FIGS. 2A, 4, and 6A-B. User device 104 can be configured to communicatively couple to second user device 122 via a direct communication connection, such as Bluetooth, NFC, BTLE, or the like, or via a wired or wireless network, such as a local Wi-Fi network. In some examples, second user device 122 can be configured to act as a proxy between user device 104 and DA server 106. For example, DA client 102 of user device 104 can be configured to transmit information (e.g., a user request received at user device 104) to DA server 106 via second user device 122. DA server 106 can process the information and return relevant data (e.g., data content responsive to the user request) to user device 104 via second user device 122.

In some examples, user device 104 can be configured to communicate abbreviated requests for data to second user device 122 to reduce the amount of information transmitted from user device 104. Second user device 122 can be configured to determine supplemental information to add to the abbreviated request to generate a complete request to transmit to DA server 106. This system architecture can advantageously allow user device 104 having limited communication capabilities and/or limited battery power (e.g., a watch or a similar compact electronic device) to access services provided by DA server 106 by using second user device 122, having greater communication capabilities and/or battery power (e.g., a mobile phone, laptop computer, tablet computer, or the like), as a proxy to DA server 106. While only two user devices 104 and 122 are shown in FIG. 1, it will be appreciated that system 100 can include any number and type of user devices configured in this proxy configuration to communicate with DA server system 106.

Although the digital assistant shown in FIG. 1 can include both a client-side portion (e.g., DA client 102) and a server-side portion (e.g., DA server 106), in some examples, the functions of a digital assistant can be implemented as a standalone application installed on a user device. In addition, the divisions of functionalities between the client and server portions of the digital assistant can vary in different implementations. For instance, in some examples, the DA client can be a thin-client that provides only user-facing input and output processing functions, and delegates all other functionalities of the digital assistant to a backend server.

2. Electronic Devices

Attention is now directed toward embodiments of electronic devices for implementing the client-side portion of a digital assistant. FIG. 2A is a block diagram illustrating portable multifunction device 200 with touch-sensitive display system 212 in accordance with some embodiments. Touch-sensitive display 212 is sometimes called a “touch screen” for convenience and is sometimes known as or called a “touch-sensitive display system.” Device 200 includes memory 202 (which optionally includes one or more computer-readable storage mediums), memory controller 222, one or more processing units (CPUs) 220, peripherals interface 218, RF circuitry 208, audio circuitry 210, speaker 211, microphone 213, input/output (I/O) subsystem 206, other input control devices 216, and external port 224. Device 200 optionally includes one or more optical

sensors 264. Device 200 optionally includes one or more contact intensity sensors 265 for detecting intensity of contacts on device 200 (e.g., a touch-sensitive surface such as touch-sensitive display system 212 of device 200). Device 200 optionally includes one or more tactile output generators 267 for generating tactile outputs on device 200 (e.g., generating tactile outputs on a touch-sensitive surface such as touch-sensitive display system 212 of device 200 or touchpad 455 of device 400). These components optionally communicate over one or more communication buses or signal lines 203.

As used in the specification and claims, the term “intensity” of a contact on a touch-sensitive surface refers to the force or pressure (force per unit area) of a contact (e.g., a finger contact) on the touch-sensitive surface, or to a substitute (proxy) for the force or pressure of a contact on the touch-sensitive surface. The intensity of a contact has a range of values that includes at least four distinct values and more typically includes hundreds of distinct values (e.g., at least 256). Intensity of a contact is, optionally, determined (or measured) using various approaches and various sensors or combinations of sensors. For example, one or more force sensors underneath or adjacent to the touch-sensitive surface are, optionally, used to measure force at various points on the touch-sensitive surface. In some implementations, force measurements from multiple force sensors are combined (e.g., a weighted average) to determine an estimated force of a contact. Similarly, a pressure-sensitive tip of a stylus is, optionally, used to determine a pressure of the stylus on the touch-sensitive surface. Alternatively, the size of the contact area detected on the touch-sensitive surface and/or changes thereto, the capacitance of the touch-sensitive surface proximate to the contact and/or changes thereto, and/or the resistance of the touch-sensitive surface proximate to the contact and/or changes thereto are, optionally, used as a substitute for the force or pressure of the contact on the touch-sensitive surface. In some implementations, the substitute measurements for contact force or pressure are used directly to determine whether an intensity threshold has been exceeded (e.g., the intensity threshold is described in units corresponding to the substitute measurements). In some implementations, the substitute measurements for contact force or pressure are converted to an estimated force or pressure, and the estimated force or pressure is used to determine whether an intensity threshold has been exceeded (e.g., the intensity threshold is a pressure threshold measured in units of pressure). Using the intensity of a contact as an attribute of a user input allows for user access to additional device functionality that may otherwise not be accessible by the user on a reduced-size device with limited real estate for displaying affordances (e.g., on a touch-sensitive display) and/or receiving user input (e.g., via a touch-sensitive display, a touch-sensitive surface, or a physical/mechanical control such as a knob or a button).

As used in the specification and claims, the term “tactile output” refers to physical displacement of a device relative to a previous position of the device, physical displacement of a component (e.g., a touch-sensitive surface) of a device relative to another component (e.g., housing) of the device, or displacement of the component relative to a center of mass of the device that will be detected by a user with the user’s sense of touch. For example, in situations where the device or the component of the device is in contact with a surface of a user that is sensitive to touch (e.g., a finger, palm, or other part of a user’s hand), the tactile output generated by the physical displacement will be interpreted by the user as a tactile sensation corresponding to a per-

ceived change in physical characteristics of the device or the component of the device. For example, movement of a touch-sensitive surface (e.g., a touch-sensitive display or trackpad) is, optionally, interpreted by the user as a “down click” or “up click” of a physical actuator button. In some cases, a user will feel a tactile sensation such as an “down click” or “up click” even when there is no movement of a physical actuator button associated with the touch-sensitive surface that is physically pressed (e.g., displaced) by the user’s movements. As another example, movement of the touch-sensitive surface is, optionally, interpreted or sensed by the user as “roughness” of the touch-sensitive surface, even when there is no change in smoothness of the touch-sensitive surface. While such interpretations of touch by a user will be subject to the individualized sensory perceptions of the user, there are many sensory perceptions of touch that are common to a large majority of users. Thus, when a tactile output is described as corresponding to a particular sensory perception of a user (e.g., an “up click,” a “down click,” “roughness”), unless otherwise stated, the generated tactile output corresponds to physical displacement of the device or a component thereof that will generate the described sensory perception for a typical (or average) user.

It will be appreciated that device **200** is only one example of a portable multifunction device, and that device **200** optionally has more or fewer components than shown, optionally combines two or more components, or optionally has a different configuration or arrangement of the components. The various components shown in FIG. **2A** are implemented in hardware, software, or a combination of both hardware and software, including one or more signal processing and/or application-specific integrated circuits.

Memory **202** may include one or more computer-readable storage mediums. The computer-readable storage mediums may be tangible and non-transitory. Memory **202** may include high-speed random access memory and may also include non-volatile memory, such as one or more magnetic disk storage devices, flash memory devices, or other non-volatile solid-state memory devices. Memory controller **222** may control access to memory **202** by other components of device **200**.

In some examples, a non-transitory computer-readable storage medium of memory **202** can be used to store instructions (e.g., for performing aspects of processes **1100-1300**, described below) for use by or in connection with an instruction execution system, apparatus, or device, such as a computer-based system, processor-containing system, or other system that can fetch the instructions from the instruction execution system, apparatus, or device and execute the instructions. In other examples, the instructions (e.g., for performing aspects of processes **1100-1300**, described below) can be stored on a non-transitory computer-readable storage medium (not shown) of the server system **108** or can be divided between the non-transitory computer-readable storage medium of memory **202** and the non-transitory computer-readable storage medium of server system **108**. In the context of this document, a “non-transitory computer-readable storage medium” can be any medium that can contain or store the program for use by or in connection with the instruction execution system, apparatus, or device.

Peripherals interface **218** can be used to couple input and output peripherals of the device to CPU **220** and memory **202**. The one or more processors **220** run or execute various software programs and/or sets of instructions stored in memory **202** to perform various functions for device **200** and to process data. In some embodiments, peripherals interface **218**, CPU **220**, and memory controller **222** may be

implemented on a single chip, such as chip **204**. In some other embodiments, they may be implemented on separate chips.

RF (radio frequency) circuitry **208** receives and sends RF signals, also called electromagnetic signals. RF circuitry **208** converts electrical signals to/from electromagnetic signals and communicates with communications networks and other communications devices via the electromagnetic signals. RF circuitry **208** optionally includes well-known circuitry for performing these functions, including but not limited to an antenna system, an RF transceiver, one or more amplifiers, a tuner, one or more oscillators, a digital signal processor, a CODEC chipset, a subscriber identity module (SIM) card, memory, and so forth. RF circuitry **208** optionally communicates with networks, such as the Internet, also referred to as the World Wide Web (WWW), an intranet and/or a wireless network, such as a cellular telephone network, a wireless local area network (LAN) and/or a metropolitan area network (MAN), and other devices by wireless communication. The RF circuitry **208** optionally includes well-known circuitry for detecting near field communication (NFC) fields, such as by a short-range communication radio. The wireless communication optionally uses any of a plurality of communications standards, protocols, and technologies, including but not limited to Global System for Mobile Communications (GSM), Enhanced Data GSM Environment (EDGE), high-speed downlink packet access (HSDPA), high-speed uplink packet access (HSUPA), Evolution, Data-Only (EV-DO), HSPA, HSPA+, Dual-Cell HSPA (DC-HSPDA), long term evolution (LTE), near field communication (NFC), wideband code division multiple access (W-CDMA), code division multiple access (CDMA), time division multiple access (TDMA), Bluetooth, Bluetooth Low Energy (BTLE), Wireless Fidelity (Wi-Fi) (e.g., IEEE 802.11a, IEEE 802.11b, IEEE 802.11g, IEEE 802.11n, and/or IEEE 802.11ac), voice over Internet Protocol (VoIP), Wi-MAX, a protocol for e mail (e.g., Internet message access protocol (IMAP) and/or post office protocol (POP)), instant messaging (e.g., extensible messaging and presence protocol (XMPP), Session Initiation Protocol for Instant Messaging and Presence Leveraging Extensions (SIMPLE), Instant Messaging and Presence Service (IMPS)), and/or Short Message Service (SMS), or any other suitable communication protocol, including communication protocols not yet developed as of the filing date of this document.

Audio circuitry **210**, speaker **211**, and microphone **213** provide an audio interface between a user and device **200**. Audio circuitry **210** receives audio data from peripherals interface **218**, converts the audio data to an electrical signal, and transmits the electrical signal to speaker **211**. Speaker **211** converts the electrical signal to human-audible sound waves. Audio circuitry **210** also receives electrical signals converted by microphone **213** from sound waves. Audio circuitry **210** converts the electrical signal to audio data and transmits the audio data to peripherals interface **218** for processing. Audio data may be retrieved from and/or transmitted to memory **202** and/or RF circuitry **208** by peripherals interface **218**. In some embodiments, audio circuitry **210** also includes a headset jack (e.g., **312**, FIG. **3**). The headset jack provides an interface between audio circuitry **210** and removable audio input/output peripherals, such as output-only headphones or a headset with both output (e.g., a headphone for one or both ears) and input (e.g., a microphone).

I/O subsystem **206** couples input/output peripherals on device **200**, such as touch screen **212** and other input control devices **216**, to peripherals interface **218**. I/O subsystem **206**

optionally includes display controller **256**, optical sensor controller **258**, intensity sensor controller **259**, haptic feedback controller **261**, and one or more input controllers **260** for other input or control devices. The one or more input controllers **260** receive/send electrical signals from/to other input control devices **216**. The other input control devices **216** optionally include physical buttons (e.g., push buttons, rocker buttons, etc.), dials, slider switches, joysticks, click wheels, and so forth. In some alternate embodiments, input controller(s) **260** are, optionally, coupled to any (or none) of the following: a keyboard, an infrared port, a USB port, and a pointer device such as a mouse. The one or more buttons (e.g., **308**, FIG. 3) optionally include an up/down button for volume control of speaker **211** and/or microphone **213**. The one or more buttons optionally include a push button (e.g., **306**, FIG. 3).

A quick press of the push button may disengage a lock of touch screen **212** or begin a process that uses gestures on the touch screen to unlock the device, as described in U.S. patent application Ser. No. 11/322,549, "Unlocking a Device by Performing Gestures on an Unlock Image," filed Dec. 23, 2005, U.S. Pat. No. 7,657,849, which is hereby incorporated by reference in its entirety. A longer press of the push button (e.g., **306**) may turn power to device **200** on or off. The user may be able to customize a functionality of one or more of the buttons. Touch screen **212** is used to implement virtual or soft buttons and one or more soft keyboards.

Touch-sensitive display **212** provides an input interface and an output interface between the device and a user. Display controller **256** receives and/or sends electrical signals from/to touch screen **212**. Touch screen **212** displays visual output to the user. The visual output may include graphics, text, icons, video, and any combination thereof (collectively termed "graphics"). In some embodiments, some or all of the visual output may correspond to user-interface objects.

Touch screen **212** has a touch-sensitive surface, sensor, or set of sensors that accepts input from the user based on haptic and/or tactile contact. Touch screen **212** and display controller **256** (along with any associated modules and/or sets of instructions in memory **202**) detect contact (and any movement or breaking of the contact) on touch screen **212** and convert the detected contact into interaction with user-interface objects (e.g., one or more soft keys, icons, web pages, or images) that are displayed on touch screen **212**. In an exemplary embodiment, a point of contact between touch screen **212** and the user corresponds to a finger of the user.

Touch screen **212** may use LCD (liquid crystal display) technology, LPD (light emitting polymer display) technology, or LED (light emitting diode) technology, although other display technologies may be used in other embodiments. Touch screen **212** and display controller **256** may detect contact and any movement or breaking thereof using any of a plurality of touch sensing technologies now known or later developed, including but not limited to capacitive, resistive, infrared, and surface acoustic wave technologies, as well as other proximity sensor arrays or other elements for determining one or more points of contact with touch screen **212**. In an exemplary embodiment, projected mutual capacitance sensing technology is used, such as that found in the iPhone® and iPod Touch® from Apple Inc. of Cupertino, Calif.

A touch-sensitive display in some embodiments of touch screen **212** may be analogous to the multi-touch sensitive touchpads described in the following U.S. Pat. No. 6,323,846 (Westerman et al.), U.S. Pat. No. 6,570,557 (Westerman et al.), and/or U.S. Pat. No. 6,677,932 (Westerman), and/or

U.S. Patent Publication 2002/0015024A1, each of which is hereby incorporated by reference in its entirety. However, touch screen **212** displays visual output from device **200**, whereas touch-sensitive touchpads do not provide visual output.

A touch-sensitive display in some embodiments of touch screen **212** may be as described in the following applications: (1) U.S. patent application Ser. No. 11/381,313, "Multipoint Touch Surface Controller," filed May 2, 2006; (2) U.S. patent application Ser. No. 10/840,862, "Multipoint Touchscreen," filed May 6, 2004; (3) U.S. patent application Ser. No. 10/903,964, "Gestures For Touch Sensitive Input Devices," filed Jul. 30, 2004; (4) U.S. patent application Ser. No. 11/048,264, "Gestures For Touch Sensitive Input Devices," filed Jan. 31, 2005; (5) U.S. patent application Ser. No. 11/038,590, "Mode-Based Graphical User Interfaces For Touch Sensitive Input Devices," filed Jan. 18, 2005; (6) U.S. patent application Ser. No. 11/228,758, "Virtual Input Device Placement On A Touch Screen User Interface," filed Sep. 16, 2005; (7) U.S. patent application Ser. No. 11/228,700, "Operation Of A Computer With A Touch Screen Interface," filed Sep. 16, 2005; (8) U.S. patent application Ser. No. 11/228,737, "Activating Virtual Keys Of A Touch-Screen Virtual Keyboard," filed Sep. 16, 2005; and (9) U.S. patent application Ser. No. 11/367,749, "Multi-Functional Hand-Held Device," filed Mar. 3, 2006. All of these applications are incorporated by reference herein in their entirety.

Touch screen **212** may have a video resolution in excess of 100 dpi. In some embodiments, the touch screen has a video resolution of approximately 160 dpi. The user may make contact with touch screen **212** using any suitable object or appendage, such as a stylus, a finger, and so forth. In some embodiments, the user interface is designed to work primarily with finger-based contacts and gestures, which can be less precise than stylus-based input due to the larger area of contact of a finger on the touch screen. In some embodiments, the device translates the rough finger-based input into a precise pointer/cursor position or command for performing the actions desired by the user.

In some embodiments, in addition to the touch screen, device **200** may include a touchpad (not shown) for activating or deactivating particular functions. In some embodiments, the touchpad is a touch-sensitive area of the device that, unlike the touch screen, does not display visual output. The touchpad may be a touch-sensitive surface that is separate from touch screen **212** or an extension of the touch-sensitive surface formed by the touch screen.

Device **200** also includes power system **262** for powering the various components. Power system **262** may include a power management system, one or more power sources (e.g., battery, alternating current (AC)), a recharging system, a power failure detection circuit, a power converter or inverter, a power status indicator (e.g., a light-emitting diode (LED)) and any other components associated with the generation, management and distribution of power in portable devices.

Device **200** may also include one or more optical sensors **264**. FIG. 2A shows an optical sensor coupled to optical sensor controller **258** in I/O subsystem **206**. Optical sensor **264** may include charge-coupled device (CCD) or complementary metal-oxide semiconductor (CMOS) phototransistors. Optical sensor **264** receives light from the environment, projected through one or more lenses, and converts the light to data representing an image. In conjunction with imaging module **243** (also called a camera module), optical sensor **264** may capture still images or video. In some embodiments, an optical sensor is located on the back of device **200**,

opposite touch screen display **212** on the front of the device so that the touch screen display may be used as a viewfinder for still and/or video image acquisition. In some embodiments, an optical sensor is located on the front of the device so that the user's image may be obtained for video conferencing while the user views the other video conference participants on the touch screen display. In some embodiments, the position of optical sensor **264** can be changed by the user (e.g., by rotating the lens and the sensor in the device housing) so that a single optical sensor **264** may be used along with the touch screen display for both video conferencing and still and/or video image acquisition.

Device **200** optionally also includes one or more contact intensity sensors **265**. FIG. 2A shows a contact intensity sensor coupled to intensity sensor controller **259** in I/O subsystem **206**. Contact intensity sensor **265** optionally includes one or more piezoresistive strain gauges, capacitive force sensors, electric force sensors, piezoelectric force sensors, optical force sensors, capacitive touch-sensitive surfaces, or other intensity sensors (e.g., sensors used to measure the force (or pressure) of a contact on a touch-sensitive surface). Contact intensity sensor **265** receives contact intensity information (e.g., pressure information or a proxy for pressure information) from the environment. In some embodiments, at least one contact intensity sensor is collocated with, or proximate to, a touch-sensitive surface (e.g., touch-sensitive display system **212**). In some embodiments, at least one contact intensity sensor is located on the back of device **200**, opposite touch screen display **212**, which is located on the front of device **200**.

Device **200** may also include one or more proximity sensors **266**. FIG. 2A shows proximity sensor **266** coupled to peripherals interface **218**. Alternately, proximity sensor **266** may be coupled to input controller **260** in I/O subsystem **206**. Proximity sensor **266** may perform as described in U.S. patent application Ser. No. 11/241,839, "Proximity Detector In Handheld Device"; Ser. No. 11/240,788, "Proximity Detector In Handheld Device"; Ser. No. 11/620,702, "Using Ambient Light Sensor To Augment Proximity Sensor Output"; Ser. No. 11/586,862, "Automated Response To And Sensing Of User Activity In Portable Devices"; and Ser. No. 11/638,251, "Methods And Systems For Automatic Configuration Of Peripherals," which are hereby incorporated by reference in their entirety. In some embodiments, the proximity sensor turns off and disables touch screen **212** when the multifunction device is placed near the user's ear (e.g., when the user is making a phone call).

Device **200** optionally also includes one or more tactile output generators **267**. FIG. 2A shows a tactile output generator coupled to haptic feedback controller **261** in I/O subsystem **206**. Tactile output generator **267** optionally includes one or more electroacoustic devices such as speakers or other audio components and/or electromechanical devices that convert energy into linear motion such as a motor, solenoid, electroactive polymer, piezoelectric actuator, electrostatic actuator, or other tactile output generating component (e.g., a component that converts electrical signals into tactile outputs on the device). Contact intensity sensor **265** receives tactile feedback generation instructions from haptic feedback module **233** and generates tactile outputs on device **200** that are capable of being sensed by a user of device **200**. In some embodiments, at least one tactile output generator is collocated with, or proximate to, a touch-sensitive surface (e.g., touch-sensitive display system **212**) and, optionally, generates a tactile output by moving the touch-sensitive surface vertically (e.g., in/out of a surface of device **200**) or laterally (e.g., back and forth in the

same plane as a surface of device **200**). In some embodiments, at least one tactile output generator sensor is located on the back of device **200**, opposite touch screen display **212**, which is located on the front of device **200**.

Device **200** may also include one or more accelerometers **268**. FIG. 2A shows accelerometer **268** coupled to peripherals interface **218**. Alternately, accelerometer **268** may be coupled to an input controller **260** in I/O subsystem **206**. Accelerometer **268** may perform as described in U.S. Patent Publication No. 20050190059, "Acceleration-based Theft Detection System for Portable Electronic Devices," and U.S. Patent Publication No. 20060017692, "Methods And Apparatuses For Operating A Portable Device Based On An Accelerometer," both of which are incorporated by reference herein in their entirety. In some embodiments, information is displayed on the touch screen display in a portrait view or a landscape view based on an analysis of data received from the one or more accelerometers. Device **200** optionally includes, in addition to accelerometer(s) **268**, a magnetometer (not shown) and a GPS (or GLONASS or other global navigation system) receiver (not shown) for obtaining information concerning the location and orientation (e.g., portrait or landscape) of device **200**.

In some embodiments, the software components stored in memory **202** include operating system **226**, communication module (or set of instructions) **228**, contact/motion module (or set of instructions) **230**, graphics module (or set of instructions) **232**, text input module (or set of instructions) **234**, Global Positioning System (GPS) module (or set of instructions) **235**, Digital Assistant Client Module **229**, and applications (or sets of instructions) **236**. Further, memory **202** can store data and models, such as user data and models **231**. Furthermore, in some embodiments, memory **202** (FIG. 2A) or **470** (FIG. 4) stores device/global internal state **257**, as shown in FIGS. 2A and 4. Device/global internal state **257** includes one or more of: active application state, indicating which applications, if any, are currently active; display state, indicating what applications, views or other information occupy various regions of touch screen display **212**; sensor state, including information obtained from the device's various sensors and input control devices **216**; and location information concerning the device's location and/or attitude.

Operating system **226** (e.g., Darwin, RTXC, LINUX, UNIX, OS X, iOS, WINDOWS, or an embedded operating system such as VxWorks) includes various software components and/or drivers for controlling and managing general system tasks (e.g., memory management, storage device control, power management, etc.) and facilitates communication between various hardware and software components.

Communication module **228** facilitates communication with other devices over one or more external ports **224** and also includes various software components for handling data received by RF circuitry **208** and/or external port **224**. External port **224** (e.g., Universal Serial Bus (USB), FIREWIRE, etc.) is adapted for coupling directly to other devices or indirectly over a network (e.g., the Internet, wireless LAN, etc.). In some embodiments, the external port is a multi-pin (e.g., 30-pin) connector that is the same as, or similar to and/or compatible with, the 30-pin connector used on iPod® (trademark of Apple Inc.) devices.

Contact/motion module **230** optionally detects contact with touch screen **212** (in conjunction with display controller **256**) and other touch-sensitive devices (e.g., a touchpad or physical click wheel). Contact/motion module **230** includes various software components for performing various operations related to detection of contact, such as determining if contact has occurred (e.g., detecting a finger-

down event), determining an intensity of the contact (e.g., the force or pressure of the contact or a substitute for the force or pressure of the contact), determining if there is movement of the contact and tracking the movement across the touch-sensitive surface (e.g., detecting one or more finger-dragging events), and determining if the contact has ceased (e.g., detecting a finger-up event or a break in contact). Contact/motion module **230** receives contact data from the touch-sensitive surface. Determining movement of the point of contact, which is represented by a series of contact data, optionally includes determining speed (magnitude), velocity (magnitude and direction), and/or an acceleration (a change in magnitude and/or direction) of the point of contact. These operations are, optionally, applied to single contacts (e.g., one finger contacts) or to multiple simultaneous contacts (e.g., “multitouch”/multiple finger contacts). In some embodiments, contact/motion module **230** and display controller **256** detect contact on a touchpad.

In some embodiments, contact/motion module **230** uses a set of one or more intensity thresholds to determine whether an operation has been performed by a user (e.g., to determine whether a user has “clicked” on an icon). In some embodiments, at least a subset of the intensity thresholds are determined in accordance with software parameters (e.g., the intensity thresholds are not determined by the activation thresholds of particular physical actuators and can be adjusted without changing the physical hardware of device **200**). For example, a mouse “click” threshold of a trackpad or touch screen display can be set to any of a large range of predefined threshold values without changing the trackpad or touch screen display hardware. Additionally, in some implementations, a user of the device is provided with software settings for adjusting one or more of the set of intensity thresholds (e.g., by adjusting individual intensity thresholds and/or by adjusting a plurality of intensity thresholds at once with a system-level click “intensity” parameter).

Contact/motion module **230** optionally detects a gesture input by a user. Different gestures on the touch-sensitive surface have different contact patterns (e.g., different motions, timings, and/or intensities of detected contacts). Thus, a gesture is, optionally, detected by detecting a particular contact pattern. For example, detecting a finger tap gesture includes detecting a finger-down event followed by detecting a finger-up (liftoff) event at the same position (or substantially the same position) as the finger-down event (e.g., at the position of an icon). As another example, detecting a finger swipe gesture on the touch-sensitive surface includes detecting a finger-down event followed by detecting one or more finger-dragging events, and subsequently followed by detecting a finger-up (liftoff) event.

Graphics module **232** includes various known software components for rendering and displaying graphics on touch screen **212** or other display, including components for changing the visual impact (e.g., brightness, transparency, saturation, contrast, or other visual property) of graphics that are displayed. As used herein, the term “graphics” includes any object that can be displayed to a user, including, without limitation, text, web pages, icons (such as user-interface objects including soft keys), digital images, videos, animations, and the like.

In some embodiments, graphics module **232** stores data representing graphics to be used. Each graphic is, optionally, assigned a corresponding code. Graphics module **232** receives, from applications etc., one or more codes specifying graphics to be displayed along with, if necessary,

coordinate data and other graphic property data, and then generates screen image data to output to display controller **256**.

Haptic feedback module **233** includes various software components for generating instructions used by tactile output generator(s) **267** to produce tactile outputs at one or more locations on device **200** in response to user interactions with device **200**.

Text input module **234**, which may be a component of graphics module **232**, provides soft keyboards for entering text in various applications (e.g., contacts **237**, e mail **240**, IM **241**, browser **247**, and any other application that needs text input).

GPS module **235** determines the location of the device and provides this information for use in various applications (e.g., to telephone **238** for use in location-based dialing; to camera **243** as picture/video metadata; and to applications that provide location-based services such as weather widgets, local yellow page widgets, and map/navigation widgets).

Digital assistant client module **229** can include various client-side digital assistant instructions to provide the client-side functionalities of the digital assistant. For example, digital assistant client module **229** can be capable of accepting voice input (e.g., speech input), text input, touch input, and/or gestural input through various user interfaces (e.g., microphone **213**, accelerometer(s) **268**, touch-sensitive display system **212**, optical sensor(s) **229**, other input control devices **216**, etc.) of portable multifunction device **200**.

Digital assistant client module **229** can also be capable of providing output in audio (e.g., speech output), visual, and/or tactile forms through various output interfaces (e.g., speaker **211**, touch-sensitive display system **212**, tactile output generator(s) **267**, etc.) of portable multifunction device **200**. For example, output can be provided as voice, sound, alerts, text messages, menus, graphics, videos, animations, vibrations, and/or combinations of two or more of the above. During operation, digital assistant client module **229** can communicate with DA server **106** using RF circuitry **208**.

User data and models **231** can include various data associated with the user (e.g., user-specific vocabulary data, user preference data, user-specified name pronunciations, data from the user’s electronic address book, to-do lists, shopping lists, etc.) to provide the client-side functionalities of the digital assistant. Further, user data and models **231** can include various models (e.g., speech recognition models, statistical language models, natural language processing models, ontology, task flow models, service models, etc.) for processing user input and determining user intent.

In some examples, digital assistant client module **229** can utilize the various sensors, subsystems, and peripheral devices of portable multifunction device **200** to gather additional information from the surrounding environment of the portable multifunction device **200** to establish a context associated with a user, the current user interaction, and/or the current user input. In some examples, digital assistant client module **229** can provide the contextual information or a subset thereof with the user input to DA server **106** to help infer the user’s intent. In some examples, the digital assistant can also use the contextual information to determine how to prepare and deliver outputs to the user. Contextual information can be referred to as context data.

In some examples, the contextual information that accompanies the user input can include sensor information, e.g., lighting, ambient noise, ambient temperature, images, or videos of the surrounding environment, etc. In some

examples, the contextual information can also include the physical state of the device, e.g., device orientation, device location, device temperature, power level, speed, acceleration, motion patterns, cellular signals strength, etc. In some examples, information related to the software state of DA server 106, e.g., running processes, installed programs, past and present network activities, background services, error logs, resources usage, etc., and of portable multifunction device 200 can be provided to DA server 106 as contextual information associated with a user input.

In some examples, the digital assistant client module 229 can selectively provide information (e.g., user data 231) stored on the portable multifunction device 200 in response to requests from DA server 106. In some examples, digital assistant client module 229 can also elicit additional input from the user via a natural language dialogue or other user interfaces upon request by DA server 106. Digital assistant client module 229 can pass the additional input to DA server 106 to help DA server 106 in intent deduction and/or fulfillment of the user's intent expressed in the user request.

A more detailed description of a digital assistant is described below with reference to FIGS. 7A-C. It should be recognized that digital assistant client module 229 can include any number of the sub-modules of digital assistant module 726 described below.

Applications 236 may include the following modules (or sets of instructions), or a subset or superset thereof:

Contacts module 237 (sometimes called an address book or contact list);

Telephone module 238;

Video conference module 239;

Email client module 240;

Instant messaging (IM) module 241;

Workout support module 242;

Camera module 243 for still and/or video images;

Image management module 244;

Video player module;

Music player module;

Browser module 247;

Calendar module 248;

Widget modules 249, which may include one or more of: weather widget 249-1, stocks widget 249-2, calculator widget 249-3, alarm clock widget 249-4, dictionary widget 249-5, and other widgets obtained by the user, as well as user-created widgets 249-6;

Widget creator module 250 for making user-created widgets 249-6;

Search module 251;

Video and music player module 252, which merges video player module and music player module;

Notes module 253;

Map module 254; and/or

Online video module 255.

Examples of other applications 236 that may be stored in memory 202 include other word processing applications, other image editing applications, drawing applications, presentation applications, JAVA-enabled applications, encryption, digital rights management, voice recognition, and voice replication.

In conjunction with touch screen 212, display controller 256, contact/motion module 230, graphics module 232, and text input module 234, contacts module 237 may be used to manage an address book or contact list (e.g., stored in application internal state 292 of contacts module 237 in memory 202 or memory 470), including: adding name(s) to the address book; deleting name(s) from the address book; associating telephone number(s), email address(es), physical

address(es) or other information with a name; associating an image with a name; categorizing and sorting names; providing telephone numbers or email addresses to initiate and/or facilitate communications by telephone 238, video conference module 239, email 240, or IM 241; and so forth.

In conjunction with RF circuitry 208, audio circuitry 210, speaker 211, microphone 213, touch screen 212, display controller 256, contact/motion module 230, graphics module 232, and text input module 234, telephone module 238 may be used to enter a sequence of characters corresponding to a telephone number, access one or more telephone numbers in contacts module 237, modify a telephone number that has been entered, dial a respective telephone number, conduct a conversation, and disconnect or hang up when the conversation is completed. As noted above, the wireless communication may use any of a plurality of communications standards, protocols, and technologies.

In conjunction with RF circuitry 208, audio circuitry 210, speaker 211, microphone 213, touch screen 212, display controller 256, optical sensor 264, optical sensor controller 258, contact/motion module 230, graphics module 232, text input module 234, contacts module 237, and telephone module 238, video conference module 239 includes executable instructions to initiate, conduct, and terminate a video conference between a user and one or more other participants in accordance with user instructions.

In conjunction with RF circuitry 208, touch screen 212, display controller 256, contact/motion module 230, graphics module 232, and text input module 234, email client module 240 includes executable instructions to create, send, receive, and manage email in response to user instructions. In conjunction with image management module 244, email client module 240 makes it very easy to create and send emails with still or video images taken with camera module 243.

In conjunction with RF circuitry 208, touch screen 212, display controller 256, contact/motion module 230, graphics module 232, and text input module 234, the instant messaging module 241 includes executable instructions to enter a sequence of characters corresponding to an instant message, to modify previously entered characters, to transmit a respective instant message (for example, using a Short Message Service (SMS) or Multimedia Message Service (MMS) protocol for telephony-based instant messages or using XMPP, SIMPLE, or IMPS for Internet-based instant messages), to receive instant messages, and to view received instant messages. In some embodiments, transmitted and/or received instant messages may include graphics, photos, audio files, video files and/or other attachments as are supported in an MMS and/or an Enhanced Messaging Service (EMS). As used herein, "instant messaging" refers to both telephony-based messages (e.g., messages sent using SMS or MMS) and Internet-based messages (e.g., messages sent using XMPP, SIMPLE, or IMPS).

In conjunction with RF circuitry 208, touch screen 212, display controller 256, contact/motion module 230, graphics module 232, text input module 234, GPS module 235, map module 254, and music player module, workout support module 242 includes executable instructions to create workouts (e.g., with time, distance, and/or calorie burning goals); communicate with workout sensors (sports devices); receive workout sensor data; calibrate sensors used to monitor a workout; select and play music for a workout; and display, store, and transmit workout data.

In conjunction with touch screen 212, display controller 256, optical sensor(s) 264, optical sensor controller 258, contact/motion module 230, graphics module 232, and

image management module **244**, camera module **243** includes executable instructions to capture still images or video (including a video stream) and store them into memory **202**, modify characteristics of a still image or video, or delete a still image or video from memory **202**.

In conjunction with touch screen **212**, display controller **256**, contact/motion module **230**, graphics module **232**, text input module **234**, and camera module **243**, image management module **244** includes executable instructions to arrange, modify (e.g., edit), or otherwise manipulate, label, delete, present (e.g., in a digital slide show or album), and store still and/or video images.

In conjunction with RF circuitry **208**, touch screen **212**, display controller **256**, contact/motion module **230**, graphics module **232**, and text input module **234**, browser module **247** includes executable instructions to browse the Internet in accordance with user instructions, including searching, linking to, receiving, and displaying web pages or portions thereof, as well as attachments and other files linked to web pages.

In conjunction with RF circuitry **208**, touch screen **212**, display controller **256**, contact/motion module **230**, graphics module **232**, text input module **234**, email client module **240**, and browser module **247**, calendar module **248** includes executable instructions to create, display, modify, and store calendars and data associated with calendars (e.g., calendar entries, to-do lists, etc.) in accordance with user instructions.

In conjunction with RF circuitry **208**, touch screen **212**, display controller **256**, contact/motion module **230**, graphics module **232**, text input module **234**, and browser module **247**, widget modules **249** are mini-applications that may be downloaded and used by a user (e.g., weather widget **249-1**, stocks widget **249-2**, calculator widget **249-3**, alarm clock widget **249-4**, and dictionary widget **249-5**) or created by the user (e.g., user-created widget **249-6**). In some embodiments, a widget includes an HTML (Hypertext Markup Language) file, a CSS (Cascading Style Sheets) file, and a JavaScript file. In some embodiments, a widget includes an XML (Extensible Markup Language) file and a JavaScript file (e.g., Yahoo! Widgets).

In conjunction with RF circuitry **208**, touch screen **212**, display controller **256**, contact/motion module **230**, graphics module **232**, text input module **234**, and browser module **247**, the widget creator module **250** may be used by a user to create widgets (e.g., turning a user-specified portion of a web page into a widget).

In conjunction with touch screen **212**, display controller **256**, contact/motion module **230**, graphics module **232**, and text input module **234**, search module **251** includes executable instructions to search for text, music, sound, image, video, and/or other files in memory **202** that match one or more search criteria (e.g., one or more user-specified search terms) in accordance with user instructions.

In conjunction with touch screen **212**, display controller **256**, contact/motion module **230**, graphics module **232**, audio circuitry **210**, speaker **211**, RF circuitry **208**, and browser module **247**, video and music player module **252** includes executable instructions that allow the user to download and play back recorded music and other sound files stored in one or more file formats, such as MP3 or AAC files, and executable instructions to display, present, or otherwise play back videos (e.g., on touch screen **212** or on an external, connected display via external port **224**). In some embodiments, device **200** optionally includes the functionality of an MP3 player, such as an iPod (trademark of Apple Inc.).

In conjunction with touch screen **212**, display controller **256**, contact/motion module **230**, graphics module **232**, and

text input module **234**, notes module **253** includes executable instructions to create and manage notes, to-do lists, and the like in accordance with user instructions.

In conjunction with RF circuitry **208**, touch screen **212**, display controller **256**, contact/motion module **230**, graphics module **232**, text input module **234**, GPS module **235**, and browser module **247**, map module **254** may be used to receive, display, modify, and store maps and data associated with maps (e.g., driving directions, data on stores and other points of interest at or near a particular location, and other location-based data) in accordance with user instructions.

In conjunction with touch screen **212**, display controller **256**, contact/motion module **230**, graphics module **232**, audio circuitry **210**, speaker **211**, RF circuitry **208**, text input module **234**, email client module **240**, and browser module **247**, online video module **255** includes instructions that allow the user to access, browse, receive (e.g., by streaming and/or download), play back (e.g., on the touch screen or on an external, connected display via external port **224**), send an email with a link to a particular online video, and otherwise manage online videos in one or more file formats, such as H.264. In some embodiments, instant messaging module **241**, rather than email client module **240**, is used to send a link to a particular online video. Additional description of the online video application can be found in U.S. Provisional Patent Application No. 60/936,562, "Portable Multifunction Device, Method, and Graphical User Interface for Playing Online Videos," filed Jun. 20, 2007, and U.S. patent application Ser. No. 11/968,067, "Portable Multifunction Device, Method, and Graphical User Interface for Playing Online Videos," filed Dec. 31, 2007, the contents of which are hereby incorporated by reference in their entirety.

Each of the above-identified modules and applications corresponds to a set of executable instructions for performing one or more functions described above and the methods described in this application (e.g., the computer-implemented methods and other information processing methods described herein). These modules (e.g., sets of instructions) need not be implemented as separate software programs, procedures, or modules, and thus various subsets of these modules may be combined or otherwise rearranged in various embodiments. For example, video player module may be combined with music player module into a single module (e.g., video and music player module **252**, FIG. 2A). In some embodiments, memory **202** may store a subset of the modules and data structures identified above. Furthermore, memory **202** may store additional modules and data structures not described above.

In some embodiments, device **200** is a device where operation of a predefined set of functions on the device is performed exclusively through a touch screen and/or a touchpad. By using a touch screen and/or a touchpad as the primary input control device for operation of device **200**, the number of physical input control devices (such as push buttons, dials, and the like) on device **200** may be reduced.

The predefined set of functions that are performed exclusively through a touch screen and/or a touchpad optionally include navigation between user interfaces. In some embodiments, the touchpad, when touched by the user, navigates device **200** to a main, home, or root menu from any user interface that is displayed on device **200**. In such embodiments, a "menu button" is implemented using a touchpad. In some other embodiments, the menu button is a physical push button or other physical input control device instead of a touchpad.

FIG. 2B is a block diagram illustrating exemplary components for event handling in accordance with some

embodiments. In some embodiments, memory **202** (FIG. 2A) or **470** (FIG. 4) includes event sorter **270** (e.g., in operating system **226**) and a respective application **236-1** (e.g., any of the aforementioned applications **237-251**, **255**, **480-490**).

Event sorter **270** receives event information and determines the application **236-1** and application view **291** of application **236-1** to which to deliver the event information. Event sorter **270** includes event monitor **271** and event dispatcher module **274**. In some embodiments, application **236-1** includes application internal state **292**, which indicates the current application view(s) displayed on touch-sensitive display **212** when the application is active or executing. In some embodiments, device/global internal state **257** is used by event sorter **270** to determine which application(s) is (are) currently active, and application internal state **292** is used by event sorter **270** to determine application views **291** to which to deliver event information.

In some embodiments, application internal state **292** includes additional information, such as one or more of: resume information to be used when application **236-1** resumes execution, user interface state information that indicates information being displayed or that is ready for display by application **236-1**, a state queue for enabling the user to go back to a prior state or view of application **236-1**, and a redo/undo queue of previous actions taken by the user.

Event monitor **271** receives event information from peripherals interface **218**. Event information includes information about a sub-event (e.g., a user touch on touch-sensitive display **212**, as part of a multi-touch gesture). Peripherals interface **218** transmits information it receives from I/O subsystem **206** or a sensor, such as proximity sensor **266**, accelerometer(s) **268**, and/or microphone **213** (through audio circuitry **210**). Information that peripherals interface **218** receives from I/O subsystem **206** includes information from touch-sensitive display **212** or a touch-sensitive surface.

In some embodiments, event monitor **271** sends requests to the peripherals interface **218** at predetermined intervals. In response, peripherals interface **218** transmits event information. In other embodiments, peripherals interface **218** transmits event information only when there is a significant event (e.g., receiving an input above a predetermined noise threshold and/or for more than a predetermined duration).

In some embodiments, event sorter **270** also includes a hit view determination module **272** and/or an active event recognizer determination module **273**.

Hit view determination module **272** provides software procedures for determining where a sub-event has taken place within one or more views when touch-sensitive display **212** displays more than one view. Views are made up of controls and other elements that a user can see on the display.

Another aspect of the user interface associated with an application is a set of views, sometimes herein called application views or user interface windows, in which information is displayed and touch-based gestures occur. The application views (of a respective application) in which a touch is detected may correspond to programmatic levels within a programmatic or view hierarchy of the application. For example, the lowest level view in which a touch is detected may be called the hit view, and the set of events that are recognized as proper inputs may be determined based, at least in part, on the hit view of the initial touch that begins a touch-based gesture.

Hit view determination module **272** receives information related to sub events of a touch-based gesture. When an

application has multiple views organized in a hierarchy, hit view determination module **272** identifies a hit view as the lowest view in the hierarchy which should handle the sub-event. In most circumstances, the hit view is the lowest level view in which an initiating sub-event occurs (e.g., the first sub-event in the sequence of sub-events that form an event or potential event). Once the hit view is identified by the hit view determination module **272**, the hit view typically receives all sub-events related to the same touch or input source for which it was identified as the hit view.

Active event recognizer determination module **273** determines which view or views within a view hierarchy should receive a particular sequence of sub-events. In some embodiments, active event recognizer determination module **273** determines that only the hit view should receive a particular sequence of sub-events. In other embodiments, active event recognizer determination module **273** determines that all views that include the physical location of a sub-event are actively involved views, and therefore determines that all actively involved views should receive a particular sequence of sub-events. In other embodiments, even if touch sub-events were entirely confined to the area associated with one particular view, views higher in the hierarchy would still remain as actively involved views.

Event dispatcher module **274** dispatches the event information to an event recognizer (e.g., event recognizer **280**). In embodiments including active event recognizer determination module **273**, event dispatcher module **274** delivers the event information to an event recognizer determined by active event recognizer determination module **273**. In some embodiments, event dispatcher module **274** stores in an event queue the event information, which is retrieved by a respective event receiver **282**.

In some embodiments, operating system **226** includes event sorter **270**. Alternatively, application **236-1** includes event sorter **270**. In yet other embodiments, event sorter **270** is a stand-alone module, or a part of another module stored in memory **202**, such as contact/motion module **230**.

In some embodiments, application **236-1** includes a plurality of event handlers **290** and one or more application views **291**, each of which includes instructions for handling touch events that occur within a respective view of the application's user interface. Each application view **291** of the application **236-1** includes one or more event recognizers **280**. Typically, a respective application view **291** includes a plurality of event recognizers **280**. In other embodiments, one or more of event recognizers **280** are part of a separate module, such as a user interface kit (not shown) or a higher level object from which application **236-1** inherits methods and other properties. In some embodiments, a respective event handler **290** includes one or more of: data updater **276**, object updater **277**, GUI updater **278**, and/or event data **279** received from event sorter **270**. Event handler **290** may utilize or call data updater **276**, object updater **277**, or GUI updater **278** to update the application internal state **292**. Alternatively, one or more of the application views **291** include one or more respective event handlers **290**. Also, in some embodiments, one or more of data updater **276**, object updater **277**, and GUI updater **278** are included in a respective application view **291**.

A respective event recognizer **280** receives event information (e.g., event data **279**) from event sorter **270** and identifies an event from the event information. Event recognizer **280** includes event receiver **282** and event comparator **284**. In some embodiments, event recognizer **280** also

includes at least a subset of: metadata **283**, and event delivery instructions **288** (which may include sub-event delivery instructions).

Event receiver **282** receives event information from event sorter **270**. The event information includes information about a sub-event, for example, a touch or a touch movement. Depending on the sub-event, the event information also includes additional information, such as location of the sub-event. When the sub-event concerns motion of a touch, the event information may also include speed and direction of the sub-event. In some embodiments, events include rotation of the device from one orientation to another (e.g., from a portrait orientation to a landscape orientation, or vice versa), and the event information includes corresponding information about the current orientation (also called device attitude) of the device.

Event comparator **284** compares the event information to predefined event or sub-event definitions and, based on the comparison, determines an event or sub event, or determines or updates the state of an event or sub-event. In some embodiments, event comparator **284** includes event definitions **286**. Event definitions **286** contain definitions of events (e.g., predefined sequences of sub-events), for example, event **1** (**287-1**), event **2** (**287-2**), and others. In some embodiments, sub-events in an event (**287**) include, for example, touch begin, touch end, touch movement, touch cancellation, and multiple touching. In one example, the definition for event **1** (**287-1**) is a double tap on a displayed object. The double tap, for example, comprises a first touch (touch begin) on the displayed object for a predetermined phase, a first liftoff (touch end) for a predetermined phase, a second touch (touch begin) on the displayed object for a predetermined phase, and a second liftoff (touch end) for a predetermined phase. In another example, the definition for event **2** (**287-2**) is a dragging on a displayed object. The dragging, for example, comprises a touch (or contact) on the displayed object for a predetermined phase, a movement of the touch across touch-sensitive display **212**, and liftoff of the touch (touch end). In some embodiments, the event also includes information for one or more associated event handlers **290**.

In some embodiments, event definition **287** includes a definition of an event for a respective user-interface object. In some embodiments, event comparator **284** performs a hit test to determine which user-interface object is associated with a sub-event. For example, in an application view in which three user-interface objects are displayed on touch-sensitive display **212**, when a touch is detected on touch-sensitive display **212**, event comparator **284** performs a hit test to determine which of the three user-interface objects is associated with the touch (sub-event). If each displayed object is associated with a respective event handler **290**, the event comparator uses the result of the hit test to determine which event handler **290** should be activated. For example, event comparator **284** selects an event handler associated with the sub-event and the object triggering the hit test.

In some embodiments, the definition for a respective event (**287**) also includes delayed actions that delay delivery of the event information until after it has been determined whether the sequence of sub-events does or does not correspond to the event recognizer's event type.

When a respective event recognizer **280** determines that the series of sub-events do not match any of the events in event definitions **286**, the respective event recognizer **280** enters an event impossible, event failed, or event ended state, after which it disregards subsequent sub-events of the touch-based gesture. In this situation, other event recogniz-

ers, if any, that remain active for the hit view continue to track and process sub-events of an ongoing touch-based gesture.

In some embodiments, a respective event recognizer **280** includes metadata **283** with configurable properties, flags, and/or lists that indicate how the event delivery system should perform sub-event delivery to actively involved event recognizers. In some embodiments, metadata **283** includes configurable properties, flags, and/or lists that indicate how event recognizers may interact, or are enabled to interact, with one another. In some embodiments, metadata **283** includes configurable properties, flags, and/or lists that indicate whether sub-events are delivered to varying levels in the view or programmatic hierarchy.

In some embodiments, a respective event recognizer **280** activates event handler **290** associated with an event when one or more particular sub-events of an event are recognized. In some embodiments, a respective event recognizer **280** delivers event information associated with the event to event handler **290**. Activating an event handler **290** is distinct from sending (and deferred sending) sub-events to a respective hit view. In some embodiments, event recognizer **280** throws a flag associated with the recognized event, and event handler **290** associated with the flag catches the flag and performs a predefined process.

In some embodiments, event delivery instructions **288** include sub-event delivery instructions that deliver event information about a sub-event without activating an event handler. Instead, the sub-event delivery instructions deliver event information to event handlers associated with the series of sub-events or to actively involved views. Event handlers associated with the series of sub-events or with actively involved views receive the event information and perform a predetermined process.

In some embodiments, data updater **276** creates and updates data used in application **236-1**. For example, data updater **276** updates the telephone number used in contacts module **237**, or stores a video file used in video player module. In some embodiments, object updater **277** creates and updates objects used in application **236-1**. For example, object updater **277** creates a new user-interface object or updates the position of a user-interface object. GUI updater **278** updates the GUI. For example, GUI updater **278** prepares display information and sends it to graphics module **232** for display on a touch-sensitive display.

In some embodiments, event handler(s) **290** includes or has access to data updater **276**, object updater **277**, and GUI updater **278**. In some embodiments, data updater **276**, object updater **277**, and GUI updater **278** are included in a single module of a respective application **236-1** or application view **291**. In other embodiments, they are included in two or more software modules.

It shall be understood that the foregoing discussion regarding event handling of user touches on touch-sensitive displays also applies to other forms of user inputs to operate multifunction devices **200** with input devices, not all of which are initiated on touch screens. For example, mouse movement and mouse button presses, optionally coordinated with single or multiple keyboard presses or holds; contact movements such as taps, drags, scrolls, etc. on touchpads; pen stylus inputs; movement of the device; oral instructions; detected eye movements; biometric inputs; and/or any combination thereof are optionally utilized as inputs corresponding to sub-events which define an event to be recognized.

FIG. 3 illustrates a portable multifunction device **200** having a touch screen **212** in accordance with some embodiments. The touch screen optionally displays one or more

graphics within user interface (UI) **300**. In this embodiment, as well as others described below, a user is enabled to select one or more of the graphics by making a gesture on the graphics, for example, with one or more fingers **302** (not drawn to scale in the figure) or one or more styluses **303** (not drawn to scale in the figure). In some embodiments, selection of one or more graphics occurs when the user breaks contact with the one or more graphics. In some embodiments, the gesture optionally includes one or more taps, one or more swipes (from left to right, right to left, upward and/or downward), and/or a rolling of a finger (from right to left, left to right, upward and/or downward) that has made contact with device **200**. In some implementations or circumstances, inadvertent contact with a graphic does not select the graphic. For example, a swipe gesture that sweeps over an application icon optionally does not select the corresponding application when the gesture corresponding to selection is a tap.

Device **200** may also include one or more physical buttons, such as “home” or menu button **304**. As described previously, menu button **304** may be used to navigate to any application **236** in a set of applications that may be executed on device **200**. Alternatively, in some embodiments, the menu button is implemented as a soft key in a GUI displayed on touch screen **212**.

In one embodiment, device **200** includes touch screen **212**, menu button **304**, push button **306** for powering the device on/off and locking the device, volume adjustment button(s) **308**, subscriber identity module (SIM) card slot **310**, headset jack **312**, and docking/charging external port **224**. Push button **306** is, optionally, used to turn the power on/off on the device by depressing the button and holding the button in the depressed state for a predefined time interval; to lock the device by depressing the button and releasing the button before the predefined time interval has elapsed; and/or to unlock the device or initiate an unlock process. In an alternative embodiment, device **200** also accepts verbal input for activation or deactivation of some functions through microphone **213**. Device **200** also, optionally, includes one or more contact intensity sensors **265** for detecting intensity of contacts on touch screen **212** and/or one or more tactile output generators **267** for generating tactile outputs for a user of device **200**.

FIG. **4** is a block diagram of an exemplary multifunction device with a display and a touch-sensitive surface in accordance with some embodiments. Device **400** need not be portable. In some embodiments, device **400** is a laptop computer, a desktop computer, a tablet computer, a multimedia player device, a navigation device, an educational device (such as a child’s learning toy), a gaming system, or a control device (e.g., a home or industrial controller). Device **400** typically includes one or more processing units (CPUs) **410**, one or more network or other communications interfaces **460**, memory **470**, and one or more communication buses **420** for interconnecting these components. Communication buses **420** optionally include circuitry (sometimes called a chipset) that interconnects and controls communications between system components. Device **400** includes input/output (I/O) interface **430** comprising display **440**, which is typically a touch screen display. I/O interface **430** also optionally includes a keyboard and/or mouse (or other pointing device) **450** and touchpad **455**, tactile output generator **457** for generating tactile outputs on device **400** (e.g., similar to tactile output generator(s) **267** described above with reference to FIG. **2A**), sensors **459** (e.g., optical, acceleration, proximity, touch-sensitive, and/or contact intensity sensors similar to contact intensity sensor(s) **265**

described above with reference to FIG. **2A**). Memory **470** includes high-speed random access memory, such as DRAM, SRAM, DDR RAM, or other random access solid state memory devices; and optionally includes non-volatile memory, such as one or more magnetic disk storage devices, optical disk storage devices, flash memory devices, or other non-volatile solid state storage devices. Memory **470** optionally includes one or more storage devices remotely located from CPU(s) **410**. In some embodiments, memory **470** stores programs, modules, and data structures analogous to the programs, modules, and data structures stored in memory **202** of portable multifunction device **200** (FIG. **2A**), or a subset thereof. Furthermore, memory **470** optionally stores additional programs, modules, and data structures not present in memory **202** of portable multifunction device **200**. For example, memory **470** of device **400** optionally stores drawing module **480**, presentation module **482**, word processing module **484**, website creation module **486**, disk authoring module **488**, and/or spreadsheet module **490**, while memory **202** of portable multifunction device **200** (FIG. **2A**) optionally does not store these modules.

Each of the above-identified elements in FIG. **4** may be stored in one or more of the previously mentioned memory devices. Each of the above-identified modules corresponds to a set of instructions for performing a function described above. The above-identified modules or programs (e.g., sets of instructions) need not be implemented as separate software programs, procedures, or modules, and thus various subsets of these modules may be combined or otherwise rearranged in various embodiments. In some embodiments, memory **470** may store a subset of the modules and data structures identified above. Furthermore, memory **470** may store additional modules and data structures not described above.

Attention is now directed towards embodiments of user interfaces that may be implemented on, for example, portable multifunction device **200**.

FIG. **5A** illustrates an exemplary user interface for a menu of applications on portable multifunction device **200** in accordance with some embodiments. Similar user interfaces may be implemented on device **400**. In some embodiments, user interface **500** includes the following elements, or a subset or superset thereof:

Signal strength indicator(s) **502** for wireless communication(s), such as cellular and Wi-Fi signals;

Time **504**;

Bluetooth indicator **505**;

Battery status indicator **506**;

Tray **508** with icons for frequently used applications, such as:

Icon **516** for telephone module **238**, labeled “Phone,” which optionally includes an indicator **514** of the number of missed calls or voicemail messages;

Icon **518** for email client module **240**, labeled “Mail,” which optionally includes an indicator **510** of the number of unread emails;

Icon **520** for browser module **247**, labeled “Browser;” and

Icon **522** for video and music player module **252**, also referred to as iPod (trademark of Apple Inc.) module **252**, labeled “iPod;” and

Icons for other applications, such as:

Icon **524** for IM module **241**, labeled “Messages;”

Icon **526** for calendar module **248**, labeled “Calendar;”

Icon **528** for image management module **244**, labeled “Photos;”

Icon **530** for camera module **243**, labeled “Camera;”

Icon **532** for online video module **255**, labeled “Online Video;”

Icon **534** for stocks widget **249-2**, labeled “Stocks;”

Icon **536** for map module **254**, labeled “Maps;”

Icon **538** for weather widget **249-1**, labeled “Weather;”

Icon **540** for alarm clock widget **249-4**, labeled “Clock;”

Icon **542** for workout support module **242**, labeled “Workout Support;”

Icon **544** for notes module **253**, labeled “Notes;” and

Icon **546** for a settings application or module, labeled “Settings,” which provides access to settings for device **200** and its various applications **236**.

It should be noted that the icon labels illustrated in FIG. **5A** are merely exemplary. For example, icon **522** for video and music player module **252** may optionally be labeled “Music” or “Music Player.” Other labels are, optionally, used for various application icons. In some embodiments, a label for a respective application icon includes a name of an application corresponding to the respective application icon. In some embodiments, a label for a particular application icon is distinct from a name of an application corresponding to the particular application icon.

FIG. **5B** illustrates an exemplary user interface on a device (e.g., device **400**, FIG. **4**) with a touch-sensitive surface **551** (e.g., a tablet or touchpad **455**, FIG. **4**) that is separate from the display **550** (e.g., touch screen display **212**). Device **400** also, optionally, includes one or more contact intensity sensors (e.g., one or more of sensors **457**) for detecting intensity of contacts on touch-sensitive surface **551** and/or one or more tactile output generators **459** for generating tactile outputs for a user of device **400**.

Although some of the examples which follow will be given with reference to inputs on touch screen display **212** (where the touch-sensitive surface and the display are combined), in some embodiments, the device detects inputs on a touch-sensitive surface that is separate from the display, as shown in FIG. **5B**. In some embodiments, the touch-sensitive surface (e.g., **551** in FIG. **5B**) has a primary axis (e.g., **552** in FIG. **5B**) that corresponds to a primary axis (e.g., **553** in FIG. **5B**) on the display (e.g., **550**). In accordance with these embodiments, the device detects contacts (e.g., **560** and **562** in FIG. **5B**) with the touch-sensitive surface **551** at locations that correspond to respective locations on the display (e.g., in FIG. **5B**, **560** corresponds to **568** and **562** corresponds to **570**). In this way, user inputs (e.g., contacts **560** and **562**, and movements thereof) detected by the device on the touch-sensitive surface (e.g., **551** in FIG. **5B**) are used by the device to manipulate the user interface on the display (e.g., **550** in FIG. **5B**) of the multifunction device when the touch-sensitive surface is separate from the display. It should be understood that similar methods are, optionally, used for other user interfaces described herein.

Additionally, while the following examples are given primarily with reference to finger inputs (e.g., finger contacts, finger tap gestures, finger swipe gestures), it should be understood that, in some embodiments, one or more of the finger inputs are replaced with input from another input device (e.g., a mouse-based input or stylus input). For example, a swipe gesture is, optionally, replaced with a mouse click (e.g., instead of a contact) followed by movement of the cursor along the path of the swipe (e.g., instead of movement of the contact). As another example, a tap gesture is, optionally, replaced with a mouse click while the cursor is located over the location of the tap gesture (e.g., instead of detection of the contact followed by ceasing to detect the contact). Similarly, when multiple user inputs are

simultaneously detected, it should be understood that multiple computer mice are, optionally, used simultaneously, or a mouse and finger contacts are, optionally, used simultaneously.

FIG. **6A** illustrates exemplary personal electronic device **600**. Device **600** includes body **602**. In some embodiments, device **600** can include some or all of the features described with respect to devices **200** and **400** (e.g., FIGS. **2A-4B**). In some embodiments, device **600** has touch-sensitive display screen **604**, hereafter touch screen **604**. Alternatively, or in addition to touch screen **604**, device **600** has a display and a touch-sensitive surface. As with devices **200** and **400**, in some embodiments, touch screen **604** (or the touch-sensitive surface) may have one or more intensity sensors for detecting intensity of contacts (e.g., touches) being applied. The one or more intensity sensors of touch screen **604** (or the touch-sensitive surface) can provide output data that represents the intensity of touches. The user interface of device **600** can respond to touches based on their intensity, meaning that touches of different intensities can invoke different user interface operations on device **600**.

Techniques for detecting and processing touch intensity may be found, for example, in related applications: International Patent Application Serial No. PCT/US2013/040061, titled “Device, Method, and Graphical User Interface for Displaying User Interface Objects Corresponding to an Application,” filed May 8, 2013, and International Patent Application Serial No. PCT/US2013/069483, titled “Device, Method, and Graphical User Interface for Transitioning Between Touch Input to Display Output Relationships,” filed Nov. 11, 2013, each of which is hereby incorporated by reference in their entirety.

In some embodiments, device **600** has one or more input mechanisms **606** and **608**. Input mechanisms **606** and **608**, if included, can be physical. Examples of physical input mechanisms include push buttons and rotatable mechanisms. In some embodiments, device **600** has one or more attachment mechanisms. Such attachment mechanisms, if included, can permit attachment of device **600** with, for example, hats, eyewear, earrings, necklaces, shirts, jackets, bracelets, watch straps, chains, trousers, belts, shoes, purses, backpacks, and so forth. These attachment mechanisms may permit device **600** to be worn by a user.

FIG. **6B** depicts exemplary personal electronic device **600**. In some embodiments, device **600** can include some or all of the components described with respect to FIGS. **2A**, **2B**, and **4**. Device **600** has bus **612** that operatively couples I/O section **614** with one or more computer processors **616** and memory **618**. I/O section **614** can be connected to display **604**, which can have touch-sensitive component **622** and, optionally, touch-intensity sensitive component **624**. In addition, I/O section **614** can be connected with communication unit **630** for receiving application and operating system data, using Wi-Fi, Bluetooth, near field communication (NFC), cellular, and/or other wireless communication techniques. Device **600** can include input mechanisms **606** and/or **608**. Input mechanism **606** may be a rotatable input device or a depressible and rotatable input device, for example. Input mechanism **608** may be a button, in some examples.

Input mechanism **608** may be a microphone, in some examples. Personal electronic device **600** can include various sensors, such as GPS sensor **632**, accelerometer **634**, directional sensor **640** (e.g., compass), gyroscope **636**, motion sensor **638**, and/or a combination thereof, all of which can be operatively connected to I/O section **614**.

Memory 618 of personal electronic device 600 can include one or more non-transitory computer-readable storage mediums, for storing computer-executable instructions, which, when executed by one or more computer processors 616, for example, can cause the computer processors to perform the techniques described below, including processes 1100-1300 (FIGS. 11A-B, 12A-B, 13A-B). Personal electronic device 600 is not limited to the components and configuration of FIG. 6B, but can include other or additional components in multiple configurations.

As used here, the term “affordance” refers to a user-interactive graphical user interface object that may be displayed on the display screen of devices 200, 400, and/or 600 (FIGS. 2, 4, and 6). For example, an image (e.g., icon), a button, and text (e.g., link) may each constitute an affordance.

As used herein, the term “focus selector” refers to an input element that indicates a current part of a user interface with which a user is interacting. In some implementations that include a cursor or other location marker, the cursor acts as a “focus selector” so that when an input (e.g., a press input) is detected on a touch-sensitive surface (e.g., touchpad 455 in FIG. 4 or touch-sensitive surface 551 in FIG. 5B) while the cursor is over a particular user interface element (e.g., a button, window, slider or other user interface element), the particular user interface element is adjusted in accordance with the detected input. In some implementations that include a touch screen display (e.g., touch-sensitive display system 212 in FIG. 2A or touch screen 212 in FIG. 5A) that enables direct interaction with user interface elements on the touch screen display, a detected contact on the touch screen acts as a “focus selector” so that when an input (e.g., a press input by the contact) is detected on the touch screen display at a location of a particular user interface element (e.g., a button, window, slider, or other user interface element), the particular user interface element is adjusted in accordance with the detected input. In some implementations, focus is moved from one region of a user interface to another region of the user interface without corresponding movement of a cursor or movement of a contact on a touch screen display (e.g., by using a tab key or arrow keys to move focus from one button to another button); in these implementations, the focus selector moves in accordance with movement of focus between different regions of the user interface. Without regard to the specific form taken by the focus selector, the focus selector is generally the user interface element (or contact on a touch screen display) that is controlled by the user so as to communicate the user’s intended interaction with the user interface (e.g., by indicating, to the device, the element of the user interface with which the user is intending to interact). For example, the location of a focus selector (e.g., a cursor, a contact, or a selection box) over a respective button while a press input is detected on the touch-sensitive surface (e.g., a touchpad or touch screen) will indicate that the user is intending to activate the respective button (as opposed to other user interface elements shown on a display of the device).

As used in the specification and claims, the term “characteristic intensity” of a contact refers to a characteristic of the contact based on one or more intensities of the contact. In some embodiments, the characteristic intensity is based on multiple intensity samples. The characteristic intensity is, optionally, based on a predefined number of intensity samples, or a set of intensity samples collected during a predetermined time period (e.g., 0.05, 0.1, 0.2, 0.5, 1, 2, 5, 10 seconds) relative to a predefined event (e.g., after detecting the contact, prior to detecting liftoff of the contact,

before or after detecting a start of movement of the contact, prior to detecting an end of the contact, before or after detecting an increase in intensity of the contact, and/or before or after detecting a decrease in intensity of the contact). A characteristic intensity of a contact is, optionally based on one or more of: a maximum value of the intensities of the contact, a mean value of the intensities of the contact, an average value of the intensities of the contact, a top 10 percentile value of the intensities of the contact, a value at the half maximum of the intensities of the contact, a value at the 90 percent maximum of the intensities of the contact, or the like. In some embodiments, the duration of the contact is used in determining the characteristic intensity (e.g., when the characteristic intensity is an average of the intensity of the contact over time). In some embodiments, the characteristic intensity is compared to a set of one or more intensity thresholds to determine whether an operation has been performed by a user. For example, the set of one or more intensity thresholds may include a first intensity threshold and a second intensity threshold. In this example, a contact with a characteristic intensity that does not exceed the first threshold results in a first operation, a contact with a characteristic intensity that exceeds the first intensity threshold and does not exceed the second intensity threshold results in a second operation, and a contact with a characteristic intensity that exceeds the second threshold results in a third operation. In some embodiments, a comparison between the characteristic intensity and one or more thresholds is used to determine whether or not to perform one or more operations (e.g., whether to perform a respective operation or forgo performing the respective operation) rather than being used to determine whether to perform a first operation or a second operation.

In some embodiments, a portion of a gesture is identified for purposes of determining a characteristic intensity. For example, a touch-sensitive surface may receive a continuous swipe contact transitioning from a start location and reaching an end location, at which point the intensity of the contact increases. In this example, the characteristic intensity of the contact at the end location may be based on only a portion of the continuous swipe contact, and not the entire swipe contact (e.g., only the portion of the swipe contact at the end location). In some embodiments, a smoothing algorithm may be applied to the intensities of the swipe contact prior to determining the characteristic intensity of the contact. For example, the smoothing algorithm optionally includes one or more of: an unweighted sliding-average smoothing algorithm, a triangular smoothing algorithm, a median filter smoothing algorithm, and/or an exponential smoothing algorithm. In some circumstances, these smoothing algorithms eliminate narrow spikes or dips in the intensities of the swipe contact for purposes of determining a characteristic intensity.

The intensity of a contact on the touch-sensitive surface may be characterized relative to one or more intensity thresholds, such as a contact-detection intensity threshold, a light press intensity threshold, a deep press intensity threshold, and/or one or more other intensity thresholds. In some embodiments, the light press intensity threshold corresponds to an intensity at which the device will perform operations typically associated with clicking a button of a physical mouse or a trackpad. In some embodiments, the deep press intensity threshold corresponds to an intensity at which the device will perform operations that are different from operations typically associated with clicking a button of a physical mouse or a trackpad. In some embodiments, when a contact is detected with a characteristic intensity below the light

press intensity threshold (e.g., and above a nominal contact-detection intensity threshold below which the contact is no longer detected), the device will move a focus selector in accordance with movement of the contact on the touch-sensitive surface without performing an operation associated with the light press intensity threshold or the deep press intensity threshold. Generally, unless otherwise stated, these intensity thresholds are consistent between different sets of user interface figures.

An increase of characteristic intensity of the contact from an intensity below the light press intensity threshold to an intensity between the light press intensity threshold and the deep press intensity threshold is sometimes referred to as a “light press” input. An increase of characteristic intensity of the contact from an intensity below the deep press intensity threshold to an intensity above the deep press intensity threshold is sometimes referred to as a “deep press” input. An increase of characteristic intensity of the contact from an intensity below the contact-detection intensity threshold to an intensity between the contact-detection intensity threshold and the light press intensity threshold is sometimes referred to as detecting the contact on the touch-surface. A decrease of characteristic intensity of the contact from an intensity above the contact-detection intensity threshold to an intensity below the contact-detection intensity threshold is sometimes referred to as detecting liftoff of the contact from the touch-surface. In some embodiments, the contact-detection intensity threshold is zero. In some embodiments, the contact-detection intensity threshold is greater than zero.

In some embodiments described herein, one or more operations are performed in response to detecting a gesture that includes a respective press input or in response to detecting the respective press input performed with a respective contact (or a plurality of contacts), where the respective press input is detected based at least in part on detecting an increase in intensity of the contact (or plurality of contacts) above a press-input intensity threshold. In some embodiments, the respective operation is performed in response to detecting the increase in intensity of the respective contact above the press-input intensity threshold (e.g., a “down stroke” of the respective press input). In some embodiments, the press input includes an increase in intensity of the respective contact above the press-input intensity threshold and a subsequent decrease in intensity of the contact below the press-input intensity threshold, and the respective operation is performed in response to detecting the subsequent decrease in intensity of the respective contact below the press-input threshold (e.g., an “up stroke” of the respective press input).

In some embodiments, the device employs intensity hysteresis to avoid accidental inputs sometimes termed “jitter,” where the device defines or selects a hysteresis intensity threshold with a predefined relationship to the press-input intensity threshold (e.g., the hysteresis intensity threshold is X intensity units lower than the press-input intensity threshold or the hysteresis intensity threshold is 75%, 90%, or some reasonable proportion of the press-input intensity threshold). Thus, in some embodiments, the press input includes an increase in intensity of the respective contact above the press-input intensity threshold and a subsequent decrease in intensity of the contact below the hysteresis intensity threshold that corresponds to the press-input intensity threshold, and the respective operation is performed in response to detecting the subsequent decrease in intensity of the respective contact below the hysteresis intensity threshold (e.g., an “up stroke” of the respective press input). Similarly, in some embodiments, the press input is detected

only when the device detects an increase in intensity of the contact from an intensity at or below the hysteresis intensity threshold to an intensity at or above the press-input intensity threshold and, optionally, a subsequent decrease in intensity of the contact to an intensity at or below the hysteresis intensity, and the respective operation is performed in response to detecting the press input (e.g., the increase in intensity of the contact or the decrease in intensity of the contact, depending on the circumstances).

For ease of explanation, the descriptions of operations performed in response to a press input associated with a press-input intensity threshold or in response to a gesture including the press input are, optionally, triggered in response to detecting either: an increase in intensity of a contact above the press-input intensity threshold, an increase in intensity of a contact from an intensity below the hysteresis intensity threshold to an intensity above the press-input intensity threshold, a decrease in intensity of the contact below the press-input intensity threshold, and/or a decrease in intensity of the contact below the hysteresis intensity threshold corresponding to the press-input intensity threshold. Additionally, in examples where an operation is described as being performed in response to detecting a decrease in intensity of a contact below the press-input intensity threshold, the operation is, optionally, performed in response to detecting a decrease in intensity of the contact below a hysteresis intensity threshold corresponding to, and lower than, the press-input intensity threshold.

3. Digital Assistant System

FIG. 7A illustrates a block diagram of digital assistant system 700 in accordance with various examples. In some examples, digital assistant system 700 can be implemented on a standalone computer system. In some examples, digital assistant system 700 can be distributed across multiple computers. In some examples, some of the modules and functions of the digital assistant can be divided into a server portion and a client portion, where the client portion resides on one or more user devices (e.g., devices 104, 122, 200, 400, or 600) and communicates with the server portion (e.g., server system 108) through one or more networks, e.g., as shown in FIG. 1. In some examples, digital assistant system 700 can be an implementation of server system 108 (and/or DA server 106) shown in FIG. 1. It should be noted that digital assistant system 700 is only one example of a digital assistant system, and that digital assistant system 700 can have more or fewer components than shown, may combine two or more components, or may have a different configuration or arrangement of the components. The various components shown in FIG. 7A can be implemented in hardware, software instructions for execution by one or more processors, firmware, including one or more signal processing and/or application specific integrated circuits, or a combination thereof.

Digital assistant system 700 can include memory 702, one or more processors 704, input/output (I/O) interface 706, and network communications interface 708. These components can communicate with one another over one or more communication buses or signal lines 710.

In some examples, memory 702 can include a non-transitory computer-readable medium, such as high-speed random access memory and/or a non-volatile computer-readable storage medium (e.g., one or more magnetic disk storage devices, flash memory devices, or other non-volatile solid-state memory devices).

In some examples, I/O interface 706 can couple input/output devices 716 of digital assistant system 700, such as displays, keyboards, touch screens, and microphones, to user

interface module 722. I/O interface 706, in conjunction with user interface module 722, can receive user inputs (e.g., voice input, keyboard inputs, touch inputs, etc.) and processes them accordingly. In some examples, e.g., when the digital assistant is implemented on a standalone user device, digital assistant system 700 can include any of the components and I/O communication interfaces described with respect to devices 200, 400, or 600 in FIGS. 2A, 4, 6A-B, respectively. In some examples, digital assistant system 700 can represent the server portion of a digital assistant implementation, and can interact with the user through a client-side portion residing on a user device (e.g., devices 104, 200, 400, or 600).

In some examples, the network communications interface 708 can include wired communication port(s) 712 and/or wireless transmission and reception circuitry 714. The wired communication port(s) can receive and send communication signals via one or more wired interfaces, e.g., Ethernet, Universal Serial Bus (USB), FIREWIRE, etc. The wireless circuitry 714 can receive and send RF signals and/or optical signals from/to communications networks and other communications devices. The wireless communications can use any of a plurality of communications standards, protocols, and technologies, such as GSM, EDGE, CDMA, TDMA, Bluetooth, Wi-Fi, VoIP, Wi-MAX, or any other suitable communication protocol. Network communications interface 708 can enable communication between digital assistant system 700 with networks, such as the Internet, an intranet, and/or a wireless network, such as a cellular telephone network, a wireless local area network (LAN), and/or a metropolitan area network (MAN), and other devices.

In some examples, memory 702, or the computer-readable storage media of memory 702, can store programs, modules, instructions, and data structures including all or a subset of: operating system 718, communications module 720, user interface module 722, one or more applications 724, and digital assistant module 726. In particular, memory 702, or the computer-readable storage media of memory 702, can store instructions for performing processes 1100-1300, described below. One or more processors 704 can execute these programs, modules, and instructions, and reads/writes from/to the data structures.

Operating system 718 (e.g., Darwin, RTXC, LINUX, UNIX, iOS, OS X, WINDOWS, or an embedded operating system such as VxWorks) can include various software components and/or drivers for controlling and managing general system tasks (e.g., memory management, storage device control, power management, etc.) and facilitates communications between various hardware, firmware, and software components.

Communications module 720 can facilitate communications between digital assistant system 700 with other devices over network communications interface 708. For example, communications module 720 can communicate with RF circuitry 208 of electronic devices such as devices 200, 400, and 600 shown in FIG. 2A, 4, 6A-B, respectively. Communications module 720 can also include various components for handling data received by wireless circuitry 714 and/or wired communications port 712.

User interface module 722 can receive commands and/or inputs from a user via I/O interface 706 (e.g., from a keyboard, touch screen, pointing device, controller, and/or microphone), and generate user interface objects on a display. User interface module 722 can also prepare and deliver outputs (e.g., speech, sound, animation, text, icons, vibra-

tions, haptic feedback, light, etc.) to the user via the I/O interface 706 (e.g., through displays, audio channels, speakers, touch-pads, etc.).

Applications 724 can include programs and/or modules that are configured to be executed by one or more processors 704. For example, if the digital assistant system is implemented on a standalone user device, applications 724 can include user applications, such as games, a calendar application, a navigation application, or an email application. If digital assistant system 700 is implemented on a server, applications 724 can include resource management applications, diagnostic applications, or scheduling applications, for example.

Memory 702 can also store digital assistant module 726 (or the server portion of a digital assistant). In some examples, digital assistant module 726 can include the following sub-modules, or a subset or superset thereof: input/output processing module 728, speech-to-text (STT) processing module 730, natural language processing module 732, dialogue flow processing module 734, task flow processing module 736, service processing module 738, and speech synthesis module 740. Each of these modules can have access to one or more of the following systems or data and models of the digital assistant module 726, or a subset or superset thereof: ontology 760, vocabulary index 744, user data 748, task flow models 754, service models 756, and ASR systems.

In some examples, using the processing modules, data, and models implemented in digital assistant module 726, the digital assistant can perform at least some of the following: converting speech input into text; identifying a user's intent expressed in a natural language input received from the user; actively eliciting and obtaining information needed to fully infer the user's intent (e.g., by disambiguating words, games, intentions, etc.); determining the task flow for fulfilling the inferred intent; and executing the task flow to fulfill the inferred intent.

In some examples, as shown in FIG. 7B, I/O processing module 728 can interact with the user through I/O devices 716 in FIG. 7A or with a user device (e.g., devices 104, 200, 400, or 600) through network communications interface 708 in FIG. 7A to obtain user input (e.g., a speech input) and to provide responses (e.g., as speech outputs) to the user input. I/O processing module 728 can optionally obtain contextual information associated with the user input from the user device, along with or shortly after the receipt of the user input. The contextual information can include user-specific data, vocabulary, and/or preferences relevant to the user input. In some examples, the contextual information also includes software and hardware states of the user device at the time the user request is received, and/or information related to the surrounding environment of the user at the time that the user request was received. In some examples, I/O processing module 728 can also send follow-up questions to, and receive answers from, the user regarding the user request. When a user request is received by I/O processing module 728 and the user request can include speech input, I/O processing module 728 can forward the speech input to STT processing module 730 (or speech recognizer) for speech-to-text conversions.

STT processing module 730 can include one or more ASR systems. The one or more ASR systems can process the speech input that is received through I/O processing module 728 to produce a recognition result. Each ASR system can include a front-end speech pre-processor. The front-end speech pre-processor can extract representative features from the speech input. For example, the front-end speech

pre-processor can perform a Fourier transform on the speech input to extract spectral features that characterize the speech input as a sequence of representative multi-dimensional vectors. Further, each ASR system can include one or more speech recognition models (e.g., acoustic models and/or language models) and can implement one or more speech recognition engines. Examples of speech recognition models can include Hidden Markov Models, Gaussian-Mixture Models, Deep Neural Network Models, n-gram language models, and other statistical models. Examples of speech recognition engines can include the dynamic time warping based engines and weighted finite-state transducers (WFST) based engines. The one or more speech recognition models and the one or more speech recognition engines can be used to process the extracted representative features of the front-end speech pre-processor to produce intermediate recognitions results (e.g., phonemes, phonemic strings, and sub-words), and ultimately, text recognition results (e.g., words, word strings, or sequence of tokens). In some examples, the speech input can be processed at least partially by a third-party service or on the user's device (e.g., device 104, 200, 400, or 600) to produce the recognition result. Once STT processing module 730 produces recognition results containing a text string (e.g., words, or sequence of words, or sequence of tokens), the recognition result can be passed to natural language processing module 732 for intent deduction.

More details on the speech-to-text processing are described in U.S. Utility application Ser. No. 13/236,942 for "Consolidating Speech Recognition Results," filed on Sep. 20, 2011, the entire disclosure of which is incorporated herein by reference.

In some examples, STT processing module 730 can include and/or access a vocabulary of recognizable words via phonetic alphabet conversion module 731. Each vocabulary word can be associated with one or more candidate pronunciations of the word represented in a speech recognition phonetic alphabet. In particular, the vocabulary of recognizable words can include a word that is associated with a plurality of candidate pronunciations. For example, the vocabulary may include the word "tomato" that is associated with the candidate pronunciations of /tə'meɪrʊs/ and /tə'matʊs/. Further, vocabulary words can be associated with custom candidate pronunciations that are based on previous speech inputs from the user. Such custom candidate pronunciations can be stored in STT processing module 730 and can be associated with a particular user via the user's profile on the device. In some examples, the candidate pronunciations for words can be determined based on the spelling of the word and one or more linguistic and/or phonetic rules. In some examples, the candidate pronunciations can be manually generated, e.g., based on known canonical pronunciations.

In some examples, the candidate pronunciations can be ranked based on the commonness of the candidate pronunciation. For example, the candidate pronunciation /tə'meɪrʊs/ can be ranked higher than /tə'matʊs/, because the former is a more commonly used pronunciation (e.g., among all users, for users in a particular geographical region, or for any other appropriate subset of users). In some examples, candidate pronunciations can be ranked based on whether the candidate pronunciation is a custom candidate pronunciation associated with the user. For example, custom candidate pronunciations can be ranked higher than canonical candidate pronunciations. This can be useful for recognizing proper nouns having a unique pronunciation that deviates from canonical pronunciation. In some examples,

candidate pronunciations can be associated with one or more speech characteristics, such as geographic origin, nationality, or ethnicity. For example, the candidate pronunciation /tə'meɪrʊs/ can be associated with the United States, whereas the candidate pronunciation /tə'matʊs/ can be associated with Great Britain. Further, the rank of the candidate pronunciation can be based on one or more characteristics (e.g., geographic origin, nationality, ethnicity, etc.) of the user stored in the user's profile on the device. For example, it can be determined from the user's profile that the user is associated with the United States. Based on the user being associated with the United States, the candidate pronunciation /tə'meɪrʊs/ (associated with the United States) can be ranked higher than the candidate pronunciation /tə'matʊs/ (associated with Great Britain). In some examples, one of the ranked candidate pronunciations can be selected as a predicted pronunciation (e.g., the most likely pronunciation).

When a speech input is received, STT processing module 730 can be used to determine the phonemes corresponding to the speech input (e.g., using an acoustic model), and then attempt to determine words that match the phonemes (e.g., using a language model). For example, if STT processing module 730 can first identify the sequence of phonemes /tə'meɪrʊs/ corresponding to a portion of the speech input, it can then determine, based on vocabulary index 744, that this sequence corresponds to the word "tomato."

In some examples, STT processing module 730 can use approximate matching techniques to determine words in an utterance. Thus, for example, the STT processing module 730 can determine that the sequence of phonemes /tə'meɪrʊs/ corresponds to the word "tomato," even if that particular sequence of phonemes is not one of the candidate sequence of phonemes for that word.

Natural language processing module 732 ("natural language processor") of the digital assistant can take the sequence of words or tokens ("token sequence") generated by STT processing module 730, and attempt to associate the token sequence with one or more "actionable intents" recognized by the digital assistant. An "actionable intent" can represent a task that can be performed by the digital assistant, and can have an associated task flow implemented in task flow models 754. The associated task flow can be a series of programmed actions and steps that the digital assistant takes in order to perform the task. The scope of a digital assistant's capabilities can be dependent on the number and variety of task flows that have been implemented and stored in task flow models 754, or in other words, on the number and variety of "actionable intents" that the digital assistant recognizes. The effectiveness of the digital assistant, however, can also be dependent on the assistant's ability to infer the correct "actionable intent(s)" from the user request expressed in natural language.

In some examples, in addition to the sequence of words or tokens obtained from STT processing module 730, natural language processing module 732 can also receive contextual information associated with the user request, e.g., from I/O processing module 728. The natural language processing module 732 can optionally use the contextual information to clarify, supplement, and/or further define the information contained in the token sequence received from STT processing module 730. The contextual information can include, for example, user preferences, hardware, and/or software states of the user device, sensor information collected before, during, or shortly after the user request, prior interactions (e.g., dialogue) between the digital assistant and the user, and the like. As described herein, contextual

information can be dynamic, and can change with time, location, content of the dialogue, and other factors.

In some examples, the natural language processing can be based on, e.g., ontology **760**. Ontology **760** can be a hierarchical structure containing many nodes, each node representing either an “actionable intent” or a “property” relevant to one or more of the “actionable intents” or other “properties.” As noted above, an “actionable intent” can represent a task that the digital assistant is capable of performing, i.e., it is “actionable” or can be acted on. A “property” can represent a parameter associated with an actionable intent or a sub-aspect of another property. A linkage between an actionable intent node and a property node in ontology **760** can define how a parameter represented by the property node pertains to the task represented by the actionable intent node.

In some examples, ontology **760** can be made up of actionable intent nodes and property nodes. Within ontology **760**, each actionable intent node can be linked to one or more property nodes either directly or through one or more intermediate property nodes. Similarly, each property node can be linked to one or more actionable intent nodes either directly or through one or more intermediate property nodes. For example, as shown in FIG. 7C, ontology **760** can include a “restaurant reservation” node (i.e., an actionable intent node). Property nodes “restaurant,” “date/time” (for the reservation), and “party size” can each be directly linked to the actionable intent node (i.e., the “restaurant reservation” node).

In addition, property nodes “cuisine,” “price range,” “phone number,” and “location” can be sub-nodes of the property node “restaurant,” and can each be linked to the “restaurant reservation” node (i.e., the actionable intent node) through the intermediate property node “restaurant.” For another example, as shown in FIG. 7C, ontology **760** can also include a “set reminder” node (i.e., another actionable intent node). Property nodes “date/time” (for setting the reminder) and “subject” (for the reminder) can each be linked to the “set reminder” node. Since the property “date/time” can be relevant to both the task of making a restaurant reservation and the task of setting a reminder, the property node “date/time” can be linked to both the “restaurant reservation” node and the “set reminder” node in ontology **760**.

An actionable intent node, along with its linked concept nodes, can be described as a “domain.” In the present discussion, each domain can be associated with a respective actionable intent, and refers to the group of nodes (and the relationships there between) associated with the particular actionable intent. For example, ontology **760** shown in FIG. 7C can include an example of restaurant reservation domain **762** and an example of reminder domain **764** within ontology **760**. The restaurant reservation domain includes the actionable intent node “restaurant reservation,” property nodes “restaurant,” “date/time,” and “party size,” and sub-property nodes “cuisine,” “price range,” “phone number,” and “location.” Reminder domain **764** can include the actionable intent node “set reminder,” and property nodes “subject” and “date/time.” In some examples, ontology **760** can be made up of many domains. Each domain can share one or more property nodes with one or more other domains. For example, the “date/time” property node can be associated with many different domains (e.g., a scheduling domain, a travel reservation domain, a movie ticket domain, etc.), in addition to restaurant reservation domain **762** and reminder domain **764**.

While FIG. 7C illustrates two example domains within ontology **760**, other domains can include, for example, “find

a movie,” “initiate a phone call,” “find directions,” “schedule a meeting,” “send a message,” and “provide an answer to a question,” “read a list,” “providing navigation instructions,” “provide instructions for a task” and so on. A “send a message” domain can be associated with a “send a message” actionable intent node, and may further include property nodes such as “recipient(s),” “message type,” and “message body.” The property node “recipient” can be further defined, for example, by the sub-property nodes such as “recipient name” and “message address.”

In some examples, ontology **760** can include all the domains (and hence actionable intents) that the digital assistant is capable of understanding and acting upon. In some examples, ontology **760** can be modified, such as by adding or removing entire domains or nodes, or by modifying relationships between the nodes within the ontology **760**.

In some examples, nodes associated with multiple related actionable intents can be clustered under a “super domain” in ontology **760**. For example, a “travel” super-domain can include a cluster of property nodes and actionable intent nodes related to travel. The actionable intent nodes related to travel can include “airline reservation,” “hotel reservation,” “car rental,” “get directions,” “find points of interest,” and so on. The actionable intent nodes under the same super domain (e.g., the “travel” super domain) can have many property nodes in common. For example, the actionable intent nodes for “airline reservation,” “hotel reservation,” “car rental,” “get directions,” and “find points of interest” can share one or more of the property nodes “start location,” “destination,” “departure date/time,” “arrival date/time,” and “party size.”

In some examples, each node in ontology **760** can be associated with a set of words and/or phrases that are relevant to the property or actionable intent represented by the node. The respective set of words and/or phrases associated with each node can be the so-called “vocabulary” associated with the node. The respective set of words and/or phrases associated with each node can be stored in vocabulary index **744** in association with the property or actionable intent represented by the node. For example, returning to FIG. 7B, the vocabulary associated with the node for the property of “restaurant” can include words such as “food,” “drinks,” “cuisine,” “hungry,” “eat,” “pizza,” “fast food,” “meal,” and so on. For another example, the vocabulary associated with the node for the actionable intent of “initiate a phone call” can include words and phrases such as “call,” “phone,” “dial,” “ring,” “call this number,” “make a call to,” and so on. The vocabulary index **744** can optionally include words and phrases in different languages.

Natural language processing module **732** can receive the token sequence (e.g., a text string) from STT processing module **730**, and determine what nodes are implicated by the words in the token sequence. In some examples, if a word or phrase in the token sequence is found to be associated with one or more nodes in ontology **760** (via vocabulary index **744**), the word or phrase can “trigger” or “activate” those nodes. Based on the quantity and/or relative importance of the activated nodes, natural language processing module **732** can select one of the actionable intents as the task that the user intended the digital assistant to perform. In some examples, the domain that has the most “triggered” nodes can be selected. In some examples, the domain having the highest confidence value (e.g., based on the relative importance of its various triggered nodes) can be selected. In some examples, the domain can be selected based on a combination of the number and the importance of the triggered

nodes. In some examples, additional factors are considered in selecting the node as well, such as whether the digital assistant has previously correctly interpreted a similar request from a user.

User data **748** can include user-specific information, such as user-specific vocabulary, user preferences, user address, user's default and secondary languages, user's contact list, and other short-term or long-term information for each user. In some examples, natural language processing module **732** can use the user-specific information to supplement the information contained in the user input to further define the user intent. For example, for a user request "invite my friends to my birthday party," natural language processing module **732** can be able to access user data **748** to determine who the "friends" are and when and where the "birthday party" would be held, rather than requiring the user to provide such information explicitly in his/her request.

Other details of searching an ontology based on a token string is described in U.S. Utility application Ser. No. 12/341,743 for "Method and Apparatus for Searching Using An Active Ontology," filed Dec. 22, 2008, the entire disclosure of which is incorporated herein by reference.

In some examples, once natural language processing module **732** identifies an actionable intent (or domain) based on the user request, natural language processing module **732** can generate a structured query to represent the identified actionable intent. In some examples, the structured query can include parameters for one or more nodes within the domain for the actionable intent, and at least some of the parameters are populated with the specific information and requirements specified in the user request. For example, the user may say "Make me a dinner reservation at a sushi place at 7." In this case, natural language processing module **732** can be able to correctly identify the actionable intent to be "restaurant reservation" based on the user input. According to the ontology, a structured query for a "restaurant reservation" domain may include parameters such as {Cuisine}, {Time}, {Date}, {Party Size}, and the like. In some examples, based on the speech input and the text derived from the speech input using STT processing module **730**, natural language processing module **732** can generate a partial structured query for the restaurant reservation domain, where the partial structured query includes the parameters {Cuisine="Sushi"} and {Time="7 pm"}. However, in this example, the user's utterance contains insufficient information to complete the structured query associated with the domain. Therefore, other necessary parameters such as {Party Size} and {Date} may not be specified in the structured query based on the information currently available. In some examples, natural language processing module **732** can populate some parameters of the structured query with received contextual information. For example, in some examples, if the user requested a sushi restaurant "near me," natural language processing module **732** can populate a {location} parameter in the structured query with GPS coordinates from the user device.

In some examples, natural language processing module **732** can pass the generated structured query (including any completed parameters) to task flow processing module **736** ("task flow processor"). Task flow processing module **736** can be configured to receive the structured query from natural language processing module **732**, complete the structured query, if necessary, and perform the actions required to "complete" the user's ultimate request. In some examples, the various procedures necessary to complete these tasks can be provided in task flow models **754**. In some examples, task flow models **754** can include procedures for obtaining

additional information from the user and task flows for performing actions associated with the actionable intent.

As described above, in order to complete a structured query, task flow processing module **736** may need to initiate additional dialogue with the user in order to obtain additional information, and/or disambiguate potentially ambiguous utterances. When such interactions are necessary, task flow processing module **736** can invoke dialogue flow processing module **734** to engage in a dialogue with the user. In some examples, dialogue flow processing module **734** can determine how (and/or when) to ask the user for the additional information and receives and processes the user responses. The questions can be provided to and answers can be received from the users through I/O processing module **728**. In some examples, dialogue flow processing module **734** can present dialogue output to the user via audio and/or visual output, and receives input from the user via spoken or physical (e.g., clicking) responses. Continuing with the example above, when task flow processing module **736** invokes dialogue flow processing module **734** to determine the "party size" and "date" information for the structured query associated with the domain "restaurant reservation," dialogue flow processing module **734** can generate questions such as "For how many people?" and "On which day?" to pass to the user. Once answers are received from the user, dialogue flow processing module **734** can then populate the structured query with the missing information, or pass the information to task flow processing module **736** to complete the missing information from the structured query.

Once task flow processing module **736** has completed the structured query for an actionable intent, task flow processing module **736** can proceed to perform the ultimate task associated with the actionable intent. Accordingly, task flow processing module **736** can execute the steps and instructions in the task flow model according to the specific parameters contained in the structured query. For example, the task flow model for the actionable intent of "restaurant reservation" can include steps and instructions for contacting a restaurant and actually requesting a reservation for a particular party size at a particular time. For example, using a structured query such as: {restaurant reservation, restaurant=ABC Café, date=3/12/2012, time=7 pm, party size=5}, task flow processing module **736** can perform the steps of: (1) logging onto a server of the ABC Café or a restaurant reservation system such as OPENTABLE®, (2) entering the date, time, and party size information in a form on the website, (3) submitting the form, and (4) making a calendar entry for the reservation in the user's calendar.

In some examples, task flow processing module **736** can employ the assistance of service processing module **738** ("service processing module") to complete a task requested in the user input or to provide an informational answer requested in the user input. For example, service processing module **738** can act on behalf of task flow processing module **736** to make a phone call, set a calendar entry, invoke a map search, invoke or interact with other user applications installed on the user device, and invoke or interact with third-party services (e.g., a restaurant reservation portal, a social networking website, a banking portal, etc.). In some examples, the protocols and application programming interfaces (API) required by each service can be specified by a respective service model among service models **756**. Service processing module **738** can access the appropriate service model for a service and generate requests for the service in accordance with the protocols and APIs required by the service according to the service model.

For example, if a restaurant has enabled an online reservation service, the restaurant can submit a service model specifying the necessary parameters for making a reservation and the APIs for communicating the values of the necessary parameter to the online reservation service. When requested by task flow processing module 736, service processing module 738 can establish a network connection with the online reservation service using the web address stored in the service model, and send the necessary parameters of the reservation (e.g., time, date, party size) to the online reservation interface in a format according to the API of the online reservation service.

In some examples, natural language processing module 732, dialogue flow processing module 734, and task flow processing module 736 can be used collectively and iteratively to infer and define the user's intent, obtain information to further clarify and refine the user intent, and finally generate a response (i.e., an output to the user, or the completion of a task) to fulfill the user's intent. The generated response can be a dialogue response to the speech input that at least partially fulfills the user's intent. Further, in some examples, the generated response can be output as a speech output. In these examples, the generated response can be sent to speech synthesis module 740 (e.g., speech synthesizer) where it can be processed to synthesize the dialogue response in speech form. In yet other examples, the generated response can be data content relevant to satisfying a user request in the speech input.

Speech synthesis module 740 can be configured to synthesize speech outputs for presentation to the user. Speech synthesis module 740 synthesizes speech outputs based on text provided by the digital assistant. For example, the generated dialogue response can be in the form of a text string. Speech synthesis module 740 can convert the text string to an audible speech output. Speech synthesis module 740 can use any appropriate speech synthesis technique in order to generate speech outputs from text, including, but not limited, to concatenative synthesis, unit selection synthesis, diphone synthesis, domain-specific synthesis, formant synthesis, articulatory synthesis, hidden Markov model (HMM) based synthesis, and sinewave synthesis. In some examples, speech synthesis module 740 can be configured to synthesize individual words based on phonemic strings corresponding to the words. For example, a phonemic string can be associated with a word in the generated dialogue response. The phonemic string can be stored in metadata associated with the word. Speech synthesis model 740 can be configured to directly process the phonemic string in the metadata to synthesize the word in speech form.

In some examples, instead of (or in addition to) using speech synthesis module 740, speech synthesis can be performed on a remote device (e.g., the server system 108), and the synthesized speech can be sent to the user device for output to the user. For example, this can occur in some implementations where outputs for a digital assistant are generated at a server system. And because server systems generally have more processing power or resources than a user device, it can be possible to obtain higher quality speech outputs than would be practical with client-side synthesis.

Additional details on digital assistants can be found in the U.S. Utility application Ser. No. 12/987,982, entitled "Intelligent Automated Assistant," filed Jan. 10, 2011, and U.S. Utility application Ser. No. 13/251,088, entitled "Generating and Processing Task Items That Represent Tasks to Perform," filed Sep. 30, 2011, the entire disclosures of which are incorporated herein by reference.

4. Exemplary Techniques for Natural Voice Interaction

FIGS. 8A-D, 9A-G, 10A-G illustrate exemplary processes for operating an intelligent automated assistant according to various examples. These figures are also used to illustrate the processes described below, including the processes in FIGS. 11A-B, 12A-B, and 13A-B.

FIG. 8A shows electronic device 800. Electronic device 800 may be any of devices 104, 122, 200, 400, 600, 900, 1000, 1400, 1500, and 1600 (FIGS. 1, 2A, 3, 4, 5A, 6A-6B, 9A-G, 10A-G, 14-16) in some embodiments. In the illustrated example, the electronic device 800 is a speaker, though it will be appreciated that the electronic device may be a device of any type, such as a phone, laptop, desktop, tablet, wearable device (e.g., smart watch), set-top box, home electronics including televisions, or any combination or subcombination thereof.

In operation, the electronic device 800 provides for the exchange of natural language speech between a user and an intelligent automated assistant. In some examples, the exchange is purely auditory. In some examples, the exchange is additionally or alternatively visual (e.g., by way of graphical user interface).

In FIG. 8A, the electronic device 800 receives (e.g., via a microphone) a natural language speech input 810 directed to an automated assistant of the electronic device 800. In some examples, the natural language speech input is indicative of content. In the depicted example, the natural language speech input 810 ("HEY SIRI, PLAY A BEATLES SONG") is indicative of media content (e.g., "A BEATLES SONG"). Content, as described herein, can include any type of information that can be consumed by a human user. Exemplary content includes, but is not limited to, contact information (e.g., phone numbers addresses), media items (e.g., songs, movies, TV episodes, textual/audio books), places of interest, persons of interest, events of interest, or any combination thereof.

In some examples, the natural language speech input includes a user request for retrieving and/or presenting content. In some examples, for instance, the natural language speech input includes one or more parameters (e.g., name, artist, location, media type) that may be used to identify and/or retrieve the content. With reference to FIG. 8A, user 802 provides a natural language speech input 810 that specifies an artist ("BEATLES") and a media type ("SONG"). Additional exemplary natural language speech inputs indicative of content include "HEY SIRI, FIND ME RESTAURANTS AROUND CUPERTINO", "READ ME HARRY POTTER AND THE SORCERER'S STONE", and "WHAT IS THE WEATHER OUT THERE".

As shown in FIG. 8B, the electronic device 800 provides (e.g., via a speaker) an audio output 812, for instance, in response to the natural language speech input. In some examples, the audio output includes synthesized speech of the automated assistant of the electronic device 800. The audio output includes a plurality of formats in which the content may be presented. Exemplary formats for presenting content include, but are not limited to: the content in its entirety, a summary of the content, a portion of the content, a paraphrase of the content, or any combination thereof. In the depicted example in FIG. 8B, the electronic device 800 provides, via audio output 812, "DO YOU WANT ME TO PROVIDE THE SONG NAMES, SUMMARIES OF THE ALBUMS, LENGTH OF THE ALBUMS, OR SOMETHING ELSE?"

In some examples, the electronic device 800 identifies the plurality of formats based on context information. Context information includes, but is not limited to: the type of the

content (e.g., song, book, place of interest), the size of the content (e.g., number of pages, playback time), information associated with the content (e.g., metadata, summaries), the type of the electronic device (e.g., whether the device is a device having a display), environmental factors associated with the device (e.g., whether the device is moving), user preferences, or a combination thereof. In the depicted example in FIG. 8B, as the user has asked the electronic device **800** to play a song, the formats presented include “SONG NAMES”, “ALBUM NAMES”, and “SUMMARIES OF THE ALBUMS”. As another example, if the user has asked the electronic device **800** to read a book, the formats presented can include “CHAPTER NAMES” and “VOLUME NAMES”.

In some examples, the electronic device **800** selectively provides an audio output based on a type of the content and/or a device type of the electronic device **800**. By way of example, if the content is video and the electronic device **800** is a speaker, the electronic device may forgo providing an audio output. Instead, the electronic device **800** may indicate to the user that the content will not be provided.

In some examples, the audio output further includes information describing the content. The information describing the content can be helpful in allowing a user to select a format for the content, as described below. In some examples, the information describing the content includes information indicative of a size of the content (e.g., number of pages, time for a complete playback, number of items). In the depicted example, the audio output **812** (“I FOUND 275 SONGS AND 12 ALBUMS”) includes a number of songs and a number of music albums.

In some examples, the electronic device **800** indicates (e.g., via the audio output or an additional, separate audio output) that the user can specify a format that is not included in the first audio output (e.g., **812**; “OR SOMETHING ELSE?”). In some examples, the electronic device **800** provides (e.g., via the first audio output or a separate audio output) one or more exemplary inputs for selecting a format, such as “YOU CAN SAY, ‘JUST THE SUMMARIES’” (not depicted).

Turning to FIG. 8C, the electronic device **800** receives (e.g., via a microphone) a natural language speech input **814** indicative of a selection of a format of the plurality of formats. In the depicted example, the electronic device **800** receives the natural language speech input **814** (“READ THE ALBUM NAMES”) from the user **802**.

In FIG. 8D, the electronic device **800** provides (e.g., via a speaker) an audio output **817** including the content in the selected format. In the depicted example, the audio output **817** includes names of Beatles albums (“LET IT BE, ABBEY ROAD,”) in accordance with the natural language speech input **814** (“READ THE ALBUM NAMES”).

In some examples, the electronic device **800** provides (e.g., via a speaker) an audio output **816** before providing the audio output **817**. In some examples, the audio output **816** indicates that the audio input **817** can be interrupted. As illustrated, for instance, the audio output **816** (“OK. YOU CAN INTERRUPT ME ANY TIME”) indicates that the user can interrupt while the electronic device **800** provides the audio output **817**. Additional exemplary audio outputs include, but are not limited to: “TELL ME WHEN YOU HEAR SOMETHING YOU LIKE”, “TELL ME IF YOU WANT TO KNOW MORE ABOUT ANY OF THEM”, and “LET ME KNOW IF YOU HAVE ANY QUESTIONS.” Various exemplary processes and mechanism for handling a user’s barge-in inputs are provided in more details below.

In some examples, the electronic device **800** receives a user request to repeat an audio output. In response, the electronic device **800** provides an adjusted audio output different from the audio output. In some examples, the adjusted audio output includes the same content of the audio output, but is provided using a different manner of playback. By way of example, the adjusted audio output is provided at a different rate (e.g., slower), at a different volume (e.g., louder), and/or in a different language than the audio output. For example, if the previous audio output includes a spelling of a word (e.g., “A-P-P-L-E”), the adjusted audio output repeats the same spelling at a slower rate. In some examples, the adjusted audio output includes the same content of the audio output **816** as well as additional information. As another example, if the audio output includes a name of a business, such as a restaurant (e.g., “CAFFE MACS”), the adjusted audio output includes both the business name and a location of the business (e.g., “CAFFE MACS IN CUPERTINO”). In some examples, the manner in which the playback is adjusted depends on a domain of a current voice interaction. For example, if the audio output is associated with a first domain (e.g., spelling), playback may be adjusted in a first manner (e.g., slower playback). If the audio output is associated with a second domain (e.g., search), playback may be adjusted in a second manner (e.g., additional information added). In some examples, the electronic device **800** provides an audio output asking the user whether he or she needs help.

FIG. 9A shows electronic device **900**. Electronic device **900** may be any of devices **104**, **122**, **200**, **400**, **600**, **800**, **1000**, **1400**, **1500**, and **1600** (FIGS. 1, 2A, 3, 4, 5A, 6A-6B, 8A-D, 10A-G, 14-16) in some embodiments. In the illustrated example, the electronic device **900** is a speaker, though it will be appreciated that the electronic device may be a device of any type, such as a phone, laptop, desktop, tablet, wearable device (e.g., smart watch), set-top box, home electronics including televisions, or any combination or subcombination thereof.

In FIG. 9A, the electronic device **900** provides (e.g., via a speaker of the electronic device), an audio output **918**. In some examples, the audio output includes synthesized speech of an automated assistant of the electronic device **900**. In some examples, the audio output is indicative of a list of items and/or includes content.

With reference to FIG. 9A, the electronic device **900** provides the audio output **918** indicative of a list of items. In the depicted example, the audio output **918** (“LET IT BE, ABBEY ROAD, THE BEATL . . .”) is indicative of a list of album names. In some examples, the electronic device **900** provides the audio output responsive to processing a natural language speech input, as described with respect to FIGS. 8A-D. In some examples, electronic device **900** indicates (e.g., via the speaker) to the user that the audio output can be interrupted before starting to provide the audio output, similar to the audio output **817** discussed with respect to FIG. 8D.

In FIG. 9B, while providing the audio output **918**, the electronic device **900** receives (e.g., via a microphone of the electronic device) a natural language speech input **922** (“LET’S PLAY THAT ONE”). In the depicted example, the electronic device **900** is in the middle of reciting a list of album names, specifically in the middle of reciting the album name “BEATLES” when receiving the natural language speech input **922**.

In response to receiving the natural language speech input **922**, the electronic device **900** derives a representation of user intent based on the natural language speech input and

the audio output. For instance, in some examples, the electronic device 900 identifies a portion of the content of the audio output in response to receipt of the natural language speech input and derives a representation of user intent based on the identified portion of the content and the natural language speech input 922. In some examples, the electronic device 900 selects a portion of the audio output (e.g., “THE BEATL”) that is provided at a time the natural language speech input 922 is received. In some examples, the electronic device 900 selects a portion of the audio output (e.g., “ABBEY ROAD”) that is provided at a time before the natural language speech input 922 is received.

In some examples, the electronic device 900 identifies one or more parameters associated with the representation of user intent based on the selected portion of the audio output. In some examples, the audio output is indicative of a list of items (e.g., list of media items, list of places of interest, list of persons of interest), and the selected portion of the audio output is indicative of an item of the list (e.g., a media item, a place of interest, a person of interest). In the depicted example in FIG. 9B, for instance, the audio output 920 (“LET IT BE, ABBEY ROAD, THE BEATL”) is indicative of a list of media items, and the selected portion of the audio output 920 is indicative of a media item of the list of media items (e.g., an album named “THE BEATLES”).

In FIG. 9C, based on the derived representation of user intent, the electronic device 900 identifies a task and performs the identified task. In some examples, the electronic device 900 further identifies one or more parameters associated with the task and performs the task using the one or more parameters. In some examples, the one or more parameters associated with the task are based on the one or more parameters associated with the representation of user intent. In the depicted example in FIG. 9C, the electronic device 900 identifies a task of performing playback of a media item and a parameter associated with the task “THE BEATLES”. As such, the electronic device 900 performs a playback 924 of the “BEATLES” album. As another example, if the electronic device 900 is reading a list of places of interest (e.g., restaurants) when receiving a natural language speech input (“Directions to there”), the electronic device can provide information (e.g., navigation details) associated with a particular place of interest identified from the list.

With reference to FIG. 9D, while performing playback of media content (e.g., 926; the “BEATLES” album), the electronic device 900 receives another natural language speech input 928. In some examples, the natural language speech input is directed to a manner in which the electronic device 800 provides playback of media content (e.g., 928; “TURN IT UP”). In some examples, the electronic device 900 processes the natural language speech input in a manner similar to that discussed with respect to FIGS. 9A-C. For example, the electronic device 900 derives a representation of user intent (e.g., interprets “IT” as referring to the current playback of the “BEATLES” album) based on audio output of the electronic device.

As shown in FIG. 9E, the electronic device 900 adjusts playback of the media content in response to the natural language speech input 928. In some examples, the electronic device 900 adjusts a volume of the speaker of the electronic device. The electronic device may, for instance, increase volume (e.g., in response to the user input 928 “TURN IT UP”) or decrease volume (e.g., in response to the user input “QUIETER”). In other examples, the electronic device 900 pauses playback of the media content (e.g., in response to the user input “PAUSE IT NOW”). In yet other examples,

the electronic device 900 performs playback of different media content. The electronic device 900 may for instance, switch to a different song of a selected artist or album (e.g., in response to the user input “SKIP THIS ONE”).

In FIG. 9F, while performing playback of media content (e.g., 926; the “BEATLES” album), the electronic device 900 receives natural language speech input 934 (“HEY SIRI, WHAT TIME IS IT NOW?”).

In FIG. 9G, in response to receiving the natural language speech input 934, the electronic device 900 attenuates the audio output 932. In the depicted example in FIG. 9G, the electronic device 900 continues to perform playback of “THE BEATLES” album, but in a blurred manner. This way, the electronic device makes the response (936; “IT’S 2 PM”) to the natural language speech input 934 easier to hear for user 902.

In some examples, the electronic device 900 attenuates the audio output by adjusting the audio output. For example, the electronic device 900 can blur the audio output, provide the audio output at a different (e.g., lower) volume, and/or provide the audio output at a different (e.g., lower) rate. In some examples, the electronic device 900 attenuates the current audio output by ceasing to provide the current audio output.

In some examples, the electronic device 900 attenuates the audio output in different manners depending on characteristics of the audio output (e.g., type, volume, metadata). In some examples, in response to receiving the natural language speech input (e.g., 934), the electronic device 900 determines a type of the audio output. In response to a determination that the audio output is of a first type (e.g., song), the electronic device 900 adjusts playback of the audio output. In response to a determination that the audio output of a second type different from the first type (e.g., synthesized speech of the automated assistant), the electronic device 900 ceases to provide the audio output.

In some examples, the electronic device 900 attenuates the audio output in response to detection of a spoken trigger (e.g., “Hey Siri”) in the natural language speech input 934. In some examples, the electronic device 900 attenuates the audio output in response to determining that the user has finished providing the natural language speech input (e.g., 934). In some examples, the electronic device 900 attenuates the audio output when responding (e.g., providing requested results) to the natural language speech input (e.g., 934).

It will be appreciated that electronic device 900 can attenuate an audio output in response to receiving the natural language speech input 922 (“LET’S PLAY THAT ONE”; FIG. 9A) and/or the natural language speech input 928 (“TURN IT UP”; FIG. 9D) in similar manners as discussed with respect to the natural language speech input 934.

FIG. 10A shows an electronic device 1000. Electronic device 1000 may be any of devices 104, 122, 200, 400, 600, 800, 900, 1400, 1500, and 1600 (FIGS. 1, 2A, 3, 4, 5A, 6A-6B, 8A-D, 9A-G, 14-16) in some embodiments. In the illustrated example, the electronic device 1000 is a speaker, though it will be appreciated that the electronic device may be a device of any type, such as a phone, laptop, desktop, tablet, wearable device (e.g., smart watch), set-top box, home electronics including televisions, or any combination or subcombination thereof.

In FIG. 10A, the electronic device 1000 samples (e.g., via a microphone of the electronic device), an audio input 1038 including a spoken trigger (e.g., “HEY SIRI”). In some examples, the spoken trigger is configured to invoke an automated assistant of the electronic device.

In FIG. 10B, in response to sampling the audio input **1038**, the electronic device **1000** provides (e.g., via a speaker of the electronic device) an audio output **1040** indicative of a state of the automated assistant. In some examples, the audio output is indicative of an active state (e.g., triggered or invoked) of the automated assistant. In some examples, when the automated assistant is in the active state, the electronic device interprets any sampled audio inputs (with or without the spoken trigger) as being directed to the automated assistant. In some examples, when in the active state, the automated assistant maintains context for a current user session.

In some examples, the audio output is a continuous sound, a sound of a single note, white noise, a sound of running water, or a combination thereof. In some examples, the electronic device **1000** gradually attenuates the audio output over a period of time. For instance, the electronic device **1000** may continuously decrease volume and/or rate of playback of the audio output during a user session. In the depicted example in FIG. 10B, the audio output **1040** includes a continuous white noise.

In some examples, while providing the audio output, the electronic device **1000** provides another separate audio output indicative of an acknowledgement of the spoken trigger. The audio output indicative of an acknowledgement of the spoken trigger can be verbal (e.g., “YOU RANG?”) or non-verbal (e.g., a beep). In the example of FIG. 10B, the electronic device **1000** provides audio output **1042** (“MM-HMM?”) to indicate an acknowledgement of the spoken trigger (e.g., “HEY SIRI”). The electronic device **1000** provides the audio output **1040** while simultaneously providing audio output **1040** in some examples.

Further operation of the electronic device **1000** is described with reference to FIGS. 10C-G. In some examples, the electronic device **800** may continue to provide the audio output **1040** during operation pertaining to one or more of FIGS. 10C-G.

With reference to FIG. 10C, the electronic device **1000** receives a natural language speech input **1044**. In the depicted example, the natural language speech input **1044** includes a user request “WHAT’S THE WEATHER OUTSIDE?” In some examples, the audio input **1038** and the natural language speech input **1044** are parts of the same audio input (e.g., “HEY SIRI, WHAT’S THE WEATHER OUTSIDE?”).

In FIG. 10D, the electronic device **1000** derives a representation of user intent based on the natural language speech input **1044**. In the depicted example, the electronic device **1000** derives a representation of user intent (i.e., providing a current time) based on the natural language speech input **1044**.

In some examples, the electronic device **1000** provides a separate audio output indicative of an ongoing processing of a user request. The audio output indicative of an ongoing processing of a user request can be verbal (e.g., “LET ME SEE”) or non-verbal (e.g., a woodpecker pecking sound). In the depicted example, the electronic device **1000** provides audio output **1046** (“HMMM”) to indicate an ongoing processing of the natural language speech input **1044** (e.g., “WHAT’S THE WEATHER OUTSIDE?”).

In FIG. 10E, the electronic device **1000** performs a task and provides one or more results based on the performed task. In the depicted example, the electronic device **1000** obtains weather information and provides an audio output **1048** (“IT’S 70 HERE IN CUPERTINO”).

In some examples, the automated assistant of the electronic device **1000** enters an inactive state after a passage of

a predefined period of time after providing the one or more results. In some examples, when the automated assistant is in an inactive state, the electronic device **1000** ceases to provide the audio output **1040**. For instance, as described with reference to FIG. 10B, the electronic device **1000** provides an output **1040** in response to receipt of the natural language speech input **1038** and may continue to provide the audio output **1040** during operation to indicate that the automated assistant remains in an active state. However, the electronic device **1000** can cease to provide the audio output **1040** after the electronic device provides results, for instance, as described with respect to FIG. 10E.

After the automated assistant transitions from an active state to an inactive state, the electronic device **1000** may receive an audio input that does not include a spoken trigger within a predefined period of time following the transition. In some examples, in response, the electronic device **1000** can process the audio input as if the audio input does include a spoken trigger.

For instance, with reference to FIG. 10F, the electronic device **1000**, after performing the task (e.g., obtaining weather information), receives a second audio input (e.g., **1052**; “WHAT ABOUT SAN FRANCISCO?”). Notably, the second audio input (e.g., **1052**) does not include a spoken trigger (e.g., “HEY SIRI”).

As described, the electronic device **1000** determines context associated with the user, the current user interaction, and/or the current user session in some examples. Based on the context and the second audio input, the electronic device derives a representation of a second user intent. The context can be determined either prior to or after the receipt of the second audio input. As discussed above with respect of FIGS. 2A-B and 7A-C, the context can include prior interactions (e.g., previous inputs, previously derived user intents, previously identified task, or a combination thereof) between the automated assistant and the user. In the depicted example, the electronic device **1000** interprets the second audio input as a request to the automated assistant for weather information (based on the previous audio input **1044**) in San Francisco.

In FIG. 10G, the electronic device **1000** performs a second task based on the second representation of the user intent and provides one or more results based on the performed second task. Specifically, the electronic device **1000** provides an audio output **1054** (“IT’S 65 RIGHT NOW IN SAN FRANCISCO.”).

The electronic device **1000** can adjust its audio outputs based on contextual information. In some examples, after sampling (e.g., via a microphone) an audio input (e.g., **1038**; “HEY SIRI”), the electronic device determines a current context before providing an audio response. In some examples, the current context includes a current time, a current location, sensor information (e.g., lighting, ambient noise, ambient temperature, images or videos of the surrounding environment), physical state of the device (power level, motion patterns, speed), etc.

In some examples, the electronic device **1000** adjusts the audio output based on the determined current context. For example, if the electronic device **1000** determines that the current time is midnight and the user has last set the volume level at noon, the electronic device **1000** can reduce the volume of the audio output.

5. Exemplary Processes for Operating Intelligent Automated Assistant

FIGS. 11A-B illustrate a flow diagram of an exemplary process **1100** for operating an automated assistant in accordance with some embodiments. The process **1100** may be

performed using one or more devices **104**, **122**, **200**, **400**, **600**, **800**, and **1400** (FIGS. **1**, **2A**, **4**, **6A-B**, **8A-C**, and **14**). Operations in process **1100** are, optionally, combined and/or the order of some operations is, optionally, changed.

At block **1102**, the electronic device provides an audio output using a speaker of the electronic device. In some examples, providing the audio output comprises providing a speech output indicative of a list of items. In some examples, providing the audio output comprises performing playback of media content. In some examples, before providing the audio output, the electronic device provides a second audio output.

In some examples, the electronic device attenuates the audio output in response to receiving the natural language speech input. In some examples, the electronic device ceases providing the audio output in response to receiving the natural language speech input.

In some examples, the electronic device determines a type of the audio output in response to receiving the natural language speech input. The electronic device adjusts the audio output in response to a determination that the audio output is of a first type. The electronic device ceases providing the audio output in response to a determination that the audio output is of a second type different from the first type.

At block **1104**, while providing the audio output, the electronic device receives a natural language speech input using a microphone of the electronic device.

In some examples, the electronic device identifies a portion of the audio input in response to receipt of the natural language speech input. In some examples, the portion of the audio output is indicative of an item of a list of items. In some examples, the item is a media item. In some examples, the item is a location.

At block **1106**, the electronic device derives a representation of user intent based on the natural language speech input and the audio output.

At block **1108**, the electronic device identifies a task based on the derived user intent.

At block **1110**, the electronic device performs the task. In some examples, performing the task includes performing playback of the media item with the speaker of the electronic device. In some examples, performing the task includes providing information associated with the location with the speaker of the electronic device. In some examples, performing the task comprises adjusting playback of the media content. Adjusting playback of the media content may comprise adjusting a volume of the speaker of the electronic device or may comprise pausing playback of the media content.

In some examples, the electronic device identifies one or more parameters associated with the task based on a portion of the audio output. In some examples, performing the task includes performing the task based on the identified one or more parameters.

FIGS. **12A-B** illustrate a flow diagram of an exemplary process **1200** for operating automated assistant in accordance with some embodiments. The process **1200** may be performed using one or more devices **104**, **122**, **200**, **400**, **600**, **800**, and **1500** (FIGS. **1**, **2A**, **4**, **6A-B**, **8A-C**, and **15**). Operations in process **1200** are, optionally, combined and/or the order of some operations is, optionally, changed.

At block **1202**, the electronic device samples an audio input using a microphone of the electronic device. The audio input comprises a spoken trigger in some examples.

At block **1204**, the electronic device provides an audio output indicative of a state of the automated assistant using

a speaker of the electronic device in response to sampling the audio input. In some examples, the audio output is indicative of an active state of the automated assistant. In some examples, the audio output is a continuous sound, white noise, and/or the sound of running water. In some examples, providing the audio output comprises attenuating the audio output over a period of time. In some examples, while providing the audio output, the electronic device provides a second audio output indicative of an ongoing processing of a user request, a third audio output indicative of a completed processing of a user request, a fourth audio output indicative of an acknowledgement of the spoken trigger, and/or a fifth audio output indicative of an error. In some examples, after sampling the audio input, the electronic device determines a current context and adjusts the audio output based on the determined current context. In some examples, the audio output indicative of a state of the automated assistant is based on a type of the electronic device.

At block **1206**, while providing the audio output indicative of a state of the automated assistant, the electronic device receives a natural language speech input and derives a representation of user intent based on the natural language speech input.

At block **1208**, the electronic device performs a task based on the user intent. In some examples, performing the task based on the user intent includes performing the task based on the user intent while providing the audio output indicative of a state of the automated assistant.

In some examples, the electronic device outputs one or more results based on the performed task using the speaker of the electronic device while providing the audio output indicative of a state of the automated assistant.

In some examples, after providing the one or more results based on the performed task, the electronic device ceases to provide the audio output indicative of a state of the automated assistant after passage of a predefined period of time.

In some examples, the electronic device determines a user context, and after performing the task, receives a second audio input that does not comprise a spoken trigger. The electronic device derives a representation of a second user intent based on the second audio input and the user context and performs a second task based on the second user intent. In some examples, the user context is based on the natural language speech input, the user intent, the task, or a combination thereof.

FIGS. **13A-B** illustrate a flow diagram of an exemplary process **1300** for operating automated assistant in accordance with some embodiments. The process **1300** may be performed using one or more devices **104**, **122**, **200**, **400**, **600**, **800**, and **1600** (FIGS. **1**, **2A**, **4**, **6A-B**, **8A-C**, and **16**). Operations in process **1300** are, optionally, combined and/or the order of some operations is, optionally, changed.

At block **1302**, the electronic device receives a first natural language speech input indicative of content.

At block **1304**, the electronic device provides a first audio output using a speaker of the electronic device. The audio output comprises a plurality of formats for presenting the content. In some examples, the first audio input comprises information describing the content. In some examples, the information describing the content comprises information indicative of a size of the content. In some examples, the first audio input is based on context information. In some examples, the context information is based on a type of the electronic device. In some examples, the plurality of formats comprises one or more of an entirety of the content, a summary of the content, a portion of the content, a para-

phrase of the content, or a combination thereof. In some examples, the first audio output further comprises one or more exemplary inputs.

At block **1306**, the electronic device receives a second natural language speech input indicative of a selection of a format of the plurality of formats.

At block **1308**, the electronic device provides a second audio output comprising a presentation of the content in the selected format of the plurality of formats using the speaker of the electronic device. In some examples, the electronic device receives a user request to repeat the second audio output. The electronic device provides a third audio output different from the second audio output in response to receiving the user request. In some examples, providing the second audio output comprises providing the content at a first rate, and providing the third audio output comprises providing the content at a second rate different from the first rate. In some examples, providing the second audio output comprises providing the content at a first volume, and providing the third audio output comprises providing the content at a second volume different from the first volume. In some examples, providing the second audio output comprises providing the content in a first language, and providing the third audio output comprises providing the content in a second language different from the first language. In some examples, the electronic device identifies a domain associated with the second audio output. The third audio output is based on the identified domain.

As shown in FIG. **14**, an electronic device **1400** includes a speaker unit **1402**, a microphone unit **1404**, and a processing unit **1406** coupled to the speaker unit **1402** and the microphone unit **1404**. In some embodiments, the processing unit **1406** includes a providing unit **1420**, a receiving unit **1422**, a deriving unit **1424**, an identifying unit **1426**, a task performing unit **1428**, and optionally, a playback performing unit **1430**, an attenuating unit **1432**, a determining unit **1434**, and an adjusting unit **1436**.

In some examples, the processing unit **1406** configured to: provide (e.g., with the providing unit **1420**), via the speaker unit **1402** of the electronic device **1400**, an audio output (e.g., block **1102**); while providing the audio output via the speaker unit **1402** of the electronic device **1400**, receive (e.g., with the receiving unit **1422**), via the microphone unit **1404** of the electronic device **1400**, a natural language speech input (e.g., block **1104**); derive (e.g., with the deriving unit **1424**) a representation of user intent based on the natural language speech input and the audio output; identify (e.g., with the identifying unit **1426**) a task based on the derived user intent (e.g., block **1106**); and perform (e.g., with the task performing unit **1428**) the identified task (e.g., block **1108**).

In some examples, the processing unit **1406** is further configured to: identify (e.g., with the identifying unit **1426**) one or more parameters associated with the task based on a portion of the audio output (e.g., block **1128**), and performing the task includes performing the task based on the identified one or more parameters.

In some examples, the processing unit **1406** is further configured to: in response to receipt of the natural language speech input, identify (e.g., with the identifying unit **1426**) the portion of the audio output (e.g., block **1118**).

In some examples, providing the audio output comprises providing a speech output indicative of a list of items (e.g., block **1114**), and the portion of the audio output is indicative of an item of the list of items.

In some examples, the item is a media item and performing the task comprises performing playback (e.g., using the

playback performing unit **1430**), via the speaker unit **1402**, of the media item (e.g., block **1116**).

In some examples, the item is a location, and performing the task comprises providing, via the speaker unit **1402**, information associated with the location (e.g., block **1134**).

In some examples, providing the audio output comprises performing playback (e.g., using playback performing unit **1430**) of media content, and performing the task comprises adjusting playback (e.g., using adjusting unit **1436**) of the media content (e.g., block **1136**).

In some examples, adjusting playback of the media content comprises: adjusting a volume of the speaker unit **1402** of the electronic device **1400** (e.g., block **1138**).

In some examples, adjusting playback of the media content comprises: pausing playback of the media content (e.g., block **1140**).

In some examples, the processing unit **1406** is further configured to: in response to receiving the natural language speech input, attenuate (e.g., using the attenuating unit **1432**) the audio output.

In some examples, the processing unit **1406** is further configured to: in response to receiving the natural language speech input, cease to provide (e.g., with the providing unit **1420**) the audio output (e.g., block **1120**).

In some examples, the processing unit **1406** is further configured to: in response to receiving the natural language speech input, determine (e.g., using the determining unit **1434**) a type of the audio output (e.g., block **1122**), in response to a determination that the audio output is of a first type, adjust (e.g., using the adjusting unit **1436**) the audio output (e.g., block **1124**); and in response to a determination that the audio output is of a second type different from the first type, cease to provide (e.g., with the providing unit **1420**) the audio output (e.g., block **1126**).

In some examples, the audio output is a first audio output, and the processing unit **1406** is further configured to: before providing the first audio output, provide (e.g., with the providing unit **1420**) a second audio output (e.g., block **1112**).

In some examples, the electronic device **1400** is a computer.

In some examples, the electronic device **1400** is a television.

In some examples, the electronic device **1400** is a set-top box.

In some examples, the electronic device **1400** is a speaker.

In some examples, the electronic device **1400** is a smart watch.

In some examples, the electronic device **1400** is a phone.

The operations described above with respect to FIG. **11A-B** are, optionally, implemented by components depicted in FIGS. **1-4**, **6A-B**, **7A**, and **14**. For example, providing operation **1102**, receiving operation **1104**, and deriving operation **1106** are optionally implemented by processor(s) **120**. It would be clear to a person of ordinary skill in the art how other processes can be implemented based on the components depicted in FIGS. **1-4**, **6A-B**, **7A**, and **14**.

In accordance with some embodiments, FIG. **15** shows a functional block diagram of an electronic device **1500** configured in accordance with the principles of the various described embodiments, including those described with reference to FIGS. **8A-D**, **9A-G**, and **10A-G**. The functional blocks of the device are, optionally, implemented by hardware, software, or a combination of hardware and software to carry out the principles of the various described embodiments. It is understood by persons of skill in the art that the

functional blocks described in FIG. 15 are, optionally, combined or separated into sub-blocks to implement the principles of the various described embodiments. Therefore, the description herein optionally supports any possible combination or separation or further definition of the functional blocks described herein.

As shown in FIG. 15, an electronic device 1500 includes a speaker unit 1502, a microphone unit 1504, and a processing unit 1506 coupled to the speaker unit 1502 and the microphone unit 1504. In some embodiments, the processing unit 1506 includes a sampling unit 1520, a providing unit 1522, a receiving unit 1524, a deriving unit 1526, a performing unit 1528, and optionally, an attenuating unit 1532, a determining unit 1534, and an adjusting unit 1536.

In some examples, the processing unit 1506 configured to: sample (e.g., using sampling unit 1520), via the microphone unit 1504 of the electronic device 1500, an audio input, wherein the audio input comprises a spoken trigger (e.g., block 1202); in response to sampling the audio input, provide (e.g., using providing unit 1522), via the speaker unit 1502 of the electronic device 1500, an audio output indicative of a state of the automated assistant (e.g., block 1204); while providing the audio output indicative of a state of the automated assistant: receive (e.g., using providing unit 1524) a natural language speech input; and derive (e.g., using deriving unit 1524) a representation of user intent based on the natural language speech input (e.g., 1206); and perform (e.g., using performing unit 1528) a task based on the user intent (e.g., 1208).

In some examples, performing the task based on the user intent comprises: while providing the audio output indicative of a state of the automated assistant, performing the task based on the user intent (e.g., block 1220).

In some examples, the processing unit 1506 is further configured to: while providing the audio output indicative of a state of the automated assistant, output, via the speaker unit 1502, one or more results based on the performed task (e.g., block 1208).

In some examples, the processing unit 1506 is further configured to: cease to provide (e.g., using providing unit 1522) the audio output indicative of a state of the automated assistant after passage of a predefined period of time after providing the one or more results based on the performed task (e.g., block 1210).

In some examples, the audio output is indicative of an active state of the automated assistant.

In some examples, the audio output is a continuous sound.

In some examples, the audio output comprises white noise.

In some examples, the audio output comprises sound of running water.

In some examples, providing the audio output comprises attenuating (e.g., using attenuating unit 1532) the audio output over a period of time (e.g., block 1210).

In some examples, the audio output indicative of a state of the automated assistant is a first audio output, and the processing unit 1506 is further configured to: while providing the first audio output, provide (e.g., using providing unit 1522) a second audio output indicative of an ongoing processing of a user request (e.g., block 1212).

In some examples, the audio output indicative of a state of the automated assistant is a first audio output, and the processing unit 1506 is further configured to: while providing the first audio output, provide (e.g., using providing unit 1522) a third audio output indicative of a completed processing of a user request (e.g., block 1214).

In some examples, the audio output indicative of a state of the automated assistant is a first audio output, and the processing unit 1506 is further configured to: while providing the first audio output, provide (e.g., using providing unit 1522) a fourth audio output indicative of an acknowledgment of the spoken trigger (e.g., block 1216).

In some examples, the audio output indicative of a state of the automated assistant is a first audio output, and the processing unit 1506 is further configured to: while providing the first audio output indicative of a state of the automated assistant, provide (e.g., using providing unit 1522) a fifth audio output indicative of an error (e.g., block 1218).

In some examples, the audio input is the first audio input, and the processing unit 1506 is further configured to: determine (e.g., using determining unit 1534) a user context (e.g., block 1222); after performing the task, receive (e.g., using providing unit 1524) a second audio input, wherein the second audio input does not comprise a spoken trigger (e.g., block 1224); derive (e.g., using deriving unit 1524) a representation of another user intent based on the second audio input and the user context (e.g., block 1226); and perform (e.g., using performing unit 1528) another task based on the another user intent (e.g., block 1228).

In some examples, the user context is based on the natural language speech input, the user intent, the task, or a combination thereof.

In some examples, the processing unit 1506 is further configured to: after sampling, via the microphone unit 1504 of the electronic device 1500, the audio input, determine (e.g., using determining unit 1534) a current context (e.g., block 1212); adjust (e.g., using adjusting unit 1536) the audio output based on the determined current context (e.g., block 1214).

In some examples, the current context comprises a current time, and adjusting the audio output comprises adjusting a volume of the audio output.

In some examples, the audio output indicative of a state of the automated assistant is based on a type of the electronic device 1500.

In some examples, the electronic device 1500 is a computer.

In some examples, the electronic device 1500 is a television.

In some examples, the electronic device 1500 is a set-top box.

In some examples, the electronic device 1500 is a speaker.

In some examples, the electronic device 1500 is a smart watch.

In some examples, the electronic device 1500 is a phone.

The operations described above with respect to FIG. 12 are, optionally, implemented by components depicted in FIGS. 1-4, 6A-B, 7A, and 15. For example, sampling operation 1202, providing operation 1204, and receiving and deriving operations 1206 are optionally implemented by processor(s) 120. It would be clear to a person of ordinary skill in the art how other processes can be implemented based on the components depicted in FIGS. 1-4, 6A-B, 7A, and 15.

In accordance with some embodiments, FIG. 16 shows a functional block diagram of an electronic device 1600 configured in accordance with the principles of the various described embodiments, including those described with reference to FIGS. 8A-D, 9A-G, and 10A-G. The functional blocks of the device are, optionally, implemented by hardware, software, or a combination of hardware and software to carry out the principles of the various described embodiments. It is understood by persons of skill in the art that the

functional blocks described in FIG. 16 are, optionally, combined or separated into sub-blocks to implement the principles of the various described embodiments. Therefore, the description herein optionally supports any possible combination or separation or further definition of the functional blocks described herein.

As shown in FIG. 16, an electronic device 1600 includes a speaker unit 1602 and a processing unit 1606 coupled to the speaker unit 1602. In some embodiments, the processing unit 1606 includes a receiving unit 1620, a providing unit 1622, and optionally, an identifying unit 1624.

In some examples, the processing unit 1606 configured to: receive (e.g., using receiving unit 1620) a first natural language speech input indicative of content (e.g., block 1302); provide (e.g., using providing unit 1622), via the speaker unit 1602, a first audio output, wherein the audio output comprises a plurality of formats for presenting the content (e.g., block 1304); receive (e.g., using receiving unit 1620) a second natural language speech input indicative of a selection of a format of the plurality of formats (e.g., block 1306); and provide (e.g., using providing unit 1622), via the speaker unit 1602, a second audio output comprising a presentation of the content in the selected format of the plurality of formats (e.g., block 1308).

In some examples, the first audio output further comprises information describing the content.

In some examples, the information describing the content comprises information indicative of a size of the content.

In some examples, the first audio input is based on context information.

In some examples, the context information is based on a type of the electronic device 1600.

In some examples, the plurality of formats comprises one or more of: an entirety of the content, a summary of the content, a portion of the content, a paraphrase of the content, or a combination thereof.

In some examples, the first audio output further comprises one or more exemplary inputs.

In some examples, the processing unit 1606 is further configured to: receive (e.g., using receiving unit 1620) a user request to repeat the second audio output (e.g., block 1316); in response to receiving the user request, provide (e.g., using providing unit 1622) a third audio output different from the second audio output (e.g., block 1320).

In some examples, providing the second audio output comprises providing the content at a first rate (e.g., block 1310), and providing the third audio output comprises providing the content at a second rate different from the first rate (e.g., block 1322).

In some examples, providing the second audio output comprises providing the content at a first volume (e.g., block 1312), and providing the third audio output comprises providing the content at a second volume different from the first volume (e.g., block 1324).

In some examples, providing the second audio output comprises providing the content in a first language (e.g., block 1314), and providing the third audio output comprises providing the content in a second language different from the first language (e.g., block 1326).

In some examples, the processing unit 1606 is further configured to: identify (e.g., using identifying unit 1624) a domain associated with the second audio output; and the third audio output is based on the identified domain.

In some examples, the electronic device 1600 is a computer.

In some examples, the electronic device 1600 is a television.

In some examples, the electronic device 1600 is a set-top box.

In some examples, the electronic device 1600 is a speaker.

In some examples, the electronic device 1600 is a smart watch.

In some examples, the electronic device 1600 is a phone.

The operations described above with respect to FIG. 13A-B are, optionally, implemented by components depicted in FIGS. 1-4, 6A-B, 7A, and 16. For example, receiving operation 1302 and providing operation 1304 are optionally implemented by processor(s) 120. It would be clear to a person of ordinary skill in the art how other processes can be implemented based on the components depicted in FIGS. 1-4, 6A-B, 7A, and 13.

In accordance with some implementations, a computer-readable storage medium (e.g., a non-transitory computer readable storage medium) is provided, the computer-readable storage medium storing one or more programs for execution by one or more processors of an electronic device, the one or more programs including instructions for performing any of the methods or processes described herein.

In accordance with some implementations, an electronic device (e.g., a portable electronic device) is provided that comprises means for performing any of the methods or processes described herein.

In accordance with some implementations, an electronic device (e.g., a portable electronic device) is provided that comprises a processing unit configured to perform any of the methods or processes described herein.

In accordance with some implementations, an electronic device (e.g., a portable electronic device) is provided that comprises one or more processors and memory storing one or more programs for execution by the one or more processors, the one or more programs including instructions for performing any of the methods or processes described herein.

The foregoing description, for purpose of explanation, has been described with reference to specific embodiments. However, the illustrative discussions above are not intended to be exhaustive or to limit the invention to the precise forms disclosed. Many modifications and variations are possible in view of the above teachings. The embodiments were chosen and described in order to best explain the principles of the techniques and their practical applications. Others skilled in the art are thereby enabled to best utilize the techniques and various embodiments with various modifications as are suited to the particular use contemplated.

Although the disclosure and examples have been fully described with reference to the accompanying drawings, it is to be noted that various changes and modifications will become apparent to those skilled in the art. Such changes and modifications are to be understood as being included within the scope of the disclosure and examples as defined by the claims.

What is claimed is:

1. An electronic device for operating an automated assistant, the electronic device comprising:

one or more processors;

a memory;

a speaker;

a microphone; and

one or more programs, wherein the one or more programs are stored in the memory and configured to be executed by the one or more processors, the one or more programs including instructions for:

providing, via the speaker of the electronic device, an audio output;

57

while providing the audio output via the speaker of the electronic device, receiving, via the microphone of the electronic device, a natural language speech input;

in response to receiving the natural language speech input, determining a type of the audio output;

in response to a determination that the audio output is of a first type, adjusting the audio output;

in response to a determination that the audio output is of a second type different from the first type, ceasing to provide the audio output;

deriving a representation of user intent based on the natural language speech input and the audio output;

identifying a task based on the derived user intent; and performing the identified task.

2. The electronic device of claim 1, the one or more programs further including instructions for:

identifying one or more parameters associated with the task based on a portion of the audio output;

wherein performing the task includes performing the task based on the identified one or more parameters.

3. The electronic device of claim 2, the one or more programs further including instructions for: in response to receipt of the natural language speech input, identifying the portion of the audio output.

4. The electronic device of claim 2, wherein providing the audio output comprises providing a speech output indicative of a list of items, and wherein the portion of the audio output is indicative of an item of the list of items.

5. The electronic device of claim 4, wherein the item is a media item, and wherein performing the task comprises performing playback, via the speaker, of the media item.

6. The electronic device of claim 4, wherein the item is a location, and wherein performing the task comprises providing, via the speaker, information associated with the location.

7. The electronic device of claim 1, wherein providing the audio output comprises performing playback of media content, and wherein performing the task comprises adjusting playback of the media content.

8. The electronic device of claim 7, wherein adjusting playback of the media content comprises: adjusting a volume of the speaker of the electronic device.

9. The electronic device of claim 7, wherein adjusting playback of the media content comprises: pausing playback of the media content.

10. The electronic device of claim 1 wherein adjusting the audio output comprises attenuating the audio output.

11. The electronic device of claim 1, wherein the audio output is a first audio output, the one or more programs further including instructions for:

before providing the first audio output, providing a second audio output.

12. A method for operating an automated assistant, the method comprising:

at an electronic device with a speaker and a microphone, providing, via the speaker of the electronic device, an audio output;

while providing the audio output via the speaker of the electronic device, receiving, via the microphone of the electronic device, a natural language speech input;

58

in response to receiving the natural language speech input, determining a type of the audio output;

in response to a determination that the audio output is of a first type, adjusting the audio output;

in response to a determination that the audio output is of a second type different from the first type, ceasing to provide the audio output;

deriving a representation of user intent based on the natural language speech input and the audio output;

identifying a task based on the derived user intent; and performing the identified task.

13. The method of claim 12, further comprising: identifying one or more parameters associated with the task based on a portion of the audio output;

wherein performing the task includes performing the task based on the identified one or more parameters.

14. The method of claim 13, further comprising: in response to receipt of the natural language speech input, identifying the portion of the audio output.

15. The method of claim 13, wherein providing the audio output comprises providing a speech output indicative of a list of items, and wherein the portion of the audio output is indicative of an item of the list of items.

16. The method of claim 15, wherein the item is a media item, and wherein performing the task comprises performing playback, via the speaker, of the media item.

17. The method of claim 15, wherein the item is a location, and wherein performing the task comprises providing, via the speaker, information associated with the location.

18. The method of claim 12, wherein providing the audio output comprises performing playback of media content, and wherein performing the task comprises adjusting playback of the media content.

19. The method of claim 18, wherein adjusting playback of the media content comprises: adjusting a volume of the speaker of the electronic device.

20. The method of claim 18, wherein adjusting playback of the media content comprises: pausing playback of the media content.

21. The method of claim 12, wherein adjusting the audio output comprises attenuating the audio output.

22. The method of claim 12, wherein the audio output is a first audio output, the method further comprising: before providing the first audio output, providing a second audio output.

23. A non-transitory computer readable storage medium storing one or more programs, the one or more programs comprising instructions, which when executed by one or more processors of an electronic device, cause the device to: provide, via a speaker of the electronic device, an audio output;

while providing the audio output via the speaker of the electronic device, receive, via a microphone of the electronic device, a natural language speech input;

in response to receiving the natural language speech input, determine a type of the audio output;

in response to a determination that the audio output is of a first type, adjust the audio output;

in response to a determination that the audio output is of a second type different from the first type, cease to provide the audio output;

derive a representation of user intent based on the natural language speech input and the audio output;

59

identify a task based on the derived user intent; and perform the identified task.

24. The non-transitory computer readable storage medium of claim 23, the one or more programs further comprising instructions, which when executed by one or more processors of the electronic device, cause the device to:

identify one or more parameters associated with the task based on a portion of the audio output; wherein performing the task includes performing the task based on the identified one or more parameters.

25. The non-transitory computer readable storage medium of claim 24, the one or more programs further comprising instructions, which when executed by one or more processors of the electronic device, cause the device to:

in response to receipt of the natural language speech input, identify the portion of the audio output.

26. The non-transitory computer readable storage medium of claim 24,

wherein providing the audio output comprises providing a speech output indicative of a list of items, and wherein the portion of the audio output is indicative of an item of the list of items.

27. The non-transitory computer readable storage medium of claim 26,

wherein the item is a media item, and wherein performing the task comprises performing playback, via the speaker, of the media item.

28. The non-transitory computer readable storage medium of claim 26,

60

wherein the item is a location, and wherein performing the task comprises providing, via the speaker, information associated with the location.

29. The non-transitory computer readable storage medium of claim 23,

wherein providing the audio output comprises performing playback of media content, and wherein performing the task comprises adjusting playback of the media content.

30. The non-transitory computer readable storage medium of claim 29, wherein adjusting playback of the media content comprises: adjusting a volume of the speaker of the electronic device.

31. The non-transitory computer readable storage medium of claim 29, wherein adjusting playback of the media content comprises: pausing playback of the media content.

32. The non-transitory computer readable storage medium of claim 23, wherein adjusting the audio output comprises attenuating the audio output.

33. The non-transitory computer readable storage medium of claim 23, wherein the audio output is a first audio output, the one or more programs further comprising instructions, which when executed by one or more processors of the electronic device, cause the device to:

before providing the first audio output, provide a second audio output.

* * * * *

UNITED STATES PATENT AND TRADEMARK OFFICE
CERTIFICATE OF CORRECTION

PATENT NO. : 10,043,516 B2
APPLICATION NO. : 15/385606
DATED : August 7, 2018
INVENTOR(S) : Harry J. Saddler et al.

Page 1 of 1

It is certified that error appears in the above-identified patent and that said Letters Patent is hereby corrected as shown below:

In the Claims

In Claim 25, at Column 59, Line 15, delete "he" and insert -- the --, therefor.

Signed and Sealed this
Twentieth Day of November, 2018

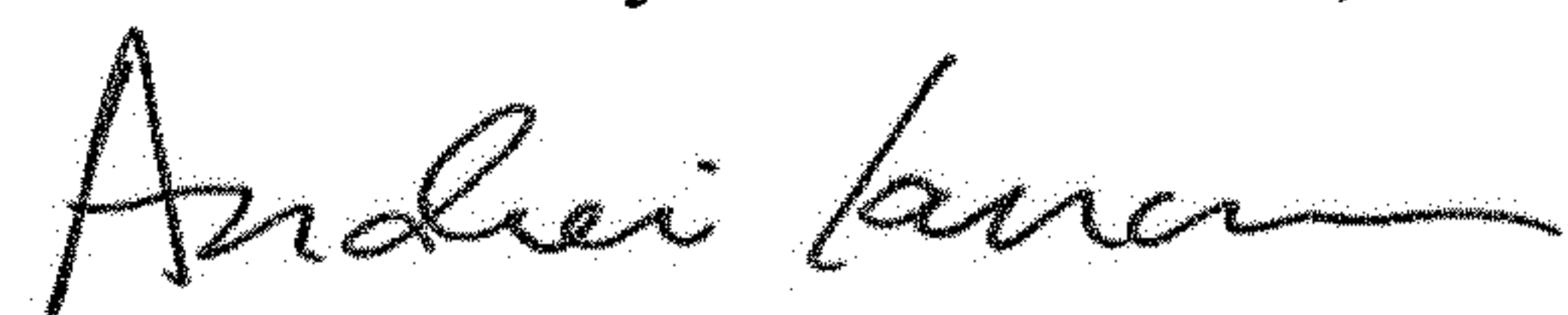

Andrei Iancu
Director of the United States Patent and Trademark Office